



FCC SAR Test Report

APPLICANT : Qualcomm Atheros, Incorporated
EQUIPMENT : 2x2 802.11a/b/g/n/ad +BT module
BRAND NAME : Qualcomm Atheros
MODEL NAME : QCA9005
FCC ID : PPD-QCA9005
STANDARD : FCC 47 CFR Part 2 (2.1093)
ANSI/IEEE C95.1-1992
IEEE 1528-2003
FCC OET Bulletin 65 Supplement C (Edition 01-01)

The product was installed into Tablet PC (Brand Name: DELL, Model Name: W01A, W01A001, XPS 18) during testing

The product was completely tested on Mar. 08, 2013. We, SPORTON INTERNATIONAL INC., would like to declare that the tested sample has been evaluated in accordance with the procedures and shown the compliance with the applicable technical standards.

The test results in this report apply exclusively to the tested model / sample. Without written approval of SPORTON INTERNATIONAL INC., the test report shall not be reproduced except in full.

Reviewed by: Eric Huang / Assistant Manager

Approved by: Jones Tsai / Manager



SPORTON INTERNATIONAL INC.

No. 52, Hwa Ya 1st Rd., Hwa Ya Technology Park, Kwei-Shan Hsiang, Tao Yuan Hsien, Taiwan, R.O.C.



Table of Contents

1. Statement of Compliance 4
2. Administration Data 5
2.1 Testing Laboratory..... 5
2.2 Applicant 5
2.3 Manufacturer 5
2.4 Application Details..... 5
3. General Information 6
3.1 Description of Equipment Under Test (EUT) 6
3.2 Maximum RF output power among production units 7
3.3 Applied Standard..... 8
3.4 Device Category and SAR Limits 8
3.5 Test Conditions..... 8
4. Specific Absorption Rate (SAR)..... 9
4.1 Introduction 9
4.2 SAR Definition..... 9
5. SAR Measurement System.....10
5.1 E-Field Probe 11
5.2 Data Acquisition Electronics (DAE) 12
5.3 Robot 12
5.4 Measurement Server..... 12
5.5 Phantom..... 13
5.6 Device Holder..... 14
5.7 Data Storage and Evaluation 15
5.8 Test Equipment List 17
6. Tissue Simulating Liquids..... 18
7. SAR System Verification 20
7.1 Purpose of System Performance check 20
7.2 System Setup..... 20
7.3 SAR System Verification Results 21
8. EUT Testing Position 22
9. Measurement Procedures 22
9.1 Spatial Peak SAR Evaluation 23
9.2 Power Reference Measurement..... 23
9.3 Area & Zoom Scan Procedures..... 24
9.4 Volume Scan Procedures..... 25
9.5 SAR Averaged Methods 25
9.6 Power Drift Monitoring..... 25
10. Conducted RF Output Power (Unit: dBm)..... 26
11. Exposure Positions Consideration..... 32
12. SAR Test Results 35
12.1 Test Records for Body SAR Test 35
12.2 Highest SAR Plot 37
12.3 Simultaneous Multi-band Transmission Analysis..... 39
13. Uncertainty Assessment 40
14. References 43
Appendix A. Plots of System Performance Check
Appendix B. Plots of SAR Measurement
Appendix C. DASy Calibration Certificate
Appendix D. Test Setup Photos



Revision History

REPORT NO.	VERSION	DESCRIPTION	ISSUED DATE
FA313102	Rev. 01	Initial issue of report	Mar. 14, 2013
FA313102	Rev. 02	1. Modified simultaneous transmission analysis in page39. 2. Modified exclusion table in page34.	Apr. 09, 2013



1. Statement of Compliance

The maximum results of Specific Absorption Rate (SAR) found during testing for **Qualcomm Atheros, Incorporated 2x2 802.11a/b/g/n/ad +BT module, Qualcomm Atheros, QCA9005** are as follows.

<Highest Reported standalone SAR Summary>

Frequency Band	Exposure Position	Reported 1g-SAR (W/kg)	Equipment Class	Highest Reported 1g-SAR (W/kg)
WLAN 5.2GHz Band	Body (0 cm Gap)	0.76	NII	0.76
WLAN 5.3GHz Band	Body (0 cm Gap)	0.40		
WLAN 5.5GHz Band	Body (0 cm Gap)	0.47		
WLAN 5.8GHz Band	Body (0 cm Gap)	0.36	DTS	0.47
WLAN 2.4GHz Band	Body (0 cm Gap)	0.47		

<Highest Reported simultaneous SAR Summary>

Frequency Band	Exposure Position	Reported 1g-SAR (W/kg)	Highest Reported 1g-SAR (W/kg)
WLAN 5.2GHz Band	Body (0 cm Gap)	0.707	0.83
Bluetooth		0.125	
WLAN 5.8GHz Band	Body (0 cm Gap)	0.36	0.55
Bluetooth		0.188	

This device is in compliance with Specific Absorption Rate (SAR) for general population/uncontrolled exposure limits (1.6 W/kg) specified in FCC 47 CFR part 2 (2.1093) and ANSI/IEEE C95.1-1992, and had been tested in accordance with the measurement methods and procedures specified in IEEE 1528-2003 and FCC OET Bulletin 65 Supplement C (Edition 01-01).



2. Administration Data

2.1 Testing Laboratory

Test Site	SPORTON INTERNATIONAL INC.
Test Site Location	No. 52, Hwa Ya 1 st Rd., Hwa Ya Technology Park, Kwei-Shan Hsiang, Tao Yuan Hsien, Taiwan, R.O.C. TEL: +886-3-327-3456 FAX: +886-3-328-4978

2.2 Applicant

Company Name	Qualcomm Atheros, Incorporated
Address	1700 Technology Drive San Jose, CA 95110

2.3 Manufacturer

Company Name	Qualcomm Atheros, Incorporated
Address	1700 Technology Drive San Jose, CA 95110

2.4 Application Details

Date of Start during the Test	Mar. 06, 2013
Date of End during the Test	Mar. 08, 2013

3. General Information

3.1 Description of Equipment Under Test (EUT)

Product Feature & Specification	
EUT	2x2 802.11a/b/g/n/ad +BT module
Brand Name	Qualcomm Atheros
Model Name	QCA9005
FCC ID	PPD-QCA9005
TX Frequency	WLAN 2.4GHz Band: 2412 MHz ~ 2462 MHz WLAN 5.2GHz Band: 5180 MHz ~ 5240 MHz WLAN 5.3GHz Band: 5260 MHz ~ 5320 MHz WLAN 5.5GHz Band: 5500 MHz ~ 5700 MHz WLAN 5.8GHz Band: 5745 MHz ~ 5825 MHz Bluetooth: 2402 MHz ~ 2480 MHz
Uplink Modulations	802.11b: DSSS (DBPSK / DQPSK / CCK) 802.11a/g/n: OFDM (BPSK / QPSK / 16QAM / 64QAM) Bluetooth : GFSK Bluetooth EDR : $\pi/4$ -DQPSK, 8-DPSK Bluetooth 4.0 LE: GFSK
EUT Stage	Production Unit
Remark: 1. The above EUT's information was declared by manufacturer. Please refer to the specifications or user's manual for more detailed description. 2. 5600 MHz ~ 5650 MHz is notched. 3. The Bluetooth Power is refer to FCC ID: PPD-QCA9005 and Report No. RF120720E01-2	

The product was installed into Tablet PC (Brand Name: DELL, Model Name: W01A, W01A001, XPS 18) during testing

Product Feature & Specification	
Host	Tablet PC
Brand Name	DELL
Model Name	W01A, W01A001, XPS 18
Antenna 1	Vendor : WHA YU Main : C1335-520243-A(Tx1, White) AUX : C1335-520244-A(Tx2, Black) Antenna Gain:1.94 dBi
Antenna 2	Vendor : Wanshih Main : UC1WFI0109(Tx2, White) AUX : UC1WFI0108(Tx1, Black) Antenna Gain:2.91 dBi
Antenna Type	WLAN: PIFA Antenna Bluetooth: PIFA Antenna
Remark: 1. This product have two models of antenna, due to the antenna type are the same that chosen highest antenna gain under tested. 2. Pre KDB 178919 D01 v05r01, for Part 15 device, identical antenna type with the same or lower gain, with no other change to the transmitter and host device configurations, and the highest SAR measured for that antenna type in previous certification is less than 0.8 W/kg, SAR evaluation is not required to add an equivalent antenna.	



3.2 Maximum RF output power among production units

IEEE 802.11 Average power(dBm)								
Normal								
WLAN2.4GHz	Ant 0				Ant 0+1			
Freq (MHz)	11b	11g	HT20	HT40	11b	11g	HT20	HT40
2412	15.5	12.5	12.0		18.5	15.5	15.0	
2422				9.5				12.5
2437	15.5	15.5	15.5	12.0	18.5	18.5	18.5	15.0
2452				9.5				12.5
2462	15.5	11.5	11.0		18.5	14.5	14.0	

Mode / Band	Bluetooth			
	1Mbps	2Mbps	3Mbps	BT v4.0 LE
	(GFSK)	($\pi/4$ -DQPSK)	(8-DPSK)	(GFSK)
2.4 GHz Bluetooth	6	6	6.5	6

IEEE 802.11 Average power(dBm)						
Normal						
WLAN 5GHz	Ant 0			Ant 0+1		
Freq (MHz)	11a	HT20	HT40	11a	HT20	HT40
5180	11.50	10.50		14.50	13.50	
5190			9.00			12.00
5200	11.00	10.50		14.00	13.50	
5220	11.00	10.50		14.00	13.50	
5230			10.00			13.00
5240	10.50	10.00		13.50	13.00	
5260	10.50	9.50		13.50	12.50	
5270			9.50			12.50
5280	10.50	9.50		13.50	12.50	
5300	10.50	9.50		13.50	12.50	
5310			9.50			12.50
5320	10.00	9.50		13.00	12.50	
5500	10.50	9.50		13.50	12.50	
5510			7.00			10.00
5520	10.50	9.50		13.50	12.50	
5540	10.50	9.50		13.50	12.50	
5550			9.50			12.50
5560	10.50	9.50		13.50	12.50	
5580	10.50	9.50		13.50	12.50	
5660	10.50	9.50		13.50	12.50	
5670			10.50			13.50
5680	10.50	9.50		13.50	12.50	
5700	10.50	10.50		13.50	13.50	
5745	10.50	10.50		13.50	13.50	
5755			10.50			13.50
5765	11.00	11.00		14.00	14.00	
5785	11.00	11.00		14.00	14.00	
5795			10.50			13.50
5805	11.00	11.00		14.00	14.00	
5825	10.50	11.00		13.50	14.00	



3.3 Applied Standard

The Specific Absorption Rate (SAR) testing specification, method, and procedure for this device is in accordance with the following standards:

- FCC 47 CFR Part 2 (2.1093)
- ANSI/IEEE C95.1-1992
- IEEE 1528-2003
- FCC OET Bulletin 65 Supplement C (Edition 01-01)
- FCC KDB 447498 D01 v05
- FCC KDB 248227 D01 v01r02
- FCC KDB 616217 D04 v01
- FCC KDB 178919 D01 v05r01

3.4 Device Category and SAR Limits

This device belongs to portable device category because its radiating structure is allowed to be used within 20 centimeters of the body of the user. Limit for General Population/Uncontrolled exposure should be applied for this device, it is 1.6 W/kg as averaged over any 1 gram of tissue.

3.5 Test Conditions

3.5.1 Ambient Condition

Ambient Temperature	20 to 24 °C
Humidity	< 60 %

3.5.2 Test Configuration

During WLAN SAR testing EUT is configured with the WLAN continuous TX tool, and the transmission duty factor was monitored on the spectrum analyzer with zero-span setting

Duty factor observed as below:

802.11b, 1Mbps: 100%

802.11a, 6Mbps: 100%

802.11 HT40, MCS8: 100%

For WLAN SAR testing, WLAN engineering testing software installed on the EUT can provide continuous transmitting RF signal.

4. Specific Absorption Rate (SAR)

4.1 Introduction

SAR is related to the rate at which energy is absorbed per unit mass in an object exposed to a radio field. The SAR distribution in a biological body is complicated and is usually carried out by experimental techniques or numerical modeling. The standard recommends limits for two tiers of groups, occupational/controlled and general population/uncontrolled, based on a person's awareness and ability to exercise control over his or her exposure. In general, occupational/controlled exposure limits are higher than the limits for general population/uncontrolled.

4.2 SAR Definition

The SAR definition is the time derivative (rate) of the incremental energy (dW) absorbed by (dissipated in) an incremental mass (dm) contained in a volume element (dv) of a given density (ρ). The equation description is as below:

$$\text{SAR} = \frac{d}{dt} \left(\frac{dW}{dm} \right) = \frac{d}{dt} \left(\frac{dW}{\rho dv} \right)$$

SAR is expressed in units of Watts per kilogram (W/kg)

SAR measurement can be either related to the temperature elevation in tissue by

$$\text{SAR} = C \left(\frac{\delta T}{\delta t} \right)$$

Where: C is the specific heat capacity, δT is the temperature rise and δt is the exposure duration, or related to the electrical field in the tissue by

$$\text{SAR} = \frac{\sigma |E|^2}{\rho}$$

Where: σ is the conductivity of the tissue, ρ is the mass density of the tissue and E is the RMS electrical field strength.

However for evaluating SAR of low power transmitter, electrical field measurement is typically applied.

5. SAR Measurement System

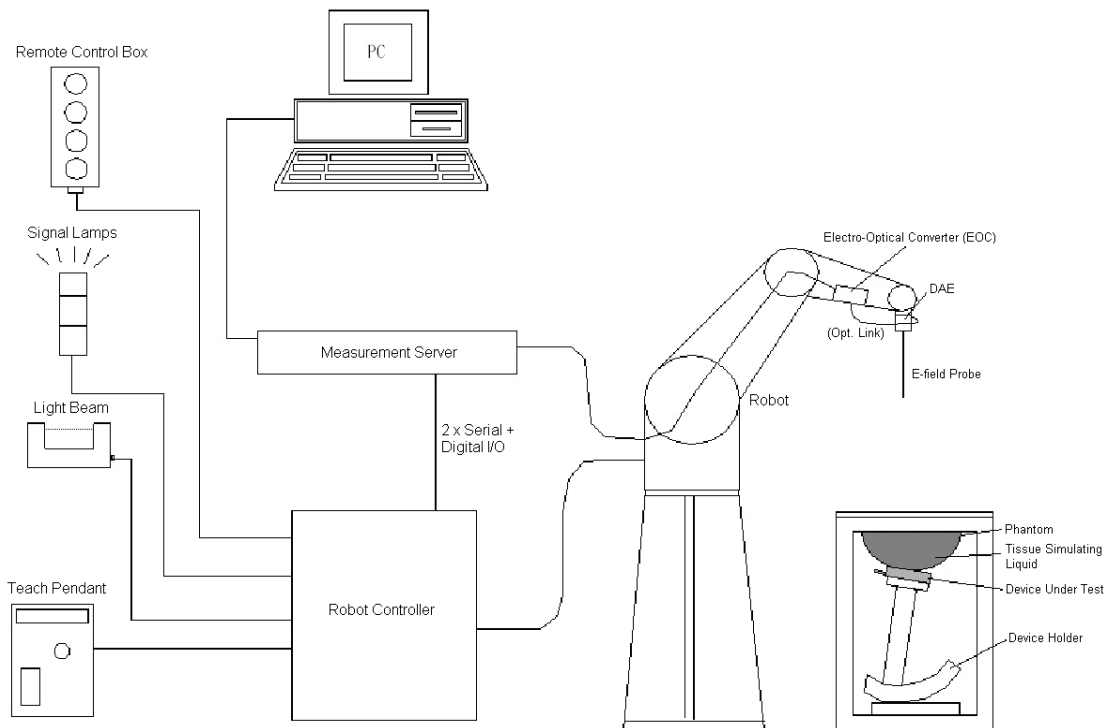

Fig 5.1 SPEAG DASY System Configurations

The DASY system for performance compliance tests is illustrated above graphically. This system consists of the following items:

- A standard high precision 6-axis robot with controller, a teach pendant and software
- A data acquisition electronic (DAE) attached to the robot arm extension
- A dosimetric probe equipped with an optical surface detector system
- The electro-optical converter (EOC) performs the conversion between optical and electrical signals
- A measurement server performs the time critical tasks such as signal filtering, control of the robot operation and fast movement interrupts.
- A probe alignment unit which improves the accuracy of the probe positioning
- A computer operating Windows XP
- DASY software
- Remote control with teach pendant and additional circuitry for robot safety such as warning lamps, etc.
- The SAM twin phantom
- A device holder
- Tissue simulating liquid
- Dipole for evaluating the proper functioning of the system

Component details are described in in the following sub-sections.

5.1 E-Field Probe

The SAR measurement is conducted with the dosimetric probe (manufactured by SPEAG). The probe is specially designed and calibrated for use in liquid with high permittivity. The dosimetric probe has special calibration in liquid at different frequency. This probe has a built in optical surface detection system to prevent from collision with phantom.

5.1.1 E-Field Probe Specification

<ES3DV3 Probe >

Construction	Symmetrical design with triangular core Built-in optical fiber for surface detection system. Built-in shielding against static charges. PEEK enclosure material (resistant to organic solvents, e.g., DGBE)
Frequency	10 MHz to 3 GHz; Linearity: ± 0.2 dB
Directivity	± 0.2 dB in HSL (rotation around probe axis) ± 0.4 dB in HSL (rotation normal to probe axis)
Dynamic Range	10 μ W/g to 100 mW/g; Linearity: ± 0.2 dB
Dimensions	Overall length: 337 mm (Tip: 10 mm) Tip diameter: 4 mm (Body: 10 mm) Distance from probe tip to dipole centers: 3 mm



Fig 5.2 Photo of ES3DV3

<EX3DV4 Probe>

Construction	Symmetrical design with triangular core Built-in shielding against static charges PEEK enclosure material (resistant to organic solvents, e.g., DGBE)
Frequency	10 MHz to 6 GHz; Linearity: ± 0.2 dB
Directivity	± 0.3 dB in HSL (rotation around probe axis) ± 0.5 dB in tissue material (rotation normal to probe axis)
Dynamic Range	10 μ W/g to 100 mW/g; Linearity: ± 0.2 dB (noise: typically $< 1 \mu$ W/g)
Dimensions	Overall length: 330 mm (Tip: 20 mm) Tip diameter: 2.5 mm (Body: 12 mm) Typical distance from probe tip to dipole centers: 1 mm



Fig 5.3 Photo of EX3DV4/ES3DV4

5.1.2 E-Field Probe Calibration

Each probe needs to be calibrated according to a dosimetric assessment procedure with accuracy better than $\pm 10\%$. The spherical isotropy shall be evaluated and within ± 0.25 dB. The sensitivity parameters (NormX, NormY, and NormZ), the diode compression parameter (DCP) and the conversion factor (ConvF) of the probe are tested. The calibration data can be referred to appendix C of this report.

5.2 Data Acquisition Electronics (DAE)

The data acquisition electronics (DAE) consists of a highly sensitive electrometer-grade preamplifier with auto-zeroing, a channel and gain-switching multiplexer, a fast 16 bit AD-converter and a command decoder and control logic unit. Transmission to the measurement server is accomplished through an optical downlink for data and status information as well as an optical uplink for commands and the clock. The input impedance of the DAE is 200 MOhm; the inputs are symmetrical and floating. Common mode rejection is above 80 dB.



Fig 5.4 Photo of DAE

5.3 Robot

The SPEAG DASY system uses the high precision robots (DASY4: RX90BL; DASY5: TX90XL) type from Stäubli SA (France). For the 6-axis controller system, the robot controller version (DASY4: CS7MB; DASY5: CS8c) from Stäubli is used. The Stäubli robot series have many features that are important for our application:

- High precision (repeatability ± 0.035 mm)
- High reliability (industrial design)
- Jerk-free straight movements
- Low ELF interference (the closed metallic construction shields against motor control fields)



Fig 5.5 Photo of DASY4



Fig 5.6 Photo of DASY5

5.4 Measurement Server

The measurement server is based on a PC/104 CPU board with CPU (DASY4: 166 MHz, Intel Pentium; DASY5: 400 MHz, Intel Celeron), chipdisk (DASY4: 32 MB; DASY5: 128 MB), RAM (DASY4: 64 MB, DASY5: 128 MB). The necessary circuits for communication with the DAE electronic box, as well as the 16 bit AD converter system for optical detection and digital I/O interface are contained on the DASY I/O board, which is directly connected to the PC/104 bus of the CPU board.

The measurement server performs all the real-time data evaluation for field measurements and surface detection, controls robot movements and handles safety operations.



Fig 5.7 Photo of Server for DASY4



Fig 5.8 Photo of Server for DASY5

5.5 Phantom

<SAM Twin Phantom>

Shell Thickness	2 ± 0.2 mm; Center ear point: 6 ± 0.2 mm
Filling Volume	Approx. 25 liters
Dimensions	Length: 1000 mm; Width: 500 mm; Height: adjustable feet
Measurement Areas	Left Hand, Right Hand, Flat Phantom



Fig 5.9 Photo of SAM Phantom

The bottom plate contains three pair of bolts for locking the device holder. The device holder positions are adjusted to the standard measurement positions in the three sections. A white cover is provided to tap the phantom during off-periods to prevent water evaporation and changes in the liquid parameters. On the phantom top, three reference markers are provided to identify the phantom position with respect to the robot.

<ELI4 Phantom>

Shell Thickness	2 ± 0.2 mm (sagging: <1%)
Filling Volume	Approx. 30 liters
Dimensions	Major ellipse axis: 600 mm Minor axis: 400 mm



Fig 5.10 Photo of ELI4 Phantom

The ELI4 phantom is intended for compliance testing of handheld and body-mounted wireless devices in the frequency range of 30 MHz to 6 GHz. ELI4 is fully compatible with standard and all known tissue simulating liquids.

5.6 Device Holder

<Device Holder for SAM Twin Phantom>

The SAR in the phantom is approximately inversely proportional to the square of the distance between the source and the liquid surface. For a source at 5 mm distance, a positioning uncertainty of ± 0.5 mm would produce a SAR uncertainty of ± 20 %. Accurate device positioning is therefore crucial for accurate and repeatable measurements. The positions in which the devices must be measured are defined by the standards.

The DASY device holder is designed to cope with different positions given in the standard. It has two scales for the device rotation (with respect to the body axis) and the device inclination (with respect to the line between the ear reference points). The rotation center for both scales is the ear reference point (ERP). Thus the device needs no repositioning when changing the angles.

The DASY device holder is constructed of low-loss POM material having the following dielectric parameters: relative permittivity $\epsilon = 3$ and loss tangent $\delta = 0.02$. The amount of dielectric material has been reduced in the closest vicinity of the device, since measurements have suggested that the influence of the clamp on the test results could thus be lowered.



Fig 5.11 Device Holder

<Laptop Extension Kit>

The extension is lightweight and made of POM, acrylic glass and foam. It fits easily on the upper part of the mounting device in place of the phone positioned. The extension is fully compatible with the SAM Twin and ELI phantoms.

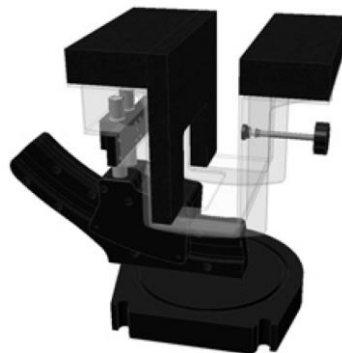

Fig 5.12 Laptop Extension Kit



5.7 Data Storage and Evaluation

5.7.1 Data Storage

The DASY software stores the assessed data from the data acquisition electronics as raw data (in microvolt readings from the probe sensors), together with all the necessary software parameters for the data evaluation (probe calibration data, liquid parameters and device frequency and modulation data) in measurement files. The post-processing software evaluates the desired unit and format for output each time the data is visualized or exported. This allows verification of the complete software setup even after the measurement and allows correction of erroneous parameter settings. For example, if a measurement has been performed with an incorrect crest factor parameter in the device setup, the parameter can be corrected afterwards and the data can be reevaluated.

The measured data can be visualized or exported in different units or formats, depending on the selected probe type (e.g., [V/m], [A/m], [mW/g]). Some of these units are not available in certain situations or give meaningless results, e.g., a SAR-output in a non-lose media, will always be zero. Raw data can also be exported to perform the evaluation with other software packages.

5.7.2 Data Evaluation

The DASY post-processing software (SEMCAD) automatically executes the following procedures to calculate the field units from the microvolt readings at the probe connector. The parameters used in the evaluation are stored in the configuration modules of the software :

Probe parameters :	- Sensitivity	Norm _i , a _{i0} , a _{i1} , a _{i2}
	- Conversion factor	ConvF _i
	- Diode compression point	dcp _i
Device parameters :	- Frequency	f
	- Crest factor	cf
Media parameters :	- Conductivity	σ
	- Density	ρ

These parameters must be set correctly in the software. They can be found in the component documents or they can be imported into the software from the configuration files issued for the DASY components. In the direct measuring mode of the multi-meter option, the parameters of the actual system setup are used. In the scan visualization and export modes, the parameters stored in the corresponding document files are used.

The first step of the evaluation is a linearization of the filtered input signal to account for the compression characteristics of the detector diode. The compensation depends on the input signal, the diode type and the DC-transmission factor from the diode to the evaluation electronics. If the exciting field is pulsed, the crest factor of the signal must be known to correctly compensate for peak power.

The formula for each channel can be given as :

$$V_i = U_i + U_i^2 \cdot \frac{cf}{dcp_i}$$

with V_i = compensated signal of channel i, (i = x, y, z)
 U_i = input signal of channel i, (i = x, y, z)
 cf = crest factor of exciting field (DASY parameter)
 dcp_i = diode compression point (DASY parameter)

From the compensated input signals, the primary field data for each channel can be evaluated :

$$\text{E-field Probes : } E_i = \sqrt{\frac{V_i}{\text{Norm}_i \cdot \text{ConvF}}}$$

$$\text{H-field Probes : } H_i = \sqrt{V_i \cdot \frac{a_{i0} + a_{i1}f + a_{i2}f^2}{f}}$$

with V_i = compensated signal of channel i, (i = x, y, z)
 Norm_i = sensor sensitivity of channel i, (i = x, y, z), $\mu\text{V}/(\text{V/m})^2$ for E-field Probes
 ConvF = sensitivity enhancement in solution
 a_{ij} = sensor sensitivity factors for H-field probes
 f = carrier frequency [GHz]
 E_i = electric field strength of channel i in V/m
 H_i = magnetic field strength of channel i in A/m

The RSS value of the field components gives the total field strength (Hermitian magnitude) :

$$E_{\text{tot}} = \sqrt{E_x^2 + E_y^2 + E_z^2}$$

The primary field data are used to calculate the derived field units.

$$\text{SAR} = E_{\text{tot}}^2 \cdot \frac{\sigma}{\rho \cdot 1000}$$

with SAR = local specific absorption rate in mW/g
 E_{tot} = total field strength in V/m
 σ = conductivity in [mho/m] or [Siemens/m]
 ρ = equivalent tissue density in g/cm^3

Note that the density is set to 1, to account for actual head tissue density rather than the density of the tissue simulating liquid.



5.8 Test Equipment List

Manufacturer	Name of Equipment	Type/Model	Serial Number	Calibration	
				Last Cal.	Due Date
SPEAG	2450MHz System Validation Kit	D2450V2	736	Jul. 25, 2011	Jul. 24, 2013
SPEAG	5GHz System Validation Kit	D5GHzV2	1006	Dec. 11, 2012	Dec. 10, 2013
SPEAG	Data Acquisition Electronics	DAE4	778	Aug. 27, 2012	Aug. 26, 2013
SPEAG	Data Acquisition Electronics	DAE4	1338	Jun. 12, 2012	Jun. 11, 2013
SPEAG	Dosimetric E-Field Probe	ES3DV3	3270	Sep. 28, 2012	Sep. 27, 2013
SPEAG	Dosimetric E-Field Probe	EX3DV4	3792	Jun. 21, 2012	Jun. 20, 2013
Wisewind	Thermometer	ETP-101	TM560	Nov. 13, 2012	Nov. 12, 2013
Wisewind	Thermometer	HTC-1	TM281	Nov. 13, 2012	Nov. 12, 2013
SPEAG	Device Holder	N/A	N/A	NCR	NCR
SPEAG	ELI4 Phantom	QD 0VA 001 BB	1026	NCR	NCR
SPEAG	ELI4 Phantom	QD 0VA 001 BA	1029	NCR	NCR
Agilent	ENA Network Analyzer	E5071C	MY46316648	Feb. 07, 2013	Feb. 06, 2014
Agilent	ESG Vector Series Signal Generator	E4438C	MY49070755	Oct. 02, 2012	Oct. 01, 2013
Anritsu	Power Meter	ML2495A	1132003	Aug. 14, 2012	Aug. 13, 2013
Agilent	Dual Directional Coupler	778D	50422	Note 4	
Woken	Attenuator 1	WK0602-XX	N/A	Note 4	
PE	Attenuator 2	PE7005-10	N/A	Note 4	
PE	Attenuator 3	PE7005- 3	N/A	Note 4	
Agilent	Dielectric Probe Kit	85070D	US01440205	Note 5	
AR	Power Amplifier	5S1G4M2	328767	Note 6	
R&S	Spectrum Analyzer	FSP	101131	Jul. 23, 2012	Jul. 22, 2013

Note:

1. The calibration certificate of DASY can be referred to appendix C of this report.
2. Referring to KDB 865664 D01v01, the dipole calibration interval can be extended to 3 years with justification. The dipoles are also not physically damaged, or repaired during the interval.
3. The justification data of dipole D2450V2, SN: 736, can be found in appendix C. The return loss is < -20dB, within 20% of prior calibration, the impedance is within 5 ohm of prior calibration.
4. The Insertion Loss calibration of Dual Directional Coupler and Attenuator were characterized via the network analyzer and compensated during system check.
5. The dielectric probe kit was calibrated via the network analyzer, with the specified procedure (calibrated in pure water) and calibration kit (standard) short circuit, before the dielectric measurement. The specific procedure and calibration kit are provided by Agilent.
6. In system check we need to monitor the level on the power meter, and adjust the power amplifier level to have precise power level to the dipole; the measured SAR will be normalized to 1W input power according to the ratio of 1W to the input power to the dipole. For system check, the calibration of the power amplifier is deemed not critically required for correct measurement; the power meter is critical and we do have calibration for it
7. Attenuator 1 insertion loss is calibrated by the network Analyzer, which the calibration is valid, before system check.

6. Tissue Simulating Liquids

For the measurement of the field distribution inside the SAM phantom with DASY, the phantom must be filled with around 25 liters of homogeneous body tissue simulating liquid. For head SAR testing, the liquid height from the ear reference point (ERP) of the phantom to the liquid top surface is larger than 15 cm, which is shown in Fig. 6.1. For body SAR testing, the liquid height from the center of the flat phantom to the liquid top surface is larger than 15 cm, which is shown in Fig. 6.2.

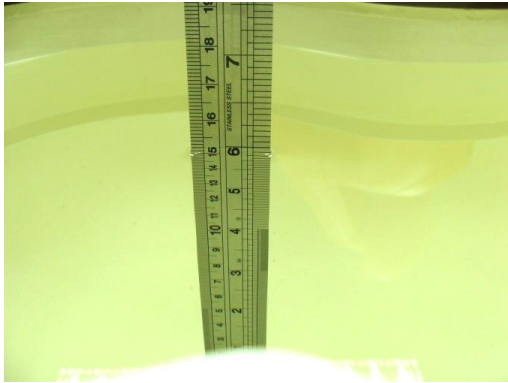

Fig 6.1 Photo of Liquid Height for Head SAR



Fig 6.2 Photo of Liquid Height for Body SAR

The following table gives the recipes for tissue simulating liquid.

Frequency (MHz)	Water (%)	Sugar (%)	Cellulose (%)	Salt (%)	Preventol (%)	DGBE (%)	Conductivity (σ)	Permittivity (ϵ_r)
For Body								
750	51.7	47.2	0	0.9	0.1	0	0.96	55.5
835	50.8	48.2	0	0.9	0.1	0	0.97	55.2
900	50.8	48.2	0	0.9	0.1	0	1.05	55.0
1800, 1900, 2000	70.2	0	0	0.4	0	29.4	1.52	53.3
2450	68.6	0	0	0	0	31.4	1.95	52.7

Table 6.1 Recipes of Tissue Simulating Liquid

Simulating Liquid for 5G, Manufactured by SPEAG

Ingredients	(% by weight)
Water	64~78%
Mineral oil	11~18%
Emulsifiers	9~15%
Additives and Salt	2~3%



The dielectric parameters of the liquids were verified prior to the SAR evaluation using an Agilent 85070D Dielectric Probe Kit and an Agilent Network Analyzer.

The following table shows the measuring results for simulating liquid.

Frequency (MHz)	Liquid Type	Liquid Temp. (°C)	Conductivity (σ)	Permittivity (ϵ_r)	Conductivity Target (σ)	Permittivity Target (ϵ_r)	Delta (σ) (%)	Delta (ϵ_r) (%)	Limit (%)	Date
2450	Body	21.4	1.969	52.278	1.95	52.7	0.97	-0.80	±5	2013/3/6
5200	Body	21.2	5.131	47.488	5.3	49	-3.19	-3.09	±5	2013/3/6
5300	Body	21.2	5.624	47.249	5.39	48.9	4.34	-3.38	±5	2013/3/6
5300	Body	21.6	5.405	47.298	5.39	48.9	0.28	-3.28	±5	2013/3/8
5600	Body	21.2	5.642	46.786	5.65	48.6	-0.14	-3.73	±5	2013/3/6
5600	Body	21.6	5.8	46.785	5.65	48.6	2.65	-3.73	±5	2013/3/8
5800	Body	21.6	6.153	46.472	6	48.2	2.55	-3.59	±5	2013/3/8

Table 6.2 Measuring Results for Simulating Liquid

7. SAR System Verification

Each DASY system is equipped with one or more system validation kits. These units, together with the predefined measurement procedures within the DASY software, enable the user to conduct the system performance check and system validation. System validation kit includes a dipole, tripod holder to fix it underneath the flat phantom and a corresponding distance holder.

7.1 Purpose of System Performance check

The system performance check verifies that the system operates within its specifications. System and operator errors can be detected and corrected. It is recommended that the system performance check be performed prior to any usage of the system in order to guarantee reproducible results. The system performance check uses normal SAR measurements in a simplified setup with a well characterized source. This setup was selected to give a high sensitivity to all parameters that might fail or vary over time. The system check does not intend to replace the calibration of the components, but indicates situations where the system uncertainty is exceeded due to drift or failure.

7.2 System Setup

In the simplified setup for system evaluation, the EUT is replaced by a calibrated dipole and the power source is replaced by a continuous wave that comes from a signal generator. The calibrated dipole must be placed beneath the flat phantom section of the SAM twin phantom with the correct distance holder. The distance holder should touch the phantom surface with a light pressure at the reference marking and be oriented parallel to the long side of the phantom. The equipment setup is shown below:

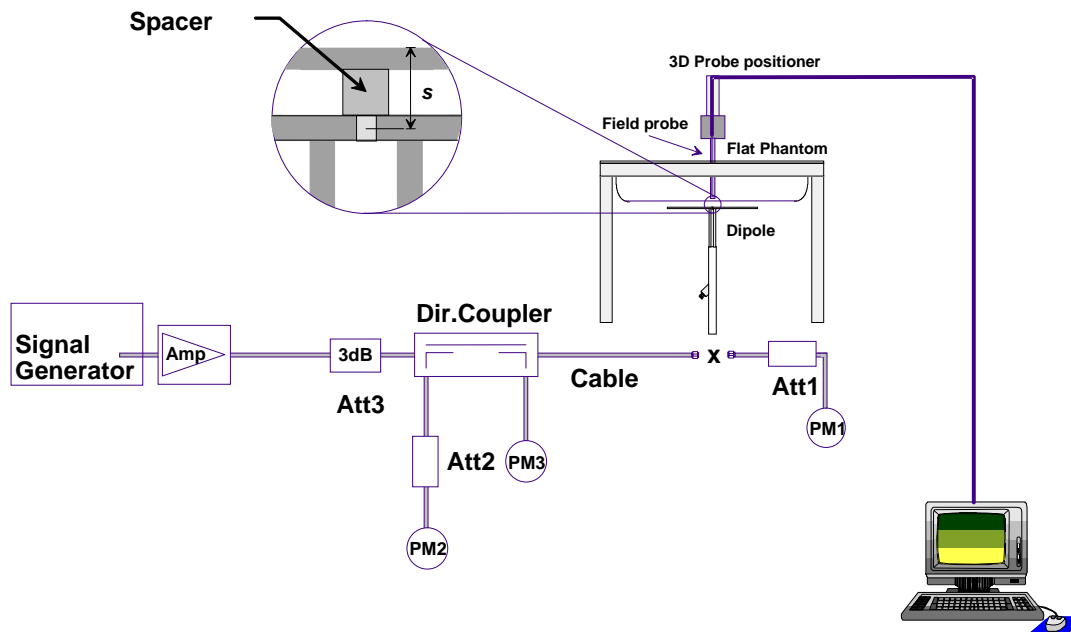

Fig 7.1 System Setup for System Evaluation

1. Signal Generator
2. Amplifier
3. Directional Coupler
4. Power Meter
5. Calibrated Dipole



Fig 7.2 Photo of Dipole Setup

7.3 SAR System Verification Results

Comparing to the original SAR value provided by SPEAG, the verification data should be within its specification of 10 %. Table 7.1 shows the target SAR and measured SAR after normalized to 1W input power. The table below indicates the system performance check can meet the variation criterion and the plots can be referred to Appendix A of this report.

Date	Frequency (MHz)	Liquid Type	Power fed onto reference dipole (mW)	Targeted SAR (W/kg)	Measured SAR (W/kg)	Normalized SAR (W/kg)	Deviation (%)
2013/3/6	2450	Body	250	52.3	13.6	54.4	4.02
2013/3/6	5200	Body	100	71.4	7.53	75.3	5.46
2013/3/6	5300	Body	100	73.5	7.3	73	-0.68
2013/3/8	5300	Body	100	73.5	7.72	77.2	5.03
2013/3/6	5300	Body	100	76.8	7.99	79.9	4.04
2013/3/8	5600	Body	100	76.8	7.92	79.2	3.13
2013/3/8	5800	Body	100	71.7	7.67	76.7	6.97

Table 7.1 Target and Measurement SAR after Normalized



8. EUT Testing Position

This EUT was tested in two different positions. They are bottom-face of tablet PC, Edge1. In these positions, the surface of EUT is touching with phantom 0 cm. Please refer to Appendix D for the test setup photos.

9. Measurement Procedures

The measurement procedures are as follows:

<Conducted power measurement>

- (a) For WWAN power measurement, use base station simulator to configure EUT WWAN transmission in conducted connection with RF cable, at maximum power in each supported wireless interface and frequency band.
- (b) Read the WWAN RF power level from the base station simulator.
- (c) For WLAN/BT power measurement, use engineering software to configure EUT WLAN/BT continuously transmission, at maximum RF power in each supported wireless interface and frequency band
- (d) Connect EUT RF port through RF cable to the power meter, and measure WLAN/BT output power

<SAR measurement>

- (a) Use base station simulator to configure EUT WWAN transmission in radiated connection, and engineering software to configure EUT WLAN/BT continuously transmission, at maximum RF power, in the highest power channel.
- (b) Place the EUT in the positions as Appendix D demonstrates.
- (c) Set scan area, grid size and other setting on the DASY software.
- (d) Measure SAR results for the highest power channel on each testing position.
- (e) Find out the largest SAR result on these testing positions of each band
- (f) Measure SAR results for other channels in worst SAR testing position if the reported SAR of highest power channel is larger than 0.8 W/kg

According to the test standard, the recommended procedure for assessing the peak spatial-average SAR value consists of the following steps:

- (a) Power reference measurement
- (b) Area scan
- (c) Zoom scan
- (d) Power drift measurement



9.1 Spatial Peak SAR Evaluation

The procedure for spatial peak SAR evaluation has been implemented according to the test standard. It can be conducted for 1g and 10g, as well as for user-specific masses. The DASY software includes all numerical procedures necessary to evaluate the spatial peak SAR value.

The base for the evaluation is a "cube" measurement. The measured volume must include the 1g and 10g cubes with the highest averaged SAR values. For that purpose, the center of the measured volume is aligned to the interpolated peak SAR value of a previously performed area scan.

The entire evaluation of the spatial peak values is performed within the post-processing engine (SEMCAD). The system always gives the maximum values for the 1g and 10g cubes. The algorithm to find the cube with highest averaged SAR is divided into the following stages:

- (a) Extraction of the measured data (grid and values) from the Zoom Scan
- (b) Calculation of the SAR value at every measurement point based on all stored data (A/D values and measurement parameters)
- (c) Generation of a high-resolution mesh within the measured volume
- (d) Interpolation of all measured values from the measurement grid to the high-resolution grid
- (e) Extrapolation of the entire 3-D field distribution to the phantom surface over the distance from sensor to surface
- (f) Calculation of the averaged SAR within masses of 1g and 10g

9.2 Power Reference Measurement

The Power Reference Measurement and Power Drift Measurements are for monitoring the power drift of the device under test in the batch process. The minimum distance of probe sensors to surface determines the closest measurement point to phantom surface. This distance cannot be smaller than the distance of sensor calibration points to probe tip as defined in the probe properties.

9.3 Area & Zoom Scan Procedures

First Area Scan is used to locate the approximate location(s) of the local peak SAR value(s). The measurement grid within an Area Scan is defined by the grid extent, grid step size and grid offset. Next, in order to determine the EM field distribution in a three-dimensional spatial extension, Zoom Scan is required. The Zoom Scan is performed around the highest E-field value to determine the averaged SAR-distribution over 10 g. Area scan and zoom scan resolution setting follows KDB 865664 D01v01 quoted below.

For any secondary peaks found in the area scan which are within 2 dB of the maximum peak and are not within this zoom scan, the zoom scan should be repeated

		≤ 3 GHz	> 3 GHz
Maximum distance from closest measurement point (geometric center of probe sensors) to phantom surface		5 ± 1 mm	$\frac{1}{2} \cdot \delta \cdot \ln(2) \pm 0.5$ mm
Maximum probe angle from probe axis to phantom surface normal at the measurement location		$30^\circ \pm 1^\circ$	$20^\circ \pm 1^\circ$
Maximum area scan spatial resolution: $\Delta x_{Area}, \Delta y_{Area}$		≤ 2 GHz: ≤ 15 mm 2 – 3 GHz: ≤ 12 mm	3 – 4 GHz: ≤ 12 mm 4 – 6 GHz: ≤ 10 mm
		When the x or y dimension of the test device, in the measurement plane orientation, is smaller than the above, the measurement resolution must be \leq the corresponding x or y dimension of the test device with at least one measurement point on the test device.	
Maximum zoom scan spatial resolution: $\Delta x_{Zoom}, \Delta y_{Zoom}$		≤ 2 GHz: ≤ 8 mm 2 – 3 GHz: ≤ 5 mm*	3 – 4 GHz: ≤ 5 mm* 4 – 6 GHz: ≤ 4 mm*
Maximum zoom scan spatial resolution, normal to phantom surface	uniform grid: $\Delta z_{Zoom}(n)$	≤ 5 mm	3 – 4 GHz: ≤ 4 mm 4 – 5 GHz: ≤ 3 mm 5 – 6 GHz: ≤ 2 mm
	graded grid $\Delta z_{Zoom}(1)$: between 1 st two points closest to phantom surface	≤ 4 mm	3 – 4 GHz: ≤ 3 mm 4 – 5 GHz: ≤ 2.5 mm 5 – 6 GHz: ≤ 2 mm
	$\Delta z_{Zoom}(n>1)$: between subsequent points	$\leq 1.5 \cdot \Delta z_{Zoom}(n-1)$	
Minimum zoom scan volume	x, y, z	≥ 30 mm	3 – 4 GHz: ≥ 28 mm 4 – 5 GHz: ≥ 25 mm 5 – 6 GHz: ≥ 22 mm
<p>Note: δ is the penetration depth of a plane-wave at normal incidence to the tissue medium; see draft standard IEEE P1528-2011 for details.</p> <p>* When zoom scan is required and the <i>reported</i> SAR from the area scan based 1-g SAR estimation procedures of KDB 447498 is ≤ 1.4 W/kg, ≤ 8 mm, ≤ 7 mm and ≤ 5 mm zoom scan resolution may be applied, respectively, for 2 GHz to 3 GHz, 3 GHz to 4 GHz and 4 GHz to 6 GHz.</p>			



9.4 Volume Scan Procedures

The volume scan is used for assess overlapping SAR distributions for antennas transmitting in different frequency bands. It is equivalent to an oversized zoom scan used in standalone measurements. The measurement volume will be used to enclose all the simultaneous transmitting antennas. For antennas transmitting simultaneously in different frequency bands, the volume scan is measured separately in each frequency band. In order to sum correctly to compute the 1g aggregate SAR, the EUT remain in the same test position for all measurements and all volume scan use the same spatial resolution and grid spacing. When all volume scan were completed, the software, SEMCAD postprocessor can combine and subsequently superpose these measurement data to calculating the multiband SAR.

9.5 SAR Averaged Methods

In DASYS, the interpolation and extrapolation are both based on the modified Quadratic Shepard's method. The interpolation scheme combines a least-square fitted function method and a weighted average method which are the two basic types of computational interpolation and approximation.

Extrapolation routines are used to obtain SAR values between the lowest measurement points and the inner phantom surface. The extrapolation distance is determined by the surface detection distance and the probe sensor offset. The uncertainty increases with the extrapolation distance. To keep the uncertainty within 1% for the 1 g and 10 g cubes, the extrapolation distance should not be larger than 5 mm.

9.6 Power Drift Monitoring

All SAR testing is under the EUT install full charged battery and transmit maximum output power. In DASYS measurement software, the power reference measurement and power drift measurement procedures are used for monitoring the power drift of EUT during SAR test. Both these procedures measure the field at a specified reference position before and after the SAR testing. The software will calculate the field difference in dB. If the power drifts more than 5%, the SAR will be retested.



10. Conducted RF Output Power (Unit: dBm)

<WLAN 2.4GHz SISO mode Conducted Power>

<Antenna 0>

WLAN 2.4GHz 802.11b Average Power (dBm)						
Power vs. Channel			Power vs. Data Rate			
Channel	Frequency	Data Rate (bps)	Channel	Data Rate (bps)		
	(MHz)	1M		2M	5.5M	11M
CH 1	2412	15.19	CH 6	15.26	15.22	15.26
CH 6	2437	15.28				
CH 11	2462	15.17				

WLAN 2.4GHz 802.11g Average Power (dBm)										
Power vs. Channel			Power vs. Data Rate							
Channel	Frequency	Data Rate (bps)	Channel	Data Rate (bps)						
	(MHz)	6M		9M	12M	18M	24M	36M	48M	54M
CH 1	2412	12.36	CH 6	14.98	14.98	14.97	14.98	14.92	14.94	14.95
CH 6	2437	14.99								
CH 11	2462	11.18								

WLAN 2.4GHz 802.11n-HT20 Average Power (dBm)										
Power vs. Channel			Power vs. Data Rate							
Channel	Frequency	MCS Index	Channel	MCS Index						
	(MHz)	MCS0		MCS1	MCS2	MCS3	MCS4	MCS5	MCS6	MCS7
CH 1	2412	11.68	CH 6	15.07	14.99	15.01	15.06	15.05	14.96	14.91
CH 6	2437	15.08								
CH 11	2462	10.73								

WLAN 2.4GHz 802.11n-HT40 Average Power (dBm)										
Power vs. Channel			Power vs. Data Rate							
Channel	Frequency	MCS Index	Channel	MCS Index						
	(MHz)	MCS0		MCS1	MCS2	MCS3	MCS4	MCS5	MCS6	MCS7
CH 3	2422	9.28	CH 6	11.44	11.49	11.49	11.48	11.49	11.42	11.44
CH 6	2437	11.54								
CH 9	2452	8.90								

Note:

- Per KDB 248227 D01 v01r02, choose the highest output power channel to test SAR and determine further SAR exclusion
- For each frequency band, testing at higher data rates and higher order modulations is not required when the maximum average output power for each of these configurations is less than 1/4dB higher than those measured at the lowest data rate
- Per KDB 248227 D01 v01r02, 11g, 11n-HT20 and 11n-HT40 output power is less than 1/4dB higher than 802.11b mode, thus the SAR can be excluded.



<WLAN 2.4GHz MIMO mode Conducted Power>

<Antenna 0+1>

WLAN 2.4GHz 802.11b Average Power (dBm)						
Power vs. Channel			Power vs. Data Rate			
Channel	Frequency	Data Rate (bps)	Channel	Data Rate (bps)		
	(MHz)	1M		2M	5.5M	11M
CH 1	2412	18.26	CH 1	18.22	18.21	18.25
CH 6	2437	17.73				
CH 11	2462	17.95				

WLAN 2.4GHz 802.11g Average Power (dBm)										
Power vs. Channel			Power vs. Data Rate							
Channel	Frequency	Data Rate (bps)	Channel	Data Rate (bps)						
	(MHz)	6M		9M	12M	18M	24M	36M	48M	54M
CH 1	2412	14.75	CH 6	16.73	16.68	16.64	16.65	16.61	16.57	16.54
CH 6	2437	16.75								
CH 11	2462	13.00								

WLAN 2.4GHz 802.11n-HT20 Average Power (dBm)										
Power vs. Channel			Power vs. Data Rate							
Channel	Frequency	MCS Index	Channel	MCS Index						
	(MHz)	MCS8		MCS9	MCS10	MCS11	MCS12	MCS13	MCS14	MCS15
CH 1	2412	13.95	CH 6	17.37	17.34	17.31	17.26	17.24	17.20	17.17
CH 6	2437	17.41								
CH 11	2462	12.46								

WLAN 2.4GHz 802.11n-HT40 Average Power (dBm)										
Power vs. Channel			Power vs. Data Rate							
Channel	Frequency	MCS Index	Channel	MCS Index						
	(MHz)	MCS8		MCS9	MCS10	MCS11	MCS12	MCS13	MCS14	MCS15
CH 3	2422	10.88	CH 6	13.02	12.97	12.92	12.95	12.88	12.85	12.88
CH 6	2437	13.08								
CH 9	2452	10.65								

Note:

1. Per KDB 248227 D01 v01r02, choose the highest output power channel to test SAR and determine further SAR exclusion
2. For each frequency band, testing at higher data rates and higher order modulations is not required when the maximum average output power for each of these configurations is less than 1/4dB higher than those measured at the lowest data rate
3. Per KDB 248227 D01 v01r02, 11g, 11n-HT20 and 11n-HT40 output power is less than 1/4dB higher than 802.11b mode, thus the SAR can be excluded.

<Bluetooth Conducted Power>

Channel	Frequency (MHz)	Average power (dBm)	
		Mode	
		GFSK	8-DPSK
CH 0	2402	5.98	6.25
CH 39	2441	5.69	5.95
CH 78	2480	5.32	5.64



<WLAN 5GHz SISO mode Conducted Power>

<Antenna 0>

WLAN 5GHz 802.11a Average Power (dBm)										
Power vs. Channel			Power vs. Data Rate							
Channel	Frequency (MHz)	Data Rate (bps)	Channel	Data Rate (bps)						
		6M		9M	12M	18M	24M	36M	48M	54M
CH 36	5180	11.27	CH 36	11.24	11.21	11.18	11.15	11.17	11.20	11.15
CH 40	5200	10.99								
CH 44	5220	10.95								
CH 48	5240	10.28								
CH 52	5260	10.08	CH 60	10.45	10.43	10.44	10.40	10.35	10.32	10.34
CH 56	5280	10.00								
CH 60	5300	10.50								
CH 64	5320	9.63								
CH 100	5500	10.48								
CH 104	5520	10.07	CH 100	10.45	10.41	10.42	10.37	10.34	10.32	10.31
CH 108	5540	10.40								
CH 112	5560	10.11								
CH 116	5580	10.37								
CH 132	5660	10.15								
CH 136	5680	10.17								
CH 140	5700	10.45								
CH 149	5745	10.43								
CH 153	5765	10.84	CH 157	10.84	10.81	10.77	10.74	10.76	10.71	10.69
CH 157	5785	10.86								
CH 161	5805	10.25								
CH 165	5825	10.44								

WLAN 5GHz 802.11n-HT20 Average Power (dBm)										
Power vs. Channel			Power vs. Data Rate							
Channel	Frequency (MHz)	MCS Index	Channel	MCS Index						
		MCS0		MCS1	MCS2	MCS3	MCS4	MCS5	MCS6	MCS7
CH 36	5180	9.39	CH 48	9.85	9.81	9.83	9.83	9.78	9.75	9.71
CH 40	5200	9.13								
CH 44	5220	9.18								
CH 48	5240	9.9								
CH 52	5260	9.22	CH 64	9.24	9.28	9.25	9.21	9.18	9.15	9.18
CH 56	5280	9.18								
CH 60	5300	9.26								
CH 64	5320	9.32								
CH 100	5500	9.38								
CH 104	5520	9.2	CH 140	10.21	10.17	10.14	10.18	10.12	10.10	10.08
CH 108	5540	9.37								
CH 112	5560	9.18								
CH 116	5580	9.25								
CH 132	5660	9.48								
CH 136	5680	9.5								
CH 140	5700	10.26								
CH 149	5745	10.38								
CH 153	5765	10.37	CH 157	10.76	10.71	10.67	10.64	10.61	10.57	10.60
CH 157	5785	10.8								
CH 161	5805	10.64								
CH 165	5825	10.74								



WLAN 5GHz 802.11n-HT40 Average Power (dBm)										
Power vs. Channel			Power vs. Data Rate							
Channel	Frequency (MHz)	MCS Index	Channel	MCS Index						
		MCS0		MCS1	MCS2	MCS3	MCS4	MCS5	MCS6	MCS7
CH 38	5190	8.72	CH 46	9.93	9.89	9.84	9.86	9.82	9.83	9.86
CH 46	5230	9.96								
CH 54	5270	9.26	CH 54	9.21	9.24	9.18	9.15	9.13	9.11	9.11
CH 62	5310	9.14								
CH 102	5510	6.89	CH 134	10.25	10.21	10.18	10.14	10.11	10.16	10.13
CH 110	5550	9.37								
CH 134	5670	10.28								
CH 151	5755	10.39	CH 151	10.36	10.31	10.35	10.31	10.27	10.24	10.20
CH 159	5795	10.17								

Note:

1. Per KDB 248227 D01 v01r02, choose the highest output power channel to test SAR and determine further SAR exclusion
2. For each frequency band, testing at higher data rates and higher order modulations is not required when the maximum average output power for each of these configurations is less than 1/4dB higher than those measured at the lowest data rate.
3. Per KDB 248227 D01 v01r02, 11n-HT20 and 11n-HT40 output power is less than 1/4dB higher than 802.11a mode, thus the SAR can be excluded.



<WLAN 5GHz MIMO Mode Conducted Power>

<Antenna 0+1>

WLAN 5GHz 802.11a Average Power (dBm)											
Power vs. Channel			Power vs. Data Rate								
Channel	Frequency (MHz)	MCS Index	Channel	MCS Index						48M	54M
		6M		9M	12M	18M	24M	36M			
CH 36	5180	14.10	CH 36	14.06	14.01	14.03	13.97	13.93	13.94	13.91	
CH 40	5200	12.05									
CH 44	5220	12.74									
CH 48	5240	12.87									
CH 52	5260	12.41	CH 60	12.41	12.44	12.40	12.37	12.32	12.30	12.26	
CH 56	5280	11.63									
CH 60	5300	12.46									
CH 64	5320	12.42									
CH 100	5500	12.96									
CH 104	5520	12.34	CH 100	12.92	12.88	12.81	12.83	12.78	12.75	12.76	
CH 108	5540	12.63									
CH 112	5560	12.46									
CH 116	5580	12.89									
CH 132	5660	12.60									
CH 136	5680	12.40									
CH 140	5700	13.36									
CH 149	5745	11.92									
CH 153	5765	12.28	CH 157	12.42	12.44	12.38	12.35	12.32	12.35	12.30	
CH 157	5785	12.47									
CH 161	5805	12.34									
CH 165	5825	11.89									

WLAN 5GHz 802.11n-HT20 Average Power (dBm)											
Power vs. Channel			Power vs. Data Rate								
Channel	Frequency (MHz)	MCS Index	Channel	MCS Index						MCS14	MCS15
		MCS8		MCS9	MCS10	MCS11	MCS12	MCS13			
CH 36	5180	13.06	CH 36	13.01	13.03	12.97	12.93	12.94	12.91	12.88	
CH 40	5200	11.68									
CH 44	5220	12.48									
CH 48	5240	12.57									
CH 52	5260	11.93	CH 60	12.10	12.06	12.03	12.04	12.00	11.97	11.94	
CH 56	5280	11.41									
CH 60	5300	12.13									
CH 64	5320	11.95									
CH 100	5500	11.56									
CH 104	5520	10.93	CH 140	12.71	12.70	12.65	12.61	12.56	12.59	12.58	
CH 108	5540	11.32									
CH 112	5560	11.07									
CH 116	5580	11.43									
CH 132	5660	11.99									
CH 136	5680	12.31									
CH 140	5700	12.75									
CH 149	5745	11.9									
CH 153	5765	12.28	CH 157	12.56	12.52	12.48	12.43	12.48	12.41	12.40	
CH 157	5785	12.6									
CH 161	5805	12.44									
CH 165	5825	12.47									



WLAN 5GHz 802.11n-HT40 Average Power (dBm)										
Power vs. Channel			Power vs. Data Rate							
Channel	Frequency	MCS Index	Channel	MCS Index						
	(MHz)	MCS8		MCS9	MCS10	MCS11	MCS12	MCS13	MCS14	MCS15
CH 38	5190	11.62	CH 46	11.86	11.82	11.80	11.75	11.73	11.76	11.77
CH 46	5230	11.91								
CH 54	5270	11.93	CH 62	12.07	12.04	12.00	12.03	11.97	11.93	11.95
CH 62	5310	12.11								
CH 102	5510	9.48	CH 134	13.10	13.07	13.04	13.06	13.01	13.00	12.98
CH 110	5550	11.95								
CH 134	5670	13.13								
CH 151	5755	12.46	CH 159	13.21	13.17	13.14	13.16	13.12	13.07	13.04
CH 159	5795	13.24								

Note:

1. Per KDB 248227 D01 v01r02, choose the highest output power channel to test SAR and determine further SAR exclusion
2. For each frequency band, testing at higher data rates and higher order modulations is not required when the maximum average output power for each of these configurations is less than 1/4dB higher than those measured at the lowest data rate.
3. Per KDB 248227 D01 v01r02, 11n-HT20 and 11n-HT40 output power is less than 1/4dB higher than 802.11a mode, thus the SAR can be excluded.
4. Per KDB 248227 D01 v01r02, 11n-HT40 (Freq: 5745MHz ~ 5825MHz) average output power is higher than 1/4dB higher than 802.11a mode, these modes SAR will be verified at the highest RF exposure position found in 802.11a SAR testing.

11. Exposure Positions Consideration

Edge 1

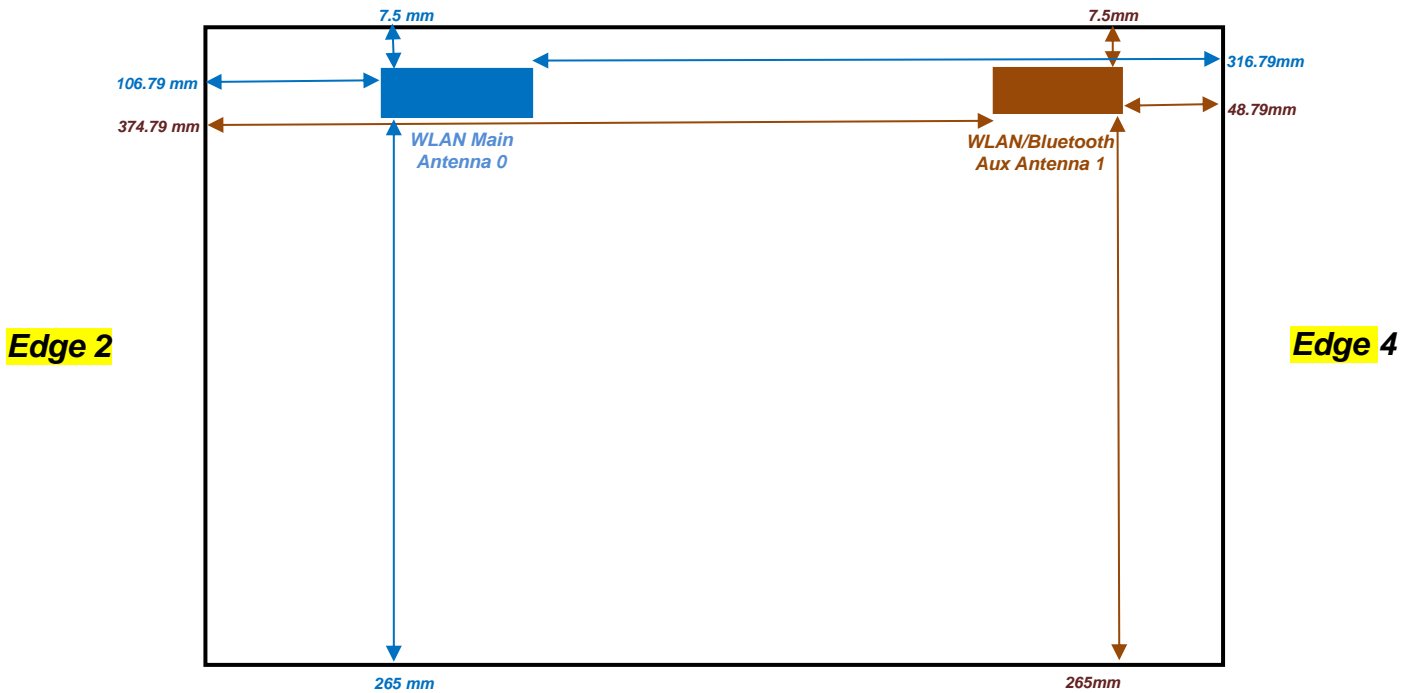

Edge 3

Back View

Antennas	Wireless Interface
WLAN Main Antenna 0 (Tx / Rx)	WLAN 2.4GHz WLAN5GHz
BT&WLAN Aux Antenna 1 (Tx / Rx)	WLAN 2.4GHz WLAN5GHz Bluetooth

<Standalone transmission configuration>

Wireless Interface	Antennas	
	WLAN Antenna 0 (Tx / Rx)	WLAN Antenna 1 (Tx / Rx)
2.4GHz Bluetooth		yes
WLAN 2.4GHz 802.11b	yes	yes
WLAN 2.4GHz 802.11g	yes	yes
WLAN 2.4GHz 802.11 HT20	yes	yes
WLAN 2.4GHz 802.11 HT40	yes	yes
WLAN 5GHz 802.11a	yes	yes
WLAN 5GHz 802.11 HT20	yes	yes
WLAN 5GHz 802.11 HT40	yes	yes



<SISO Mode Simultaneous transmission configuration>

combination no.	Wireless Interface	Antennas	
		Antenna 0 (Tx / Rx)	Antenna 1 (Tx / Rx)
1	2.4GHz Bluetooth		yes
	WLAN 2.4GHz 802.11b/g/HT20/HT40	yes	
2	2.4GHz Bluetooth		yes
	WLAN 5.2/5.3/5.5/5.8 GHz 802.11a/HT20/HT40	yes	

<MIMO Mode Simultaneous transmission configuration>

combination no.	Wireless Interface	Antennas	
		Antenna 0 (Tx / Rx)	Antenna 1 (Tx / Rx)
1	2.4GHz Bluetooth		yes
	WLAN 5.2/5.3/5.5/5.8 GHz 802.11 a/ HT20/HT40	yes	yes



WLAN SAR test exclusion table distance is < 50mm

Exposure Position	Wireless Interface	802.11b Ant 0	802.11b Ant 0+1	802.11a Ant 0	802.11a Ant 0+1	Bluetooth Ant 1
	Tune-up Maximum power (dBm)	15.5	18.5	11.5	14.5	6.5
Bottom Face	Antenna to user (mm)	5	5	5	5	5
	SAR exclusion threshold	11.18	22.3	6.82	13.6	1.41
	SAR testing required?	YES	YES	YES	YES	NO
Edge 1	Antenna to user (mm)	7.5	7.5	7.5	7.5	7.5
	SAR exclusion threshold	7.42	22.78	4.55	9.07	0.94
	SAR testing required?	YES	YES	YES	YES	NO
Edge 4	Antenna to user (mm)		48.79		48.79	48.79
	SAR exclusion threshold		2.28		1.39	0.14
	SAR testing required?		NO		NO	NO

WLAN SAR test exclusion table distance is > 50mm

Exposure Position	Wireless Interface	802.11b Ant 0	802.11b Ant 0+1	802.11a Ant 0	802.11a Ant 0+1	Bluetooth Ant 1
	Tune-up Maximum power (dBm)	15.5	18.5	11.5	14.5	6.5
	Tune-up Maximum rated power (mW)	35.48	70.79	14.13	28.18	4.47
Edge 2	Antenna to user (mm)	106.79	106.79	106.79	106.79	106.79
	SAR exclusion threshold (mW)	663	663	630	630	203
	SAR testing required?	NO	NO	NO	NO	NO
Edge 3	Antenna to user (mm)	265	265	265	265	265
	SAR exclusion threshold (mW)	2246	2246	2212	2212	505
	SAR testing required?	NO	NO	NO	NO	NO
Edge 4	Antenna to user (mm)	316.79		316.79		
	SAR exclusion threshold (mW)	2763		2730		
	SAR testing required?	NO		NO		

Note:

- Maximum power is the source-based time-average power and represents the maximum RF output power among production units
- Per KDB 447498 D01v05, for larger devices, the *test separation distance* is determined by the closest separation between the antenna and the user.
- Per KDB 447498 D01v05, standalone SAR test exclusion threshold is applied; If the distance of the antenna to the user is < 5mm, 5mm is used to determine SAR exclusion threshold
- Per KDB 447498 D01v05, the 1-g and 10-g SAR test exclusion thresholds for 100 MHz to 6 GHz at *test separation distances* ≤ 50 mm are determined by:

$$[(\text{max. power of channel, including tune-up tolerance, mW}) / (\text{min. test separation distance, mm})] \cdot [\sqrt{f(\text{GHz})}] \leq 3.0$$
 for 1-g SAR and ≤ 7.5 for 10-g extremity SAR
 - f(GHz) is the RF channel transmit frequency in GHz
 - Power and distance are rounded to the nearest mW and mm before calculation
 - The result is rounded to one decimal place for comparison
 - if SAR exclusion threshold > 3, RF Exposure evaluation is necessary
- Per KDB 447498 D01v05, at 100 MHz to 6 GHz and for *test separation distances* > 50 mm, the SAR test exclusion threshold is determined according to the following
 - [Threshold at 50 mm in step 1) + (test separation distance - 50 mm) · (f(MHz)/150)] mW, at 100 MHz to 1500 MHz
 - [Threshold at 50 mm in step 1) + (test separation distance - 50 mm) · 10] mW at > 1500 MHz and ≤ 6 GHz



12. SAR Test Results

Note:

1. Per KDB 447498 D01v05, the reported SAR is the measured SAR value adjusted for maximum tune-up tolerance.
 $Scaling\ Factor = \frac{tune-up\ limit\ power\ (mW)}{EUT\ RF\ power\ (mW)}$, where tune-up limit is the maximum rated power among all production units.
 $Reported\ SAR(W/kg) = Measured\ SAR(W/kg) * Scaling\ Factor$
2. Per KDB 447498 D01v05, for each exposure position, if the highest output channel reported SAR $\leq 0.8W/kg$, other channels SAR testing is not necessary.
3. This product have two model of antenna, due to the antenna type are the same that chosen highest antenna gain under tested.
4. Pre KDB 178919 D01, for Part 15 device, identical antenna type with the same or lower gain, with no other change to the transmitter and host device configurations, and the highest SAR measured for that antenna type in previous certification is less than 0.8 W/kg, SAR evaluation is not required to add an equivalent antenna.
5. Per KDB 447498 D01v05, for each exposure position, testing of other required channels within the operating mode of a frequency band is not required when the reported 1-g or 10-g SAR for the mid-band or highest output power channel is:
 - $\leq 0.8\ W/kg$ or $2.0\ W/kg$, for 1-g or 10-g respectively, when the transmission band is $\leq 100\ MHz$
 - $\leq 0.6\ W/kg$ or $1.5\ W/kg$, for 1-g or 10-g respectively, when the transmission band is between 100 MHz and 200 MHz
 - $\leq 0.4\ W/kg$ or $1.0\ W/kg$, for 1-g or 10-g respectively, when the transmission band is $\geq 200\ MHz$

12.1 Test Records for Body SAR Test

<WLAN2.4GHz SAR>

Plot No.	Band	Mode	Test Position	Gap (cm)	Ant.	Ch.	Freq. (MHz)	Data Rate (bps)	Average Power (dBm)	Tune-Up Limit (dBm)	Tune-up Scaling Factor	Power Drift (dB)	Measured SAR 1g (W/kg)	Reported SAR 1g (W/kg)
1	WLAN2.4GHz	802.11b	Bottom Face	0cm	Ant 0	6	2437	1M	15.28	15.5	1.052	0.07	0.307	0.323
2	WLAN2.4GHz	802.11b	Edge 1	0cm	Ant 0	6	2437	1M	15.28	15.5	1.052	-0.06	0.42	0.442
5	WLAN2.4GHz	802.11b	Bottom Face	0cm	Ant 0+1	1	2412	1M	18.26	18.5	1.058	-0.01	0.393	0.416
6	WLAN2.4GHz	802.11b	Edge 1	0cm	Ant 0+1	1	2412	1M	18.26	18.5	1.058	-0.03	0.446	0.472



<WLAN5GHz SAR>

Plot No.	Band	Mode	Test Position	Gap (cm)	Ant.	Ch.	Freq. (MHz)	Data Rate (bps)	Average Power (dBm)	Tune-Up Limit (dBm)	Tune-up Scaling Factor	Power Drift (dB)	Measured SAR 1g (W/kg)	Reported SAR 1g (W/kg)
10	WLAN5GHz	802.11a	Bottom Face	0cm	Ant 0	36	5180	6M	11.27	11.5	1.054	-0.1	0.199	0.210
11	WLAN5GHz	802.11a	Edge 1	0cm	Ant 0	36	5180	6M	11.27	11.5	1.054	0.13	0.719	0.758
13	WLAN5GHz	802.11a	Bottom Face	0cm	Ant 0	60	5300	6M	10.5	10.5	1.000	-0.12	0.163	0.163
14	WLAN5GHz	802.11a	Edge 1	0cm	Ant 0	60	5300	6M	10.5	10.5	1.000	0.18	0.339	0.339
16	WLAN5GHz	802.11a	Bottom Face	0cm	Ant 0	100	5500	6M	10.48	10.5	1.005	0.19	0.176	0.177
17	WLAN5GHz	802.11a	Edge 1	0cm	Ant 0	100	5500	6M	10.48	10.5	1.005	0.02	0.435	0.437
18	WLAN5GHz	802.11a	Edge 1	0cm	Ant 0	116	5580	6M	10.37	10.5	1.030	-0.18	0.272	0.280
19	WLAN5GHz	802.11a	Edge 1	0cm	Ant 0	140	5700	6M	10.45	10.5	1.012	-0.16	0.395	0.400
20	WLAN5GHz	802.11a	Bottom Face	0cm	Ant 0	157	5785	6M	10.86	11	1.033	-0.14	0.185	0.191
21	WLAN5GHz	802.11a	Edge 1	0cm	Ant 0	157	5785	6M	10.86	11	1.033	-0.14	0.332	0.343
24	WLAN5GHz	802.11a	Bottom Face	0cm	Ant 0+1	36	5180	6M	14.1	14.5	1.096	-0.14	0.255	0.280
25	WLAN5GHz	802.11a	Edge 1	0cm	Ant 0+1	36	5180	6M	14.1	14.5	1.096	0.06	0.645	0.707
28	WLAN5GHz	802.11a	Bottom Face	0cm	Ant 0+1	60	5300	6M	12.46	13.5	1.271	-0.13	0.146	0.186
29	WLAN5GHz	802.11a	Edge 1	0cm	Ant 0+1	60	5300	6M	12.46	13.5	1.271	-0.15	0.311	0.395
31	WLAN5GHz	802.11a	Bottom Face	0cm	Ant 0+1	140	5700	6M	13.36	13.5	1.033	-0.05	0.217	0.224
32	WLAN5GHz	802.11a	Edge 1	0cm	Ant 0+1	140	5700	6M	13.36	13.5	1.033	-0.02	0.452	0.467
33	WLAN5GHz	802.11a	Edge 1	0cm	Ant 0+1	100	5500	6M	12.96	13.5	1.132	-0.15	0.464	0.525
34	WLAN5GHz	802.11a	Edge 1	0cm	Ant 0+1	116	5580	6M	12.89	13.5	1.151	-0.17	0.433	0.498
35	WLAN5GHz	802.11a	Bottom Face	0cm	Ant 0+1	157	5785	6M	12.47	14	1.422	-0.16	0.165	0.235
36	WLAN5GHz	802.11a	Edge 1	0cm	Ant 0+1	157	5785	6M	12.47	14	1.422	-0.06	0.253	0.360
37	WLAN5GHz	802.11n-HT40	Edge 1	0cm	Ant 0+1	159	5795	MCS8	13.24	13.5	1.062	-0.11	0.262	0.278

12.2 Highest SAR Plot

Test Laboratory: Sporton International Inc. SAR/HAC Testing Lab

Date: 2013/3/6

#06_WLAN2.4G_802.11b_Edge 1_0cm_Ch1;Ant 0+1

DUT: 313102

Communication System: 802.11b; Frequency: 2412 MHz; Duty Cycle: 1:1
 Medium: MSL_2450_130306 Medium parameters used: $f = 2412$ MHz; $\sigma = 1.918$ mho/m; $\epsilon_r = 52.404$; $\rho = 1000$ kg/m³
 Ambient Temperature : 22.4 °C ; Liquid Temperature : 21.4 °C

DASY5 Configuration:

- Probe: ES3DV3 - SN3270; ConvF(4.17, 4.17, 4.17); Calibrated: 2012/9/28;
- Sensor-Surface: 3mm (Mechanical Surface Detection)
- Electronics: DAE4 Sn778; Calibrated: 2012/8/27
- Phantom: ELI 4.0_Front; Type: QDOVA001BB; Serial: 1026
- Measurement SW: DASY52, Version 52.8 (2); SEMCAD X Version 14.6.6 (6477)

Configuration/Ch1/Area Scan (61x401x1): Measurement grid: dx=12mm, dy=12mm
 Maximum value of SAR (interpolated) = 0.598 mW/g

Configuration/Ch1/Zoom Scan (7x7x7)/Cube 0: Measurement grid: dx=5mm, dy=5mm, dz=5mm
 Reference Value = 18.170 V/m; Power Drift = -0.03 dB
 Peak SAR (extrapolated) = 0.991 mW/g
SAR(1 g) = 0.446 mW/g; SAR(10 g) = 0.201 mW/g
 Maximum value of SAR (measured) = 0.599 mW/g

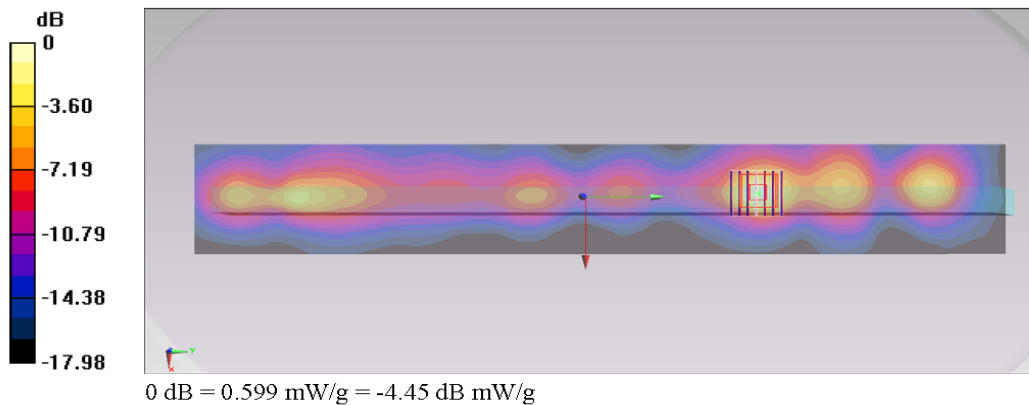

Test Laboratory: Sporton International Inc. SAR/HAC Testing Lab

Date: 2013/3/6

#11_WLAN5G_802.11a_Edge 1_0cm_Ch36;Ant 0

DUT: 313102

Communication System: 802.11a; Frequency: 5180 MHz; Duty Cycle: 1:1
 Medium: MSL_5G_130306 Medium parameters used: $f = 5180$ MHz; $\sigma = 5.097$ mho/m; $\epsilon_r = 47.487$; $\rho = 1000$ kg/m³
 Ambient Temperature : 22.2°C; Liquid Temperature : 21.2°C

DASY5 Configuration:

- Probe: EX3DV4 - SN3792; ConvF(4.2, 4.2, 4.2); Calibrated: 2012/6/21;
- Sensor-Surface: 1.4mm (Mechanical Surface Detection)
- Electronics: DAE4 Sn1338; Calibrated: 2012/6/12
- Phantom: ELI 4.0_Front; Type: QDOVA001BB; Serial: 1029
- Measurement SW: DASY52, Version 52.8 (3); SEMCAD X Version 14.6.5 (6469)

Configuration/Ch36/Area Scan (71x241x1): Measurement grid: dx=10mm, dy=10mm
 Maximum value of SAR (interpolated) = 1.69 mW/g

Configuration/Ch36/Zoom Scan (7x7x7)/Cube 0: Measurement grid: dx=4mm, dy=4mm, dz=1.4mm

Reference Value = 2.929 V/m; Power Drift = 0.13 dB

Peak SAR (extrapolated) = 2.795 mW/g

SAR(1 g) = 0.719 mW/g; SAR(10 g) = 0.217 mW/g

Maximum value of SAR (measured) = 1.67 mW/g

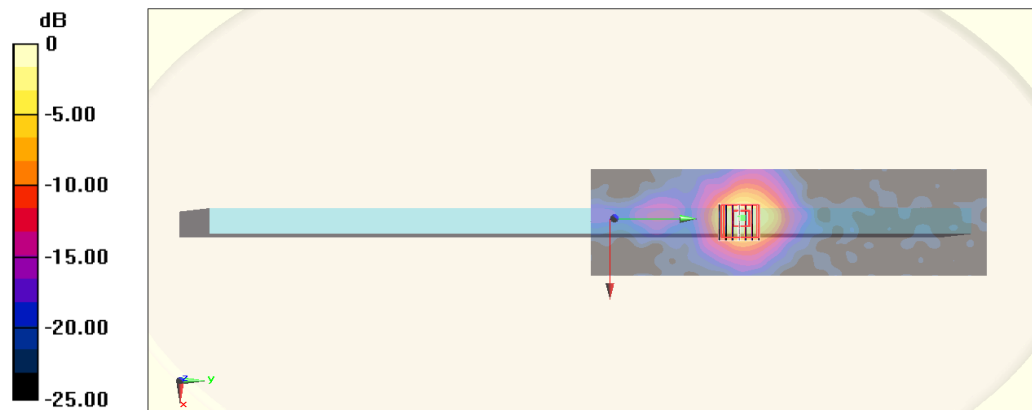

0 dB = 1.67 mW/g = 4.45 dB mW/g

12.3 Simultaneous Multi-band Transmission Analysis

No.	Applicable Simultaneous Transmission Combination
1.	WLAN 2.4GHz 802.11b/g/HT20/HT40 (SISO) + Bluetooth
2.	WLAN 5GHz 802.11a/HT20/HT40 (SISO) + Bluetooth
3.	WLAN 5GHz 802.11an HT20/HT40 (MIMO) + Bluetooth

Note:

- The Bluetooth Power is refer to FCC ID: PPD-QCA9005 and Report No. RF120720E01-2.
- WLAN2.4GHz 802.11n-HT20/HT40 cannot simultaneous transmission with Bluetooth.
- EUT will choose either WLAN 2.4GHz or WLAN 5GHz according to the network signal condition; therefore, they will not transmit simultaneously.
- The Scaled SAR summation is calculated based on the same configuration and test position.
- Per KDB 447498 D01v05, simultaneous transmission SAR is compliant if,
 - Scalar SAR summation < 1.6W/kg.
 - SPLSR = (SAR1 + SAR2)1.5 / (min. separation distance, mm), and the peak separation distance is determined from the square root of [(x1-x2)2 + (y1-y2)2 + (z1-z2)2], where (x1, y1, z1) and (x2, y2, z2) are the coordinates of the extrapolated peak SAR locations in the zoom scan
If SPLSR ≤ 0.04, simultaneously transmission SAR measurement is not necessary
- For simultaneous transmission analysis, Bluetooth SAR is estimated per KDB 447498 D01v05 based on the formula below.
 - (max. power of channel, including tune-up tolerance, mW)/(min. test separation distance, mm)] $[\sqrt{f(\text{GHz})}/x]$ W/kg for test separation distances ≤ 50 mm; where x = 7.5 for 1-g SAR, and x = 18.75 for 10-g SAR.
 - 0.4 W/kg for 1-g SAR and 1.0 W/kg for 10-g SAR, when the test separation distances is > 50 mm.

Max Power	Exposure Position		Bottom Face	Edge 1
	Test separation		0 mm	0 mm
6.5 dBm	Antenna to user distance		5 mm	7.5 mm
	Estimated SAR (W/kg)		0.188W/kg	0.125 W/kg

Position	WLAN					Bluetooth		WLAN + Bluetooth
	Band	Mode	Antenna	Plot No	Reported SAR (W/kg)	Antenna	Estimated SAR (W/kg)	
Bottom Face At 0cm	WLAN2.4GHz Band	SISO	Ant 0	1	0.323	Ant 1	0.188	0.51
	WLAN5.2GHz Band	SISO	Ant 0	10	0.21	Ant 1	0.188	0.40
	WLAN5.3GHz Band	SISO	Ant 0	13	0.163	Ant 1	0.188	0.35
	WLAN5.5GHz Band	SISO	Ant 0	16	0.177	Ant 1	0.188	0.37
	WLAN5.8GHz Band	SISO	Ant 0	20	0.191	Ant 1	0.188	0.38
	WLAN5.2GHz Band	MIMO	Ant 0+1	24	0.280	Ant 1	0.188	0.47
	WLAN5.8GHz Band	MIMO	Ant 0+1	35	0.235	Ant 1	0.188	0.42
Edge1 At 0cm	WLAN2.4GHz Band	SISO	Ant 0	2	0.442	Ant 1	0.125	0.57
	WLAN5.2GHz Band	SISO	Ant 0	11	0.758	Ant 1	0.125	0.88
	WLAN5.3GHz Band	SISO	Ant 0	14	0.339	Ant 1	0.125	0.46
	WLAN5.5GHz Band	SISO	Ant 0	17	0.437	Ant 1	0.125	0.56
	WLAN5.8GHz Band	SISO	Ant 0	21	0.343	Ant 1	0.125	0.47
	WLAN5.2GHz Band	MIMO	Ant 0+1	25	0.707	Ant 1	0.125	0.83
	WLAN5.8GHz Band	MIMO	Ant 0+1	36	0.360	Ant 1	0.188	0.55

Test Engineer : Michael Yang and Nick Yu

13. Uncertainty Assessment

The component of uncertainty may generally be categorized according to the methods used to evaluate them. The evaluation of uncertainty by the statistical analysis of a series of observations is termed a Type A evaluation of uncertainty. The evaluation of uncertainty by means other than the statistical analysis of a series of observation is termed a Type B evaluation of uncertainty. Each component of uncertainty, however evaluated, is represented by an estimated standard deviation, termed standard uncertainty, which is determined by the positive square root of the estimated variance.

A Type A evaluation of standard uncertainty may be based on any valid statistical method for treating data. This includes calculating the standard deviation of the mean of a series of independent observations; using the method of least squares to fit a curve to the data in order to estimate the parameter of the curve and their standard deviations; or carrying out an analysis of variance in order to identify and quantify random effects in certain kinds of measurement.

A type B evaluation of standard uncertainty is typically based on scientific judgment using all of the relevant information available. These may include previous measurement data, experience, and knowledge of the behavior and properties of relevant materials and instruments, manufacture’s specification, data provided in calibration reports and uncertainties assigned to reference data taken from handbooks. Broadly speaking, the uncertainty is either obtained from an outdoor source or obtained from an assumed distribution, such as the normal distribution, rectangular or triangular distributions indicated in Table 12.1

Uncertainty Distributions	Normal	Rectangular	Triangular	U-Shape
Multi-plying Factor ^(a)	1/k ^(b)	1/√3	1/√6	1/√2

- (a) standard uncertainty is determined as the product of the multiplying factor and the estimated range of variations in the measured quantity
- (b) κ is the coverage factor

Table 13.1 Standard Uncertainty for Assumed Distribution

The combined standard uncertainty of the measurement result represents the estimated standard deviation of the result. It is obtained by combining the individual standard uncertainties of both Type A and Type B evaluation using the usual “root-sum-squares” (RSS) methods of combining standard deviations by taking the positive square root of the estimated variances.

Expanded uncertainty is a measure of uncertainty that defines an interval about the measurement result within which the measured value is confidently believed to lie. It is obtained by multiplying the combined standard uncertainty by a coverage factor. Typically, the coverage factor ranges from 2 to 3. Using a coverage factor allows the true value of a measured quantity to be specified with a defined probability within the specified uncertainty range. For purpose of this document, a coverage factor two is used, which corresponds to confidence interval of about 95 %. The DASY uncertainty Budget is shown in the following tables.



Error Description	Uncertainty	Probability	Divisor	Ci	Ci	Standard	Standard
	Value	Distribution		(1g)	(10g)	Uncertainty	Uncertainty
	(±%)					(1g)	(10g)
Measurement System							
Probe Calibration	6.0	Normal	1	1	1	± 6.0 %	± 6.0 %
Axial Isotropy	4.7	Rectangular	√3	0.7	0.7	± 1.9 %	± 1.9 %
Hemispherical Isotropy	9.6	Rectangular	√3	0.7	0.7	± 3.9 %	± 3.9 %
Boundary Effects	1.0	Rectangular	√3	1	1	± 0.6 %	± 0.6 %
Linearity	4.7	Rectangular	√3	1	1	± 2.7 %	± 2.7 %
System Detection Limits	1.0	Rectangular	√3	1	1	± 0.6 %	± 0.6 %
Readout Electronics	0.3	Normal	1	1	1	± 0.3 %	± 0.3 %
Response Time	0.8	Rectangular	√3	1	1	± 0.5 %	± 0.5 %
Integration Time	2.6	Rectangular	√3	1	1	± 1.5 %	± 1.5 %
RF Ambient Noise	3.0	Rectangular	√3	1	1	± 1.7 %	± 1.7 %
RF Ambient Reflections	3.0	Rectangular	√3	1	1	± 1.7 %	± 1.7 %
Probe Positioner	0.4	Rectangular	√3	1	1	± 0.2 %	± 0.2 %
Probe Positioning	2.9	Rectangular	√3	1	1	± 1.7 %	± 1.7 %
Max. SAR Eval.	1.0	Rectangular	√3	1	1	± 0.6 %	± 0.6 %
Test Sample Related							
Device Positioning	2.9	Normal	1	1	1	± 2.9 %	± 2.9 %
Device Holder	3.6	Normal	1	1	1	± 3.6 %	± 3.6 %
Power Drift	5.0	Rectangular	√3	1	1	± 2.9 %	± 2.9 %
Phantom and Setup							
Phantom Uncertainty	4.0	Rectangular	√3	1	1	± 2.3 %	± 2.3 %
Liquid Conductivity (Target)	5.0	Rectangular	√3	0.64	0.43	± 1.8 %	± 1.2 %
Liquid Conductivity (Meas.)	2.5	Normal	1	0.64	0.43	± 1.6 %	± 1.1 %
Liquid Permittivity (Target)	5.0	Rectangular	√3	0.6	0.49	± 1.7 %	± 1.4 %
Liquid Permittivity (Meas.)	2.5	Normal	1	0.6	0.49	± 1.5 %	± 1.2 %
Combined Standard Uncertainty						± 11.0 %	± 10.8 %
Coverage Factor for 95 %						K=2	
Expanded Uncertainty						± 22.0 %	± 21.5 %

Table 13.2 Uncertainty Budget for frequency range 300 MHz to 3 GHz



Error Description	Uncertainty	Probability	Divisor	Ci	Ci	Standard	Standard
	Value	Distribution		(1g)	(10g)	Uncertainty	Uncertainty
	(±%)					(1g)	(10g)
Measurement System							
Probe Calibration	6.55	Normal	1	1	1	± 6.55 %	± 6.55 %
Axial Isotropy	4.7	Rectangular	√3	0.7	0.7	± 1.9 %	± 1.9 %
Hemispherical Isotropy	9.6	Rectangular	√3	0.7	0.7	± 3.9 %	± 3.9 %
Boundary Effects	2.0	Rectangular	√3	1	1	± 1.2 %	± 1.2 %
Linearity	4.7	Rectangular	√3	1	1	± 2.7 %	± 2.7 %
System Detection Limits	1.0	Rectangular	√3	1	1	± 0.6 %	± 0.6 %
Readout Electronics	0.3	Normal	1	1	1	± 0.3 %	± 0.3 %
Response Time	0.8	Rectangular	√3	1	1	± 0.5 %	± 0.5 %
Integration Time	2.6	Rectangular	√3	1	1	± 1.5 %	± 1.5 %
RF Ambient Noise	3.0	Rectangular	√3	1	1	± 1.7 %	± 1.7 %
RF Ambient Reflections	3.0	Rectangular	√3	1	1	± 1.7 %	± 1.7 %
Probe Positioner	0.8	Rectangular	√3	1	1	± 0.5 %	± 0.5 %
Probe Positioning	9.9	Rectangular	√3	1	1	± 5.7 %	± 5.7 %
Max. SAR Eval.	4.0	Rectangular	√3	1	1	± 2.3 %	± 2.3 %
Test Sample Related							
Device Positioning	2.9	Normal	1	1	1	± 2.9 %	± 2.9 %
Device Holder	3.6	Normal	1	1	1	± 3.6 %	± 3.6 %
Power Drift	5.0	Rectangular	√3	1	1	± 2.9 %	± 2.9 %
Phantom and Setup							
Phantom Uncertainty	4.0	Rectangular	√3	1	1	± 2.3 %	± 2.3 %
Liquid Conductivity (Target)	5.0	Rectangular	√3	0.64	0.43	± 1.8 %	± 1.2 %
Liquid Conductivity (Meas.)	2.5	Normal	1	0.64	0.43	± 1.6 %	± 1.1 %
Liquid Permittivity (Target)	5.0	Rectangular	√3	0.6	0.49	± 1.7 %	± 1.4 %
Liquid Permittivity (Meas.)	2.5	Normal	1	0.6	0.49	± 1.5 %	± 1.2 %
Combined Standard Uncertainty						± 12.8 %	± 12.6 %
Coverage Factor for 95 %						K=2	
Expanded Uncertainty						± 25.6 %	± 25.2 %

Table 13.3 Uncertainty Budget for frequency range 3 GHz to 6 GHz



14. References

- [1] FCC 47 CFR Part 2 "Frequency Allocations and Radio Treaty Matters; General Rules and Regulations"
- [2] ANSI/IEEE Std. C95.1-1992, "IEEE Standard for Safety Levels with Respect to Human Exposure to Radio Frequency Electromagnetic Fields, 3 kHz to 300 GHz", September 1992
- [3] IEEE Std. 1528-2003, "Recommended Practice for Determining the Peak Spatial-Average Specific Absorption Rate (SAR) in the Human Head from Wireless Communications Devices: Measurement Techniques", December 2003
- [4] FCC OET Bulletin 65 (Edition 97-01) Supplement C (Edition 01-01), "Evaluating Compliance with FCC Guidelines for Human Exposure to Radiofrequency Electromagnetic Fields", June 2001
- [5] SPEAG DASY System Handbook
- [6] FCC KDB 248227 D01 v01r02, "SAR Measurement Procedures for 802.11 a/b/g Transmitters", May 2007
- [7] FCC KDB 447498 D01 v05, "Mobile and Portable Device RF Exposure Procedures and Equipment Authorization Policies", October 2012



Appendix A. Plots of System Performance Check

The plots are shown as follows.



Appendix B. Plots of SAR Measurement

The plots are shown as follows.



Appendix C. DAS Y Calibration Certificate

The DAS Y calibration certificates are shown as follows.