

# FCC SAR Test Report

**APPLICANT** : Qualcomm Atheros, Incorporated  
**EQUIPMENT** : 2x2 802.11a/b/g/n/ad +BT module  
**BRAND NAME** : Qualcomm Atheros  
**MODEL NAME** : QCA9005  
**FCC ID** : PPD-QCA9005  
**STANDARD** : FCC 47 CFR Part 2 (2.1093)  
ANSI/IEEE C95.1-1992  
IEEE 1528-2003  
FCC OET Bulletin 65 Supplement C (Edition 01-01)

The product was installed into Tablet PC (Brand Name: DELL, Model Name: W01A, W01A001, XPS 18) during testing

The product was completely tested on Mar. 08, 2013. We, SPORTON INTERNATIONAL INC., would like to declare that the tested sample has been evaluated in accordance with the procedures and shown the compliance with the applicable technical standards.

The test results in this report apply exclusively to the tested model / sample. Without written approval of SPORTON INTERNATIONAL INC., the test report shall not be reproduced except in full.

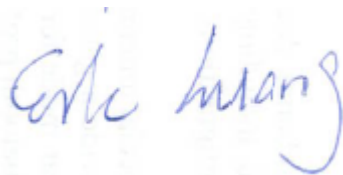

Reviewed by: Eric Huang / Assistant Manager



Approved by: Jones Tsai / Manager



**SPORTON INTERNATIONAL INC.**

No. 52, Hwa Ya 1<sup>st</sup> Rd., Hwa Ya Technology Park, Kwei-Shan Hsiang, Tao Yuan Hsien, Taiwan, R.O.C.



## Table of Contents

|  |           |
|--|-----------|
| <b>1. Statement of Compliance</b>                    | <b>4</b>  |
| <b>2. Administration Data</b>                        | <b>5</b>  |
| 2.1 Testing Laboratory                               | 5         |
| 2.2 Applicant  | 5         |
| 2.3 Manufacturer                                     | 5         |
| 2.4 Application Details                              | 5         |
| <b>3. General Information</b>                        | <b>6</b>  |
| 3.1 Description of Equipment Under Test (EUT)        | 6         |
| 3.2 Maximum RF output power among production units   | 7         |
| 3.3 Applied Standard                                 | 8         |
| 3.4 Device Category and SAR Limits                   | 8         |
| 3.5 Test Conditions                                  | 8         |
| <b>4. Specific Absorption Rate (SAR)</b>             | <b>9</b>  |
| 4.1 Introduction                                     | 9         |
| 4.2 SAR Definition                                   | 9         |
| <b>5. SAR Measurement System</b>                     | <b>10</b> |
| 5.1 E-Field Probe                                    | 11        |
| 5.2 Data Acquisition Electronics (DAE)               | 12        |
| 5.3 Robot  | 12        |
| 5.4 Measurement Server                               | 12        |
| 5.5 Phantom  | 13        |
| 5.6 Device Holder                                    | 14        |
| 5.7 Data Storage and Evaluation                      | 15        |
| 5.8 Test Equipment List                              | 17        |
| <b>6. Tissue Simulating Liquids</b>                  | <b>18</b> |
| <b>7. SAR System Verification</b>                    | <b>20</b> |
| 7.1 Purpose of System Performance check              | 20        |
| 7.2 System Setup                                     | 20        |
| 7.3 SAR System Verification Results                  | 21        |
| <b>8. EUT Testing Position</b>                       | <b>22</b> |
| <b>9. Measurement Procedures</b>                     | <b>22</b> |
| 9.1 Spatial Peak SAR Evaluation                      | 23        |
| 9.2 Power Reference Measurement                      | 23        |
| 9.3 Area & Zoom Scan Procedures                      | 24        |
| 9.4 Volume Scan Procedures                           | 25        |
| 9.5 SAR Averaged Methods                             | 25        |
| 9.6 Power Drift Monitoring                           | 25        |
| <b>10. Conducted RF Output Power (Unit: dBm)</b>     | <b>26</b> |
| <b>11. Exposure Positions Consideration</b>          | <b>32</b> |
| <b>12. SAR Test Results</b>                          | <b>35</b> |
| 12.1 Test Records for Body SAR Test                  | 35        |
| 12.2 Highest SAR Plot                                | 37        |
| 12.3 Simultaneous Multi-band Transmission Analysis   | 39        |
| <b>13. Uncertainty Assessment</b>                    | <b>40</b> |
| <b>14. References</b>                                | <b>43</b> |
| <b>Appendix A. Plots of System Performance Check</b> |           |
| <b>Appendix B. Plots of SAR Measurement</b>          |           |
| <b>Appendix C. DASYS Calibration Certificate</b>     |           |
| <b>Appendix D. Test Setup Photos</b>                 |           |





### 1. Statement of Compliance

The maximum results of Specific Absorption Rate (SAR) found during testing for **Qualcomm Atheros, Incorporated 2x2 802.11a/b/g/n/ad +BT module, Qualcomm Atheros, QCA9005** are as follows.

**<Highest Reported standalone SAR Summary>**

| Frequency Band   | Exposure Position | Reported 1g-SAR (W/kg) | Equipment Class | Highest Reported 1g-SAR (W/kg) |
|------------------|-------------------|------------------------|-----------------|--------------------------------|
| WLAN 5.2GHz Band | Body (0 cm Gap)   | 0.76                   | NII             | 0.76                           |
| WLAN 5.3GHz Band | Body (0 cm Gap)   | 0.40                   |                 |                                |
| WLAN 5.5GHz Band | Body (0 cm Gap)   | 0.47                   |                 |                                |
| WLAN 5.8GHz Band | Body (0 cm Gap)   | 0.36                   | DTS             | 0.47                           |
| WLAN 2.4GHz Band | Body (0 cm Gap)   | 0.47                   |                 |                                |

**<Highest Reported simultaneous SAR Summary>**

| Frequency Band   | Exposure Position | Reported 1g-SAR (W/kg) | Highest Reported 1g-SAR (W/kg) |
|------------------|-------------------|------------------------|--------------------------------|
| WLAN 5.2GHz Band | Body (0 cm Gap)   | 0.707                  | 0.83                           |
| Bluetooth        |                   | 0.125                  |                                |
| WLAN 5.8GHz Band | Body (0 cm Gap)   | 0.36                   | 0.55                           |
| Bluetooth        |                   | 0.188                  |                                |

This device is in compliance with Specific Absorption Rate (SAR) for general population/uncontrolled exposure limits (1.6 W/kg) specified in FCC 47 CFR part 2 (2.1093) and ANSI/IEEE C95.1-1992, and had been tested in accordance with the measurement methods and procedures specified in IEEE 1528-2003 and FCC OET Bulletin 65 Supplement C (Edition 01-01).



## 2. Administration Data

### 2.1 Testing Laboratory

|                    |   |
|--------------------|---|
| Test Site          | SPORTON INTERNATIONAL INC.  |
| Test Site Location | No. 52, Hwa Ya 1 <sup>st</sup> Rd., Hwa Ya Technology Park,<br>Kwei-Shan Hsiang, Tao Yuan Hsien, Taiwan, R.O.C.<br>TEL: +886-3-327-3456<br>FAX: +886-3-328-4978 |

### 2.2 Applicant

|              |  |
|--------------|--|
| Company Name | Qualcomm Atheros, Incorporated           |
| Address      | 1700 Technology Drive San Jose, CA 95110 |

### 2.3 Manufacturer

|              |  |
|--------------|--|
| Company Name | Qualcomm Atheros, Incorporated           |
| Address      | 1700 Technology Drive San Jose, CA 95110 |

### 2.4 Application Details

|                               |               |
|-------------------------------|---------------|
| Date of Start during the Test | Mar. 06, 2013 |
| Date of End during the Test   | Mar. 08, 2013 |

### 3. General Information

#### 3.1 Description of Equipment Under Test (EUT)

| Product Feature & Specification  |   |
|--|---|
| EUT  | 2x2 802.11a/b/g/n/ad +BT module   |
| Brand Name   | Qualcomm Atheros  |
| Model Name   | QCA9005   |
| FCC ID   | PPD-QCA9005   |
| TX Frequency   | WLAN 2.4GHz Band: 2412 MHz ~ 2462 MHz<br>WLAN 5.2GHz Band: 5180 MHz ~ 5240 MHz<br>WLAN 5.3GHz Band: 5260 MHz ~ 5320 MHz<br>WLAN 5.5GHz Band: 5500 MHz ~ 5700 MHz<br>WLAN 5.8GHz Band: 5745 MHz ~ 5825 MHz<br>Bluetooth: 2402 MHz ~ 2480 MHz |
| Uplink Modulations   | 802.11b: DSSS (DBPSK / DQPSK / CCK)<br>802.11a/g/n: OFDM (BPSK / QPSK / 16QAM / 64QAM)<br>Bluetooth : GFSK<br>Bluetooth EDR : $\pi/4$ -DQPSK, 8-DPSK<br>Bluetooth 4.0 LE: GFSK  |
| EUT Stage  | Production Unit   |
| <b>Remark:</b><br>1. The above EUT's information was declared by manufacturer. Please refer to the specifications or user's manual for more detailed description.<br>2. 5600 MHz ~ 5650 MHz is notched.<br>3. The Bluetooth Power is refer to FCC ID: PPD-QCA9005 and Report No. RF120720E01-2 |   |

The product was installed into Tablet PC (Brand Name: DELL, Model Name: W01A, W01A001, XPS 18) during testing

| Product Feature & Specification   |  |
|---|--|
| Host  | Tablet PC  |
| Brand Name  | DELL   |
| Model Name  | W01A, W01A001, XPS 18  |
| Antenna 1   | Vendor : WHA YU<br>Main : C1335-520243-A(Tx1, White) AUX : C1335-520244-A(Tx2, Black)<br>Antenna Gain:1.94 dBi |
| Antenna 2   | Vendor : Wanshih<br>Main : UC1WFI0109(Tx2, White) AUX : UC1WFI0108(Tx1, Black)<br>Antenna Gain:2.91 dBi        |
| Antenna Type  | WLAN: PIFA Antenna<br>Bluetooth: PIFA Antenna  |
| <b>Remark:</b><br>1. This product have two models of antenna, due to the antenna type are the same that chosen highest antenna gain under tested.<br>2. Pre KDB 178919 D01 v05r01, for Part 15 device, identical antenna type with the same or lower gain, with no other change to the transmitter and host device configurations, and the highest SAR measured for that antenna type in previous certification is less than 0.8 W/kg, SAR evaluation is not required to add an equivalent antenna. |  |



**3.2 Maximum RF output power among production units**

| IEEE 802.11 Average power(dBm) |       |      |      |      |         |      |      |      |
|--------------------------------|-------|------|------|------|---------|------|------|------|
| Normal                         |       |      |      |      |         |      |      |      |
| WLAN2.4GHz                     | Ant 0 |      |      |      | Ant 0+1 |      |      |      |
| Freq (MHz)                     | 11b   | 11g  | HT20 | HT40 | 11b     | 11g  | HT20 | HT40 |
| 2412                           | 15.5  | 12.5 | 12.0 |      | 18.5    | 15.5 | 15.0 |      |
| 2422                           |       |      |      | 9.5  |         |      |      | 12.5 |
| 2437                           | 15.5  | 15.5 | 15.5 | 12.0 | 18.5    | 18.5 | 18.5 | 15.0 |
| 2452                           |       |      |      | 9.5  |         |      |      | 12.5 |
| 2462                           | 15.5  | 11.5 | 11.0 |      | 18.5    | 14.5 | 14.0 |      |

| Mode / Band       | Bluetooth |                   |          |            |
|-------------------|-----------|-------------------|----------|------------|
|                   | 1Mbps     | 2Mbps             | 3Mbps    | BT v4.0 LE |
|                   | (GFSK)    | ( $\pi/4$ -DQPSK) | (8-DPSK) | (GFSK)     |
| 2.4 GHz Bluetooth | 6         | 6                 | 6.5      | 6          |

| IEEE 802.11 Average power(dBm) |       |       |       |         |       |       |
|--------------------------------|-------|-------|-------|---------|-------|-------|
| Normal                         |       |       |       |         |       |       |
| WLAN 5GHz                      | Ant 0 |       |       | Ant 0+1 |       |       |
| Freq (MHz)                     | 11a   | HT20  | HT40  | 11a     | HT20  | HT40  |
| 5180                           | 11.50 | 10.50 |       | 14.50   | 13.50 |       |
| 5190                           |       |       | 9.00  |         |       | 12.00 |
| 5200                           | 11.00 | 10.50 |       | 14.00   | 13.50 |       |
| 5220                           | 11.00 | 10.50 |       | 14.00   | 13.50 |       |
| 5230                           |       |       | 10.00 |         |       | 13.00 |
| 5240                           | 10.50 | 10.00 |       | 13.50   | 13.00 |       |
| 5260                           | 10.50 | 9.50  |       | 13.50   | 12.50 |       |
| 5270                           |       |       | 9.50  |         |       | 12.50 |
| 5280                           | 10.50 | 9.50  |       | 13.50   | 12.50 |       |
| 5300                           | 10.50 | 9.50  |       | 13.50   | 12.50 |       |
| 5310                           |       |       | 9.50  |         |       | 12.50 |
| 5320                           | 10.00 | 9.50  |       | 13.00   | 12.50 |       |
| 5500                           | 10.50 | 9.50  |       | 13.50   | 12.50 |       |
| 5510                           |       |       | 7.00  |         |       | 10.00 |
| 5520                           | 10.50 | 9.50  |       | 13.50   | 12.50 |       |
| 5540                           | 10.50 | 9.50  |       | 13.50   | 12.50 |       |
| 5550                           |       |       | 9.50  |         |       | 12.50 |
| 5560                           | 10.50 | 9.50  |       | 13.50   | 12.50 |       |
| 5580                           | 10.50 | 9.50  |       | 13.50   | 12.50 |       |
| 5660                           | 10.50 | 9.50  |       | 13.50   | 12.50 |       |
| 5670                           |       |       | 10.50 |         |       | 13.50 |
| 5680                           | 10.50 | 9.50  |       | 13.50   | 12.50 |       |
| 5700                           | 10.50 | 10.50 |       | 13.50   | 13.50 |       |
| 5745                           | 10.50 | 10.50 |       | 13.50   | 13.50 |       |
| 5755                           |       |       | 10.50 |         |       | 13.50 |
| 5765                           | 11.00 | 11.00 |       | 14.00   | 14.00 |       |
| 5785                           | 11.00 | 11.00 |       | 14.00   | 14.00 |       |
| 5795                           |       |       | 10.50 |         |       | 13.50 |
| 5805                           | 11.00 | 11.00 |       | 14.00   | 14.00 |       |
| 5825                           | 10.50 | 11.00 |       | 13.50   | 14.00 |       |



### 3.3 Applied Standard

The Specific Absorption Rate (SAR) testing specification, method, and procedure for this device is in accordance with the following standards:

- FCC 47 CFR Part 2 (2.1093)
- ANSI/IEEE C95.1-1992
- IEEE 1528-2003
- FCC OET Bulletin 65 Supplement C (Edition 01-01)
- FCC KDB 447498 D01 v05
- FCC KDB 248227 D01 v01r02
- FCC KDB 616217 D04 v01
- FCC KDB 178919 D01 v05r01

### 3.4 Device Category and SAR Limits

This device belongs to portable device category because its radiating structure is allowed to be used within 20 centimeters of the body of the user. Limit for General Population/Uncontrolled exposure should be applied for this device, it is 1.6 W/kg as averaged over any 1 gram of tissue.

### 3.5 Test Conditions

#### 3.5.1 Ambient Condition

|                     |             |
|---------------------|-------------|
| Ambient Temperature | 20 to 24 °C |
| Humidity            | < 60 %      |

#### 3.5.2 Test Configuration

During WLAN SAR testing EUT is configured with the WLAN continuous TX tool, and the transmission duty factor was monitored on the spectrum analyzer with zero-span setting

Duty factor observed as below:

802.11b, 1Mbps: 100%

802.11a, 6Mbps: 100%

802.11 HT40, MCS8: 100%

For WLAN SAR testing, WLAN engineering testing software installed on the EUT can provide continuous transmitting RF signal.



## **4. Specific Absorption Rate (SAR)**

### **4.1 Introduction**

SAR is related to the rate at which energy is absorbed per unit mass in an object exposed to a radio field. The SAR distribution in a biological body is complicated and is usually carried out by experimental techniques or numerical modeling. The standard recommends limits for two tiers of groups, occupational/controlled and general population/uncontrolled, based on a person's awareness and ability to exercise control over his or her exposure. In general, occupational/controlled exposure limits are higher than the limits for general population/uncontrolled.

### **4.2 SAR Definition**

The SAR definition is the time derivative (rate) of the incremental energy (dW) absorbed by (dissipated in) an incremental mass (dm) contained in a volume element (dv) of a given density ( $\rho$ ). The equation description is as below:

$$\text{SAR} = \frac{d}{dt} \left( \frac{dW}{dm} \right) = \frac{d}{dt} \left( \frac{dW}{\rho dv} \right)$$

SAR is expressed in units of Watts per kilogram (W/kg)

SAR measurement can be either related to the temperature elevation in tissue by

$$\text{SAR} = C \left( \frac{\delta T}{\delta t} \right)$$

Where: C is the specific heat capacity,  $\delta T$  is the temperature rise and  $\delta t$  is the exposure duration, or related to the electrical field in the tissue by

$$\text{SAR} = \frac{\sigma |E|^2}{\rho}$$

Where:  $\sigma$  is the conductivity of the tissue,  $\rho$  is the mass density of the tissue and E is the RMS electrical field strength.

However for evaluating SAR of low power transmitter, electrical field measurement is typically applied.

## 5. SAR Measurement System

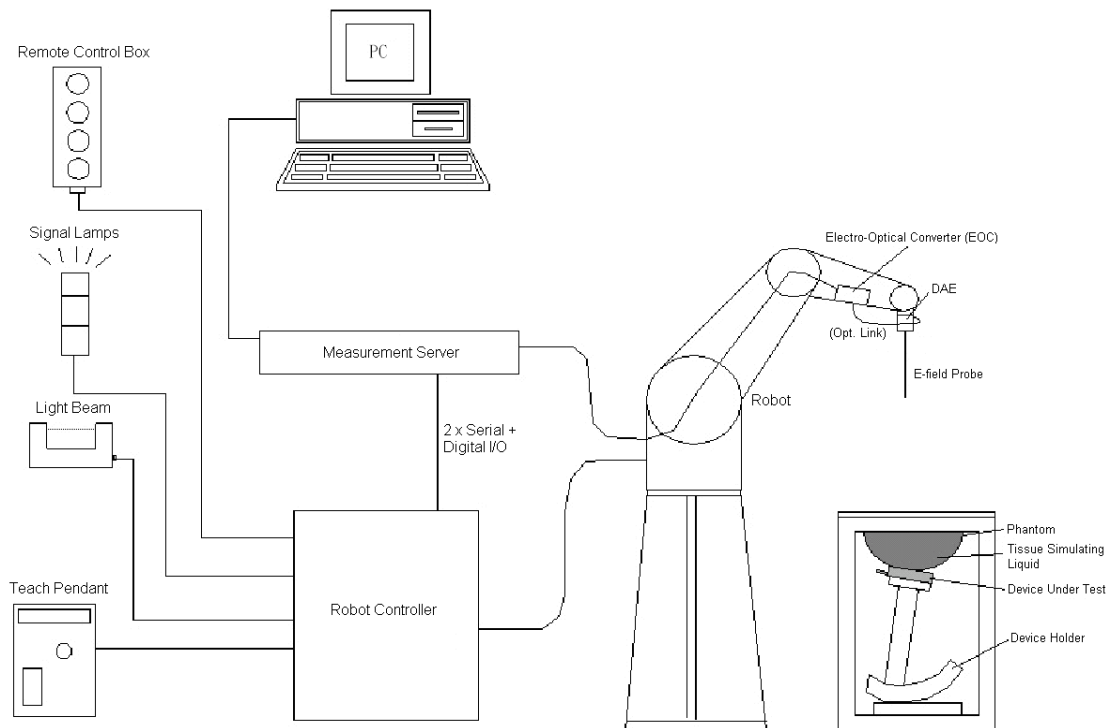

**Fig 5.1 SPEAG DASY System Configurations**

The DASY system for performance compliance tests is illustrated above graphically. This system consists of the following items:

- A standard high precision 6-axis robot with controller, a teach pendant and software
- A data acquisition electronic (DAE) attached to the robot arm extension
- A dosimetric probe equipped with an optical surface detector system
- The electro-optical converter (EOC) performs the conversion between optical and electrical signals
- A measurement server performs the time critical tasks such as signal filtering, control of the robot operation and fast movement interrupts.
- A probe alignment unit which improves the accuracy of the probe positioning
- A computer operating Windows XP
- DASY software
- Remote control with teach pendant and additional circuitry for robot safety such as warning lamps, etc.
- The SAM twin phantom
- A device holder
- Tissue simulating liquid
- Dipole for evaluating the proper functioning of the system

Component details are described in in the following sub-sections.

### 5.1 E-Field Probe

The SAR measurement is conducted with the dosimetric probe (manufactured by SPEAG). The probe is specially designed and calibrated for use in liquid with high permittivity. The dosimetric probe has special calibration in liquid at different frequency. This probe has a built in optical surface detection system to prevent from collision with phantom.

#### 5.1.1 E-Field Probe Specification

##### <ES3DV3 Probe >

|                      |  |
|----------------------|--|
| <b>Construction</b>  | Symmetrical design with triangular core<br>Built-in optical fiber for surface detection system.<br>Built-in shielding against static charges.<br>PEEK enclosure material (resistant to organic solvents, e.g., DGBE) |
| <b>Frequency</b>     | 10 MHz to 3 GHz; Linearity: $\pm 0.2$ dB   |
| <b>Directivity</b>   | $\pm 0.2$ dB in HSL (rotation around probe axis)<br>$\pm 0.4$ dB in HSL (rotation normal to probe axis)  |
| <b>Dynamic Range</b> | 10 $\mu$ W/g to 100 mW/g; Linearity: $\pm 0.2$ dB  |
| <b>Dimensions</b>    | Overall length: 337 mm (Tip: 10 mm)<br>Tip diameter: 4 mm (Body: 10 mm)<br>Distance from probe tip to dipole centers: 3 mm   |



Fig 5.2 Photo of ES3DV3

##### <EX3DV4 Probe>

|                      |   |
|----------------------|---|
| <b>Construction</b>  | Symmetrical design with triangular core<br>Built-in shielding against static charges<br>PEEK enclosure material (resistant to organic solvents, e.g., DGBE) |
| <b>Frequency</b>     | 10 MHz to 6 GHz; Linearity: $\pm 0.2$ dB  |
| <b>Directivity</b>   | $\pm 0.3$ dB in HSL (rotation around probe axis)<br>$\pm 0.5$ dB in tissue material (rotation normal to probe axis)   |
| <b>Dynamic Range</b> | 10 $\mu$ W/g to 100 mW/g; Linearity: $\pm 0.2$ dB<br>(noise: typically $< 1 \mu$ W/g)   |
| <b>Dimensions</b>    | Overall length: 330 mm (Tip: 20 mm)<br>Tip diameter: 2.5 mm (Body: 12 mm)<br>Typical distance from probe tip to dipole centers: 1 mm                        |



Fig 5.3 Photo of EX3DV4/ES3DV4

#### 5.1.2 E-Field Probe Calibration

Each probe needs to be calibrated according to a dosimetric assessment procedure with accuracy better than  $\pm 10\%$ . The spherical isotropy shall be evaluated and within  $\pm 0.25$ dB. The sensitivity parameters (NormX, NormY, and NormZ), the diode compression parameter (DCP) and the conversion factor (ConvF) of the probe are tested. The calibration data can be referred to appendix C of this report.

### 5.2 Data Acquisition Electronics (DAE)

The data acquisition electronics (DAE) consists of a highly sensitive electrometer-grade preamplifier with auto-zeroing, a channel and gain-switching multiplexer, a fast 16 bit AD-converter and a command decoder and control logic unit. Transmission to the measurement server is accomplished through an optical downlink for data and status information as well as an optical uplink for commands and the clock. The input impedance of the DAE is 200 MOhm; the inputs are symmetrical and floating. Common mode rejection is above 80 dB.



Fig 5.4 Photo of DAE

### 5.3 Robot

The SPEAG DASY system uses the high precision robots (DASY4: RX90BL; DASY5: TX90XL) type from Stäubli SA (France). For the 6-axis controller system, the robot controller version (DASY4: CS7MB; DASY5: CS8c) from Stäubli is used. The Stäubli robot series have many features that are important for our application:

- High precision (repeatability  $\pm 0.035$  mm)
- High reliability (industrial design)
- Jerk-free straight movements
- Low ELF interference (the closed metallic construction shields against motor control fields)



Fig 5.5 Photo of DASY4



Fig 5.6 Photo of DASY5

### 5.4 Measurement Server

The measurement server is based on a PC/104 CPU board with CPU (DASY4: 166 MHz, Intel Pentium; DASY5: 400 MHz, Intel Celeron), chipdisk (DASY4: 32 MB; DASY5: 128 MB), RAM (DASY4: 64 MB, DASY5: 128 MB). The necessary circuits for communication with the DAE electronic box, as well as the 16 bit AD converter system for optical detection and digital I/O interface are contained on the DASY I/O board, which is directly connected to the PC/104 bus of the CPU board.

The measurement server performs all the real-time data evaluation for field measurements and surface detection, controls robot movements and handles safety operations.



Fig 5.7 Photo of Server for DASY4



Fig 5.8 Photo of Server for DASY5

**5.5 Phantom**

**<SAM Twin Phantom>**

|                          |  |
|--------------------------|--|
| <b>Shell Thickness</b>   | 2 ± 0.2 mm;<br>Center ear point: 6 ± 0.2 mm                |
| <b>Filling Volume</b>    | Approx. 25 liters  |
| <b>Dimensions</b>        | Length: 1000 mm; Width: 500 mm;<br>Height: adjustable feet |
| <b>Measurement Areas</b> | Left Hand, Right Hand, Flat Phantom                        |



**Fig 5.9 Photo of SAM Phantom**

The bottom plate contains three pair of bolts for locking the device holder. The device holder positions are adjusted to the standard measurement positions in the three sections. A white cover is provided to tap the phantom during off-periods to prevent water evaporation and changes in the liquid parameters. On the phantom top, three reference markers are provided to identify the phantom position with respect to the robot.

**<ELI4 Phantom>**

|                        |  |
|------------------------|--|
| <b>Shell Thickness</b> | 2 ± 0.2 mm (sagging: <1%)                        |
| <b>Filling Volume</b>  | Approx. 30 liters                                |
| <b>Dimensions</b>      | Major ellipse axis: 600 mm<br>Minor axis: 400 mm |



**Fig 5.10 Photo of ELI4 Phantom**

The ELI4 phantom is intended for compliance testing of handheld and body-mounted wireless devices in the frequency range of 30 MHz to 6 GHz. ELI4 is fully compatible with standard and all known tissue simulating liquids.

## 5.6 Device Holder

### <Device Holder for SAM Twin Phantom>

The SAR in the phantom is approximately inversely proportional to the square of the distance between the source and the liquid surface. For a source at 5 mm distance, a positioning uncertainty of  $\pm 0.5$  mm would produce a SAR uncertainty of  $\pm 20$  %. Accurate device positioning is therefore crucial for accurate and repeatable measurements. The positions in which the devices must be measured are defined by the standards.

The DASY device holder is designed to cope with different positions given in the standard. It has two scales for the device rotation (with respect to the body axis) and the device inclination (with respect to the line between the ear reference points). The rotation center for both scales is the ear reference point (ERP). Thus the device needs no repositioning when changing the angles.

The DASY device holder is constructed of low-loss POM material having the following dielectric parameters: relative permittivity  $\epsilon = 3$  and loss tangent  $\delta = 0.02$ . The amount of dielectric material has been reduced in the closest vicinity of the device, since measurements have suggested that the influence of the clamp on the test results could thus be lowered.



Fig 5.11 Device Holder

### <Laptop Extension Kit>

The extension is lightweight and made of POM, acrylic glass and foam. It fits easily on the upper part of the mounting device in place of the phone positioned. The extension is fully compatible with the SAM Twin and ELI phantoms.

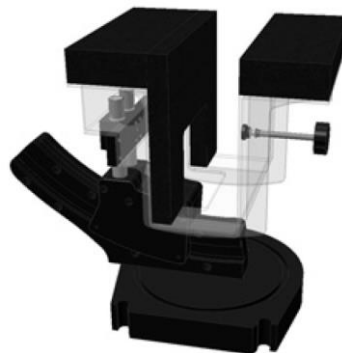

Fig 5.12 Laptop Extension Kit



## 5.7 Data Storage and Evaluation

### 5.7.1 Data Storage

The DASY software stores the assessed data from the data acquisition electronics as raw data (in microvolt readings from the probe sensors), together with all the necessary software parameters for the data evaluation (probe calibration data, liquid parameters and device frequency and modulation data) in measurement files. The post-processing software evaluates the desired unit and format for output each time the data is visualized or exported. This allows verification of the complete software setup even after the measurement and allows correction of erroneous parameter settings. For example, if a measurement has been performed with an incorrect crest factor parameter in the device setup, the parameter can be corrected afterwards and the data can be reevaluated.

The measured data can be visualized or exported in different units or formats, depending on the selected probe type (e.g., [V/m], [A/m], [mW/g]). Some of these units are not available in certain situations or give meaningless results, e.g., a SAR-output in a non-lose media, will always be zero. Raw data can also be exported to perform the evaluation with other software packages.

### 5.7.2 Data Evaluation

The DASY post-processing software (SEMCAD) automatically executes the following procedures to calculate the field units from the microvolt readings at the probe connector. The parameters used in the evaluation are stored in the configuration modules of the software :

|                            |                           |   |
|----------------------------|---------------------------|---|
| <b>Probe parameters :</b>  | - Sensitivity             | Norm <sub>i</sub> , a <sub>i0</sub> , a <sub>i1</sub> , a <sub>i2</sub> |
|                            | - Conversion factor       | ConvF <sub>i</sub>  |
|                            | - Diode compression point | dcp <sub>i</sub>  |
| <b>Device parameters :</b> | - Frequency               | f   |
|                            | - Crest factor            | cf  |
| <b>Media parameters :</b>  | - Conductivity            | σ   |
|                            | - Density                 | ρ   |

These parameters must be set correctly in the software. They can be found in the component documents or they can be imported into the software from the configuration files issued for the DASY components. In the direct measuring mode of the multi-meter option, the parameters of the actual system setup are used. In the scan visualization and export modes, the parameters stored in the corresponding document files are used.

The first step of the evaluation is a linearization of the filtered input signal to account for the compression characteristics of the detector diode. The compensation depends on the input signal, the diode type and the DC-transmission factor from the diode to the evaluation electronics. If the exciting field is pulsed, the crest factor of the signal must be known to correctly compensate for peak power.

The formula for each channel can be given as :

$$V_i = U_i + U_i^2 \cdot \frac{cf}{dcp_i}$$

with  $V_i$  = compensated signal of channel i, (i = x, y, z)  
 $U_i$  = input signal of channel i, (i = x, y, z)  
 cf = crest factor of exciting field (DASY parameter)  
 dcp<sub>i</sub> = diode compression point (DASY parameter)

From the compensated input signals, the primary field data for each channel can be evaluated :

$$\text{E-field Probes : } E_i = \sqrt{\frac{V_i}{\text{Norm}_i \cdot \text{ConvF}}}$$

$$\text{H-field Probes : } H_i = \sqrt{V_i \cdot \frac{a_{i0} + a_{i1}f + a_{i2}f^2}{f}}$$

with  $V_i$  = compensated signal of channel i, (i = x, y, z)  
 $\text{Norm}_i$  = sensor sensitivity of channel i, (i = x, y, z),  $\mu\text{V}/(\text{V/m})^2$  for E-field Probes  
 ConvF = sensitivity enhancement in solution  
 $a_{ij}$  = sensor sensitivity factors for H-field probes  
 f = carrier frequency [GHz]  
 $E_i$  = electric field strength of channel i in V/m  
 $H_i$  = magnetic field strength of channel i in A/m

The RSS value of the field components gives the total field strength (Hermitian magnitude) :

$$E_{\text{tot}} = \sqrt{E_x^2 + E_y^2 + E_z^2}$$

The primary field data are used to calculate the derived field units.

$$\text{SAR} = E_{\text{tot}}^2 \cdot \frac{\sigma}{\rho \cdot 1000}$$

with SAR = local specific absorption rate in mW/g  
 $E_{\text{tot}}$  = total field strength in V/m  
 $\sigma$  = conductivity in [mho/m] or [Siemens/m]  
 $\rho$  = equivalent tissue density in  $\text{g}/\text{cm}^3$

Note that the density is set to 1, to account for actual head tissue density rather than the density of the tissue simulating liquid.





**5.8 Test Equipment List**

| Manufacturer | Name of Equipment                  | Type/Model    | Serial Number | Calibration   |               |
|--------------|------------------------------------|---------------|---------------|---------------|---------------|
|              |                                    |               |               | Last Cal.     | Due Date      |
| SPEAG        | 2450MHz System Validation Kit      | D2450V2       | 736           | Jul. 25, 2011 | Jul. 24, 2013 |
| SPEAG        | 5GHz System Validation Kit         | D5GHzV2       | 1006          | Dec. 11, 2012 | Dec. 10, 2013 |
| SPEAG        | Data Acquisition Electronics       | DAE4          | 778           | Aug. 27, 2012 | Aug. 26, 2013 |
| SPEAG        | Data Acquisition Electronics       | DAE4          | 1338          | Jun. 12, 2012 | Jun. 11, 2013 |
| SPEAG        | Dosimetric E-Field Probe           | ES3DV3        | 3270          | Sep. 28, 2012 | Sep. 27, 2013 |
| SPEAG        | Dosimetric E-Field Probe           | EX3DV4        | 3792          | Jun. 21, 2012 | Jun. 20, 2013 |
| Wisewind     | Thermometer                        | ETP-101       | TM560         | Nov. 13, 2012 | Nov. 12, 2013 |
| Wisewind     | Thermometer                        | HTC-1         | TM281         | Nov. 13, 2012 | Nov. 12, 2013 |
| SPEAG        | Device Holder                      | N/A           | N/A           | NCR           | NCR           |
| SPEAG        | ELI4 Phantom                       | QD 0VA 001 BB | 1026          | NCR           | NCR           |
| SPEAG        | ELI4 Phantom                       | QD 0VA 001 BA | 1029          | NCR           | NCR           |
| Agilent      | ENA Network Analyzer               | E5071C        | MY46316648    | Feb. 07, 2013 | Feb. 06, 2014 |
| Agilent      | ESG Vector Series Signal Generator | E4438C        | MY49070755    | Oct. 02, 2012 | Oct. 01, 2013 |
| Anritsu      | Power Meter                        | ML2495A       | 1132003       | Aug. 14, 2012 | Aug. 13, 2013 |
| Agilent      | Dual Directional Coupler           | 778D          | 50422         | Note 4        |               |
| Woken        | Attenuator 1                       | WK0602-XX     | N/A           | Note 4        |               |
| PE           | Attenuator 2                       | PE7005-10     | N/A           | Note 4        |               |
| PE           | Attenuator 3                       | PE7005- 3     | N/A           | Note 4        |               |
| Agilent      | Dielectric Probe Kit               | 85070D        | US01440205    | Note 5        |               |
| AR           | Power Amplifier                    | 5S1G4M2       | 328767        | Note 6        |               |
| R&S          | Spectrum Analyzer                  | FSP           | 101131        | Jul. 23, 2012 | Jul. 22, 2013 |

**Note:**

1. The calibration certificate of DASY can be referred to appendix C of this report.
2. Referring to KDB 865664 D01v01, the dipole calibration interval can be extended to 3 years with justification. The dipoles are also not physically damaged, or repaired during the interval.
3. The justification data of dipole D2450V2, SN: 736, can be found in appendix C. The return loss is < -20dB, within 20% of prior calibration, the impedance is within 5 ohm of prior calibration.
4. The Insertion Loss calibration of Dual Directional Coupler and Attenuator were characterized via the network analyzer and compensated during system check.
5. The dielectric probe kit was calibrated via the network analyzer, with the specified procedure (calibrated in pure water) and calibration kit (standard) short circuit, before the dielectric measurement. The specific procedure and calibration kit are provided by Agilent.
6. In system check we need to monitor the level on the power meter, and adjust the power amplifier level to have precise power level to the dipole; the measured SAR will be normalized to 1W input power according to the ratio of 1W to the input power to the dipole. For system check, the calibration of the power amplifier is deemed not critically required for correct measurement; the power meter is critical and we do have calibration for it
7. Attenuator 1 insertion loss is calibrated by the network Analyzer, which the calibration is valid, before system check.

## 6. Tissue Simulating Liquids

For the measurement of the field distribution inside the SAM phantom with DASY, the phantom must be filled with around 25 liters of homogeneous body tissue simulating liquid. For head SAR testing, the liquid height from the ear reference point (ERP) of the phantom to the liquid top surface is larger than 15 cm, which is shown in Fig. 6.1. For body SAR testing, the liquid height from the center of the flat phantom to the liquid top surface is larger than 15 cm, which is shown in Fig. 6.2.

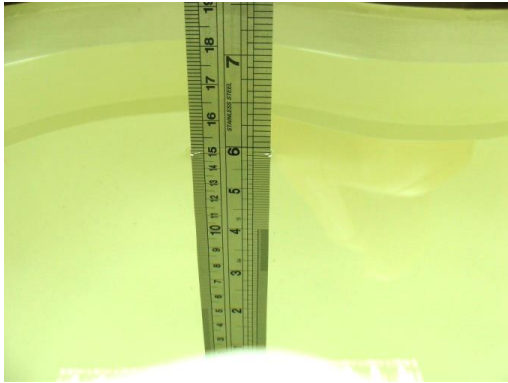

Fig 6.1 Photo of Liquid Height for Head SAR



Fig 6.2 Photo of Liquid Height for Body SAR

The following table gives the recipes for tissue simulating liquid.

| Frequency (MHz)  | Water (%) | Sugar (%) | Cellulose (%) | Salt (%) | Preventol (%) | DGBE (%) | Conductivity ( $\sigma$ ) | Permittivity ( $\epsilon_r$ ) |
|------------------|-----------|-----------|---------------|----------|---------------|----------|---------------------------|-------------------------------|
| <b>For Body</b>  |           |           |               |          |               |          |                           |                               |
| 750              | 51.7      | 47.2      | 0             | 0.9      | 0.1           | 0        | 0.96                      | 55.5                          |
| 835              | 50.8      | 48.2      | 0             | 0.9      | 0.1           | 0        | 0.97                      | 55.2                          |
| 900              | 50.8      | 48.2      | 0             | 0.9      | 0.1           | 0        | 1.05                      | 55.0                          |
| 1800, 1900, 2000 | 70.2      | 0         | 0             | 0.4      | 0             | 29.4     | 1.52                      | 53.3                          |
| 2450             | 68.6      | 0         | 0             | 0        | 0             | 31.4     | 1.95                      | 52.7                          |

Table 6.1 Recipes of Tissue Simulating Liquid

### Simulating Liquid for 5G, Manufactured by SPEAG

| Ingredients        | (% by weight) |
|--------------------|---------------|
| Water              | 64~78%        |
| Mineral oil        | 11~18%        |
| Emulsifiers        | 9~15%         |
| Additives and Salt | 2~3%          |



The dielectric parameters of the liquids were verified prior to the SAR evaluation using an Agilent 85070D Dielectric Probe Kit and an Agilent Network Analyzer.

The following table shows the measuring results for simulating liquid.

| Frequency (MHz) | Liquid Type | Liquid Temp. (°C) | Conductivity ( $\sigma$ ) | Permittivity ( $\epsilon_r$ ) | Conductivity Target ( $\sigma$ ) | Permittivity Target ( $\epsilon_r$ ) | Delta ( $\sigma$ ) (%) | Delta ( $\epsilon_r$ ) (%) | Limit (%) | Date     |
|-----------------|-------------|-------------------|---------------------------|-------------------------------|----------------------------------|--------------------------------------|------------------------|----------------------------|-----------|----------|
| 2450            | Body        | 21.4              | 1.969                     | 52.278                        | 1.95                             | 52.7                                 | 0.97                   | -0.80                      | ±5        | 2013/3/6 |
| 5200            | Body        | 21.2              | 5.131                     | 47.488                        | 5.3                              | 49                                   | -3.19                  | -3.09                      | ±5        | 2013/3/6 |
| 5300            | Body        | 21.2              | 5.624                     | 47.249                        | 5.39                             | 48.9                                 | 4.34                   | -3.38                      | ±5        | 2013/3/6 |
| 5300            | Body        | 21.6              | 5.405                     | 47.298                        | 5.39                             | 48.9                                 | 0.28                   | -3.28                      | ±5        | 2013/3/8 |
| 5600            | Body        | 21.2              | 5.642                     | 46.786                        | 5.65                             | 48.6                                 | -0.14                  | -3.73                      | ±5        | 2013/3/6 |
| 5600            | Body        | 21.6              | 5.8                       | 46.785                        | 5.65                             | 48.6                                 | 2.65                   | -3.73                      | ±5        | 2013/3/8 |
| 5800            | Body        | 21.6              | 6.153                     | 46.472                        | 6                                | 48.2                                 | 2.55                   | -3.59                      | ±5        | 2013/3/8 |

Table 6.2 Measuring Results for Simulating Liquid

## 7. SAR System Verification

Each DASY system is equipped with one or more system validation kits. These units, together with the predefined measurement procedures within the DASY software, enable the user to conduct the system performance check and system validation. System validation kit includes a dipole, tripod holder to fix it underneath the flat phantom and a corresponding distance holder.

### 7.1 Purpose of System Performance check

The system performance check verifies that the system operates within its specifications. System and operator errors can be detected and corrected. It is recommended that the system performance check be performed prior to any usage of the system in order to guarantee reproducible results. The system performance check uses normal SAR measurements in a simplified setup with a well characterized source. This setup was selected to give a high sensitivity to all parameters that might fail or vary over time. The system check does not intend to replace the calibration of the components, but indicates situations where the system uncertainty is exceeded due to drift or failure.

### 7.2 System Setup

In the simplified setup for system evaluation, the EUT is replaced by a calibrated dipole and the power source is replaced by a continuous wave that comes from a signal generator. The calibrated dipole must be placed beneath the flat phantom section of the SAM twin phantom with the correct distance holder. The distance holder should touch the phantom surface with a light pressure at the reference marking and be oriented parallel to the long side of the phantom. The equipment setup is shown below:

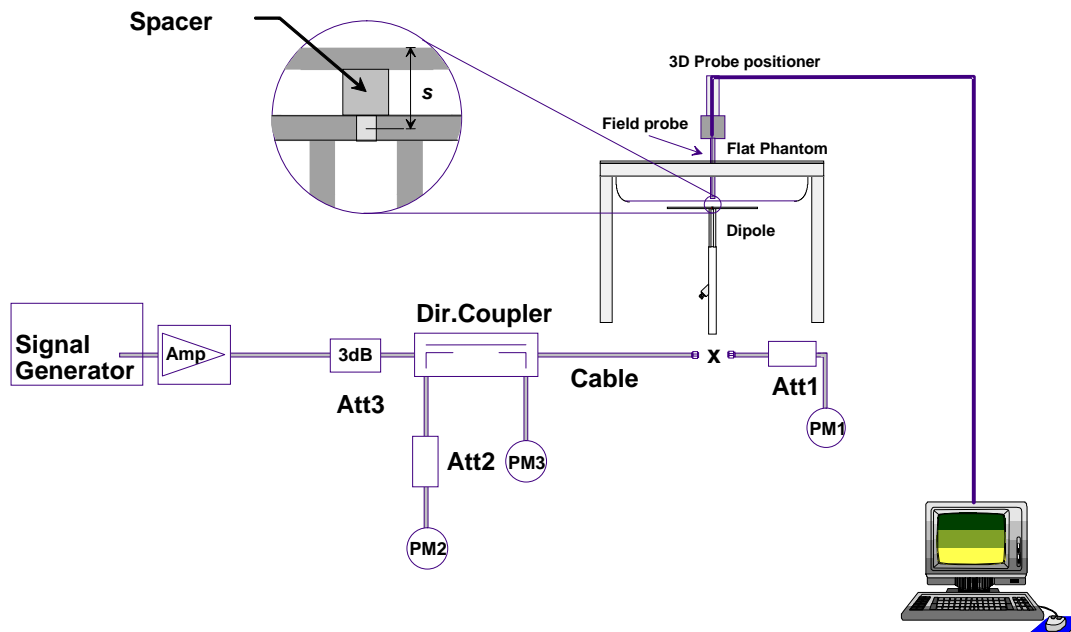

Fig 7.1 System Setup for System Evaluation

1. Signal Generator
2. Amplifier
3. Directional Coupler
4. Power Meter
5. Calibrated Dipole



**Fig 7.2 Photo of Dipole Setup**

**7.3 SAR System Verification Results**

Comparing to the original SAR value provided by SPEAG, the verification data should be within its specification of 10 %. Table 7.1 shows the target SAR and measured SAR after normalized to 1W input power. The table below indicates the system performance check can meet the variation criterion and the plots can be referred to Appendix A of this report.

| Date     | Frequency (MHz) | Liquid Type | Power fed onto reference dipole (mW) | Targeted SAR (W/kg) | Measured SAR (W/kg) | Normalized SAR (W/kg) | Deviation (%) |
|----------|-----------------|-------------|--------------------------------------|---------------------|---------------------|-----------------------|---------------|
| 2013/3/6 | 2450            | Body        | 250                                  | 52.3                | 13.6                | 54.4                  | 4.02          |
| 2013/3/6 | 5200            | Body        | 100                                  | 71.4                | 7.53                | 75.3                  | 5.46          |
| 2013/3/6 | 5300            | Body        | 100                                  | 73.5                | 7.3                 | 73                    | -0.68         |
| 2013/3/8 | 5300            | Body        | 100                                  | 73.5                | 7.72                | 77.2                  | 5.03          |
| 2013/3/6 | 5300            | Body        | 100                                  | 76.8                | 7.99                | 79.9                  | 4.04          |
| 2013/3/8 | 5600            | Body        | 100                                  | 76.8                | 7.92                | 79.2                  | 3.13          |
| 2013/3/8 | 5800            | Body        | 100                                  | 71.7                | 7.67                | 76.7                  | 6.97          |

**Table 7.1 Target and Measurement SAR after Normalized**



## 8. EUT Testing Position

This EUT was tested in two different positions. They are bottom-face of tablet PC, Edge1. In these positions, the surface of EUT is touching with phantom 0 cm. Please refer to Appendix D for the test setup photos.

## 9. Measurement Procedures

The measurement procedures are as follows:

### <Conducted power measurement>

- (a) For WWAN power measurement, use base station simulator to configure EUT WWAN transmission in conducted connection with RF cable, at maximum power in each supported wireless interface and frequency band.
- (b) Read the WWAN RF power level from the base station simulator.
- (c) For WLAN/BT power measurement, use engineering software to configure EUT WLAN/BT continuously transmission, at maximum RF power in each supported wireless interface and frequency band
- (d) Connect EUT RF port through RF cable to the power meter, and measure WLAN/BT output power

### <SAR measurement>

- (a) Use base station simulator to configure EUT WWAN transmission in radiated connection, and engineering software to configure EUT WLAN/BT continuously transmission, at maximum RF power, in the highest power channel.
- (b) Place the EUT in the positions as Appendix D demonstrates.
- (c) Set scan area, grid size and other setting on the DASY software.
- (d) Measure SAR results for the highest power channel on each testing position.
- (e) Find out the largest SAR result on these testing positions of each band
- (f) Measure SAR results for other channels in worst SAR testing position if the reported SAR of highest power channel is larger than 0.8 W/kg

According to the test standard, the recommended procedure for assessing the peak spatial-average SAR value consists of the following steps:

- (a) Power reference measurement
- (b) Area scan
- (c) Zoom scan
- (d) Power drift measurement



### **9.1 Spatial Peak SAR Evaluation**

The procedure for spatial peak SAR evaluation has been implemented according to the test standard. It can be conducted for 1g and 10g, as well as for user-specific masses. The DASY software includes all numerical procedures necessary to evaluate the spatial peak SAR value.

The base for the evaluation is a "cube" measurement. The measured volume must include the 1g and 10g cubes with the highest averaged SAR values. For that purpose, the center of the measured volume is aligned to the interpolated peak SAR value of a previously performed area scan.

The entire evaluation of the spatial peak values is performed within the post-processing engine (SEMCAD). The system always gives the maximum values for the 1g and 10g cubes. The algorithm to find the cube with highest averaged SAR is divided into the following stages:

- (a) Extraction of the measured data (grid and values) from the Zoom Scan
- (b) Calculation of the SAR value at every measurement point based on all stored data (A/D values and measurement parameters)
- (c) Generation of a high-resolution mesh within the measured volume
- (d) Interpolation of all measured values from the measurement grid to the high-resolution grid
- (e) Extrapolation of the entire 3-D field distribution to the phantom surface over the distance from sensor to surface
- (f) Calculation of the averaged SAR within masses of 1g and 10g

### **9.2 Power Reference Measurement**

The Power Reference Measurement and Power Drift Measurements are for monitoring the power drift of the device under test in the batch process. The minimum distance of probe sensors to surface determines the closest measurement point to phantom surface. This distance cannot be smaller than the distance of sensor calibration points to probe tip as defined in the probe properties.

### 9.3 Area & Zoom Scan Procedures

First Area Scan is used to locate the approximate location(s) of the local peak SAR value(s). The measurement grid within an Area Scan is defined by the grid extent, grid step size and grid offset. Next, in order to determine the EM field distribution in a three-dimensional spatial extension, Zoom Scan is required. The Zoom Scan is performed around the highest E-field value to determine the averaged SAR-distribution over 10 g. Area scan and zoom scan resolution setting follows KDB 865664 D01v01 quoted below.

For any secondary peaks found in the area scan which are within 2 dB of the maximum peak and are not within this zoom scan, the zoom scan should be repeated

|  |   | $\leq 3$ GHz   | $> 3$ GHz   |
|--|---|--|---|
| Maximum distance from closest measurement point (geometric center of probe sensors) to phantom surface   |   | $5 \pm 1$ mm   | $\frac{1}{2} \cdot \delta \cdot \ln(2) \pm 0.5$ mm                            |
| Maximum probe angle from probe axis to phantom surface normal at the measurement location  |   | $30^\circ \pm 1^\circ$   | $20^\circ \pm 1^\circ$  |
| Maximum area scan spatial resolution: $\Delta x_{Area}, \Delta y_{Area}$   |   | $\leq 2$ GHz: $\leq 15$ mm<br>2 – 3 GHz: $\leq 12$ mm  | 3 – 4 GHz: $\leq 12$ mm<br>4 – 6 GHz: $\leq 10$ mm                            |
|  |   | When the x or y dimension of the test device, in the measurement plane orientation, is smaller than the above, the measurement resolution must be $\leq$ the corresponding x or y dimension of the test device with at least one measurement point on the test device. |   |
| Maximum zoom scan spatial resolution: $\Delta x_{Zoom}, \Delta y_{Zoom}$   |   | $\leq 2$ GHz: $\leq 8$ mm<br>2 – 3 GHz: $\leq 5$ mm*   | 3 – 4 GHz: $\leq 5$ mm*<br>4 – 6 GHz: $\leq 4$ mm*                            |
| Maximum zoom scan spatial resolution, normal to phantom surface  | uniform grid: $\Delta z_{Zoom}(n)$  | $\leq 5$ mm  | 3 – 4 GHz: $\leq 4$ mm<br>4 – 5 GHz: $\leq 3$ mm<br>5 – 6 GHz: $\leq 2$ mm    |
|  | graded grid<br>$\Delta z_{Zoom}(1)$ : between 1 <sup>st</sup> two points closest to phantom surface | $\leq 4$ mm  | 3 – 4 GHz: $\leq 3$ mm<br>4 – 5 GHz: $\leq 2.5$ mm<br>5 – 6 GHz: $\leq 2$ mm  |
|  | $\Delta z_{Zoom}(n>1)$ : between subsequent points  | $\leq 1.5 \cdot \Delta z_{Zoom}(n-1)$  |   |
| Minimum zoom scan volume   | x, y, z   | $\geq 30$ mm   | 3 – 4 GHz: $\geq 28$ mm<br>4 – 5 GHz: $\geq 25$ mm<br>5 – 6 GHz: $\geq 22$ mm |
| <p>Note: <math>\delta</math> is the penetration depth of a plane-wave at normal incidence to the tissue medium; see draft standard IEEE P1528-2011 for details.</p> <p>* When zoom scan is required and the <i>reported</i> SAR from the area scan based <i>1-g SAR estimation</i> procedures of KDB 447498 is <math>\leq 1.4</math> W/kg, <math>\leq 8</math> mm, <math>\leq 7</math> mm and <math>\leq 5</math> mm zoom scan resolution may be applied, respectively, for 2 GHz to 3 GHz, 3 GHz to 4 GHz and 4 GHz to 6 GHz.</p> |   |  |   |





### **9.4 Volume Scan Procedures**

The volume scan is used for assess overlapping SAR distributions for antennas transmitting in different frequency bands. It is equivalent to an oversized zoom scan used in standalone measurements. The measurement volume will be used to enclose all the simultaneous transmitting antennas. For antennas transmitting simultaneously in different frequency bands, the volume scan is measured separately in each frequency band. In order to sum correctly to compute the 1g aggregate SAR, the EUT remain in the same test position for all measurements and all volume scan use the same spatial resolution and grid spacing. When all volume scan were completed, the software, SEMCAD postprocessor can combine and subsequently superpose these measurement data to calculating the multiband SAR.

### **9.5 SAR Averaged Methods**

In DASy, the interpolation and extrapolation are both based on the modified Quadratic Shepard's method. The interpolation scheme combines a least-square fitted function method and a weighted average method which are the two basic types of computational interpolation and approximation.

Extrapolation routines are used to obtain SAR values between the lowest measurement points and the inner phantom surface. The extrapolation distance is determined by the surface detection distance and the probe sensor offset. The uncertainty increases with the extrapolation distance. To keep the uncertainty within 1% for the 1 g and 10 g cubes, the extrapolation distance should not be larger than 5 mm.

### **9.6 Power Drift Monitoring**

All SAR testing is under the EUT install full charged battery and transmit maximum output power. In DASy measurement software, the power reference measurement and power drift measurement procedures are used for monitoring the power drift of EUT during SAR test. Both these procedures measure the field at a specified reference position before and after the SAR testing. The software will calculate the field difference in dB. If the power drifts more than 5%, the SAR will be retested.



**10. Conducted RF Output Power (Unit: dBm)**

**<WLAN 2.4GHz SISO mode Conducted Power>**

**<Antenna 0>**

| WLAN 2.4GHz 802.11b Average Power (dBm) |           |                 |                     |                 |       |       |
|---|-----------|-----------------|---------------------|-----------------|-------|-------|
| Power vs. Channel                       |           |                 | Power vs. Data Rate |                 |       |       |
| Channel                                 | Frequency | Data Rate (bps) | Channel             | Data Rate (bps) |       |       |
|   | (MHz)     | 1M              |                     | 2M              | 5.5M  | 11M   |
| CH 1                                    | 2412      | 15.19           | CH 6                | 15.26           | 15.22 | 15.26 |
| CH 6                                    | 2437      | <b>15.28</b>    |                     |                 |       |       |
| CH 11                                   | 2462      | 15.17           |                     |                 |       |       |

| WLAN 2.4GHz 802.11g Average Power (dBm) |           |                 |                     |                 |       |       |       |       |       |       |
|---|-----------|-----------------|---------------------|-----------------|-------|-------|-------|-------|-------|-------|
| Power vs. Channel                       |           |                 | Power vs. Data Rate |                 |       |       |       |       |       |       |
| Channel                                 | Frequency | Data Rate (bps) | Channel             | Data Rate (bps) |       |       |       |       |       |       |
|   | (MHz)     | 6M              |                     | 9M              | 12M   | 18M   | 24M   | 36M   | 48M   | 54M   |
| CH 1                                    | 2412      | 12.36           | CH 6                | 14.98           | 14.98 | 14.97 | 14.98 | 14.92 | 14.94 | 14.95 |
| CH 6                                    | 2437      | <b>14.99</b>    |                     |                 |       |       |       |       |       |       |
| CH 11                                   | 2462      | 11.18           |                     |                 |       |       |       |       |       |       |

| WLAN 2.4GHz 802.11n-HT20 Average Power (dBm) |           |              |                     |           |       |       |       |       |       |       |
|--|-----------|--------------|---------------------|-----------|-------|-------|-------|-------|-------|-------|
| Power vs. Channel                            |           |              | Power vs. Data Rate |           |       |       |       |       |       |       |
| Channel                                      | Frequency | MCS Index    | Channel             | MCS Index |       |       |       |       |       |       |
|  | (MHz)     | MCS0         |                     | MCS1      | MCS2  | MCS3  | MCS4  | MCS5  | MCS6  | MCS7  |
| CH 1   | 2412      | 11.68        | CH 6                | 15.07     | 14.99 | 15.01 | 15.06 | 15.05 | 14.96 | 14.91 |
| CH 6   | 2437      | <b>15.08</b> |                     |           |       |       |       |       |       |       |
| CH 11  | 2462      | 10.73        |                     |           |       |       |       |       |       |       |

| WLAN 2.4GHz 802.11n-HT40 Average Power (dBm) |           |              |                     |           |       |       |       |       |       |       |
|--|-----------|--------------|---------------------|-----------|-------|-------|-------|-------|-------|-------|
| Power vs. Channel                            |           |              | Power vs. Data Rate |           |       |       |       |       |       |       |
| Channel                                      | Frequency | MCS Index    | Channel             | MCS Index |       |       |       |       |       |       |
|  | (MHz)     | MCS0         |                     | MCS1      | MCS2  | MCS3  | MCS4  | MCS5  | MCS6  | MCS7  |
| CH 3   | 2422      | 9.28         | CH 6                | 11.44     | 11.49 | 11.49 | 11.48 | 11.49 | 11.42 | 11.44 |
| CH 6   | 2437      | <b>11.54</b> |                     |           |       |       |       |       |       |       |
| CH 9   | 2452      | 8.90         |                     |           |       |       |       |       |       |       |

**Note:**

1. Per KDB 248227 D01 v01r02, choose the highest output power channel to test SAR and determine further SAR exclusion
2. For each frequency band, testing at higher data rates and higher order modulations is not required when the maximum average output power for each of these configurations is less than 1/4dB higher than those measured at the lowest data rate
3. Per KDB 248227 D01 v01r02, 11g, 11n-HT20 and 11n-HT40 output power is less than 1/4dB higher than 802.11b mode, thus the SAR can be excluded.



<WLAN 2.4GHz MIMO mode Conducted Power>

<Antenna 0+1>

| WLAN 2.4GHz 802.11b Average Power (dBm) |           |                 |                     |                 |       |       |
|---|-----------|-----------------|---------------------|-----------------|-------|-------|
| Power vs. Channel                       |           |                 | Power vs. Data Rate |                 |       |       |
| Channel                                 | Frequency | Data Rate (bps) | Channel             | Data Rate (bps) |       |       |
|   | (MHz)     | 1M              |                     | 2M              | 5.5M  | 11M   |
| CH 1                                    | 2412      | <b>18.26</b>    | CH 1                | 18.22           | 18.21 | 18.25 |
| CH 6                                    | 2437      | 17.73           |                     |                 |       |       |
| CH 11                                   | 2462      | 17.95           |                     |                 |       |       |

| WLAN 2.4GHz 802.11g Average Power (dBm) |           |                 |                     |                 |       |       |       |       |       |       |
|---|-----------|-----------------|---------------------|-----------------|-------|-------|-------|-------|-------|-------|
| Power vs. Channel                       |           |                 | Power vs. Data Rate |                 |       |       |       |       |       |       |
| Channel                                 | Frequency | Data Rate (bps) | Channel             | Data Rate (bps) |       |       |       |       |       |       |
|   | (MHz)     | 6M              |                     | 9M              | 12M   | 18M   | 24M   | 36M   | 48M   | 54M   |
| CH 1                                    | 2412      | 14.75           | CH 6                | 16.73           | 16.68 | 16.64 | 16.65 | 16.61 | 16.57 | 16.54 |
| CH 6                                    | 2437      | <b>16.75</b>    |                     |                 |       |       |       |       |       |       |
| CH 11                                   | 2462      | 13.00           |                     |                 |       |       |       |       |       |       |

| WLAN 2.4GHz 802.11n-HT20 Average Power (dBm) |           |              |                     |           |       |       |       |       |       |       |
|--|-----------|--------------|---------------------|-----------|-------|-------|-------|-------|-------|-------|
| Power vs. Channel                            |           |              | Power vs. Data Rate |           |       |       |       |       |       |       |
| Channel                                      | Frequency | MCS Index    | Channel             | MCS Index |       |       |       |       |       |       |
|  | (MHz)     | MCS8         |                     | MCS9      | MCS10 | MCS11 | MCS12 | MCS13 | MCS14 | MCS15 |
| CH 1   | 2412      | 13.95        | CH 6                | 17.37     | 17.34 | 17.31 | 17.26 | 17.24 | 17.20 | 17.17 |
| CH 6   | 2437      | <b>17.41</b> |                     |           |       |       |       |       |       |       |
| CH 11  | 2462      | 12.46        |                     |           |       |       |       |       |       |       |

| WLAN 2.4GHz 802.11n-HT40 Average Power (dBm) |           |              |                     |           |       |       |       |       |       |       |
|--|-----------|--------------|---------------------|-----------|-------|-------|-------|-------|-------|-------|
| Power vs. Channel                            |           |              | Power vs. Data Rate |           |       |       |       |       |       |       |
| Channel                                      | Frequency | MCS Index    | Channel             | MCS Index |       |       |       |       |       |       |
|  | (MHz)     | MCS8         |                     | MCS9      | MCS10 | MCS11 | MCS12 | MCS13 | MCS14 | MCS15 |
| CH 3   | 2422      | 10.88        | CH 6                | 13.02     | 12.97 | 12.92 | 12.95 | 12.88 | 12.85 | 12.88 |
| CH 6   | 2437      | <b>13.08</b> |                     |           |       |       |       |       |       |       |
| CH 9   | 2452      | 10.65        |                     |           |       |       |       |       |       |       |

Note:

1. Per KDB 248227 D01 v01r02, choose the highest output power channel to test SAR and determine further SAR exclusion
2. For each frequency band, testing at higher data rates and higher order modulations is not required when the maximum average output power for each of these configurations is less than 1/4dB higher than those measured at the lowest data rate
3. Per KDB 248227 D01 v01r02, 11g, 11n-HT20 and 11n-HT40 output power is less than 1/4dB higher than 802.11b mode, thus the SAR can be excluded.

<Bluetooth Conducted Power>

| Channel | Frequency (MHz) | Average power (dBm) |        |
|---------|-----------------|---------------------|--------|
|         |                 | Mode                |        |
|         |                 | GFSK                | 8-DPSK |
| CH 0    | 2402            | 5.98                | 6.25   |
| CH 39   | 2441            | 5.69                | 5.95   |
| CH 78   | 2480            | 5.32                | 5.64   |



<WLAN 5GHz SISO mode Conducted Power>

<Antenna 0>

| WLAN 5GHz 802.11a Average Power (dBm) |                 |                 |                     |                 |       |       |       |       |       |       |
|---------------------------------------|-----------------|-----------------|---------------------|-----------------|-------|-------|-------|-------|-------|-------|
| Power vs. Channel                     |                 |                 | Power vs. Data Rate |                 |       |       |       |       |       |       |
| Channel                               | Frequency (MHz) | Data Rate (bps) | Channel             | Data Rate (bps) |       |       |       |       |       |       |
|                                       |                 | 6M              |                     | 9M              | 12M   | 18M   | 24M   | 36M   | 48M   | 54M   |
| CH 36                                 | 5180            | <b>11.27</b>    | CH 36               | 11.24           | 11.21 | 11.18 | 11.15 | 11.17 | 11.20 | 11.15 |
| CH 40                                 | 5200            | 10.99           |                     |                 |       |       |       |       |       |       |
| CH 44                                 | 5220            | 10.95           |                     |                 |       |       |       |       |       |       |
| CH 48                                 | 5240            | 10.28           |                     |                 |       |       |       |       |       |       |
| CH 52                                 | 5260            | 10.08           | CH 60               | 10.45           | 10.43 | 10.44 | 10.40 | 10.35 | 10.32 | 10.34 |
| CH 56                                 | 5280            | 10.00           |                     |                 |       |       |       |       |       |       |
| CH 60                                 | 5300            | <b>10.50</b>    |                     |                 |       |       |       |       |       |       |
| CH 64                                 | 5320            | 9.63            |                     |                 |       |       |       |       |       |       |
| CH 100                                | 5500            | <b>10.48</b>    |                     |                 |       |       |       |       |       |       |
| CH 104                                | 5520            | 10.07           | CH 100              | 10.45           | 10.41 | 10.42 | 10.37 | 10.34 | 10.32 | 10.31 |
| CH 108                                | 5540            | 10.40           |                     |                 |       |       |       |       |       |       |
| CH 112                                | 5560            | 10.11           |                     |                 |       |       |       |       |       |       |
| CH 116                                | 5580            | 10.37           |                     |                 |       |       |       |       |       |       |
| CH 132                                | 5660            | 10.15           |                     |                 |       |       |       |       |       |       |
| CH 136                                | 5680            | 10.17           |                     |                 |       |       |       |       |       |       |
| CH 140                                | 5700            | 10.45           |                     |                 |       |       |       |       |       |       |
| CH 149                                | 5745            | 10.43           | CH 157              | 10.84           | 10.81 | 10.77 | 10.74 | 10.76 | 10.71 | 10.69 |
| CH 153                                | 5765            | 10.84           |                     |                 |       |       |       |       |       |       |
| CH 157                                | 5785            | <b>10.86</b>    |                     |                 |       |       |       |       |       |       |
| CH 161                                | 5805            | 10.25           |                     |                 |       |       |       |       |       |       |
| CH 165                                | 5825            | 10.44           |                     |                 |       |       |       |       |       |       |

| WLAN 5GHz 802.11n-HT20 Average Power (dBm) |                 |              |                     |           |       |       |       |       |       |       |
|--|-----------------|--------------|---------------------|-----------|-------|-------|-------|-------|-------|-------|
| Power vs. Channel                          |                 |              | Power vs. Data Rate |           |       |       |       |       |       |       |
| Channel                                    | Frequency (MHz) | MCS Index    | Channel             | MCS Index |       |       |       |       |       |       |
|  |                 | MCS0         |                     | MCS1      | MCS2  | MCS3  | MCS4  | MCS5  | MCS6  | MCS7  |
| CH 36                                      | 5180            | 9.39         | CH 48               | 9.85      | 9.81  | 9.83  | 9.83  | 9.78  | 9.75  | 9.71  |
| CH 40                                      | 5200            | 9.13         |                     |           |       |       |       |       |       |       |
| CH 44                                      | 5220            | 9.18         |                     |           |       |       |       |       |       |       |
| CH 48                                      | 5240            | <b>9.9</b>   |                     |           |       |       |       |       |       |       |
| CH 52                                      | 5260            | 9.22         | CH 64               | 9.24      | 9.28  | 9.25  | 9.21  | 9.18  | 9.15  | 9.18  |
| CH 56                                      | 5280            | 9.18         |                     |           |       |       |       |       |       |       |
| CH 60                                      | 5300            | 9.26         |                     |           |       |       |       |       |       |       |
| CH 64                                      | 5320            | <b>9.32</b>  |                     |           |       |       |       |       |       |       |
| CH 100                                     | 5500            | 9.38         |                     |           |       |       |       |       |       |       |
| CH 104                                     | 5520            | 9.2          | CH 140              | 10.21     | 10.17 | 10.14 | 10.18 | 10.12 | 10.10 | 10.08 |
| CH 108                                     | 5540            | 9.37         |                     |           |       |       |       |       |       |       |
| CH 112                                     | 5560            | 9.18         |                     |           |       |       |       |       |       |       |
| CH 116                                     | 5580            | 9.25         |                     |           |       |       |       |       |       |       |
| CH 132                                     | 5660            | 9.48         |                     |           |       |       |       |       |       |       |
| CH 136                                     | 5680            | 9.5          |                     |           |       |       |       |       |       |       |
| CH 140                                     | 5700            | <b>10.26</b> |                     |           |       |       |       |       |       |       |
| CH 149                                     | 5745            | 10.38        | CH 157              | 10.76     | 10.71 | 10.67 | 10.64 | 10.61 | 10.57 | 10.60 |
| CH 153                                     | 5765            | 10.37        |                     |           |       |       |       |       |       |       |
| CH 157                                     | 5785            | <b>10.8</b>  |                     |           |       |       |       |       |       |       |
| CH 161                                     | 5805            | 10.64        |                     |           |       |       |       |       |       |       |
| CH 165                                     | 5825            | 10.74        |                     |           |       |       |       |       |       |       |



| WLAN 5GHz 802.11n-HT40 Average Power (dBm) |                 |              |                     |           |       |       |       |       |       |       |
|--|-----------------|--------------|---------------------|-----------|-------|-------|-------|-------|-------|-------|
| Power vs. Channel                          |                 |              | Power vs. Data Rate |           |       |       |       |       |       |       |
| Channel                                    | Frequency (MHz) | MCS Index    | Channel             | MCS Index |       |       |       |       |       |       |
|  |                 | MCS0         |                     | MCS1      | MCS2  | MCS3  | MCS4  | MCS5  | MCS6  | MCS7  |
| CH 38                                      | 5190            | 8.72         | CH 46               | 9.93      | 9.89  | 9.84  | 9.86  | 9.82  | 9.83  | 9.86  |
| CH 46                                      | 5230            | <b>9.96</b>  |                     |           |       |       |       |       |       |       |
| CH 54                                      | 5270            | <b>9.26</b>  | CH 54               | 9.21      | 9.24  | 9.18  | 9.15  | 9.13  | 9.11  | 9.11  |
| CH 62                                      | 5310            | 9.14         |                     |           |       |       |       |       |       |       |
| CH 102                                     | 5510            | 6.89         | CH 134              | 10.25     | 10.21 | 10.18 | 10.14 | 10.11 | 10.16 | 10.13 |
| CH 110                                     | 5550            | 9.37         |                     |           |       |       |       |       |       |       |
| CH 134                                     | 5670            | <b>10.28</b> |                     |           |       |       |       |       |       |       |
| CH 151                                     | 5755            | <b>10.39</b> | CH 151              | 10.36     | 10.31 | 10.35 | 10.31 | 10.27 | 10.24 | 10.20 |
| CH 159                                     | 5795            | 10.17        |                     |           |       |       |       |       |       |       |

**Note:**

1. Per KDB 248227 D01 v01r02, choose the highest output power channel to test SAR and determine further SAR exclusion
2. For each frequency band, testing at higher data rates and higher order modulations is not required when the maximum average output power for each of these configurations is less than 1/4dB higher than those measured at the lowest data rate.
3. Per KDB 248227 D01 v01r02, 11n-HT20 and 11n-HT40 output power is less than 1/4dB higher than 802.11a mode, thus the SAR can be excluded.



<WLAN 5GHz MIMO Mode Conducted Power>

<Antenna 0+1>

| WLAN 5GHz 802.11a Average Power (dBm) |                 |              |                     |           |       |       |       |       |       |       |     |
|---------------------------------------|-----------------|--------------|---------------------|-----------|-------|-------|-------|-------|-------|-------|-----|
| Power vs. Channel                     |                 |              | Power vs. Data Rate |           |       |       |       |       |       |       |     |
| Channel                               | Frequency (MHz) | MCS Index    | Channel             | MCS Index |       |       |       |       |       | 48M   | 54M |
|                                       |                 | 6M           |                     | 9M        | 12M   | 18M   | 24M   | 36M   |       |       |     |
| CH 36                                 | 5180            | <b>14.10</b> | CH 36               | 14.06     | 14.01 | 14.03 | 13.97 | 13.93 | 13.94 | 13.91 |     |
| CH 40                                 | 5200            | 12.05        |                     |           |       |       |       |       |       |       |     |
| CH 44                                 | 5220            | 12.74        |                     |           |       |       |       |       |       |       |     |
| CH 48                                 | 5240            | 12.87        |                     |           |       |       |       |       |       |       |     |
| CH 52                                 | 5260            | 12.41        | CH 60               | 12.41     | 12.44 | 12.40 | 12.37 | 12.32 | 12.30 | 12.26 |     |
| CH 56                                 | 5280            | 11.63        |                     |           |       |       |       |       |       |       |     |
| CH 60                                 | 5300            | <b>12.46</b> |                     |           |       |       |       |       |       |       |     |
| CH 64                                 | 5320            | 12.42        |                     |           |       |       |       |       |       |       |     |
| CH 100                                | 5500            | <b>12.96</b> |                     |           |       |       |       |       |       |       |     |
| CH 104                                | 5520            | 12.34        | CH 100              | 12.92     | 12.88 | 12.81 | 12.83 | 12.78 | 12.75 | 12.76 |     |
| CH 108                                | 5540            | 12.63        |                     |           |       |       |       |       |       |       |     |
| CH 112                                | 5560            | 12.46        |                     |           |       |       |       |       |       |       |     |
| CH 116                                | 5580            | 12.89        |                     |           |       |       |       |       |       |       |     |
| CH 132                                | 5660            | 12.60        |                     |           |       |       |       |       |       |       |     |
| CH 136                                | 5680            | 12.40        |                     |           |       |       |       |       |       |       |     |
| CH 140                                | 5700            | 13.36        |                     |           |       |       |       |       |       |       |     |
| CH 149                                | 5745            | 11.92        |                     |           |       |       |       |       |       |       |     |
| CH 153                                | 5765            | 12.28        | CH 157              | 12.42     | 12.44 | 12.38 | 12.35 | 12.32 | 12.35 | 12.30 |     |
| CH 157                                | 5785            | <b>12.47</b> |                     |           |       |       |       |       |       |       |     |
| CH 161                                | 5805            | 12.34        |                     |           |       |       |       |       |       |       |     |
| CH 165                                | 5825            | 11.89        |                     |           |       |       |       |       |       |       |     |

| WLAN 5GHz 802.11n-HT20 Average Power (dBm) |                 |              |                     |           |       |       |       |       |       |       |       |
|--|-----------------|--------------|---------------------|-----------|-------|-------|-------|-------|-------|-------|-------|
| Power vs. Channel                          |                 |              | Power vs. Data Rate |           |       |       |       |       |       |       |       |
| Channel                                    | Frequency (MHz) | MCS Index    | Channel             | MCS Index |       |       |       |       |       | MCS14 | MCS15 |
|  |                 | MCS8         |                     | MCS9      | MCS10 | MCS11 | MCS12 | MCS13 |       |       |       |
| CH 36                                      | 5180            | <b>13.06</b> | CH 36               | 13.01     | 13.03 | 12.97 | 12.93 | 12.94 | 12.91 | 12.88 |       |
| CH 40                                      | 5200            | 11.68        |                     |           |       |       |       |       |       |       |       |
| CH 44                                      | 5220            | 12.48        |                     |           |       |       |       |       |       |       |       |
| CH 48                                      | 5240            | 12.57        |                     |           |       |       |       |       |       |       |       |
| CH 52                                      | 5260            | 11.93        | CH 60               | 12.10     | 12.06 | 12.03 | 12.04 | 12.00 | 11.97 | 11.94 |       |
| CH 56                                      | 5280            | 11.41        |                     |           |       |       |       |       |       |       |       |
| CH 60                                      | 5300            | <b>12.13</b> |                     |           |       |       |       |       |       |       |       |
| CH 64                                      | 5320            | 11.95        |                     |           |       |       |       |       |       |       |       |
| CH 100                                     | 5500            | 11.56        |                     |           |       |       |       |       |       |       |       |
| CH 104                                     | 5520            | 10.93        | CH 140              | 12.71     | 12.70 | 12.65 | 12.61 | 12.56 | 12.59 | 12.58 |       |
| CH 108                                     | 5540            | 11.32        |                     |           |       |       |       |       |       |       |       |
| CH 112                                     | 5560            | 11.07        |                     |           |       |       |       |       |       |       |       |
| CH 116                                     | 5580            | 11.43        |                     |           |       |       |       |       |       |       |       |
| CH 132                                     | 5660            | 11.99        |                     |           |       |       |       |       |       |       |       |
| CH 136                                     | 5680            | 12.31        |                     |           |       |       |       |       |       |       |       |
| CH 140                                     | 5700            | <b>12.75</b> |                     |           |       |       |       |       |       |       |       |
| CH 149                                     | 5745            | 11.9         |                     |           |       |       |       |       |       |       |       |
| CH 153                                     | 5765            | 12.28        | CH 157              | 12.56     | 12.52 | 12.48 | 12.43 | 12.48 | 12.41 | 12.40 |       |
| CH 157                                     | 5785            | <b>12.6</b>  |                     |           |       |       |       |       |       |       |       |
| CH 161                                     | 5805            | 12.44        |                     |           |       |       |       |       |       |       |       |
| CH 165                                     | 5825            | 12.47        |                     |           |       |       |       |       |       |       |       |



| WLAN 5GHz 802.11n-HT40 Average Power (dBm) |                 |                |                     |           |       |       |       |       |       |       |
|--|-----------------|----------------|---------------------|-----------|-------|-------|-------|-------|-------|-------|
| Power vs. Channel                          |                 |                | Power vs. Data Rate |           |       |       |       |       |       |       |
| Channel                                    | Frequency (MHz) | MCS Index MCS8 | Channel             | MCS Index |       |       |       |       |       |       |
|  |                 |                |                     | MCS9      | MCS10 | MCS11 | MCS12 | MCS13 | MCS14 | MCS15 |
| CH 38                                      | 5190            | 11.62          | CH 46               | 11.86     | 11.82 | 11.80 | 11.75 | 11.73 | 11.76 | 11.77 |
| CH 46                                      | 5230            | <b>11.91</b>   |                     |           |       |       |       |       |       |       |
| CH 54                                      | 5270            | 11.93          | CH 62               | 12.07     | 12.04 | 12.00 | 12.03 | 11.97 | 11.93 | 11.95 |
| CH 62                                      | 5310            | <b>12.11</b>   |                     |           |       |       |       |       |       |       |
| CH 102                                     | 5510            | 9.48           | CH 134              | 13.10     | 13.07 | 13.04 | 13.06 | 13.01 | 13.00 | 12.98 |
| CH 110                                     | 5550            | 11.95          |                     |           |       |       |       |       |       |       |
| CH 134                                     | 5670            | <b>13.13</b>   |                     |           |       |       |       |       |       |       |
| CH 151                                     | 5755            | 12.46          | CH 159              | 13.21     | 13.17 | 13.14 | 13.16 | 13.12 | 13.07 | 13.04 |
| CH 159                                     | 5795            | <b>13.24</b>   |                     |           |       |       |       |       |       |       |

**Note:**

1. Per KDB 248227 D01 v01r02, choose the highest output power channel to test SAR and determine further SAR exclusion
2. For each frequency band, testing at higher data rates and higher order modulations is not required when the maximum average output power for each of these configurations is less than 1/4dB higher than those measured at the lowest data rate.
3. Per KDB 248227 D01 v01r02, 11n-HT20 and 11n-HT40 output power is less than 1/4dB higher than 802.11a mode, thus the SAR can be excluded.
4. Per KDB 248227 D01 v01r02, 11n-HT40 (Freq: 5745MHz ~ 5825MHz) average output power is higher than 1/4dB higher than 802.11a mode, these modes SAR will be verified at the highest RF exposure position found in 802.11a SAR testing.

### 11. Exposure Positions Consideration

**Edge 1**

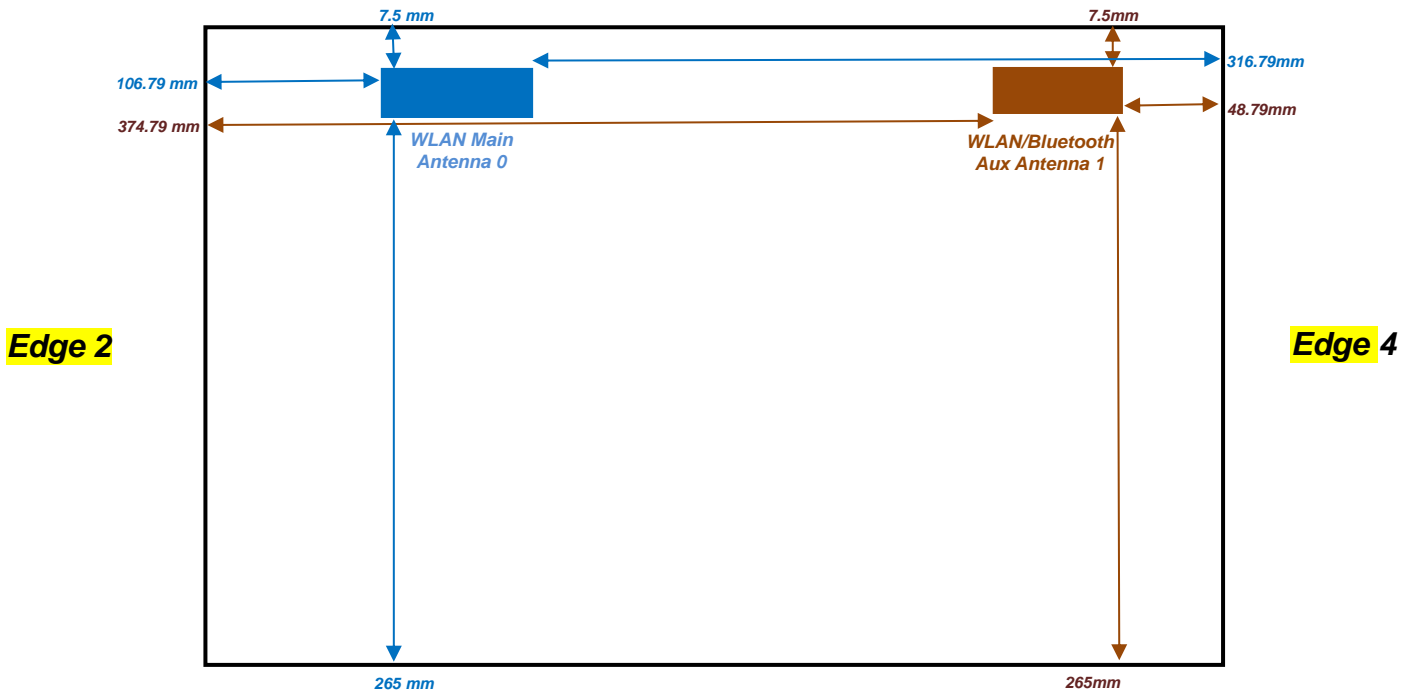

**Edge 3**

**Back View**

| Antennas                        | Wireless Interface                   |
|---------------------------------|--------------------------------------|
| WLAN Main Antenna 0 (Tx / Rx)   | WLAN 2.4GHz<br>WLAN5GHz              |
| BT&WLAN Aux Antenna 1 (Tx / Rx) | WLAN 2.4GHz<br>WLAN5GHz<br>Bluetooth |

<Standalone transmission configuration>

| Wireless Interface      | Antennas                 |                          |
|-------------------------|--------------------------|--------------------------|
|                         | WLAN Antenna 0 (Tx / Rx) | WLAN Antenna 1 (Tx / Rx) |
| 2.4GHz Bluetooth        |                          | yes                      |
| WLAN 2.4GHz 802.11b     | yes                      | yes                      |
| WLAN 2.4GHz 802.11g     | yes                      | yes                      |
| WLAN 2.4GHz 802.11 HT20 | yes                      | yes                      |
| WLAN 2.4GHz 802.11 HT40 | yes                      | yes                      |
| WLAN 5GHz 802.11a       | yes                      | yes                      |
| WLAN 5GHz 802.11 HT20   | yes                      | yes                      |
| WLAN 5GHz 802.11 HT40   | yes                      | yes                      |





<SISO Mode Simultaneous transmission configuration>

| combination no. | Wireless Interface                         | Antennas            |                     |
|-----------------|--|---------------------|---------------------|
|                 |  | Antenna 0 (Tx / Rx) | Antenna 1 (Tx / Rx) |
| 1               | 2.4GHz Bluetooth                           |                     | yes                 |
|                 | WLAN 2.4GHz 802.11b/g/HT20/HT40            | yes                 |                     |
| 2               | 2.4GHz Bluetooth                           |                     | yes                 |
|                 | WLAN 5.2/5.3/5.5/5.8 GHz 802.11a/HT20/HT40 | yes                 |                     |

<MIMO Mode Simultaneous transmission configuration>

| combination no. | Wireless Interface                           | Antennas            |                     |
|-----------------|--|---------------------|---------------------|
|                 |  | Antenna 0 (Tx / Rx) | Antenna 1 (Tx / Rx) |
| 1               | 2.4GHz Bluetooth                             |                     | yes                 |
|                 | WLAN 5.2/5.3/5.5/5.8 GHz 802.11 a/ HT20/HT40 | yes                 | yes                 |



WLAN SAR test exclusion table distance is < 50mm

| Exposure Position | Wireless Interface          | 802.11b Ant 0 | 802.11b Ant 0+1 | 802.11a Ant 0 | 802.11a Ant 0+1 | Bluetooth Ant 1 |
|-------------------|-----------------------------|---------------|-----------------|---------------|-----------------|-----------------|
|                   | Tune-up Maximum power (dBm) | 15.5          | 18.5            | 11.5          | 14.5            | 6.5             |
| Bottom Face       | Antenna to user (mm)        | 5             | 5               | 5             | 5               | 5               |
|                   | SAR exclusion threshold     | 11.18         | 22.3            | 6.82          | 13.6            | 1.41            |
|                   | SAR testing required?       | YES           | YES             | YES           | YES             | NO              |
| Edge 1            | Antenna to user (mm)        | 7.5           | 7.5             | 7.5           | 7.5             | 7.5             |
|                   | SAR exclusion threshold     | 7.42          | 22.78           | 4.55          | 9.07            | 0.94            |
|                   | SAR testing required?       | YES           | YES             | YES           | YES             | NO              |
| Edge 4            | Antenna to user (mm)        |               | 48.79           |               | 48.79           | 48.79           |
|                   | SAR exclusion threshold     |               | 2.28            |               | 1.39            | 0.14            |
|                   | SAR testing required?       |               | NO              |               | NO              | NO              |

WLAN SAR test exclusion table distance is > 50mm

| Exposure Position | Wireless Interface               | 802.11b Ant 0 | 802.11b Ant 0+1 | 802.11a Ant 0 | 802.11a Ant 0+1 | Bluetooth Ant 1 |
|-------------------|----------------------------------|---------------|-----------------|---------------|-----------------|-----------------|
|                   | Tune-up Maximum power (dBm)      | 15.5          | 18.5            | 11.5          | 14.5            | 6.5             |
|                   | Tune-up Maximum rated power (mW) | 35.48         | 70.79           | 14.13         | 28.18           | 4.47            |
| Edge 2            | Antenna to user (mm)             | 106.79        | 106.79          | 106.79        | 106.79          | 106.79          |
|                   | SAR exclusion threshold (mW)     | 663           | 663             | 630           | 630             | 203             |
|                   | SAR testing required?            | NO            | NO              | NO            | NO              | NO              |
| Edge 3            | Antenna to user (mm)             | 265           | 265             | 265           | 265             | 265             |
|                   | SAR exclusion threshold (mW)     | 2246          | 2246            | 2212          | 2212            | 505             |
|                   | SAR testing required?            | NO            | NO              | NO            | NO              | NO              |
| Edge 4            | Antenna to user (mm)             | 316.79        |                 | 316.79        |                 |                 |
|                   | SAR exclusion threshold (mW)     | 2763          |                 | 2730          |                 |                 |
|                   | SAR testing required?            | NO            |                 | NO            |                 |                 |

Note:

- Maximum power is the source-based time-average power and represents the maximum RF output power among production units
- Per KDB 447498 D01v05, for larger devices, the *test separation distance* is determined by the closest separation between the antenna and the user.
- Per KDB 447498 D01v05, standalone SAR test exclusion threshold is applied; If the distance of the antenna to the user is < 5mm, 5mm is used to determine SAR exclusion threshold
- Per KDB 447498 D01v05, the 1-g and 10-g SAR test exclusion thresholds for 100 MHz to 6 GHz at *test separation distances* ≤ 50 mm are determined by:
 
$$[(\text{max. power of channel, including tune-up tolerance, mW}) / (\text{min. test separation distance, mm})] \cdot [\sqrt{f(\text{GHz})}] \leq 3.0$$
 for 1-g SAR and ≤ 7.5 for 10-g extremity SAR
  - f(GHz) is the RF channel transmit frequency in GHz
  - Power and distance are rounded to the nearest mW and mm before calculation
  - The result is rounded to one decimal place for comparison
  - if SAR exclusion threshold > 3, RF Exposure evaluation is necessary
- Per KDB 447498 D01v05, at 100 MHz to 6 GHz and for *test separation distances* > 50 mm, the SAR test exclusion threshold is determined according to the following
  - [Threshold at 50 mm in step 1) + (test separation distance - 50 mm) · (f(MHz)/150)] mW, at 100 MHz to 1500 MHz
  - [Threshold at 50 mm in step 1) + (test separation distance - 50 mm) · 10] mW at > 1500 MHz and ≤ 6 GHz



### 12. SAR Test Results

**Note:**

1. Per KDB 447498 D01v05, the reported SAR is the measured SAR value adjusted for maximum tune-up tolerance.  
 $Scaling\ Factor = \frac{tune-up\ limit\ power\ (mW)}{EUT\ RF\ power\ (mW)}$ , where tune-up limit is the maximum rated power among all production units.  
 $Reported\ SAR(W/kg) = Measured\ SAR(W/kg) * Scaling\ Factor$
2. Per KDB 447498 D01v05, for each exposure position, if the highest output channel reported SAR ≤0.8W/kg, other channels SAR testing is not necessary.
3. This product have two model of antenna, due to the antenna type are the same that chosen highest antenna gain under tested.
4. Pre KDB 178919 D01, for Part 15 device, identical antenna type with the same or lower gain, with no other change to the transmitter and host device configurations, and the highest SAR measured for that antenna type in previous certification is less than 0.8 W/kg, SAR evaluation is not required to add an equivalent antenna.
5. Per KDB 447498 D01v05, for each exposure position, testing of other required channels within the operating mode of a frequency band is not required when the reported 1-g or 10-g SAR for the mid-band or highest output power channel is:
  - ≤ 0.8 W/kg or 2.0 W/kg, for 1-g or 10-g respectively, when the transmission band is ≤ 100 MHz
  - ≤ 0.6 W/kg or 1.5 W/kg, for 1-g or 10-g respectively, when the transmission band is between 100 MHz and 200 MHz
  - ≤ 0.4 W/kg or 1.0 W/kg, for 1-g or 10-g respectively, when the transmission band is ≥ 200 MHz

#### 12.1 Test Records for Body SAR Test

**<WLAN2.4GHz SAR>**

| Plot No. | Band       | Mode    | Test Position | Gap (cm) | Ant.    | Ch. | Freq. (MHz) | Data Rate (bps) | Average Power (dBm) | Tune-Up Limit (dBm) | Tune-up Scaling Factor | Power Drift (dB) | Measured SAR 1g (W/kg) | Reported SAR 1g (W/kg) |
|----------|------------|---------|---------------|----------|---------|-----|-------------|-----------------|---------------------|---------------------|------------------------|------------------|------------------------|------------------------|
| 1        | WLAN2.4GHz | 802.11b | Bottom Face   | 0cm      | Ant 0   | 6   | 2437        | 1M              | 15.28               | 15.5                | 1.052                  | 0.07             | 0.307                  | 0.323                  |
| 2        | WLAN2.4GHz | 802.11b | Edge 1        | 0cm      | Ant 0   | 6   | 2437        | 1M              | 15.28               | 15.5                | 1.052                  | -0.06            | 0.42                   | 0.442                  |
| 5        | WLAN2.4GHz | 802.11b | Bottom Face   | 0cm      | Ant 0+1 | 1   | 2412        | 1M              | 18.26               | 18.5                | 1.058                  | -0.01            | 0.393                  | 0.416                  |
| 6        | WLAN2.4GHz | 802.11b | Edge 1        | 0cm      | Ant 0+1 | 1   | 2412        | 1M              | 18.26               | 18.5                | 1.058                  | -0.03            | 0.446                  | 0.472                  |



<WLAN5GHz SAR>

| Plot No. | Band     | Mode         | Test Position | Gap (cm) | Ant.    | Ch. | Freq. (MHz) | Data Rate (bps) | Average Power (dBm) | Tune-Up Limit (dBm) | Tune-up Scaling Factor | Power Drift (dB) | Measured SAR 1g (W/kg) | Reported SAR 1g (W/kg) |
|----------|----------|--------------|---------------|----------|---------|-----|-------------|-----------------|---------------------|---------------------|------------------------|------------------|------------------------|------------------------|
| 10       | WLAN5GHz | 802.11a      | Bottom Face   | 0cm      | Ant 0   | 36  | 5180        | 6M              | 11.27               | 11.5                | 1.054                  | -0.1             | 0.199                  | 0.210                  |
| 11       | WLAN5GHz | 802.11a      | Edge 1        | 0cm      | Ant 0   | 36  | 5180        | 6M              | 11.27               | 11.5                | 1.054                  | 0.13             | 0.719                  | 0.758                  |
| 13       | WLAN5GHz | 802.11a      | Bottom Face   | 0cm      | Ant 0   | 60  | 5300        | 6M              | 10.5                | 10.5                | 1.000                  | -0.12            | 0.163                  | 0.163                  |
| 14       | WLAN5GHz | 802.11a      | Edge 1        | 0cm      | Ant 0   | 60  | 5300        | 6M              | 10.5                | 10.5                | 1.000                  | 0.18             | 0.339                  | 0.339                  |
| 16       | WLAN5GHz | 802.11a      | Bottom Face   | 0cm      | Ant 0   | 100 | 5500        | 6M              | 10.48               | 10.5                | 1.005                  | 0.19             | 0.176                  | 0.177                  |
| 17       | WLAN5GHz | 802.11a      | Edge 1        | 0cm      | Ant 0   | 100 | 5500        | 6M              | 10.48               | 10.5                | 1.005                  | 0.02             | 0.435                  | 0.437                  |
| 18       | WLAN5GHz | 802.11a      | Edge 1        | 0cm      | Ant 0   | 116 | 5580        | 6M              | 10.37               | 10.5                | 1.030                  | -0.18            | 0.272                  | 0.280                  |
| 19       | WLAN5GHz | 802.11a      | Edge 1        | 0cm      | Ant 0   | 140 | 5700        | 6M              | 10.45               | 10.5                | 1.012                  | -0.16            | 0.395                  | 0.400                  |
| 20       | WLAN5GHz | 802.11a      | Bottom Face   | 0cm      | Ant 0   | 157 | 5785        | 6M              | 10.86               | 11                  | 1.033                  | -0.14            | 0.185                  | 0.191                  |
| 21       | WLAN5GHz | 802.11a      | Edge 1        | 0cm      | Ant 0   | 157 | 5785        | 6M              | 10.86               | 11                  | 1.033                  | -0.14            | 0.332                  | 0.343                  |
| 24       | WLAN5GHz | 802.11a      | Bottom Face   | 0cm      | Ant 0+1 | 36  | 5180        | 6M              | 14.1                | 14.5                | 1.096                  | -0.14            | 0.255                  | 0.280                  |
| 25       | WLAN5GHz | 802.11a      | Edge 1        | 0cm      | Ant 0+1 | 36  | 5180        | 6M              | 14.1                | 14.5                | 1.096                  | 0.06             | 0.645                  | 0.707                  |
| 28       | WLAN5GHz | 802.11a      | Bottom Face   | 0cm      | Ant 0+1 | 60  | 5300        | 6M              | 12.46               | 13.5                | 1.271                  | -0.13            | 0.146                  | 0.186                  |
| 29       | WLAN5GHz | 802.11a      | Edge 1        | 0cm      | Ant 0+1 | 60  | 5300        | 6M              | 12.46               | 13.5                | 1.271                  | -0.15            | 0.311                  | 0.395                  |
| 31       | WLAN5GHz | 802.11a      | Bottom Face   | 0cm      | Ant 0+1 | 140 | 5700        | 6M              | 13.36               | 13.5                | 1.033                  | -0.05            | 0.217                  | 0.224                  |
| 32       | WLAN5GHz | 802.11a      | Edge 1        | 0cm      | Ant 0+1 | 140 | 5700        | 6M              | 13.36               | 13.5                | 1.033                  | -0.02            | 0.452                  | 0.467                  |
| 33       | WLAN5GHz | 802.11a      | Edge 1        | 0cm      | Ant 0+1 | 100 | 5500        | 6M              | 12.96               | 13.5                | 1.132                  | -0.15            | 0.464                  | 0.525                  |
| 34       | WLAN5GHz | 802.11a      | Edge 1        | 0cm      | Ant 0+1 | 116 | 5580        | 6M              | 12.89               | 13.5                | 1.151                  | -0.17            | 0.433                  | 0.498                  |
| 35       | WLAN5GHz | 802.11a      | Bottom Face   | 0cm      | Ant 0+1 | 157 | 5785        | 6M              | 12.47               | 14                  | 1.422                  | -0.16            | 0.165                  | 0.235                  |
| 36       | WLAN5GHz | 802.11a      | Edge 1        | 0cm      | Ant 0+1 | 157 | 5785        | 6M              | 12.47               | 14                  | 1.422                  | -0.06            | 0.253                  | 0.360                  |
| 37       | WLAN5GHz | 802.11n-HT40 | Edge 1        | 0cm      | Ant 0+1 | 159 | 5795        | MCS8            | 13.24               | 13.5                | 1.062                  | -0.11            | 0.262                  | 0.278                  |

**12.2 Highest SAR Plot**

Test Laboratory: Sporton International Inc. SAR/HAC Testing Lab

Date: 2013/3/6

**#06\_WLAN2.4G\_802.11b\_Edge 1\_0cm\_Ch1;Ant 0+1**

**DUT: 313102**

Communication System: 802.11b; Frequency: 2412 MHz; Duty Cycle: 1:1  
 Medium: MSL\_2450\_130306 Medium parameters used:  $f = 2412$  MHz;  $\sigma = 1.918$  mho/m;  $\epsilon_r = 52.404$ ;  $\rho = 1000$  kg/m<sup>3</sup>  
 Ambient Temperature : 22.4 °C ; Liquid Temperature : 21.4 °C

DASY5 Configuration:

- Probe: ES3DV3 - SN3270; ConvF(4.17, 4.17, 4.17); Calibrated: 2012/9/28;
- Sensor-Surface: 3mm (Mechanical Surface Detection)
- Electronics: DAE4 Sn778; Calibrated: 2012/8/27
- Phantom: ELI 4.0\_Front; Type: QDOVA001BB; Serial: 1026
- Measurement SW: DASY52, Version 52.8 (2); SEMCAD X Version 14.6.6 (6477)

**Configuration/Ch1/Area Scan (61x401x1):** Measurement grid: dx=12mm, dy=12mm  
 Maximum value of SAR (interpolated) = 0.598 mW/g

**Configuration/Ch1/Zoom Scan (7x7x7)/Cube 0:** Measurement grid: dx=5mm, dy=5mm, dz=5mm

Reference Value = 18.170 V/m; Power Drift = -0.03 dB

Peak SAR (extrapolated) = 0.991 mW/g

**SAR(1 g) = 0.446 mW/g; SAR(10 g) = 0.201 mW/g**

Maximum value of SAR (measured) = 0.599 mW/g

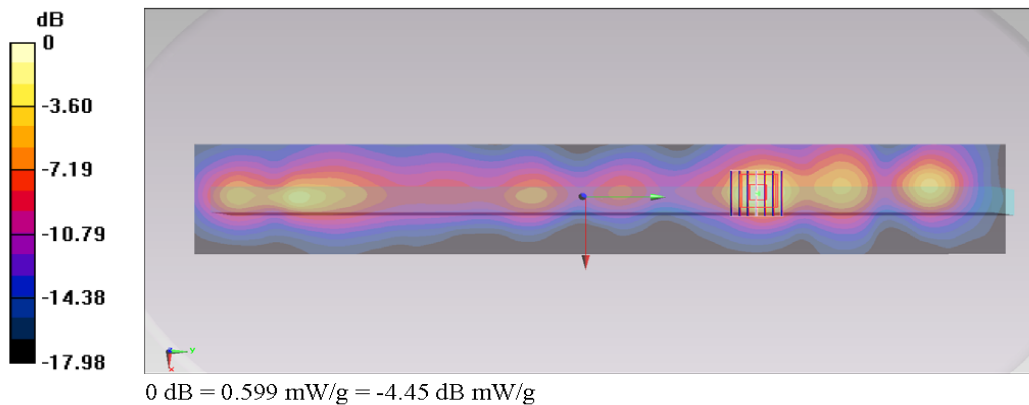

Test Laboratory: Sporton International Inc. SAR/HAC Testing Lab

Date: 2013/3/6

**#11\_WLAN5G\_802.11a\_Edge 1\_0cm\_Ch36;Ant 0**

**DUT: 313102**

Communication System: 802.11a; Frequency: 5180 MHz; Duty Cycle: 1:1  
 Medium: MSL\_5G\_130306 Medium parameters used:  $f = 5180$  MHz;  $\sigma = 5.097$  mho/m;  $\epsilon_r = 47.487$ ;  $\rho = 1000$  kg/m<sup>3</sup>  
 Ambient Temperature : 22.2°C; Liquid Temperature : 21.2°C

DASY5 Configuration:

- Probe: EX3DV4 - SN3792; ConvF(4.2, 4.2, 4.2); Calibrated: 2012/6/21;
- Sensor-Surface: 1.4mm (Mechanical Surface Detection)
- Electronics: DAE4 Sn1338; Calibrated: 2012/6/12
- Phantom: ELI 4.0\_Front; Type: QDOVA001BB; Serial: 1029
- Measurement SW: DASY52, Version 52.8 (3); SEMCAD X Version 14.6.5 (6469)

**Configuration/Ch36/Area Scan (71x241x1):** Measurement grid: dx=10mm, dy=10mm  
 Maximum value of SAR (interpolated) = 1.69 mW/g

**Configuration/Ch36/Zoom Scan (7x7x7)/Cube 0:** Measurement grid: dx=4mm, dy=4mm, dz=1.4mm

Reference Value = 2.929 V/m; Power Drift = 0.13 dB

Peak SAR (extrapolated) = 2.795 mW/g

**SAR(1 g) = 0.719 mW/g; SAR(10 g) = 0.217 mW/g**

Maximum value of SAR (measured) = 1.67 mW/g

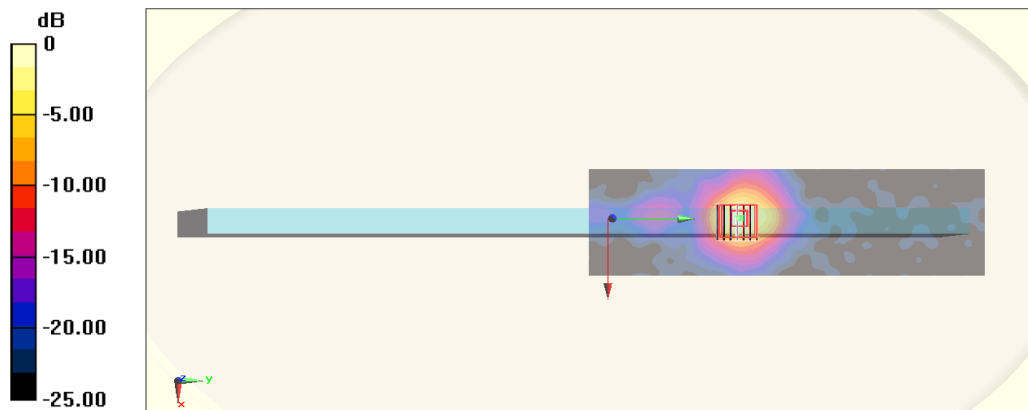

0 dB = 1.67 mW/g = 4.45 dB mW/g

**12.3 Simultaneous Multi-band Transmission Analysis**

| No. | Applicable Simultaneous Transmission Combination   |
|-----|--|
| 1.  | WLAN 2.4GHz 802.11b/g/HT20/HT40 (SISO) + Bluetooth |
| 2.  | WLAN 5GHz 802.11a/HT20/HT40 (SISO) + Bluetooth     |
| 3.  | WLAN 5GHz 802.11an HT20/HT40 (MIMO) + Bluetooth    |

**Note:**

- The Bluetooth Power is refer to FCC ID: PPD-QCA9005 and Report No. RF120720E01-2.
- WLAN2.4GHz 802.11n-HT20/HT40 cannot simultaneous transmission with Bluetooth.
- EUT will choose either WLAN 2.4GHz or WLAN 5GHz according to the network signal condition; therefore, they will not transmit simultaneously.
- The Scaled SAR summation is calculated based on the same configuration and test position.
- Per KDB 447498 D01v05, simultaneous transmission SAR is compliant if,
  - Scalar SAR summation < 1.6W/kg.
  - SPLSR = (SAR1 + SAR2)1.5 / (min. separation distance, mm), and the peak separation distance is determined from the square root of [(x1-x2)2 + (y1-y2)2 + (z1-z2)2], where (x1, y1, z1) and (x2, y2, z2) are the coordinates of the extrapolated peak SAR locations in the zoom scan  
If SPLSR ≤ 0.04, simultaneously transmission SAR measurement is not necessary
- For simultaneous transmission analysis, Bluetooth SAR is estimated per KDB 447498 D01v05 based on the formula below.
  - (max. power of channel, including tune-up tolerance, mW)/(min. test separation distance, mm)] $[\sqrt{f(\text{GHz})}/x]$  W/kg for test separation distances ≤ 50 mm; where x = 7.5 for 1-g SAR, and x = 18.75 for 10-g SAR.
  - 0.4 W/kg for 1-g SAR and 1.0 W/kg for 10-g SAR, when the test separation distances is > 50 mm.

| Max Power | Exposure Position        | Bottom Face | Edge 1     |
|-----------|--------------------------|-------------|------------|
|           | Test separation          | 0 mm        | 0 mm       |
| 6.5 dBm   | Antenna to user distance | 5 mm        | 7.5 mm     |
|           | Estimated SAR (W/kg)     | 0.188W/kg   | 0.125 W/kg |

| Position           | WLAN            |      |         |         |                     | Bluetooth |                      | WLAN + Bluetooth |
|--------------------|-----------------|------|---------|---------|---------------------|-----------|----------------------|------------------|
|                    | Band            | Mode | Antenna | Plot No | Reported SAR (W/kg) | Antenna   | Estimated SAR (W/kg) |                  |
| Bottom Face At 0cm | WLAN2.4GHz Band | SISO | Ant 0   | 1       | 0.323               | Ant 1     | 0.188                | <b>0.51</b>      |
|                    | WLAN5.2GHz Band | SISO | Ant 0   | 10      | 0.21                | Ant 1     | 0.188                | <b>0.40</b>      |
|                    | WLAN5.3GHz Band | SISO | Ant 0   | 13      | 0.163               | Ant 1     | 0.188                | <b>0.35</b>      |
|                    | WLAN5.5GHz Band | SISO | Ant 0   | 16      | 0.177               | Ant 1     | 0.188                | <b>0.37</b>      |
|                    | WLAN5.8GHz Band | SISO | Ant 0   | 20      | 0.191               | Ant 1     | 0.188                | <b>0.38</b>      |
|                    | WLAN5.2GHz Band | MIMO | Ant 0+1 | 24      | 0.280               | Ant 1     | 0.188                | <b>0.47</b>      |
|                    | WLAN5.8GHz Band | MIMO | Ant 0+1 | 35      | 0.235               | Ant 1     | 0.188                | <b>0.42</b>      |
| Edge1 At 0cm       | WLAN2.4GHz Band | SISO | Ant 0   | 2       | 0.442               | Ant 1     | 0.125                | <b>0.57</b>      |
|                    | WLAN5.2GHz Band | SISO | Ant 0   | 11      | 0.758               | Ant 1     | 0.125                | <b>0.88</b>      |
|                    | WLAN5.3GHz Band | SISO | Ant 0   | 14      | 0.339               | Ant 1     | 0.125                | <b>0.46</b>      |
|                    | WLAN5.5GHz Band | SISO | Ant 0   | 17      | 0.437               | Ant 1     | 0.125                | <b>0.56</b>      |
|                    | WLAN5.8GHz Band | SISO | Ant 0   | 21      | 0.343               | Ant 1     | 0.125                | <b>0.47</b>      |
|                    | WLAN5.2GHz Band | MIMO | Ant 0+1 | 25      | 0.707               | Ant 1     | 0.125                | <b>0.83</b>      |
|                    | WLAN5.8GHz Band | MIMO | Ant 0+1 | 36      | 0.360               | Ant 1     | 0.188                | <b>0.55</b>      |

Test Engineer : Michael Yang and Nick Yu

### 13. Uncertainty Assessment

The component of uncertainty may generally be categorized according to the methods used to evaluate them. The evaluation of uncertainty by the statistical analysis of a series of observations is termed a Type A evaluation of uncertainty. The evaluation of uncertainty by means other than the statistical analysis of a series of observation is termed a Type B evaluation of uncertainty. Each component of uncertainty, however evaluated, is represented by an estimated standard deviation, termed standard uncertainty, which is determined by the positive square root of the estimated variance.

A Type A evaluation of standard uncertainty may be based on any valid statistical method for treating data. This includes calculating the standard deviation of the mean of a series of independent observations; using the method of least squares to fit a curve to the data in order to estimate the parameter of the curve and their standard deviations; or carrying out an analysis of variance in order to identify and quantify random effects in certain kinds of measurement.

A type B evaluation of standard uncertainty is typically based on scientific judgment using all of the relevant information available. These may include previous measurement data, experience, and knowledge of the behavior and properties of relevant materials and instruments, manufacture’s specification, data provided in calibration reports and uncertainties assigned to reference data taken from handbooks. Broadly speaking, the uncertainty is either obtained from an outdoor source or obtained from an assumed distribution, such as the normal distribution, rectangular or triangular distributions indicated in Table 12.1

| Uncertainty Distributions          | Normal             | Rectangular | Triangular | U-Shape |
|------------------------------------|--------------------|-------------|------------|---------|
| Multi-plying Factor <sup>(a)</sup> | 1/k <sup>(b)</sup> | 1/√3        | 1/√6       | 1/√2    |

- (a) standard uncertainty is determined as the product of the multiplying factor and the estimated range of variations in the measured quantity
- (b)  $\kappa$  is the coverage factor

**Table 13.1 Standard Uncertainty for Assumed Distribution**

The combined standard uncertainty of the measurement result represents the estimated standard deviation of the result. It is obtained by combining the individual standard uncertainties of both Type A and Type B evaluation using the usual “root-sum-squares” (RSS) methods of combining standard deviations by taking the positive square root of the estimated variances.

Expanded uncertainty is a measure of uncertainty that defines an interval about the measurement result within which the measured value is confidently believed to lie. It is obtained by multiplying the combined standard uncertainty by a coverage factor. Typically, the coverage factor ranges from 2 to 3. Using a coverage factor allows the true value of a measured quantity to be specified with a defined probability within the specified uncertainty range. For purpose of this document, a coverage factor two is used, which corresponds to confidence interval of about 95 %. The DASY uncertainty Budget is shown in the following tables.





| Error Description                    | Uncertainty | Probability  | Divisor | Ci   | Ci    | Standard    | Standard    |
|--------------------------------------|-------------|--------------|---------|------|-------|-------------|-------------|
|                                      | Value       | Distribution |         | (1g) | (10g) | Uncertainty | Uncertainty |
|                                      | (±%)        |              |         |      |       | (1g)        | (10g)       |
| <b>Measurement System</b>            |             |              |         |      |       |             |             |
| Probe Calibration                    | 6.0         | Normal       | 1       | 1    | 1     | ± 6.0 %     | ± 6.0 %     |
| Axial Isotropy                       | 4.7         | Rectangular  | √3      | 0.7  | 0.7   | ± 1.9 %     | ± 1.9 %     |
| Hemispherical Isotropy               | 9.6         | Rectangular  | √3      | 0.7  | 0.7   | ± 3.9 %     | ± 3.9 %     |
| Boundary Effects                     | 1.0         | Rectangular  | √3      | 1    | 1     | ± 0.6 %     | ± 0.6 %     |
| Linearity                            | 4.7         | Rectangular  | √3      | 1    | 1     | ± 2.7 %     | ± 2.7 %     |
| System Detection Limits              | 1.0         | Rectangular  | √3      | 1    | 1     | ± 0.6 %     | ± 0.6 %     |
| Readout Electronics                  | 0.3         | Normal       | 1       | 1    | 1     | ± 0.3 %     | ± 0.3 %     |
| Response Time                        | 0.8         | Rectangular  | √3      | 1    | 1     | ± 0.5 %     | ± 0.5 %     |
| Integration Time                     | 2.6         | Rectangular  | √3      | 1    | 1     | ± 1.5 %     | ± 1.5 %     |
| RF Ambient Noise                     | 3.0         | Rectangular  | √3      | 1    | 1     | ± 1.7 %     | ± 1.7 %     |
| RF Ambient Reflections               | 3.0         | Rectangular  | √3      | 1    | 1     | ± 1.7 %     | ± 1.7 %     |
| Probe Positioner                     | 0.4         | Rectangular  | √3      | 1    | 1     | ± 0.2 %     | ± 0.2 %     |
| Probe Positioning                    | 2.9         | Rectangular  | √3      | 1    | 1     | ± 1.7 %     | ± 1.7 %     |
| Max. SAR Eval.                       | 1.0         | Rectangular  | √3      | 1    | 1     | ± 0.6 %     | ± 0.6 %     |
| <b>Test Sample Related</b>           |             |              |         |      |       |             |             |
| Device Positioning                   | 2.9         | Normal       | 1       | 1    | 1     | ± 2.9 %     | ± 2.9 %     |
| Device Holder                        | 3.6         | Normal       | 1       | 1    | 1     | ± 3.6 %     | ± 3.6 %     |
| Power Drift                          | 5.0         | Rectangular  | √3      | 1    | 1     | ± 2.9 %     | ± 2.9 %     |
| <b>Phantom and Setup</b>             |             |              |         |      |       |             |             |
| Phantom Uncertainty                  | 4.0         | Rectangular  | √3      | 1    | 1     | ± 2.3 %     | ± 2.3 %     |
| Liquid Conductivity (Target)         | 5.0         | Rectangular  | √3      | 0.64 | 0.43  | ± 1.8 %     | ± 1.2 %     |
| Liquid Conductivity (Meas.)          | 2.5         | Normal       | 1       | 0.64 | 0.43  | ± 1.6 %     | ± 1.1 %     |
| Liquid Permittivity (Target)         | 5.0         | Rectangular  | √3      | 0.6  | 0.49  | ± 1.7 %     | ± 1.4 %     |
| Liquid Permittivity (Meas.)          | 2.5         | Normal       | 1       | 0.6  | 0.49  | ± 1.5 %     | ± 1.2 %     |
| <b>Combined Standard Uncertainty</b> |             |              |         |      |       | ± 11.0 %    | ± 10.8 %    |
| <b>Coverage Factor for 95 %</b>      |             |              |         |      |       | K=2         |             |
| <b>Expanded Uncertainty</b>          |             |              |         |      |       | ± 22.0 %    | ± 21.5 %    |

Table 13.2 Uncertainty Budget for frequency range 300 MHz to 3 GHz



| Error Description                    | Uncertainty | Probability  | Divisor | Ci   | Ci    | Standard    | Standard    |
|--------------------------------------|-------------|--------------|---------|------|-------|-------------|-------------|
|                                      | Value       | Distribution |         | (1g) | (10g) | Uncertainty | Uncertainty |
|                                      | (±%)        |              |         |      |       | (1g)        | (10g)       |
| <b>Measurement System</b>            |             |              |         |      |       |             |             |
| Probe Calibration                    | 6.55        | Normal       | 1       | 1    | 1     | ± 6.55 %    | ± 6.55 %    |
| Axial Isotropy                       | 4.7         | Rectangular  | √3      | 0.7  | 0.7   | ± 1.9 %     | ± 1.9 %     |
| Hemispherical Isotropy               | 9.6         | Rectangular  | √3      | 0.7  | 0.7   | ± 3.9 %     | ± 3.9 %     |
| Boundary Effects                     | 2.0         | Rectangular  | √3      | 1    | 1     | ± 1.2 %     | ± 1.2 %     |
| Linearity                            | 4.7         | Rectangular  | √3      | 1    | 1     | ± 2.7 %     | ± 2.7 %     |
| System Detection Limits              | 1.0         | Rectangular  | √3      | 1    | 1     | ± 0.6 %     | ± 0.6 %     |
| Readout Electronics                  | 0.3         | Normal       | 1       | 1    | 1     | ± 0.3 %     | ± 0.3 %     |
| Response Time                        | 0.8         | Rectangular  | √3      | 1    | 1     | ± 0.5 %     | ± 0.5 %     |
| Integration Time                     | 2.6         | Rectangular  | √3      | 1    | 1     | ± 1.5 %     | ± 1.5 %     |
| RF Ambient Noise                     | 3.0         | Rectangular  | √3      | 1    | 1     | ± 1.7 %     | ± 1.7 %     |
| RF Ambient Reflections               | 3.0         | Rectangular  | √3      | 1    | 1     | ± 1.7 %     | ± 1.7 %     |
| Probe Positioner                     | 0.8         | Rectangular  | √3      | 1    | 1     | ± 0.5 %     | ± 0.5 %     |
| Probe Positioning                    | 9.9         | Rectangular  | √3      | 1    | 1     | ± 5.7 %     | ± 5.7 %     |
| Max. SAR Eval.                       | 4.0         | Rectangular  | √3      | 1    | 1     | ± 2.3 %     | ± 2.3 %     |
| <b>Test Sample Related</b>           |             |              |         |      |       |             |             |
| Device Positioning                   | 2.9         | Normal       | 1       | 1    | 1     | ± 2.9 %     | ± 2.9 %     |
| Device Holder                        | 3.6         | Normal       | 1       | 1    | 1     | ± 3.6 %     | ± 3.6 %     |
| Power Drift                          | 5.0         | Rectangular  | √3      | 1    | 1     | ± 2.9 %     | ± 2.9 %     |
| <b>Phantom and Setup</b>             |             |              |         |      |       |             |             |
| Phantom Uncertainty                  | 4.0         | Rectangular  | √3      | 1    | 1     | ± 2.3 %     | ± 2.3 %     |
| Liquid Conductivity (Target)         | 5.0         | Rectangular  | √3      | 0.64 | 0.43  | ± 1.8 %     | ± 1.2 %     |
| Liquid Conductivity (Meas.)          | 2.5         | Normal       | 1       | 0.64 | 0.43  | ± 1.6 %     | ± 1.1 %     |
| Liquid Permittivity (Target)         | 5.0         | Rectangular  | √3      | 0.6  | 0.49  | ± 1.7 %     | ± 1.4 %     |
| Liquid Permittivity (Meas.)          | 2.5         | Normal       | 1       | 0.6  | 0.49  | ± 1.5 %     | ± 1.2 %     |
| <b>Combined Standard Uncertainty</b> |             |              |         |      |       | ± 12.8 %    | ± 12.6 %    |
| <b>Coverage Factor for 95 %</b>      |             |              |         |      |       | K=2         |             |
| <b>Expanded Uncertainty</b>          |             |              |         |      |       | ± 25.6 %    | ± 25.2 %    |

Table 13.3 Uncertainty Budget for frequency range 3 GHz to 6 GHz



## **14. References**

- [1] FCC 47 CFR Part 2 “Frequency Allocations and Radio Treaty Matters; General Rules and Regulations”
- [2] ANSI/IEEE Std. C95.1-1992, “IEEE Standard for Safety Levels with Respect to Human Exposure to Radio Frequency Electromagnetic Fields, 3 kHz to 300 GHz”, September 1992
- [3] IEEE Std. 1528-2003, “Recommended Practice for Determining the Peak Spatial-Average Specific Absorption Rate (SAR) in the Human Head from Wireless Communications Devices: Measurement Techniques”, December 2003
- [4] FCC OET Bulletin 65 (Edition 97-01) Supplement C (Edition 01-01), “Evaluating Compliance with FCC Guidelines for Human Exposure to Radiofrequency Electromagnetic Fields”, June 2001
- [5] SPEAG DASY System Handbook
- [6] FCC KDB 248227 D01 v01r02, “SAR Measurement Procedures for 802.11 a/b/g Transmitters”, May 2007
- [7] FCC KDB 447498 D01 v05, “Mobile and Portable Device RF Exposure Procedures and Equipment Authorization Policies”, October 2012



## ***Appendix A. Plots of System Performance Check***

The plots are shown as follows.



## ***Appendix B. Plots of SAR Measurement***

The plots are shown as follows.



## **Appendix C. DASYS Calibration Certificate**

The DASYS calibration certificates are shown as follows.