



# FCC TEST REPORT

**REPORT NO.:** RF990709E01C

**MODEL NO.:** ARS63-S

**FCC ID:** PPD-ARS63S

**RECEIVED:** July 13, 2010

**TESTED:** July 22 to 27, 2010

**ISSUED:** Aug. 04, 2010

**APPLICANT:** Atheros Communications, Inc.

**ADDRESS:** 5480 Great America Parkway, Santa Clara,  
CA 95054

**ISSUED BY:** Bureau Veritas Consumer Products Services  
(H.K.) Ltd., Taoyuan Branch Hsin Chu Laboratory

**LAB ADDRESS:** No. 81-1, Lu Liao Keng, 9th Ling,Wu Lung Tsuen,  
Chiung Lin Hsiang, Hsin Chu Hsien 307, Taiwan

**TEST LOCATION (1):** No. 81-1, Lu Liao Keng, 9th Ling,Wu Lung Tsuen,  
Chiung Lin Hsiang, Hsin Chu Hsien 307, Taiwan

**TEST LOCATION (2):** No. 49, Ln. 206, Wende Rd., Shangshan Tsuen,  
Chiung Lin Hsiang, Hsin Chu Hsien 307, Taiwan

This test report consists of 89 pages in total. It may be duplicated completely for legal use with the approval of the applicant. It should not be reproduced except in full, without the written approval of our laboratory. The client should not use it to claim product certification, approval, or endorsement by any government agency. The test results in the report only apply to the tested sample.

## Table of Contents

1.	CERTIFICATION .....	5
2.	SUMMARY OF TEST RESULTS .....	6
2.1	MEASUREMENT UNCERTAINTY .....	7
3.	GENERAL INFORMATION .....	8
3.1	GENERAL DESCRIPTION OF EUT .....	8
3.2	DESCRIPTION OF ANTENNA .....	9
3.3	DESCRIPTION OF TEST MODES .....	10
3.3.1	TEST MODE APPLICABILITY AND TESTED CHANNEL DETAIL .....	11
3.4	GENERAL DESCRIPTION OF APPLIED STANDARDS .....	14
3.5	DESCRIPTION OF SUPPORT UNITS .....	15
3.6	CONFIGURATION OF SYSTEM UNDER TEST .....	15
4.	TEST TYPES AND RESULTS .....	16
4.1	CONDUCTED EMISSION MEASUREMENT .....	16
4.1.1	LIMITS OF CONDUCTED EMISSION MEASUREMENT .....	16
4.1.2	TEST INSTRUMENTS .....	16
4.1.3	TEST PROCEDURES .....	17
4.1.4	DEVIATION FROM TEST STANDARD .....	17
4.1.5	TEST SETUP .....	18
4.1.6	EUT OPERATING CONDITIONS .....	18
4.1.7	TEST RESULTS .....	19
4.2	RADIATED EMISSION MEASUREMENT .....	21
4.2.1	LIMITS OF RADIATED EMISSION MEASUREMENT .....	21
4.2.2	TEST INSTRUMENTS .....	22
4.2.3	TEST PROCEDURES .....	23
4.2.4	DEVIATION FROM TEST STANDARD .....	23
4.2.5	TEST SETUP .....	24
4.2.6	EUT OPERATING CONDITIONS .....	24
4.2.7	TEST RESULTS (For transmitter part) .....	25
4.2.8	TEST RESULTS (For receiver part) .....	47
4.3	6dB BANDWIDTH MEASUREMENT .....	51
4.3.1	LIMITS OF 6dB BANDWIDTH MEASUREMENT .....	51
4.3.2	TEST INSTRUMENTS .....	51
4.3.3	TEST PROCEDURE .....	52



A D T

4.3.4	DEVIATION FROM TEST STANDARD .....	52
4.3.5	TEST SETUP .....	52
4.3.6	EUT OPERATING CONDITIONS .....	52
4.3.7	TEST RESULTS .....	53
4.4	99% BANDWIDTH MEASUREMENT .....	59
4.4.1	TEST INSTRUMENTS .....	59
4.4.2	TEST PROCEDURE .....	59
4.4.3	TEST SETUP .....	59
4.4.4	EUT OPERATING CONDITIONS .....	59
4.4.5	TEST RESULTS .....	60
4.5	MAXIMUM PEAK OUTPUT POWER .....	66
4.5.1	LIMITS OF MAXIMUM PEAK OUTPUT POWER MEASUREMENT .....	66
4.5.2	INSTRUMENTS .....	66
4.5.3	TEST PROCEDURES .....	66
4.5.4	DEVIATION FROM TEST STANDARD .....	66
4.5.5	TEST SETUP .....	66
4.5.6	EUT OPERATING CONDITIONS .....	67
4.5.7	TEST RESULTS .....	68
4.6	AVERAGE OUTPUT POWER .....	69
4.6.1	FOR REFERENCE .....	69
4.6.2	TEST INSTRUMENTS .....	69
4.6.3	TEST PROCEDURES .....	70
4.6.4	TEST SETUP .....	70
4.6.5	EUT OPERATING CONDITIONS .....	70
4.6.6	TEST RESULTS .....	71
4.7	POWER SPECTRAL DENSITY MEASUREMENT .....	72
4.7.1	LIMITS OF POWER SPECTRAL DENSITY MEASUREMENT .....	72
4.7.2	TEST INSTRUMENTS .....	72
4.7.3	TEST PROCEDURE .....	73
4.7.4	DEVIATION FROM TEST STANDARD .....	73
4.7.5	TEST SETUP .....	73
4.7.6	EUT OPERATING CONDITION .....	73
4.7.7	TEST RESULTS .....	74
4.8	CONDUCTED OUT-BAND EMISSION MEASUREMENT .....	80
4.8.1	LIMITS OF CONDUCTED OUT-BAND EMISSION MEASUREMENT .....	80
4.8.2	TEST INSTRUMENTS .....	80
4.8.3	TEST PROCEDURE .....	80
4.8.4	TEST SETUP .....	81



A D T

4.8.5	DEVIATION FROM TEST STANDARD .....	81
4.8.6	EUT OPERATING CONDITION .....	81
4.8.7	TEST RESULTS.....	81
5.	INFORMATION ON THE TESTING LABORATORIES .....	88
6.	APPENDIX-A- MODIFICATIONS RECORDERS FOR ENGINEERING CHANGES TO THE EUT BY THE LAB .....	89



## 1. CERTIFICATION

**PRODUCT:** Low Power 1x1 802.11 b/g/n (SDIO) Card  
**BRAND NAME:** Atheros  
**MODEL NO.:** ARS63-S  
**TEST SAMPLE:** R&D SAMPLE  
**TESTED:** July 22 to 27, 2010  
**APPLICANT:** Atheros Communications, Inc.  
**STANDARDS:** FCC Part 15, Subpart C (Section 15.247)  
ANSI C63.4-2003  
Canada RSS-210 issue 7  
Canada RSS-Gen issue 2

The above equipment (Model: ARS63-S) has been tested by **Bureau Veritas Consumer Products Services (H.K.) Ltd., Taoyuan Branch**, and was in compliance with the requirement of the above standards. The test record, data evaluation & Equipment Under Test (EUT) configurations represented herein are true and accurate accounts of the measurements of the sample's EMC characteristics under the conditions specified in this report.

**PREPARED BY** : Midoli Peng , **DATE:** Aug. 04, 2010  
( Midoli Peng, Specialist )

**TECHNICAL ACCEPTANCE** : Hank Chung , **DATE:** Aug. 04, 2010  
( Hank Chung, Deputy Manager )

**APPROVED BY** : May Chen , **DATE:** Aug. 04, 2010  
( May Chen, Deputy Manager )



A D T

## 2. SUMMARY OF TEST RESULTS

The EUT has been tested according to the following specifications:

APPLIED STANDARD: 47 CFR Part 15, Subpart C ; RSS-210; RSS-Gen					
Standard Section			Test Type and Limit	Result	REMARK
RSS-210	RSS-Gen	47 CFR Part 15			
-	7.2.2	15.207	AC Power Conducted Emission	PASS	Meet the requirement of limit. Minimum passing margin is -15.41dB at 0.150MHz
A8.2(a)	4.6	15.247(a)(2)	Spectrum Bandwidth of a Direct Sequence Spread Spectrum System Limit: min. 500kHz	PASS	Meet the requirement of limit
A8.4(4)	4.8	15.247(b)	Maximum Peak Output Power Limit: max. 30dBm	PASS	Meet the requirement of limit
A8.5	4.9	15.247(c)	Transmitter Radiated Emissions FCC Limit: Table 15.209 RSS-210 Limit: Table 2	PASS	Meet the requirement of limit Minimum passing margin is -0.7dB at 2483.5MHz
-	6	-	Receiver Radiated Emissions RSS-210 Limit: Table 2	PASS	Meet the requirement of limit Minimum passing margin is -1.5dB at 166.55MHz
A8.2(b)	-	15.247(d)	Power Spectral Density Limit: max. 8dBm	PASS	Meet the requirement of limit
A8.5	-	15.247(c)	Conducted Out-Band Emission Measurement Limit: 20 dB less than the peak value of fundamental frequency	PASS	Meet the requirement of limit
	7.1.4	15.203	Antenna Requirement	PASS	Antenna connector is IPEX not a standard connector.



A D T

## 2.1 MEASUREMENT UNCERTAINTY

Where relevant, the following measurement uncertainty levels have been estimated for tests performed on the EUT as specified in CISPR 16-4-2:

This uncertainty represents an expanded uncertainty expressed at approximately the 95% confidence level using a coverage factor of  $k=2$ .

Measurement	Value
Conducted emissions	2.45 dB
Radiated emissions (30MHz-1GHz)	3.76 dB
Radiated emissions (1GHz -18GHz)	2.19 dB
Radiated emissions (18GHz -40GHz)	2.55 dB



A D T

### 3. GENERAL INFORMATION

#### 3.1 GENERAL DESCRIPTION OF EUT

<b>PRODUCT</b>	Low Power 1x1 802.11 b/g/n (SDIO) Card
<b>MODEL NO.</b>	ARS63-S
<b>FCC ID</b>	PPD-ARS63S
<b>IC ID</b>	4104A-ARS63S
<b>POWER SUPPLY</b>	DC 3.3V from host equipment
<b>MODULATION TYPE</b>	CCK, DQPSK, DBPSK for DSSS 64QAM, 16QAM, QPSK, BPSK for OFDM
<b>MODULATION TECHNOLOGY</b>	DSSS, OFDM
<b>TRANSFER RATE</b>	<b>802.11b:</b> 11 / 5.5 / 2 / 1Mbps <b>802.11g:</b> 54 / 48 / 36 / 24 / 18 / 12 / 9 / 6Mbps <b>802.11n (20MHz, 800ns GI):</b> 65 / 58.5 / 52 / 39 / 26 / 19.5 / 13 / 6.5Mbps <b>802.11n (20MHz, 400ns GI):</b> 72.2 / 65 / 57.8 / 43.3 / 28.9 / 21.7 / 14.4 / 7.2Mbps
<b>OPERATING FREQUENCY</b>	2412MHz ~ 2462MHz
<b>NUMBER OF CHANNEL</b>	11
<b>MAXIMUM OUTPUT POWER</b>	802.11b: 125.9mW 802.11g: 239.9mW 802.11n (20MHz): 234.4mW
<b>ANTENNA TYPE</b>	See item 3.2
<b>ANTENNA CONNECTOR</b>	See item 3.2
<b>DATA CABLE</b>	NA
<b>I/O PORTS</b>	NA
<b>ASSOCIATED DEVICES</b>	NA

#### NOTE:

1. The EUT incorporates CDD function with 802.11b, 802.11g and SISO function with 802.11n.





A D T

- The EUT is 1 \* 1 spatial SISO without beam forming function. The antenna configuration is one transmitter antenna and one receiver antenna, as there is 1 PIFA antenna.
- The EUT complies with 802.11n standards and backwards compatible with 802.11b, 802.11g products.
- The EUT was pre-tested under the following modes:

Test Mode	Data rate
Mode A	400ns GI
<b>Mode B</b>	<b>800ns GI</b>

From the above modes, the worst case was found in **Mode B**. Therefore only the test data of the mode was recorded in this report.

- The above EUT information was declared by manufacturer and for more detailed features description, please refer to the manufacturer's specifications or user's manual.

### 3.2 DESCRIPTION OF ANTENNA

There is one set of antenna provided to this EUT, please refer to the following table:

Brand	Model	Gain(dBi) (included cable loss)	Antenna Type	Connector	Cable Loss(dB)	Cable Length
WNC	81-EBJ15.005	3.62	PIFA	IPEX	1.15	300mm

### 3.3 DESCRIPTION OF TEST MODES

#### Operated in 2400 ~ 2483.5MHz band:

Eleven channels are provided for 802.11b, 802.11g, 802.11n (20MHz):

CHANNEL	FREQUENCY	CHANNEL	FREQUENCY
1	2412MHz	7	2442MHz
2	2417MHz	8	2447MHz
3	2422MHz	9	2452MHz
4	2427MHz	10	2457MHz
5	2432MHz	11	2462MHz
6	2437MHz		



### 3.3.1 TEST MODE APPLICABILITY AND TESTED CHANNEL DETAIL

EUT CONFIGURE MODE	APPLICABLE TO				DESCRIPTION
	PLC	RE < 1G	RE ≥ 1G	APCM	
-	√	√	√	√	-

Where **PLC**: Power Line Conducted Emission      **RE < 1G**: Radiated Emission below 1GHz  
**RE ≥ 1G**: Radiated Emission above 1GHz      **APCM**: Antenna Port Conducted Measurement

#### **POWER LINE CONDUCTED EMISSION TEST:**

- Pre-Scan has been conducted to determine the worst-case mode from all possible combinations between available modulations, data rates and antenna ports (if EUT with antenna diversity architecture).
- Following channel(s) was (were) selected for the final test as listed below.

MODE	AVAILABLE CHANNEL	TESTED CHANNEL	MODULATION TECHNOLOGY	MODULATION TYPE	DATA RATE (Mbps)
802.11b	1 to 11	1	DSSS	DBPSK	1

#### **RADIATED EMISSION TEST (BELOW 1 GHz):**

- Pre-Scan has been conducted to determine the worst-case mode from all possible combinations between available modulations, data rates and antenna ports (if EUT with antenna diversity architecture).
- The receiving mode had show equal or better than Tx mode during the pre-scan and hence the Tx mode data is re-used for Receiving-mode worst-case data.
- Following channel(s) was (were) selected for the final test as listed below.

MODE	AVAILABLE CHANNEL	TESTED CHANNEL	MODULATION TECHNOLOGY	MODULATION TYPE	DATA RATE (Mbps)
802.11g	1 to 11	6	OFDM	BPSK	6



A D T

#### **RADIATED EMISSION TEST (ABOVE 1 GHz):**

- Pre-Scan has been conducted to determine the worst-case mode from all possible combinations between available modulations, data rates and antenna ports (if EUT with antenna diversity architecture).
- Following channel(s) was (were) selected for the final test as listed below.

MODE	AVAILABLE CHANNEL	TESTED CHANNEL	MODULATION TECHNOLOGY	MODULATION TYPE	DATA RATE (Mbps)
802.11b	1 to 11	1, 6, 11	DSSS	DBPSK	1
802.11g	1 to 11	1, 6, 11	OFDM	BPSK	6
802.11n (20MHz)	1 to 11	1, 6, 11	OFDM	BPSK	6.5
Receiver	1 to 11	1, 6, 11	-	-	-

#### **CONDUCTED OUT-BAND EMISSION MEASUREMENT:**

- Pre-Scan has been conducted to determine the worst-case mode from all possible combinations between available modulations, data rates and antenna ports (if EUT with antenna diversity architecture).
- Following channel(s) was (were) selected for the final test as listed below.

MODE	AVAILABLE CHANNEL	TESTED CHANNEL	MODULATION TECHNOLOGY	MODULATION TYPE	DATA RATE (Mbps)
802.11b	1 to 11	1, 11	DSSS	DBPSK	1
802.11g	1 to 11	1, 11	OFDM	BPSK	6
802.11n (20MHz)	1 to 11	1, 11	OFDM	BPSK	6.5

#### **ANTENNA PORT CONDUCTED MEASUREMENT:**

- This item includes all test value of each mode, but only includes spectrum plot of worst value of each mode.
- Following channel(s) was (were) selected for the final test as listed below.

MODE	AVAILABLE CHANNEL	TESTED CHANNEL	MODULATION TECHNOLOGY	MODULATION TYPE	DATA RATE (Mbps)
802.11b	1 to 11	1, 6, 11	DSSS	DBPSK	1
802.11g	1 to 11	1, 6, 11	OFDM	BPSK	6
802.11n (20MHz)	1 to 11	1, 6, 11	OFDM	BPSK	6.5



A D T

**TEST CONDITION:**

APPLICABLE TO	ENVIRONMENTAL CONDITIONS	INPUT POWER (SYSTEM)	TESTED BY
RE $\geq$ 1G	20deg. C, 70%RH, 1013 hPa	120Vac, 60Hz	Rex Huang
RE<1G	24deg. C, 70%RH, 1013 hPa	120Vac, 60Hz	Eric Lee
PLC	26deg. C, 76%RH, 1013 hPa	120Vac, 60Hz	Frank Liu
APCM	25deg. C, 60%RH, 1013 hPa	120Vac, 60Hz	Eric Lee

### **3.4 GENERAL DESCRIPTION OF APPLIED STANDARDS**

The EUT is a RF Product. According to the specifications of the manufacturer, it must comply with the requirements of the following standards:

**FCC Part 15, Subpart C. (15.247)**

**ANSI C63.4-2003**

**Canada RSS-210 issue 7**

**Canada RSS-Gen issue 2**

All test items have been performed and recorded as per the above standards.

### 3.5 DESCRIPTION OF SUPPORT UNITS

The EUT has been tested as an independent unit together with other necessary accessories or support units. The following support units or accessories were used to form a representative test configuration during the tests.

NO.	PRODUCT	BRAND	MODEL NO.	SERIAL NO.	FCC ID
1	NOTEBOOK COMPUTER	DELL	PP32LA	GSLB32S	FCC DoC
2	EXTENSION CARD	Atheros	NA	NA	NA

NO.	SIGNAL CABLE DESCRIPTION OF THE ABOVE SUPPORT UNITS
1	NA
2	NA

**NOTE:** All power cords of the above support units are non shielded (1.8m).

### 3.6 CONFIGURATION OF SYSTEM UNDER TEST

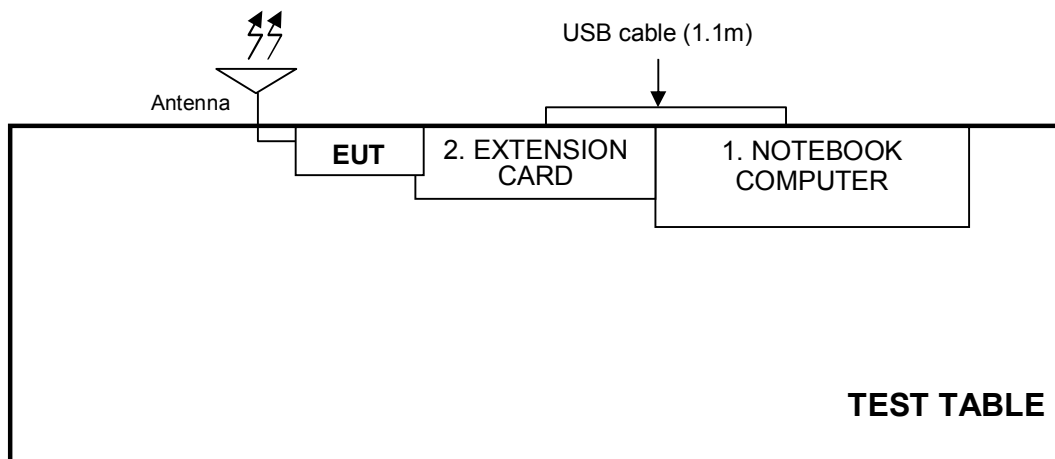

## 4. TEST TYPES AND RESULTS

### 4.1 CONDUCTED EMISSION MEASUREMENT

#### 4.1.1 LIMITS OF CONDUCTED EMISSION MEASUREMENT

FREQUENCY OF EMISSION (MHz)	CONDUCTED LIMIT (dB $\mu$ V)	
	Quasi-peak	Average
0.15-0.5	66 to 56	56 to 46
0.5-5	56	46
5-30	60	50

- NOTE:**
1. The lower limit shall apply at the transition frequencies.
  2. The limit decreases in line with the logarithm of the frequency in the range of 0.15 to 0.50 MHz.
  3. All emanations from a class A/B digital device or system, including any network of conductors and apparatus connected thereto, shall not exceed the level of field strengths specified above.

#### 4.1.2 TEST INSTRUMENTS

DESCRIPTION & MANUFACTURER	MODEL NO.	SERIAL NO.	CALIBRATED DATE	CALIBRATED UNTIL
Test Receiver	ESCS 30	100375	Mar. 09, 2010	Mar. 08, 2011
Line-Impedance Stabilization Network (for EUT)	NSLK 8127	8127-522	Sep. 23, 2009	Sep. 22, 2010
Line-Impedance Stabilization Network (for Peripheral)	ESH3-Z5	848773/004	Oct. 26, 2009	Oct. 25, 2010
RF Cable (JYBAO)	5DFB	COBCAB-001	Nov. 24, 2009	Nov. 23, 2010
50 ohms Terminator	50	3	Oct. 28, 2009	Oct. 27, 2010
Software	BV ADT_Cond_V7.3.7	NA	NA	NA

**Note:**

1. The calibration interval of the above test instruments is 12 months and the calibrations are traceable to NML/ROC and NIST/USA.
2. The test was performed in Shielded Room No. C.
3. The VCCI Con C Registration No. is C-3611.



#### 4.1.3 TEST PROCEDURES

- a. The EUT was placed 0.4 meters from the conducting wall of the shielded room with EUT being connected to the power mains through a line impedance stabilization network (LISN). Other support units were connected to the power mains through another LISN. The two LISNs provide 50 ohm/ 50uH of coupling impedance for the measuring instrument.
- b. Both lines of the power mains connected to the EUT were checked for maximum conducted interference.
- c. The frequency range from 150kHz to 30MHz was searched. Emission levels under (Limit - 20dB) were not recorded.

#### 4.1.4 DEVIATION FROM TEST STANDARD

No deviation

#### 4.1.5 TEST SETUP

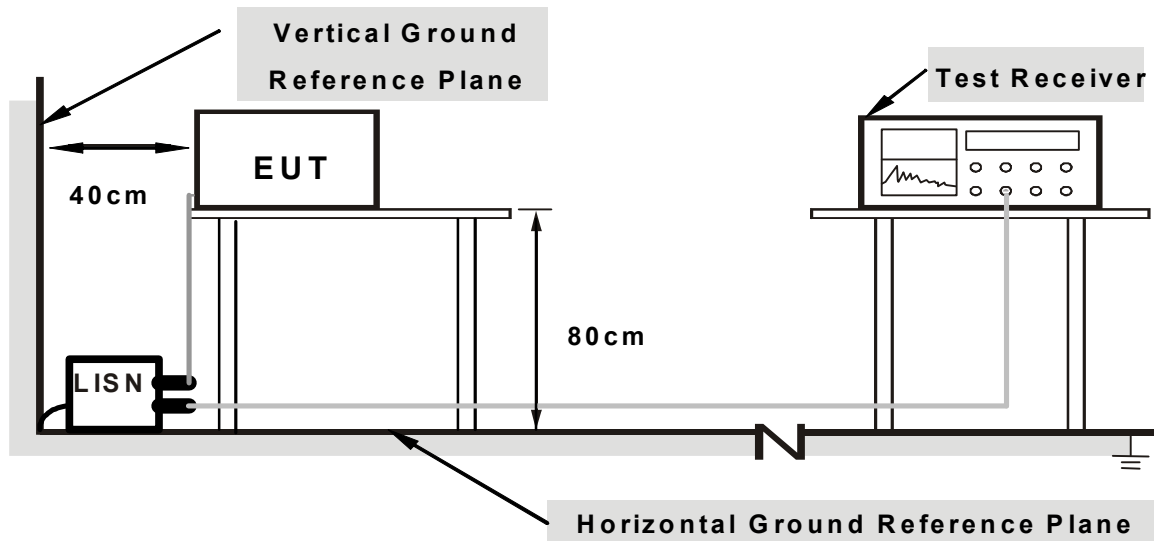

**Note: 1. Support units were connected to second LISN.**

**2. Both of LISNs (AMN) are 80 cm from EUT and at least 80 from other units and other metal planes**

For the actual test configuration, please refer to the related item – Photographs of the Test Configuration.

#### 4.1.6 EUT OPERATING CONDITIONS

1. Connect the EUT with the support unit 1 (Notebook Computer) which is placed on a testing table.
2. The communication partner run test program “ART\_win\_release\_ar6003\_v\_0.2.6\_061110” to enable EUT under transmission/receiving condition continuously at specific channel frequency.

### 4.1.7 TEST RESULTS

<b>PHASE</b>	Line (L)	<b>6dB BANDWIDTH</b>	9 kHz
--------------	----------	----------------------	-------

No	Freq. [MHz]	Corr. Factor (dB)	Reading Value [dB (uV)]		Emission Level [dB (uV)]		Limit [dB (uV)]		Margin (dB)	
			Q.P.	AV.	Q.P.	AV.	Q.P.	AV.	Q.P.	AV.
			1	0.150	0.05	50.54	-	50.59	-	66.00
2	0.158	0.05	44.76	-	44.81	-	65.58	55.58	-20.76	-
3	1.829	0.12	37.05	-	37.17	-	56.00	46.00	-18.83	-
4	1.930	0.13	34.72	-	34.85	-	56.00	46.00	-21.15	-
5	16.206	0.45	38.04	-	38.49	-	60.00	50.00	-21.51	-
6	19.086	0.50	35.51	-	36.01	-	60.00	50.00	-23.99	-

- REMARKS:**
1. Q.P. and AV. are abbreviations of quasi-peak and average individually.
  2. "-": The Quasi-peak reading value also meets average limit and measurement with the average detector is unnecessary.
  3. The emission levels of other frequencies were very low against the limit.
  4. Margin value = Emission level - Limit value
  5. Correction factor = Insertion loss + Cable loss
  6. Emission Level = Correction Factor + Reading Value.

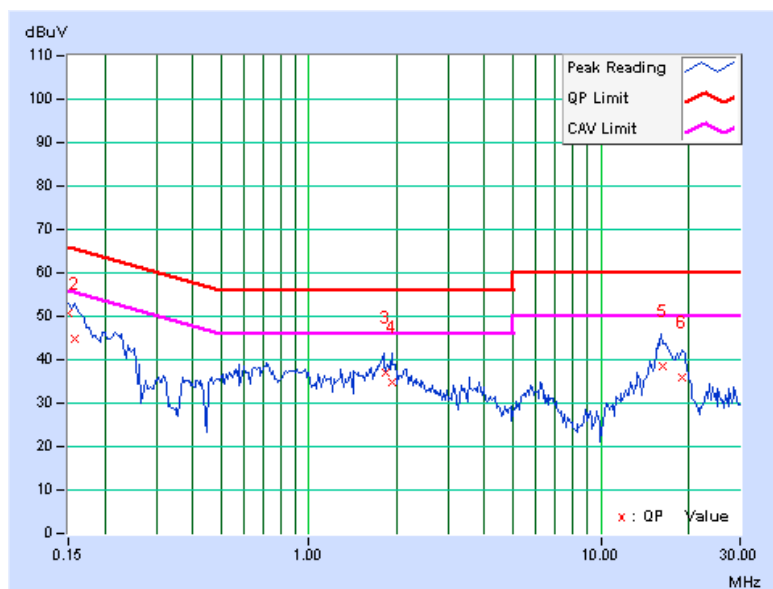

<b>PHASE</b>	Neutral (N)	<b>6dB BANDWIDTH</b>	9 kHz
--------------	-------------	----------------------	-------

No	Freq. [MHz]	Corr. Factor (dB)	Reading Value [dB (uV)]		Emission Level [dB (uV)]		Limit [dB (uV)]		Margin (dB)	
			Q.P.	AV.	Q.P.	AV.	Q.P.	AV.	Q.P.	AV.
			1	0.152	0.06	45.73	-	45.79	-	65.90
2	0.642	0.08	31.16	-	31.24	-	56.00	46.00	-24.76	-
3	2.565	0.16	28.98	-	29.14	-	56.00	46.00	-26.86	-
4	7.206	0.29	28.54	-	28.83	-	60.00	50.00	-31.17	-
5	15.852	0.45	41.24	-	41.69	-	60.00	50.00	-18.31	-
6	16.670	0.47	39.12	-	39.59	-	60.00	50.00	-20.41	-

- REMARKS:**
1. Q.P. and AV. are abbreviations of quasi-peak and average individually.
  2. "-": The Quasi-peak reading value also meets average limit and measurement with the average detector is unnecessary.
  3. The emission levels of other frequencies were very low against the limit.
  4. Margin value = Emission level - Limit value
  5. Correction factor = Insertion loss + Cable loss
  6. Emission Level = Correction Factor + Reading Value.

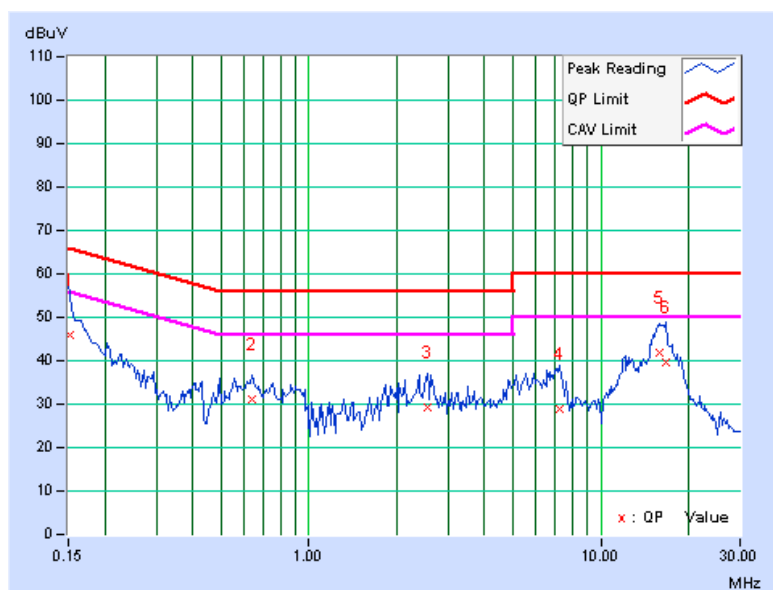

## 4.2 RADIATED EMISSION MEASUREMENT

### 4.2.1 LIMITS OF RADIATED EMISSION MEASUREMENT

Emissions radiated outside of the specified bands, shall be according to the general radiated limits in 15.209(RSS-210 table 2&3) as following:

Frequencies (MHz)	Field strength (microvolts/meter)	Measurement distance (meters)
0.009-0.490	2400/F(kHz)	300
0.490-1.705	24000/F(kHz)	30
1.705-30.0	30	30
30-88	100	3
88-216	150	3
216-960	200	3
Above 960	500	3

**NOTE:**

1. The lower limit shall apply at the transition frequencies.
2. Emission level (dBuV/m) = 20 log Emission level (uV/m).
3. As shown in 15.35(b), for frequencies above 1000MHz, the field strength limits are based on average detector, however, the peak field strength of any emission shall not exceed the maximum permitted average limits, specified above by more than 20dB under any condition of modulation.



A D T

#### 4.2.2 TEST INSTRUMENTS

DESCRIPTION & MANUFACTURER	MODEL NO.	SERIAL NO.	CALIBRATED DATE	CALIBRATED UNTIL
Agilent Spectrum Analyzer	E4446A	MY48250254	Aug. 03, 2009	Aug. 02, 2010
Agilent Pre-Selector	N9039A	MY46520310	Aug. 18, 2009	Aug. 17, 2010
Agilent Signal Generator	N5181A	MY49060347	July 18, 2010	July 17, 2011
LIG NEX1 Test Receiver	ER-265	L09068005	Aug. 31, 2009	Aug. 30, 2010
Mini-Circuits Pre-Amplifier	ZFL-1000VH2B	AMP-ZFL-04	Nov. 18, 2009	Nov. 17, 2010
Agilent Pre-Amplifier	8449B	3008A02465	Mar. 01, 2010	Feb. 28, 2011
Miteq Pre-Amplifier	AFS33-1800265 0-30-8P-44	881786	NA	NA
SCHWARZBECK Trilog Broadband Antenna	VULB 9168	9168-361	Sep. 30, 2009	Sep. 29, 2010
AISI Horn_Antenna	AIH.8018	0000220091110	Nov. 16, 2009	Nov. 15, 2010
SCHWARZBECK Horn_Antenna	BBHA 9170	9170-424	Sep. 30, 2009	Sep. 29, 2010
RF CABLE	NA	RF104-205 RF104-207 RF104-208	Dec. 24, 2009	Dec. 23, 2010
RF Cable	NA	CHHCAB_001	NA	NA
Software	ADT_Radiated_V8.7.05	NA	NA	NA
CT Antenna Tower & Turn Table	NA	NA	NA	NA

- Note: 1. The calibration interval of the above test instruments is 12 months and the calibrations are traceable to NML/ROC and NIST/USA.  
2. The horn antenna, preamplifier (model: 8449B) are used only for the measurement of emission frequency above 1GHz if tested.  
3. The test was performed in 966 Chamber No. H.  
4. The FCC Site Registration No. is 797305.  
5. The CANADA Site Registration No. is IC 7450H-3.



A D T

#### 4.2.3 TEST PROCEDURES

- a. The EUT was placed on the top of a rotating table 0.8 meters above the ground at a 3 meter chamber room. The table was rotated 360 degrees to determine the position of the highest radiation.
- b. The EUT was set 3 meters away from the interference-receiving antenna, which was mounted on the top of a variable-height antenna tower.
- c. The antenna is a broadband antenna, and its height is varied from one meter to four meters above the ground to determine the maximum value of the field strength. Both horizontal and vertical polarizations of the antenna are set to make the measurement.
- d. For each suspected emission, the EUT was arranged to its worst case and then the antenna was tuned to heights from 1 meter to 4 meters and the rotatable table was turned from 0 degrees to 360 degrees to find the maximum reading.
- e. The test-receiver system was set to Peak Detect Function and Specified Bandwidth with Maximum Hold Mode.
- f. If the emission level of the EUT in peak mode was 10dB lower than the limit specified, then testing could be stopped and the peak values of the EUT would be reported. Otherwise the emissions that did not have 10dB margin would be re-tested one by one using peak, quasi-peak or average method as specified and then reported in a data sheet.

**NOTE:**

1. The resolution bandwidth and video bandwidth of test receiver/spectrum analyzer is 120kHz for Peak detection (PK) and Quasi-peak detection (QP) at frequency below 1GHz.
2. The resolution bandwidth of test receiver/spectrum analyzer is 1 MHz and the video bandwidth is 3 MHz for Peak detection (PK) at frequency above 1GHz.
3. The resolution bandwidth of test receiver/spectrum analyzer is 1 MHz and the video bandwidth is 10 Hz for Average detection (AV) at frequency above 1GHz.

#### 4.2.4 DEVIATION FROM TEST STANDARD

No deviation

#### 4.2.5 TEST SETUP

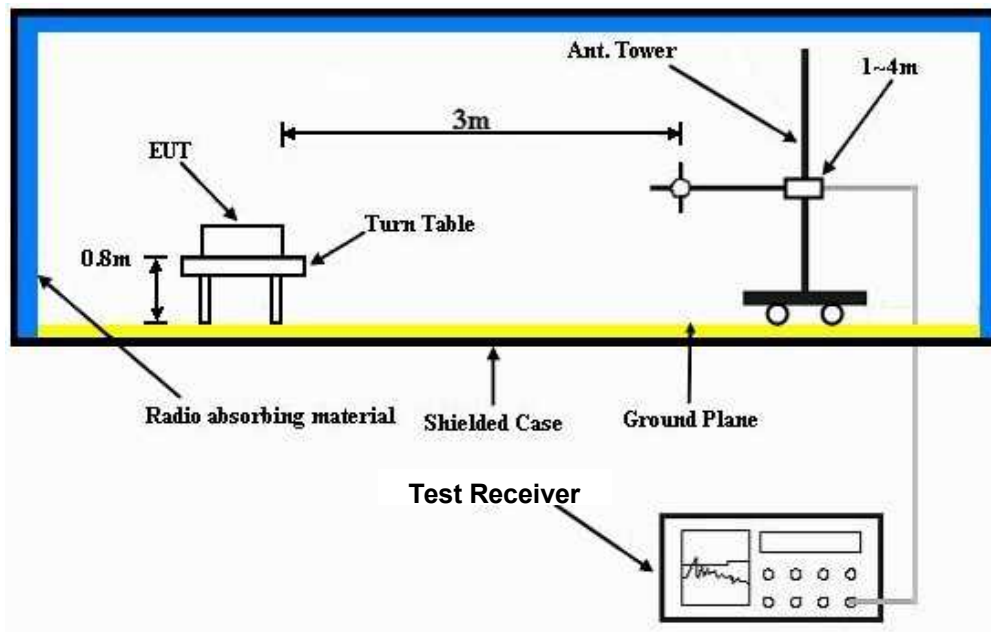

For the actual test configuration, please refer to the related item – Photographs of the Test Configuration.

#### 4.2.6 EUT OPERATING CONDITIONS

Same as 4.1.6





A D T

## 4.2.7 TEST RESULTS (FOR TRANSMITTER PART)

## BELOW 1GHz WORST-CASE DATA : 802.11g OFDM MODULATION

EUT TEST CONDITION		MEASUREMENT DETAIL	
CHANNEL	Channel 6	FREQUENCY RANGE	Below 1000MHz
INPUT POWER (SYSTEM)	120Vac, 60 Hz	DETECTOR FUNCTION	Quasi-Peak
ENVIRONMENTAL CONDITIONS	24deg. C, 70%RH 1013 hPa	TESTED BY	Eric Lee

ANTENNA POLARITY & TEST DISTANCE: HORIZONTAL AT 3 M								
NO.	FREQ. (MHz)	EMISSION LEVEL (dBuV/m)	LIMIT (dBuV/m)	MARGIN (dB)	ANTENNA HEIGHT (m)	TABLE ANGLE (Degree)	RAW VALUE (dBuV)	CORRECTION FACTOR (dB/m)
1	99.65	33.7 QP	43.5	-9.8	1.75 H	360	23.75	9.95
2	116.50	35.4 QP	43.5	-8.1	1.50 H	358	23.11	12.29
3	133.16	33.9 QP	43.5	-9.6	2.25 H	0	20.21	13.69
4	149.90	35.8 QP	43.5	-7.7	1.50 H	360	21.52	14.30
5	166.55	42.0 QP	43.5	-1.5	1.75 H	220	28.00	14.00
6	199.30	37.4 QP	43.5	-6.1	1.25 H	0	26.14	11.26
7	248.96	39.8 QP	46.0	-6.2	1.25 H	281	26.91	12.91
ANTENNA POLARITY & TEST DISTANCE: VERTICAL AT 3 M								
NO.	FREQ. (MHz)	EMISSION LEVEL (dBuV/m)	LIMIT (dBuV/m)	MARGIN (dB)	ANTENNA HEIGHT (m)	TABLE ANGLE (Degree)	RAW VALUE (dBuV)	CORRECTION FACTOR (dB/m)
1	33.50	37.8 QP	40.0	-2.2	1.00 V	291	24.32	13.46
2	99.80	26.8 QP	43.5	-16.7	1.00 V	28	16.85	9.95
3	149.86	33.6 QP	43.5	-9.9	1.25 V	360	19.30	14.30
4	166.05	34.4 QP	43.5	-9.1	2.25 V	312	20.38	14.02
5	248.82	33.3 QP	46.0	-12.7	1.00 V	217	20.39	12.91
6	365.25	31.0 QP	46.0	-15.0	1.75 V	360	14.12	16.88

- REMARKS:**
1. Emission level (dBuV/m) = Raw Value (dBuV) + Correction Factor (dB/m).
  2. Correction Factor (dB/m) = Antenna Factor (dB/m) + Cable Factor (dB).
  3. The other emission levels were very low against the limit.
  4. Margin value = Emission level – Limit value.



A D T

## ABOVE 1GHz WORST-CASE DATA

### 802.11b DSSS MODULATION

EUT TEST CONDITION		MEASUREMENT DETAIL	
CHANNEL	Channel 1	FREQUENCY RANGE	1 ~ 25GHz
INPUT POWER (SYSTEM)	120Vac, 60 Hz	DETECTOR FUNCTION	Peak (PK) Average (AV)
ENVIRONMENTAL CONDITIONS	28deg. C, 74%RH 1013 hPa	TESTED BY	Rex Huang

ANTENNA POLARITY & TEST DISTANCE: HORIZONTAL AT 3 M								
NO.	FREQ. (MHz)	EMISSION LEVEL (dBuV/m)	LIMIT (dBuV/m)	MARGIN (dB)	ANTENNA HEIGHT (m)	TABLE ANGLE (Degree)	RAW VALUE (dBuV)	CORRECTION FACTOR (dB/m)
1	2386.00	59.7 PK	74.0	-14.3	1.77 H	306	28.50	31.20
2	2386.00	52.2 AV	54.0	-1.8	1.77 H	306	21.00	31.20
3	*2412.00	105.4 PK			1.76 H	304	74.13	31.27
4	*2412.00	102.9 AV			1.76 H	304	71.63	31.27
5	4824.00	51.5 PK	74.0	-22.5	1.04 H	108	12.08	39.42
6	4824.00	47.4 AV	54.0	-6.6	1.04 H	108	7.98	39.42
ANTENNA POLARITY & TEST DISTANCE: VERTICAL AT 3 M								
NO.	FREQ. (MHz)	EMISSION LEVEL (dBuV/m)	LIMIT (dBuV/m)	MARGIN (dB)	ANTENNA HEIGHT (m)	TABLE ANGLE (Degree)	RAW VALUE (dBuV)	CORRECTION FACTOR (dB/m)
1	2386.10	58.1 PK	74.0	-15.9	1.22 V	60	26.90	31.20
2	2386.10	49.7 AV	54.0	-4.3	1.22 V	60	18.50	31.20
3	*2412.00	100.1 PK			1.22 V	55	68.83	31.27
4	*2412.00	97.5 AV			1.22 V	55	66.23	31.27
5	4824.00	54.1 PK	74.0	-19.9	1.04 V	4	14.68	39.42
6	4824.00	51.5 AV	54.0	-2.5	1.04 V	4	12.08	39.42

- REMARKS:**
1. Emission level (dBuV/m) = Raw Value (dBuV) + Correction Factor (dB/m).
  2. Correction Factor (dB/m) = Antenna Factor (dB/m) + Cable Factor (dB).
  3. The other emission levels were very low against the limit.
  4. Margin value = Emission level – Limit value.
  5. “ \* “: Fundamental frequency.



A D T

EUT TEST CONDITION		MEASUREMENT DETAIL	
CHANNEL	Channel 6	FREQUENCY RANGE	1 ~ 25GHz
INPUT POWER (SYSTEM)	120Vac, 60 Hz	DETECTOR FUNCTION	Peak (PK) Average (AV)
ENVIRONMENTAL CONDITIONS	28deg. C, 74%RH 1013 hPa	TESTED BY	Rex Huang

ANTENNA POLARITY & TEST DISTANCE: HORIZONTAL AT 3 M								
NO.	FREQ. (MHz)	EMISSION LEVEL (dBuV/m)	LIMIT (dBuV/m)	MARGIN (dB)	ANTENNA HEIGHT (m)	TABLE ANGLE (Degree)	RAW VALUE (dBuV)	CORRECTION FACTOR (dB/m)
1	*2437.00	107.9 PK			1.72 H	306	76.56	31.34
2	*2437.00	105.1 AV			1.72 H	306	73.76	31.34
3	4874.00	52.1 PK	74.0	-21.9	1.02 H	158	12.48	39.62
4	4874.00	48.1 AV	54.0	-5.9	1.02 H	158	8.48	39.62
5	7311.00	54.1 PK	74.0	-19.9	1.50 H	299	10.00	44.10
6	7311.00	41.7 AV	54.0	-12.3	1.50 H	299	-2.40	44.10
ANTENNA POLARITY & TEST DISTANCE: VERTICAL AT 3 M								
NO.	FREQ. (MHz)	EMISSION LEVEL (dBuV/m)	LIMIT (dBuV/m)	MARGIN (dB)	ANTENNA HEIGHT (m)	TABLE ANGLE (Degree)	RAW VALUE (dBuV)	CORRECTION FACTOR (dB/m)
1	*2437.00	102.4 PK			1.19 V	65	71.06	31.34
2	*2437.00	98.4 AV			1.19 V	65	67.06	31.34
3	4874.00	53.4 PK	74.0	-20.6	1.10 V	216	13.78	39.62
4	4874.00	51.3 AV	54.0	-2.7	1.10 V	216	11.68	39.62
5	7311.00	54.7 PK	74.0	-19.3	1.23 V	57	10.60	44.10
6	7311.00	42.8 AV	54.0	-11.2	1.23 V	57	-1.30	44.10

- REMARKS:**
1. Emission level (dBuV/m) = Raw Value (dBuV) + Correction Factor (dB/m).
  2. Correction Factor (dB/m) = Antenna Factor (dB/m) + Cable Factor (dB).
  3. The other emission levels were very low against the limit.
  4. Margin value = Emission level – Limit value.
  5. “ \* “: Fundamental frequency.



A D T

EUT TEST CONDITION		MEASUREMENT DETAIL	
CHANNEL	Channel 11	FREQUENCY RANGE	1 ~ 25GHz
INPUT POWER (SYSTEM)	120Vac, 60 Hz	DETECTOR FUNCTION	Peak (PK) Average (AV)
ENVIRONMENTAL CONDITIONS	28deg. C, 74%RH 1013 hPa	TESTED BY	Rex Huang

**ANTENNA POLARITY & TEST DISTANCE: HORIZONTAL AT 3 M**

NO.	FREQ. (MHz)	EMISSION LEVEL (dBuV/m)	LIMIT (dBuV/m)	MARGIN (dB)	ANTENNA HEIGHT (m)	TABLE ANGLE (Degree)	RAW VALUE (dBuV)	CORRECTION FACTOR (dB/m)
1	*2462.00	105.3 PK			1.70 H	307	73.90	31.40
2	*2462.00	103.1 AV			1.70 H	307	71.70	31.40
3	2488.00	60.0 PK	74.0	-14.0	1.69 H	311	28.53	31.47
4	2488.00	52.4 AV	54.0	-1.6	1.69 H	311	20.93	31.47
5	4924.00	51.1 PK	74.0	-22.9	1.00 H	112	11.28	39.82
6	4924.00	47.4 AV	54.0	-6.6	1.00 H	112	7.58	39.82
7	7386.00	53.1 PK	74.0	-20.9	1.60 H	300	8.92	44.18
8	7386.00	39.9 AV	54.0	-14.1	1.60 H	300	-4.28	44.18

**ANTENNA POLARITY & TEST DISTANCE: VERTICAL AT 3 M**

NO.	FREQ. (MHz)	EMISSION LEVEL (dBuV/m)	LIMIT (dBuV/m)	MARGIN (dB)	ANTENNA HEIGHT (m)	TABLE ANGLE (Degree)	RAW VALUE (dBuV)	CORRECTION FACTOR (dB/m)
1	*2462.00	98.1 PK			1.22 V	63	66.70	31.40
2	*2462.00	96.1 AV			1.22 V	63	64.70	31.40
3	2487.80	58.6 PK	74.0	-15.4	1.19 V	59	27.13	31.47
4	2487.80	48.0 AV	54.0	-6.0	1.19 V	59	16.53	31.47
5	4924.00	53.7 PK	74.0	-20.3	1.05 V	94	13.88	39.82
6	4924.00	50.7 AV	54.0	-3.3	1.05 V	94	10.88	39.82
7	7386.00	54.8 PK	74.0	-19.2	1.14 V	106	10.62	44.18
8	7386.00	41.4 AV	54.0	-12.6	1.14 V	106	-2.78	44.18

- REMARKS:**
1. Emission level (dBuV/m) = Raw Value (dBuV) + Correction Factor (dB/m).
  2. Correction Factor (dB/m) = Antenna Factor (dB/m) + Cable Factor (dB).
  3. The other emission levels were very low against the limit.
  4. Margin value = Emission level – Limit value.
  5. “ \* “: Fundamental frequency.



A D T

RESTRICTED BANDEDGE (802.11b MODE, CH1, HORIZONTAL )

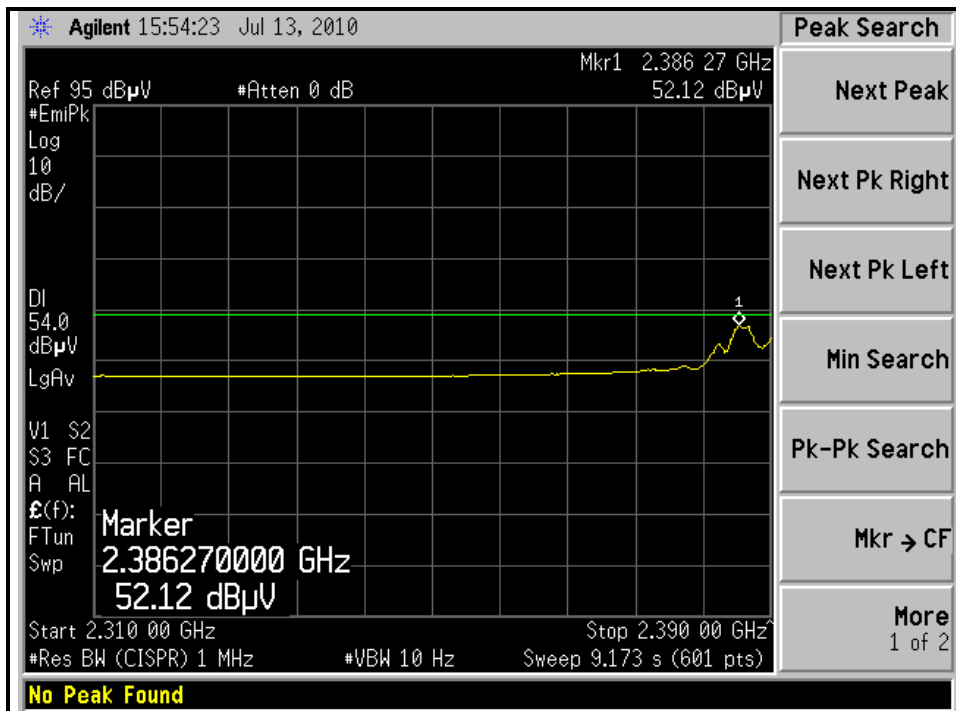
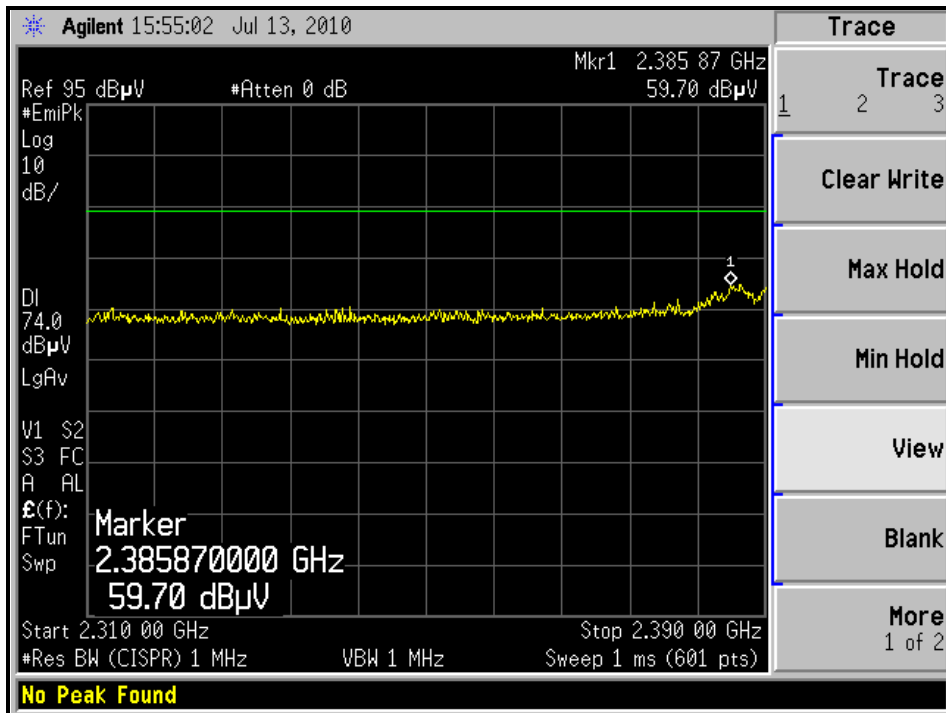



A D T

RESTRICTED BANDEDGE (802.11b MODE, CH1, VERTICAL )

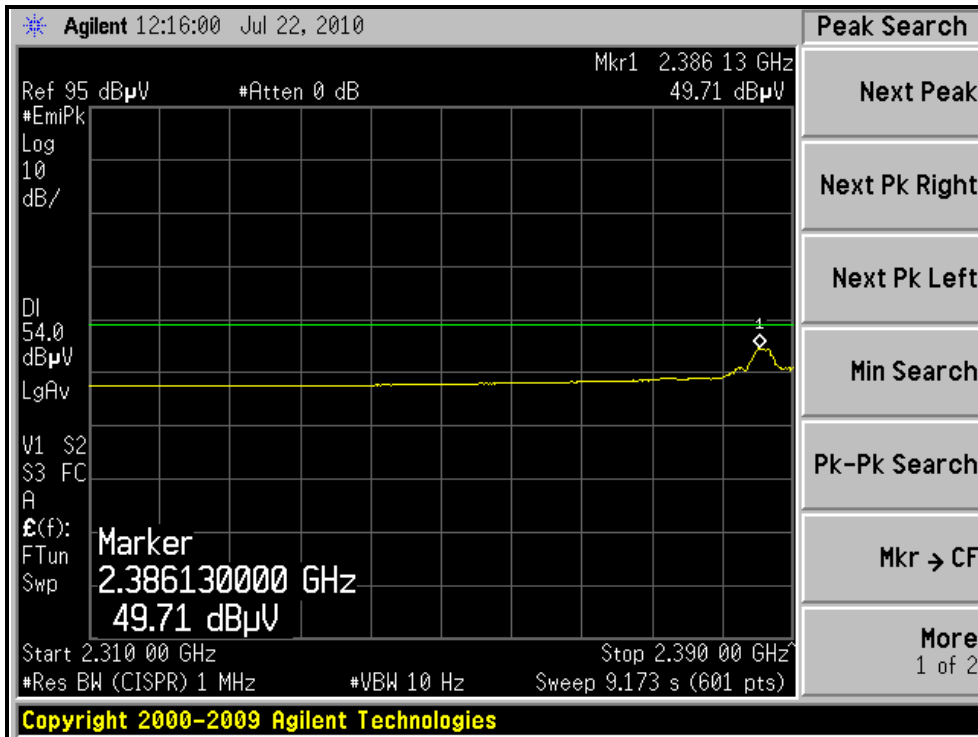
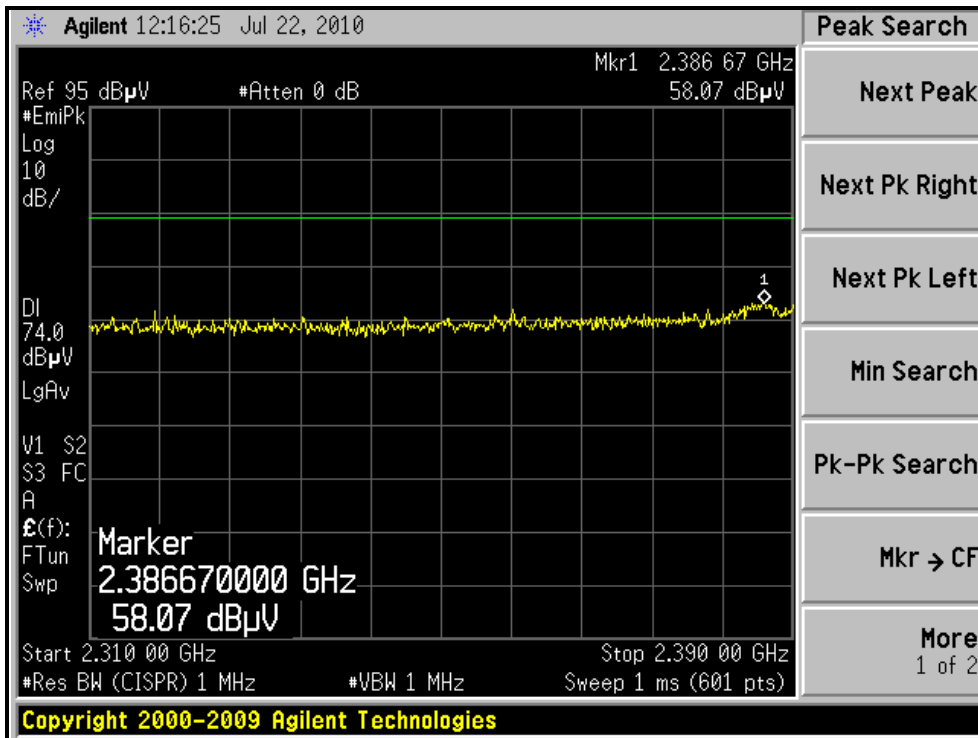



A D T

RESTRICTED BANDEDGE (802.11b MODE, CH11, HORIZONTAL )

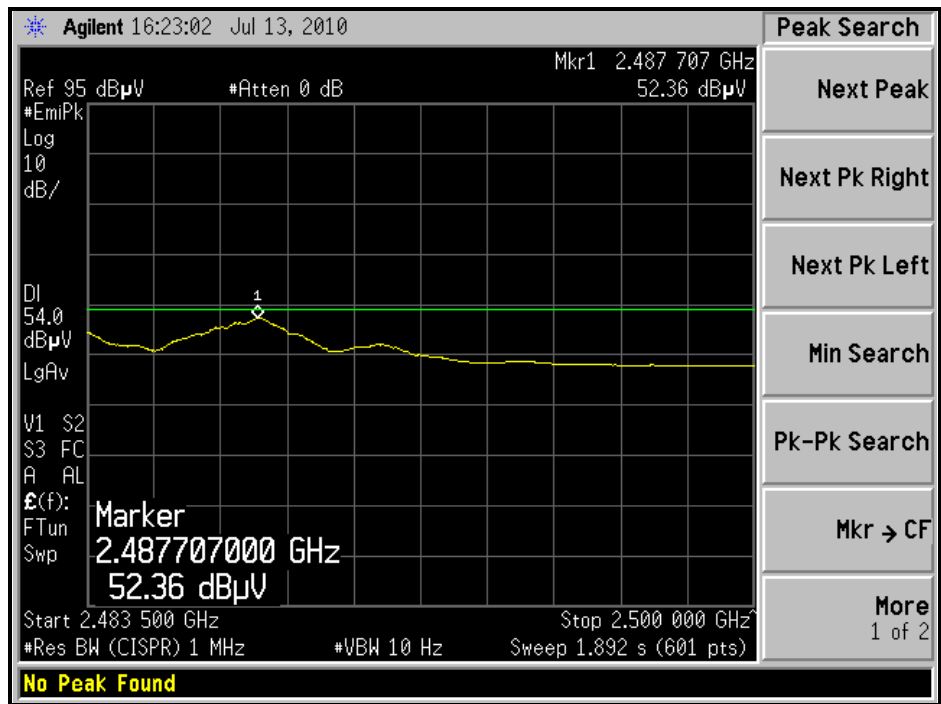
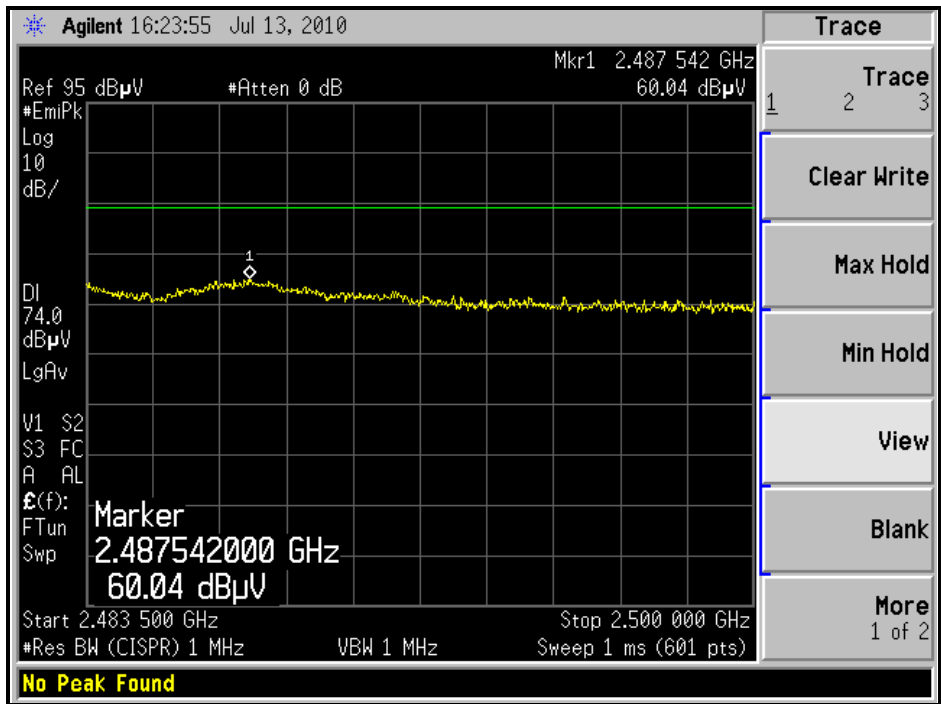



A D T

RESTRICTED BANDEDGE (802.11b MODE, CH11, VERTICAL )

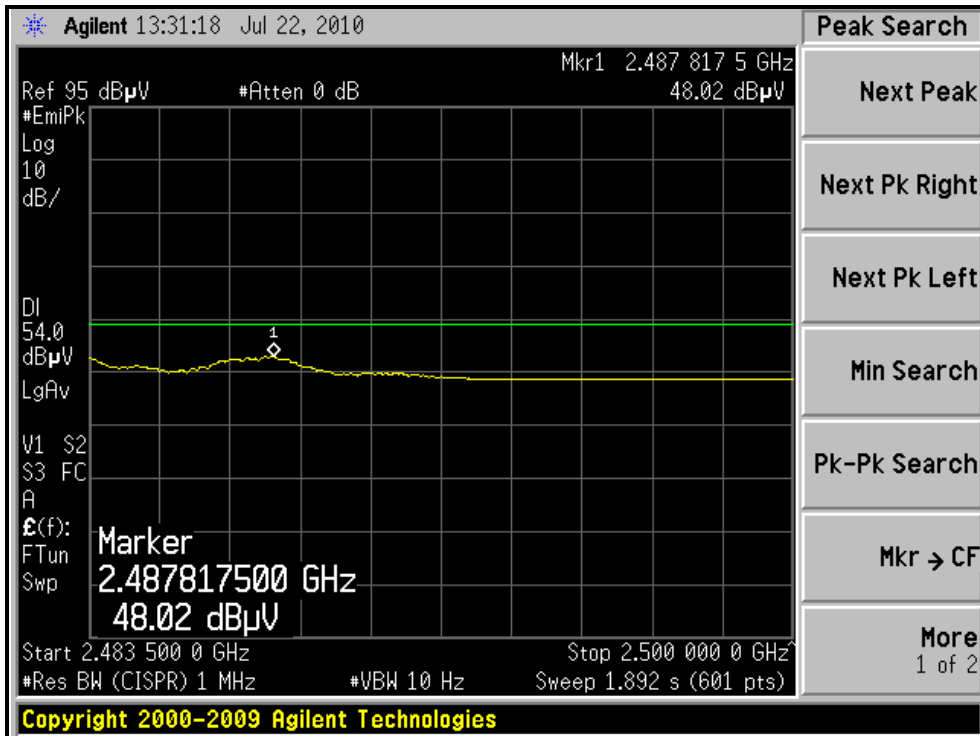
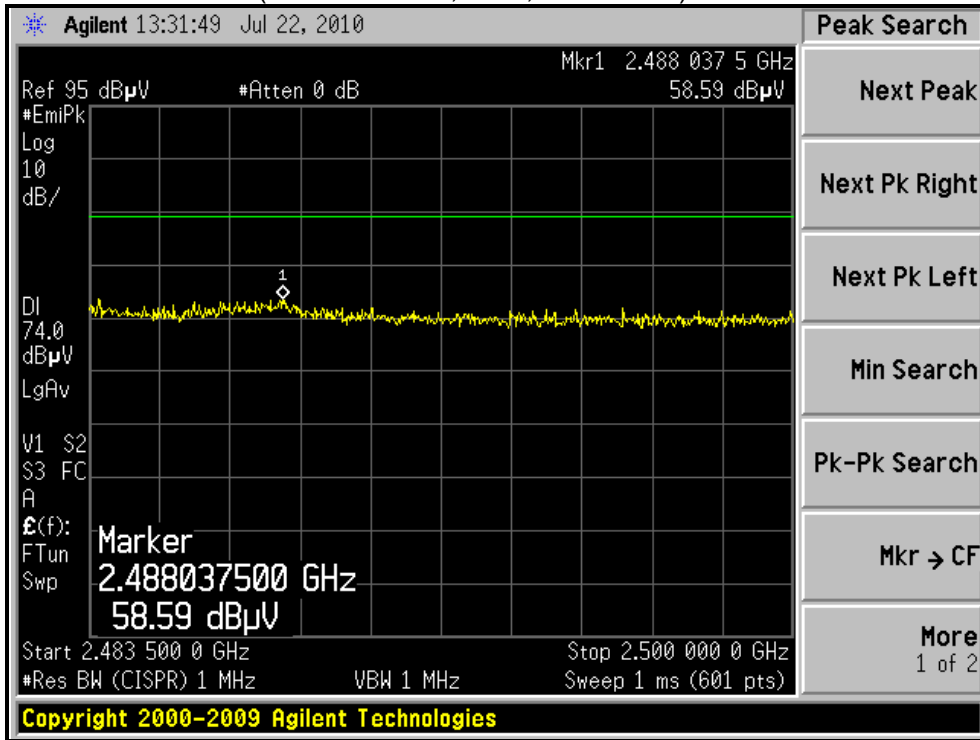





A D T

**802.11g OFDM MODULATION**

EUT TEST CONDITION		MEASUREMENT DETAIL	
CHANNEL	Channel 1	FREQUENCY RANGE	1 ~ 25GHz
INPUT POWER (SYSTEM)	120Vac, 60 Hz	DETECTOR FUNCTION	Peak (PK) Average (AV)
ENVIRONMENTAL CONDITIONS	28deg. C, 74%RH 1013 hPa	TESTED BY	Rex Huang

**ANTENNA POLARITY & TEST DISTANCE: HORIZONTAL AT 3 M**

NO.	FREQ. (MHz)	EMISSION LEVEL (dBuV/m)	LIMIT (dBuV/m)	MARGIN (dB)	ANTENNA HEIGHT (m)	TABLE ANGLE (Degree)	RAW VALUE (dBuV)	CORRECTION FACTOR (dB/m)
1	2390.00	69.4 PK	74.0	-4.6	1.78 H	306	38.19	31.21
2	2390.00	53.0 AV	54.0	-1.0	1.78 H	306	21.79	31.21
3	*2412.00	106.3 PK			1.74 H	304	75.03	31.27
4	*2412.00	96.0 AV			1.74 H	304	64.73	31.27
5	4824.00	48.9 PK	74.0	-25.1	1.44 H	71	9.48	39.42
6	4824.00	38.9 AV	54.0	-15.1	1.44 H	71	-0.52	39.42

**ANTENNA POLARITY & TEST DISTANCE: VERTICAL AT 3 M**

NO.	FREQ. (MHz)	EMISSION LEVEL (dBuV/m)	LIMIT (dBuV/m)	MARGIN (dB)	ANTENNA HEIGHT (m)	TABLE ANGLE (Degree)	RAW VALUE (dBuV)	CORRECTION FACTOR (dB/m)
1	2390.00	62.5 PK	74.0	-11.5	1.21 V	60	31.29	31.21
2	2390.00	48.8 AV	54.0	-5.2	1.21 V	60	17.59	31.21
3	*2412.00	100.2 PK			1.22 V	55	68.93	31.27
4	*2412.00	89.3 AV			1.22 V	55	58.03	31.27
5	4824.00	50.2 PK	74.0	-23.8	1.14 V	83	10.78	39.42
6	4824.00	41.9 AV	54.0	-12.1	1.14 V	83	2.48	39.42

- REMARKS:**
1. Emission level (dBuV/m) = Raw Value (dBuV) + Correction Factor (dB/m).
  2. Correction Factor (dB/m) = Antenna Factor (dB/m) + Cable Factor (dB).
  3. The other emission levels were very low against the limit.
  4. Margin value = Emission level – Limit value.
  5. “ \* “: Fundamental frequency.



A D T

EUT TEST CONDITION		MEASUREMENT DETAIL	
CHANNEL	Channel 6	FREQUENCY RANGE	1 ~ 25GHz
INPUT POWER (SYSTEM)	120Vac, 60 Hz	DETECTOR FUNCTION	Peak (PK) Average (AV)
ENVIRONMENTAL CONDITIONS	28deg. C, 74%RH 1013 hPa	TESTED BY	Rex Huang

ANTENNA POLARITY & TEST DISTANCE: HORIZONTAL AT 3 M								
NO.	FREQ. (MHz)	EMISSION LEVEL (dBuV/m)	LIMIT (dBuV/m)	MARGIN (dB)	ANTENNA HEIGHT (m)	TABLE ANGLE (Degree)	RAW VALUE (dBuV)	CORRECTION FACTOR (dB/m)
1	*2437.00	112.6 PK			1.71 H	306	81.26	31.34
2	*2437.00	102.5 AV			1.71 H	306	71.16	31.34
3	4874.00	61.1 PK	74.0	-12.9	1.69 H	248	21.48	39.62
4	4874.00	46.9 AV	54.0	-7.1	1.69 H	248	7.28	39.62
5	7311.00	55.6 PK	74.0	-18.4	1.23 H	50	11.50	44.10
6	7311.00	41.5 AV	54.0	-12.5	1.23 H	50	-2.60	44.10
ANTENNA POLARITY & TEST DISTANCE: VERTICAL AT 3 M								
NO.	FREQ. (MHz)	EMISSION LEVEL (dBuV/m)	LIMIT (dBuV/m)	MARGIN (dB)	ANTENNA HEIGHT (m)	TABLE ANGLE (Degree)	RAW VALUE (dBuV)	CORRECTION FACTOR (dB/m)
1	*2437.00	106.5 PK			1.20 V	360	75.16	31.34
2	*2437.00	96.8 AV			1.20 V	360	65.46	31.34
3	4874.00	63.4 PK	74.0	-10.6	1.11 V	150	23.78	39.62
4	4874.00	48.5 AV	54.0	-5.5	1.11 V	150	8.88	39.62
5	7311.00	57.2 PK	74.0	-16.8	1.28 V	11	13.10	44.10
6	7311.00	42.4 AV	54.0	-11.6	1.28 V	11	-1.70	44.10

- REMARKS:**
1. Emission level (dBuV/m) = Raw Value (dBuV) + Correction Factor (dB/m).
  2. Correction Factor (dB/m) = Antenna Factor (dB/m) + Cable Factor (dB).
  3. The other emission levels were very low against the limit.
  4. Margin value = Emission level – Limit value.
  5. “ \* “: Fundamental frequency.



A D T

EUT TEST CONDITION		MEASUREMENT DETAIL	
CHANNEL	Channel 11	FREQUENCY RANGE	1 ~ 25GHz
INPUT POWER (SYSTEM)	120Vac, 60 Hz	DETECTOR FUNCTION	Peak (PK) Average (AV)
ENVIRONMENTAL CONDITIONS	28deg. C, 74%RH 1013 hPa	TESTED BY	Rex Huang

**ANTENNA POLARITY & TEST DISTANCE: HORIZONTAL AT 3 M**

NO.	FREQ. (MHz)	EMISSION LEVEL (dBuV/m)	LIMIT (dBuV/m)	MARGIN (dB)	ANTENNA HEIGHT (m)	TABLE ANGLE (Degree)	RAW VALUE (dBuV)	CORRECTION FACTOR (dB/m)
1	*2462.00	106.4 PK			1.71 H	307	75.00	31.40
2	*2462.00	95.9 AV			1.71 H	307	64.50	31.40
3	2483.50	69.2 PK	74.0	-4.8	1.70 H	311	37.74	31.46
4	2483.50	53.0 AV	54.0	-1.0	1.70 H	311	21.54	31.46
5	4924.00	48.6 PK	74.0	-25.4	1.69 H	144	8.78	39.82
6	4924.00	39.1 AV	54.0	-14.9	1.69 H	144	-0.72	39.82
7	7386.00	52.1 PK	74.0	-21.9	1.11 H	48	7.92	44.18
8	7386.00	38.9 AV	54.0	-15.1	1.11 H	48	-5.28	44.18

**ANTENNA POLARITY & TEST DISTANCE: VERTICAL AT 3 M**

NO.	FREQ. (MHz)	EMISSION LEVEL (dBuV/m)	LIMIT (dBuV/m)	MARGIN (dB)	ANTENNA HEIGHT (m)	TABLE ANGLE (Degree)	RAW VALUE (dBuV)	CORRECTION FACTOR (dB/m)
1	*2462.00	100.1 PK			1.20 V	48	68.70	31.40
2	*2462.00	89.2 AV			1.20 V	48	57.80	31.40
3	2483.50	67.9 PK	74.0	-6.1	1.19 V	53	36.44	31.46
4	2483.50	49.9 AV	54.0	-4.1	1.19 V	53	18.44	31.46
5	4924.00	49.9 PK	74.0	-24.1	1.48 V	26	10.08	39.82
6	4924.00	41.5 AV	54.0	-12.5	1.48 V	26	1.68	39.82
7	7386.00	53.6 PK	74.0	-20.4	1.14 V	278	9.42	44.18
8	7386.00	39.2 AV	54.0	-14.8	1.14 V	278	-4.98	44.18

- REMARKS:**
1. Emission level (dBuV/m) = Raw Value (dBuV) + Correction Factor (dB/m).
  2. Correction Factor (dB/m) = Antenna Factor (dB/m) + Cable Factor (dB).
  3. The other emission levels were very low against the limit.
  4. Margin value = Emission level – Limit value.
  5. “ \* “: Fundamental frequency.



A D T

RESTRICTED BANDEDGE (802.11g MODE, CH1, HORIZONTAL )

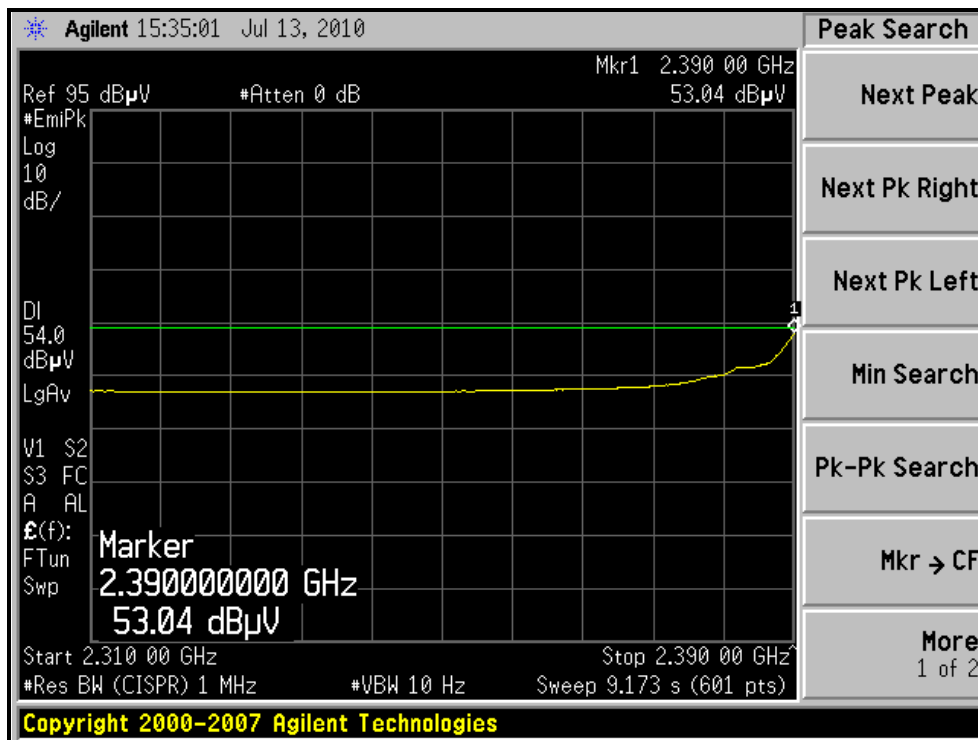
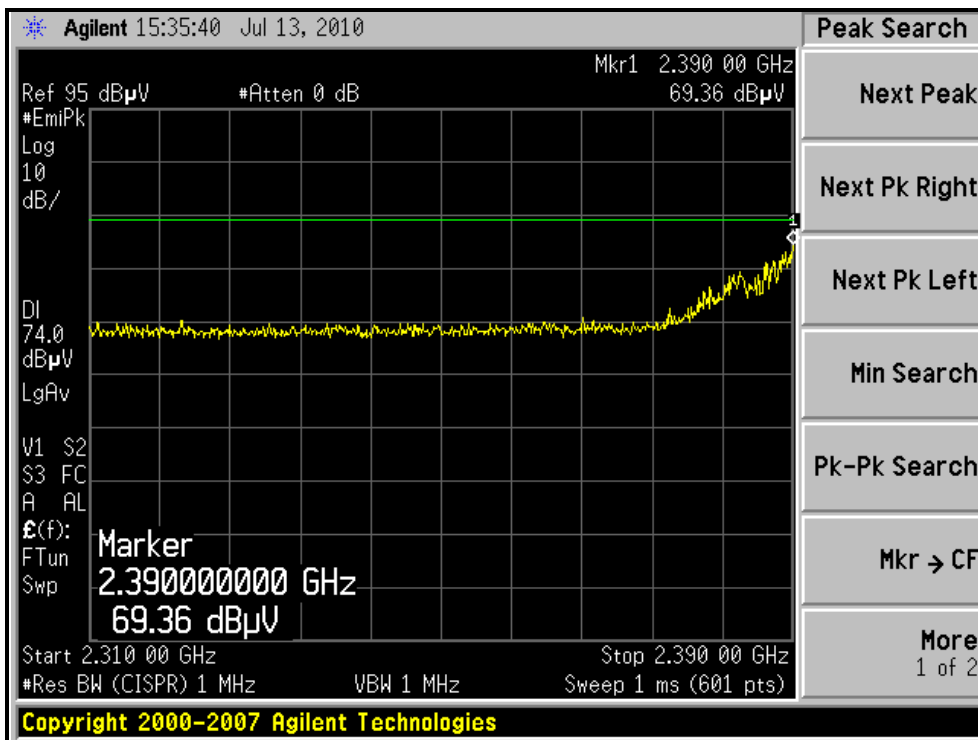



A D T

RESTRICTED BANDEDGE (802.11g MODE, CH1, VERTICAL )

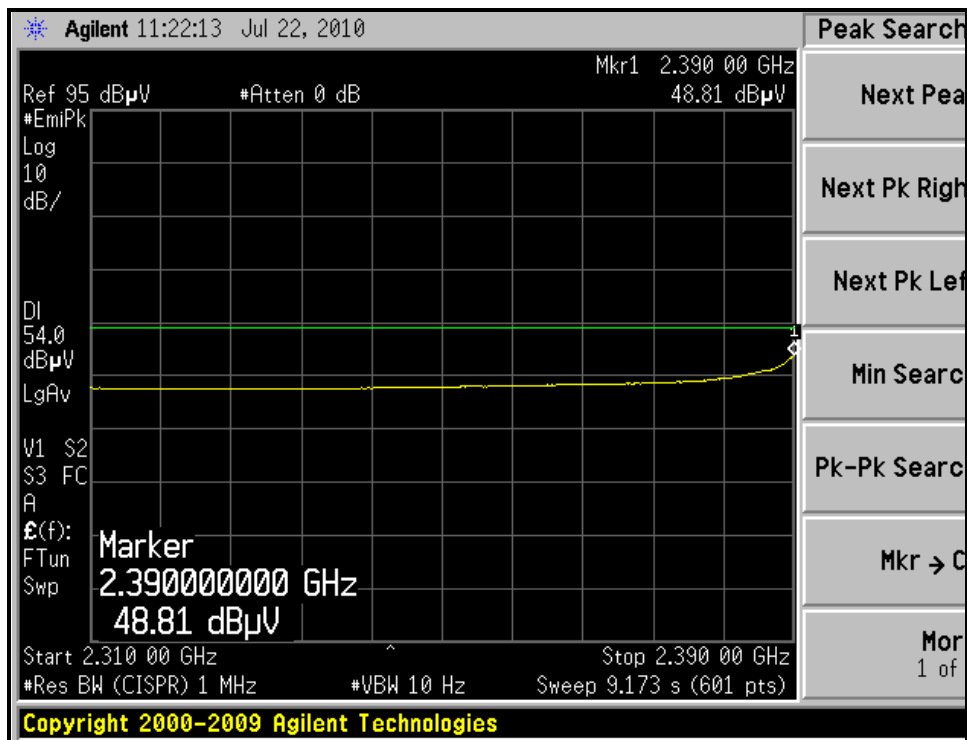
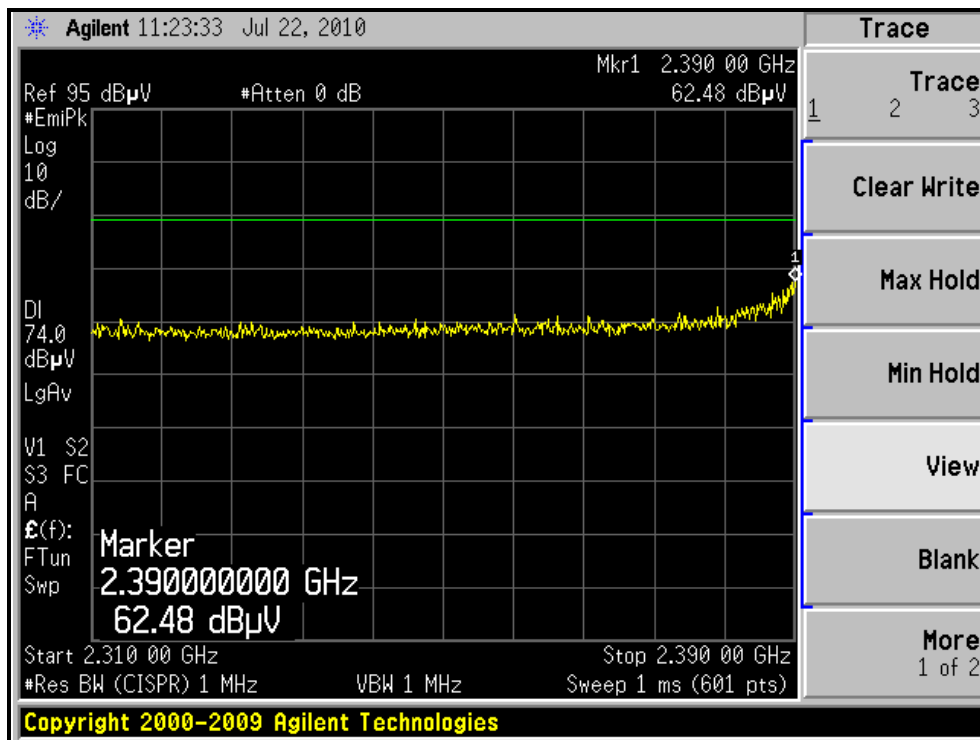



A D T

RESTRICTED BANDEDGE (802.11g MODE, CH11, HORIZONTAL )

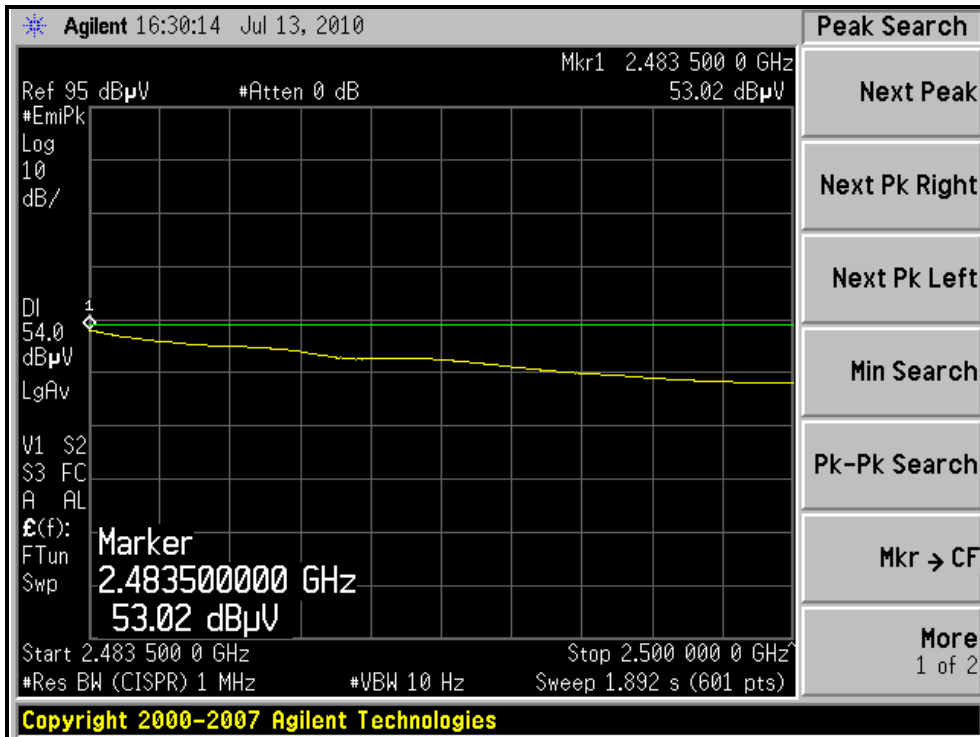
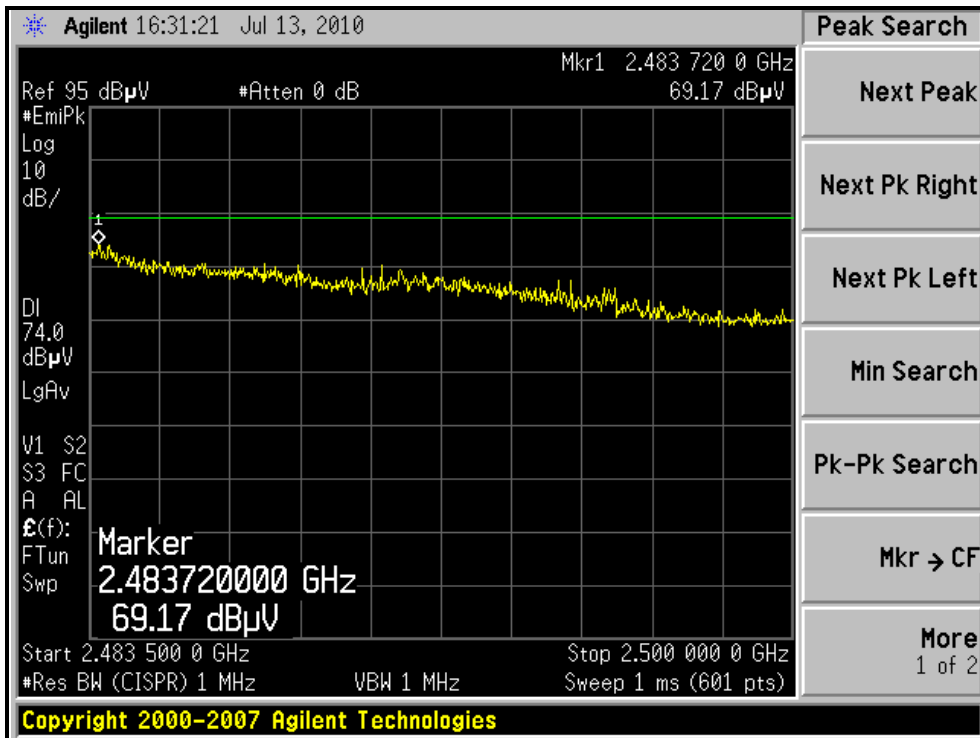



A D T

RESTRICTED BANDEDGE (802.11g MODE,CH11, VERTICAL )

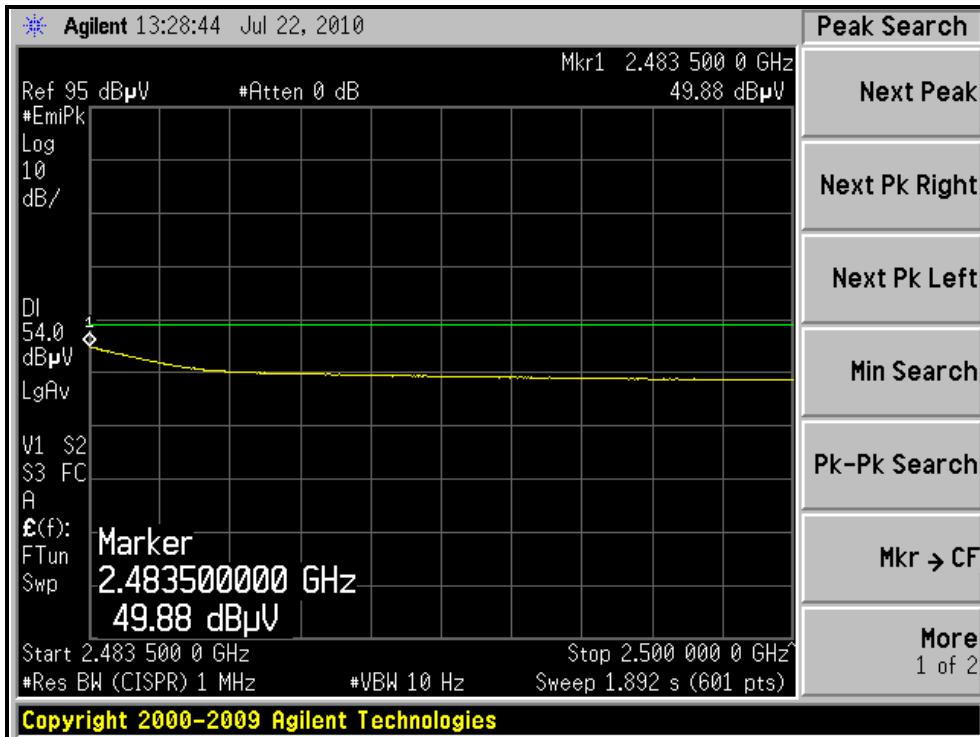
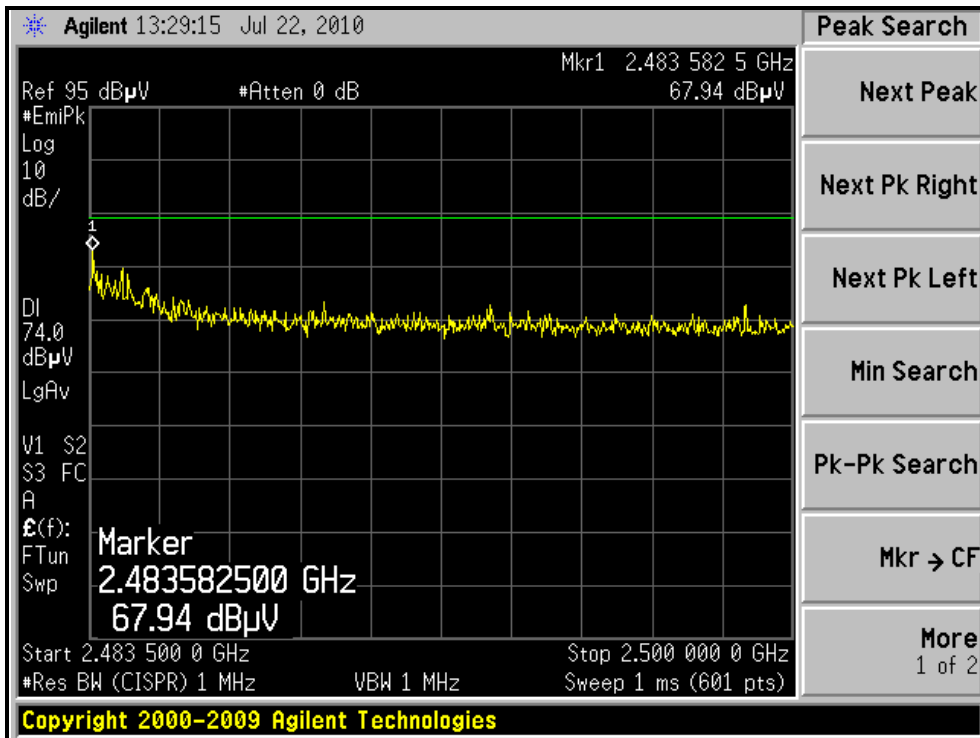



A D T

802.11n (20MHz) OFDM MODULATION

EUT TEST CONDITION		MEASUREMENT DETAIL	
CHANNEL	Channel 1	FREQUENCY RANGE	1 ~ 25GHz
INPUT POWER (SYSTEM)	120Vac, 60 Hz	DETECTOR FUNCTION	Peak (PK) Average (AV)
ENVIRONMENTAL CONDITIONS	28deg. C, 74%RH 1013 hPa	TESTED BY	Rex Huang

ANTENNA POLARITY & TEST DISTANCE: HORIZONTAL AT 3 M

NO.	FREQ. (MHz)	EMISSION LEVEL (dBuV/m)	LIMIT (dBuV/m)	MARGIN (dB)	ANTENNA HEIGHT (m)	TABLE ANGLE (Degree)	RAW VALUE (dBuV)	CORRECTION FACTOR (dB/m)
1	2390.00	70.1 PK	74.0	-3.9	1.77 H	360	38.89	31.21
2	2390.00	52.0 AV	54.0	-2.0	1.77 H	360	20.79	31.21
3	*2412.00	104.7 PK			1.76 H	306	73.43	31.27
4	*2412.00	94.3 AV			1.76 H	306	63.03	31.27
5	4824.00	48.1 PK	74.0	-25.9	1.66 H	50	8.68	39.42
6	4824.00	38.2 AV	54.0	-15.8	1.66 H	50	-1.22	39.42

ANTENNA POLARITY & TEST DISTANCE: VERTICAL AT 3 M

NO.	FREQ. (MHz)	EMISSION LEVEL (dBuV/m)	LIMIT (dBuV/m)	MARGIN (dB)	ANTENNA HEIGHT (m)	TABLE ANGLE (Degree)	RAW VALUE (dBuV)	CORRECTION FACTOR (dB/m)
1	2390.00	66.2 PK	74.0	-7.8	1.21 V	60	34.99	31.21
2	2390.00	48.9 AV	54.0	-5.1	1.21 V	60	17.69	31.21
3	*2412.00	98.2 PK			1.22 V	55	66.93	31.27
4	*2412.00	88.0 AV			1.22 V	55	56.73	31.27
5	4824.00	52.6 PK	74.0	-21.4	1.44 V	171	13.18	39.42
6	4824.00	41.9 AV	54.0	-12.1	1.44 V	171	2.48	39.42

- REMARKS:**
1. Emission level (dBuV/m) = Raw Value (dBuV) + Correction Factor (dB/m).
  2. Correction Factor (dB/m) = Antenna Factor (dB/m) + Cable Factor (dB).
  3. The other emission levels were very low against the limit.
  4. Margin value = Emission level – Limit value.
  5. “ \* “: Fundamental frequency.





A D T

EUT TEST CONDITION		MEASUREMENT DETAIL	
CHANNEL	Channel 6	FREQUENCY RANGE	1 ~ 25GHz
INPUT POWER (SYSTEM)	120Vac, 60 Hz	DETECTOR FUNCTION	Peak (PK) Average (AV)
ENVIRONMENTAL CONDITIONS	28deg. C, 74%RH 1013 hPa	TESTED BY	Rex Huang

ANTENNA POLARITY & TEST DISTANCE: HORIZONTAL AT 3 M								
NO.	FREQ. (MHz)	EMISSION LEVEL (dBuV/m)	LIMIT (dBuV/m)	MARGIN (dB)	ANTENNA HEIGHT (m)	TABLE ANGLE (Degree)	RAW VALUE (dBuV)	CORRECTION FACTOR (dB/m)
1	*2437.00	111.5 PK			1.71 H	306	80.16	31.34
2	*2437.00	101.1 AV			1.71 H	306	69.76	31.34
3	4874.00	60.4 PK	74.0	-13.6	1.69 H	246	20.78	39.62
4	4874.00	46.3 AV	54.0	-7.7	1.69 H	246	6.68	39.62
5	7311.00	51.9 PK	74.0	-22.1	1.43 H	22	7.80	44.10
6	7311.00	38.1 AV	54.0	-15.9	1.43 H	22	-6.00	44.10
ANTENNA POLARITY & TEST DISTANCE: VERTICAL AT 3 M								
NO.	FREQ. (MHz)	EMISSION LEVEL (dBuV/m)	LIMIT (dBuV/m)	MARGIN (dB)	ANTENNA HEIGHT (m)	TABLE ANGLE (Degree)	RAW VALUE (dBuV)	CORRECTION FACTOR (dB/m)
1	*2437.00	105.8 PK			1.28 V	60	74.46	31.34
2	*2437.00	95.4 AV			1.28 V	60	64.06	31.34
3	4874.00	64.6 PK	74.0	-9.4	1.14 V	68	24.98	39.62
4	4874.00	49.1 AV	54.0	-4.9	1.14 V	68	9.48	39.62
5	7311.00	53.4 PK	74.0	-20.6	1.20 V	158	9.30	44.10
6	7311.00	39.9 AV	54.0	-14.1	1.20 V	158	-4.20	44.10

- REMARKS:**
1. Emission level (dBuV/m) = Raw Value (dBuV) + Correction Factor (dB/m).
  2. Correction Factor (dB/m) = Antenna Factor (dB/m) + Cable Factor (dB).
  3. The other emission levels were very low against the limit.
  4. Margin value = Emission level – Limit value.
  5. “ \* “: Fundamental frequency.



A D T

EUT TEST CONDITION		MEASUREMENT DETAIL	
CHANNEL	Channel 11	FREQUENCY RANGE	1 ~ 25GHz
INPUT POWER (SYSTEM)	120Vac, 60 Hz	DETECTOR FUNCTION	Peak (PK) Average (AV)
ENVIRONMENTAL CONDITIONS	28deg. C, 74%RH 1013 hPa	TESTED BY	Rex Huang

**ANTENNA POLARITY & TEST DISTANCE: HORIZONTAL AT 3 M**

NO.	FREQ. (MHz)	EMISSION LEVEL (dBuV/m)	LIMIT (dBuV/m)	MARGIN (dB)	ANTENNA HEIGHT (m)	TABLE ANGLE (Degree)	RAW VALUE (dBuV)	CORRECTION FACTOR (dB/m)
1	*2462.00	105.9 PK			1.71 H	307	74.50	31.40
2	*2462.00	95.1 AV			1.71 H	307	63.70	31.40
3	2483.50	71.5 PK	74.0	-2.5	1.70 H	311	40.04	31.46
4	<b>2483.50</b>	<b>53.3 AV</b>	<b>54.0</b>	<b>-0.7</b>	<b>1.70 H</b>	<b>311</b>	<b>21.84</b>	<b>31.46</b>
5	4924.00	49.2 PK	74.0	-24.8	1.29 H	68	9.38	39.82
6	4924.00	38.5 AV	54.0	-15.5	1.29 H	68	-1.32	39.82
7	7386.00	51.4 PK	74.0	-22.6	1.40 H	311	7.22	44.18
8	7386.00	38.6 AV	54.0	-15.4	1.40 H	311	-5.58	44.18

**ANTENNA POLARITY & TEST DISTANCE: VERTICAL AT 3 M**

NO.	FREQ. (MHz)	EMISSION LEVEL (dBuV/m)	LIMIT (dBuV/m)	MARGIN (dB)	ANTENNA HEIGHT (m)	TABLE ANGLE (Degree)	RAW VALUE (dBuV)	CORRECTION FACTOR (dB/m)
1	*2462.00	98.9 PK			1.19 V	53	67.50	31.40
2	*2462.00	89.3 AV			1.19 V	53	57.90	31.40
3	2483.50	69.5 PK	74.0	-4.5	1.20 V	80	38.04	31.46
4	2483.50	49.0 AV	54.0	-5.0	1.20 V	80	17.54	31.46
5	4924.00	53.1 PK	74.0	-20.9	1.50 V	200	13.28	39.82
6	4924.00	42.6 AV	54.0	-11.4	1.50 V	200	2.78	39.82
7	7386.00	54.2 PK	74.0	-19.8	1.40 V	307	10.02	44.18
8	7386.00	39.6 AV	54.0	-14.4	1.40 V	307	-4.58	44.18

- REMARKS:**
1. Emission level (dBuV/m) = Raw Value (dBuV) + Correction Factor (dB/m).
  2. Correction Factor (dB/m) = Antenna Factor (dB/m) + Cable Factor (dB).
  3. The other emission levels were very low against the limit.
  4. Margin value = Emission level – Limit value.
  5. “ \* “: Fundamental frequency.



A D T

RESTRICTED BANDEDGE (802.11n (20MHz) MODE,CH1, HORIZONTAL )

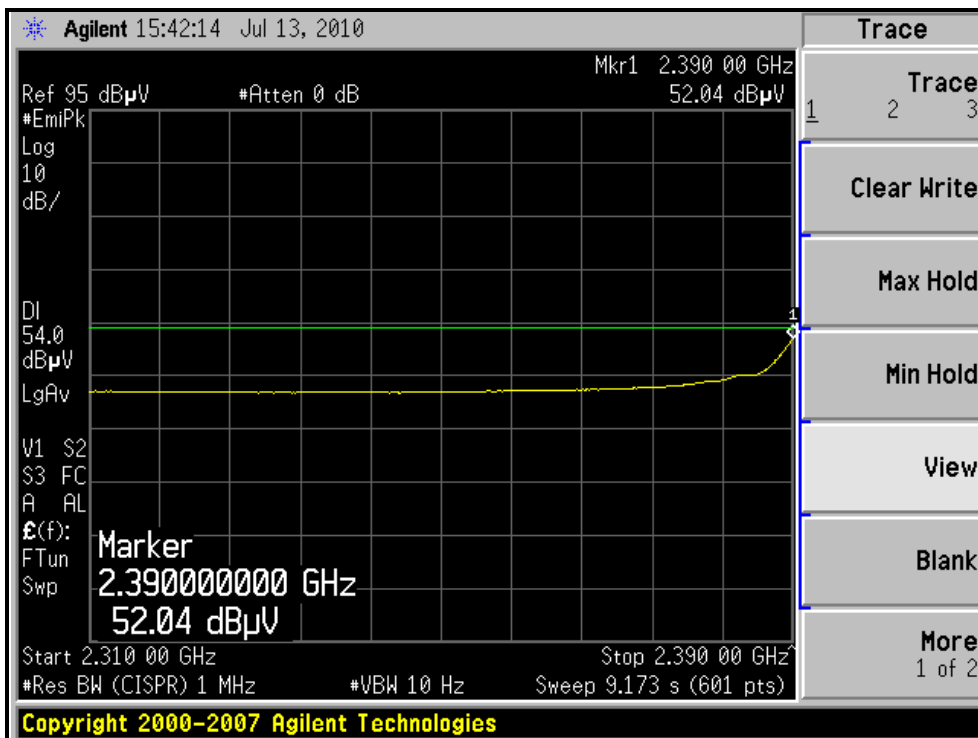
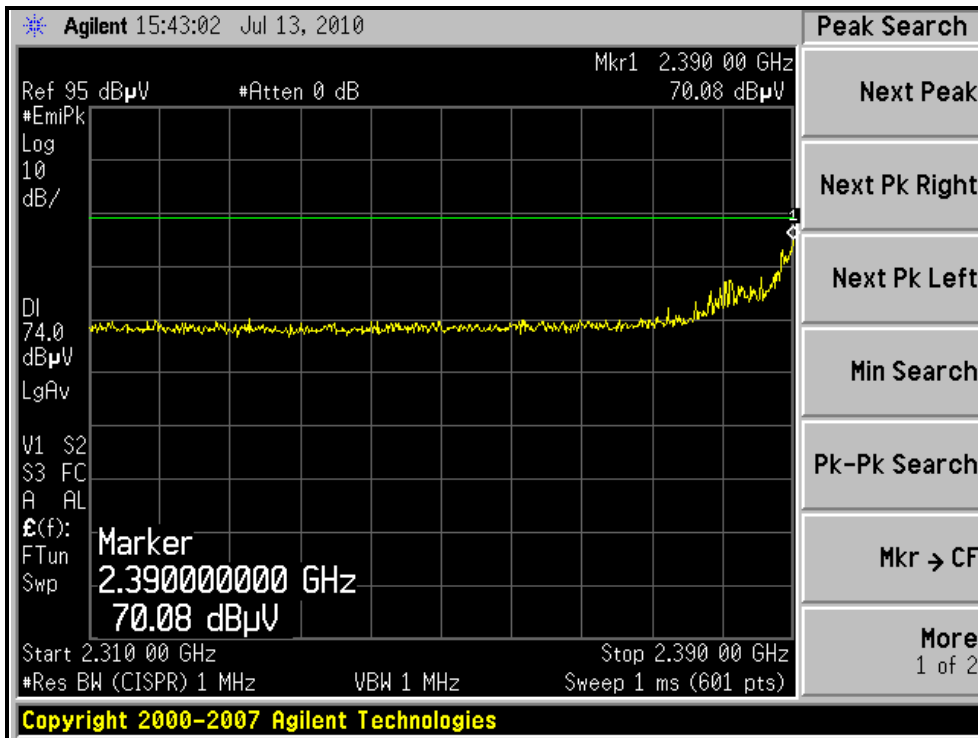



A D T

RESTRICTED BANDEDGE (802.11n (20MHz) MODE,CH1, VERTICAL )

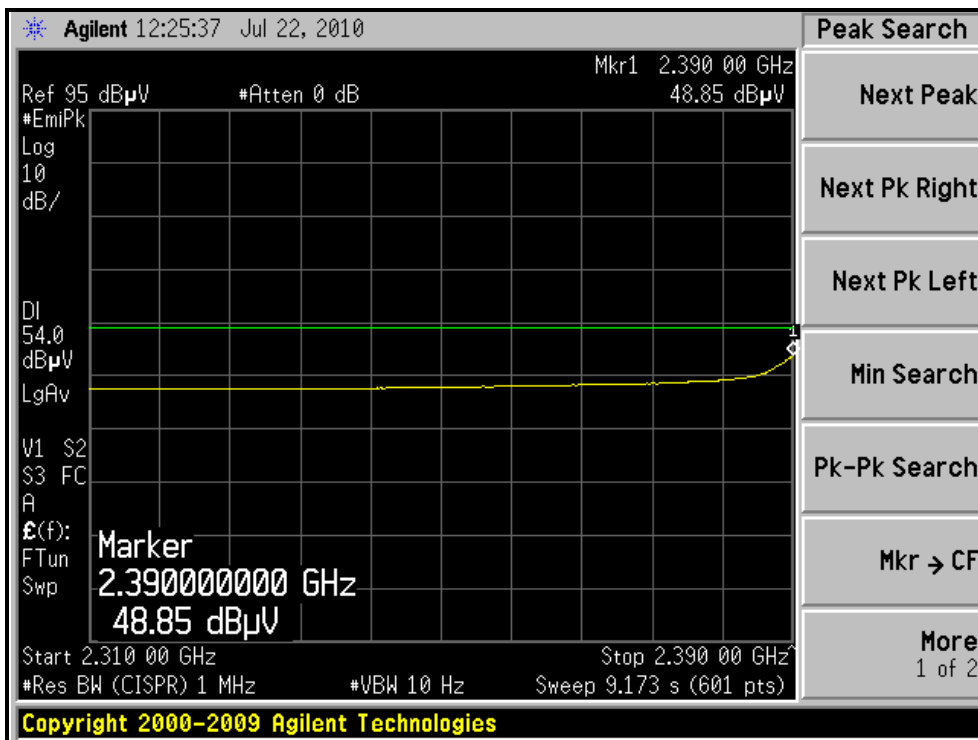
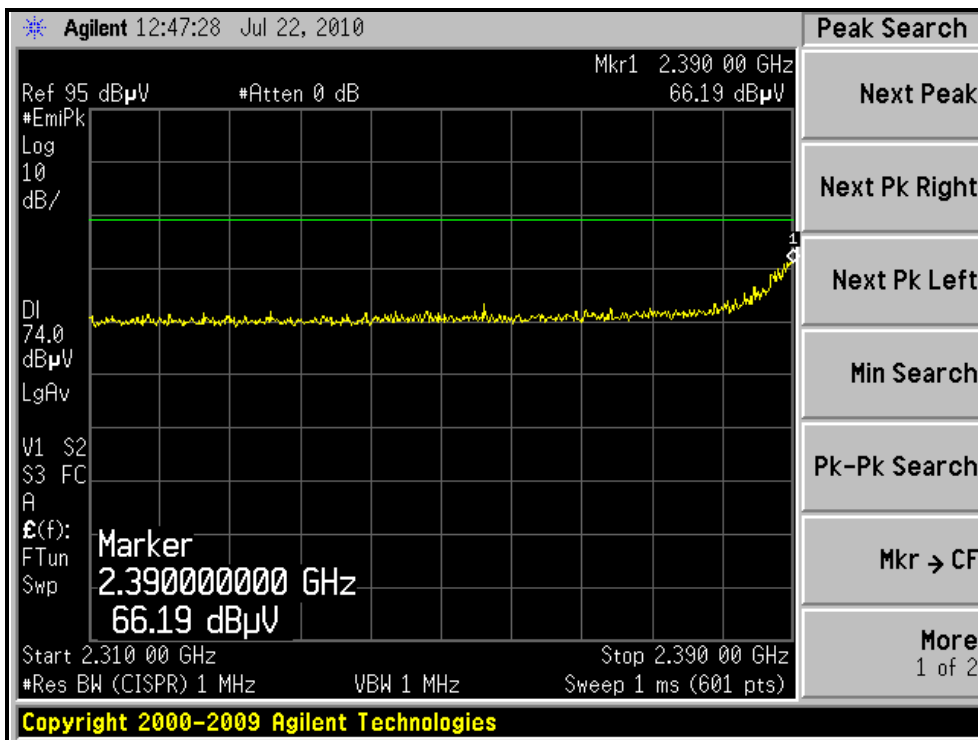



A D T

RESTRICTED BANDEDGE (802.11n (20MHz) MODE,CH11, HORIZONTAL )

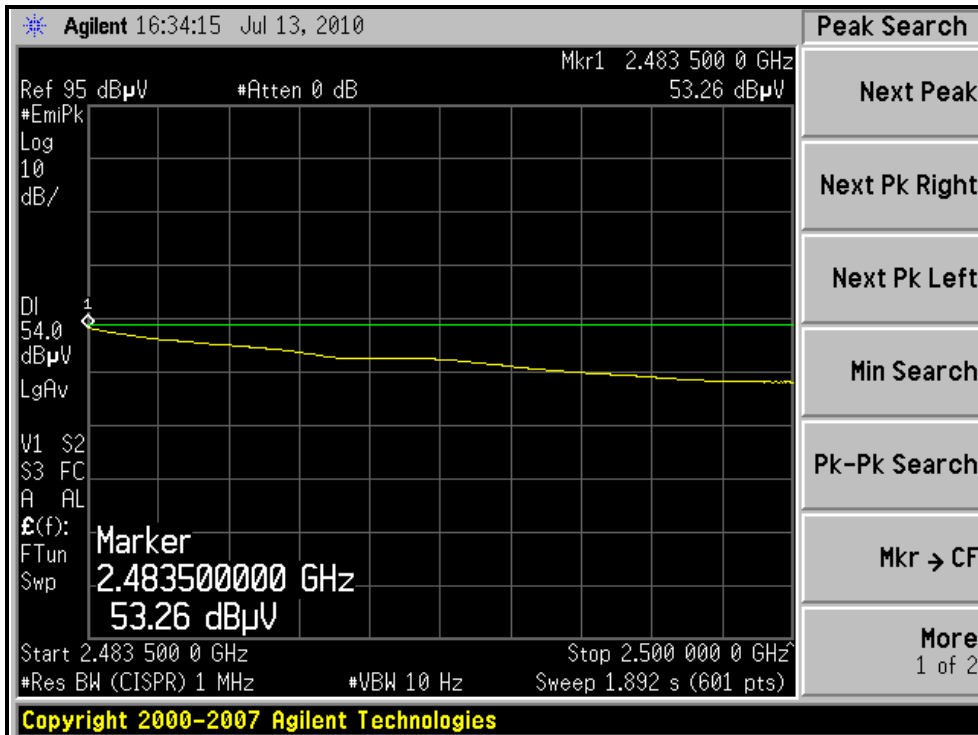
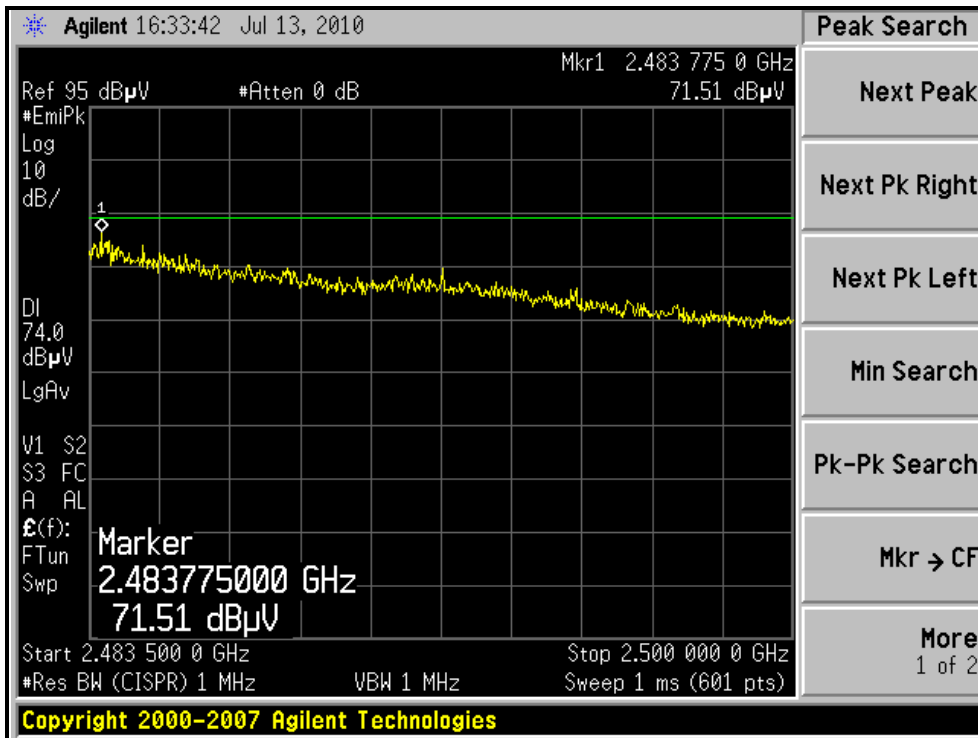



A D T

RESTRICTED BANDEDGE (802.11n (20MHz) MODE,CH11, VERTICAL )

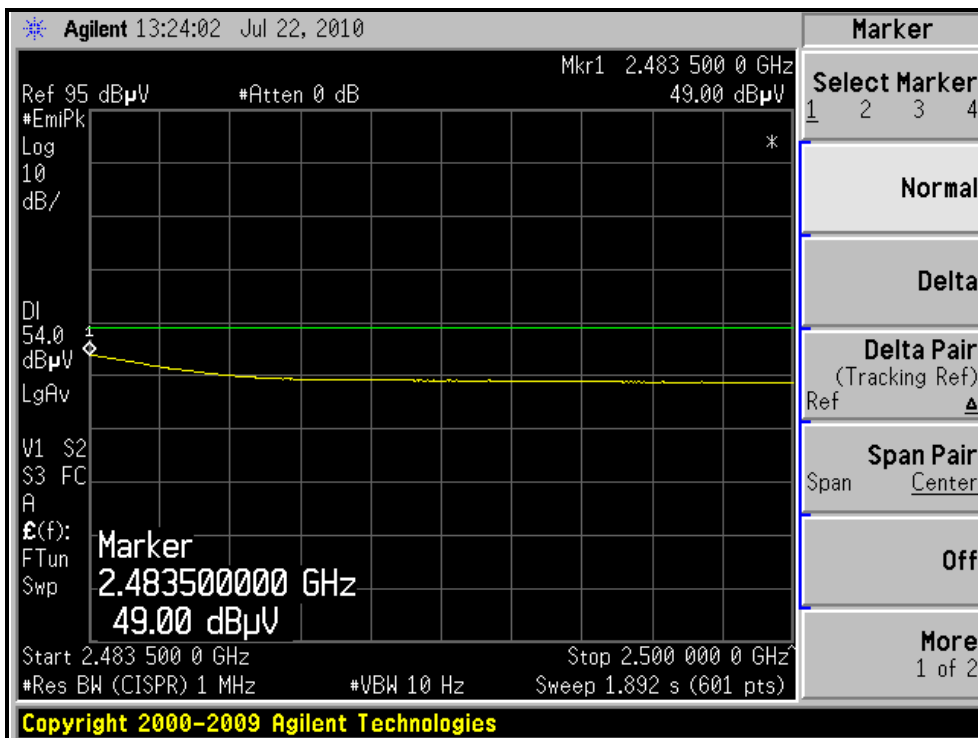
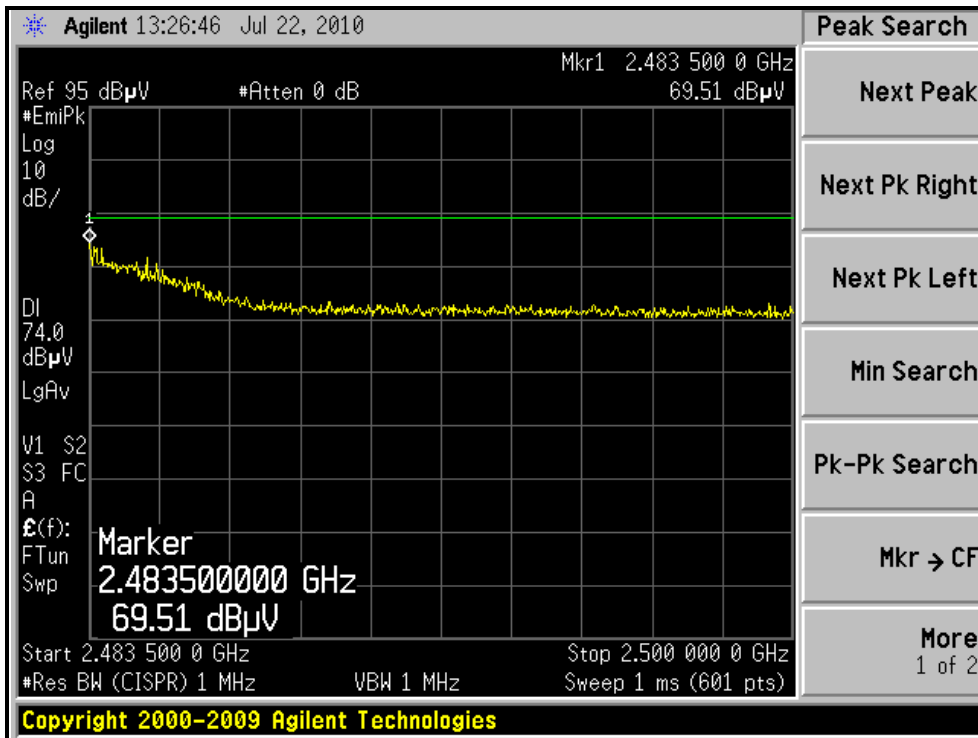



A D T

## 4.2.8 TEST RESULTS (FOR RECEIVER PART)

## BELOW 1GHz WORST-CASE DATA :

EUT TEST CONDITION		MEASUREMENT DETAIL	
CHANNEL	Channel 6	FREQUENCY RANGE	Below 1000MHz
INPUT POWER (SYSTEM)	120Vac, 60 Hz	DETECTOR FUNCTION	Quasi-Peak
ENVIRONMENTAL CONDITIONS	24deg. C, 70%RH 1013 hPa	TESTED BY	Eric Lee

ANTENNA POLARITY & TEST DISTANCE: HORIZONTAL AT 3 M								
NO.	FREQ. (MHz)	EMISSION LEVEL (dBuV/m)	LIMIT (dBuV/m)	MARGIN (dB)	ANTENNA HEIGHT (m)	TABLE ANGLE (Degree)	RAW VALUE (dBuV)	CORRECTION FACTOR (dB/m)
1	99.65	33.7 QP	43.5	-9.8	1.75 H	360	23.75	9.95
2	116.50	35.4 QP	43.5	-8.1	1.50 H	358	23.11	12.29
3	133.16	33.9 QP	43.5	-9.6	2.25 H	0	20.21	13.69
4	149.90	35.8 QP	43.5	-7.7	1.50 H	360	21.52	14.30
5	166.55	42.0 QP	43.5	-1.5	1.75 H	220	28.00	14.00
6	199.30	37.4 QP	43.5	-6.1	1.25 H	0	26.14	11.26
7	248.96	39.8 QP	46.0	-6.2	1.25 H	281	26.91	12.91
ANTENNA POLARITY & TEST DISTANCE: VERTICAL AT 3 M								
NO.	FREQ. (MHz)	EMISSION LEVEL (dBuV/m)	LIMIT (dBuV/m)	MARGIN (dB)	ANTENNA HEIGHT (m)	TABLE ANGLE (Degree)	RAW VALUE (dBuV)	CORRECTION FACTOR (dB/m)
1	33.50	37.8 QP	40.0	-2.2	1.00 V	291	24.32	13.46
2	99.80	26.8 QP	43.5	-16.7	1.00 V	28	16.85	9.95
3	149.86	33.6 QP	43.5	-9.9	1.25 V	360	19.30	14.30
4	166.05	34.4 QP	43.5	-9.1	2.25 V	312	20.38	14.02
5	248.82	33.3 QP	46.0	-12.7	1.00 V	217	20.39	12.91
6	365.25	31.0 QP	46.0	-15.0	1.75 V	360	14.12	16.88

- REMARKS:**
1. Emission level (dBuV/m) = Raw Value (dBuV) + Correction Factor (dB/m).
  2. Correction Factor (dB/m) = Antenna Factor (dB/m) + Cable Factor (dB).
  3. The other emission levels were very low against the limit.
  4. Margin value = Emission level – Limit value.



A D T

**ABOVE 1GHz WORST-CASE DATA**

EUT TEST CONDITION		MEASUREMENT DETAIL	
CHANNEL	Channel 1	FREQUENCY RANGE	1 ~ 7.5GHz
INPUT POWER (SYSTEM)	120Vac, 60 Hz	DETECTOR FUNCTION	Peak (PK) Average (AV)
ENVIRONMENTAL CONDITIONS	25deg. C, 70%RH 1013 hPa	TESTED BY	Rex Huang

**ANTENNA POLARITY & TEST DISTANCE: HORIZONTAL AT 3 M**

NO.	FREQ. (MHz)	EMISSION LEVEL (dBuV/m)	LIMIT (dBuV/m)	MARGIN (dB)	ANTENNA HEIGHT (m)	TABLE ANGLE (Degree)	RAW VALUE (dBuV)	CORRECTION FACTOR (dB/m)
1	3216.00	57.6 PK	74.0	-16.4	1.00 H	12	24.24	33.36
2	3216.00	50.7 AV	54.0	-3.3	1.00 H	12	17.34	33.36
3	6432.00	55.2 PK	74.0	-18.8	1.03 H	29	12.95	42.25
4	6432.00	45.4 AV	54.0	-8.6	1.03 H	29	3.15	42.25

**ANTENNA POLARITY & TEST DISTANCE: VERTICAL AT 3 M**

NO.	FREQ. (MHz)	EMISSION LEVEL (dBuV/m)	LIMIT (dBuV/m)	MARGIN (dB)	ANTENNA HEIGHT (m)	TABLE ANGLE (Degree)	RAW VALUE (dBuV)	CORRECTION FACTOR (dB/m)
1	3216.00	51.8 PK	74.0	-22.2	1.06 V	111	18.44	33.36
2	3216.00	47.6 AV	54.0	-6.4	1.06 V	111	14.24	33.36
3	6432.00	55.0 PK	74.0	-19.0	1.11 V	243	12.75	42.25
4	6432.00	45.3 AV	54.0	-8.7	1.11 V	243	3.05	42.25

- REMARKS:**
1. Emission level (dBuV/m) = Raw Value (dBuV) + Correction Factor (dB/m).
  2. Correction Factor (dB/m) = Antenna Factor (dB/m) + Cable Factor (dB).
  3. The other emission levels were very low against the limit.
  4. Margin value = Emission level – Limit value.





A D T

EUT TEST CONDITION		MEASUREMENT DETAIL	
CHANNEL	Channel 6	FREQUENCY RANGE	1 ~ 7.5GHz
INPUT POWER (SYSTEM)	120Vac, 60 Hz	DETECTOR FUNCTION	Peak (PK) Average (AV)
ENVIRONMENTAL CONDITIONS	25deg. C, 70%RH 1013 hPa	TESTED BY	Rex Huang

ANTENNA POLARITY & TEST DISTANCE: HORIZONTAL AT 3 M								
NO.	FREQ. (MHz)	EMISSION LEVEL (dBuV/m)	LIMIT (dBuV/m)	MARGIN (dB)	ANTENNA HEIGHT (m)	TABLE ANGLE (Degree)	RAW VALUE (dBuV)	CORRECTION FACTOR (dB/m)
1	3249.30	58.2 PK	74.0	-15.8	1.01 H	29	24.74	33.46
2	3249.30	50.9 AV	54.0	-3.1	1.01 H	29	17.44	33.46
3	6498.60	55.4 PK	74.0	-18.6	1.04 H	57	13.06	42.34
4	6498.60	45.5 AV	54.0	-8.5	1.04 H	57	3.16	42.34
ANTENNA POLARITY & TEST DISTANCE: VERTICAL AT 3 M								
NO.	FREQ. (MHz)	EMISSION LEVEL (dBuV/m)	LIMIT (dBuV/m)	MARGIN (dB)	ANTENNA HEIGHT (m)	TABLE ANGLE (Degree)	RAW VALUE (dBuV)	CORRECTION FACTOR (dB/m)
1	3249.30	52.1 PK	74.0	-21.9	1.07 V	109	18.64	33.46
2	3249.30	48.1 AV	54.0	-5.9	1.07 V	109	14.64	33.46
3	6498.60	55.2 PK	74.0	-18.8	1.13 V	249	12.86	42.34
4	6498.60	45.6 AV	54.0	-8.4	1.13 V	249	3.26	42.34

- REMARKS:**
1. Emission level (dBuV/m) = Raw Value (dBuV) + Correction Factor (dB/m).
  2. Correction Factor (dB/m) = Antenna Factor (dB/m) + Cable Factor (dB).
  3. The other emission levels were very low against the limit.
  4. Margin value = Emission level – Limit value.



A D T

EUT TEST CONDITION		MEASUREMENT DETAIL	
CHANNEL	Channel 11	FREQUENCY RANGE	1 ~ 7.5GHz
INPUT POWER (SYSTEM)	120Vac, 60 Hz	DETECTOR FUNCTION	Peak (PK) Average (AV)
ENVIRONMENTAL CONDITIONS	25deg. C, 70%RH 1013 hPa	TESTED BY	Rex Huang

ANTENNA POLARITY & TEST DISTANCE: HORIZONTAL AT 3 M								
NO.	FREQ. (MHz)	EMISSION LEVEL (dBuV/m)	LIMIT (dBuV/m)	MARGIN (dB)	ANTENNA HEIGHT (m)	TABLE ANGLE (Degree)	RAW VALUE (dBuV)	CORRECTION FACTOR (dB/m)
1	3282.60	58.4 PK	74.0	-15.6	1.04 H	34	24.85	33.55
2	3282.60	51.4 AV	54.0	-2.6	1.04 H	34	17.85	33.55
3	6565.30	55.9 PK	74.0	-18.1	1.07 H	62	13.36	42.54
4	6565.30	45.6 AV	54.0	-8.4	1.07 H	62	3.06	42.54
ANTENNA POLARITY & TEST DISTANCE: VERTICAL AT 3 M								
NO.	FREQ. (MHz)	EMISSION LEVEL (dBuV/m)	LIMIT (dBuV/m)	MARGIN (dB)	ANTENNA HEIGHT (m)	TABLE ANGLE (Degree)	RAW VALUE (dBuV)	CORRECTION FACTOR (dB/m)
1	3282.60	52.3 PK	74.0	-21.7	1.09 V	107	18.75	33.55
2	3282.60	48.4 AV	54.0	-5.6	1.09 V	107	14.85	33.55
3	6565.30	55.4 PK	74.0	-18.6	1.14 V	248	12.86	42.54
4	6565.30	45.9 AV	54.0	-8.1	1.14 V	248	3.36	42.54

- REMARKS:**
1. Emission level (dBuV/m) = Raw Value (dBuV) + Correction Factor (dB/m).
  2. Correction Factor (dB/m) = Antenna Factor (dB/m) + Cable Factor (dB).
  3. The other emission levels were very low against the limit.
  4. Margin value = Emission level – Limit value.



### 4.3 6dB BANDWIDTH MEASUREMENT

#### 4.3.1 LIMITS OF 6dB BANDWIDTH MEASUREMENT

The minimum of 6dB Bandwidth Measurement is 0.5 MHz.

#### 4.3.2 TEST INSTRUMENTS

DESCRIPTION & MANUFACTURER	MODEL NO.	SERIAL NO.	CALIBRATED DATE	CALIBRATED UNTIL
Spectrum Analyzer	E4446A	MY48250254	Aug. 03, 2009	Aug. 02, 2010

**NOTE:** The calibration interval of the above test instruments is 12 months and the calibrations are traceable to NML/ROC and NIST/USA.

#### 4.3.3 TEST PROCEDURE

The transmitter output was connected to the spectrum analyzer through an attenuator. The bandwidth of the fundamental frequency was measured by spectrum analyzer with 100kHz RBW and 100kHz VBW. The 6dB bandwidth is defined as the total spectrum the power of which is higher than peak power minus 6dB.

#### 4.3.4 DEVIATION FROM TEST STANDARD

No deviation

#### 4.3.5 TEST SETUP

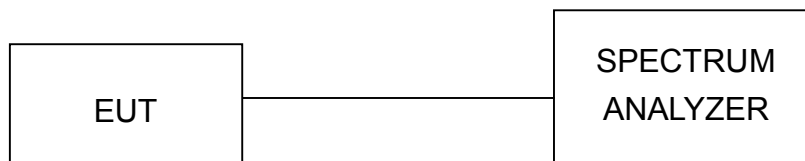

#### 4.3.6 EUT OPERATING CONDITIONS

The software provided by client to enable the EUT under transmission condition continuously at lowest, middle and highest channel frequencies individually.

### 4.3.7 TEST RESULTS

#### 802.11b DSSS MODULATION:

CHANNEL	CHANNEL FREQUENCY (MHz)	6dB BANDWIDTH (MHz)	MINIMUM LIMIT (MHz)	PASS / FAIL
1	2412	10.88	0.5	PASS
6	2437	11.06	0.5	PASS
11	2462	11.08	0.5	PASS

CH1

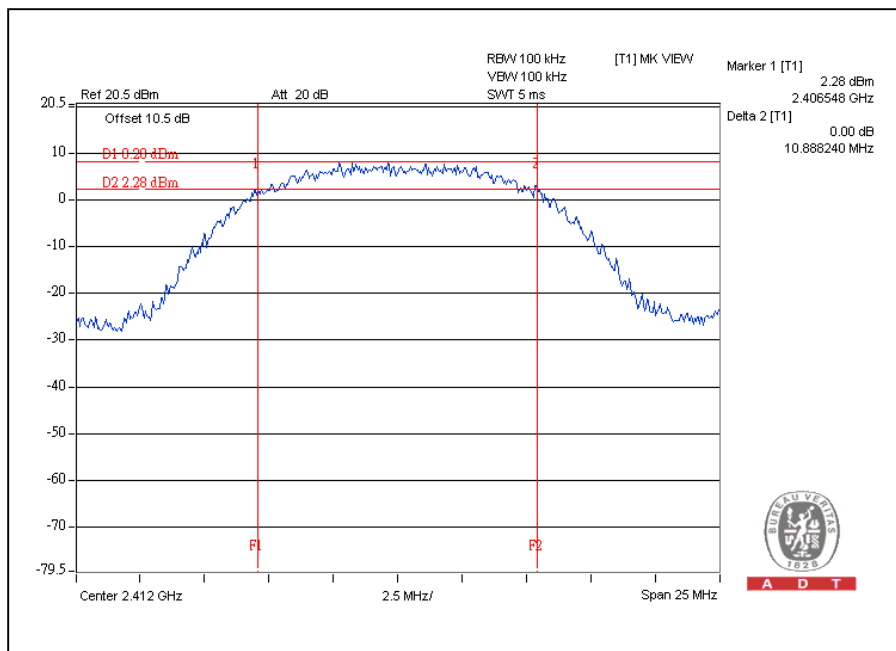



A D T

### CH6

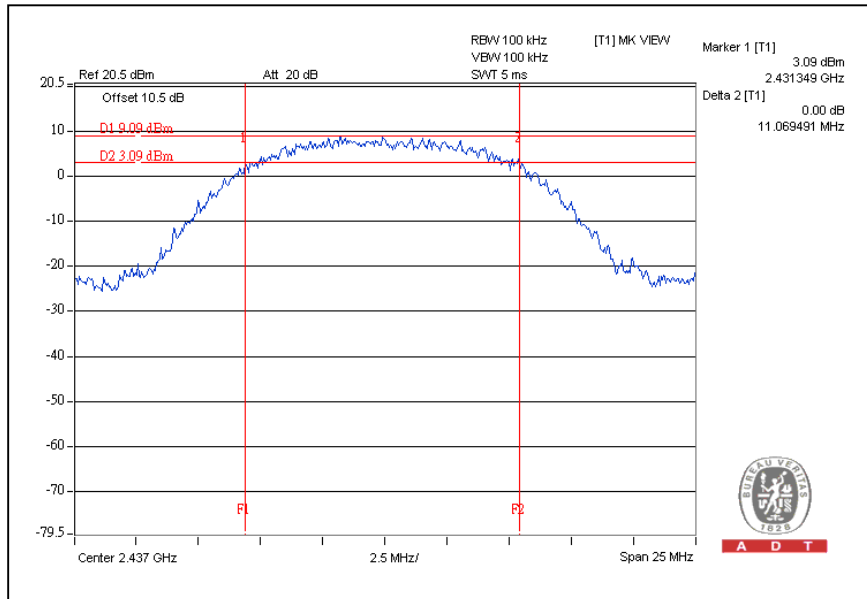

### CH11

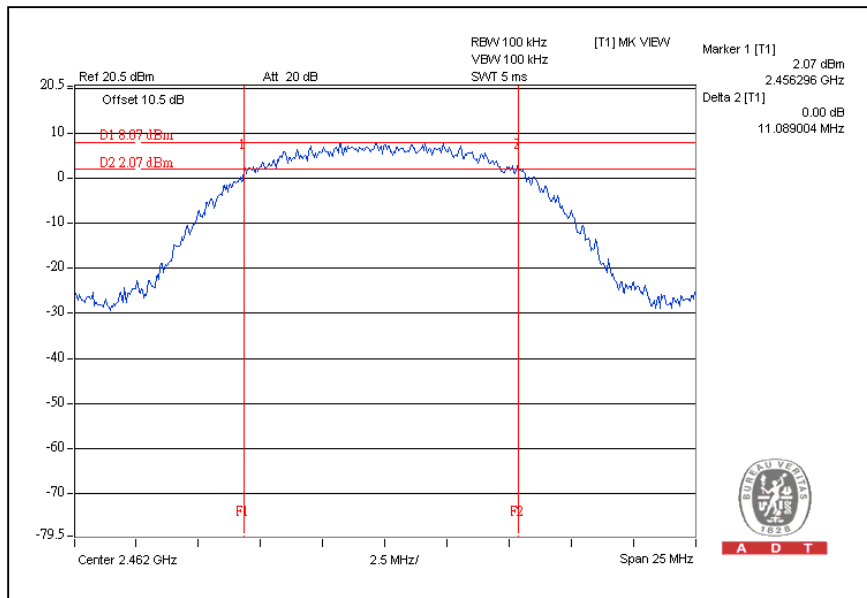



A D T

### 802.11g OFDM MODULATION:

CHANNEL	CHANNEL FREQUENCY (MHz)	6dB BANDWIDTH (MHz)	MINIMUM LIMIT (MHz)	PASS / FAIL
1	2412	16.32	0.5	PASS
6	2437	16.31	0.5	PASS
11	2462	16.33	0.5	PASS

CH1

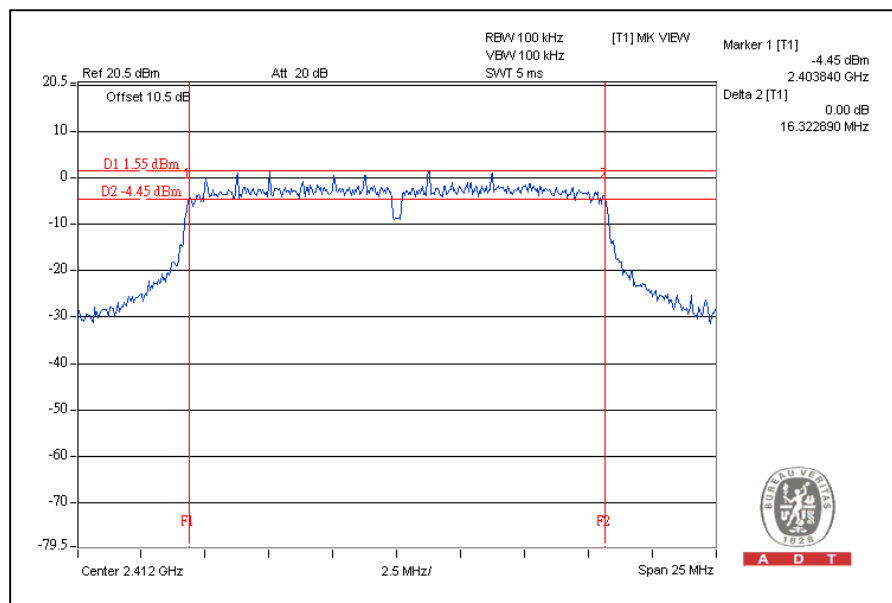



A D T

### CH6

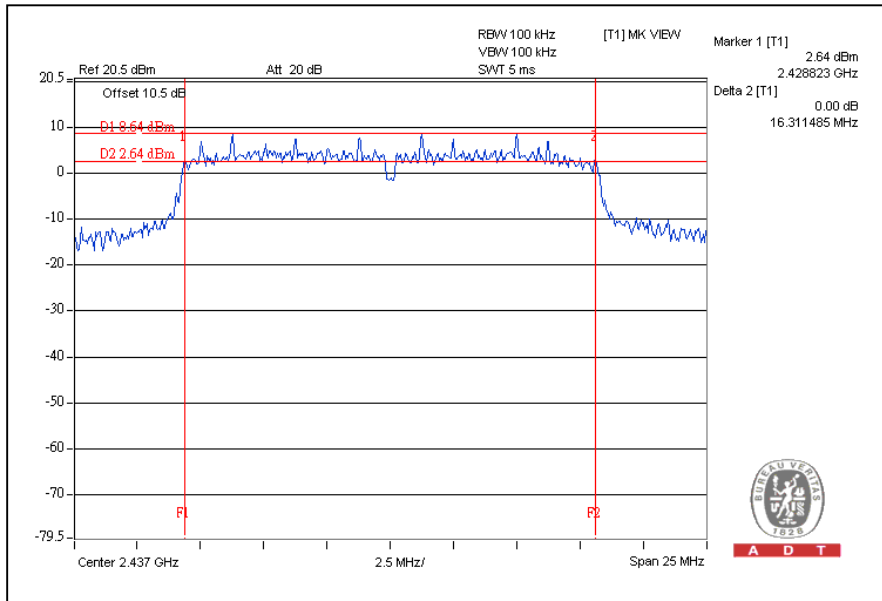

A D T

### CH11

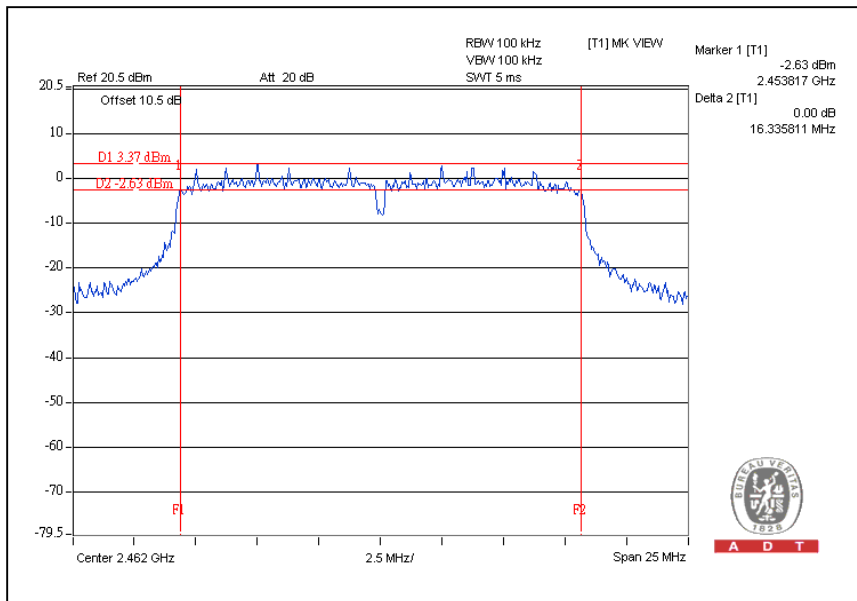

A D T



**802.11n (20MHz) OFDM MODULATION:**

CHANNEL	CHANNEL FREQUENCY (MHz)	6dB BANDWIDTH (MHz)	MINIMUM LIMIT (MHz)	PASS / FAIL
1	2412	16.32	0.5	PASS
6	2437	17.24	0.5	PASS
11	2462	16.73	0.5	PASS

CH1

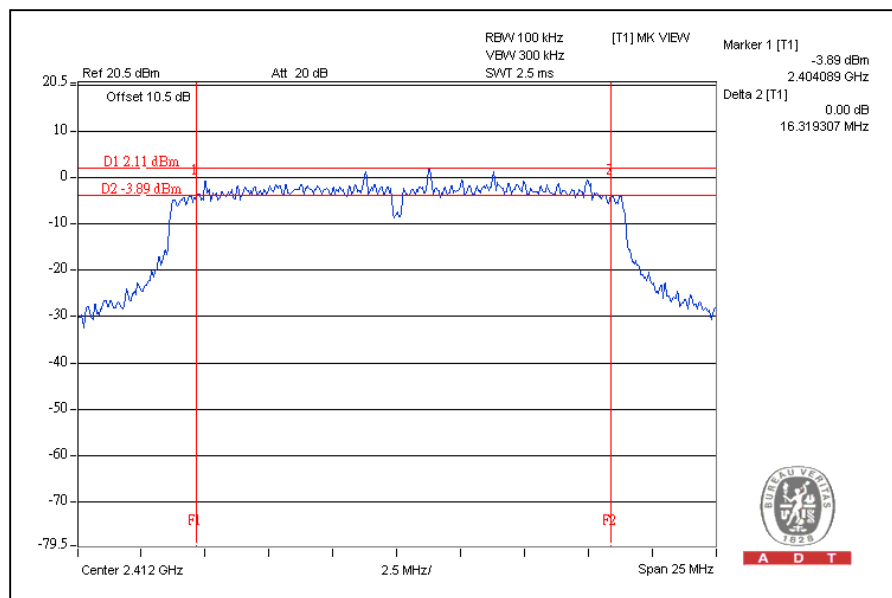



A D T

### CH6

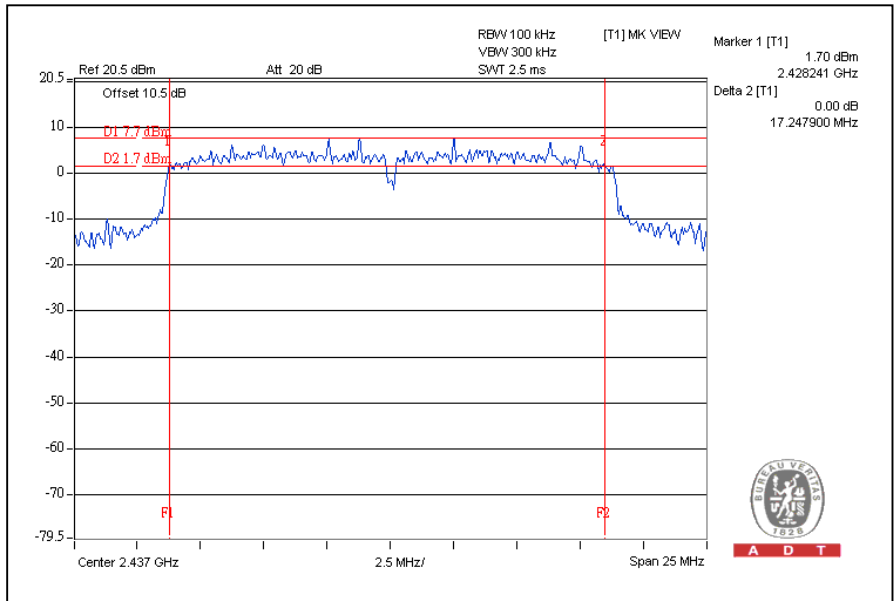

A D T

### CH11

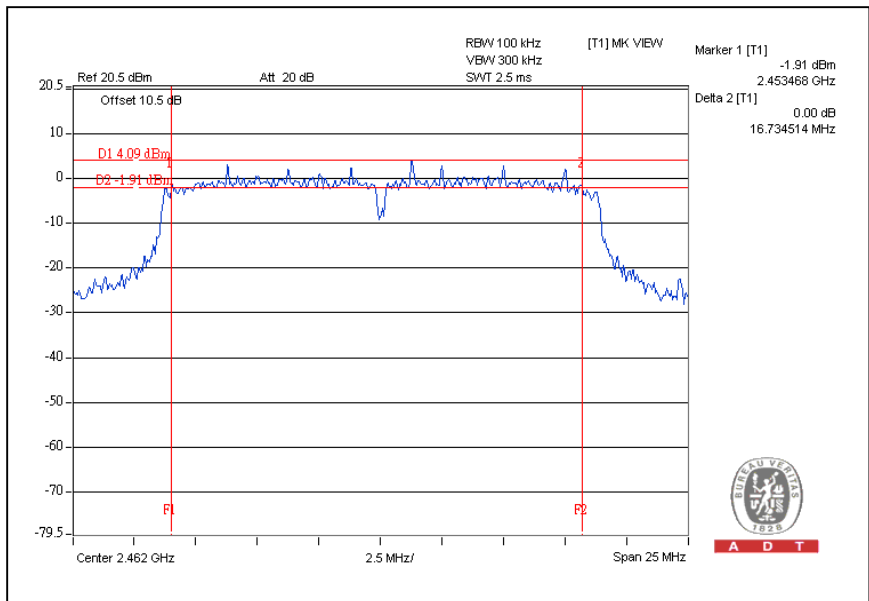

A D T

#### 4.4 99% BANDWIDTH MEASUREMENT

##### 4.4.1 TEST INSTRUMENTS

DESCRIPTION & MANUFACTURER	MODEL NO.	SERIAL NO.	CALIBRATED DATE	CALIBRATED UNTIL
Spectrum Analyzer	E4446A	MY48250254	Aug. 03, 2009	Aug. 02, 2010

**NOTE:** The calibration interval of the above test instruments is 12 months and the calibrations are traceable to NML/ROC and NIST/USA.

##### 4.4.2 TEST PROCEDURE

The transmitter output was connected to the spectrum analyzer through an attenuator. The bandwidth of the fundamental frequency was measured by spectrum analyzer with 100kHz RBW and 100kHz VBW.

##### 4.4.3 TEST SETUP



##### 4.4.4 EUT OPERATING CONDITIONS

The software provided by client to enable the EUT under transmission condition continuously at lowest, middle and highest channel frequencies individually.

### 4.4.5 TEST RESULTS

#### 802.11b DSSS MODULATION:

CHANNEL	CHANNEL FREQUENCY (MHz)	99% BANDWIDTH (MHz)
1	2412	14.5
6	2437	14.7
11	2462	14.0

CH1

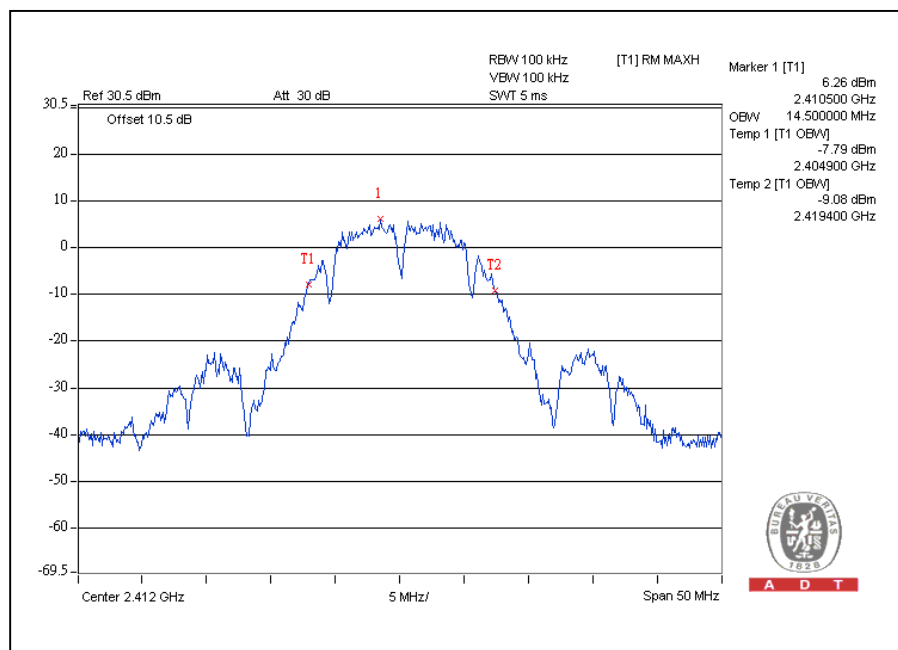

A D T



A D T

### CH6

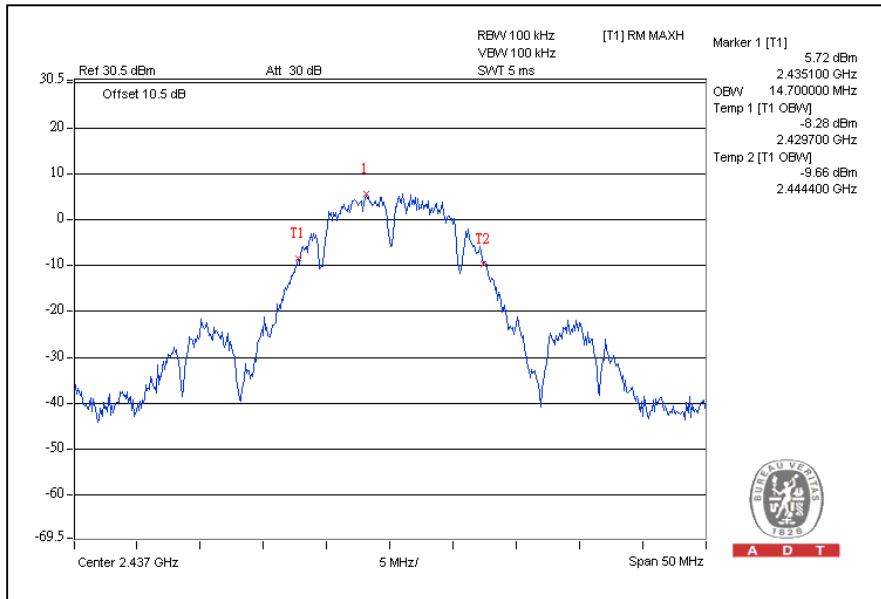

### CH11

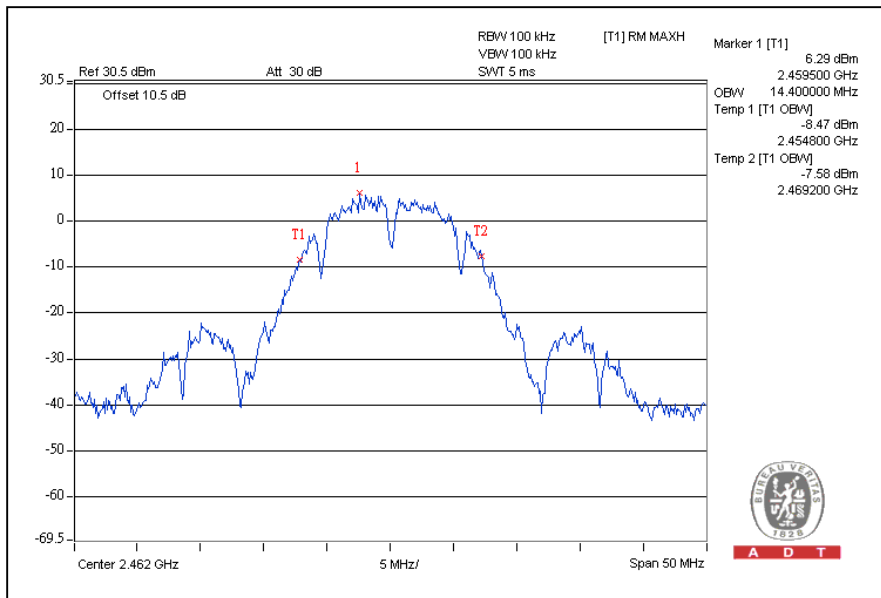

**802.11g OFDM MODULATION:**

CHANNEL	CHANNEL FREQUENCY (MHz)	99% BANDWIDTH (MHz)
1	2412	16.5
6	2437	21.5
11	2462	16.5

**CH1**

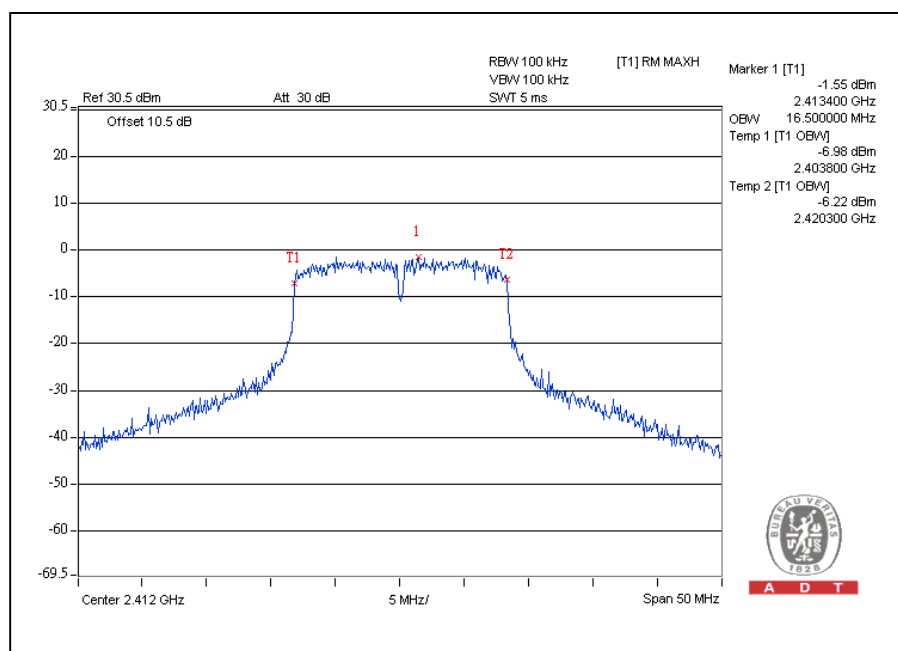



A D T

### CH6

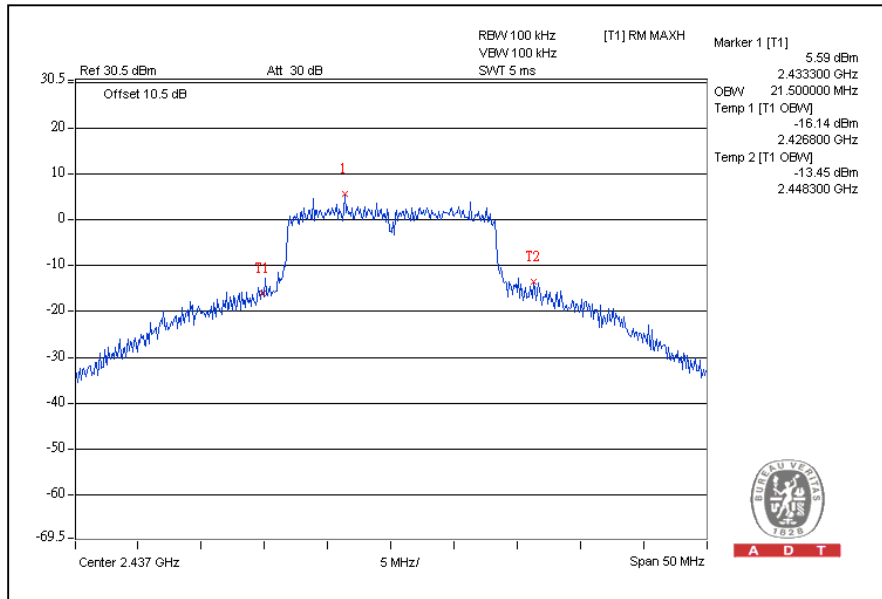

### CH11

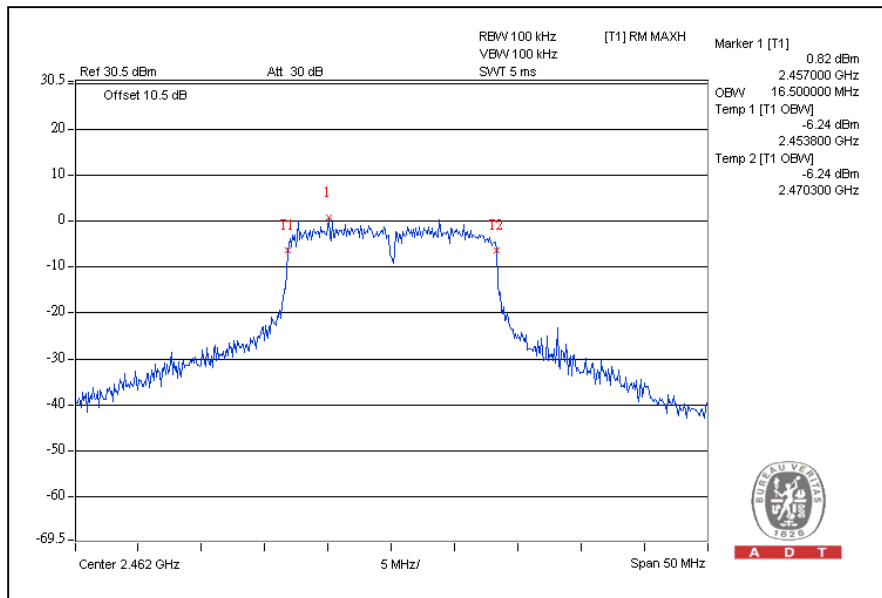

**802.11n (20MHz) OFDM MODULATION:**

CHANNEL	CHANNEL FREQUENCY (MHz)	99% BANDWIDTH (MHz)
1	2412	16.5
6	2437	20.5
11	2462	16.5

CH1

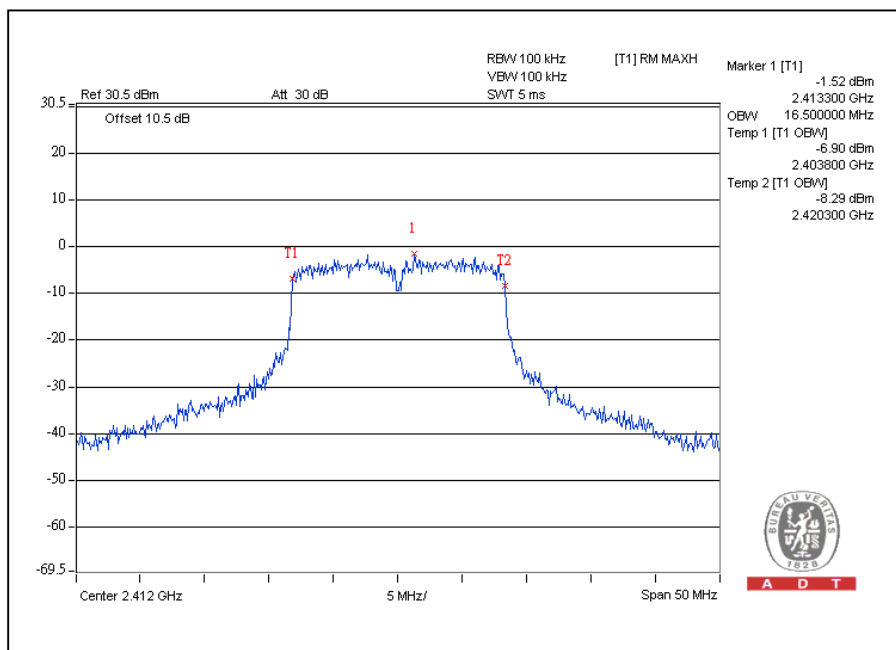





A D T

### CH6

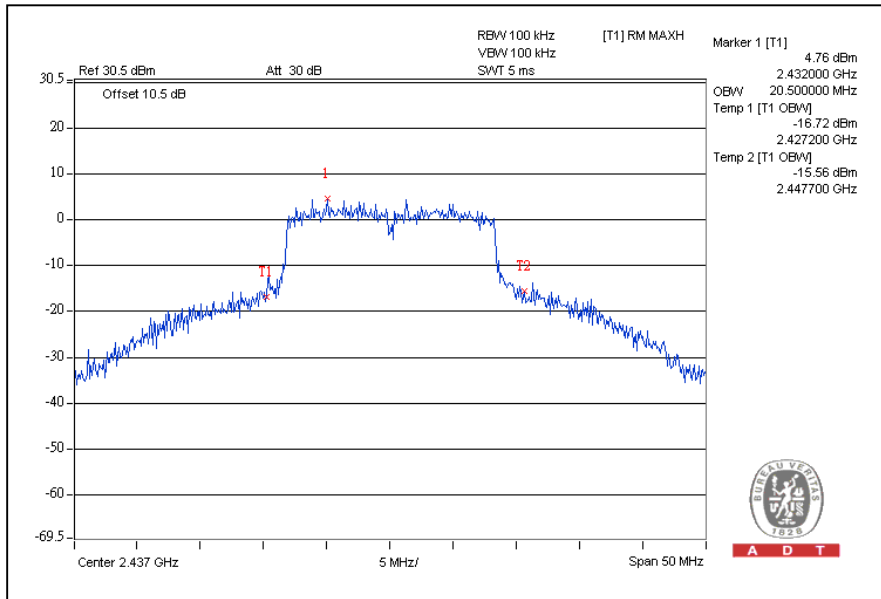

### CH11

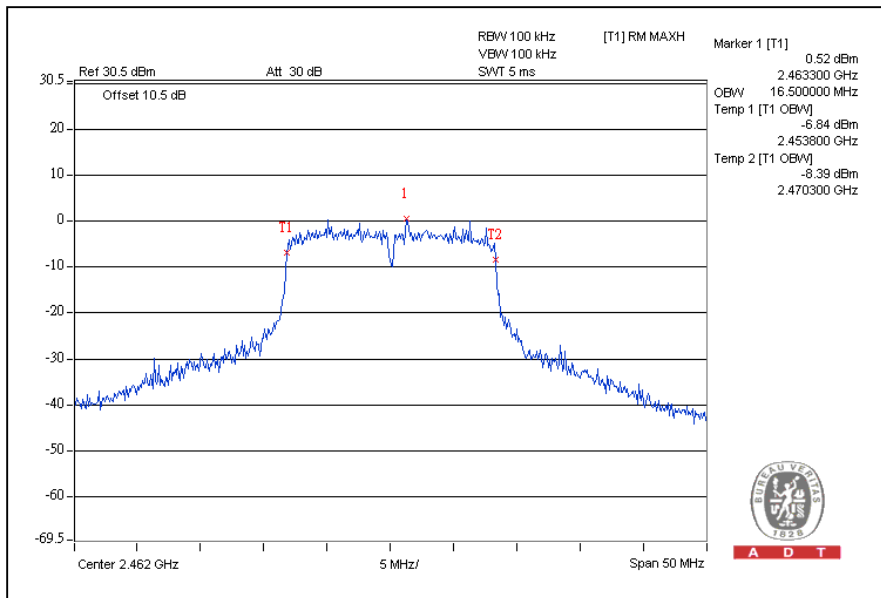

## 4.5 MAXIMUM PEAK OUTPUT POWER

### 4.5.1 LIMITS OF MAXIMUM PEAK OUTPUT POWER MEASUREMENT

The Maximum Peak Output Power Measurement is 30dBm.

### 4.5.2 INSTRUMENTS

DESCRIPTION & MANUFACTURER	MODEL NO.	SERIAL NO.	CALIBRATED DATE	CALIBRATED UNTIL
Peak Power Meter	ML2495A	0824006	May 04, 2010	May 03, 2011
Power Sensor	MA2411B	0738172	May 04, 2010	May 03, 2011

**NOTE:** The calibration interval of the above test instruments is 12 months and the calibrations are traceable to NML/ROC and NIST/USA.

### 4.5.3 TEST PROCEDURES

1. The transmitter output was connected to the power meter through an attenuator; the bandwidth of the fundamental frequency was measured with the power meter.
2. Record the power level.

### 4.5.4 DEVIATION FROM TEST STANDARD

No deviation

### 4.5.5 TEST SETUP

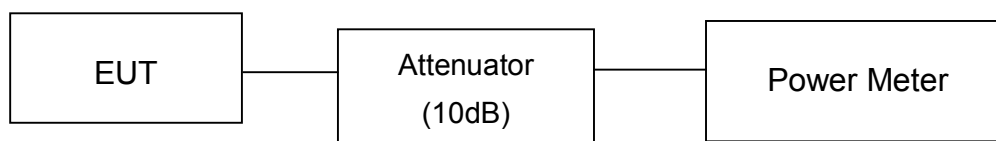



A D T

#### 4.5.6 EUT OPERATING CONDITIONS

Same as Item 4.3.6



A D T

#### 4.5.7 TEST RESULTS

##### 802.11b DSSS MODULATION:

CHANNEL	CHANNEL FREQUENCY (MHz)	PEAK POWER OUTPUT (dBm)	PEAK POWER OUTPUT (mW)	PEAK POWER LIMIT (dBm)	PASS / FAIL
1	2412	20.9	123.0	30	PASS
6	2437	20.8	120.2	30	PASS
11	2462	21.0	125.9	30	PASS

##### 802.11g OFDM MODULATION:

CHANNEL	CHANNEL FREQUENCY (MHz)	PEAK POWER OUTPUT (dBm)	PEAK POWER OUTPUT (mW)	PEAK POWER LIMIT (dBm)	PASS / FAIL
1	2412	22.3	169.8	30	PASS
6	2437	23.8	239.9	30	PASS
11	2462	23.0	199.5	30	PASS

##### 802.11n (20MHz) OFDM MODULATION:

CHANNEL	CHANNEL FREQUENCY (MHz)	PEAK POWER OUTPUT (dBm)	PEAK POWER OUTPUT (mW)	PEAK POWER LIMIT (dBm)	PASS / FAIL
1	2412	21.7	147.9	30	PASS
6	2437	23.7	234.4	30	PASS
11	2462	22.4	173.8	30	PASS



A D T

## 4.6 AVERAGE OUTPUT POWER

### 4.6.1 FOR REFERENCE.

### 4.6.2 TEST INSTRUMENTS

DESCRIPTION & MANUFACTURER	MODEL NO.	SERIAL NO.	CALIBRATED DATE	CALIBRATED UNTIL
Peak Power Meter	ML2495A	0824006	May 04, 2010	May 03, 2011
Power Sensor	MA2411B	0738172	May 04, 2010	May 03, 2011

**NOTE:** The calibration interval of the above test instruments is 12 months and the calibrations are traceable to NML/ROC and NIST/USA.

#### 4.6.3 TEST PROCEDURES

1. The transmitter output was connected to the power meter through an attenuator, the bandwidth of the fundamental frequency was measured with the power meter.
2. Record the average power level.

#### 4.6.4 TEST SETUP

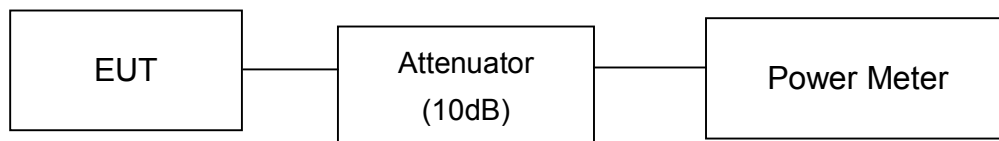

#### 4.6.5 EUT OPERATING CONDITIONS

Same as Item 4.3.5



A D T

#### 4.6.6 TEST RESULTS

##### 802.11b DSSS MODULATION:

CHANNEL	CHANNEL FREQUENCY (MHz)	AVERAGE POWER OUTPUT (dBm)
1	2412	18.8
6	2437	19.0
11	2462	18.8

##### 802.11g OFDM MODULATION:

CHANNEL	CHANNEL FREQUENCY (MHz)	AVERAGE POWER OUTPUT (dBm)
1	2412	14.0
6	2437	19.5
11	2462	15.3

##### 802.11n (20MHz) OFDM MODULATION:

CHANNEL	CHANNEL FREQUENCY (MHz)	AVERAGE POWER OUTPUT (dBm)
1	2412	13.3
6	2437	19.1
11	2462	14.7



A D T

## 4.7 POWER SPECTRAL DENSITY MEASUREMENT

### 4.7.1 LIMITS OF POWER SPECTRAL DENSITY MEASUREMENT

The Maximum of Power Spectral Density Measurement is 8dBm.

### 4.7.2 TEST INSTRUMENTS

DESCRIPTION & MANUFACTURER	MODEL NO.	SERIAL NO.	CALIBRATED DATE	CALIBRATED UNTIL
Spectrum Analyzer	E4446A	MY48250254	Aug. 03, 2009	Aug. 02, 2010

**NOTE:** The calibration interval of the above test instruments is 12 months and the calibrations are traceable to NML/ROC and NIST/USA.



#### 4.7.3 TEST PROCEDURE

The transmitter output was connected to the spectrum analyzer through an attenuator, the bandwidth of the fundamental frequency was measured with the spectrum analyzer using 3kHz RBW and 30kHz VBW, set sweep time = span/3kHz. The power spectral density was measured and recorded.

The sweep time is allowed to be longer than span/3kHz for a full response of the mixer in the spectrum analyzer.

#### 4.7.4 DEVIATION FROM TEST STANDARD

No deviation

#### 4.7.5 TEST SETUP

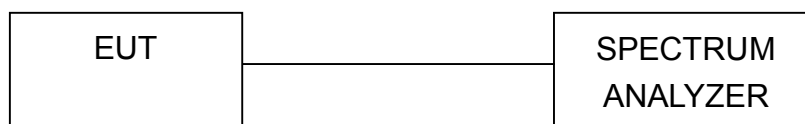

#### 4.7.6 EUT OPERATING CONDITION

Same as Item 4.3.6



A D T

### 4.7.7 TEST RESULTS

#### 802.11b DSSS MODULATION:

CHANNEL	CHANNEL FREQUENCY (MHz )	RF POWER LEVEL IN 3kHz BW (dBm)	MAXIMUM LIMIT (dBm)	PASS / FAIL
1	2412	-5.8	8	PASS
6	2437	-4.6	8	PASS
11	2462	-6.5	8	PASS

CH1

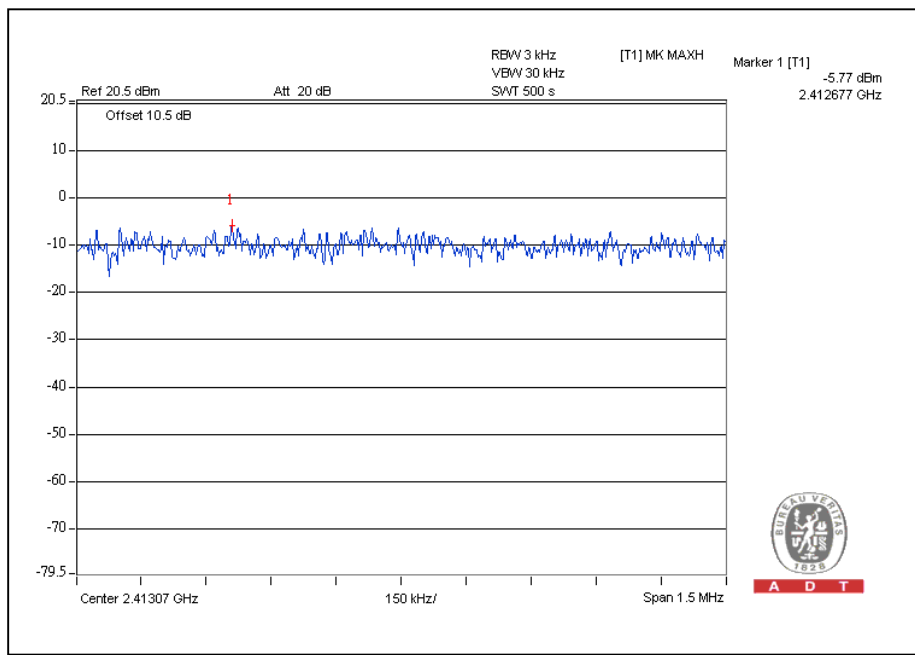



A D T

### CH6

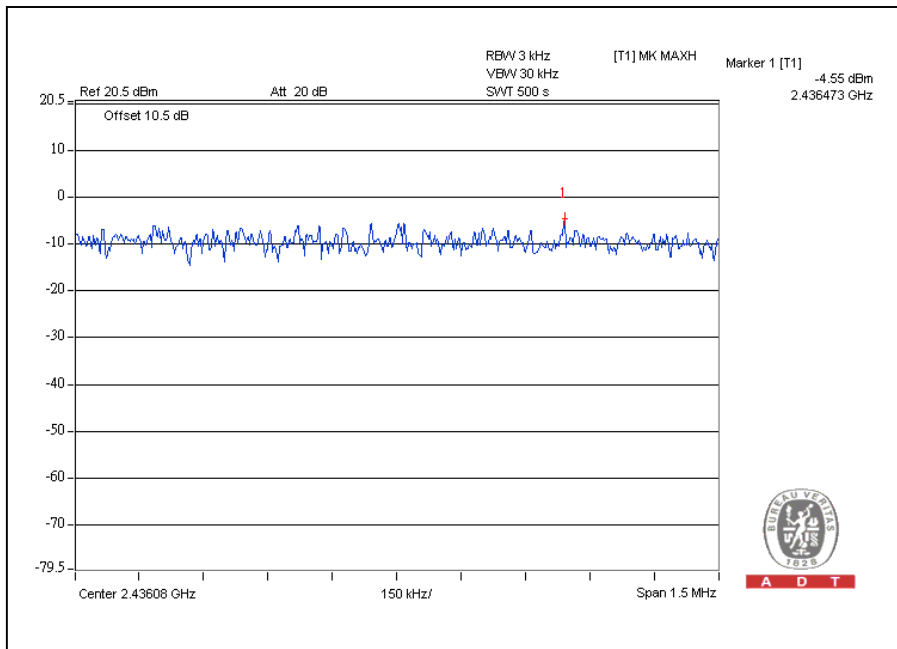

### CH11

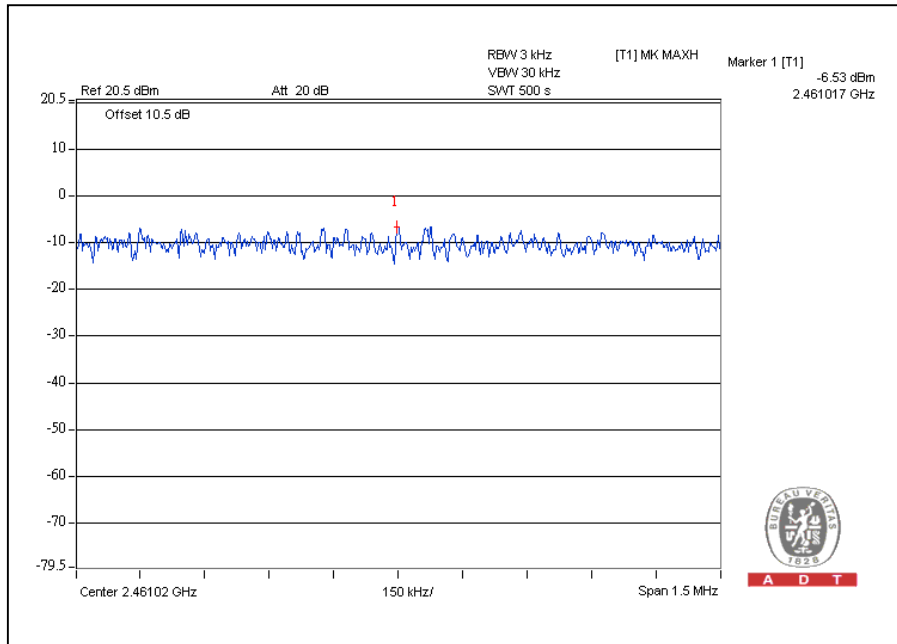



A D T

### 802.11g OFDM MODULATION:

CHANNEL	CHANNEL FREQUENCY (MHz )	RF POWER LEVEL IN 3kHz BW (dBm)	MAXIMUM LIMIT (dBm)	PASS / FAIL
1	2412	-12.8	8	PASS
6	2437	-6.1	8	PASS
11	2462	-9.8	8	PASS

CH1

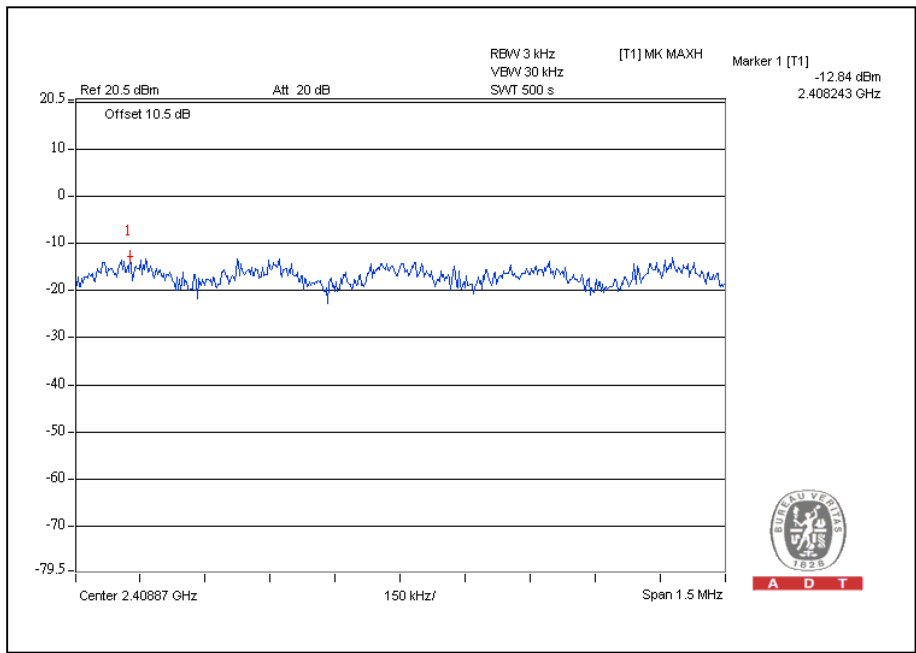



A D T

### CH6

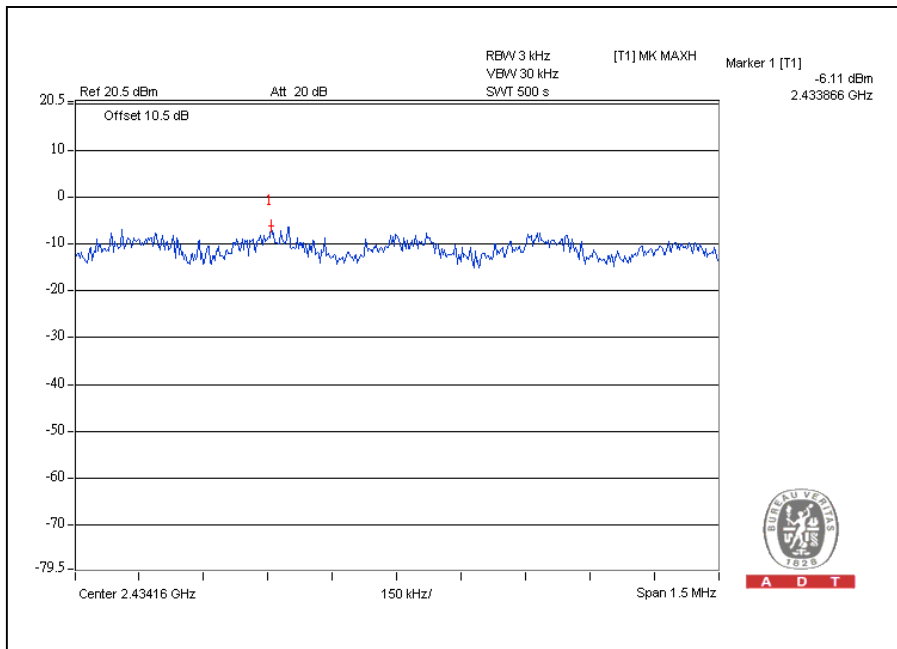

### CH11

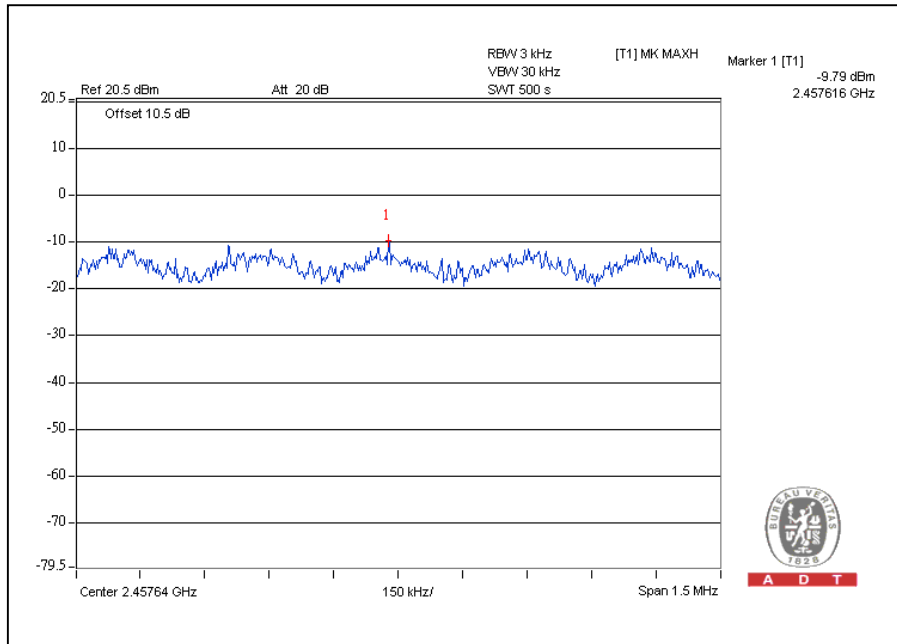



A D T

**802.11n (20MHz) OFDM MODULATION:**

CHANNEL	CHANNEL FREQUENCY (MHz )	RF POWER LEVEL IN 3kHz BW (dBm)	MAXIMUM LIMIT (dBm)	PASS / FAIL
1	2412	-13.3	8	PASS
6	2437	-6.7	8	PASS
11	2462	-11.7	8	PASS

CH1

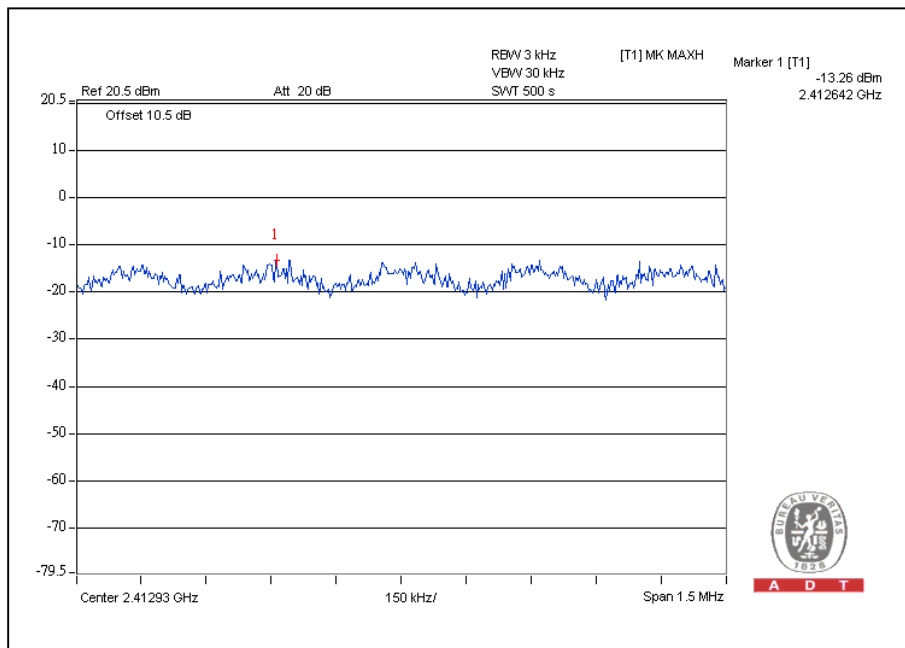



A D T

### CH6

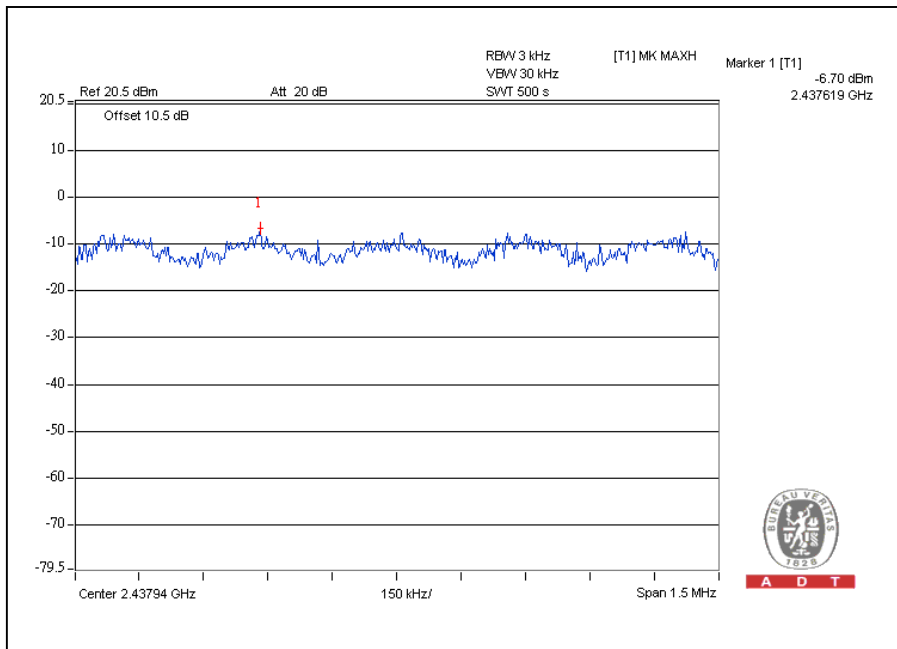

### CH11

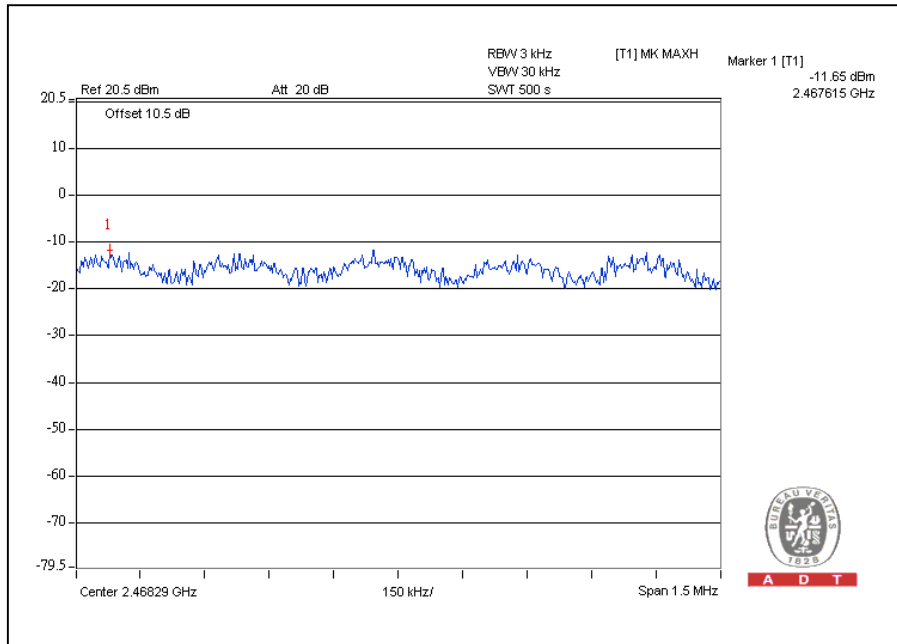



A D T

## 4.8 CONDUCTED OUT-BAND EMISSION MEASUREMENT

### 4.8.1 LIMITS OF CONDUCTED OUT-BAND EMISSION MEASUREMENT

Below  $-20\text{dB}$  of the highest emission level of operating band (in 100kHz Resolution Bandwidth).

### 4.8.2 TEST INSTRUMENTS

DESCRIPTION & MANUFACTURER	MODEL NO.	SERIAL NO.	CALIBRATED DATE	CALIBRATED UNTIL
Spectrum Analyzer	E4446A	MY48250254	Aug. 03, 2009	Aug. 02, 2010

**NOTE:** The calibration interval of the above test instruments is 12 months and the calibrations are traceable to NML/ROC and NIST/USA.

### 4.8.3 TEST PROCEDURE

The transmitter output was connected to the spectrum analyzer via a low loss cable. Set RBW of spectrum analyzer to 100kHz and VBW of spectrum analyzer to 300kHz with suitable frequency span including 100 MHz bandwidth from band edge. The band edges was measured and recorded.

The spectrum plots (RBW = 100kHz, VBW = 300kHz) are attached on the following pages.



#### 4.8.4 TEST SETUP

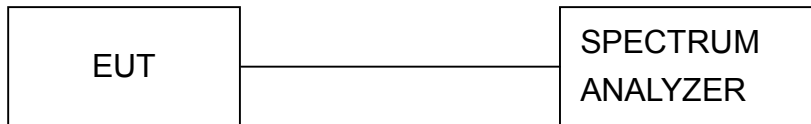

#### 4.8.5 DEVIATION FROM TEST STANDARD

No deviation

#### 4.8.6 EUT OPERATING CONDITION

Same as Item 4.3.6

#### 4.8.7 TEST RESULTS

The spectrum plots are attached on the following images. D1 line indicates the highest level, and D2 line indicates the 20dB offset below D1. It shows compliance with the requirement in part 15.247(d).

## 802.11b DSSS MODULATION: CH1

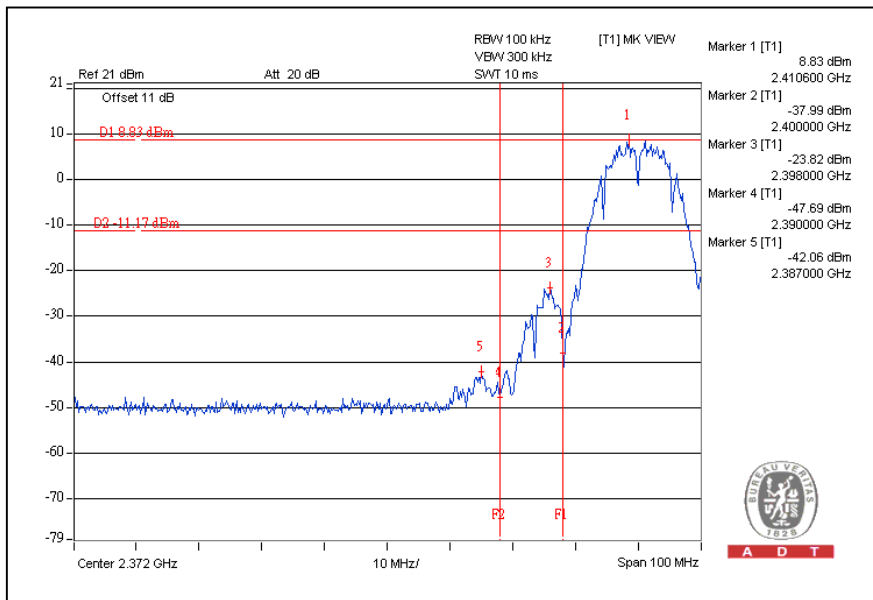

## CH11

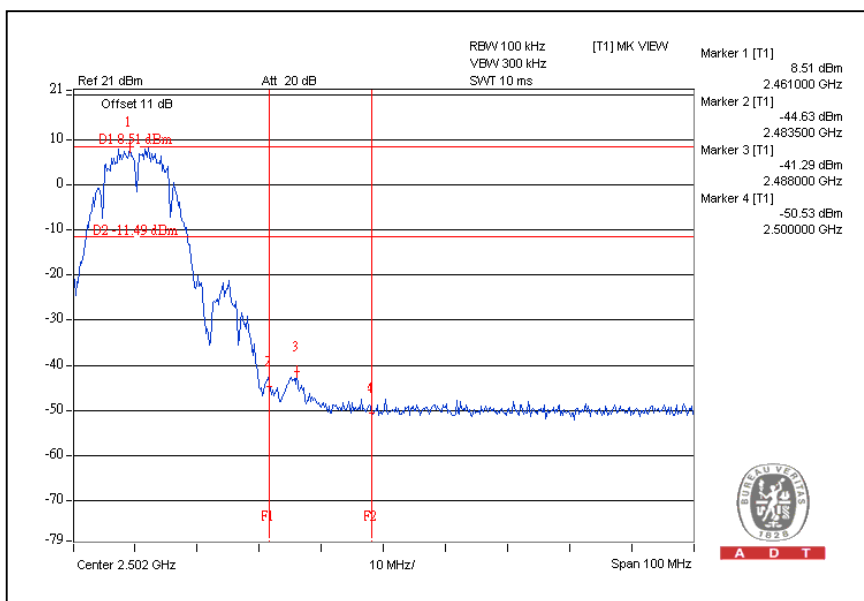

### CH1

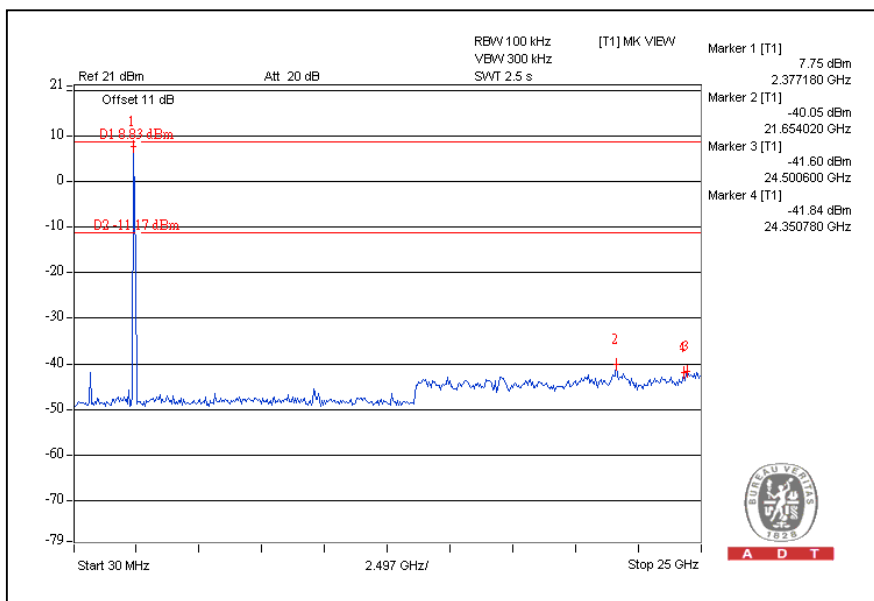

### CH11

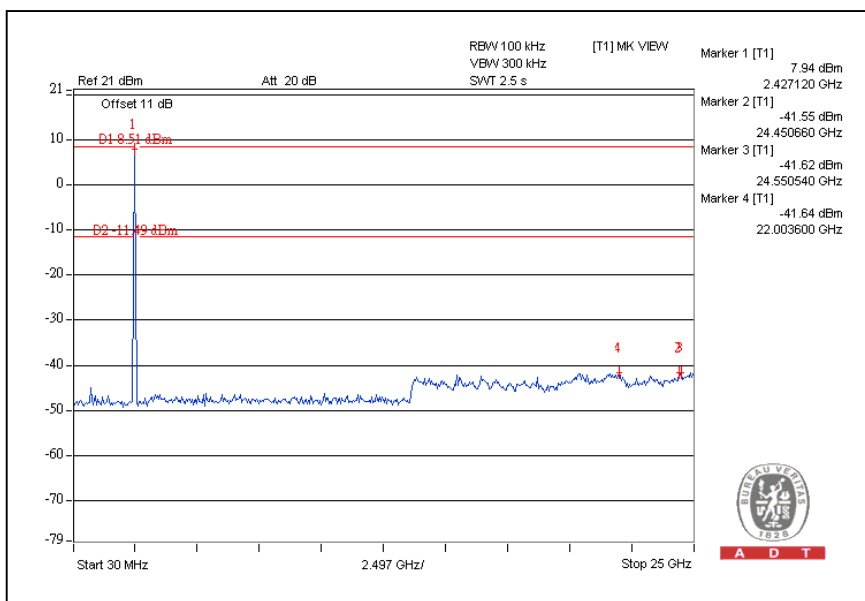



A D T

# 802.11g OFDM MODULATION:

## CH1

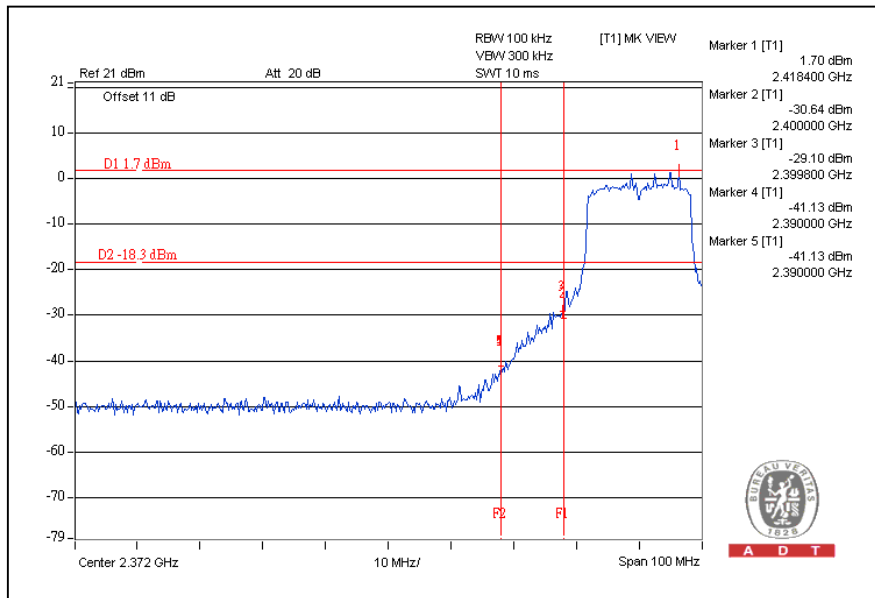

## CH11

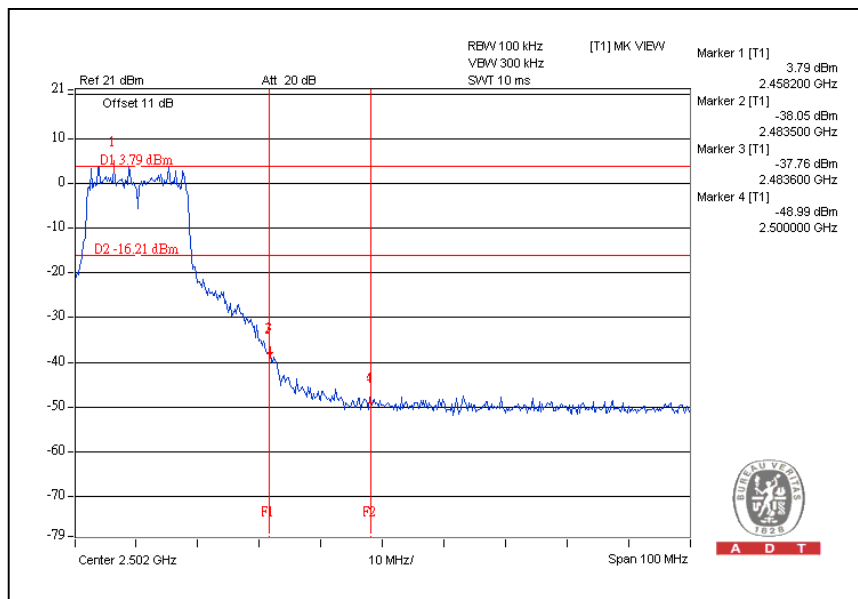



A D T

### CH1

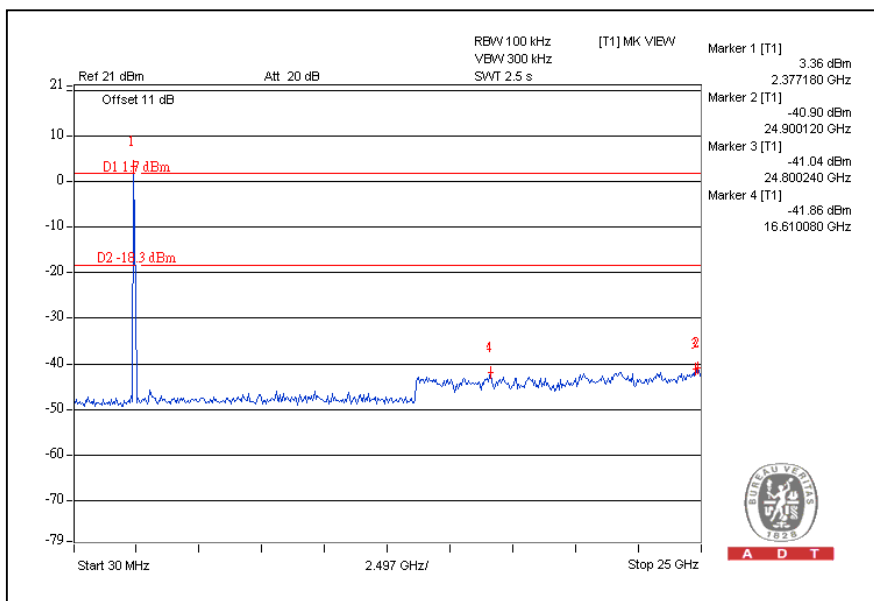

### CH11

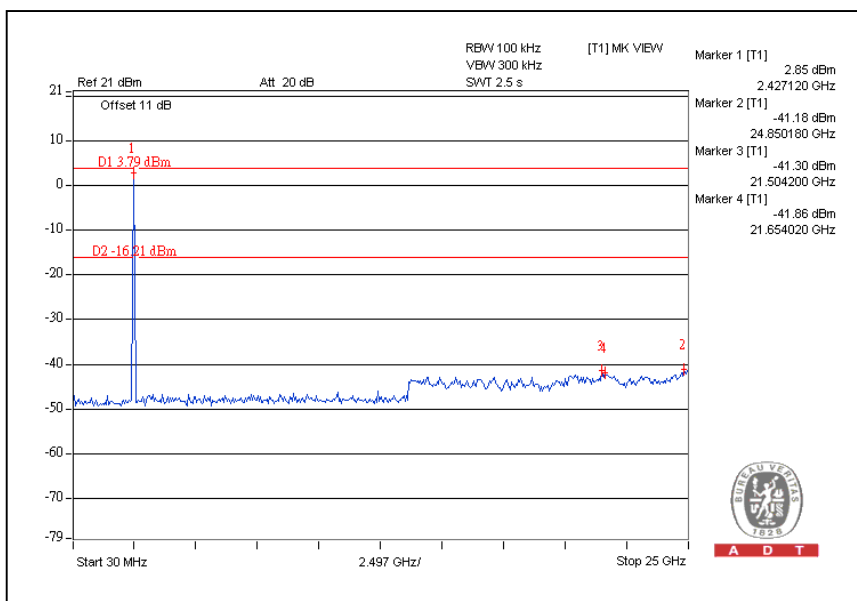



A D T

### 802.11n (20MHz) OFDM MODULATION:

CH1

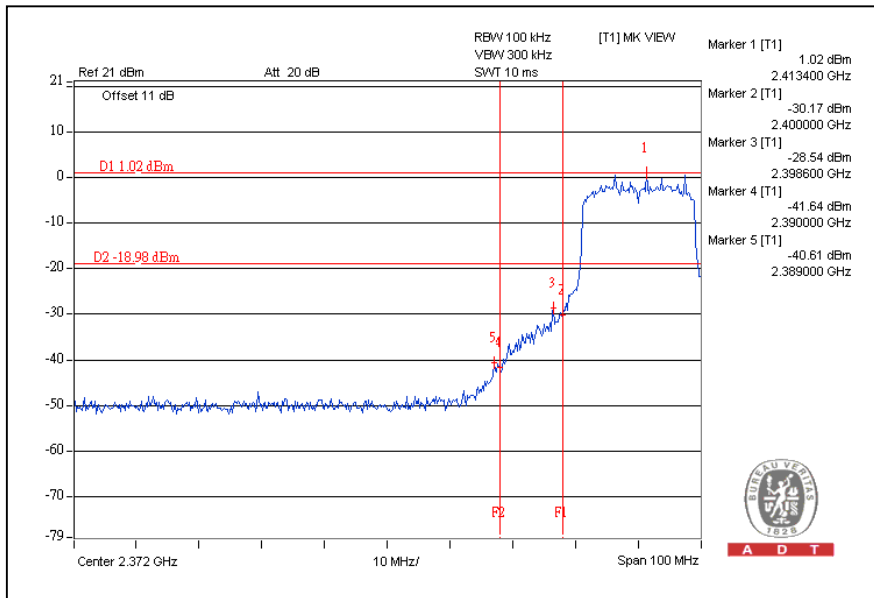

CH11

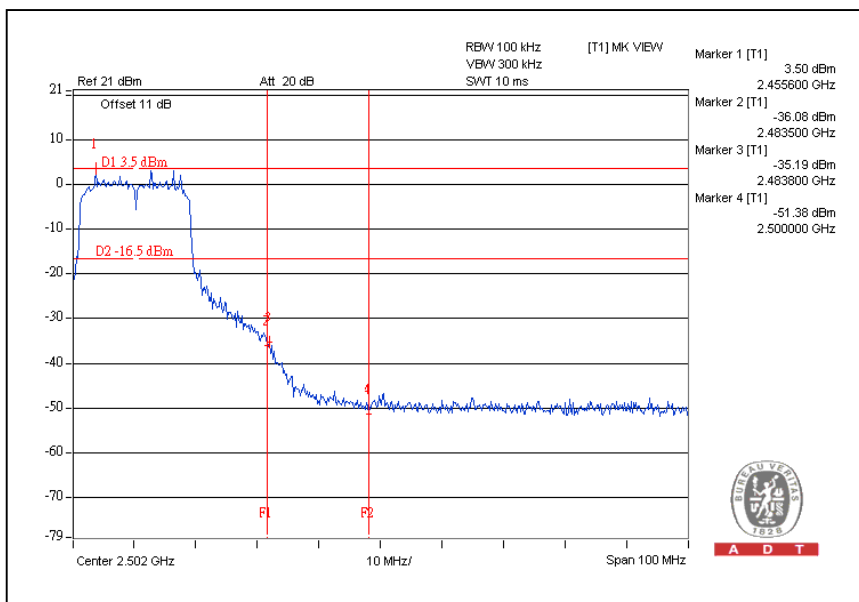



A D T

### CH1

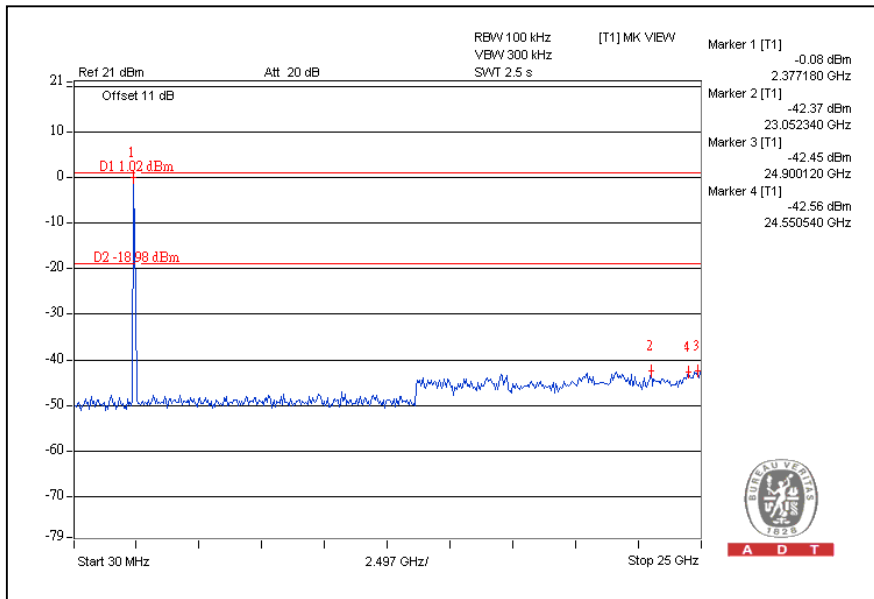

### CH11

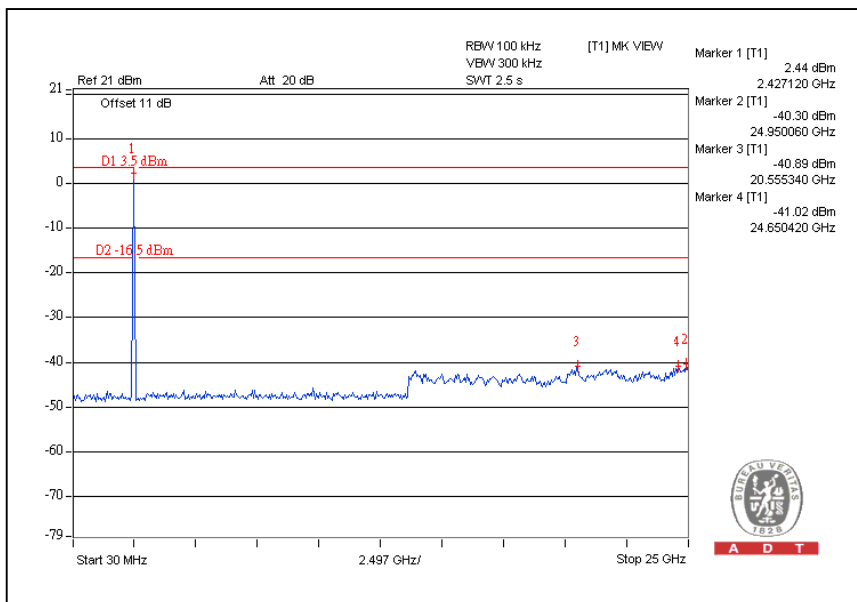



## 5. INFORMATION ON THE TESTING LABORATORIES

We, Bureau Veritas Consumer Products Services (H.K.) Ltd., Taoyuan Branch, were founded in 1988 to provide our best service in EMC, Radio, Telecom and Safety consultation. Our laboratories are accredited and approved according to ISO/IEC 17025:

Copies of accreditation certificates of our laboratories obtained from approval agencies can be downloaded from our web site: [www.adt.com.tw/index.5/phtml](http://www.adt.com.tw/index.5/phtml). If you have any comments, please feel free to contact us at the following:

**Linko EMC/RF Lab:**  
Tel: 886-2-26052180  
Fax: 886-2-26052943

**Hsin Chu EMC/RF Lab:**  
Tel: 886-3-5935343  
Fax: 886-3-5935342

**Hwa Ya EMC/RF/Safety Telecom Lab:**  
Tel: 886-3-3183232  
Fax: 886-3-3185050

**Web Site:** [www.adt.com.tw](http://www.adt.com.tw)

The address and road map of all our labs can be found in our web site also





A D T

## **6.APPENDIX-A- MODIFICATIONS RECORDERS FOR ENGINEERING CHANGES TO THE EUT BY THE LAB**

No any modifications are made to the EUT by the lab during the test.

---END---