



FCC TEST REPORT (15.247)

REPORT NO.: RF990709E01A

MODEL NO.: ARS63-D

FCC ID: PPD-ARS63D

RECEIVED: July 08, 2010

TESTED: July 22 to Aug. 11, 2010

ISSUED: Aug. 26, 2010

APPLICANT: Atheros Communications, Inc.

ADDRESS: 1700 Technology Drive, San Jose, CA
95110

ISSUED BY: Bureau Veritas Consumer Products Services
(H.K.) Ltd., Taoyuan Branch Hsin Chu Laboratory

LAB ADDRESS: No. 81-1, Lu Liao Keng, 9th Ling,Wu Lung Tsuen,
Chiung Lin Hsiang, Hsin Chu Hsien 307, Taiwan

TEST LOCATION (1): No. 81-1, Lu Liao Keng, 9th Ling,Wu Lung Tsuen,
Chiung Lin Hsiang, Hsin Chu Hsien 307, Taiwan

TEST LOCATION (2): No. 49, Ln. 206, Wende Rd., Shangshan Tsuen,
Chiung Lin Hsiang, Hsin Chu Hsien 307, Taiwan

This test report consists of 142 pages in total. It may be duplicated completely for legal use with the approval of the applicant. It should not be reproduced except in full, without the written approval of our laboratory. The client should not use it to claim product certification, approval, or endorsement by any government agency. The test results in the report only apply to the tested sample.



A D T

Table of Contents

1.	CERTIFICATION	6
2.	SUMMARY OF TEST RESULTS	7
2.1	MEASUREMENT UNCERTAINTY	9
3.	GENERAL INFORMATION	10
3.1	GENERAL DESCRIPTION OF EUT	10
3.2	DESCRIPTION OF ANTENNA	12
3.3	DESCRIPTION OF TEST MODES	13
3.3.1	TEST MODE APPLICABILITY AND TESTED CHANNEL DETAIL	14
3.4	GENERAL DESCRIPTION OF APPLIED STANDARDS	17
3.5	DESCRIPTION OF SUPPORT UNITS.....	18
3.6	CONFIGURATION OF SYSTEM UNDER TEST	18
4.	TEST TYPES AND RESULTS (802.11b & g, 2400 ~ 2483.5MHz Band)	19
4.1	CONDUCTED EMISSION MEASUREMENT	19
4.1.1	LIMITS OF CONDUCTED EMISSION MEASUREMENT.....	19
4.1.2	TEST INSTRUMENTS	19
4.1.3	TEST PROCEDURES.....	20
4.1.4	DEVIATION FROM TEST STANDARD	20
4.1.5	TEST SETUP	21
4.1.6	EUT OPERATING CONDITIONS.....	21
4.1.7	TEST RESULTS.....	22
4.2	RADIATED EMISSION MEASUREMENT	24
4.2.1	LIMITS OF RADIATED EMISSION MEASUREMENT.....	24
4.2.2	TEST INSTRUMENTS	25
4.2.3	TEST PROCEDURES.....	26
4.2.4	DEVIATION FROM TEST STANDARD	26
4.2.5	TEST SETUP	27
4.2.6	EUT OPERATING CONDITIONS.....	27
4.2.7	TEST RESULTS (For transmitter part)	28
4.2.8	TEST RESULTS (For receiver part)	50
4.3	6dB BANDWIDTH MEASUREMENT	54
4.3.1	LIMITS OF 6dB BANDWIDTH MEASUREMENT	54
4.3.2	TEST INSTRUMENTS	54
4.3.3	TEST PROCEDURE	54
4.3.4	DEVIATION FROM TEST STANDARD	54
4.3.5	TEST SETUP	54
4.3.6	EUT OPERATING CONDITIONS.....	54
4.3.7	TEST RESULTS.....	55
4.4	99% BANDWIDTH MEASUREMENT	61
4.4.1	TEST INSTRUMENTS	61



4.4.2	TEST PROCEDURE	61
4.4.3	TEST SETUP	61
4.4.4	EUT OPERATING CONDITIONS.....	61
4.4.5	TEST RESULTS.....	62
4.5	MAXIMUM PEAK OUTPUT POWER.....	68
4.5.1	LIMITS OF MAXIMUM PEAK OUTPUT POWER MEASUREMENT	68
4.5.2	INSTRUMENTS	68
4.5.3	TEST PROCEDURES.....	68
4.5.4	DEVIATION FROM TEST STANDARD	68
4.5.5	TEST SETUP	68
4.5.6	EUT OPERATING CONDITIONS.....	68
4.5.7	TEST RESULTS.....	69
4.6	AVERAGE OUTPUT POWER.....	70
4.6.1	FOR REFERENCE.....	70
4.6.2	TEST INSTRUMENTS	70
4.6.3	TEST PROCEDURES.....	70
4.6.4	TEST SETUP	70
4.6.5	EUT OPERATING CONDITIONS.....	70
4.6.6	TEST RESULTS.....	71
4.7	POWER SPECTRAL DENSITY MEASUREMENT.....	72
4.7.1	LIMITS OF POWER SPECTRAL DENSITY MEASUREMENT	72
4.7.2	TEST INSTRUMENTS	72
4.7.3	TEST PROCEDURE	72
4.7.4	DEVIATION FROM TEST STANDARD	72
4.7.5	TEST SETUP	72
4.7.6	EUT OPERATING CONDITION	72
4.7.7	TEST RESULTS.....	73
4.8	CONDUCTED OUT-BAND EMISSION MEASUREMENT.....	79
4.8.1	LIMITS OF CONDUCTED OUT-BAND EMISSION MEASUREMENT	79
4.8.2	TEST INSTRUMENTS	79
4.8.3	TEST PROCEDURE	79
4.8.4	DEVIATION FROM TEST STANDARD	79
4.8.5	EUT OPERATING CONDITION	79
4.8.6	TEST RESULTS.....	79
5.	TEST TYPES AND RESULTS (802.11a, 5725~5850MHz Band).....	86
5.1	CONDUCTED EMISSION MEASUREMENT.....	86
5.1.1	LIMITS OF CONDUCTED EMISSION MEASUREMENT.....	86
5.1.2	TEST INSTRUMENTS	86
5.1.3	TEST PROCEDURES.....	87



5.1.4	DEVIATION FROM TEST STANDARD	87
5.1.5	TEST SETUP	88
5.1.6	EUT OPERATING CONDITIONS	88
5.1.7	TEST RESULTS	89
5.2	RADIATED EMISSION MEASUREMENT	91
5.2.1	LIMITS OF RADIATED EMISSION MEASUREMENT	91
5.2.2	TEST INSTRUMENTS	92
5.2.3	TEST PROCEDURES	93
5.2.4	DEVIATION FROM TEST STANDARD	93
5.2.5	TEST SETUP	94
5.2.6	EUT OPERATING CONDITIONS	94
5.2.7	TEST RESULTS (For transmitter part)	95
5.2.8	TEST RESULTS (For receiver part)	104
5.3	6dB BANDWIDTH MEASUREMENT	108
5.3.1	LIMITS OF 6dB BANDWIDTH MEASUREMENT	108
5.3.2	TEST INSTRUMENTS	108
5.3.3	TEST PROCEDURE	108
5.3.4	DEVIATION FROM TEST STANDARD	108
5.3.5	TEST SETUP	108
5.3.6	EUT OPERATING CONDITIONS	108
5.3.7	TEST RESULTS	109
5.4	99% BANDWIDTH MEASUREMENT	115
5.4.1	TEST INSTRUMENTS	115
5.4.2	TEST PROCEDURE	115
5.4.3	TEST SETUP	115
5.4.4	EUT OPERATING CONDITIONS	115
5.4.5	TEST RESULTS	116
5.5	MAXIMUM PEAK OUTPUT POWER	122
5.5.1	LIMITS OF MAXIMUM PEAK OUTPUT POWER MEASUREMENT	122
5.5.2	INSTRUMENTS	122
5.5.3	TEST PROCEDURES	122
5.5.4	DEVIATION FROM TEST STANDARD	122
5.5.5	TEST SETUP	122
5.5.6	EUT OPERATING CONDITIONS	122
5.5.7	TEST RESULTS	123
5.6	AVERAGE OUTPUT POWER	124
5.6.1	FOR REFERENCE	124
5.6.2	TEST INSTRUMENTS	124
5.6.3	TEST PROCEDURES	125



A D T

5.6.4	TEST SETUP	125
5.6.5	EUT OPERATING CONDITIONS	125
5.6.6	TEST RESULTS	126
5.7	POWER SPECTRAL DENSITY MEASUREMENT	127
5.7.1	LIMITS OF POWER SPECTRAL DENSITY MEASUREMENT	127
5.7.2	TEST INSTRUMENTS	127
5.7.3	TEST PROCEDURE	127
5.7.4	DEVIATION FROM TEST STANDARD	127
5.7.5	TEST SETUP	127
5.7.6	EUT OPERATING CONDITION	127
5.7.7	TEST RESULTS	128
5.8	CONDUCTED OUT-BAND EMISSION MEASUREMENT	134
5.8.1	LIMITS OF CONDUCTED OUT-BAND EMISSION MEASUREMENT	134
5.8.2	TEST INSTRUMENTS	134
5.8.3	TEST PROCEDURE	134
5.8.4	DEVIATION FROM TEST STANDARD	134
5.8.5	EUT OPERATING CONDITION	134
5.8.6	TEST RESULTS	134
6.	INFORMATION ON THE TESTING LABORATORIES	141
7.	APPENDIX A - MODIFICATIONS RECORDERS FOR ENGINEERING CHANGES TO THE EUT BY THE LAB	142



1. CERTIFICATION

PRODUCT: Low Power 1x1 802.11 a/b/g/n (SDIO) Card
BRAND NAME: Atheros
MODEL NO.: ARS63-D
TEST SAMPLE: R&D SAMPLE
TESTED: July 22 to Aug. 11, 2010
APPLICANT: Atheros Communications, Inc.
STANDARDS: FCC Part 15, Subpart C (Section 15.247)
ANSI C63.4-2003
Canada RSS-210 issue 7
Canada RSS-Gen issue 2

The above equipment (Model: ARS63-D) has been tested by **Bureau Veritas Consumer Products Services (H.K.) Ltd., Taoyuan Branch**, and was in compliance with the requirement of the above standards. The test record, data evaluation & Equipment Under Test (EUT) configurations represented herein are true and accurate accounts of the measurements of the sample's EMC characteristics under the conditions specified in this report.

PREPARED BY : Midoli Peng , **DATE:** Aug. 26, 2010
(Midoli Peng, Specialist)

TECHNICAL ACCEPTANCE : Hank Chung , **DATE:** Aug. 26, 2010
(Hank Chung, Deputy Manager)

APPROVED BY : May Chen , **DATE:** Aug. 26, 2010
(May Chen, Deputy Manager)

2. SUMMARY OF TEST RESULTS

The EUT has been tested according to the following specifications:

For 2.4GHz, 2412~2462MHz Band

APPLIED STANDARD: 47 CFR Part 15, Subpart C ; RSS-210; RSS-Gen					
Standard Section			Test Type and Limit	Result	REMARK
RSS-210	RSS-Gen	47 CFR Part 15			
-	7.2.2	15.207	AC Power Conducted Emission	PASS	Meet the requirement of limit. Minimum passing margin is -15.41dB at 0.150MHz
A8.2(a)	4.6	15.247(a)(2)	Spectrum Bandwidth of a Direct Sequence Spread Spectrum System Limit: min. 500kHz	PASS	Meet the requirement of limit
A8.4(4)	4.8	15.247(b)	Maximum Peak Output Power Limit: max. 30dBm	PASS	Meet the requirement of limit
A8.5	4.9	15.247(c)	Transmitter Radiated Emissions FCC Limit: Table 15.209 RSS-210 Limit: Table 2	PASS	Meet the requirement of limit Minimum passing margin is -0.7dB at 2483.5MHz
-	6	-	Receiver Radiated Emissions RSS-210 Limit: Table 2	PASS	Meet the requirement of limit Minimum passing margin is -1.5dB at 166.55MHz
A8.2(b)	-	15.247(d)	Power Spectral Density Limit: max. 8dBm	PASS	Meet the requirement of limit
A8.5	-	15.247(c)	Conducted Out-Band Emission Measurement Limit: 20 dB less than the peak value of fundamental frequency	PASS	Meet the requirement of limit
	7.1.4	15.203	Antenna Requirement	PASS	Antenna connector is IPEX not a standard connector.



A D T

For 5GHz, 5725~5850MHz Band

APPLIED STANDARD: 47 CFR Part 15, Subpart C ; RSS-210; RSS-Gen					
Standard Section			Test Type and Limit	Result	REMARK
RSS-210	RSS-Gen	47 CFR Part 15			
-	7.2.2	15.207	AC Power Conducted Emission	PASS	Meet the requirement of limit. Minimum passing margin is -16.12dB at 0.240MHz
A8.2(a)	4.6	15.247(a)(2)	Spectrum Bandwidth of a Direct Sequence Spread Spectrum System Limit: min. 500kHz	PASS	Meet the requirement of limit
A8.4(4)	4.8	15.247(b)	Maximum Peak Output Power Limit: max. 30dBm	PASS	Meet the requirement of limit
A8.5	4.9	15.247(c)	Transmitter Radiated Emissions FCC Limit: Table 15.209 RSS-210 Limit: Table 2	PASS	Meet the requirement of limit Minimum passing margin is -1.2dB at 11570.0MHz
-	6	-	Receiver Radiated Emissions RSS-210 Limit: Table 2	PASS	Meet the requirement of limit Minimum passing margin is -2.6dB at 165.0MHz
A8.2(b)	-	15.247(d)	Power Spectral Density Limit: max. 8dBm	PASS	Meet the requirement of limit
A8.5	-	15.247(c)	Conducted Out-Band Emission Measurement Limit: 20 dB less than the peak value of fundamental frequency	PASS	Meet the requirement of limit
	7.1.4	15.203	Antenna Requirement	PASS	Antenna connector is IPEX not a standard connector.

NOTE:

1. The EUT was operating in 2400 ~ 2483.5MHz, 5.15~5.35GHz, 5.47~5.725GHz and 5.725~5.850GHz frequencies band. This report was recorded the RF parameters including 2400 ~ 2483.5MHz and 5.725~5.850GHz. For the 5.15~5.35GHz and 5.47~5.725GHz RF parameters was recorded in another test report (RF990709E01A-1).

2.1 MEASUREMENT UNCERTAINTY

Where relevant, the following measurement uncertainty levels have been estimated for tests performed on the EUT as specified in CISPR 16-4-2:

This uncertainty represents an expanded uncertainty expressed at approximately the 95% confidence level using a coverage factor of $k=2$.

Measurement	Value
Conducted emissions	2.45 dB
Radiated emissions (30MHz-1GHz)	3.76 dB
Radiated emissions (1GHz -18GHz)	2.19 dB
Radiated emissions (18GHz -40GHz)	2.55 dB



A D T

3. GENERAL INFORMATION

3.1 GENERAL DESCRIPTION OF EUT

PRODUCT	Low Power 1x1 802.11 a/b/g/n (SDIO) Card
MODEL NO.	ARS63-D
FCC ID	PPD-ARS63D
IC ID	4104A-ARS63D
POWER SUPPLY	DC 3.3V from host equipment
MODULATION TYPE	CCK, DQPSK, DBPSK for DSSS 64QAM, 16QAM, QPSK, BPSK for OFDM
MODULATION TECHNOLOGY	DSSS, OFDM
TRANSFER RATE	802.11b: 11 / 5.5 / 2 / 1Mbps 802.11a/g: 54/48/36/24/18/12/9/6Mbps 802.11n (20MHz, 800ns GI): 65 / 58.5 / 52 / 39 / 26 / 19.5 / 13 / 6.5Mbps 802.11n (20MHz, 400ns GI): 72.2 / 65 / 57.8 / 43.3 / 28.9 / 21.7 / 14.4 / 7.2Mbps 802.11n (40MHz, 800ns GI)<For 5GHz only> : 135 / 121.5 / 108 / 81 / 54 / 40.5 / 27 / 13.5Mbps 802.11n (40MHz, 400ns GI) <For 5GHz only> : 150 / 135 / 120 / 90 / 60 / 45 / 30 / 15Mbps
OPERATING FREQUENCY	For 15.407 802.11a: 5.18 ~ 5.24GHz, 5.26 ~ 5.32GHz, 5.50 ~ 5.70GHz For 15.247 802.11b & 802.11g: 2.412 ~ 2.462GHz 802.11a: 5.745 ~ 5.825GHz
NUMBER OF CHANNEL	For 15.407 19 for 802.11a, 802.11n (20MHz) 9 for 802.11n (40MHz) For 15.247(2.4GHz) 11 for 802.11b, 802.11g, 802.11n (20MHz) For 15.247(5GHz) 5 for 802.11a, 802.11n (20MHz) 2 for 802.11n (40MHz)

MAXIMUM OUTPUT POWER	For 15.407 802.11a: 85.1mW 802.11n (20MHz): 70.8mW 802.11n (40MHz): 81.3mW For 15.247(2.4GHz) 802.11b: 125.9mW 802.11g: 239.9mW 802.11n (20MHz): 234.4mW For 15.247(5GHz) 802.11a: 218.8mW 802.11n (20MHz): 239.9mW 802.11n (40MHz): 257.0mW
ANTENNA TYPE	See item 3.2
ANTENNA CONNECTOR	See item 3.2
DATA CABLE	NA
I/O PORTS	NA
ASSOCIATED DEVICES	NA

NOTE:

1. The EUT incorporates CDD function with 802.11a, 802.11b, 802.11g and SISO function with 802.11n.
2. The EUT is 1 * 1 spatial SISO without beam forming function. The antenna configuration is one transmitter antenna and one receiver antenna, as there are 2 PIFA antennas.
3. The EUT complies with 802.11n standards and backwards compatible with 802. 11a, 802.11b, 802.11g products.
4. The EUT was pre-tested under the following modes:

Test Mode	Data rate
Mode A	400ns GI
Mode B	800ns GI

From the above modes, the worst case was found in **Mode B**. Therefore only the test data of the mode was recorded in this report.

5. The above EUT information was declared by manufacturer and for more detailed features description, please refer to the manufacturer's specifications or user's manual.

3.2 DESCRIPTION OF ANTENNA

There are two sets of antennas provided to this EUT, please refer to the following table:

Set 1:

No.	Brand	Model	Antenna Type	Connector	Antenna Gain (dBi)< included cable loss>			
					For 2.4GHz	For 5GHz (5.15~5.35)	For 5GHz (5.47~5.725)	For 5GHz (5.725~5.85)
1&2	WNC	81-EBJ15.005	PIFA	IPEX	3.62	3.08	4.76	4.76

Cable Loss:

No.	Brand	Model	Cable Loss(dB)				Cable Length
			For 2.4GHz	For 5GHz (5.15~5.35)	For 5GHz (5.47~5.725)	For 5GHz (5.725~5.85)	
1&2	WNC	81-EBJ15.005	1.15	1.70	1.74	1.79	300mm

Set 2:

No.	Brand	Model	Antenna Type	Connector	Antenna Gain (dBi)< included cable loss>			
					For 2.4GHz	For 5GHz (5.15~5.35)	For 5GHz (5.47~5.725)	For 5GHz (5.725~5.85)
1&2	WNC	81.ED415.001	PIFA	IPEX	1.48	5.56	5.34	3.14

Cable Loss:

No.	Brand	Model	Cable Loss(dB)				Cable Length
			For 2.4GHz	For 5GHz (5.15~5.35)	For 5GHz (5.47~5.725)	For 5GHz (5.725~5.85)	
1&2	WNC	81.ED415.001	0.96	1.29	1.36	1.38	300mm

Antenna (model: 81-EBJ15.005) was chosen for final test.



A D T

3.3 DESCRIPTION OF TEST MODES

Operated in 2400 ~ 2483.5MHz band:

Eleven channels are provided for 802.11b, 802.11g, 802.11n (20MHz):

CHANNEL	FREQUENCY	CHANNEL	FREQUENCY
1	2412MHz	7	2442MHz
2	2417MHz	8	2447MHz
3	2422MHz	9	2452MHz
4	2427MHz	10	2457MHz
5	2432MHz	11	2462MHz
6	2437MHz		

Operated in 5725 ~ 5850MHz band:

Five channels are provided for 802.11a, 802.11n (20MHz):

CHANNEL	FREQUENCY	CHANNEL	FREQUENCY
149	5745 MHz	161	5805 MHz
153	5765 MHz	165	5825 MHz
157	5785 MHz		

Two channels are provided for 802.11n (40MHz):

CHANNEL	FREQUENCY
151	5755 MHz
159	5795 MHz



3.3.1 TEST MODE APPLICABILITY AND TESTED CHANNEL DETAIL

EUT CONFIGURE MODE	APPLICABLE TO				DESCRIPTION
	PLC	RE < 1G	RE ≥ 1G	APCM	
-	√	√	√	√	-

Where **PLC**: Power Line Conducted Emission **RE < 1G**: Radiated Emission below 1GHz
RE ≥ 1G: Radiated Emission above 1GHz **APCM**: Antenna Port Conducted Measurement

POWER LINE CONDUCTED EMISSION TEST:

- Pre-Scan has been conducted to determine the worst-case mode from all possible combinations between available modulations, data rates and antenna ports (if EUT with antenna diversity architecture).
- Following channel(s) was (were) selected for the final test as listed below.

MODE	AVAILABLE CHANNEL	TESTED CHANNEL	MODULATION TECHNOLOGY	MODULATION TYPE	DATA RATE (Mbps)
802.11b	1 to 11	1	DSSS	DBPSK	1
For 5 GHz 802.11n (40MHz)	151 to 159	159	OFDM	BPSK	13.5

RADIATED EMISSION TEST (BELOW 1 GHz):

- Pre-Scan has been conducted to determine the worst-case mode from all possible combinations between available modulations, data rates and antenna ports (if EUT with antenna diversity architecture).
- The receiving mode had show equal or better than Tx mode during the pre-scan and hence the Tx mode data is re-used for Receiving-mode worst-case data.
- Following channel(s) was (were) selected for the final test as listed below.

MODE	AVAILABLE CHANNEL	TESTED CHANNEL	MODULATION TECHNOLOGY	MODULATION TYPE	DATA RATE (Mbps)
802.11g	1 to 11	6	OFDM	BPSK	6
For 5 GHz 802.11n (40MHz)	151 to 159	159	OFDM	BPSK	13.5



A D T

RADIATED EMISSION TEST (ABOVE 1 GHz):

- Pre-Scan has been conducted to determine the worst-case mode from all possible combinations between available modulations, data rates and antenna ports (if EUT with antenna diversity architecture).
- Following channel(s) was (were) selected for the final test as listed below.

MODE	AVAILABLE CHANNEL	TESTED CHANNEL	MODULATION TECHNOLOGY	MODULATION TYPE	DATA RATE (Mbps)
802.11b	1 to 11	1, 6, 11	DSSS	DBPSK	1
802.11g	1 to 11	1, 6, 11	OFDM	BPSK	6
802.11n (20MHz)	1 to 11	1, 6, 11	OFDM	BPSK	6.5
For 2.4 GHz Receiver	1 to 11	1, 6, 11	-	-	-
802.11a	149 to 165	149, 157, 165	OFDM	BPSK	6
For 5 GHz 802.11n (20MHz)	149 to 165	149, 157, 165	OFDM	BPSK	6.5
For 5 GHz 802.11n (40MHz)	151 to 159	151, 159	OFDM	BPSK	13.5
For 5 GHz Receiver	149 to 165	149, 157, 165	-	-	-

CONDUCTED OUT-BAND EMISSION MEASUREMENT:

- Pre-Scan has been conducted to determine the worst-case mode from all possible combinations between available modulations, data rates and antenna ports (if EUT with antenna diversity architecture).
- Following channel(s) was (were) selected for the final test as listed below.

MODE	AVAILABLE CHANNEL	TESTED CHANNEL	MODULATION TECHNOLOGY	MODULATION TYPE	DATA RATE (Mbps)
802.11b	1 to 11	1, 11	DSSS	DBPSK	1
802.11g	1 to 11	1, 11	OFDM	BPSK	6
For 2.4 GHz 802.11n (20MHz)	1 to 11	1, 11	OFDM	BPSK	6.5
802.11a	149 to 165	149, 165	OFDM	BPSK	6
For 5 GHz 802.11n (20MHz)	149 to 165	149, 165	OFDM	BPSK	6.5
For 5 GHz 802.11n (40MHz)	151 to 159	151, 159	OFDM	BPSK	13.5

ANTENNA PORT CONDUCTED MEASUREMENT:

- This item includes all test value of each mode, but only includes spectrum plot of worst value of each mode.
- Pre-Scan has been conducted to determine the worst-case mode from all possible combinations between available modulations, data rates and antenna ports (if EUT with antenna diversity architecture).
- Following channel(s) was (were) selected for the final test as listed below.

MODE	AVAILABLE CHANNEL	TESTED CHANNEL	MODULATION TECHNOLOGY	MODULATION TYPE	DATA RATE (Mbps)
802.11b	1 to 11	1, 6, 11	DSSS	DBPSK	1
802.11g	1 to 11	1, 6, 11	OFDM	BPSK	6
For 2.4 GHz 802.11n (20MHz)	1 to 11	1, 6, 11	OFDM	BPSK	6.5
802.11a	149 to 165	149, 157, 165	OFDM	BPSK	6
For 5 GHz 802.11n (20MHz)	149 to 165	149, 157, 165	OFDM	BPSK	6.5
For 5 GHz 802.11n (40MHz)	151 to 159	151, 159	OFDM	BPSK	13.5

※ TEST CONDITION:

APPLICABLE TO	ENVIRONMENTAL CONDITIONS	INPUT POWER (System)	TESTED BY
RE³1G	20deg. C, 70%RH, 1013 hPa	120Vac, 60Hz	Rex Huang / Eric Lee
RE<1G	24deg. C, 70%RH, 1013 hPa	120Vac, 60Hz	Eric Lee
PLC	26deg. C, 76%RH, 1013 hPa	120Vac, 60Hz	Frank Liu / Eric Lee
APCM	25deg. C, 60%RH, 1013 hPa	120Vac, 60Hz	Eric Lee

3.4 GENERAL DESCRIPTION OF APPLIED STANDARDS

The EUT is a RF product. According to the specifications of the manufacturer, it must comply with the requirements of the following standards:

FCC Part 15, Subpart C. (15.247)

ANSI C63.4-2003

Canada RSS-210 issue 7

Canada RSS-Gen issue 2

All test items have been performed and recorded as per the above standards.

NOTE: The EUT has been verified to comply with the requirements of FCC Part 15, Subpart B, Class B (DoC). The test report has been issued separately.

3.5 DESCRIPTION OF SUPPORT UNITS

The EUT has been tested as an independent unit together with other necessary accessories or support units. The following support units or accessories were used to form a representative test configuration during the tests.

No.	Product	Brand	Model No.	Serial No.	FCC ID
1	NOTEBOOK COMPUTER	DELL	PP32LA	GSLB32S	FCC DoC
2	EXTENSION CARD	Atheros	NA	NA	NA

No.	Signal cable description
1	NA
2	NA

Note: The power cords of the above support units were unshielded (1.8m).

3.6 CONFIGURATION OF SYSTEM UNDER TEST

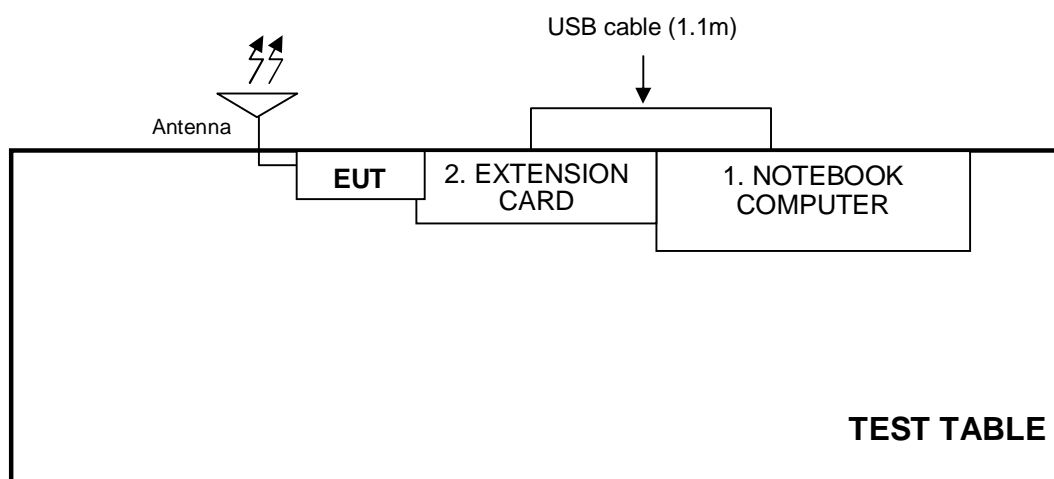

4. TEST TYPES AND RESULTS (802.11b & g, 2400 ~ 2483.5MHz Band)

4.1 CONDUCTED EMISSION MEASUREMENT

4.1.1 LIMITS OF CONDUCTED EMISSION MEASUREMENT

FREQUENCY OF EMISSION (MHz)	CONDUCTED LIMIT (dB μ V)	
0.15-0.5	Quasi-peak	Average
0.5-5	66 to 56	56 to 46
5-30	56	46
	60	50

- NOTE:**
1. The lower limit shall apply at the transition frequencies.
 2. The limit decreases in line with the logarithm of the frequency in the range of 0.15 to 0.50 MHz.
 3. All emanations from a class A/B digital device or system, including any network of conductors and apparatus connected thereto, shall not exceed the level of field strengths specified above.

4.1.2 TEST INSTRUMENTS

DESCRIPTION & MANUFACTURER	MODEL NO.	SERIAL NO.	CALIBRATED DATE	CALIBRATED UNTIL
Test Receiver	ESCS 30	100375	Mar. 09, 2010	Mar. 08, 2011
Line-Impedance Stabilization Network (for EUT)	NSLK 8127	8127-522	Sep. 23, 2009	Sep. 22, 2010
Line-Impedance Stabilization Network (for Peripheral)	ESH3-Z5	848773/004	Oct. 26, 2009	Oct. 25, 2010
RF Cable (JYEBAO)	5DFB	COBCAB-001	Nov. 24, 2009	Nov. 23, 2010
50 ohms Terminator	50	3	Oct. 28, 2009	Oct. 27, 2010
Software	BV ADT_Cond_V7.3.7	NA	NA	NA

Note:

1. The calibration interval of the above test instruments is 12 months and the calibrations are traceable to NML/ROC and NIST/USA.
2. The test was performed in Shielded Room No. C.
3. The VCCI Con C Registration No. is C-3611.

4.1.3 TEST PROCEDURES

- a. The EUT was placed 0.4 meters from the conducting wall of the shielded room with EUT being connected to the power mains through a line impedance stabilization network (LISN). Other support units were connected to the power mains through another LISN. The two LISNs provide 50 ohm/ 50uH of coupling impedance for the measuring instrument.
- b. Both lines of the power mains connected to the EUT were checked for maximum conducted interference.
- c. The frequency range from 150kHz to 30MHz was searched. Emission levels under (Limit - 20dB) were not recorded.

4.1.4 DEVIATION FROM TEST STANDARD

No deviation

4.1.5 TEST SETUP

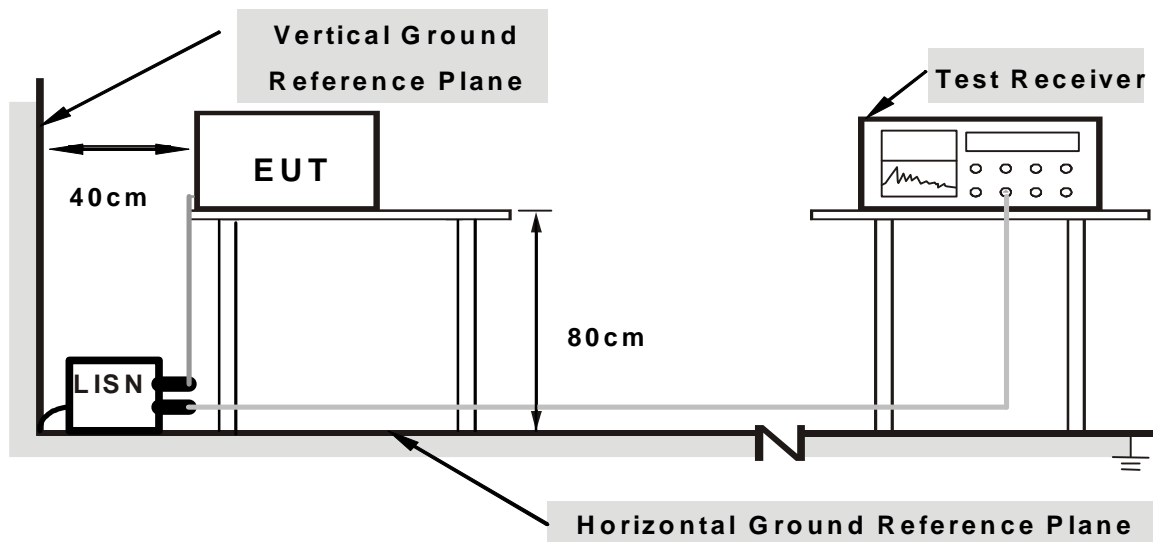

Note: 1.Support units were connected to second LISN.

2.Both of LISNs (AMN) are 80 cm from EUT and at least 80 from other units and other metal planes

For the actual test configuration, please refer to the related item – Photographs of the Test Configuration.

4.1.6 EUT OPERATING CONDITIONS

1. Connect the EUT with the support unit 1 (Notebook Computer) which is placed on a testing table.
2. The communication partner run test program “ART_win_release_ar6003_v_0.2.6_061110” to enable EUT under transmission/receiving condition continuously at specific channel frequency.

4.1.7 TEST RESULTS

PHASE	Line (L)	6dB BANDWIDTH	9 kHz
--------------	----------	----------------------	-------

No	Freq.	Corr.	Reading Value		Emission Level		Limit		Margin	
	[MHz]	Factor	[dB (uV)]		[dB (uV)]		[dB (uV)]		(dB)	
		(dB)	Q.P.	AV.	Q.P.	AV.	Q.P.	AV.	Q.P.	AV.
1	0.150	0.05	50.54	-	50.59	-	66.00	56.00	-15.41	-
2	0.158	0.05	44.76	-	44.81	-	65.58	55.58	-20.76	-
3	1.829	0.12	37.05	-	37.17	-	56.00	46.00	-18.83	-
4	1.930	0.13	34.72	-	34.85	-	56.00	46.00	-21.15	-
5	16.206	0.45	38.04	-	38.49	-	60.00	50.00	-21.51	-
6	19.086	0.50	35.51	-	36.01	-	60.00	50.00	-23.99	-

- REMARKS:**
1. Q.P. and AV. are abbreviations of quasi-peak and average individually.
 2. "-": The Quasi-peak reading value also meets average limit and measurement with the average detector is unnecessary.
 3. The emission levels of other frequencies were very low against the limit.
 4. Margin value = Emission level - Limit value
 5. Correction factor = Insertion loss + Cable loss
 6. Emission Level = Correction Factor + Reading Value.

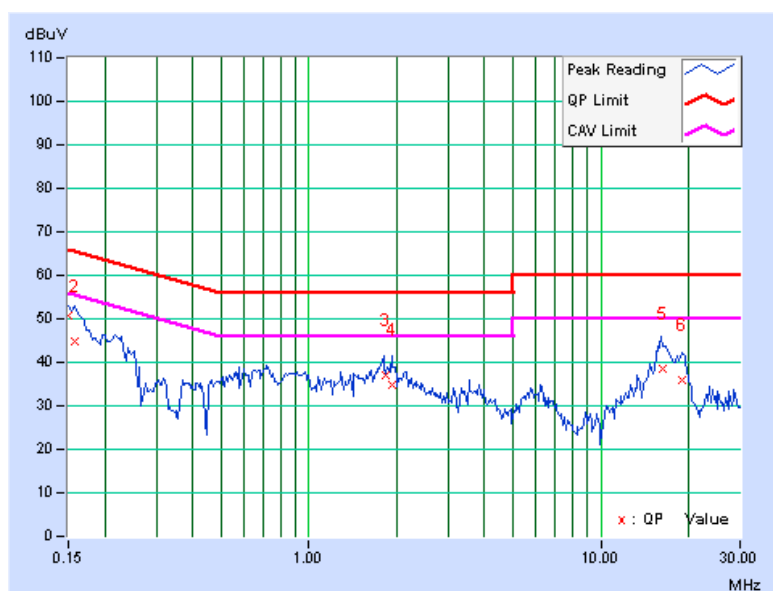

PHASE	Neutral (N)	6dB BANDWIDTH	9 kHz
--------------	-------------	----------------------	-------

No	Freq. [MHz]	Corr. Factor (dB)	Reading Value [dB (uV)]		Emission Level [dB (uV)]		Limit [dB (uV)]		Margin (dB)	
			Q.P.	AV.	Q.P.	AV.	Q.P.	AV.	Q.P.	AV.
			1	0.152	0.06	45.73	-	45.79	-	65.90
2	0.642	0.08	31.16	-	31.24	-	56.00	46.00	-24.76	-
3	2.565	0.16	28.98	-	29.14	-	56.00	46.00	-26.86	-
4	7.206	0.29	28.54	-	28.83	-	60.00	50.00	-31.17	-
5	15.852	0.45	41.24	-	41.69	-	60.00	50.00	-18.31	-
6	16.670	0.47	39.12	-	39.59	-	60.00	50.00	-20.41	-

- REMARKS:**
1. Q.P. and AV. are abbreviations of quasi-peak and average individually.
 2. "-": The Quasi-peak reading value also meets average limit and measurement with the average detector is unnecessary.
 3. The emission levels of other frequencies were very low against the limit.
 4. Margin value = Emission level - Limit value
 5. Correction factor = Insertion loss + Cable loss
 6. Emission Level = Correction Factor + Reading Value.

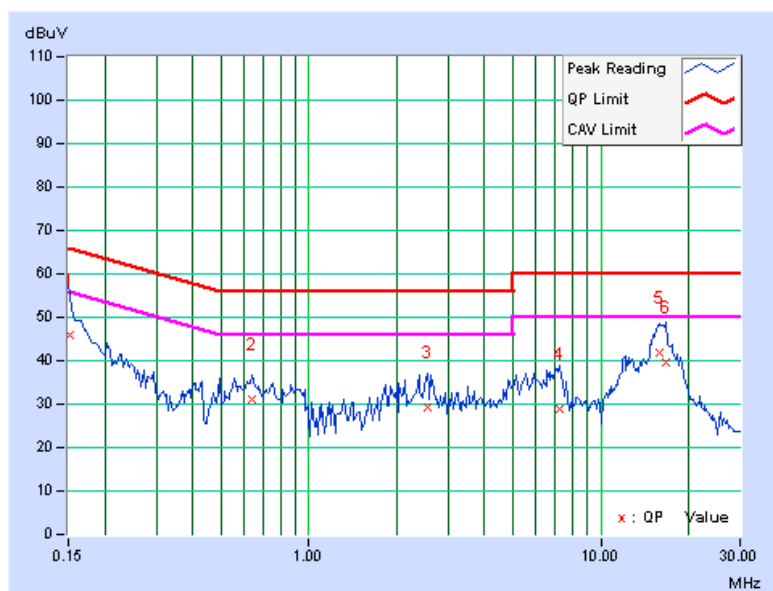

4.2 RADIATED EMISSION MEASUREMENT

4.2.1 LIMITS OF RADIATED EMISSION MEASUREMENT

Emissions radiated outside of the specified bands, shall be according to the general radiated limits in 15.209(RSS-210 table 2&3) as following:

Frequencies (MHz)	Field strength (microvolts/meter)	Measurement distance (meters)
0.009-0.490	2400/F(kHz)	300
0.490-1.705	24000/F(kHz)	30
1.705-30.0	30	30
30-88	100	3
88-216	150	3
216-960	200	3
Above 960	500	3

NOTE:

1. The lower limit shall apply at the transition frequencies.
2. Emission level (dBuV/m) = 20 log Emission level (uV/m).
3. As shown in 15.35(b), for frequencies above 1000MHz, the field strength limits are based on average detector, however, the peak field strength of any emission shall not exceed the maximum permitted average limits, specified above by more than 20dB under any condition of modulation.
4. Section 15.205 restricted bands of operation shall compliance with the limits in Section 15.209.



A D T

4.2.2 TEST INSTRUMENTS

DESCRIPTION & MANUFACTURER	MODEL NO.	SERIAL NO.	CALIBRATED DATE	CALIBRATED UNTIL
Agilent Spectrum Analyzer	E4446A	MY48250254	July 14, 2010	July 13, 2011
Agilent Pre-Selector	N9039A	MY46520310	Aug. 18, 2009	Aug. 17, 2010
Agilent Signal Generator	N5181A	MY49060347	July 18, 2010	July 17, 2011
LIG NEX1 Test Receiver	ER-265	L09068005	Aug. 31, 2009	Aug. 30, 2010
Mini-Circuits Pre-Amplifier	ZFL-1000VH2B	AMP-ZFL-04	Nov. 18, 2009	Nov. 17, 2010
Agilent Pre-Amplifier	8449B	3008A02465	Mar. 01, 2010	Feb. 28, 2011
Miteq Pre-Amplifier	AFS33-1800265 0-30-8P-44	881786	NA	NA
SCHWARZBECK Trilog Broadband Antenna	VULB 9168	9168-361	Sep. 30, 2009	Sep. 29, 2010
AISI Horn_Antenna	AIH.8018	0000220091110	Nov. 16, 2009	Nov. 15, 2010
SCHWARZBECK Horn_Antenna	BBHA 9170	9170-424	Sep. 30, 2009	Sep. 29, 2010
RF CABLE	NA	RF104-205 RF104-207 RF104-208	Dec. 24, 2009	Dec. 23, 2010
RF Cable	NA	CHHCAB_001	NA	NA
Software	ADT_Radiated_V8.7.05	NA	NA	NA
CT Antenna Tower & Turn Table	NA	NA	NA	NA

Note: 1. The calibration interval of the above test instruments is 12 months and the calibrations are traceable to NML/ROC and NIST/USA.

2. The horn antenna, preamplifier (model: 8449B) are used only for the measurement of emission frequency above 1GHz if tested.

3. The test was performed in 966 Chamber No. H.

4. The FCC Site Registration No. is 797305.

5. The CANADA Site Registration No. is IC 7450H-3.

4.2.3 TEST PROCEDURES

- a. The EUT was placed on the top of a rotating table 0.8 meters above the ground at a 3 meter chamber room. The table was rotated 360 degrees to determine the position of the highest radiation.
- b. The EUT was set 3 meters away from the interference-receiving antenna, which was mounted on the top of a variable-height antenna tower.
- c. The antenna is a broadband antenna, and its height is varied from one meter to four meters above the ground to determine the maximum value of the field strength. Both horizontal and vertical polarizations of the antenna are set to make the measurement.
- d. For each suspected emission, the EUT was arranged to its worst case and then the antenna was tuned to heights from 1 meter to 4 meters and the rotatable table was turned from 0 degrees to 360 degrees to find the maximum reading.
- e. The test-receiver system was set to quasi-peak detect function and specified bandwidth with maximum hold mode when the test frequency is below 1 GHz.
- f. The test-receiver system was set to peak and average detect function and specified bandwidth with maximum hold mode when the test frequency is above 1 GHz. If the peak reading value also meets average limit, measurement with the average detector is unnecessary.

NOTE:

1. The resolution bandwidth and video bandwidth of test receiver/spectrum analyzer is 120kHz for Quasi-peak detection (QP) at frequency below 1GHz.
2. The resolution bandwidth of test receiver/spectrum analyzer is 1 MHz and the video bandwidth is 3 MHz for Peak detection (PK) at frequency above 1GHz.
3. The resolution bandwidth of test receiver/spectrum analyzer is 1 MHz and the video bandwidth is 10 Hz for Average detection (AV) at frequency above 1GHz.

4.2.4 DEVIATION FROM TEST STANDARD

No deviation

4.2.5 TEST SETUP

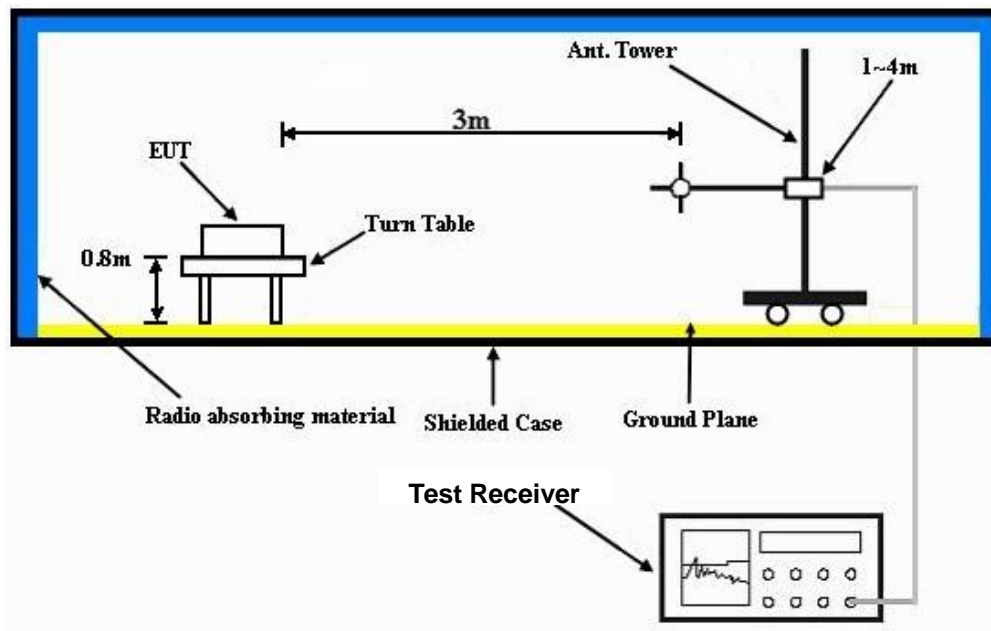

For the actual test configuration, please refer to the related item – Photographs of the Test Configuration.

4.2.6 EUT OPERATING CONDITIONS

Same as 4.1.6

4.2.7 TEST RESULTS (FOR TRANSMITTER PART)

BELOW 1GHz WORST-CASE DATA : 802.11g OFDM MODULATION

EUT TEST CONDITION		MEASUREMENT DETAIL	
CHANNEL	Channel 6	FREQUENCY RANGE	Below 1000MHz
INPUT POWER (SYSTEM)	120Vac, 60 Hz	DETECTOR FUNCTION	Quasi-Peak
ENVIRONMENTAL CONDITIONS	24deg. C, 70%RH 1013 hPa	TESTED BY	Eric Lee

ANTENNA POLARITY & TEST DISTANCE: HORIZONTAL AT 3 M								
NO.	FREQ. (MHz)	EMISSION LEVEL (dBuV/m)	LIMIT (dBuV/m)	MARGIN (dB)	ANTENNA HEIGHT (m)	TABLE ANGLE (Degree)	RAW VALUE (dBuV)	CORRECTION FACTOR (dB/m)
1	99.65	33.7 QP	43.5	-9.8	1.75 H	360	23.75	9.95
2	116.50	35.4 QP	43.5	-8.1	1.50 H	358	23.11	12.29
3	133.16	33.9 QP	43.5	-9.6	2.25 H	0	20.21	13.69
4	149.90	35.8 QP	43.5	-7.7	1.50 H	360	21.52	14.30
5	166.55	42.0 QP	43.5	-1.5	1.75 H	220	28.00	14.00
6	199.30	37.4 QP	43.5	-6.1	1.25 H	0	26.14	11.26
7	248.96	39.8 QP	46.0	-6.2	1.25 H	281	26.91	12.91
ANTENNA POLARITY & TEST DISTANCE: VERTICAL AT 3 M								
NO.	FREQ. (MHz)	EMISSION LEVEL (dBuV/m)	LIMIT (dBuV/m)	MARGIN (dB)	ANTENNA HEIGHT (m)	TABLE ANGLE (Degree)	RAW VALUE (dBuV)	CORRECTION FACTOR (dB/m)
1	33.50	37.8 QP	40.0	-2.2	1.00 V	291	24.32	13.46
2	99.80	26.8 QP	43.5	-16.7	1.00 V	28	16.85	9.95
3	149.86	33.6 QP	43.5	-9.9	1.25 V	360	19.30	14.30
4	166.05	34.4 QP	43.5	-9.1	2.25 V	312	20.38	14.02
5	248.82	33.3 QP	46.0	-12.7	1.00 V	217	20.39	12.91
6	365.25	31.0 QP	46.0	-15.0	1.75 V	360	14.12	16.88

- REMARKS:**
1. Emission level (dBuV/m) = Raw Value (dBuV) + Correction Factor (dB/m).
 2. Correction Factor (dB/m) = Antenna Factor (dB/m) + Cable Factor (dB).
 3. The other emission levels were very low against the limit.
 4. Margin value = Emission level – Limit value.



ABOVE 1GHz WORST-CASE DATA

802.11b DSSS MODULATION

EUT TEST CONDITION		MEASUREMENT DETAIL	
CHANNEL	Channel 1	FREQUENCY RANGE	1 ~ 25GHz
INPUT POWER (SYSTEM)	120Vac, 60 Hz	DETECTOR FUNCTION	Peak (PK) Average (AV)
ENVIRONMENTAL CONDITIONS	28deg. C, 74%RH 1013 hPa	TESTED BY	Rex Huang

ANTENNA POLARITY & TEST DISTANCE: HORIZONTAL AT 3 M								
NO.	FREQ. (MHz)	EMISSION LEVEL (dBuV/m)	LIMIT (dBuV/m)	MARGIN (dB)	ANTENNA HEIGHT (m)	TABLE ANGLE (Degree)	RAW VALUE (dBuV)	CORRECTION FACTOR (dB/m)
1	2386.00	59.7 PK	74.0	-14.3	1.77 H	306	28.50	31.20
2	2386.00	52.2 AV	54.0	-1.8	1.77 H	306	21.00	31.20
3	*2412.00	105.4 PK			1.76 H	304	74.13	31.27
4	*2412.00	102.9 AV			1.76 H	304	71.63	31.27
5	4824.00	51.5 PK	74.0	-22.5	1.04 H	108	12.08	39.42
6	4824.00	47.4 AV	54.0	-6.6	1.04 H	108	7.98	39.42
ANTENNA POLARITY & TEST DISTANCE: VERTICAL AT 3 M								
NO.	FREQ. (MHz)	EMISSION LEVEL (dBuV/m)	LIMIT (dBuV/m)	MARGIN (dB)	ANTENNA HEIGHT (m)	TABLE ANGLE (Degree)	RAW VALUE (dBuV)	CORRECTION FACTOR (dB/m)
1	2386.10	58.1 PK	74.0	-15.9	1.22 V	60	26.90	31.20
2	2386.10	49.7 AV	54.0	-4.3	1.22 V	60	18.50	31.20
3	*2412.00	100.1 PK			1.22 V	55	68.83	31.27
4	*2412.00	97.5 AV			1.22 V	55	66.23	31.27
5	4824.00	54.1 PK	74.0	-19.9	1.04 V	4	14.68	39.42
6	4824.00	51.5 AV	54.0	-2.5	1.04 V	4	12.08	39.42

- REMARKS:**
1. Emission level (dBuV/m) = Raw Value (dBuV) + Correction Factor (dB/m).
 2. Correction Factor (dB/m) = Antenna Factor (dB/m) + Cable Factor (dB).
 3. The other emission levels were very low against the limit.
 4. Margin value = Emission level – Limit value.
 5. “ * “: Fundamental frequency.



A D T

EUT TEST CONDITION		MEASUREMENT DETAIL	
CHANNEL	Channel 6	FREQUENCY RANGE	1 ~ 25GHz
INPUT POWER (SYSTEM)	120Vac, 60 Hz	DETECTOR FUNCTION	Peak (PK) Average (AV)
ENVIRONMENTAL CONDITIONS	28deg. C, 74%RH 1013 hPa	TESTED BY	Rex Huang

ANTENNA POLARITY & TEST DISTANCE: HORIZONTAL AT 3 M								
NO.	FREQ. (MHz)	EMISSION LEVEL (dBuV/m)	LIMIT (dBuV/m)	MARGIN (dB)	ANTENNA HEIGHT (m)	TABLE ANGLE (Degree)	RAW VALUE (dBuV)	CORRECTION FACTOR (dB/m)
1	*2437.00	107.9 PK			1.72 H	306	76.56	31.34
2	*2437.00	105.1 AV			1.72 H	306	73.76	31.34
3	4874.00	52.1 PK	74.0	-21.9	1.02 H	158	12.48	39.62
4	4874.00	48.1 AV	54.0	-5.9	1.02 H	158	8.48	39.62
5	7311.00	54.1 PK	74.0	-19.9	1.50 H	299	10.00	44.10
6	7311.00	41.7 AV	54.0	-12.3	1.50 H	299	-2.40	44.10

ANTENNA POLARITY & TEST DISTANCE: VERTICAL AT 3 M								
NO.	FREQ. (MHz)	EMISSION LEVEL (dBuV/m)	LIMIT (dBuV/m)	MARGIN (dB)	ANTENNA HEIGHT (m)	TABLE ANGLE (Degree)	RAW VALUE (dBuV)	CORRECTION FACTOR (dB/m)
1	*2437.00	102.4 PK			1.19 V	65	71.06	31.34
2	*2437.00	98.4 AV			1.19 V	65	67.06	31.34
3	4874.00	53.4 PK	74.0	-20.6	1.10 V	216	13.78	39.62
4	4874.00	51.3 AV	54.0	-2.7	1.10 V	216	11.68	39.62
5	7311.00	54.7 PK	74.0	-19.3	1.23 V	57	10.60	44.10
6	7311.00	42.8 AV	54.0	-11.2	1.23 V	57	-1.30	44.10

- REMARKS:**
1. Emission level (dBuV/m) = Raw Value (dBuV) + Correction Factor (dB/m).
 2. Correction Factor (dB/m) = Antenna Factor (dB/m) + Cable Factor (dB).
 3. The other emission levels were very low against the limit.
 4. Margin value = Emission level – Limit value.
 5. “ * “: Fundamental frequency.



EUT TEST CONDITION		MEASUREMENT DETAIL	
CHANNEL	Channel 11	FREQUENCY RANGE	1 ~ 25GHz
INPUT POWER (SYSTEM)	120Vac, 60 Hz	DETECTOR FUNCTION	Peak (PK) Average (AV)
ENVIRONMENTAL CONDITIONS	28deg. C, 74%RH 1013 hPa	TESTED BY	Rex Huang

ANTENNA POLARITY & TEST DISTANCE: HORIZONTAL AT 3 M								
NO.	FREQ. (MHz)	EMISSION LEVEL (dBuV/m)	LIMIT (dBuV/m)	MARGIN (dB)	ANTENNA HEIGHT (m)	TABLE ANGLE (Degree)	RAW VALUE (dBuV)	CORRECTION FACTOR (dB/m)
1	*2462.00	105.3 PK			1.70 H	307	73.90	31.40
2	*2462.00	103.1 AV			1.70 H	307	71.70	31.40
3	2488.00	60.0 PK	74.0	-14.0	1.69 H	311	28.53	31.47
4	2488.00	52.4 AV	54.0	-1.6	1.69 H	311	20.93	31.47
5	4924.00	51.1 PK	74.0	-22.9	1.00 H	112	11.28	39.82
6	4924.00	47.4 AV	54.0	-6.6	1.00 H	112	7.58	39.82
7	7386.00	53.1 PK	74.0	-20.9	1.60 H	300	8.92	44.18
8	7386.00	39.9 AV	54.0	-14.1	1.60 H	300	-4.28	44.18
ANTENNA POLARITY & TEST DISTANCE: VERTICAL AT 3 M								
NO.	FREQ. (MHz)	EMISSION LEVEL (dBuV/m)	LIMIT (dBuV/m)	MARGIN (dB)	ANTENNA HEIGHT (m)	TABLE ANGLE (Degree)	RAW VALUE (dBuV)	CORRECTION FACTOR (dB/m)
1	*2462.00	98.1 PK			1.22 V	63	66.70	31.40
2	*2462.00	96.1 AV			1.22 V	63	64.70	31.40
3	2487.80	58.6 PK	74.0	-15.4	1.19 V	59	27.13	31.47
4	2487.80	48.0 AV	54.0	-6.0	1.19 V	59	16.53	31.47
5	4924.00	53.7 PK	74.0	-20.3	1.05 V	94	13.88	39.82
6	4924.00	50.7 AV	54.0	-3.3	1.05 V	94	10.88	39.82
7	7386.00	54.8 PK	74.0	-19.2	1.14 V	106	10.62	44.18
8	7386.00	41.4 AV	54.0	-12.6	1.14 V	106	-2.78	44.18

- REMARKS:**
1. Emission level (dBuV/m) = Raw Value (dBuV) + Correction Factor (dB/m).
 2. Correction Factor (dB/m) = Antenna Factor (dB/m) + Cable Factor (dB).
 3. The other emission levels were very low against the limit.
 4. Margin value = Emission level – Limit value.
 5. “ * “: Fundamental frequency.



A D T

RESTRICTED BANDEDGE (802.11b MODE, CH1, HORIZONTAL)

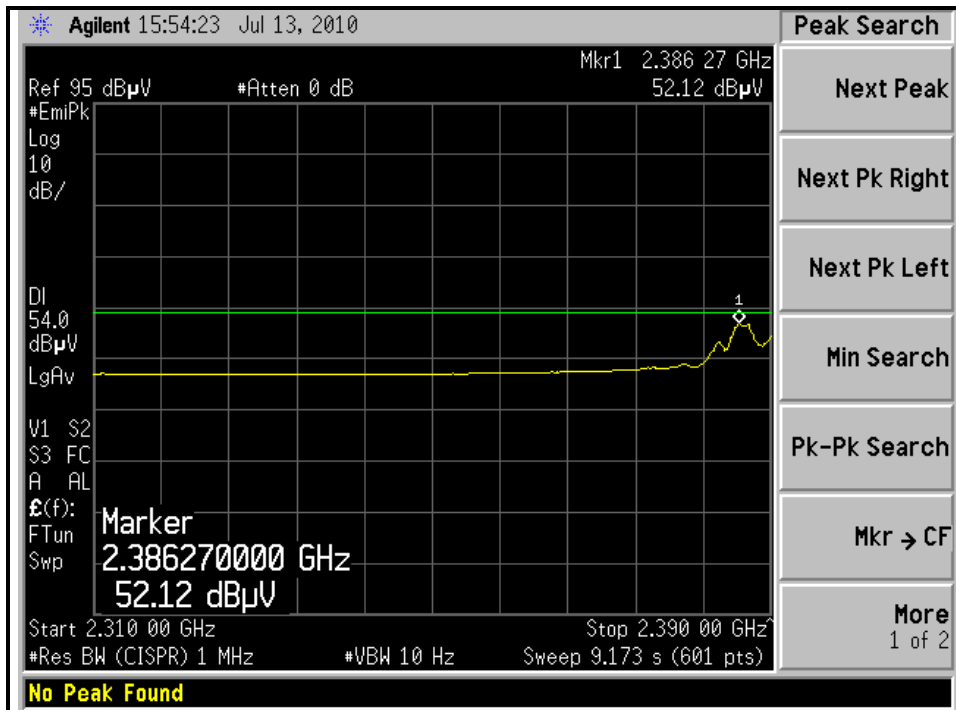
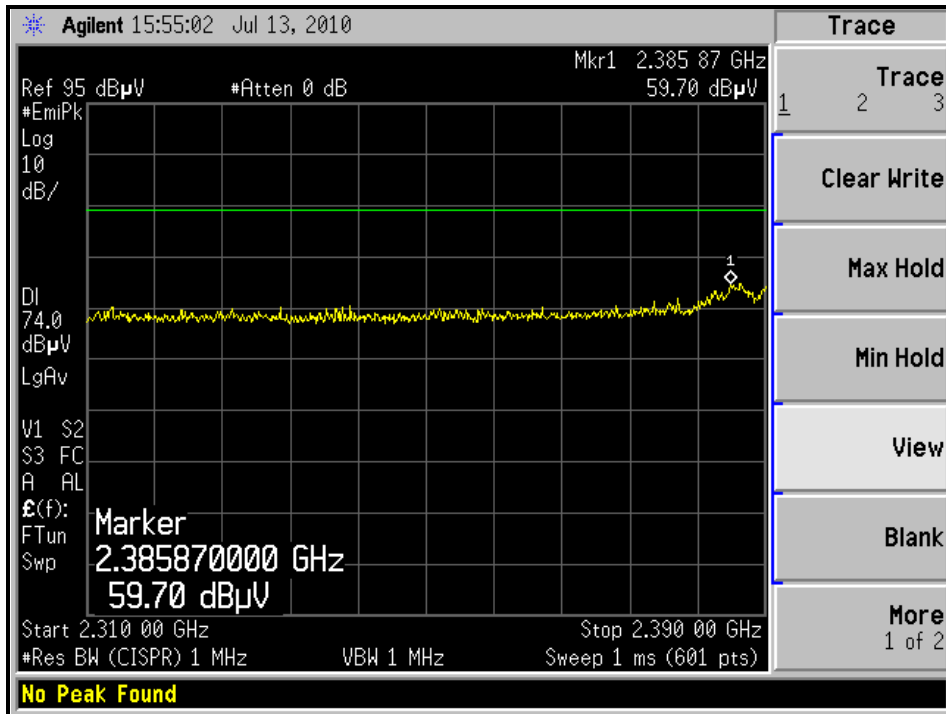



A D T

RESTRICTED BANDEDGE (802.11b MODE, CH1, VERTICAL)

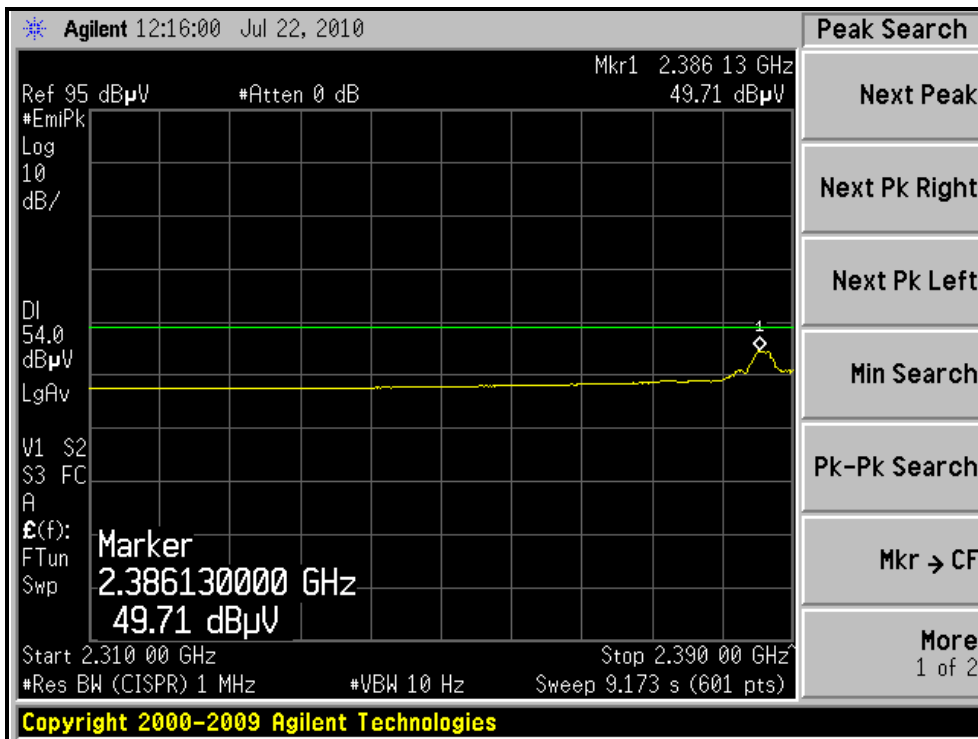
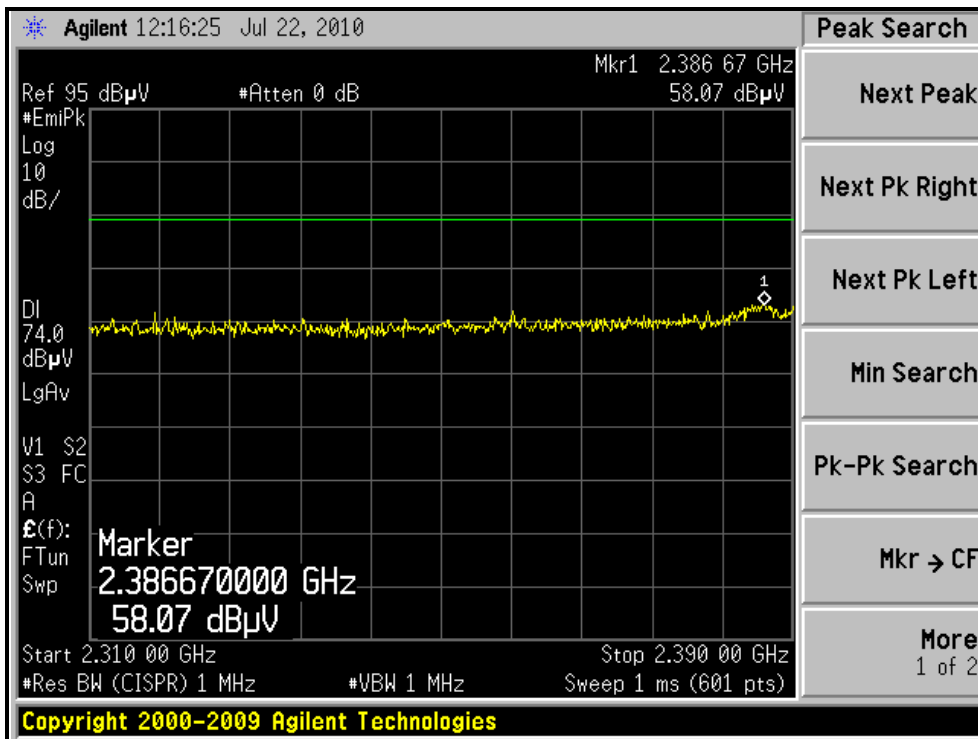



A D T

RESTRICTED BANDEDGE (802.11b MODE, CH11, HORIZONTAL)

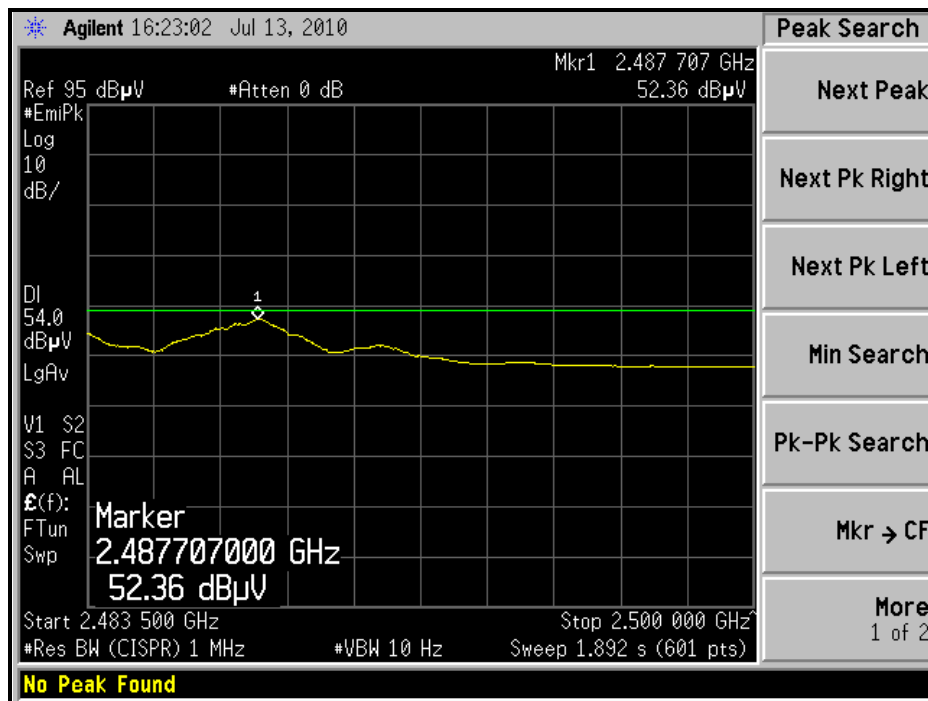
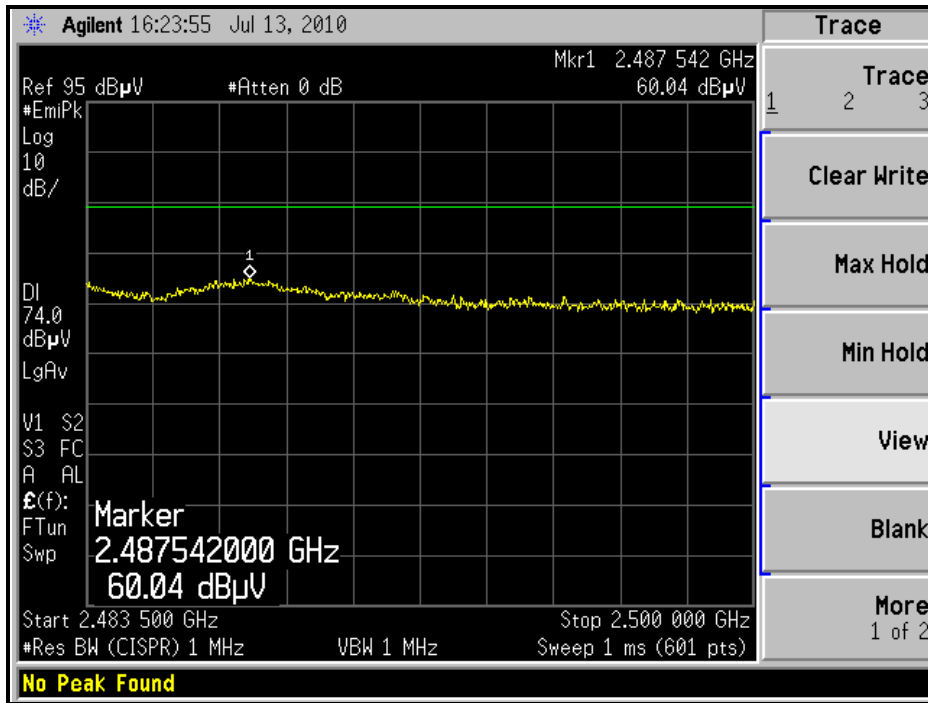



A D T

RESTRICTED BANDEDGE (802.11b MODE, CH11, VERTICAL)

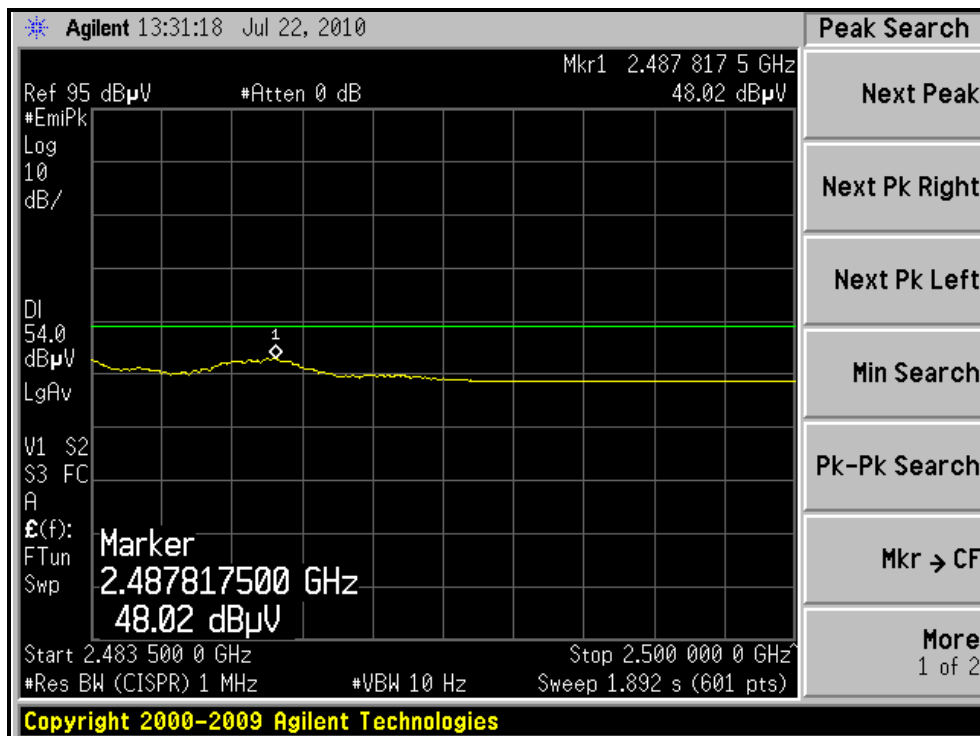
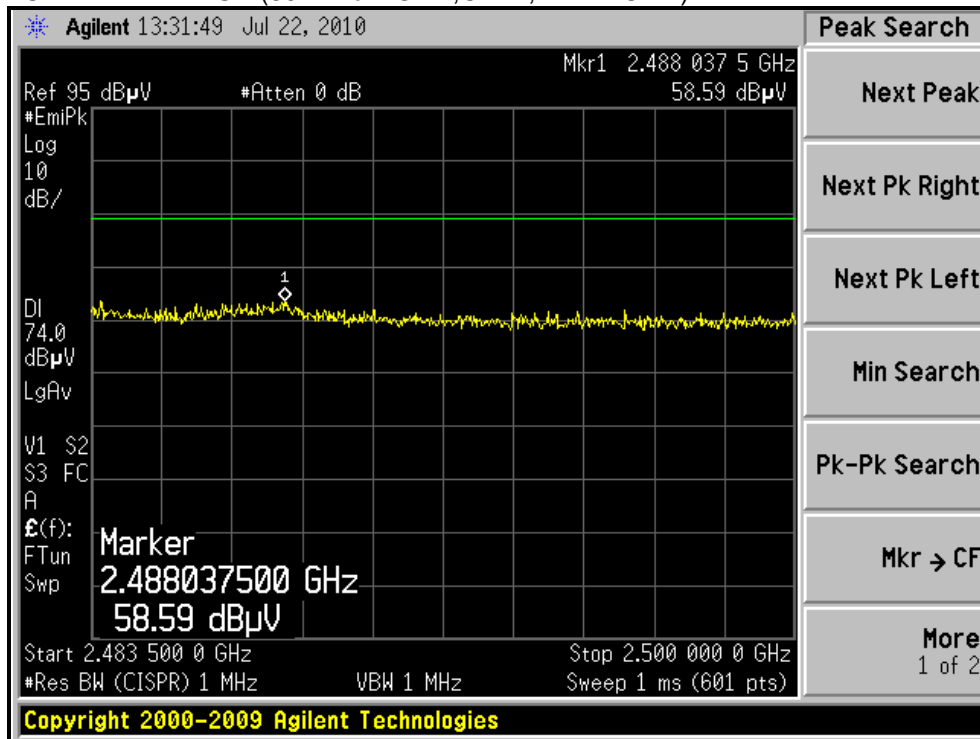



802.11g OFDM MODULATION

EUT TEST CONDITION		MEASUREMENT DETAIL	
CHANNEL	Channel 1	FREQUENCY RANGE	1 ~ 25GHz
INPUT POWER (SYSTEM)	120Vac, 60 Hz	DETECTOR FUNCTION	Peak (PK) Average (AV)
ENVIRONMENTAL CONDITIONS	28deg. C, 74%RH 1013 hPa	TESTED BY	Rex Huang

ANTENNA POLARITY & TEST DISTANCE: HORIZONTAL AT 3 M								
NO.	FREQ. (MHz)	EMISSION LEVEL (dBuV/m)	LIMIT (dBuV/m)	MARGIN (dB)	ANTENNA HEIGHT (m)	TABLE ANGLE (Degree)	RAW VALUE (dBuV)	CORRECTION FACTOR (dB/m)
1	2390.00	69.4 PK	74.0	-4.6	1.78 H	306	38.19	31.21
2	2390.00	53.0 AV	54.0	-1.0	1.78 H	306	21.79	31.21
3	*2412.00	106.3 PK			1.74 H	304	75.03	31.27
4	*2412.00	96.0 AV			1.74 H	304	64.73	31.27
5	4824.00	48.9 PK	74.0	-25.1	1.44 H	71	9.48	39.42
6	4824.00	38.9 AV	54.0	-15.1	1.44 H	71	-0.52	39.42
ANTENNA POLARITY & TEST DISTANCE: VERTICAL AT 3 M								
NO.	FREQ. (MHz)	EMISSION LEVEL (dBuV/m)	LIMIT (dBuV/m)	MARGIN (dB)	ANTENNA HEIGHT (m)	TABLE ANGLE (Degree)	RAW VALUE (dBuV)	CORRECTION FACTOR (dB/m)
1	2390.00	62.5 PK	74.0	-11.5	1.21 V	60	31.29	31.21
2	2390.00	48.8 AV	54.0	-5.2	1.21 V	60	17.59	31.21
3	*2412.00	100.2 PK			1.22 V	55	68.93	31.27
4	*2412.00	89.3 AV			1.22 V	55	58.03	31.27
5	4824.00	50.2 PK	74.0	-23.8	1.14 V	83	10.78	39.42
6	4824.00	41.9 AV	54.0	-12.1	1.14 V	83	2.48	39.42

- REMARKS:**
1. Emission level (dBuV/m) = Raw Value (dBuV) + Correction Factor (dB/m).
 2. Correction Factor (dB/m) = Antenna Factor (dB/m) + Cable Factor (dB).
 3. The other emission levels were very low against the limit.
 4. Margin value = Emission level – Limit value.
 5. “ * “: Fundamental frequency.



A D T

EUT TEST CONDITION		MEASUREMENT DETAIL	
CHANNEL	Channel 6	FREQUENCY RANGE	1 ~ 25GHz
INPUT POWER (SYSTEM)	120Vac, 60 Hz	DETECTOR FUNCTION	Peak (PK) Average (AV)
ENVIRONMENTAL CONDITIONS	28deg. C, 74%RH 1013 hPa	TESTED BY	Rex Huang

ANTENNA POLARITY & TEST DISTANCE: HORIZONTAL AT 3 M								
NO.	FREQ. (MHz)	EMISSION LEVEL (dBuV/m)	LIMIT (dBuV/m)	MARGIN (dB)	ANTENNA HEIGHT (m)	TABLE ANGLE (Degree)	RAW VALUE (dBuV)	CORRECTION FACTOR (dB/m)
1	*2437.00	112.6 PK			1.71 H	306	81.26	31.34
2	*2437.00	102.5 AV			1.71 H	306	71.16	31.34
3	4874.00	61.1 PK	74.0	-12.9	1.69 H	248	21.48	39.62
4	4874.00	46.9 AV	54.0	-7.1	1.69 H	248	7.28	39.62
5	7311.00	55.6 PK	74.0	-18.4	1.23 H	50	11.50	44.10
6	7311.00	41.5 AV	54.0	-12.5	1.23 H	50	-2.60	44.10
ANTENNA POLARITY & TEST DISTANCE: VERTICAL AT 3 M								
NO.	FREQ. (MHz)	EMISSION LEVEL (dBuV/m)	LIMIT (dBuV/m)	MARGIN (dB)	ANTENNA HEIGHT (m)	TABLE ANGLE (Degree)	RAW VALUE (dBuV)	CORRECTION FACTOR (dB/m)
1	*2437.00	106.5 PK			1.20 V	360	75.16	31.34
2	*2437.00	96.8 AV			1.20 V	360	65.46	31.34
3	4874.00	63.4 PK	74.0	-10.6	1.11 V	150	23.78	39.62
4	4874.00	48.5 AV	54.0	-5.5	1.11 V	150	8.88	39.62
5	7311.00	57.2 PK	74.0	-16.8	1.28 V	11	13.10	44.10
6	7311.00	42.4 AV	54.0	-11.6	1.28 V	11	-1.70	44.10

- REMARKS:**
1. Emission level (dBuV/m) = Raw Value (dBuV) + Correction Factor (dB/m).
 2. Correction Factor (dB/m) = Antenna Factor (dB/m) + Cable Factor (dB).
 3. The other emission levels were very low against the limit.
 4. Margin value = Emission level – Limit value.
 5. “ * “: Fundamental frequency.



A D T

EUT TEST CONDITION		MEASUREMENT DETAIL	
CHANNEL	Channel 11	FREQUENCY RANGE	1 ~ 25GHz
INPUT POWER (SYSTEM)	120Vac, 60 Hz	DETECTOR FUNCTION	Peak (PK) Average (AV)
ENVIRONMENTAL CONDITIONS	28deg. C, 74%RH 1013 hPa	TESTED BY	Rex Huang

ANTENNA POLARITY & TEST DISTANCE: HORIZONTAL AT 3 M								
NO.	FREQ. (MHz)	EMISSION LEVEL (dBuV/m)	LIMIT (dBuV/m)	MARGIN (dB)	ANTENNA HEIGHT (m)	TABLE ANGLE (Degree)	RAW VALUE (dBuV)	CORRECTION FACTOR (dB/m)
1	*2462.00	106.4 PK			1.71 H	307	75.00	31.40
2	*2462.00	95.9 AV			1.71 H	307	64.50	31.40
3	2483.50	69.2 PK	74.0	-4.8	1.70 H	311	37.74	31.46
4	2483.50	53.0 AV	54.0	-1.0	1.70 H	311	21.54	31.46
5	4924.00	48.6 PK	74.0	-25.4	1.69 H	144	8.78	39.82
6	4924.00	39.1 AV	54.0	-14.9	1.69 H	144	-0.72	39.82
7	7386.00	52.1 PK	74.0	-21.9	1.11 H	48	7.92	44.18
8	7386.00	38.9 AV	54.0	-15.1	1.11 H	48	-5.28	44.18
ANTENNA POLARITY & TEST DISTANCE: VERTICAL AT 3 M								
NO.	FREQ. (MHz)	EMISSION LEVEL (dBuV/m)	LIMIT (dBuV/m)	MARGIN (dB)	ANTENNA HEIGHT (m)	TABLE ANGLE (Degree)	RAW VALUE (dBuV)	CORRECTION FACTOR (dB/m)
1	*2462.00	100.1 PK			1.20 V	48	68.70	31.40
2	*2462.00	89.2 AV			1.20 V	48	57.80	31.40
3	2483.50	67.9 PK	74.0	-6.1	1.19 V	53	36.44	31.46
4	2483.50	49.9 AV	54.0	-4.1	1.19 V	53	18.44	31.46
5	4924.00	49.9 PK	74.0	-24.1	1.48 V	26	10.08	39.82
6	4924.00	41.5 AV	54.0	-12.5	1.48 V	26	1.68	39.82
7	7386.00	53.6 PK	74.0	-20.4	1.14 V	278	9.42	44.18
8	7386.00	39.2 AV	54.0	-14.8	1.14 V	278	-4.98	44.18

- REMARKS:**
1. Emission level (dBuV/m) = Raw Value (dBuV) + Correction Factor (dB/m).
 2. Correction Factor (dB/m) = Antenna Factor (dB/m) + Cable Factor (dB).
 3. The other emission levels were very low against the limit.
 4. Margin value = Emission level – Limit value.
 5. “ * “: Fundamental frequency.



A D T

RESTRICTED BANDEDGE (802.11g MODE,CH1, HORIZONTAL)

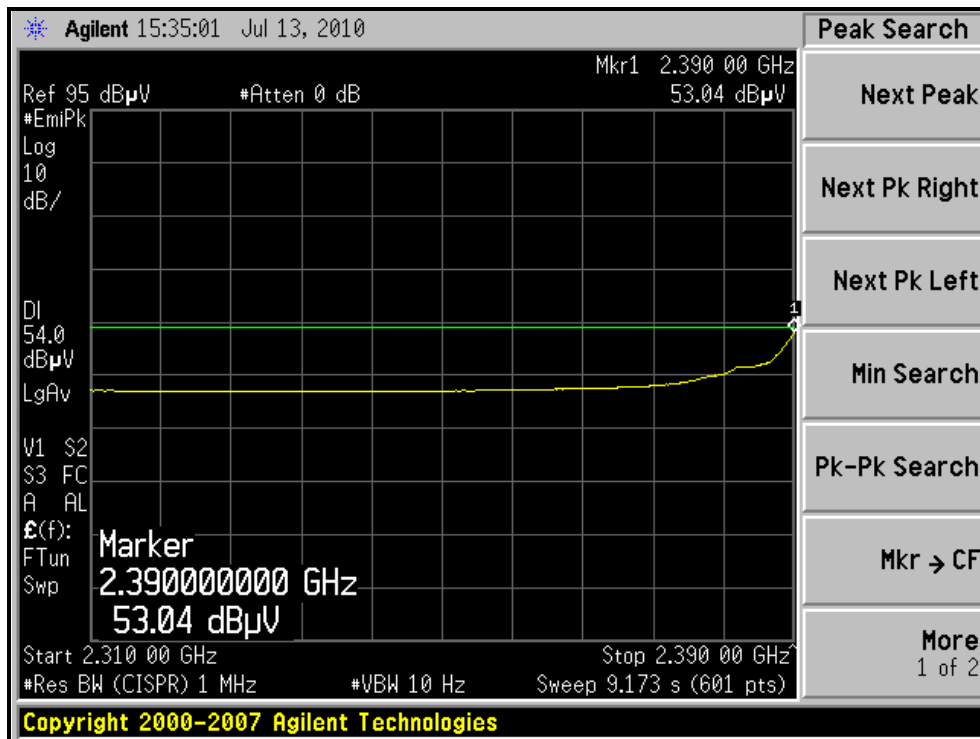
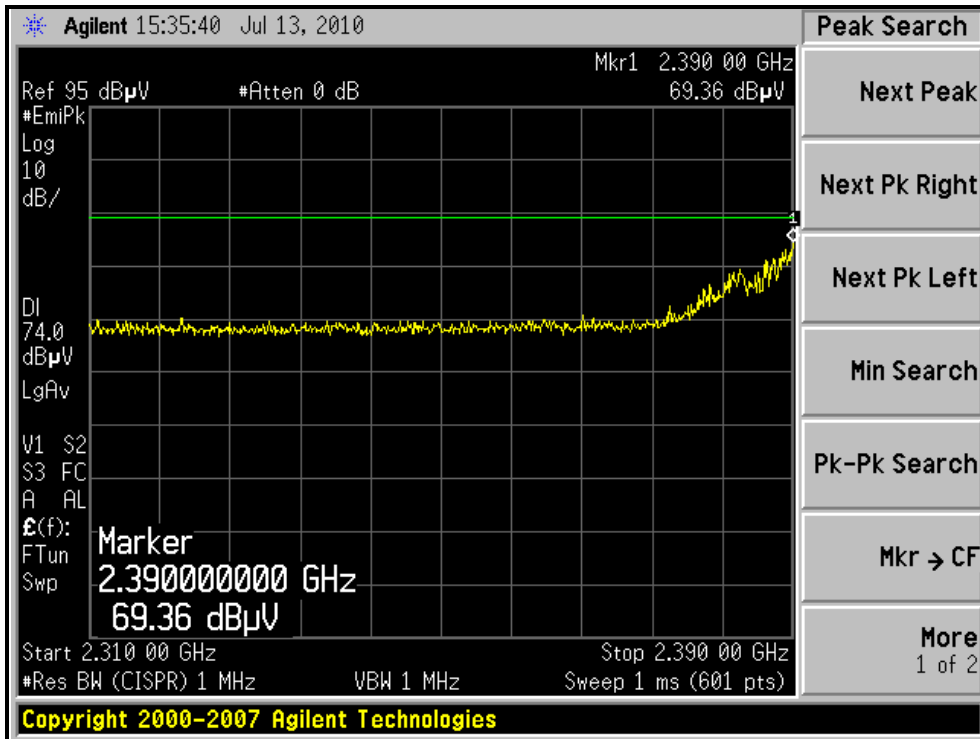



A D T

RESTRICTED BANDEDGE (802.11g MODE, CH1, VERTICAL)

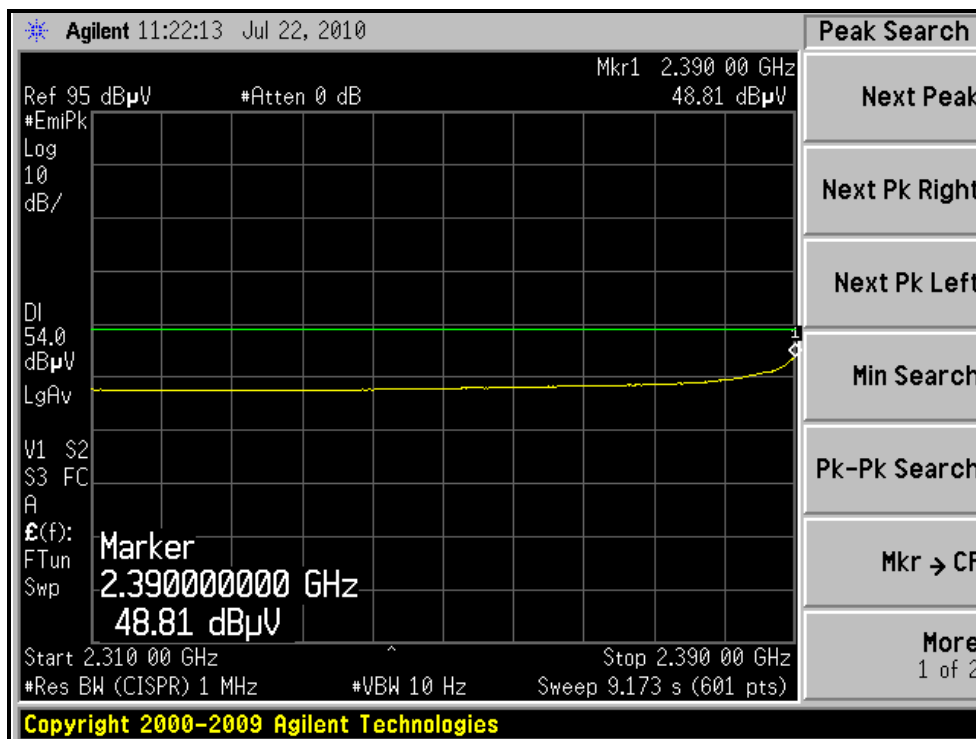
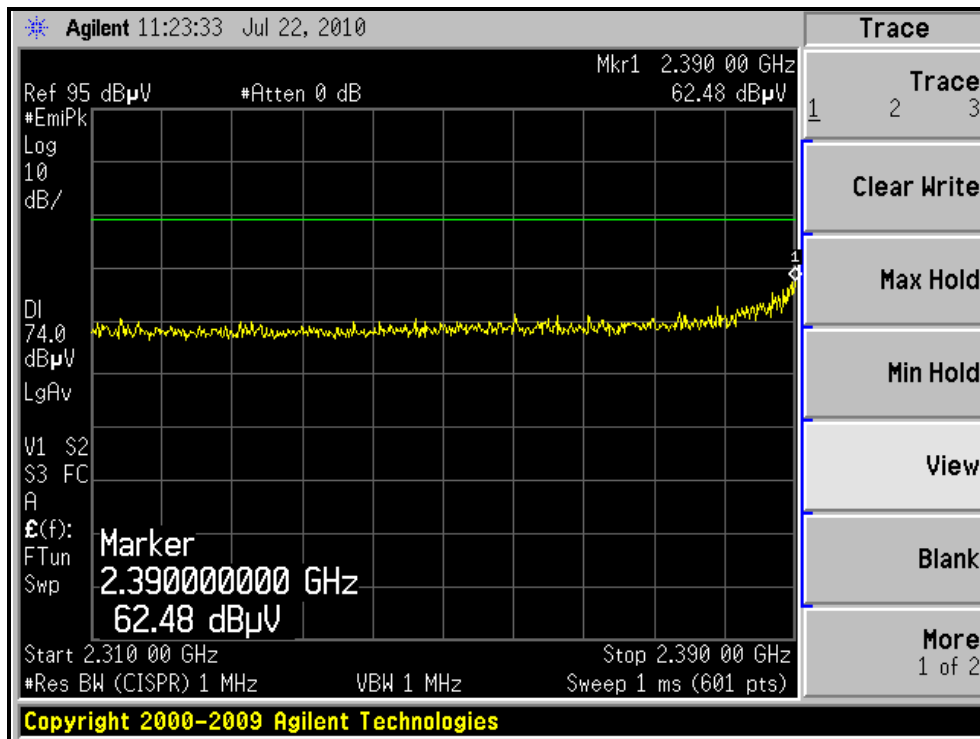



A D T

RESTRICTED BANDEDGE (802.11g MODE,CH11, HORIZONTAL)

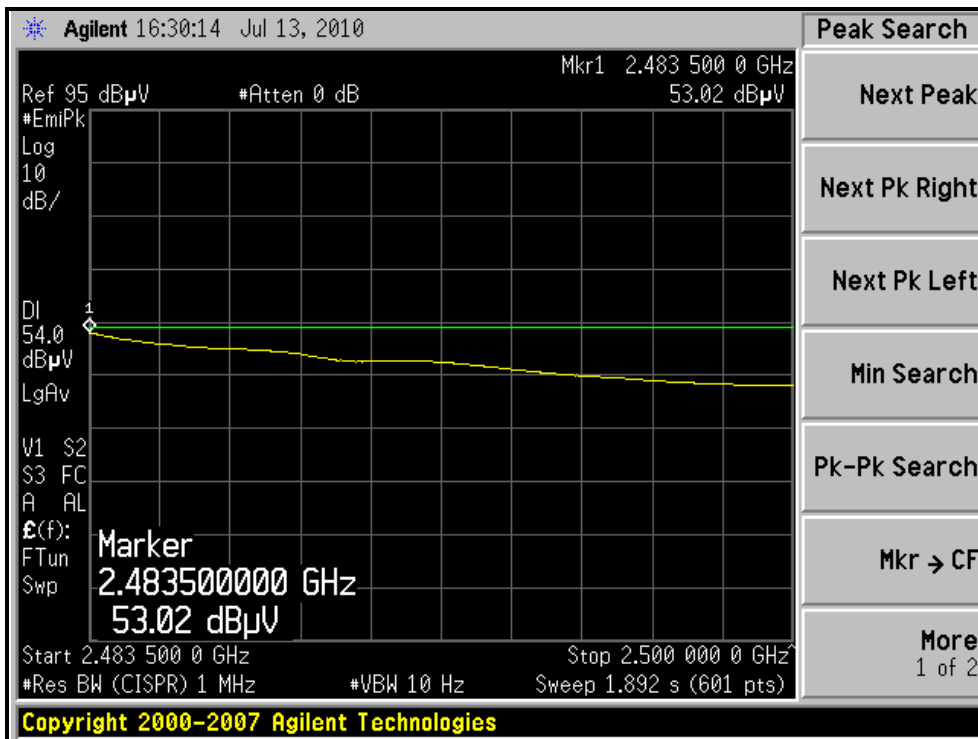
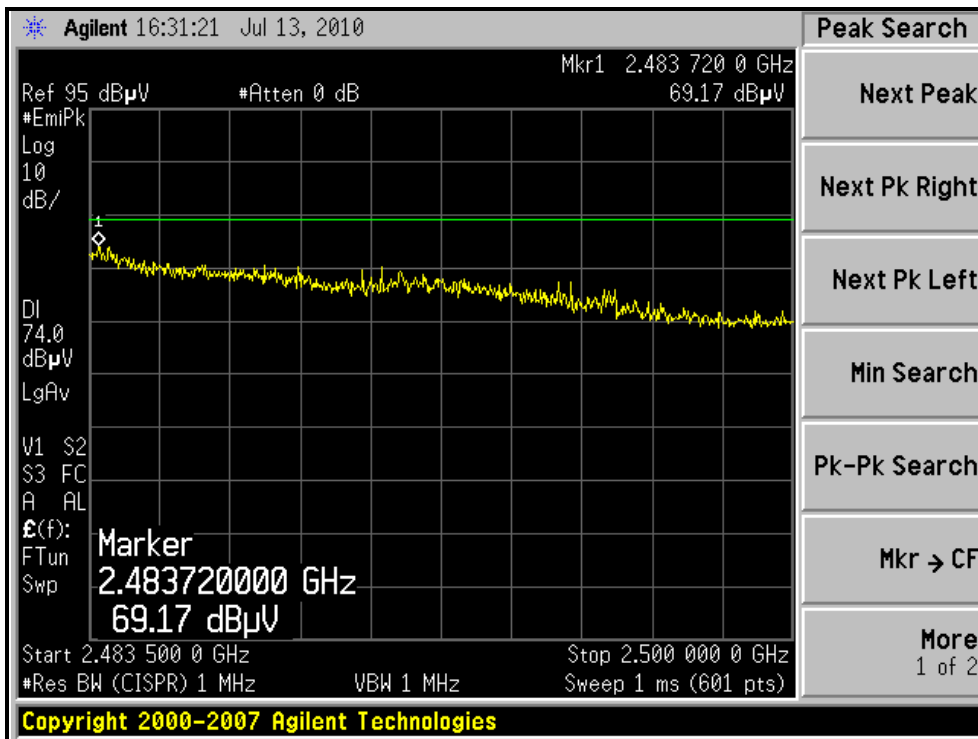



A D T

RESTRICTED BANDEDGE (802.11g MODE,CH11, VERTICAL)

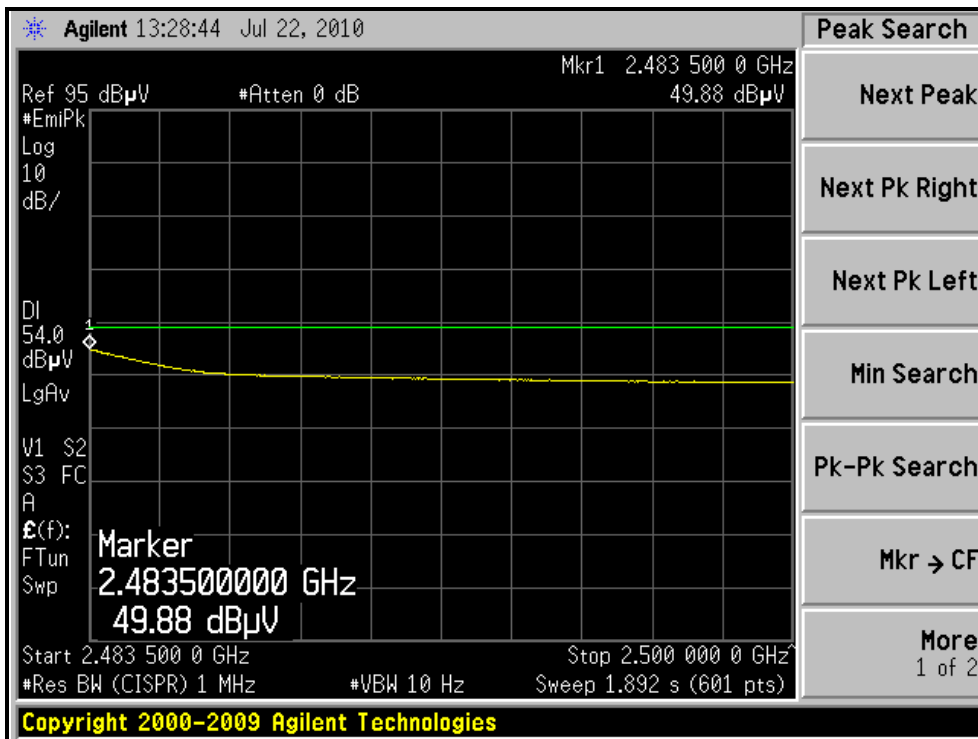
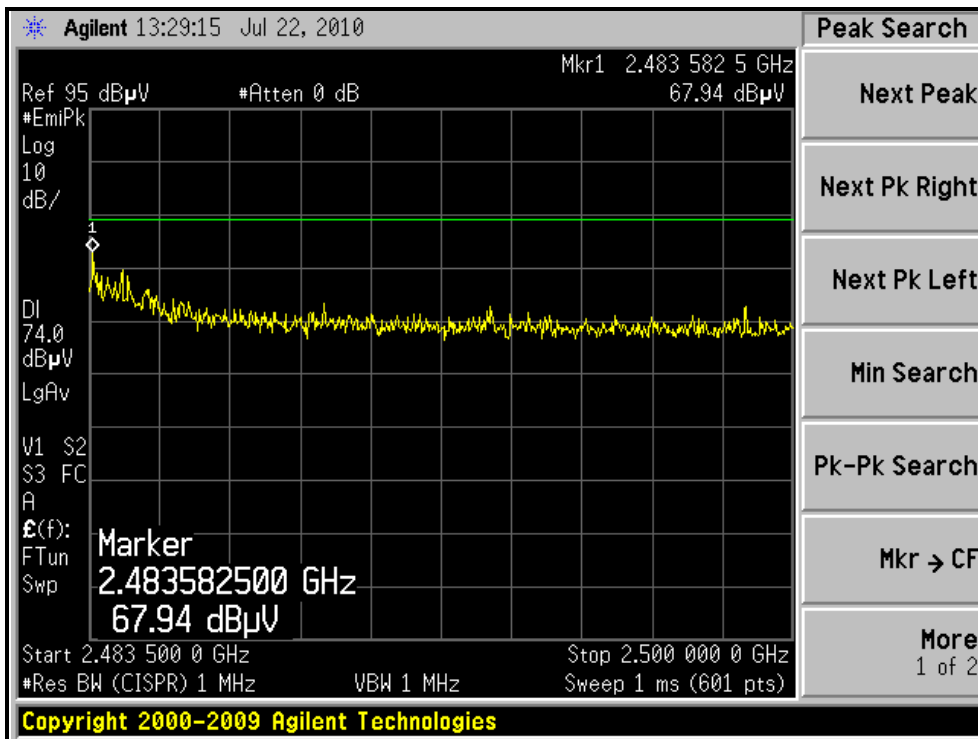

802.11n (20MHz) OFDM MODULATION

EUT TEST CONDITION		MEASUREMENT DETAIL	
CHANNEL	Channel 1	FREQUENCY RANGE	1 ~ 25GHz
INPUT POWER (SYSTEM)	120Vac, 60 Hz	DETECTOR FUNCTION	Peak (PK) Average (AV)
ENVIRONMENTAL CONDITIONS	28deg. C, 74%RH 1013 hPa	TESTED BY	Rex Huang

ANTENNA POLARITY & TEST DISTANCE: HORIZONTAL AT 3 M								
NO.	FREQ. (MHz)	EMISSION LEVEL (dBuV/m)	LIMIT (dBuV/m)	MARGIN (dB)	ANTENNA HEIGHT (m)	TABLE ANGLE (Degree)	RAW VALUE (dBuV)	CORRECTION FACTOR (dB/m)
1	2390.00	70.1 PK	74.0	-3.9	1.77 H	360	38.89	31.21
2	2390.00	52.0 AV	54.0	-2.0	1.77 H	360	20.79	31.21
3	*2412.00	104.7 PK			1.76 H	306	73.43	31.27
4	*2412.00	94.3 AV			1.76 H	306	63.03	31.27
5	4824.00	48.1 PK	74.0	-25.9	1.66 H	50	8.68	39.42
6	4824.00	38.2 AV	54.0	-15.8	1.66 H	50	-1.22	39.42
ANTENNA POLARITY & TEST DISTANCE: VERTICAL AT 3 M								
NO.	FREQ. (MHz)	EMISSION LEVEL (dBuV/m)	LIMIT (dBuV/m)	MARGIN (dB)	ANTENNA HEIGHT (m)	TABLE ANGLE (Degree)	RAW VALUE (dBuV)	CORRECTION FACTOR (dB/m)
1	2390.00	66.2 PK	74.0	-7.8	1.21 V	60	34.99	31.21
2	2390.00	48.9 AV	54.0	-5.1	1.21 V	60	17.69	31.21
3	*2412.00	98.2 PK			1.22 V	55	66.93	31.27
4	*2412.00	88.0 AV			1.22 V	55	56.73	31.27
5	4824.00	52.6 PK	74.0	-21.4	1.44 V	171	13.18	39.42
6	4824.00	41.9 AV	54.0	-12.1	1.44 V	171	2.48	39.42

- REMARKS:**
1. Emission level (dBuV/m) = Raw Value (dBuV) + Correction Factor (dB/m).
 2. Correction Factor (dB/m) = Antenna Factor (dB/m) + Cable Factor (dB).
 3. The other emission levels were very low against the limit.
 4. Margin value = Emission level – Limit value.
 5. “ * “: Fundamental frequency.



A D T

EUT TEST CONDITION		MEASUREMENT DETAIL	
CHANNEL	Channel 6	FREQUENCY RANGE	1 ~ 25GHz
INPUT POWER (SYSTEM)	120Vac, 60 Hz	DETECTOR FUNCTION	Peak (PK) Average (AV)
ENVIRONMENTAL CONDITIONS	28deg. C, 74%RH 1013 hPa	TESTED BY	Rex Huang

ANTENNA POLARITY & TEST DISTANCE: HORIZONTAL AT 3 M								
NO.	FREQ. (MHz)	EMISSION LEVEL (dBuV/m)	LIMIT (dBuV/m)	MARGIN (dB)	ANTENNA HEIGHT (m)	TABLE ANGLE (Degree)	RAW VALUE (dBuV)	CORRECTION FACTOR (dB/m)
1	*2437.00	111.5 PK			1.71 H	306	80.16	31.34
2	*2437.00	101.1 AV			1.71 H	306	69.76	31.34
3	4874.00	60.4 PK	74.0	-13.6	1.69 H	246	20.78	39.62
4	4874.00	46.3 AV	54.0	-7.7	1.69 H	246	6.68	39.62
5	7311.00	51.9 PK	74.0	-22.1	1.43 H	22	7.80	44.10
6	7311.00	38.1 AV	54.0	-15.9	1.43 H	22	-6.00	44.10
ANTENNA POLARITY & TEST DISTANCE: VERTICAL AT 3 M								
NO.	FREQ. (MHz)	EMISSION LEVEL (dBuV/m)	LIMIT (dBuV/m)	MARGIN (dB)	ANTENNA HEIGHT (m)	TABLE ANGLE (Degree)	RAW VALUE (dBuV)	CORRECTION FACTOR (dB/m)
1	*2437.00	105.8 PK			1.28 V	60	74.46	31.34
2	*2437.00	95.4 AV			1.28 V	60	64.06	31.34
3	4874.00	64.6 PK	74.0	-9.4	1.14 V	68	24.98	39.62
4	4874.00	49.1 AV	54.0	-4.9	1.14 V	68	9.48	39.62
5	7311.00	53.4 PK	74.0	-20.6	1.20 V	158	9.30	44.10
6	7311.00	39.9 AV	54.0	-14.1	1.20 V	158	-4.20	44.10

- REMARKS:**
1. Emission level (dBuV/m) = Raw Value (dBuV) + Correction Factor (dB/m).
 2. Correction Factor (dB/m) = Antenna Factor (dB/m) + Cable Factor (dB).
 3. The other emission levels were very low against the limit.
 4. Margin value = Emission level – Limit value.
 5. “ * “: Fundamental frequency.



A D T

EUT TEST CONDITION		MEASUREMENT DETAIL	
CHANNEL	Channel 11	FREQUENCY RANGE	1 ~ 25GHz
INPUT POWER (SYSTEM)	120Vac, 60 Hz	DETECTOR FUNCTION	Peak (PK) Average (AV)
ENVIRONMENTAL CONDITIONS	28deg. C, 74%RH 1013 hPa	TESTED BY	Rex Huang

ANTENNA POLARITY & TEST DISTANCE: HORIZONTAL AT 3 M								
NO.	FREQ. (MHz)	EMISSION LEVEL (dBuV/m)	LIMIT (dBuV/m)	MARGIN (dB)	ANTENNA HEIGHT (m)	TABLE ANGLE (Degree)	RAW VALUE (dBuV)	CORRECTION FACTOR (dB/m)
1	*2462.00	105.9 PK			1.71 H	307	74.50	31.40
2	*2462.00	95.1 AV			1.71 H	307	63.70	31.40
3	2483.50	71.5 PK	74.0	-2.5	1.70 H	311	40.04	31.46
4	2483.50	53.3 AV	54.0	-0.7	1.70 H	311	21.84	31.46
5	4924.00	49.2 PK	74.0	-24.8	1.29 H	68	9.38	39.82
6	4924.00	38.5 AV	54.0	-15.5	1.29 H	68	-1.32	39.82
7	7386.00	51.4 PK	74.0	-22.6	1.40 H	311	7.22	44.18
8	7386.00	38.6 AV	54.0	-15.4	1.40 H	311	-5.58	44.18
ANTENNA POLARITY & TEST DISTANCE: VERTICAL AT 3 M								
NO.	FREQ. (MHz)	EMISSION LEVEL (dBuV/m)	LIMIT (dBuV/m)	MARGIN (dB)	ANTENNA HEIGHT (m)	TABLE ANGLE (Degree)	RAW VALUE (dBuV)	CORRECTION FACTOR (dB/m)
1	*2462.00	98.9 PK			1.19 V	53	67.50	31.40
2	*2462.00	89.3 AV			1.19 V	53	57.90	31.40
3	2483.50	69.5 PK	74.0	-4.5	1.20 V	80	38.04	31.46
4	2483.50	49.0 AV	54.0	-5.0	1.20 V	80	17.54	31.46
5	4924.00	53.1 PK	74.0	-20.9	1.50 V	200	13.28	39.82
6	4924.00	42.6 AV	54.0	-11.4	1.50 V	200	2.78	39.82
7	7386.00	54.2 PK	74.0	-19.8	1.40 V	307	10.02	44.18
8	7386.00	39.6 AV	54.0	-14.4	1.40 V	307	-4.58	44.18

- REMARKS:**
1. Emission level (dBuV/m) = Raw Value (dBuV) + Correction Factor (dB/m).
 2. Correction Factor (dB/m) = Antenna Factor (dB/m) + Cable Factor (dB).
 3. The other emission levels were very low against the limit.
 4. Margin value = Emission level – Limit value.
 5. “ * “: Fundamental frequency.



A D T

RESTRICTED BANDEDGE (802.11n (20MHz) MODE,CH1, HORIZONTAL)

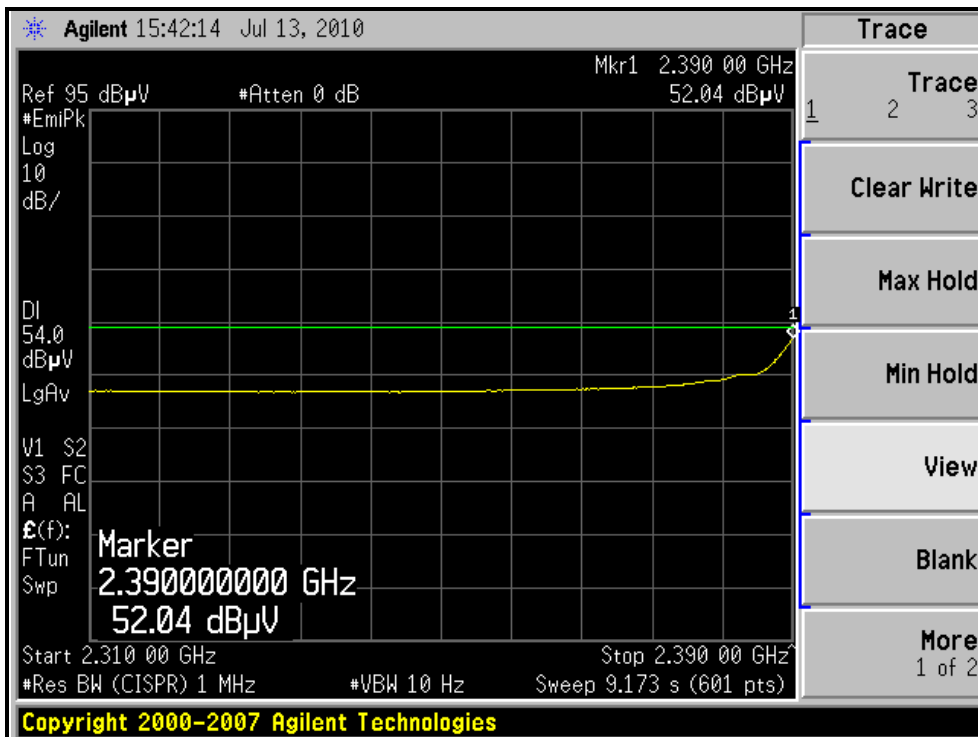
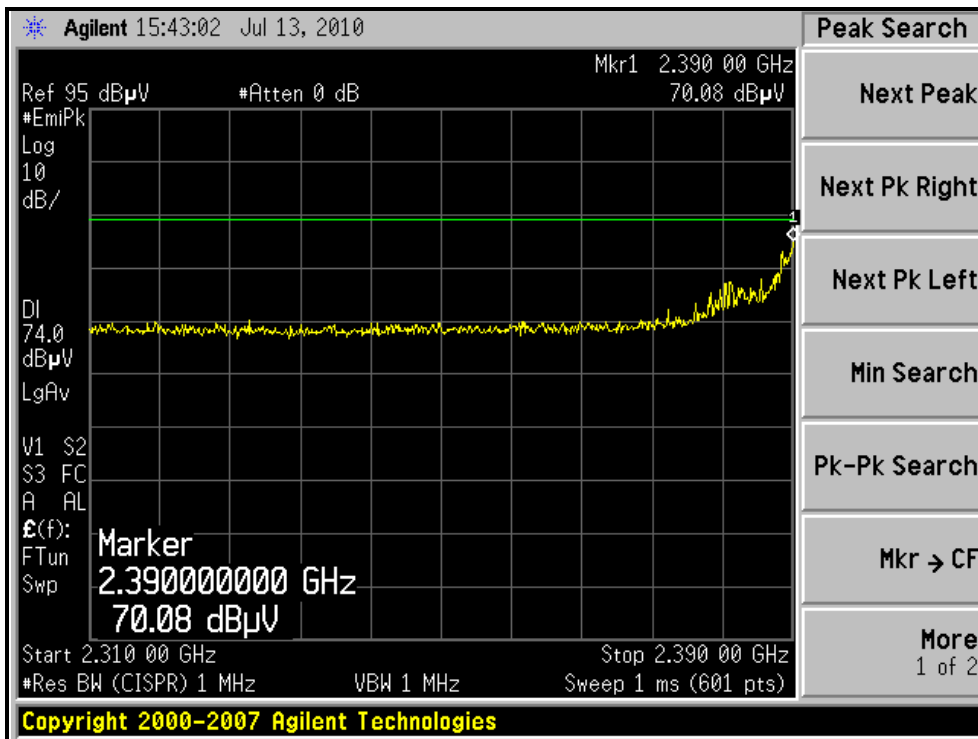



A D T

RESTRICTED BANDEDGE (802.11n (20MHz) MODE,CH1, VERTICAL)

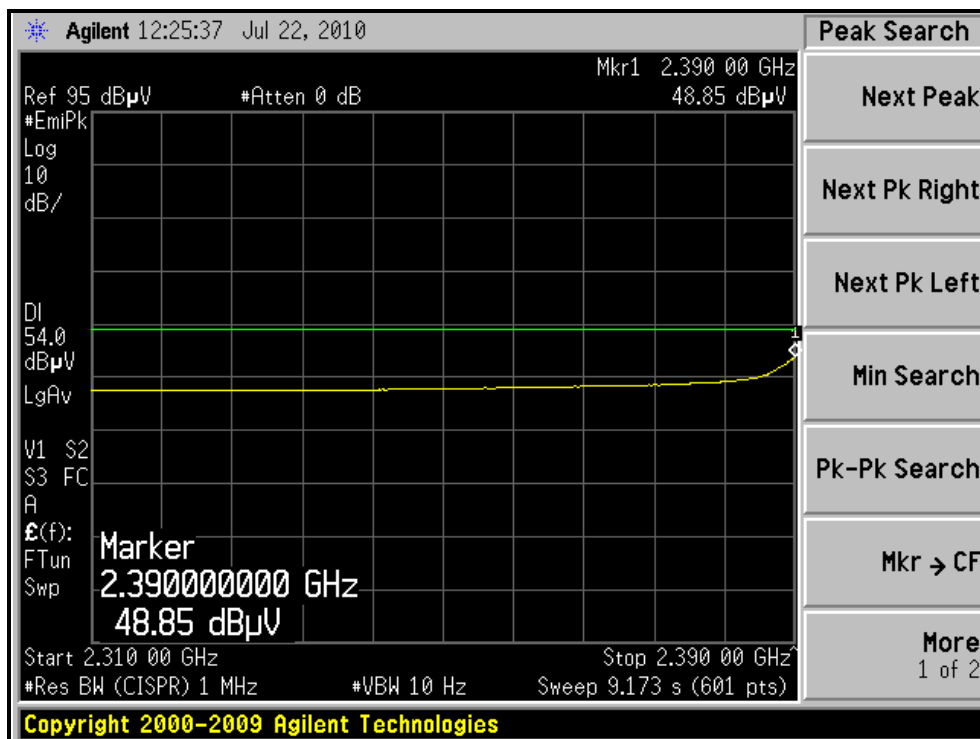
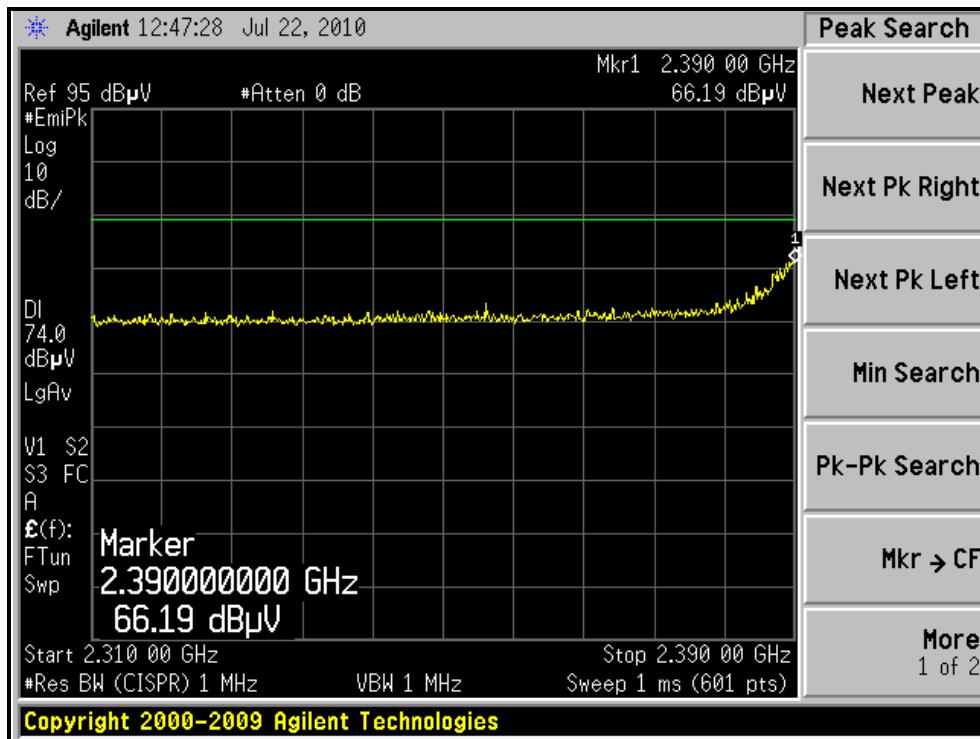



A D T

RESTRICTED BANDEDGE (802.11n (20MHz) MODE,CH11, HORIZONTAL)

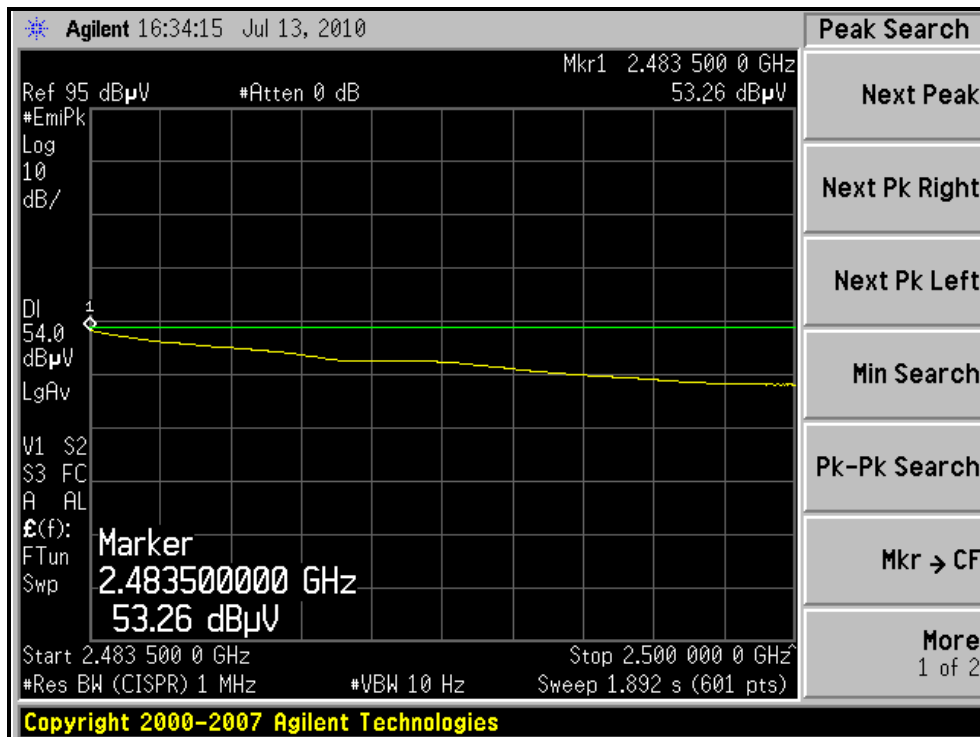
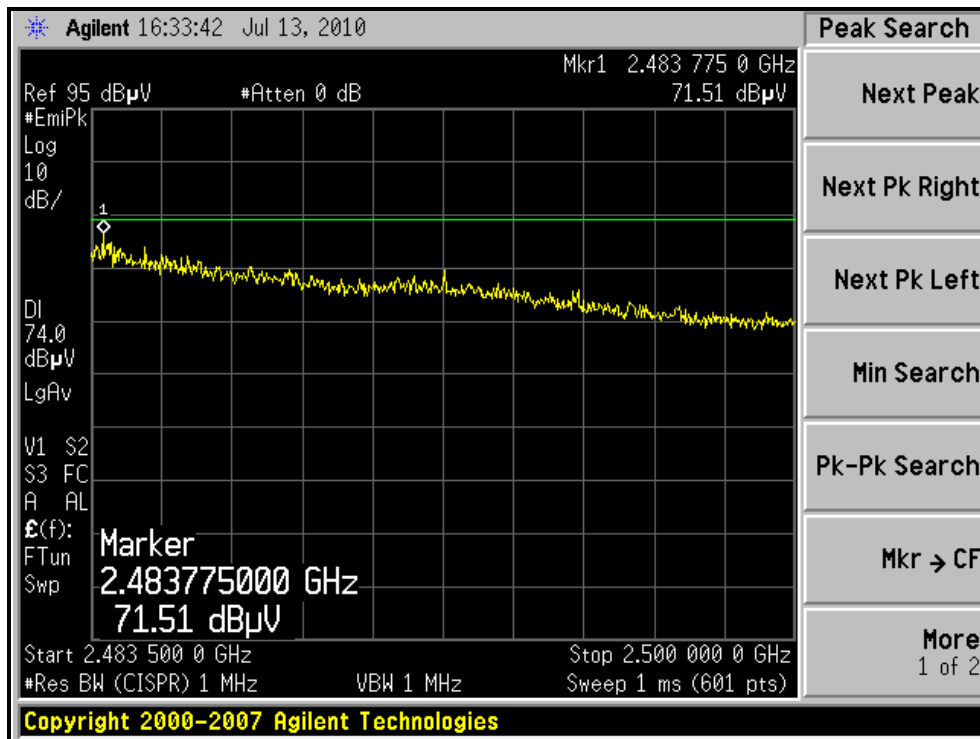



A D T

RESTRICTED BANDEDGE (802.11n (20MHz) MODE,CH11, VERTICAL)

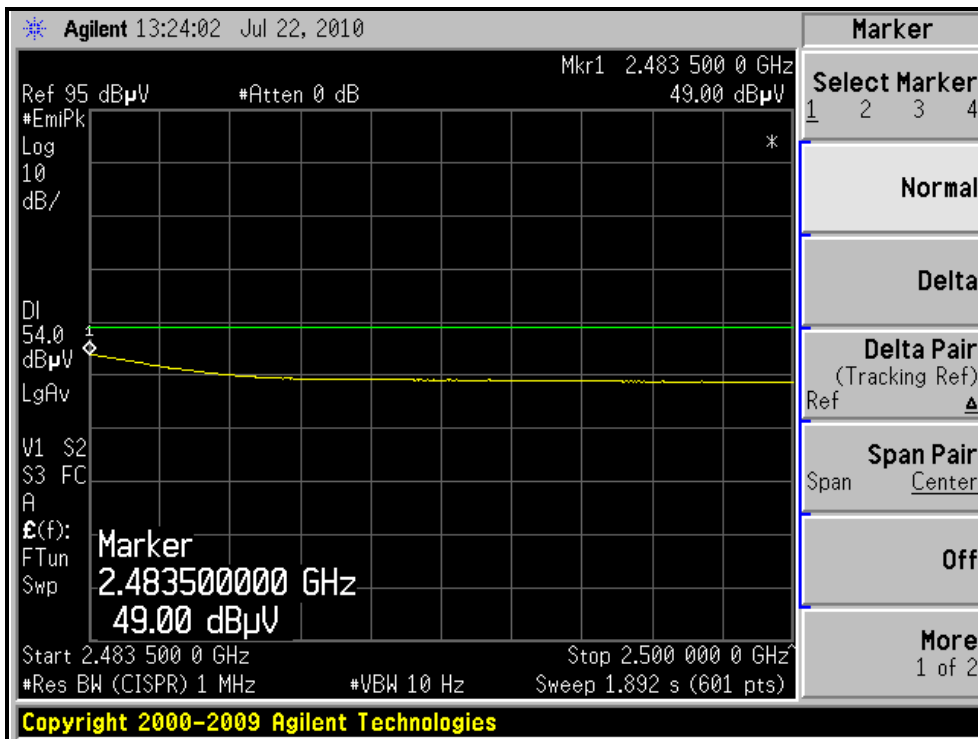
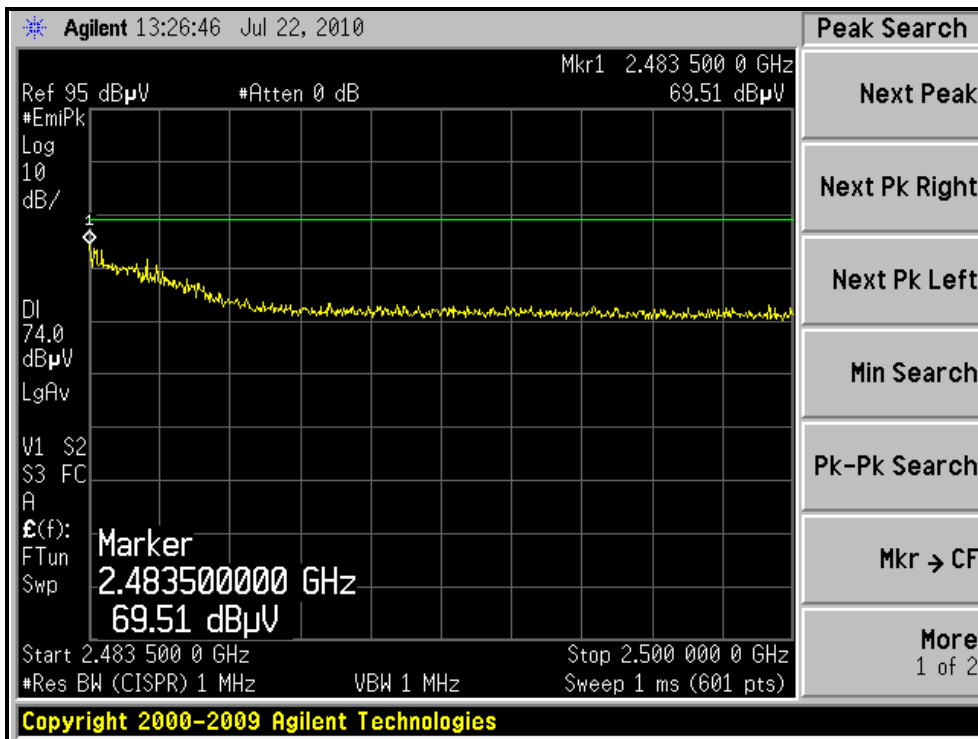

4.2.8 TEST RESULTS (FOR RECEIVER PART)

BELOW 1GHz WORST-CASE DATA :

EUT TEST CONDITION		MEASUREMENT DETAIL	
CHANNEL	Channel 6	FREQUENCY RANGE	Below 1000MHz
INPUT POWER (SYSTEM)	120Vac, 60 Hz	DETECTOR FUNCTION	Quasi-Peak
ENVIRONMENTAL CONDITIONS	24deg. C, 70%RH 1013 hPa	TESTED BY	Eric Lee

ANTENNA POLARITY & TEST DISTANCE: HORIZONTAL AT 3 M								
NO.	FREQ. (MHz)	EMISSION LEVEL (dBuV/m)	LIMIT (dBuV/m)	MARGIN (dB)	ANTENNA HEIGHT (m)	TABLE ANGLE (Degree)	RAW VALUE (dBuV)	CORRECTION FACTOR (dB/m)
1	99.65	33.7 QP	43.5	-9.8	1.75 H	360	23.75	9.95
2	116.50	35.4 QP	43.5	-8.1	1.50 H	358	23.11	12.29
3	133.16	33.9 QP	43.5	-9.6	2.25 H	0	20.21	13.69
4	149.90	35.8 QP	43.5	-7.7	1.50 H	360	21.52	14.30
5	166.55	42.0 QP	43.5	-1.5	1.75 H	220	28.00	14.00
6	199.30	37.4 QP	43.5	-6.1	1.25 H	0	26.14	11.26
7	248.96	39.8 QP	46.0	-6.2	1.25 H	281	26.91	12.91
ANTENNA POLARITY & TEST DISTANCE: VERTICAL AT 3 M								
NO.	FREQ. (MHz)	EMISSION LEVEL (dBuV/m)	LIMIT (dBuV/m)	MARGIN (dB)	ANTENNA HEIGHT (m)	TABLE ANGLE (Degree)	RAW VALUE (dBuV)	CORRECTION FACTOR (dB/m)
1	33.50	37.8 QP	40.0	-2.2	1.00 V	291	24.32	13.46
2	99.80	26.8 QP	43.5	-16.7	1.00 V	28	16.85	9.95
3	149.86	33.6 QP	43.5	-9.9	1.25 V	360	19.30	14.30
4	166.05	34.4 QP	43.5	-9.1	2.25 V	312	20.38	14.02
5	248.82	33.3 QP	46.0	-12.7	1.00 V	217	20.39	12.91
6	365.25	31.0 QP	46.0	-15.0	1.75 V	360	14.12	16.88

- REMARKS:**
1. Emission level (dBuV/m) = Raw Value (dBuV) + Correction Factor (dB/m).
 2. Correction Factor (dB/m) = Antenna Factor (dB/m) + Cable Factor (dB).
 3. The other emission levels were very low against the limit.
 4. Margin value = Emission level – Limit value.



ABOVE 1GHz WORST-CASE DATA

EUT TEST CONDITION		MEASUREMENT DETAIL	
CHANNEL	Channel 1	FREQUENCY RANGE	1 ~ 7.5GHz
INPUT POWER (SYSTEM)	120Vac, 60 Hz	DETECTOR FUNCTION	Peak (PK) Average (AV)
ENVIRONMENTAL CONDITIONS	25deg. C, 70%RH 1013 hPa	TESTED BY	Rex Huang

ANTENNA POLARITY & TEST DISTANCE: HORIZONTAL AT 3 M								
NO.	FREQ. (MHz)	EMISSION LEVEL (dBuV/m)	LIMIT (dBuV/m)	MARGIN (dB)	ANTENNA HEIGHT (m)	TABLE ANGLE (Degree)	RAW VALUE (dBuV)	CORRECTION FACTOR (dB/m)
1	3216.00	57.6 PK	74.0	-16.4	1.00 H	12	24.24	33.36
2	3216.00	50.7 AV	54.0	-3.3	1.00 H	12	17.34	33.36
3	6432.00	55.2 PK	74.0	-18.8	1.03 H	29	12.95	42.25
4	6432.00	45.4 AV	54.0	-8.6	1.03 H	29	3.15	42.25
ANTENNA POLARITY & TEST DISTANCE: VERTICAL AT 3 M								
NO.	FREQ. (MHz)	EMISSION LEVEL (dBuV/m)	LIMIT (dBuV/m)	MARGIN (dB)	ANTENNA HEIGHT (m)	TABLE ANGLE (Degree)	RAW VALUE (dBuV)	CORRECTION FACTOR (dB/m)
1	3216.00	51.8 PK	74.0	-22.2	1.06 V	111	18.44	33.36
2	3216.00	47.6 AV	54.0	-6.4	1.06 V	111	14.24	33.36
3	6432.00	55.0 PK	74.0	-19.0	1.11 V	243	12.75	42.25
4	6432.00	45.3 AV	54.0	-8.7	1.11 V	243	3.05	42.25

- REMARKS:**
1. Emission level (dBuV/m) = Raw Value (dBuV) + Correction Factor (dB/m).
 2. Correction Factor (dB/m) = Antenna Factor (dB/m) + Cable Factor (dB).
 3. The other emission levels were very low against the limit.
 4. Margin value = Emission level – Limit value.



A D T

EUT TEST CONDITION		MEASUREMENT DETAIL	
CHANNEL	Channel 6	FREQUENCY RANGE	1 ~ 7.5GHz
INPUT POWER (SYSTEM)	120Vac, 60 Hz	DETECTOR FUNCTION	Peak (PK) Average (AV)
ENVIRONMENTAL CONDITIONS	25deg. C, 70%RH 1013 hPa	TESTED BY	Rex Huang

ANTENNA POLARITY & TEST DISTANCE: HORIZONTAL AT 3 M								
NO.	FREQ. (MHz)	EMISSION LEVEL (dBuV/m)	LIMIT (dBuV/m)	MARGIN (dB)	ANTENNA HEIGHT (m)	TABLE ANGLE (Degree)	RAW VALUE (dBuV)	CORRECTION FACTOR (dB/m)
1	3249.30	58.2 PK	74.0	-15.8	1.01 H	29	24.74	33.46
2	3249.30	50.9 AV	54.0	-3.1	1.01 H	29	17.44	33.46
3	6498.60	55.4 PK	74.0	-18.6	1.04 H	57	13.06	42.34
4	6498.60	45.5 AV	54.0	-8.5	1.04 H	57	3.16	42.34
ANTENNA POLARITY & TEST DISTANCE: VERTICAL AT 3 M								
NO.	FREQ. (MHz)	EMISSION LEVEL (dBuV/m)	LIMIT (dBuV/m)	MARGIN (dB)	ANTENNA HEIGHT (m)	TABLE ANGLE (Degree)	RAW VALUE (dBuV)	CORRECTION FACTOR (dB/m)
1	3249.30	52.1 PK	74.0	-21.9	1.07 V	109	18.64	33.46
2	3249.30	48.1 AV	54.0	-5.9	1.07 V	109	14.64	33.46
3	6498.60	55.2 PK	74.0	-18.8	1.13 V	249	12.86	42.34
4	6498.60	45.6 AV	54.0	-8.4	1.13 V	249	3.26	42.34

- REMARKS:**
1. Emission level (dBuV/m) = Raw Value (dBuV) + Correction Factor (dB/m).
 2. Correction Factor (dB/m) = Antenna Factor (dB/m) + Cable Factor (dB).
 3. The other emission levels were very low against the limit.
 4. Margin value = Emission level – Limit value.



A D T

EUT TEST CONDITION		MEASUREMENT DETAIL	
CHANNEL	Channel 11	FREQUENCY RANGE	1 ~ 7.5GHz
INPUT POWER (SYSTEM)	120Vac, 60 Hz	DETECTOR FUNCTION	Peak (PK) Average (AV)
ENVIRONMENTAL CONDITIONS	25deg. C, 70%RH 1013 hPa	TESTED BY	Rex Huang

ANTENNA POLARITY & TEST DISTANCE: HORIZONTAL AT 3 M								
NO.	FREQ. (MHz)	EMISSION LEVEL (dBuV/m)	LIMIT (dBuV/m)	MARGIN (dB)	ANTENNA HEIGHT (m)	TABLE ANGLE (Degree)	RAW VALUE (dBuV)	CORRECTION FACTOR (dB/m)
1	3282.60	58.4 PK	74.0	-15.6	1.04 H	34	24.85	33.55
2	3282.60	51.4 AV	54.0	-2.6	1.04 H	34	17.85	33.55
3	6565.30	55.9 PK	74.0	-18.1	1.07 H	62	13.36	42.54
4	6565.30	45.6 AV	54.0	-8.4	1.07 H	62	3.06	42.54
ANTENNA POLARITY & TEST DISTANCE: VERTICAL AT 3 M								
NO.	FREQ. (MHz)	EMISSION LEVEL (dBuV/m)	LIMIT (dBuV/m)	MARGIN (dB)	ANTENNA HEIGHT (m)	TABLE ANGLE (Degree)	RAW VALUE (dBuV)	CORRECTION FACTOR (dB/m)
1	3282.60	52.3 PK	74.0	-21.7	1.09 V	107	18.75	33.55
2	3282.60	48.4 AV	54.0	-5.6	1.09 V	107	14.85	33.55
3	6565.30	55.4 PK	74.0	-18.6	1.14 V	248	12.86	42.54
4	6565.30	45.9 AV	54.0	-8.1	1.14 V	248	3.36	42.54

- REMARKS:**
1. Emission level (dBuV/m) = Raw Value (dBuV) + Correction Factor (dB/m).
 2. Correction Factor (dB/m) = Antenna Factor (dB/m) + Cable Factor (dB).
 3. The other emission levels were very low against the limit.
 4. Margin value = Emission level – Limit value.

4.3 6dB BANDWIDTH MEASUREMENT

4.3.1 LIMITS OF 6dB BANDWIDTH MEASUREMENT

The minimum of 6dB Bandwidth Measurement is 0.5 MHz.

4.3.2 TEST INSTRUMENTS

DESCRIPTION & MANUFACTURER	MODEL NO.	SERIAL NO.	CALIBRATED DATE	CALIBRATED UNTIL
Spectrum Analyzer	E4446A	MY48250254	July 14, 2010	July 13, 2011

NOTE: The calibration interval of the above test instruments is 12 months and the calibrations are traceable to NML/ROC and NIST/USA.

4.3.3 TEST PROCEDURE

The transmitter output was connected to the spectrum analyzer through an attenuator. The bandwidth of the fundamental frequency was measured by spectrum analyzer with 100kHz RBW and 100kHz VBW. The 6dB bandwidth is defined as the total spectrum the power of which is higher than peak power minus 6dB.

4.3.4 DEVIATION FROM TEST STANDARD

No deviation

4.3.5 TEST SETUP



4.3.6 EUT OPERATING CONDITIONS

The software provided by client to enable the EUT under transmission condition continuously at lowest, middle and highest channel frequencies individually.



A D T

4.3.7 TEST RESULTS

802.11b DSSS MODULATION:

CHANNEL	CHANNEL FREQUENCY (MHz)	6dB BANDWIDTH (MHz)	MINIMUM LIMIT (MHz)	PASS / FAIL
1	2412	10.88	0.5	PASS
6	2437	11.06	0.5	PASS
11	2462	11.08	0.5	PASS

CH1

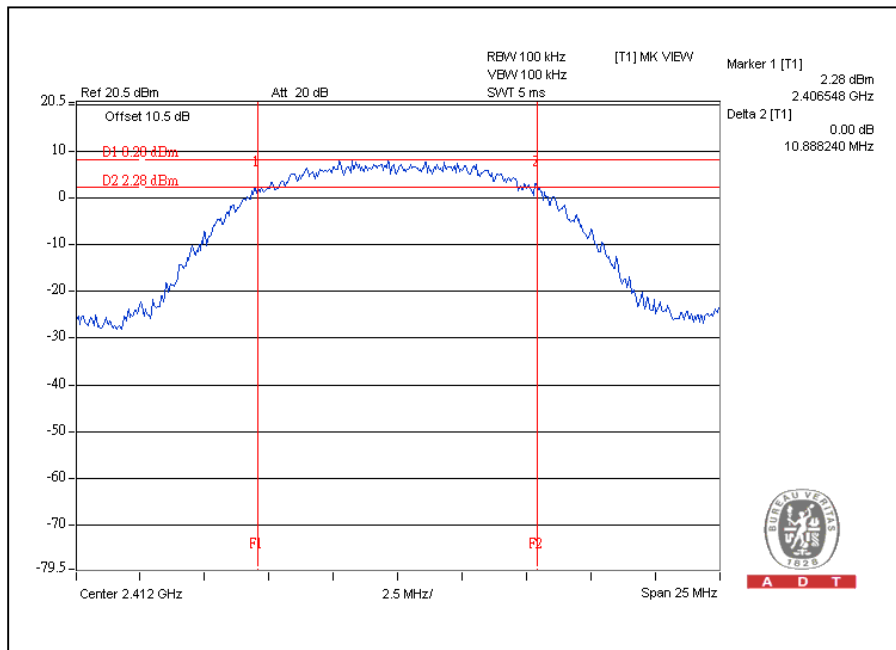

CH6

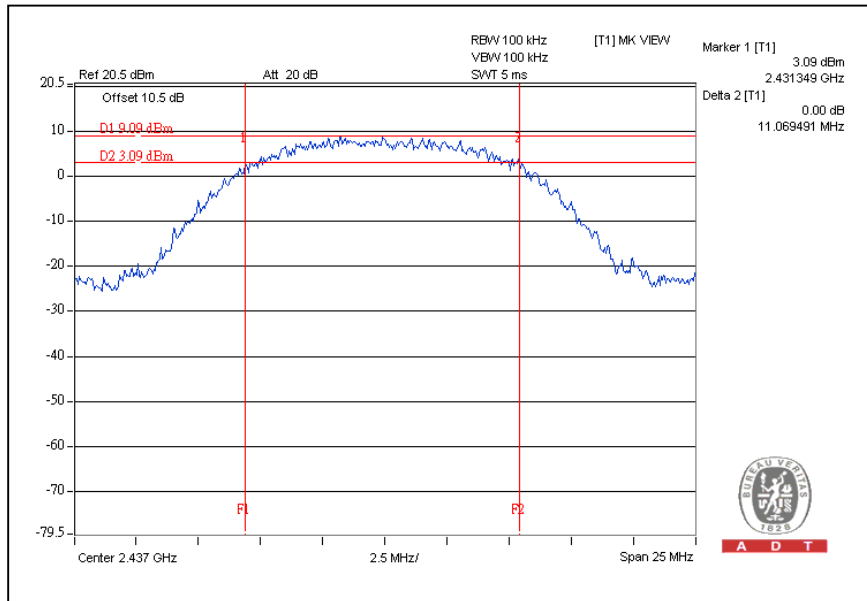

CH11

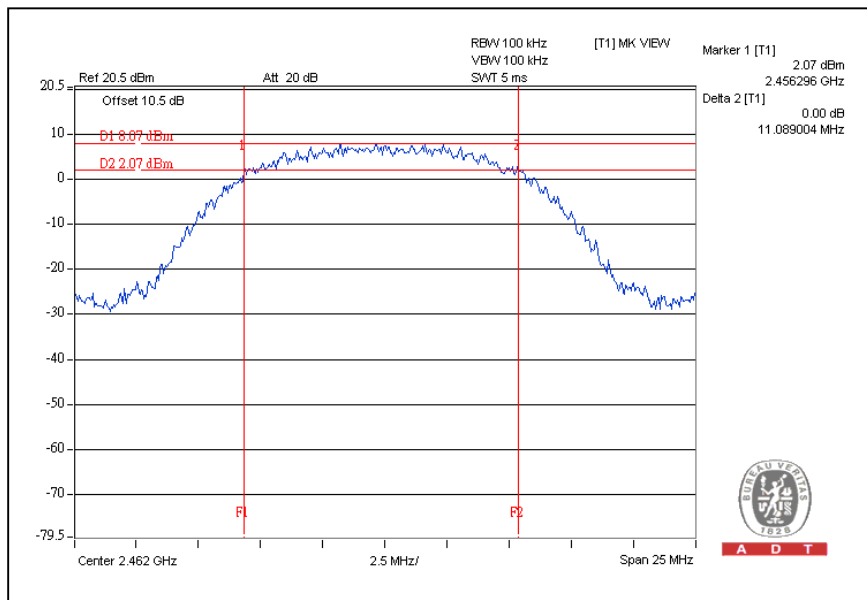



A D T

802.11g OFDM MODULATION:

CHANNEL	CHANNEL FREQUENCY (MHz)	6dB BANDWIDTH (MHz)	MINIMUM LIMIT (MHz)	PASS / FAIL
1	2412	16.32	0.5	PASS
6	2437	16.31	0.5	PASS
11	2462	16.33	0.5	PASS

CH1

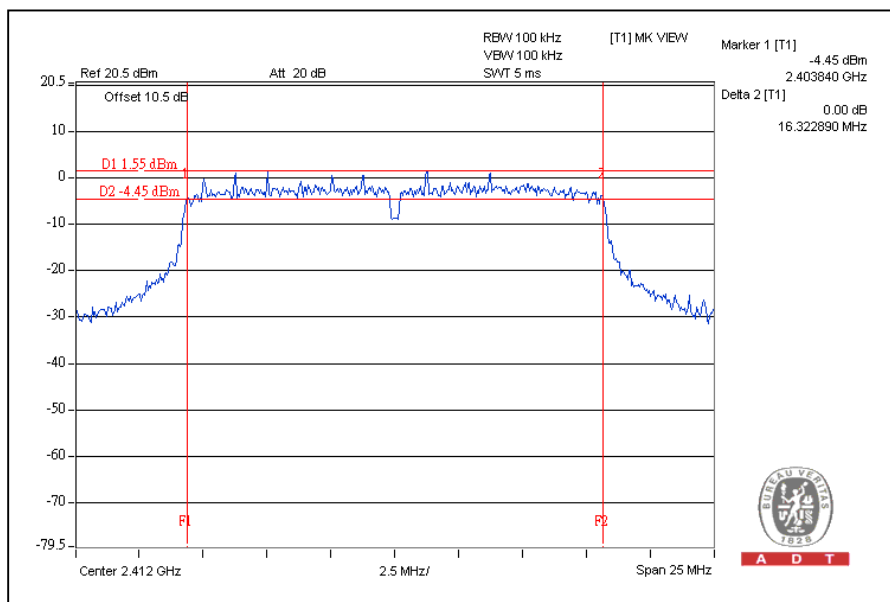



A D T

CH6

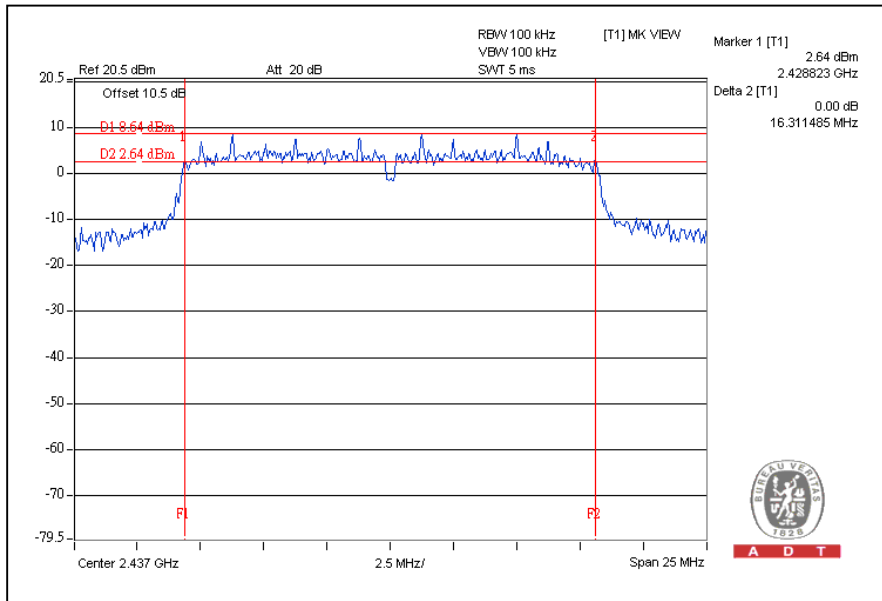

CH11

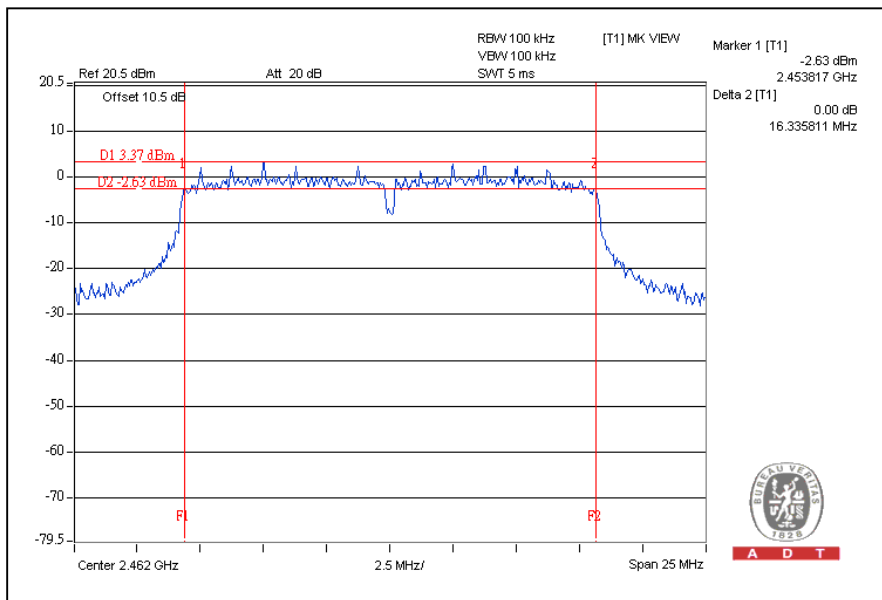



A D T

802.11n (20MHz) OFDM MODULATION:

CHANNEL	CHANNEL FREQUENCY (MHz)	6dB BANDWIDTH (MHz)	MINIMUM LIMIT (MHz)	PASS / FAIL
1	2412	16.32	0.5	PASS
6	2437	17.24	0.5	PASS
11	2462	16.73	0.5	PASS

CH1

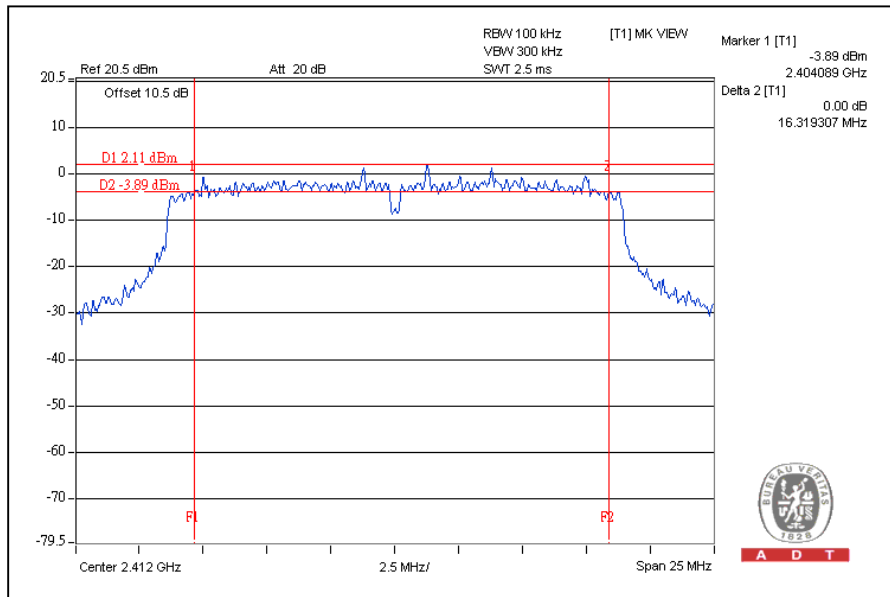



A D T

CH6

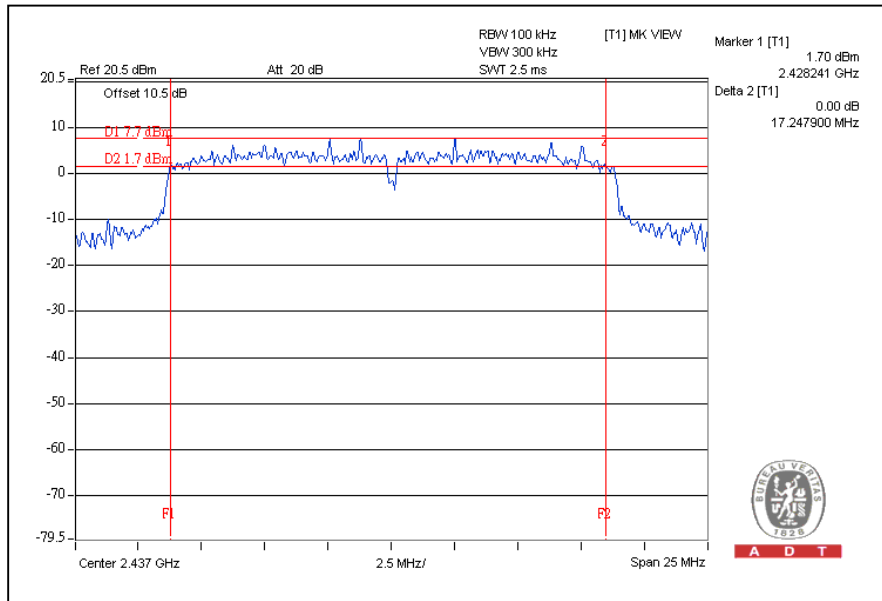

CH11

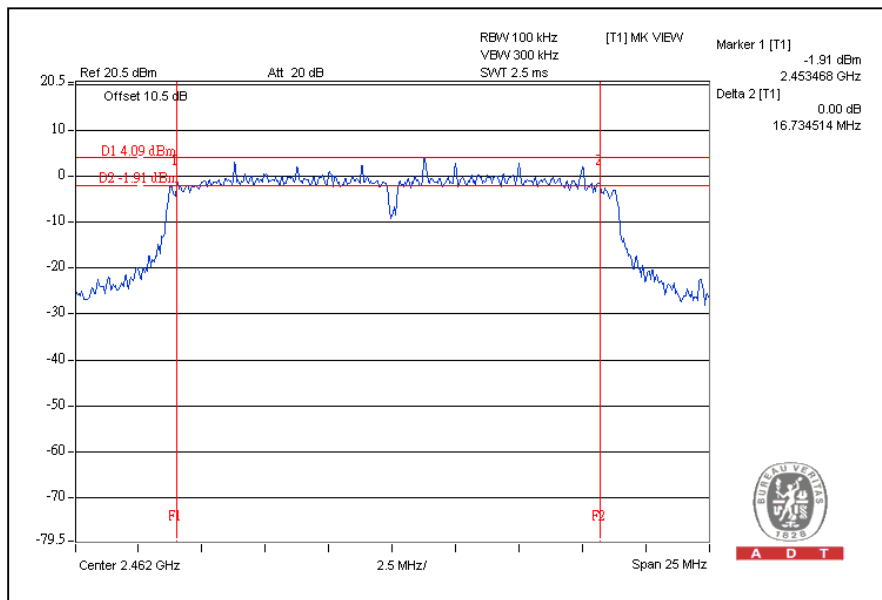

4.4 99% BANDWIDTH MEASUREMENT

4.4.1 TEST INSTRUMENTS

DESCRIPTION & MANUFACTURER	MODEL NO.	SERIAL NO.	CALIBRATED DATE	CALIBRATED UNTIL
Spectrum Analyzer	E4446A	MY48250254	July 14, 2010	July 13, 2011

NOTE: The calibration interval of the above test instruments is 12 months and the calibrations are traceable to NML/ROC and NIST/USA.

4.4.2 TEST PROCEDURE

The transmitter output was connected to the spectrum analyzer through an attenuator. The bandwidth of the fundamental frequency was measured by spectrum analyzer with 100kHz RBW and 100kHz VBW.

4.4.3 TEST SETUP

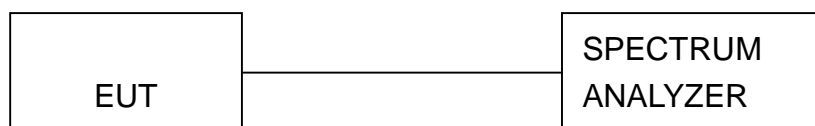

4.4.4 EUT OPERATING CONDITIONS

The software provided by client to enable the EUT under transmission condition continuously at lowest, middle and highest channel frequencies individually.

4.4.5 TEST RESULTS

802.11b DSSS MODULATION:

CHANNEL	CHANNEL FREQUENCY (MHz)	99% BANDWIDTH (MHz)
1	2412	14.5
6	2437	14.7
11	2462	14.0

CH1

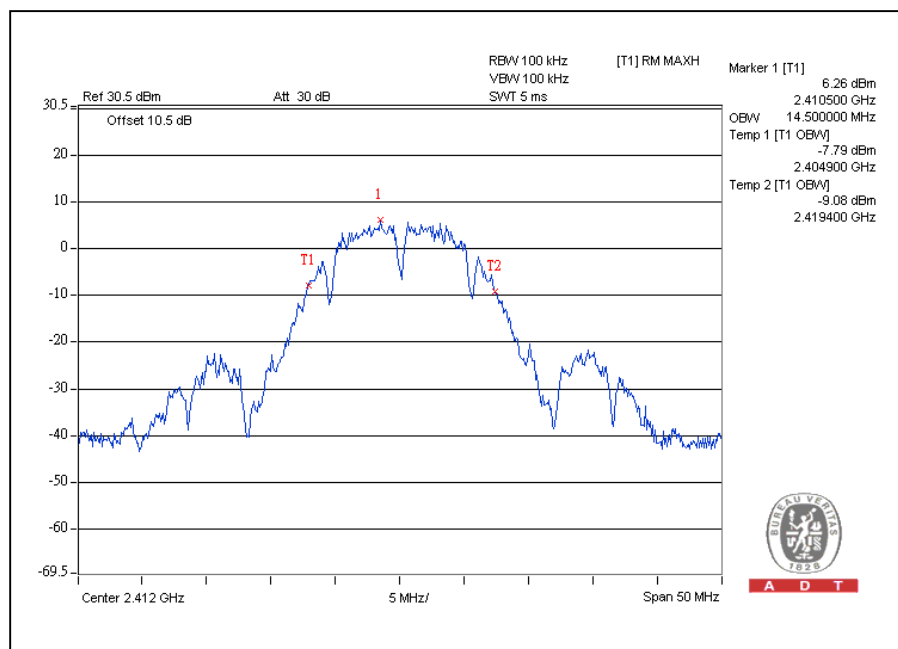



A D T

CH6

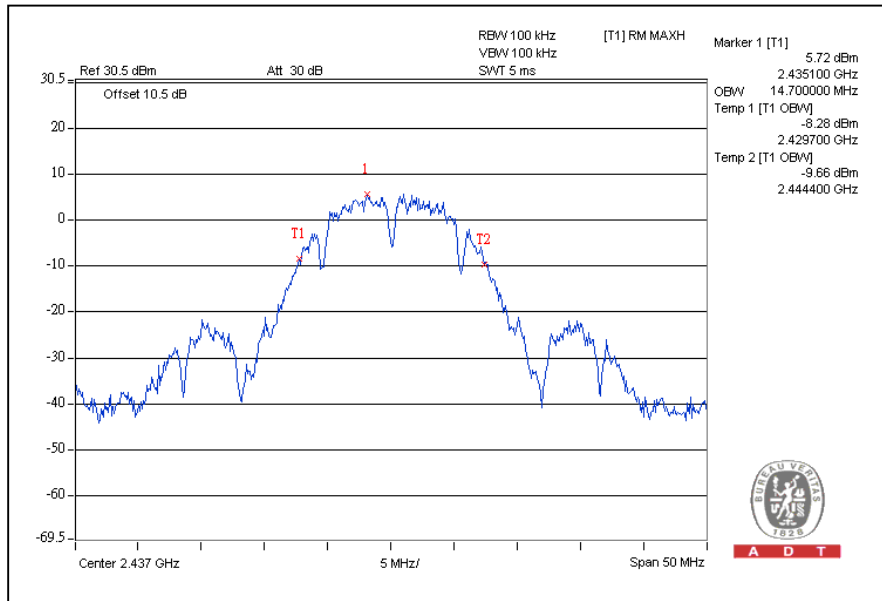

CH11

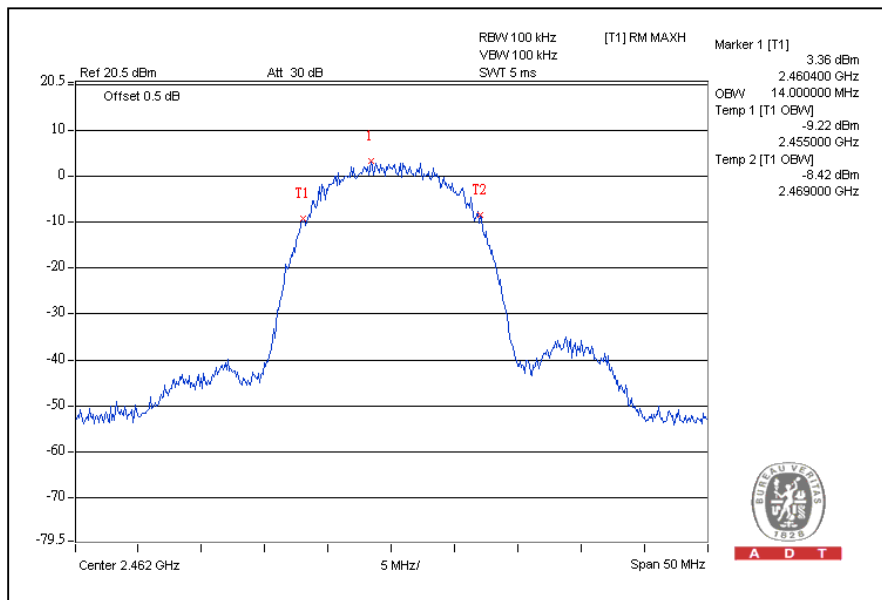

802.11g OFDM MODULATION:

CHANNEL	CHANNEL FREQUENCY (MHz)	99% BANDWIDTH (MHz)
1	2412	16.5
6	2437	21.5
11	2462	16.5

CH1

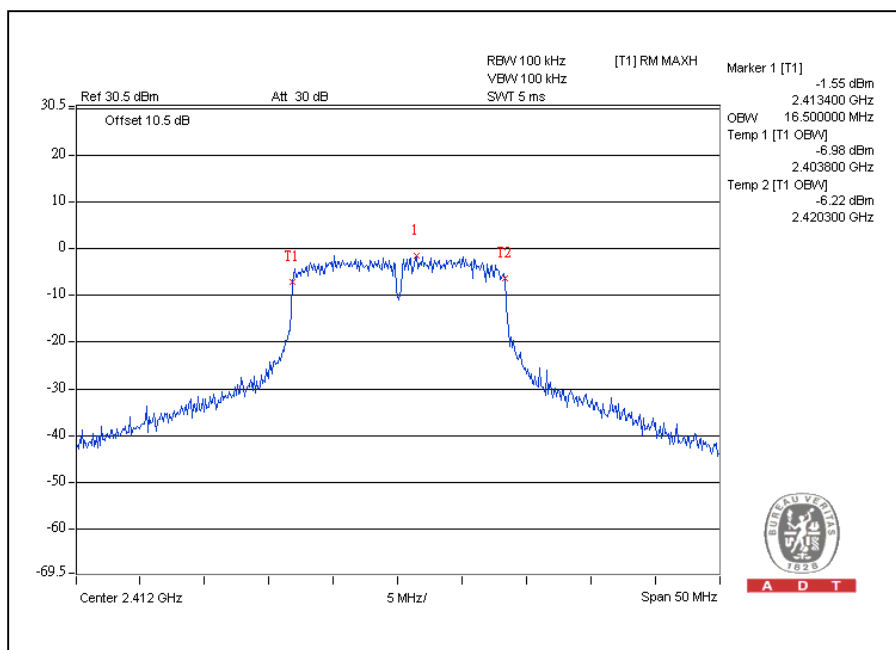



A D T

CH6

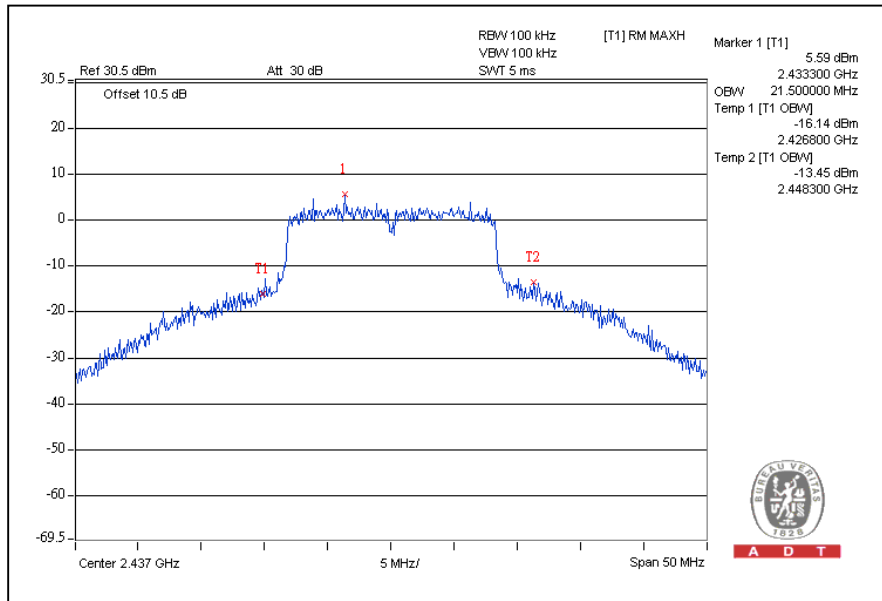

CH11

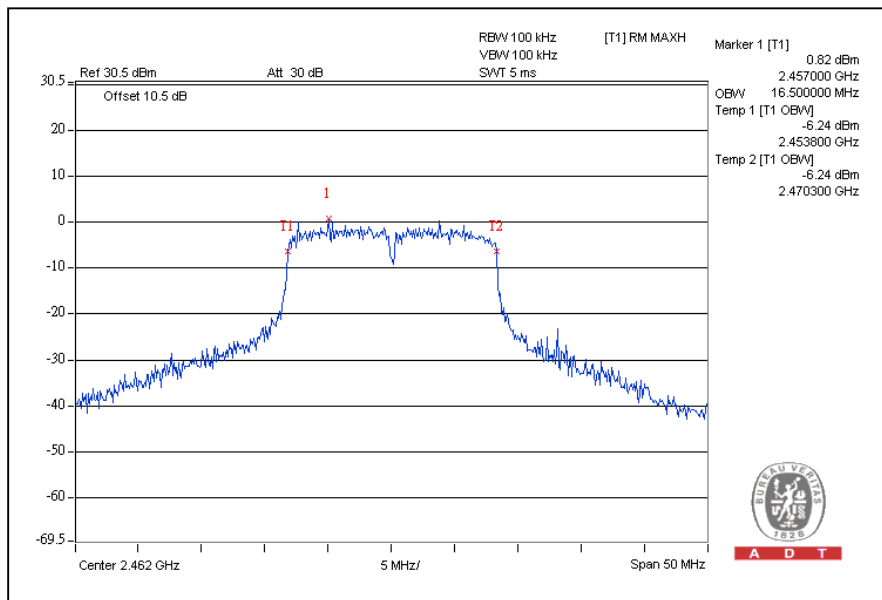



A D T

802.11n (20MHz) OFDM MODULATION:

CHANNEL	CHANNEL FREQUENCY (MHz)	99% BANDWIDTH (MHz)
1	2412	16.5
6	2437	20.5
11	2462	16.5

CH1

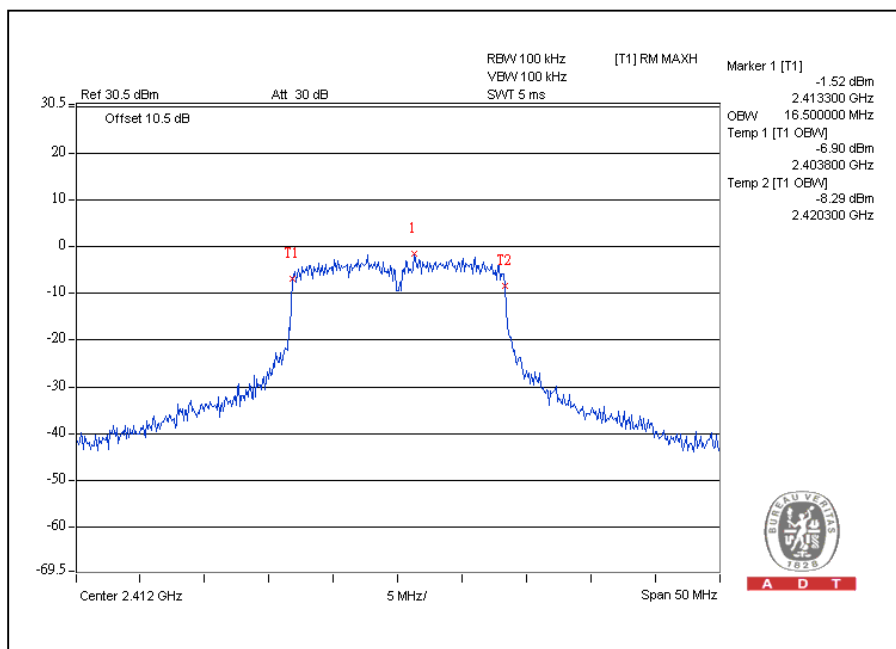



A D T

CH6

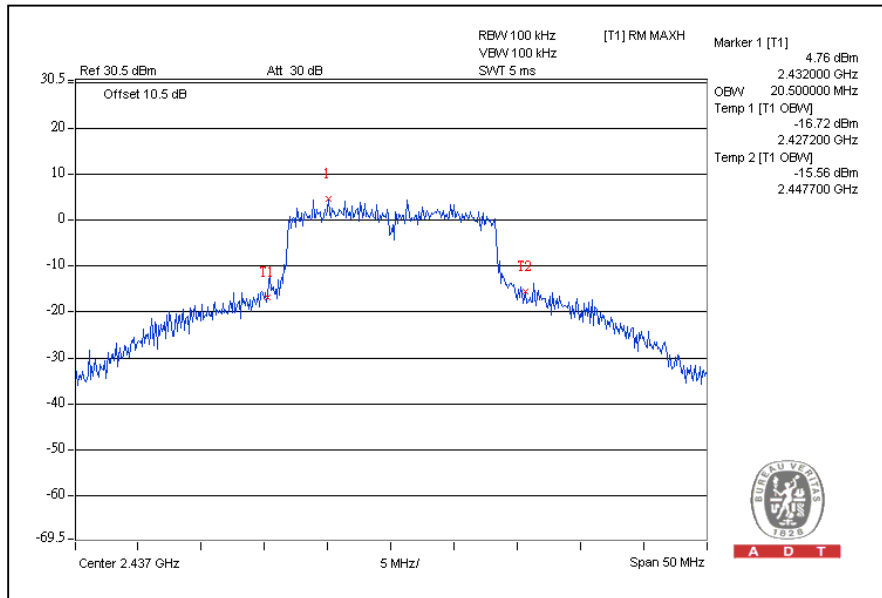

CH11

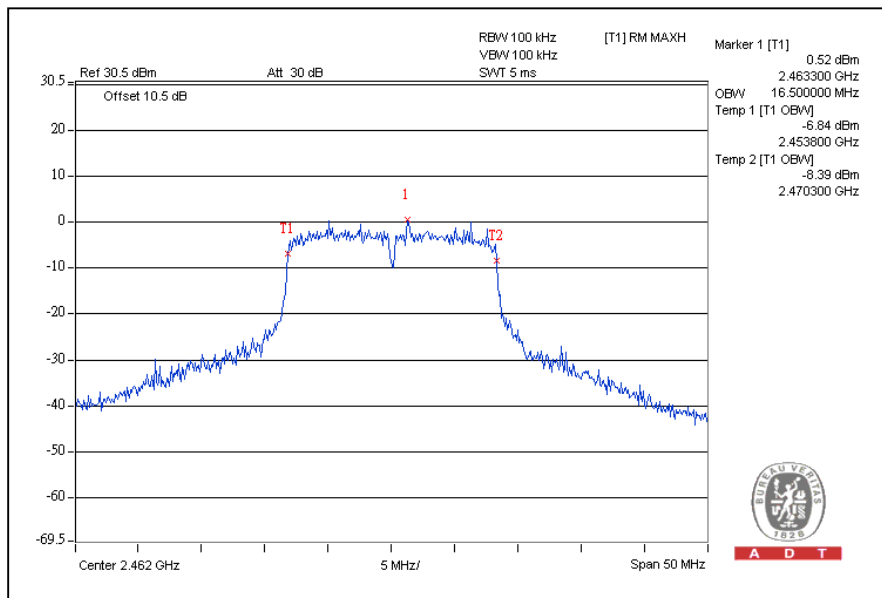

4.5 MAXIMUM PEAK OUTPUT POWER

4.5.1 LIMITS OF MAXIMUM PEAK OUTPUT POWER MEASUREMENT

The Maximum Peak Output Power Measurement is 30dBm.

4.5.2 INSTRUMENTS

DESCRIPTION & MANUFACTURER	MODEL NO.	SERIAL NO.	CALIBRATED DATE	CALIBRATED UNTIL
Peak Power Meter	ML2495A	0824006	May 04, 2010	May 03, 2011
Power Sensor	MA2411B	0738172	May 04, 2010	May 03, 2011

NOTE: The calibration interval of the above test instruments is 12 months and the calibrations are traceable to NML/ROC and NIST/USA.

4.5.3 TEST PROCEDURES

1. The transmitter output was connected to the power meter through an attenuator; the bandwidth of the fundamental frequency was measured with the power meter.
2. Record the power level.

4.5.4 DEVIATION FROM TEST STANDARD

No deviation

4.5.5 TEST SETUP

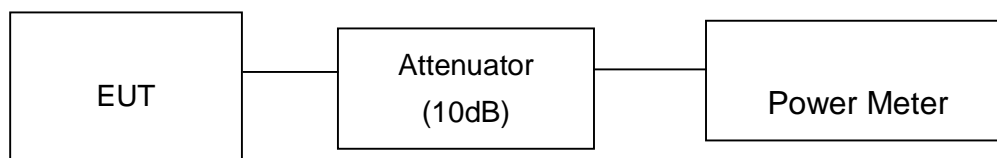

4.5.6 EUT OPERATING CONDITIONS

Same as Item 4.3.6



A D T

4.5.7 TEST RESULTS

802.11b DSSS MODULATION:

CHANNEL	CHANNEL FREQUENCY (MHz)	PEAK POWER OUTPUT (dBm)	PEAK POWER OUTPUT (mW)	PEAK POWER LIMIT (dBm)	PASS / FAIL
1	2412	20.9	123.0	30	PASS
6	2437	20.8	120.2	30	PASS
11	2462	21.0	125.9	30	PASS

802.11g OFDM MODULATION:

CHANNEL	CHANNEL FREQUENCY (MHz)	PEAK POWER OUTPUT (dBm)	PEAK POWER OUTPUT (mW)	PEAK POWER LIMIT (dBm)	PASS / FAIL
1	2412	22.3	169.8	30	PASS
6	2437	23.8	239.9	30	PASS
11	2462	23.0	199.5	30	PASS

802.11n (20MHz) OFDM MODULATION:

CHANNEL	CHANNEL FREQUENCY (MHz)	PEAK POWER OUTPUT (dBm)	PEAK POWER OUTPUT (mW)	PEAK POWER LIMIT (dBm)	PASS / FAIL
1	2412	21.7	147.9	30	PASS
6	2437	23.7	234.4	30	PASS
11	2462	22.4	173.8	30	PASS

4.6 AVERAGE OUTPUT POWER

4.6.1 FOR REFERENCE.

4.6.2 TEST INSTRUMENTS

DESCRIPTION & MANUFACTURER	MODEL NO.	SERIAL NO.	CALIBRATED DATE	CALIBRATED UNTIL
Peak Power Meter	ML2495A	0824006	May 04, 2010	May 03, 2011
Power Sensor	MA2411B	0738172	May 04, 2010	May 03, 2011

NOTE: The calibration interval of the above test instruments is 12 months and the calibrations are traceable to NML/ROC and NIST/USA.

4.6.3 TEST PROCEDURES

1. The transmitter output was connected to the power meter through an attenuator, the bandwidth of the fundamental frequency was measured with the power meter.
2. Record the average power level.

4.6.4 TEST SETUP

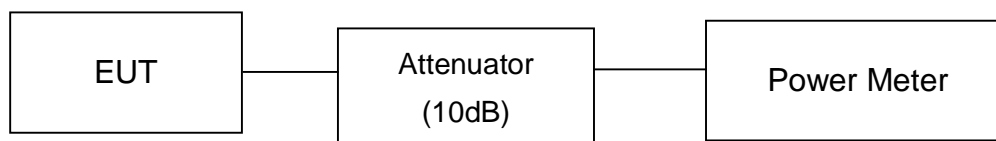

4.6.5 EUT OPERATING CONDITIONS

Same as Item 4.3.5



A D T

4.6.6 TEST RESULTS

802.11b DSSS MODULATION:

CHANNEL	CHANNEL FREQUENCY (MHz)	AVERAGE POWER OUTPUT (dBm)
1	2412	18.8
6	2437	19.0
11	2462	18.8

802.11g OFDM MODULATION:

CHANNEL	CHANNEL FREQUENCY (MHz)	AVERAGE POWER OUTPUT (dBm)
1	2412	14.0
6	2437	19.5
11	2462	15.3

802.11n (20MHz) OFDM MODULATION:

CHANNEL	CHANNEL FREQUENCY (MHz)	AVERAGE POWER OUTPUT (dBm)
1	2412	13.3
6	2437	19.1
11	2462	14.7

4.7 POWER SPECTRAL DENSITY MEASUREMENT

4.7.1 LIMITS OF POWER SPECTRAL DENSITY MEASUREMENT

The Maximum of Power Spectral Density Measurement is 8dBm.

4.7.2 TEST INSTRUMENTS

DESCRIPTION & MANUFACTURER	MODEL NO.	SERIAL NO.	CALIBRATED DATE	CALIBRATED UNTIL
Spectrum Analyzer	E4446A	MY48250254	July 14, 2010	July 13, 2011

NOTE: The calibration interval of the above test instruments is 12 months and the calibrations are traceable to NML/ROC and NIST/USA.

4.7.3 TEST PROCEDURE

The transmitter output was connected to the spectrum analyzer through an attenuator, the bandwidth of the fundamental frequency was measured with the spectrum analyzer using 3kHz RBW and 30kHz VBW, set sweep time = span/3kHz. The power spectral density was measured and recorded. The sweep time is allowed to be longer than span/3kHz for a full response of the mixer in the spectrum analyzer.

4.7.4 DEVIATION FROM TEST STANDARD

No deviation

4.7.5 TEST SETUP

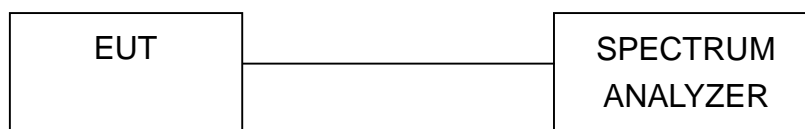

4.7.6 EUT OPERATING CONDITION

Same as Item 4.3.6

4.7.7 TEST RESULTS

802.11b DSSS MODULATION:

CHANNEL	CHANNEL FREQUENCY (MHz)	RF POWER LEVEL IN 3kHz BW (dBm)	MAXIMUM LIMIT (dBm)	PASS / FAIL
1	2412	-5.8	8	PASS
6	2437	-4.6	8	PASS
11	2462	-6.5	8	PASS

CH1

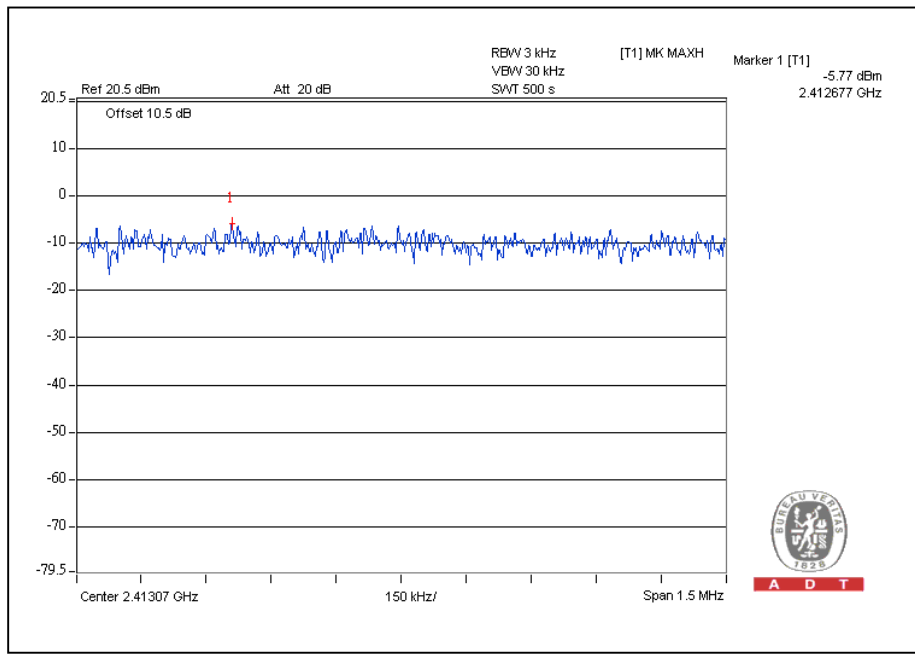



A D T

CH6

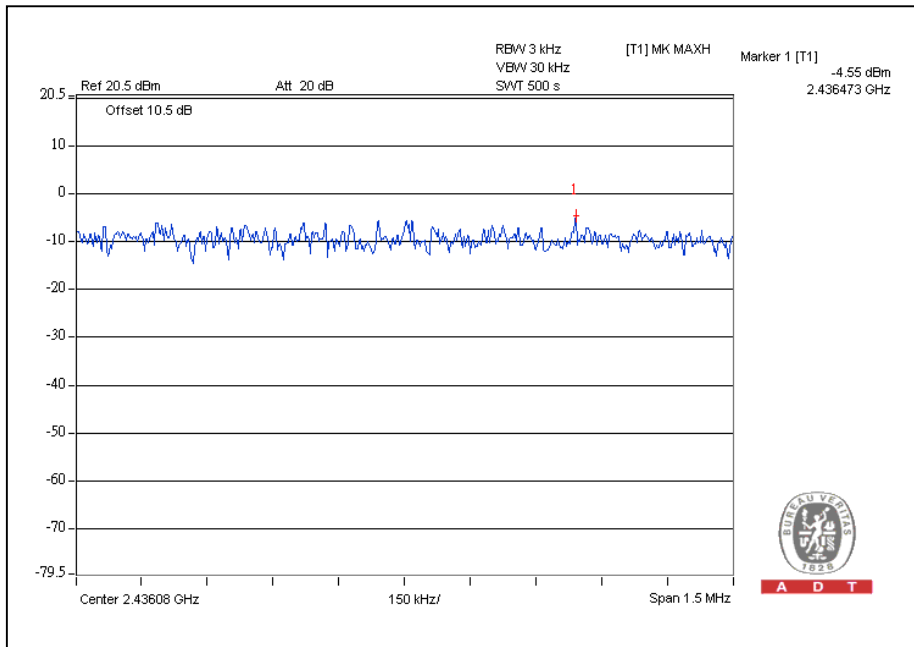

CH11

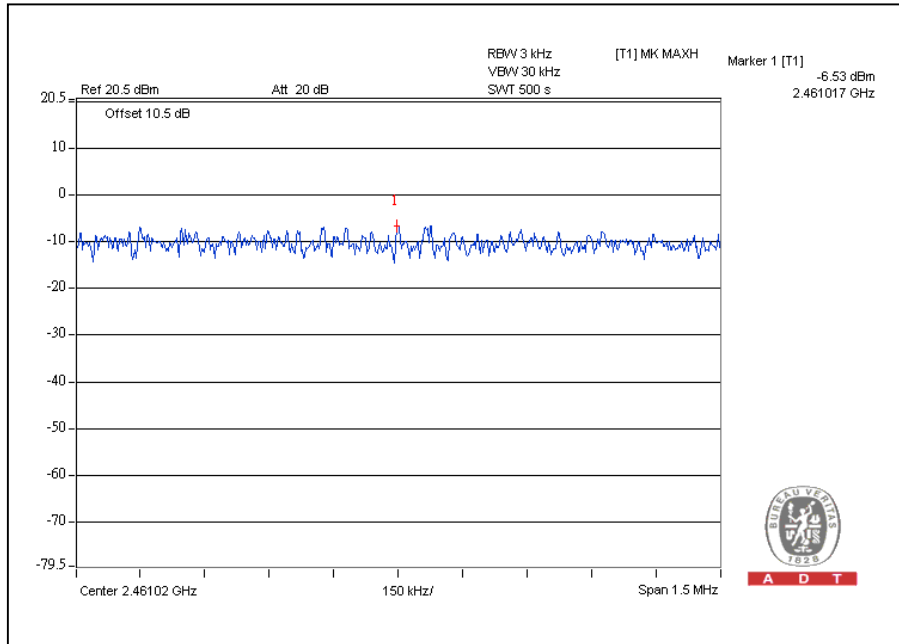



A D T

802.11g OFDM MODULATION:

CHANNEL	CHANNEL FREQUENCY (MHz)	RF POWER LEVEL IN 3kHz BW (dBm)	MAXIMUM LIMIT (dBm)	PASS / FAIL
1	2412	-12.8	8	PASS
6	2437	-6.1	8	PASS
11	2462	-9.8	8	PASS

CH1

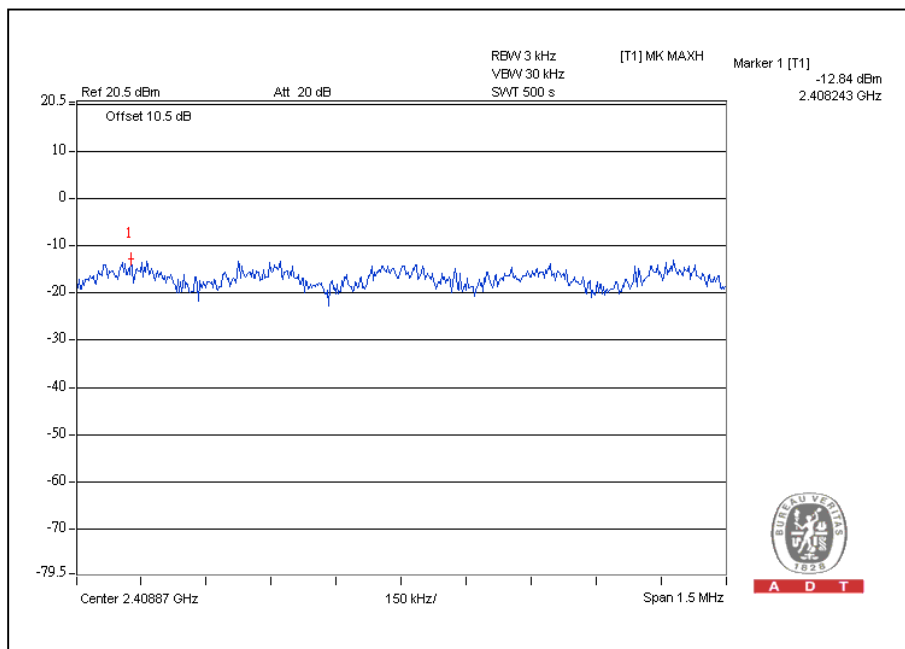

A D T



A D T

CH6

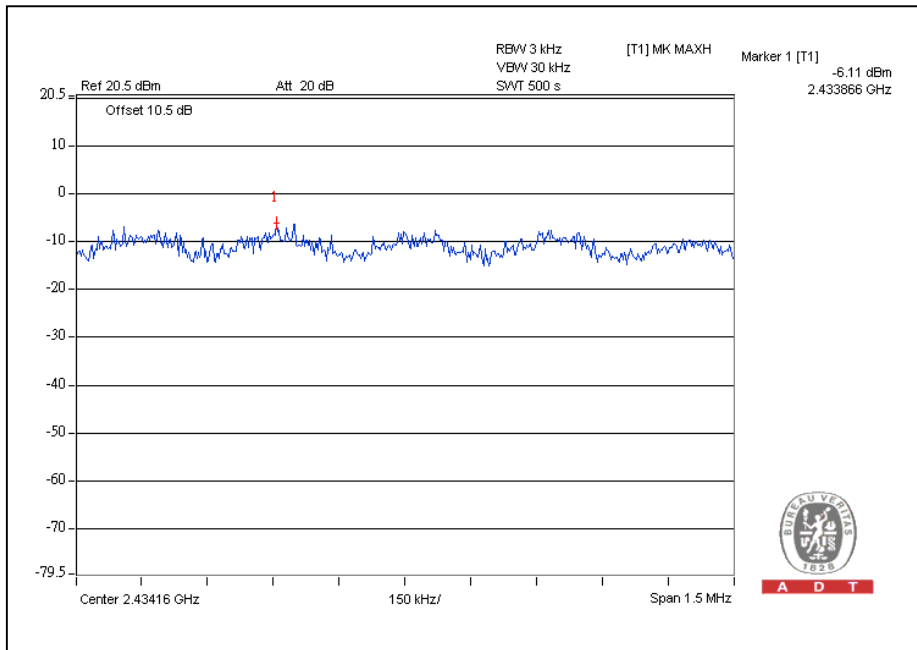

CH11

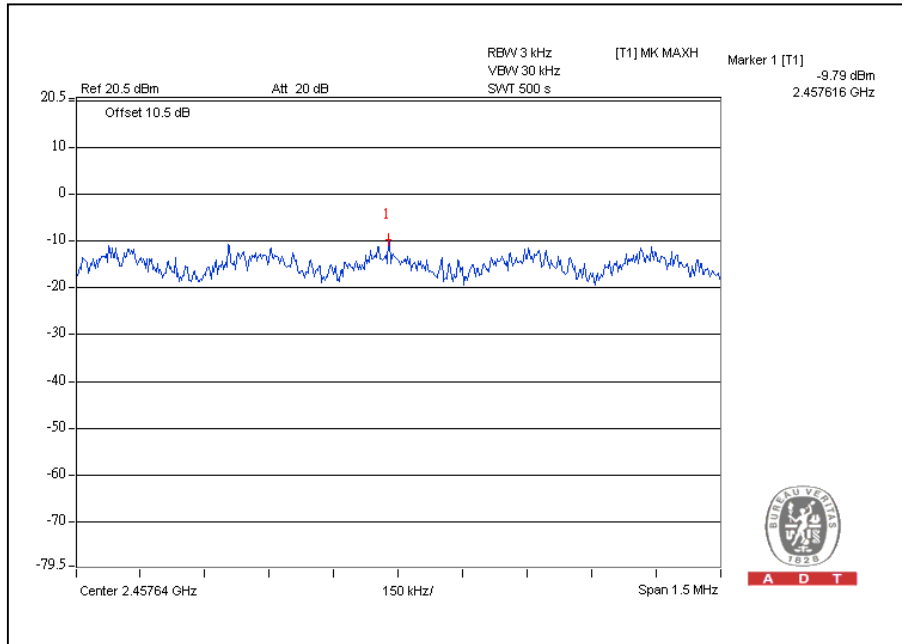



A D T

802.11n (20MHz) OFDM MODULATION:

CHANNEL	CHANNEL FREQUENCY (MHz)	RF POWER LEVEL IN 3kHz BW (dBm)	MAXIMUM LIMIT (dBm)	PASS / FAIL
1	2412	-13.3	8	PASS
6	2437	-6.7	8	PASS
11	2462	-11.7	8	PASS

CH1

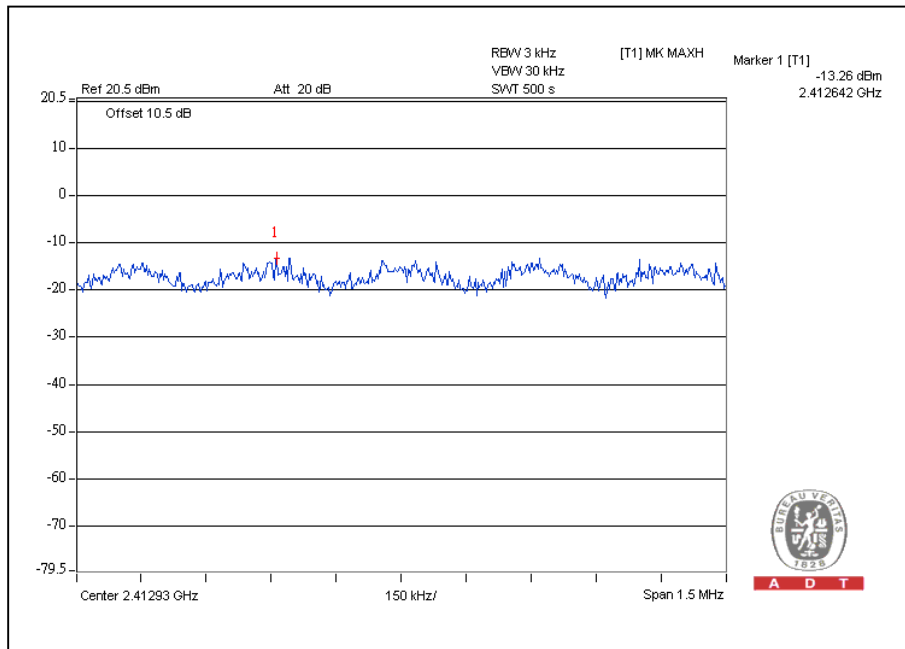



A D T

CH6

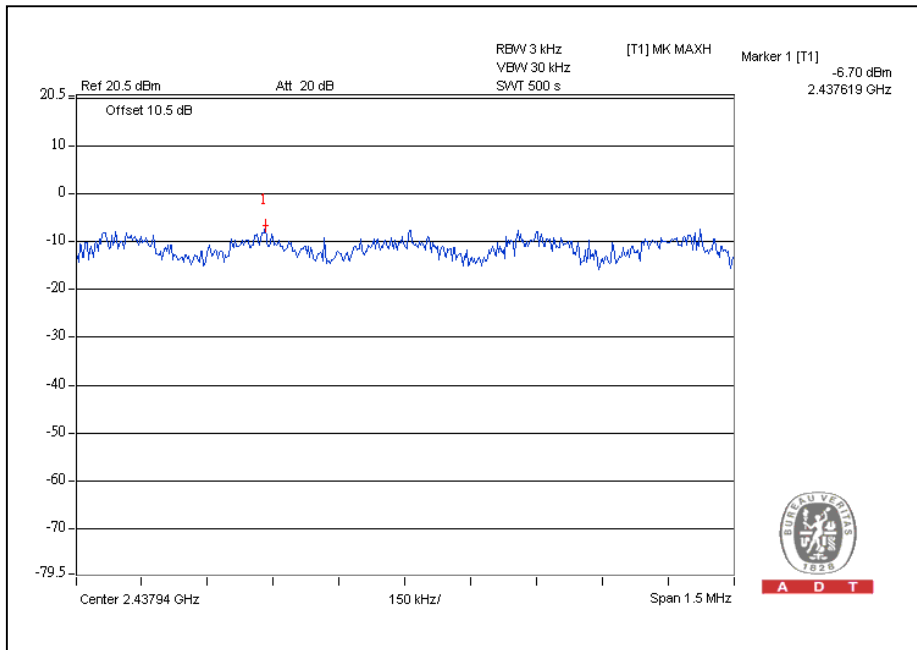

CH11

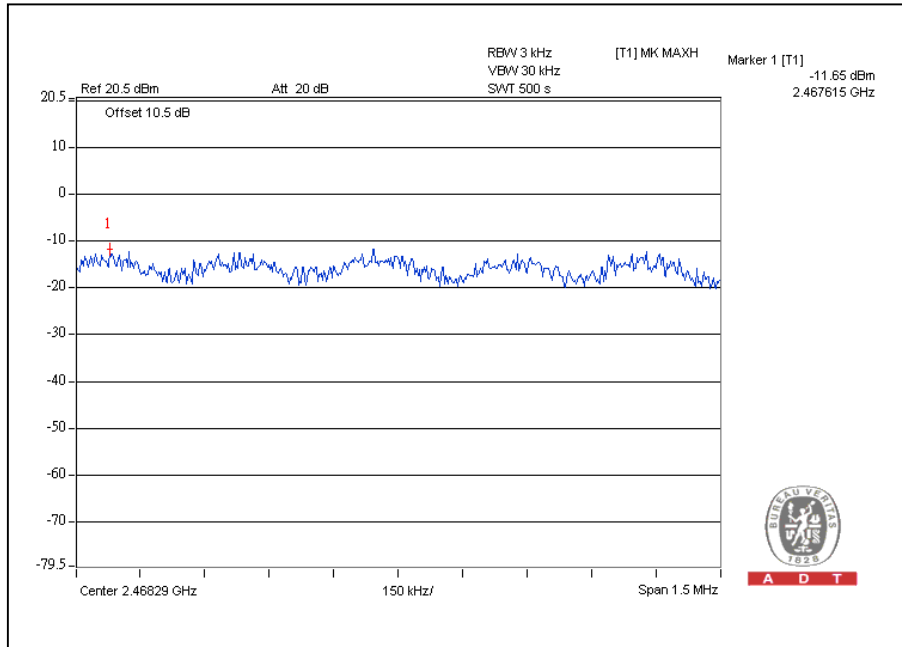

4.8 CONDUCTED OUT-BAND EMISSION MEASUREMENT

4.8.1 LIMITS OF CONDUCTED OUT-BAND EMISSION MEASUREMENT

Below -20dB of the highest emission level of operating band (in 100kHz Resolution Bandwidth).

4.8.2 TEST INSTRUMENTS

DESCRIPTION & MANUFACTURER	MODEL NO.	SERIAL NO.	CALIBRATED DATE	CALIBRATED UNTIL
Spectrum Analyzer	E4446A	MY48250254	July 14, 2010	July 13, 2011

NOTE: The calibration interval of the above test instruments is 12 months and the calibrations are traceable to NML/ROC and NIST/USA.

4.8.3 TEST PROCEDURE

The transmitter output was connected to the spectrum analyzer via a low loss cable. Set RBW of spectrum analyzer to 100kHz and VBW of spectrum analyzer to 300kHz with suitable frequency span including 100 MHz bandwidth from band edge. The band edges was measured and recorded.

The spectrum plots (RBW = 100kHz, VBW = 300kHz) are attached on the following pages.

4.8.4 DEVIATION FROM TEST STANDARD

No deviation

4.8.5 EUT OPERATING CONDITION

Same as Item 4.3.6

4.8.6 TEST RESULTS

The spectrum plots are attached on the following images. D1 line indicates the highest level, and D2 line indicates the 20dB offset below D1. It shows compliance with the requirement in part 15.247(d).

802.11b DSSS MODULATION:

CH1

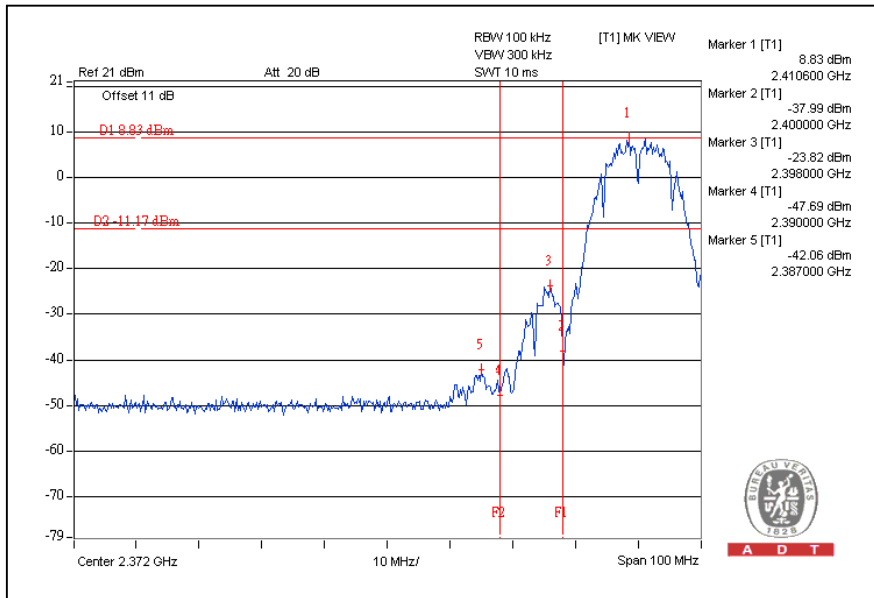

CH11

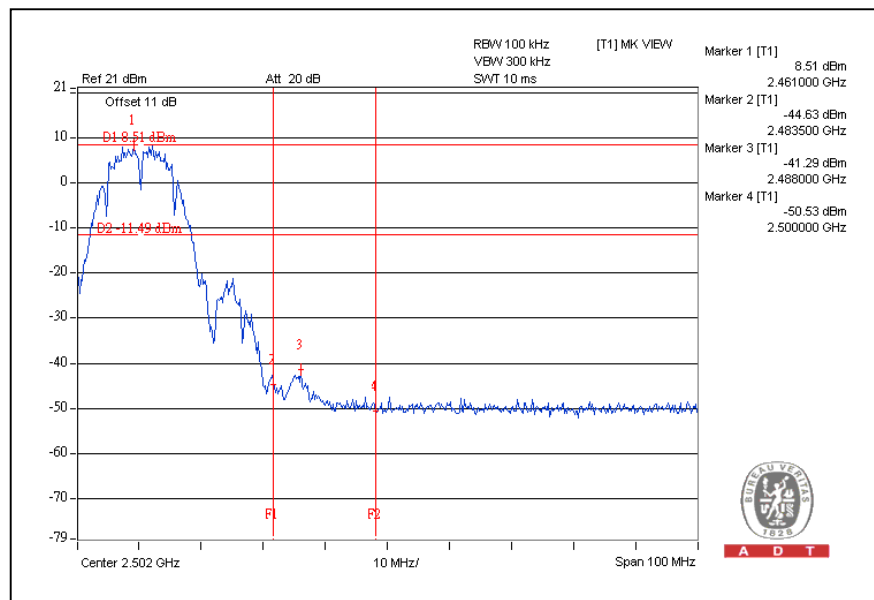



A D T

CH1

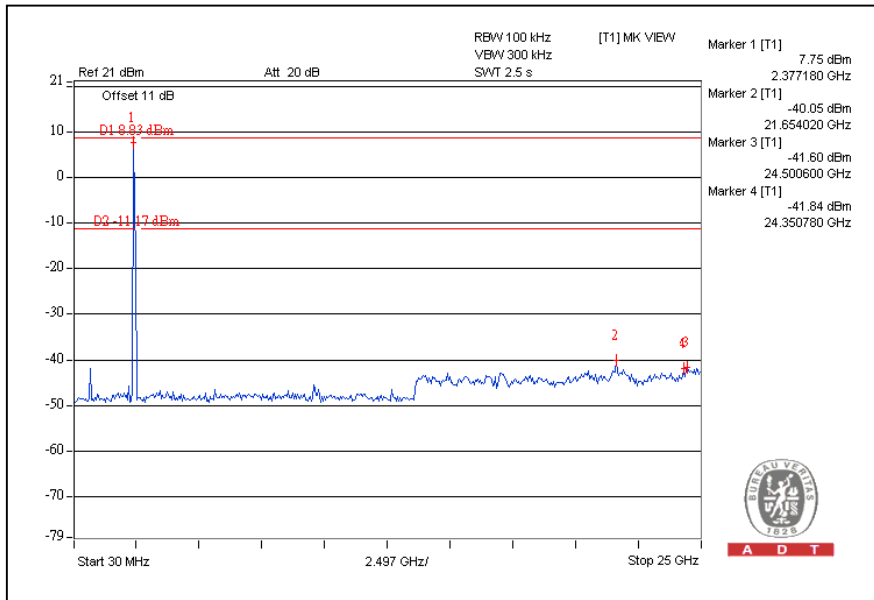

CH11

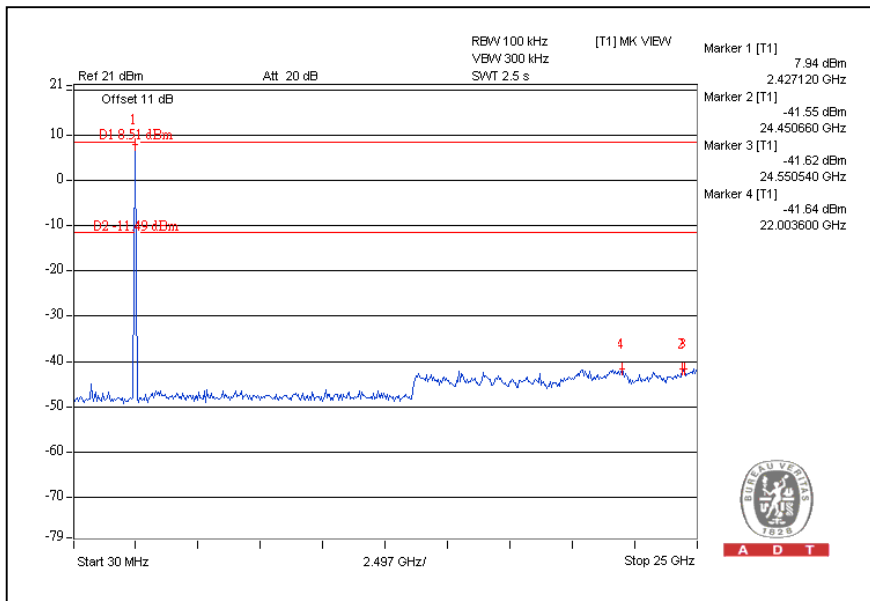

802.11g OFDM MODULATION:

CH1

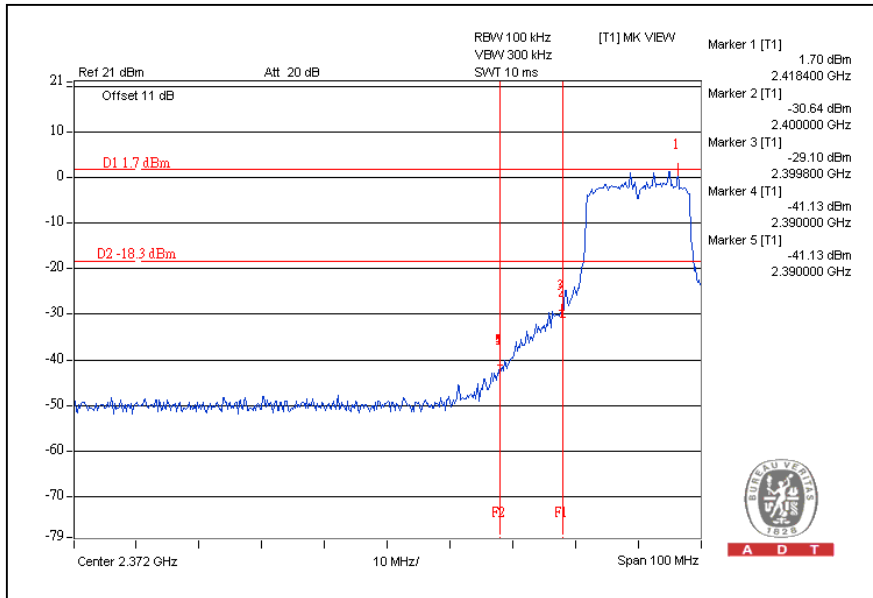

CH11

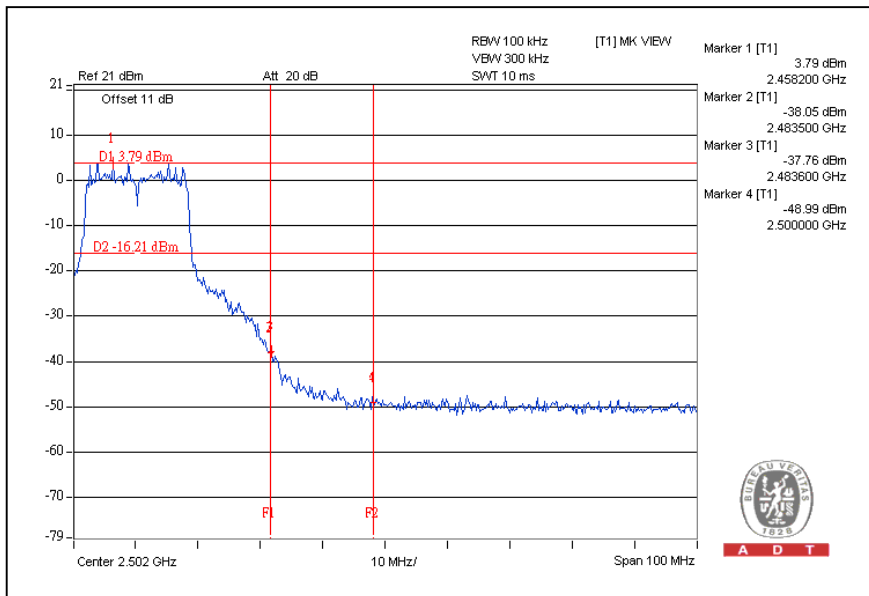



A D T

CH1

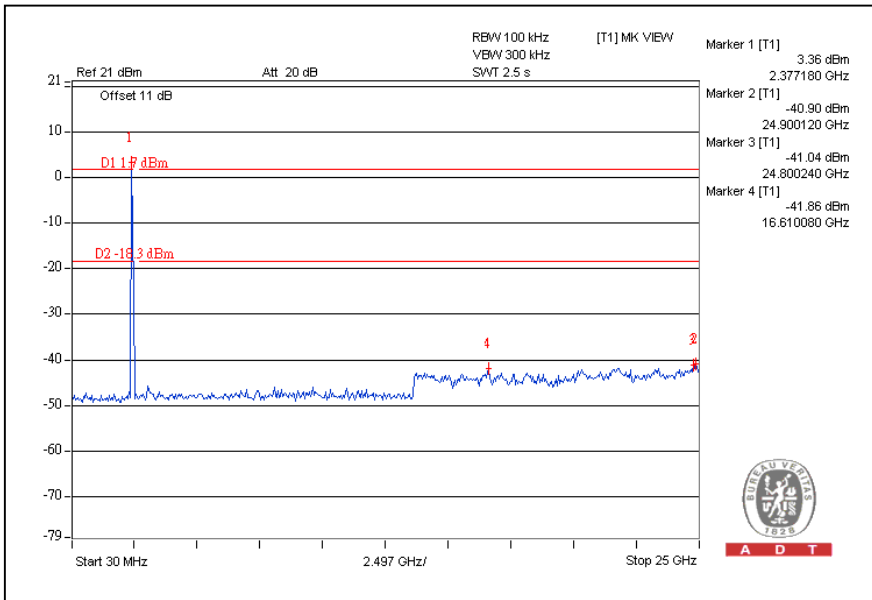

CH11

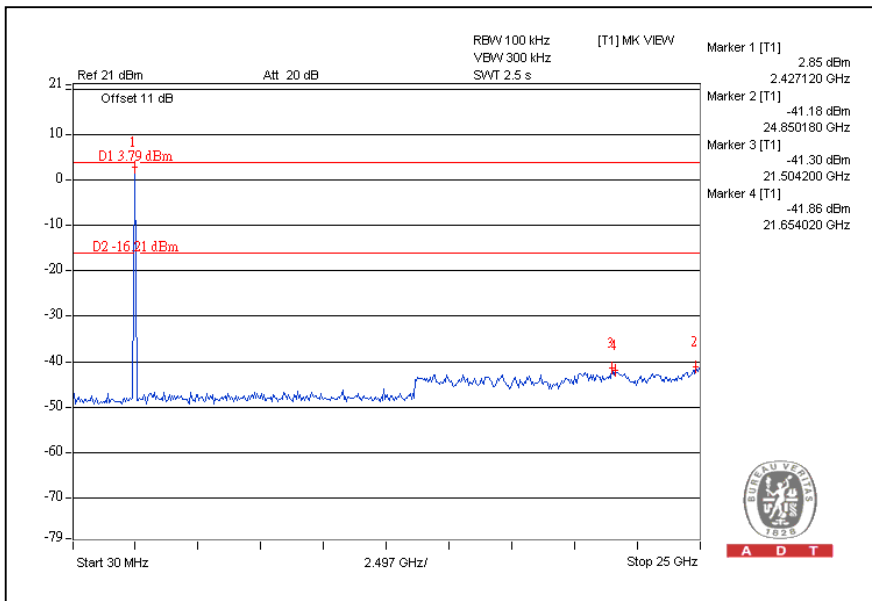

802.11n (20MHz) OFDM MODULATION:

CH1

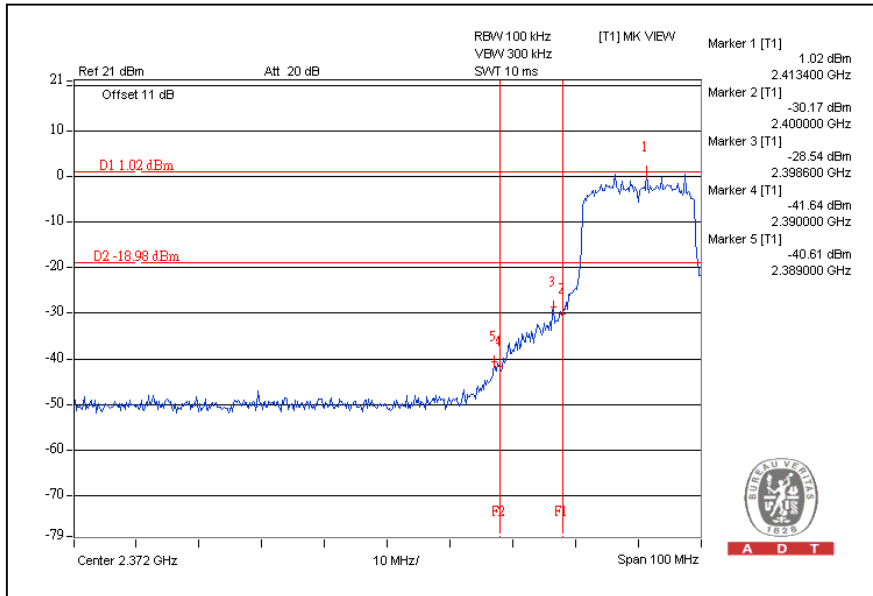

CH11

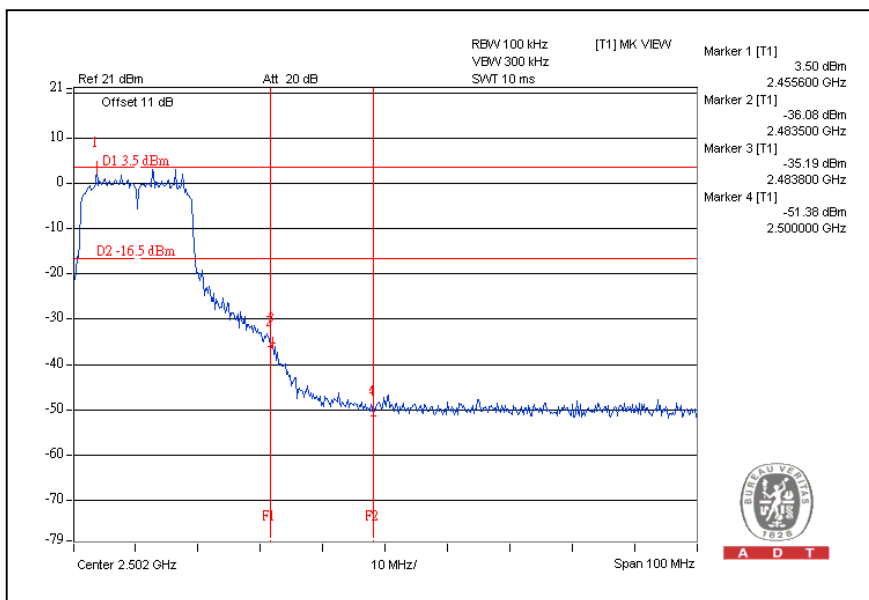



A D T

CH1

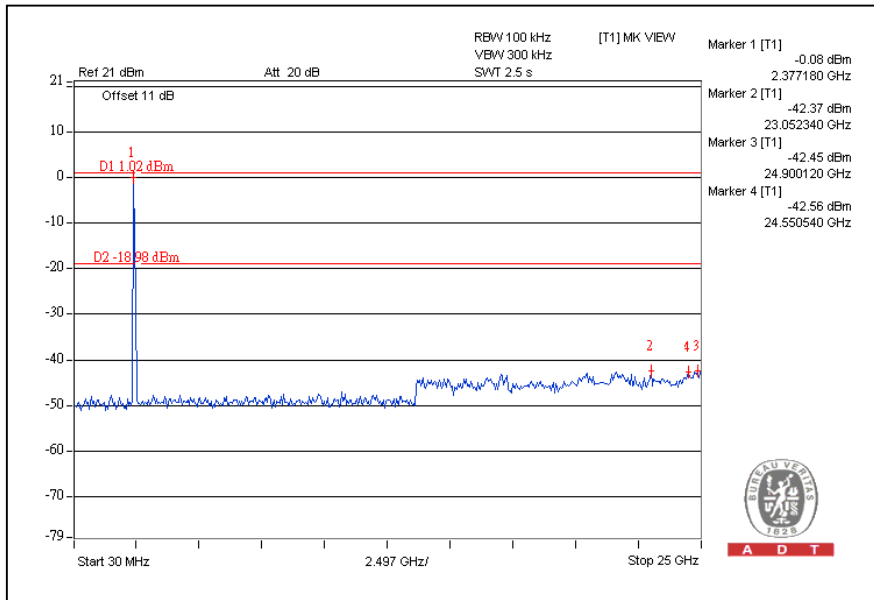

CH11

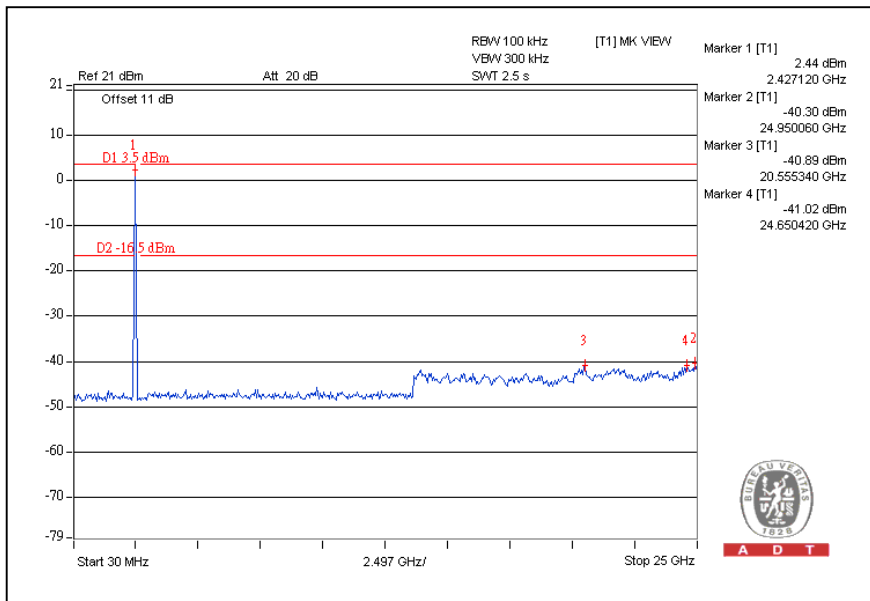

5. TEST TYPES AND RESULTS (802.11a, 5725~5850MHz Band)

5.1 CONDUCTED EMISSION MEASUREMENT

5.1.1 LIMITS OF CONDUCTED EMISSION MEASUREMENT

FREQUENCY OF EMISSION (MHz)	CONDUCTED LIMIT (dB μ V)	
	Quasi-peak	Average
0.15-0.5	66 to 56	56 to 46
0.5-5	56	46
5-30	60	50

- NOTE:**
1. The lower limit shall apply at the transition frequencies.
 2. The limit decreases in line with the logarithm of the frequency in the range of 0.15 to 0.50 MHz.
 3. All emanations from a class A/B digital device or system, including any network of conductors and apparatus connected thereto, shall not exceed the level of field strengths specified above.

5.1.2 TEST INSTRUMENTS

DESCRIPTION & MANUFACTURER	MODEL NO.	SERIAL NO.	CALIBRATED DATE	CALIBRATED UNTIL
Test Receiver	ESCS 30	100375	Mar. 09, 2010	Mar. 08, 2011
Line-Impedance Stabilization Network (for EUT)	NSLK 8127	8127-522	Sep. 23, 2009	Sep. 22, 2010
Line-Impedance Stabilization Network (for Peripheral)	ESH3-Z5	848773/004	Oct. 26, 2009	Oct. 25, 2010
RF Cable (JYEBAO)	5DFB	COBCAB-001	Nov. 24, 2009	Nov. 23, 2010
50 ohms Terminator	50	3	Oct. 28, 2009	Oct. 27, 2010
Software	BV ADT_Cond_V7.3.7	NA	NA	NA

Note:

1. The calibration interval of the above test instruments is 12 months and the calibrations are traceable to NML/ROC and NIST/USA.
2. The test was performed in Shielded Room No. C.
3. The VCCI Con C Registration No. is C-3611.

5.1.3 TEST PROCEDURES

- a. The EUT was placed 0.4 meters from the conducting wall of the shielded room with EUT being connected to the power mains through a line impedance stabilization network (LISN). Other support units were connected to the power mains through another LISN. The two LISNs provide 50 ohm/50uH of coupling impedance for the measuring instrument.
- b. Both lines of the power mains connected to the EUT were checked for maximum conducted interference.
- c. The frequency range from 150kHz to 30MHz was searched. Emission levels under (Limit – 20dB) were not recorded.

5.1.4 DEVIATION FROM TEST STANDARD

No deviation

5.1.5 TEST SETUP

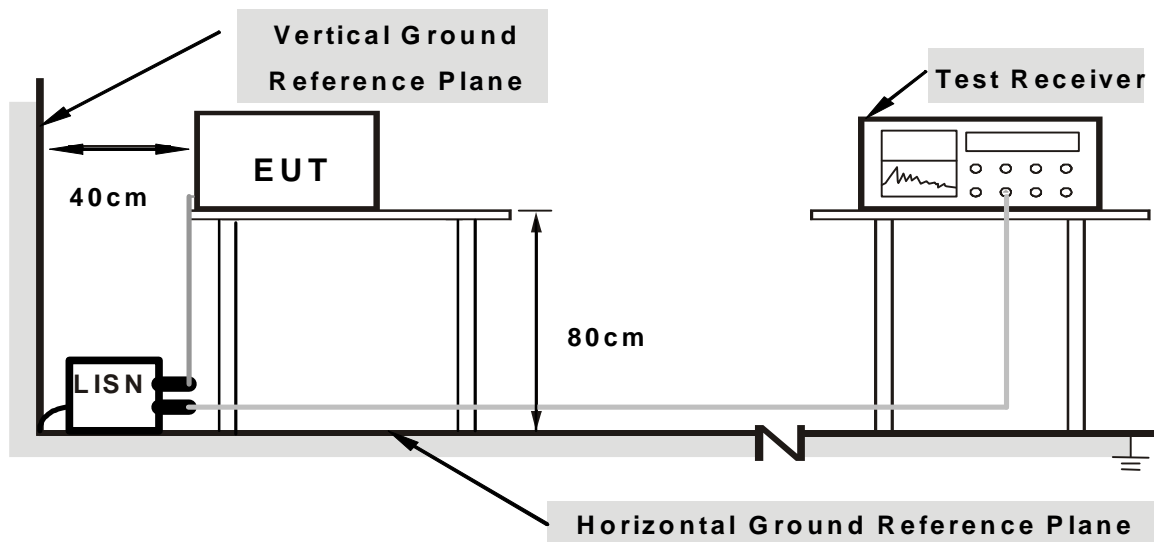

Note: 1. Support units were connected to second LISN.

2. Both of LISNs (AMN) are 80 cm from EUT and at least 80 from other units and other metal planes

For the actual test configuration, please refer to the related item – Photographs of the Test Configuration.

5.1.6 EUT OPERATING CONDITIONS

Same as the 4.1.6

5.1.7 TEST RESULTS

PHASE	Line (L)	6dB BANDWIDTH	9 kHz
-------	----------	---------------	-------

No	Freq.	Corr.	Reading Value		Emission Level		Limit		Margin	
	[MHz]	Factor	[dB (uV)]		[dB (uV)]		[dB (uV)]		(dB)	
		(dB)	Q.P.	AV.	Q.P.	AV.	Q.P.	AV.	Q.P.	AV.
1	0.181	0.05	46.05	-	46.10	-	64.43	54.43	-18.33	-
2	0.232	0.05	43.97	-	44.02	-	62.38	52.38	-18.36	-
3	0.259	0.05	43.76	-	43.81	-	61.45	51.45	-17.64	-
4	0.275	0.05	36.50	-	36.55	-	60.97	50.97	-24.41	-
5	3.664	0.18	35.14	-	35.32	-	56.00	46.00	-20.68	-
6	19.543	0.50	36.50	-	37.00	-	60.00	50.00	-23.00	-

- REMARKS:**
1. Q.P. and AV. are abbreviations of quasi-peak and average individually.
 2. "-": The Quasi-peak reading value also meets average limit and measurement with the average detector is unnecessary.
 3. The emission levels of other frequencies were very low against the limit.
 4. Margin value = Emission level - Limit value
 5. Correction factor = Insertion loss + Cable loss
 6. Emission Level = Correction Factor + Reading Value.

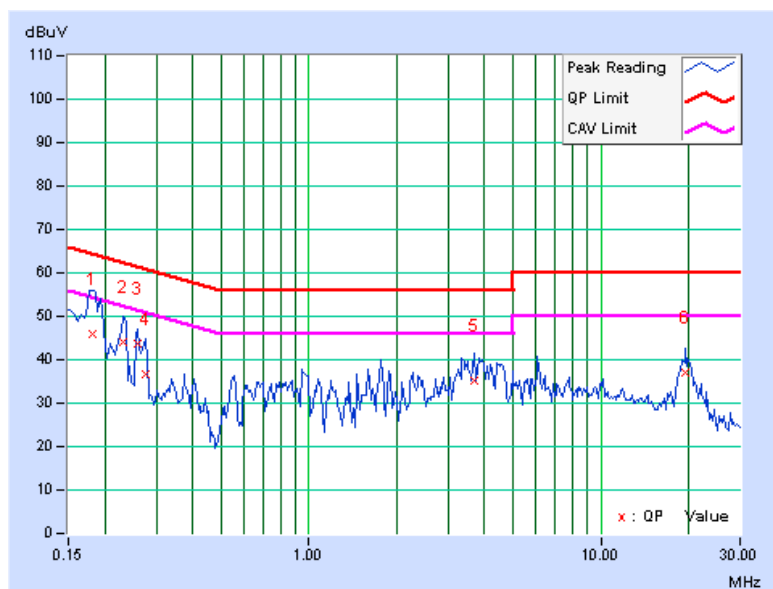

PHASE	Neutral (N)	6dB BANDWIDTH	9 kHz
--------------	-------------	----------------------	-------

No	Freq.	Corr.	Reading Value		Emission Level		Limit		Margin	
	[MHz]	Factor	[dB (uV)]		[dB (uV)]		[dB (uV)]		(dB)	
		(dB)	Q.P.	AV.	Q.P.	AV.	Q.P.	AV.	Q.P.	AV.
1	0.201	0.06	35.70	-	35.76	-	63.58	53.58	-27.82	-
2	0.232	0.06	45.18	-	45.24	-	62.38	52.38	-17.14	-
3	0.240	0.06	45.92	-	45.98	-	62.10	52.10	-16.12	-
4	1.867	0.13	35.56	-	35.69	-	56.00	46.00	-20.31	-
5	2.031	0.14	34.65	-	34.79	-	56.00	46.00	-21.21	-
6	3.738	0.19	33.60	-	33.79	-	56.00	46.00	-22.21	-

- REMARKS:**
1. Q.P. and AV. are abbreviations of quasi-peak and average individually.
 2. "-": The Quasi-peak reading value also meets average limit and measurement with the average detector is unnecessary.
 3. The emission levels of other frequencies were very low against the limit.
 4. Margin value = Emission level - Limit value
 5. Correction factor = Insertion loss + Cable loss
 6. Emission Level = Correction Factor + Reading Value.

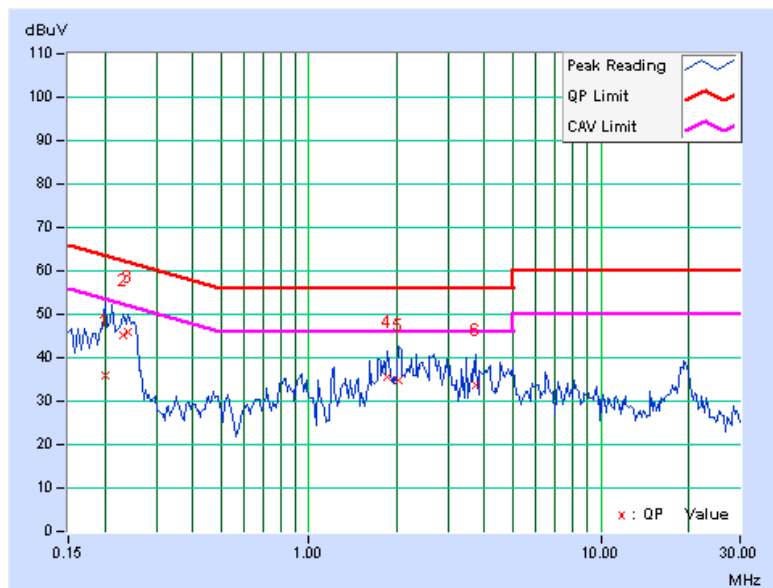

5.2 RADIATED EMISSION MEASUREMENT

5.2.1 LIMITS OF RADIATED EMISSION MEASUREMENT

Emissions radiated outside of the specified bands, shall be according to the general radiated limits in 15.209(RSS-210 table 2&3) as following:

Frequencies (MHz)	Field strength (microvolts/meter)	Measurement distance (meters)
0.009-0.490	2400/F(kHz)	300
0.490-1.705	24000/F(kHz)	30
1.705-30.0	30	30
30-88	100	3
88-216	150	3
216-960	200	3
Above 960	500	3

NOTE:

1. The lower limit shall apply at the transition frequencies.
2. Emission level (dBuV/m) = 20 log Emission level (uV/m).
3. As shown in 15.35(b), for frequencies above 1000MHz, the field strength limits are based on average detector, however, the peak field strength of any emission shall not exceed the maximum permitted average limits, specified above by more than 20dB under any condition of modulation.



A D T

5.2.2 TEST INSTRUMENTS

DESCRIPTION & MANUFACTURER	MODEL NO.	SERIAL NO.	CALIBRATED DATE	CALIBRATED UNTIL
Agilent Spectrum Analyzer	E4446A	MY48250254	July 14, 2010	July 13, 2011
Agilent Pre-Selector	N9039A	MY46520310	Aug. 18, 2009	Aug. 17, 2010
Agilent Signal Generator	N5181A	MY49060347	July 18, 2010	July 17, 2011
LIG NEX1 Test Receiver	ER-265	L09068005	Aug. 31, 2009	Aug. 30, 2010
Mini-Circuits Pre-Amplifier	ZFL-1000VH2B	AMP-ZFL-04	Nov. 18, 2009	Nov. 17, 2010
Agilent Pre-Amplifier	8449B	3008A02465	Mar. 01, 2010	Feb. 28, 2011
Miteq Pre-Amplifier	AFS33-1800265 0-30-8P-44	881786	NA	NA
SCHWARZBECK Trilog Broadband Antenna	VULB 9168	9168-361	Sep. 30, 2009	Sep. 29, 2010
AISI Horn_Antenna	AIH.8018	0000220091110	Nov. 16, 2009	Nov. 15, 2010
SCHWARZBECK Horn_Antenna	BBHA 9170	9170-424	Sep. 30, 2009	Sep. 29, 2010
RF CABLE	NA	RF104-205 RF104-207 RF104-208	Dec. 24, 2009	Dec. 23, 2010
RF Cable	NA	CHHCAB_001	NA	NA
Software	ADT_Radiated_V8.7.05	NA	NA	NA
CT Antenna Tower & Turn Table	NA	NA	NA	NA

Note: 1. The calibration interval of the above test instruments is 12 months and the calibrations are traceable to NML/ROC and NIST/USA.

2. The horn antenna, preamplifier (model: 8449B) are used only for the measurement of emission frequency above 1GHz if tested.

3. The test was performed in 966 Chamber No. H.

4. The FCC Site Registration No. is 797305.

5. The CANADA Site Registration No. is IC 7450H-3.

5.2.3 TEST PROCEDURES

- a. The EUT was placed on the top of a rotating table 0.8 meters above the ground at a 3 meter chamber room. The table was rotated 360 degrees to determine the position of the highest radiation.
- b. The EUT was set 3 meters away from the interference-receiving antenna, which was mounted on the top of a variable-height antenna tower.
- c. The antenna is a broadband antenna, and its height is varied from one meter to four meters above the ground to determine the maximum value of the field strength. Both horizontal and vertical polarizations of the antenna are set to make the measurement.
- d. For each suspected emission, the EUT was arranged to its worst case and then the antenna was tuned to heights from 1 meter to 4 meters and the rotatable table was turned from 0 degrees to 360 degrees to find the maximum reading.
- e. The test-receiver system was set to Peak Detect Function and Specified Bandwidth with Maximum Hold Mode.
- f. If the emission level of the EUT in peak mode was 10dB lower than the limit specified, then testing could be stopped and the peak values of the EUT would be reported. Otherwise the emissions that did not have 10dB margin would be re-tested one by one using peak, quasi-peak or average method as specified and then reported in a data sheet.

NOTE:

1. The resolution bandwidth and video bandwidth of test receiver/spectrum analyzer is 120kHz for Peak detection (PK) and Quasi-peak detection (QP) at frequency below 1GHz.
2. The resolution bandwidth of test receiver/spectrum analyzer is 1 MHz and the video bandwidth is 3 MHz for Peak detection (PK) at frequency above 1GHz.
3. The resolution bandwidth of test receiver/spectrum analyzer is 1 MHz and the video bandwidth is 10 Hz for Average detection (AV) at frequency above 1GHz.

5.2.4 DEVIATION FROM TEST STANDARD

No deviation

5.2.5 TEST SETUP

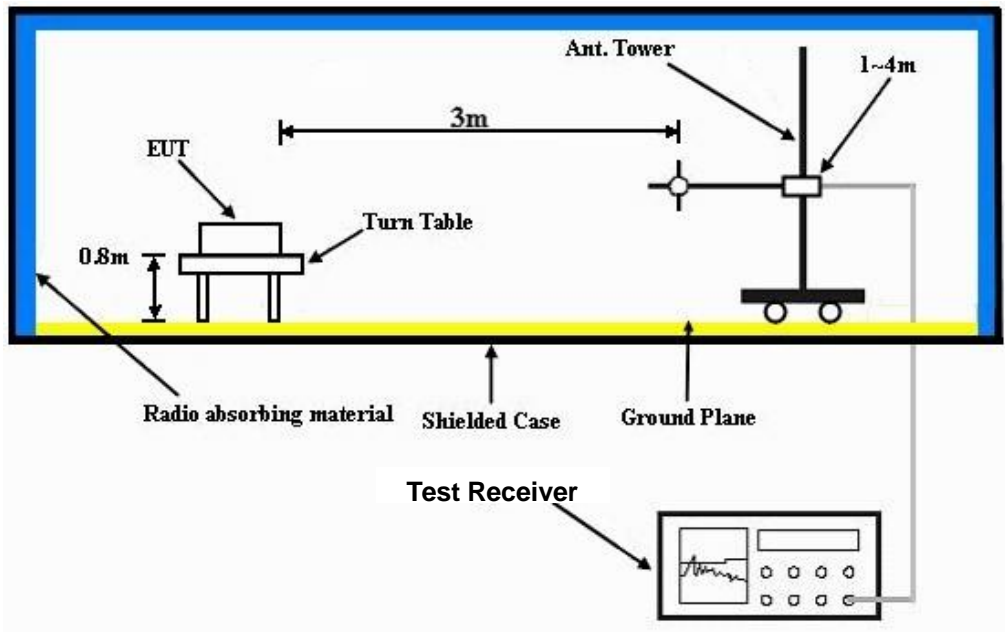

For the actual test configuration, please refer to the related item – Photographs of the Test Configuration.

5.2.6 EUT OPERATING CONDITIONS

Same as the 4.2.6

5.2.7 TEST RESULTS (FOR TRANSMITTER PART)

BELOW 1GHz WORST-CASE DATA : 802.11n (40MHz) OFDM MODULATION

EUT TEST CONDITION		MEASUREMENT DETAIL	
CHANNEL	Channel 159	FREQUENCY RANGE	Below 1000MHz
INPUT POWER (SYSTEM)	120Vac, 60 Hz	DETECTOR FUNCTION	Quasi-Peak
ENVIRONMENTAL CONDITIONS	24deg. C, 70%RH 1011 hPa	TESTED BY	Eric Lee

ANTENNA POLARITY & TEST DISTANCE: HORIZONTAL AT 3 M								
NO.	FREQ. (MHz)	EMISSION LEVEL (dBuV/m)	LIMIT (dBuV/m)	MARGIN (dB)	ANTENNA HEIGHT (m)	TABLE ANGLE (Degree)	RAW VALUE (dBuV)	CORRECTION FACTOR (dB/m)
1	99.20	33.6 QP	43.5	-9.9	1.72 H	356	23.67	9.93
2	115.00	33.6 QP	43.5	-9.9	1.55 H	352	21.53	12.07
3	133.20	32.0 QP	43.5	-11.5	2.20 H	10	18.30	13.70
4	150.00	35.0 QP	43.5	-8.5	1.52 H	360	20.70	14.30
5	165.00	40.9 QP	43.5	-2.6	1.72 H	200	26.84	14.06
6	200.00	38.1 QP	43.5	-5.4	1.50 H	15	26.89	11.21
7	250.00	41.0 QP	46.0	-5.0	1.50 H	285	28.05	12.95
ANTENNA POLARITY & TEST DISTANCE: VERTICAL AT 3 M								
NO.	FREQ. (MHz)	EMISSION LEVEL (dBuV/m)	LIMIT (dBuV/m)	MARGIN (dB)	ANTENNA HEIGHT (m)	TABLE ANGLE (Degree)	RAW VALUE (dBuV)	CORRECTION FACTOR (dB/m)
1	33.55	36.9 QP	40.0	-3.1	1.00 V	300	23.43	13.47
2	100.05	27.6 QP	43.5	-15.9	1.00 V	320	17.63	9.97
3	150.62	35.6 QP	43.5	-7.9	1.20 V	350	21.30	14.30
4	168.30	32.6 QP	43.5	-10.9	2.00 V	306	18.67	13.93
5	250.30	30.6 QP	46.0	-15.4	1.06 V	243	17.64	12.96
6	370.00	30.0 QP	46.0	-16.0	1.60 V	360	12.97	17.03

- REMARKS:**
1. Emission level (dBuV/m) = Raw Value (dBuV) + Correction Factor (dB/m).
 2. Correction Factor (dB/m) = Antenna Factor (dB/m) + Cable Factor (dB).
 3. The other emission levels were very low against the limit.
 4. Margin value = Emission level – Limit value.



ABOVE 1GHz DATA

802.11a OFDM MODULATION

EUT TEST CONDITION		MEASUREMENT DETAIL	
CHANNEL	Channel 149	FREQUENCY RANGE	1 ~ 40GHz
INPUT POWER (SYSTEM)	120Vac, 60 Hz	DETECTOR FUNCTION	Peak (PK) Average (AV)
ENVIRONMENTAL CONDITIONS	26deg. C, 80%RH 1011 hPa	TESTED BY	Eric Lee

ANTENNA POLARITY & TEST DISTANCE: HORIZONTAL AT 3 M								
NO.	FREQ. (MHz)	EMISSION LEVEL (dBuV/m)	LIMIT (dBuV/m)	MARGIN (dB)	ANTENNA HEIGHT (m)	TABLE ANGLE (Degree)	RAW VALUE (dBuV)	CORRECTION FACTOR (dB/m)
1	*5745.00	110.4 PK			1.32 H	315	68.85	41.55
2	*5745.00	100.6 AV			1.32 H	315	59.05	41.55
3	11490.00	65.1 PK	74.0	-8.9	1.48 H	229	17.39	47.71
4	11490.00	49.6 AV	54.0	-4.4	1.48 H	229	1.89	47.71
ANTENNA POLARITY & TEST DISTANCE: VERTICAL AT 3 M								
NO.	FREQ. (MHz)	EMISSION LEVEL (dBuV/m)	LIMIT (dBuV/m)	MARGIN (dB)	ANTENNA HEIGHT (m)	TABLE ANGLE (Degree)	RAW VALUE (dBuV)	CORRECTION FACTOR (dB/m)
1	*5745.00	105.6 PK			1.33 V	306	64.05	41.55
2	*5745.00	94.9 AV			1.33 V	306	53.35	41.55
3	11490.00	66.0 PK	74.0	-8.0	1.15 V	290	18.29	47.71
4	11490.00	52.6 AV	54.0	-1.4	1.15 V	290	4.89	47.71

- REMARKS:**
1. Emission level (dBuV/m) = Raw Value (dBuV) + Correction Factor (dB/m).
 2. Correction Factor (dB/m) = Antenna Factor (dB/m) + Cable Factor (dB).
 3. The other emission levels were very low against the limit.
 4. Margin value = Emission level – Limit value.
 5. “ * “: Fundamental frequency.
 6. The limit value is defined as per 15.247.



A D T

EUT TEST CONDITION		MEASUREMENT DETAIL	
CHANNEL	Channel 157	FREQUENCY RANGE	1 ~ 40GHz
INPUT POWER (SYSTEM)	120Vac, 60 Hz	DETECTOR FUNCTION	Peak (PK) Average (AV)
ENVIRONMENTAL CONDITIONS	26deg. C, 80%RH 1011 hPa	TESTED BY	Eric Lee

ANTENNA POLARITY & TEST DISTANCE: HORIZONTAL AT 3 M								
NO.	FREQ. (MHz)	EMISSION LEVEL (dBuV/m)	LIMIT (dBuV/m)	MARGIN (dB)	ANTENNA HEIGHT (m)	TABLE ANGLE (Degree)	RAW VALUE (dBuV)	CORRECTION FACTOR (dB/m)
1	*5785.00	110.1 PK			1.29 H	322	68.42	41.68
2	*5785.00	100.1 AV			1.29 H	322	58.42	41.68
3	11570.00	65.2 PK	74.0	-8.8	1.50 H	230	17.45	47.75
4	11570.00	49.8 AV	54.0	-4.2	1.50 H	230	2.05	47.75
ANTENNA POLARITY & TEST DISTANCE: VERTICAL AT 3 M								
NO.	FREQ. (MHz)	EMISSION LEVEL (dBuV/m)	LIMIT (dBuV/m)	MARGIN (dB)	ANTENNA HEIGHT (m)	TABLE ANGLE (Degree)	RAW VALUE (dBuV)	CORRECTION FACTOR (dB/m)
1	*5785.00	105.9 PK			1.36 V	311	64.22	41.68
2	*5785.00	95.1 AV			1.36 V	311	53.42	41.68
3	11570.00	65.9 PK	74.0	-8.1	1.16 V	290	18.15	47.75
4	11570.00	52.8 AV	54.0	-1.2	1.16 V	290	5.05	47.75

- REMARKS:**
1. Emission level (dBuV/m) = Raw Value (dBuV) + Correction Factor (dB/m).
 2. Correction Factor (dB/m) = Antenna Factor (dB/m) + Cable Factor (dB).
 3. The other emission levels were very low against the limit.
 4. Margin value = Emission level – Limit value.
 5. “ * “: Fundamental frequency.
 6. The limit value is defined as per 15.247.



EUT TEST CONDITION		MEASUREMENT DETAIL	
CHANNEL	Channel 165	FREQUENCY RANGE	1 ~ 40GHz
INPUT POWER (SYSTEM)	120Vac, 60 Hz	DETECTOR FUNCTION	Peak (PK) Average (AV)
ENVIRONMENTAL CONDITIONS	26deg. C, 80%RH 1011 hPa	TESTED BY	Eric Lee

ANTENNA POLARITY & TEST DISTANCE: HORIZONTAL AT 3 M								
NO.	FREQ. (MHz)	EMISSION LEVEL (dBuV/m)	LIMIT (dBuV/m)	MARGIN (dB)	ANTENNA HEIGHT (m)	TABLE ANGLE (Degree)	RAW VALUE (dBuV)	CORRECTION FACTOR (dB/m)
1	*5825.00	111.4 PK			1.31 H	323	69.62	41.78
2	*5825.00	101.4 AV			1.31 H	323	59.62	41.78
3	11650.00	65.8 PK	74.0	-8.2	1.49 H	223	17.97	47.83
4	11650.00	50.0 AV	54.0	-4.0	1.49 H	223	2.17	47.83
ANTENNA POLARITY & TEST DISTANCE: VERTICAL AT 3 M								
NO.	FREQ. (MHz)	EMISSION LEVEL (dBuV/m)	LIMIT (dBuV/m)	MARGIN (dB)	ANTENNA HEIGHT (m)	TABLE ANGLE (Degree)	RAW VALUE (dBuV)	CORRECTION FACTOR (dB/m)
1	*5825.00	106.1 PK			1.41 V	322	64.33	41.78
2	*5825.00	95.4 AV			1.41 V	322	53.62	41.78
3	11650.00	67.9 PK	74.0	-6.1	1.27 V	246	20.07	47.83
4	11650.00	52.1 AV	54.0	-1.9	1.27 V	246	4.27	47.83

- REMARKS:**
1. Emission level (dBuV/m) = Raw Value (dBuV) + Correction Factor (dB/m).
 2. Correction Factor (dB/m) = Antenna Factor (dB/m) + Cable Factor (dB).
 3. The other emission levels were very low against the limit.
 4. Margin value = Emission level – Limit value.
 5. “ * “: Fundamental frequency.
 6. The limit value is defined as per 15.247.

802.11n (20MHz) OFDM MODULATION

EUT TEST CONDITION		MEASUREMENT DETAIL	
CHANNEL	Channel 149	FREQUENCY RANGE	1 ~ 40GHz
INPUT POWER (SYSTEM)	120Vac, 60 Hz	DETECTOR FUNCTION	Peak (PK) Average (AV)
ENVIRONMENTAL CONDITIONS	26deg. C, 80%RH 1011 hPa	TESTED BY	Eric Lee

ANTENNA POLARITY & TEST DISTANCE: HORIZONTAL AT 3 M								
NO.	FREQ. (MHz)	EMISSION LEVEL (dBuV/m)	LIMIT (dBuV/m)	MARGIN (dB)	ANTENNA HEIGHT (m)	TABLE ANGLE (Degree)	RAW VALUE (dBuV)	CORRECTION FACTOR (dB/m)
1	*5745.00	112.4 PK			1.29 H	323	70.85	41.55
2	*5745.00	102.1 AV			1.29 H	323	60.55	41.55
3	11490.00	66.9 PK	74.0	-7.1	1.51 H	222	19.19	47.71
4	11490.00	48.9 AV	54.0	-5.1	1.51 H	222	1.19	47.71
ANTENNA POLARITY & TEST DISTANCE: VERTICAL AT 3 M								
NO.	FREQ. (MHz)	EMISSION LEVEL (dBuV/m)	LIMIT (dBuV/m)	MARGIN (dB)	ANTENNA HEIGHT (m)	TABLE ANGLE (Degree)	RAW VALUE (dBuV)	CORRECTION FACTOR (dB/m)
1	*5745.00	106.9 PK			1.20 V	329	65.35	41.55
2	*5745.00	96.6 AV			1.20 V	329	55.05	41.55
3	11490.00	68.2 PK	74.0	-5.8	1.16 V	291	20.49	47.71
4	11490.00	51.6 AV	54.0	-2.4	1.16 V	291	3.89	47.71

- REMARKS:**
1. Emission level (dBuV/m) = Raw Value (dBuV) + Correction Factor (dB/m).
 2. Correction Factor (dB/m) = Antenna Factor (dB/m) + Cable Factor (dB).
 3. The other emission levels were very low against the limit.
 4. Margin value = Emission level – Limit value.
 5. “ * “: Fundamental frequency.
 6. The limit value is defined as per 15.247.



A D T

EUT TEST CONDITION		MEASUREMENT DETAIL	
CHANNEL	Channel 157	FREQUENCY RANGE	1 ~ 40GHz
INPUT POWER (SYSTEM)	120Vac, 60 Hz	DETECTOR FUNCTION	Peak (PK) Average (AV)
ENVIRONMENTAL CONDITIONS	26deg. C, 80%RH 1011 hPa	TESTED BY	Eric Lee

ANTENNA POLARITY & TEST DISTANCE: HORIZONTAL AT 3 M								
NO.	FREQ. (MHz)	EMISSION LEVEL (dBuV/m)	LIMIT (dBuV/m)	MARGIN (dB)	ANTENNA HEIGHT (m)	TABLE ANGLE (Degree)	RAW VALUE (dBuV)	CORRECTION FACTOR (dB/m)
1	*5785.00	111.8 PK			1.30 H	343	70.12	41.68
2	*5785.00	101.9 AV			1.30 H	343	60.22	41.68
3	11570.00	67.2 PK	74.0	-6.8	1.47 H	234	19.45	47.75
4	11570.00	49.8 AV	54.0	-4.2	1.47 H	234	2.05	47.75
ANTENNA POLARITY & TEST DISTANCE: VERTICAL AT 3 M								
NO.	FREQ. (MHz)	EMISSION LEVEL (dBuV/m)	LIMIT (dBuV/m)	MARGIN (dB)	ANTENNA HEIGHT (m)	TABLE ANGLE (Degree)	RAW VALUE (dBuV)	CORRECTION FACTOR (dB/m)
1	*5785.00	106.5 PK			1.40 V	340	64.82	41.68
2	*5785.00	97.1 AV			1.40 V	340	55.42	41.68
3	11570.00	68.9 PK	74.0	-5.1	1.14 V	299	21.15	47.75
4	11570.00	51.8 AV	54.0	-2.2	1.14 V	299	4.05	47.75

- REMARKS:**
1. Emission level (dBuV/m) = Raw Value (dBuV) + Correction Factor (dB/m).
 2. Correction Factor (dB/m) = Antenna Factor (dB/m) + Cable Factor (dB).
 3. The other emission levels were very low against the limit.
 4. Margin value = Emission level – Limit value.
 5. “ * “: Fundamental frequency.
 6. The limit value is defined as per 15.247.



EUT TEST CONDITION		MEASUREMENT DETAIL	
CHANNEL	Channel 165	FREQUENCY RANGE	1 ~ 40GHz
INPUT POWER (SYSTEM)	120Vac, 60 Hz	DETECTOR FUNCTION	Peak (PK) Average (AV)
ENVIRONMENTAL CONDITIONS	26deg. C, 80%RH 1011 hPa	TESTED BY	Eric Lee

ANTENNA POLARITY & TEST DISTANCE: HORIZONTAL AT 3 M								
NO.	FREQ. (MHz)	EMISSION LEVEL (dBuV/m)	LIMIT (dBuV/m)	MARGIN (dB)	ANTENNA HEIGHT (m)	TABLE ANGLE (Degree)	RAW VALUE (dBuV)	CORRECTION FACTOR (dB/m)
1	*5825.00	112.8 PK			1.29 H	359	71.02	41.78
2	*5825.00	101.8 AV			1.29 H	359	60.02	41.78
3	11650.00	66.5 PK	74.0	-7.5	1.48 H	230	18.67	47.83
4	11650.00	49.9 AV	54.0	-4.1	1.48 H	230	2.07	47.83
ANTENNA POLARITY & TEST DISTANCE: VERTICAL AT 3 M								
NO.	FREQ. (MHz)	EMISSION LEVEL (dBuV/m)	LIMIT (dBuV/m)	MARGIN (dB)	ANTENNA HEIGHT (m)	TABLE ANGLE (Degree)	RAW VALUE (dBuV)	CORRECTION FACTOR (dB/m)
1	*5825.00	107.3 PK			1.39 V	359	65.52	41.78
2	*5825.00	97.2 AV			1.39 V	359	55.42	41.78
3	11650.00	68.2 PK	74.0	-5.8	1.23 V	301	20.37	47.83
4	11650.00	51.9 AV	54.0	-2.1	1.23 V	301	4.07	47.83

- REMARKS:**
1. Emission level (dBuV/m) = Raw Value (dBuV) + Correction Factor (dB/m).
 2. Correction Factor (dB/m) = Antenna Factor (dB/m) + Cable Factor (dB).
 3. The other emission levels were very low against the limit.
 4. Margin value = Emission level – Limit value.
 5. “ * “: Fundamental frequency.
 6. The limit value is defined as per 15.247.

802.11n (40MHz) OFDM MODULATION

EUT TEST CONDITION		MEASUREMENT DETAIL	
CHANNEL	Channel 151	FREQUENCY RANGE	1 ~ 40GHz
INPUT POWER (SYSTEM)	120Vac, 60 Hz	DETECTOR FUNCTION	Peak (PK) Average (AV)
ENVIRONMENTAL CONDITIONS	26deg. C, 80%RH 1011 hPa	TESTED BY	Eric Lee

ANTENNA POLARITY & TEST DISTANCE: HORIZONTAL AT 3 M								
NO.	FREQ. (MHz)	EMISSION LEVEL (dBuV/m)	LIMIT (dBuV/m)	MARGIN (dB)	ANTENNA HEIGHT (m)	TABLE ANGLE (Degree)	RAW VALUE (dBuV)	CORRECTION FACTOR (dB/m)
1	*5755.00	108.5 PK			1.29 H	319	66.91	41.59
2	*5755.00	97.4 AV			1.29 H	319	55.81	41.59
3	11510.00	64.9 PK	74.0	-9.1	1.44 H	244	17.18	47.72
4	11510.00	48.2 AV	54.0	-5.8	1.44 H	244	0.48	47.72
ANTENNA POLARITY & TEST DISTANCE: VERTICAL AT 3 M								
NO.	FREQ. (MHz)	EMISSION LEVEL (dBuV/m)	LIMIT (dBuV/m)	MARGIN (dB)	ANTENNA HEIGHT (m)	TABLE ANGLE (Degree)	RAW VALUE (dBuV)	CORRECTION FACTOR (dB/m)
1	*5755.00	103.5 PK			1.34 V	308	61.91	41.59
2	*5755.00	96.6 AV			1.34 V	308	55.01	41.59
3	11510.00	66.1 PK	74.0	-7.9	1.25 V	300	18.38	47.72
4	11510.00	49.4 AV	54.0	-4.6	1.25 V	300	1.68	47.72

- REMARKS:**
1. Emission level (dBuV/m) = Raw Value (dBuV) + Correction Factor (dB/m).
 2. Correction Factor (dB/m) = Antenna Factor (dB/m) + Cable Factor (dB).
 3. The other emission levels were very low against the limit.
 4. Margin value = Emission level – Limit value.
 5. “ * “: Fundamental frequency.
 6. The limit value is defined as per 15.247.



A D T

EUT TEST CONDITION		MEASUREMENT DETAIL	
CHANNEL	Channel 159	FREQUENCY RANGE	1 ~ 40GHz
INPUT POWER (SYSTEM)	120Vac, 60 Hz	DETECTOR FUNCTION	Peak (PK) Average (AV)
ENVIRONMENTAL CONDITIONS	26deg. C, 80%RH 1011 hPa	TESTED BY	Eric Lee

ANTENNA POLARITY & TEST DISTANCE: HORIZONTAL AT 3 M								
NO.	FREQ. (MHz)	EMISSION LEVEL (dBuV/m)	LIMIT (dBuV/m)	MARGIN (dB)	ANTENNA HEIGHT (m)	TABLE ANGLE (Degree)	RAW VALUE (dBuV)	CORRECTION FACTOR (dB/m)
1	*5795.00	109.2 PK			1.32 H	322	67.50	41.70
2	*5795.00	98.0 AV			1.32 H	322	56.30	41.70
3	11590.00	64.7 PK	74.0	-9.3	1.47 H	250	16.94	47.76
4	11590.00	47.9 AV	54.0	-6.1	1.47 H	250	0.14	47.76
ANTENNA POLARITY & TEST DISTANCE: VERTICAL AT 3 M								
NO.	FREQ. (MHz)	EMISSION LEVEL (dBuV/m)	LIMIT (dBuV/m)	MARGIN (dB)	ANTENNA HEIGHT (m)	TABLE ANGLE (Degree)	RAW VALUE (dBuV)	CORRECTION FACTOR (dB/m)
1	*5795.00	104.1 PK			1.29 V	311	62.40	41.70
2	*5795.00	93.0 AV			1.29 V	311	51.30	41.70
3	11590.00	66.5 PK	74.0	-7.5	1.14 V	268	18.74	47.76
4	11590.00	49.3 AV	54.0	-4.7	1.14 V	268	1.54	47.76

- REMARKS:**
1. Emission level (dBuV/m) = Raw Value (dBuV) + Correction Factor (dB/m).
 2. Correction Factor (dB/m) = Antenna Factor (dB/m) + Cable Factor (dB).
 3. The other emission levels were very low against the limit.
 4. Margin value = Emission level – Limit value.
 5. “ * “: Fundamental frequency.
 6. The limit value is defined as per 15.247.

5.2.8 TEST RESULTS (FOR RECEIVER PART)

BELOW 1GHz DATA

EUT TEST CONDITION		MEASUREMENT DETAIL	
CHANNEL	Channel 159	FREQUENCY RANGE	Below 1000MHz
INPUT POWER (SYSTEM)	120Vac, 60 Hz	DETECTOR FUNCTION	Quasi-Peak
ENVIRONMENTAL CONDITIONS	24deg. C, 70%RH 1011 hPa	TESTED BY	Eric Lee

ANTENNA POLARITY & TEST DISTANCE: HORIZONTAL AT 3 M								
NO.	FREQ. (MHz)	EMISSION LEVEL (dBuV/m)	LIMIT (dBuV/m)	MARGIN (dB)	ANTENNA HEIGHT (m)	TABLE ANGLE (Degree)	RAW VALUE (dBuV)	CORRECTION FACTOR (dB/m)
1	99.20	33.6 QP	43.5	-9.9	1.72 H	356	23.67	9.93
2	115.00	33.6 QP	43.5	-9.9	1.55 H	352	21.53	12.07
3	133.20	32.0 QP	43.5	-11.5	2.20 H	10	18.30	13.70
4	150.00	35.0 QP	43.5	-8.5	1.52 H	360	20.70	14.30
5	165.00	40.9 QP	43.5	-2.6	1.72 H	200	26.84	14.06
6	200.00	38.1 QP	43.5	-5.4	1.50 H	15	26.89	11.21
7	250.00	41.0 QP	46.0	-5.0	1.50 H	285	28.05	12.95
ANTENNA POLARITY & TEST DISTANCE: VERTICAL AT 3 M								
NO.	FREQ. (MHz)	EMISSION LEVEL (dBuV/m)	LIMIT (dBuV/m)	MARGIN (dB)	ANTENNA HEIGHT (m)	TABLE ANGLE (Degree)	RAW VALUE (dBuV)	CORRECTION FACTOR (dB/m)
1	33.55	36.9 QP	40.0	-3.1	1.00 V	300	23.43	13.47
2	100.05	27.6 QP	43.5	-15.9	1.00 V	320	17.63	9.97
3	150.62	35.6 QP	43.5	-7.9	1.20 V	350	21.30	14.30
4	168.30	32.6 QP	43.5	-10.9	2.00 V	306	18.67	13.93
5	250.30	30.6 QP	46.0	-15.4	1.06 V	243	17.64	12.96
6	370.00	30.0 QP	46.0	-16.0	1.60 V	360	12.97	17.03

- REMARKS:**
1. Emission level (dBuV/m) = Raw Value (dBuV) + Correction Factor (dB/m).
 2. Correction Factor (dB/m) = Antenna Factor (dB/m) + Cable Factor (dB).
 3. The other emission levels were very low against the limit.
 4. Margin value = Emission level – Limit value.



A D T

ABOVE 1GHz DATA

802.11a OFDM MODULATION

EUT TEST CONDITION		MEASUREMENT DETAIL	
CHANNEL	Channel 149	FREQUENCY RANGE	1 ~ 17.55GHz
INPUT POWER (SYSTEM)	120Vac, 60 Hz	DETECTOR FUNCTION	Peak (PK) Average (AV)
ENVIRONMENTAL CONDITIONS	25deg. C, 70%RH 1011 hPa	TESTED BY	Eric Lee

ANTENNA POLARITY & TEST DISTANCE: HORIZONTAL AT 3 M								
NO.	FREQ. (MHz)	EMISSION LEVEL (dBuV/m)	LIMIT (dBuV/m)	MARGIN (dB)	ANTENNA HEIGHT (m)	TABLE ANGLE (Degree)	RAW VALUE (dBuV)	CORRECTION FACTOR (dB/m)
1	3830.00	47.1 PK	74.0	-26.9	1.65 H	95	11.65	35.45
2	3830.00	40.6 AV	54.0	-13.4	1.65 H	95	5.15	35.45
3	7660.00	56.2 PK	74.0	-17.8	1.10 H	142	11.64	44.56
4	7660.00	45.6 AV	54.0	-8.4	1.10 H	142	1.04	44.56
ANTENNA POLARITY & TEST DISTANCE: VERTICAL AT 3 M								
NO.	FREQ. (MHz)	EMISSION LEVEL (dBuV/m)	LIMIT (dBuV/m)	MARGIN (dB)	ANTENNA HEIGHT (m)	TABLE ANGLE (Degree)	RAW VALUE (dBuV)	CORRECTION FACTOR (dB/m)
1	3830.00	48.3 PK	74.0	-25.7	1.24 V	51	12.85	35.45
2	3830.00	41.6 AV	54.0	-12.4	1.24 V	51	6.15	35.45
3	7660.00	56.4 PK	74.0	-17.6	1.54 V	88	11.84	44.56
4	7660.00	45.6 AV	54.0	-8.4	1.54 V	88	1.04	44.56

- REMARKS:**
1. Emission level (dBuV/m) = Raw Value (dBuV) + Correction Factor (dB/m).
 2. Correction Factor (dB/m) = Antenna Factor (dB/m) + Cable Factor (dB).
 3. The other emission levels were very low against the limit.
 4. Margin value = Emission level – Limit value.



A D T

EUT TEST CONDITION		MEASUREMENT DETAIL	
CHANNEL	Channel 157	FREQUENCY RANGE	1 ~ 17.55GHz
INPUT POWER (SYSTEM)	120Vac, 60 Hz	DETECTOR FUNCTION	Peak (PK) Average (AV)
ENVIRONMENTAL CONDITIONS	25deg. C, 70%RH 1011 hPa	TESTED BY	Eric Lee

ANTENNA POLARITY & TEST DISTANCE: HORIZONTAL AT 3 M								
NO.	FREQ. (MHz)	EMISSION LEVEL (dBuV/m)	LIMIT (dBuV/m)	MARGIN (dB)	ANTENNA HEIGHT (m)	TABLE ANGLE (Degree)	RAW VALUE (dBuV)	CORRECTION FACTOR (dB/m)
1	3856.66	47.2 PK	74.0	-26.8	1.52 H	215	11.65	35.55
2	3856.66	40.6 AV	54.0	-13.4	1.52 H	215	5.05	35.55
3	7713.33	56.2 PK	74.0	-17.8	1.00 H	213	11.57	44.63
4	7713.33	45.7 AV	54.0	-8.3	1.00 H	213	1.07	44.63
ANTENNA POLARITY & TEST DISTANCE: VERTICAL AT 3 M								
NO.	FREQ. (MHz)	EMISSION LEVEL (dBuV/m)	LIMIT (dBuV/m)	MARGIN (dB)	ANTENNA HEIGHT (m)	TABLE ANGLE (Degree)	RAW VALUE (dBuV)	CORRECTION FACTOR (dB/m)
1	3856.66	48.2 PK	74.0	-25.8	1.02 V	178	12.65	35.55
2	3856.66	42.1 AV	54.0	-11.9	1.02 V	178	6.55	35.55
3	7713.33	56.3 PK	74.0	-17.7	1.00 V	102	11.67	44.63
4	7713.33	45.1 AV	54.0	-8.9	1.00 V	102	0.47	44.63

- REMARKS:**
1. Emission level (dBuV/m) = Raw Value (dBuV) + Correction Factor (dB/m).
 2. Correction Factor (dB/m) = Antenna Factor (dB/m) + Cable Factor (dB).
 3. The other emission levels were very low against the limit.
 4. Margin value = Emission level – Limit value.



A D T

EUT TEST CONDITION		MEASUREMENT DETAIL	
CHANNEL	Channel 165	FREQUENCY RANGE	1 ~ 17.55GHz
INPUT POWER (SYSTEM)	120Vac, 60 Hz	DETECTOR FUNCTION	Peak (PK) Average (AV)
ENVIRONMENTAL CONDITIONS	25deg. C, 70%RH 1011 hPa	TESTED BY	Eric Lee

ANTENNA POLARITY & TEST DISTANCE: HORIZONTAL AT 3 M								
NO.	FREQ. (MHz)	EMISSION LEVEL (dBuV/m)	LIMIT (dBuV/m)	MARGIN (dB)	ANTENNA HEIGHT (m)	TABLE ANGLE (Degree)	RAW VALUE (dBuV)	CORRECTION FACTOR (dB/m)
1	3883.33	47.2 PK	74.0	-26.8	1.24 H	51	11.55	35.65
2	3883.33	40.8 AV	54.0	-13.2	1.24 H	51	5.15	35.65
3	7766.66	46.1 PK	74.0	-27.9	1.84 H	250	1.38	44.72
4	7766.66	45.6 AV	54.0	-8.4	1.84 H	250	0.88	44.72
ANTENNA POLARITY & TEST DISTANCE: VERTICAL AT 3 M								
NO.	FREQ. (MHz)	EMISSION LEVEL (dBuV/m)	LIMIT (dBuV/m)	MARGIN (dB)	ANTENNA HEIGHT (m)	TABLE ANGLE (Degree)	RAW VALUE (dBuV)	CORRECTION FACTOR (dB/m)
1	3883.33	48.2 PK	74.0	-25.8	1.00 V	3	12.55	35.65
2	3883.33	41.7 AV	54.0	-12.3	1.00 V	3	6.05	35.65
3	7766.66	56.3 PK	74.0	-17.7	1.50 V	254	11.58	44.72
4	7766.66	45.3 AV	54.0	-8.7	1.50 V	254	0.58	44.72

- REMARKS:**
1. Emission level (dBuV/m) = Raw Value (dBuV) + Correction Factor (dB/m).
 2. Correction Factor (dB/m) = Antenna Factor (dB/m) + Cable Factor (dB).
 3. The other emission levels were very low against the limit.
 4. Margin value = Emission level – Limit value.

5.3 6dB BANDWIDTH MEASUREMENT

5.3.1 LIMITS OF 6dB BANDWIDTH MEASUREMENT

The minimum of 6dB Bandwidth Measurement is 0.5 MHz.

5.3.2 TEST INSTRUMENTS

DESCRIPTION & MANUFACTURER	MODEL NO.	SERIAL NO.	CALIBRATED DATE	CALIBRATED UNTIL
Spectrum Analyzer	E4446A	MY48250254	July 14, 2010	July 13, 2011

NOTE: The calibration interval of the above test instruments is 12 months and the calibrations are traceable to NML/ROC and NIST/USA.

5.3.3 TEST PROCEDURE

The transmitter output was connected to the spectrum analyzer through an attenuator. The bandwidth of the fundamental frequency was measured by spectrum analyzer with 100kHz RBW and 100kHz VBW. The 6dB bandwidth is defined as the total spectrum the power of which is higher than peak power minus 6dB.

5.3.4 DEVIATION FROM TEST STANDARD

No deviation

5.3.5 TEST SETUP



5.3.6 EUT OPERATING CONDITIONS

The software provided by client to enable the EUT under transmission condition continuously at lowest, middle and highest channel frequencies individually.



A D T

5.3.7 TEST RESULTS

802.11a OFDM MODULATION:

CHANNEL	CHANNEL FREQUENCY (MHz)	6dB BANDWIDTH (MHz)	MINIMUM LIMIT (MHz)	PASS / FAIL
149	5745	15.86	0.5	PASS
157	5785	16.05	0.5	PASS
165	5825	15.81	0.5	PASS

CH149

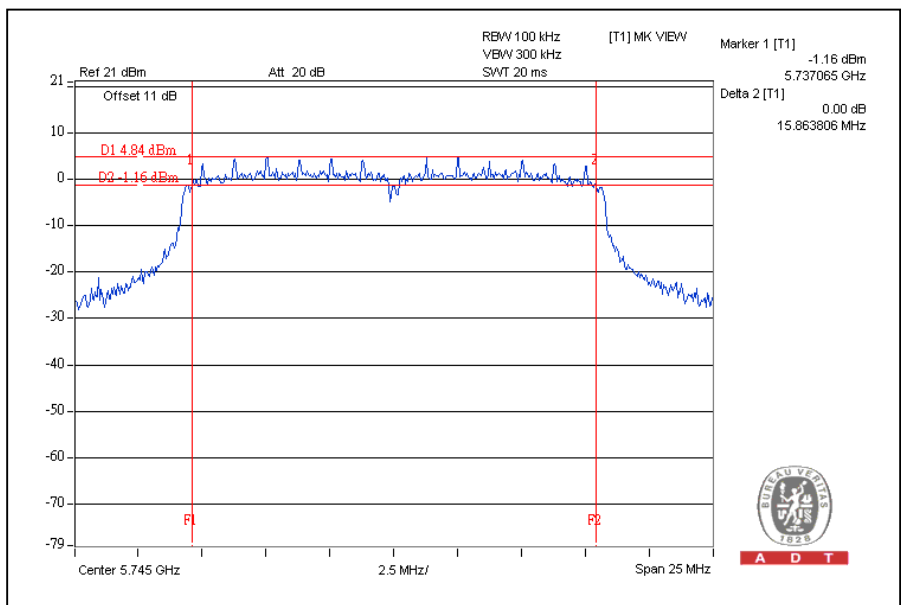



A D T

CH157

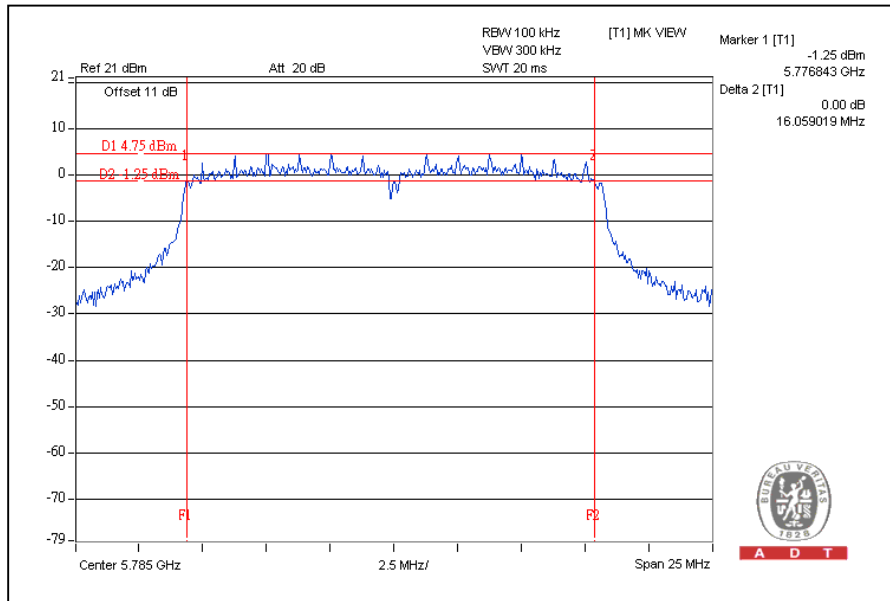

CH165

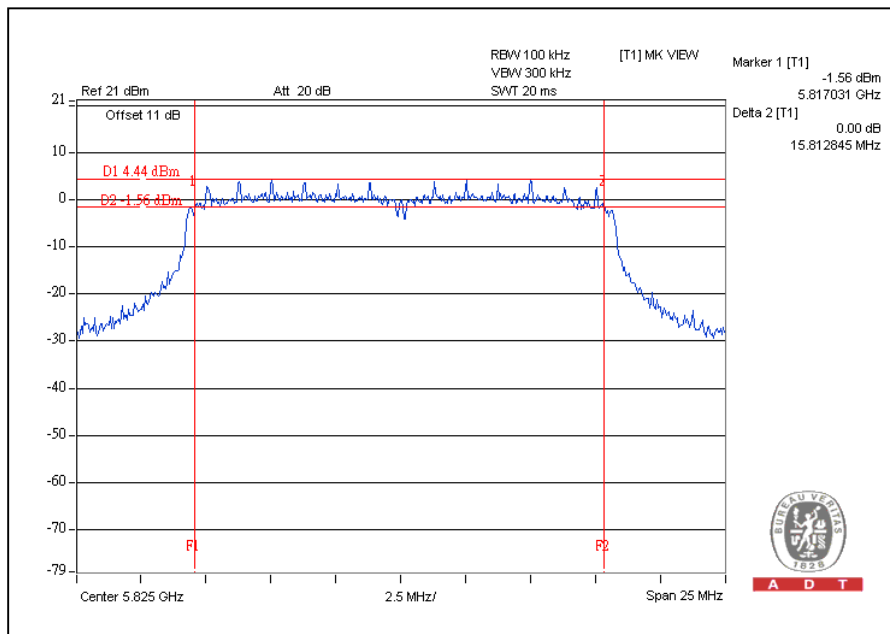



A D T

802.11n (20MHz) OFDM MODULATION:

CHANNEL	CHANNEL FREQUENCY (MHz)	6dB BANDWIDTH (MHz)	MINIMUM LIMIT (MHz)	PASS / FAIL
149	5745	15.80	0.5	PASS
157	5785	15.98	0.5	PASS
165	5825	16.07	0.5	PASS

CH149

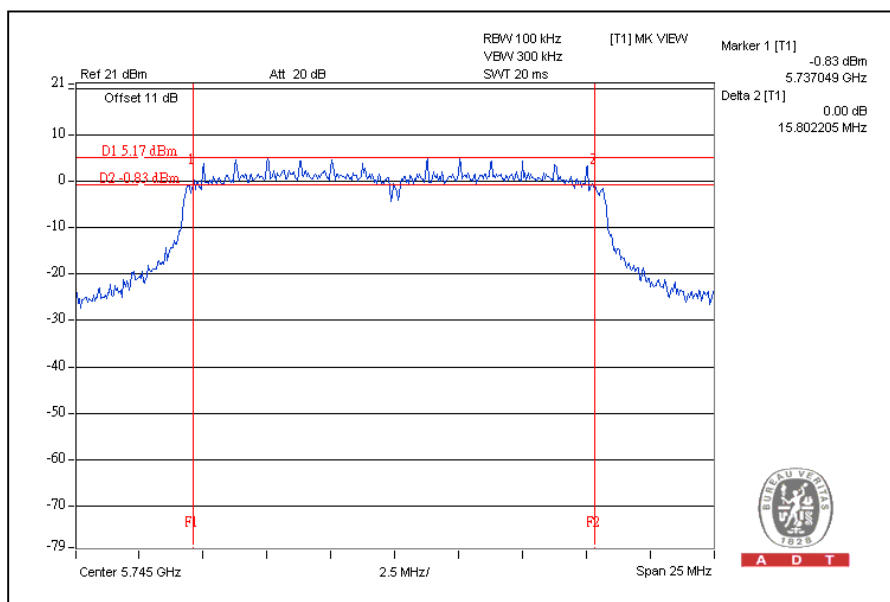



A D T

CH157

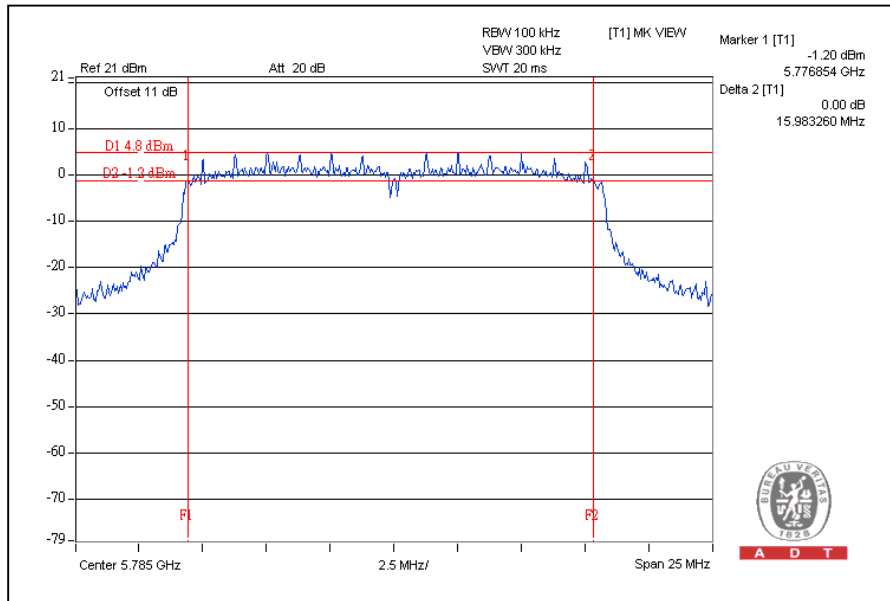

CH165

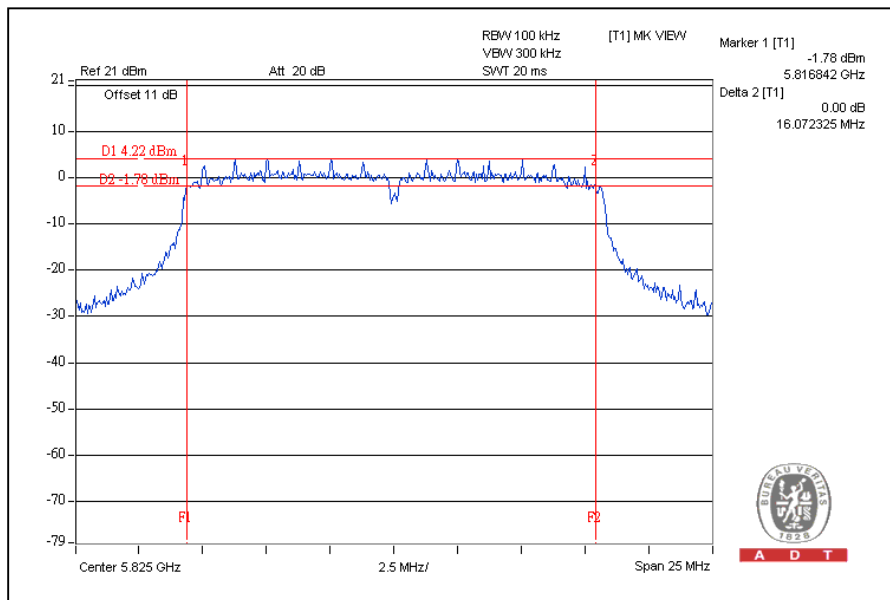



A D T

802.11n (40MHz) OFDM MODULATION:

CHANNEL	CHANNEL FREQUENCY (MHz)	6dB BANDWIDTH (MHz)	MINIMUM LIMIT (MHz)	PASS / FAIL
151	5755	35.08	0.5	PASS
159	5795	35.23	0.5	PASS

CH151

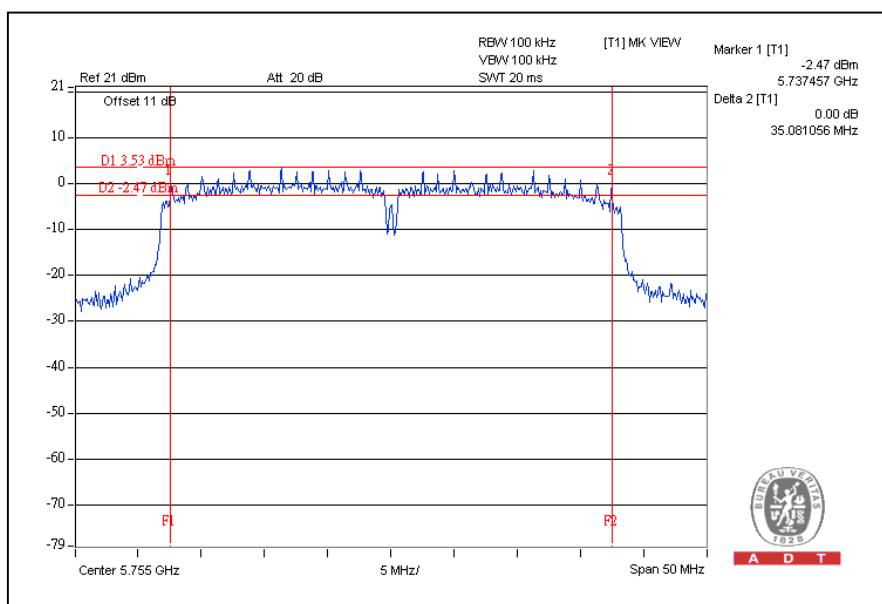



A D T

CH159

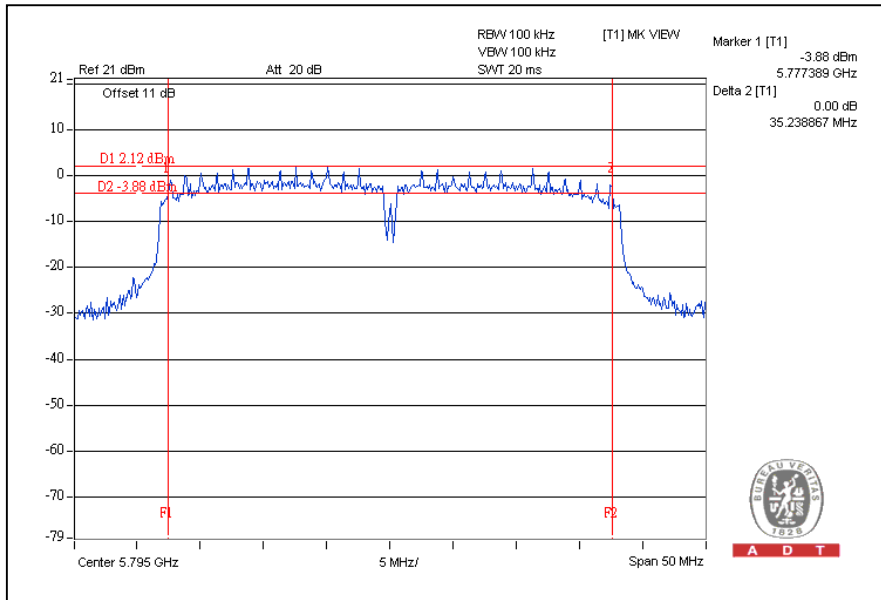

5.4 99% BANDWIDTH MEASUREMENT

5.4.1 TEST INSTRUMENTS

DESCRIPTION & MANUFACTURER	MODEL NO.	SERIAL NO.	CALIBRATED DATE	CALIBRATED UNTIL
Spectrum Analyzer	E4446A	MY48250254	July 14, 2010	July 13, 2011

NOTE: The calibration interval of the above test instruments is 12 months and the calibrations are traceable to NML/ROC and NIST/USA.

5.4.2 TEST PROCEDURE

The transmitter output was connected to the spectrum analyzer through an attenuator. The bandwidth of the fundamental frequency was measured by spectrum analyzer with 100kHz RBW and 100kHz VBW.

5.4.3 TEST SETUP

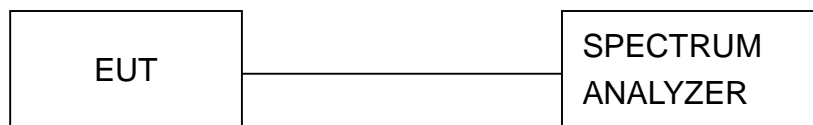

5.4.4 EUT OPERATING CONDITIONS

The software provided by client to enable the EUT under transmission condition continuously at lowest, middle and highest channel frequencies individually.



A D T

5.4.5 TEST RESULTS

802.11a OFDM MODULATION:

CHANNEL	CHANNEL FREQUENCY (MHz)	99% BANDWIDTH (MHz)
149	5745	16.5
157	5785	16.5
165	5825	16.45

CH149

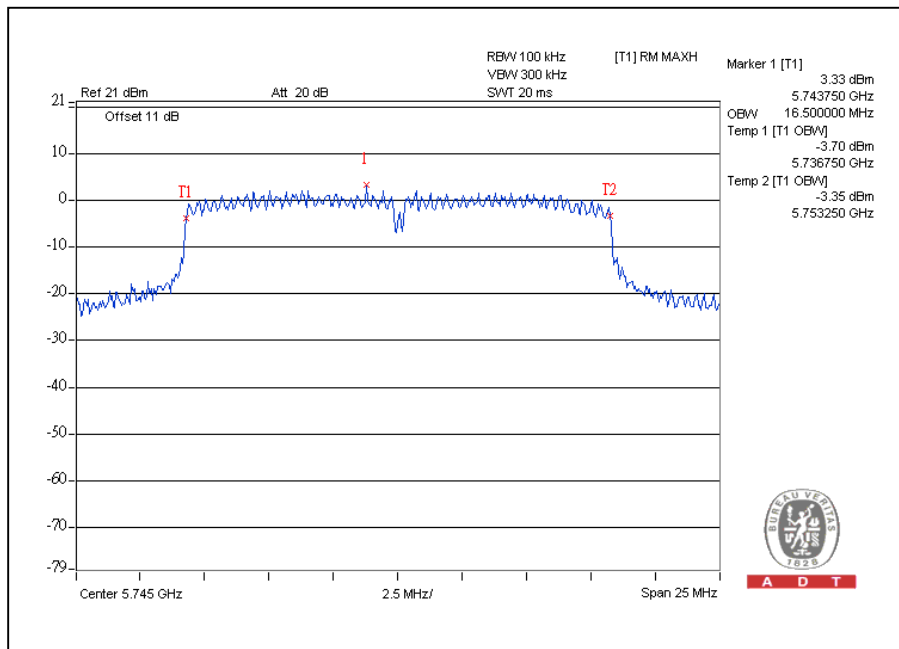



A D T

CH157

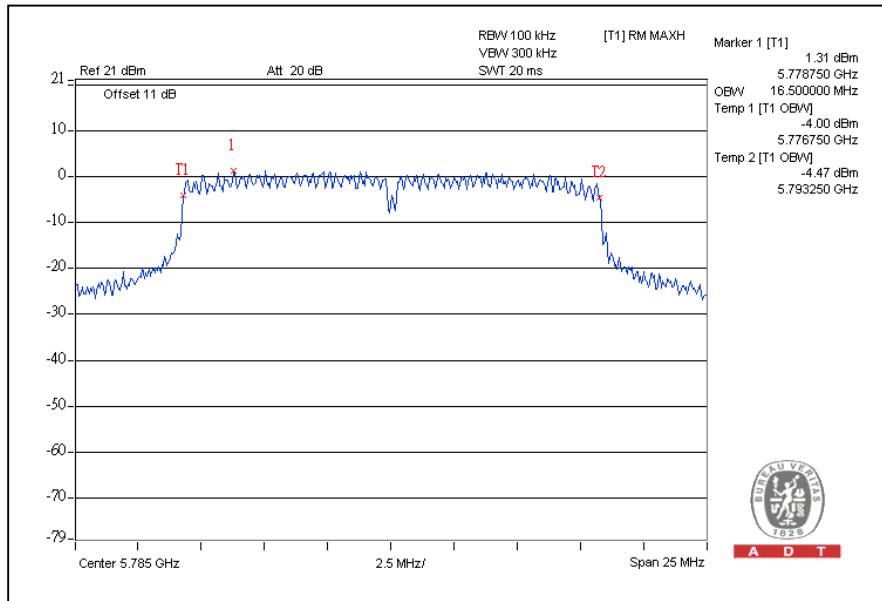

CH165

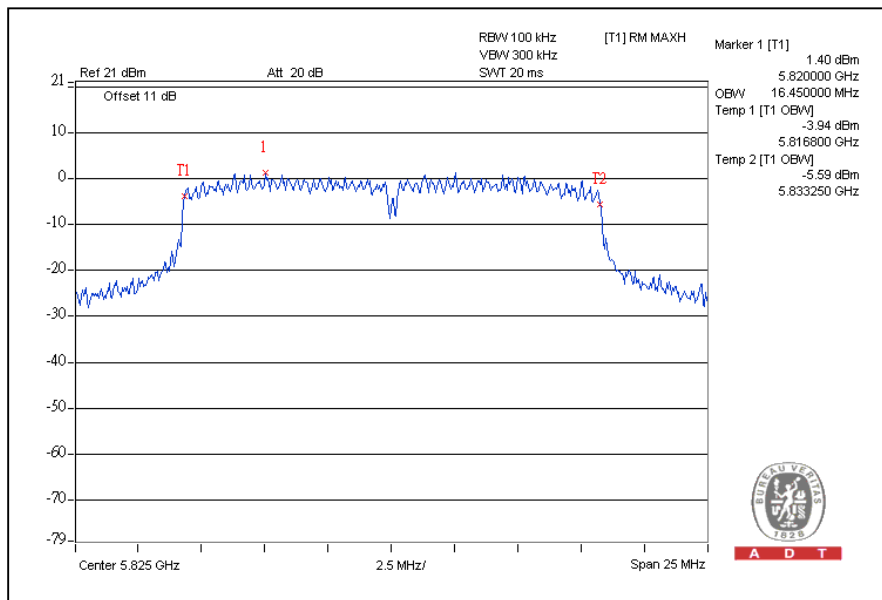

802.11n (20MHz) OFDM MODULATION:

CHANNEL	CHANNEL FREQUENCY (MHz)	99% BANDWIDTH (MHz)
149	5745	17.56
157	5785	17.56
165	5825	17.56

CH149

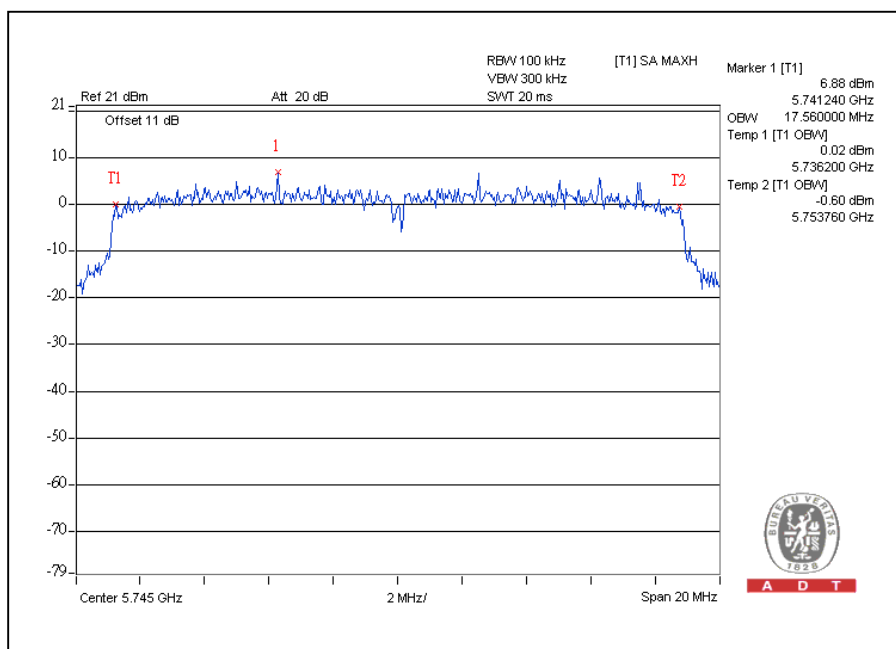



A D T

CH157

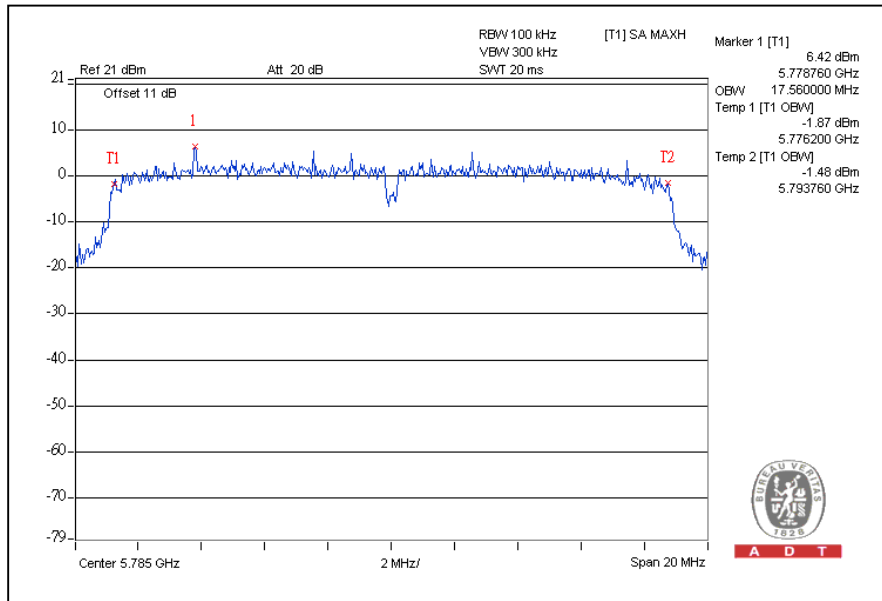

CH165

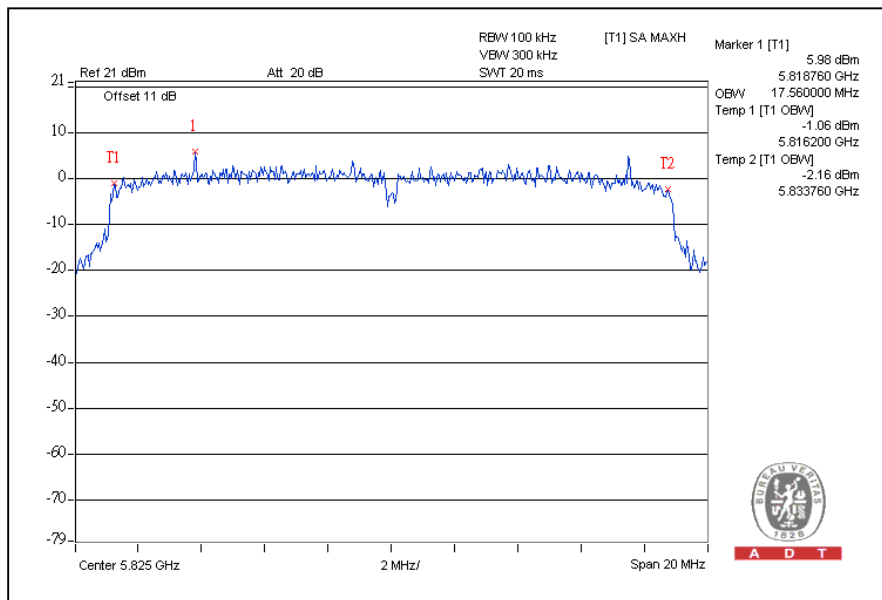

802.11n (40MHz) OFDM MODULATION:

CHANNEL	CHANNEL FREQUENCY (MHz)	99% BANDWIDTH (MHz)
151	5755	35.84
159	5795	36

CH151

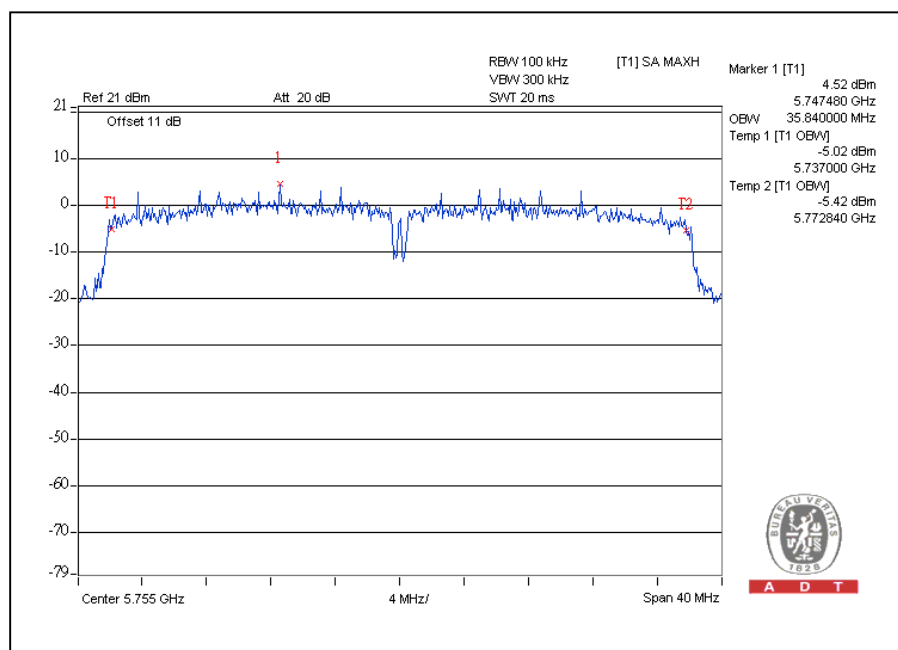



A D T

CH159

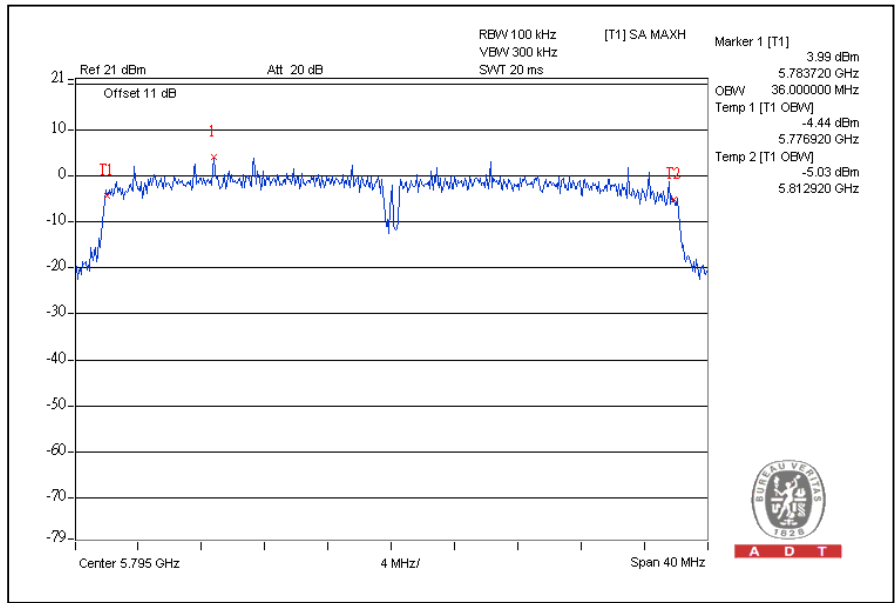

5.5 MAXIMUM PEAK OUTPUT POWER

5.5.1 LIMITS OF MAXIMUM PEAK OUTPUT POWER MEASUREMENT

The Maximum Peak Output Power Measurement is 30dBm.

5.5.2 INSTRUMENTS

DESCRIPTION & MANUFACTURER	MODEL NO.	SERIAL NO.	CALIBRATED DATE	CALIBRATED UNTIL
Peak Power Meter	ML2495A	0824006	May 04, 2010	May 03, 2011
Power Sensor	MA2411B	0738172	May 04, 2010	May 03, 2011

NOTE: The calibration interval of the above test instruments is 12 months and the calibrations are traceable to NML/ROC and NIST/USA.

5.5.3 TEST PROCEDURES

1. The transmitter output was connected to the power meter through an attenuator; the bandwidth of the fundamental frequency was measured with the power meter.
2. Record the power level.

5.5.4 DEVIATION FROM TEST STANDARD

No deviation

5.5.5 TEST SETUP

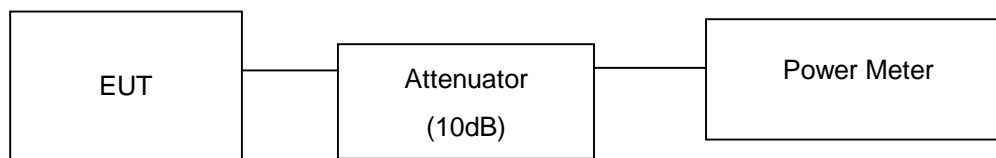

5.5.6 EUT OPERATING CONDITIONS

Same as Item 4.3.6



A D T

5.5.7 TEST RESULTS

802.11a OFDM MODULATION:

CHANNEL	CHANNEL FREQUENCY (MHz)	PEAK POWER OUTPUT (dBm)	PEAK POWER (mW)	PEAK POWER LIMIT (dBm)	PASS / FAIL
149	5745	23.4	218.8	30	PASS
157	5785	23.4	218.8	30	PASS
165	5825	23.3	213.8	30	PASS

802.11n (20MHz) OFDM MODULATION:

CHANNEL	CHANNEL FREQUENCY (MHz)	PEAK POWER OUTPUT (dBm)	PEAK POWER (mW)	PEAK POWER LIMIT (dBm)	PASS / FAIL
149	5745	23.8	239.9	30	PASS
157	5785	23.7	234.4	30	PASS
165	5825	23.5	223.9	30	PASS

802.11n (40MHz) OFDM MODULATION:

CHANNEL	CHANNEL FREQUENCY (MHz)	PEAK POWER OUTPUT (dBm)	PEAK POWER (mW)	PEAK POWER LIMIT (dBm)	PASS / FAIL
151	5755	24.1	257.0	30	PASS
159	5795	24.1	257.0	30	PASS



5.6 AVERAGE OUTPUT POWER

5.6.1 For reference.

5.6.2 TEST INSTRUMENTS

DESCRIPTION & MANUFACTURER	MODEL NO.	SERIAL NO.	CALIBRATED DATE	CALIBRATED UNTIL
Peak Power Meter	ML2495A	0824006	May 04, 2010	May 03, 2011
Power Sensor	MA2411B	0738172	May 04, 2010	May 03, 2011

NOTE: The calibration interval of the above test instruments is 12 months and the calibrations are traceable to NML/ROC and NIST/USA.

5.6.3 TEST PROCEDURES

1. The transmitter output was connected to the power meter through an attenuator, the bandwidth of the fundamental frequency was measured with the power meter.
2. Record the average power level.

5.6.4 TEST SETUP

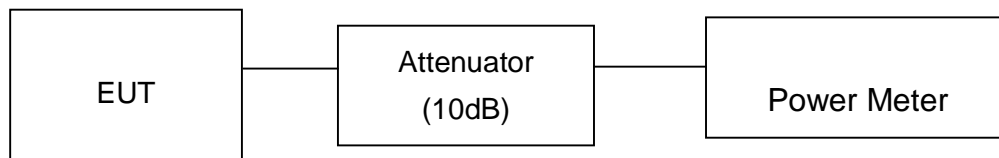

5.6.5 EUT OPERATING CONDITIONS

Same as Item 4.3.5



A D T

5.6.6 TEST RESULTS

802.11a OFDM MODULATION:

CHANNEL	CHANNEL FREQUENCY (MHz)	AVERAGE POWER OUTPUT (dBm)
149	5745	16.6
157	5785	16.5
165	5825	16.3

802.11n (20MHz) OFDM MODULATION:

CHANNEL	CHANNEL FREQUENCY (MHz)	AVERAGE POWER OUTPUT (dBm)
149	5745	17.5
157	5785	17.4
165	5825	17.1

802.11n (40MHz) OFDM MODULATION:

CHANNEL	CHANNEL FREQUENCY (MHz)	AVERAGE POWER OUTPUT (dBm)
151	5755	18.5
159	5795	18.6

5.7 POWER SPECTRAL DENSITY MEASUREMENT

5.7.1 LIMITS OF POWER SPECTRAL DENSITY MEASUREMENT

The Maximum of Power Spectral Density Measurement is 8dBm.

5.7.2 TEST INSTRUMENTS

DESCRIPTION & MANUFACTURER	MODEL NO.	SERIAL NO.	CALIBRATED DATE	CALIBRATED UNTIL
Spectrum Analyzer	E4446A	MY48250254	July 14, 2010	July 13, 2011

NOTE: The calibration interval of the above test instruments is 12 months and the calibrations are traceable to NML/ROC and NIST/USA.

5.7.3 TEST PROCEDURE

The transmitter output was connected to the spectrum analyzer through an attenuator, the bandwidth of the fundamental frequency was measured with the spectrum analyzer using 3 kHz RBW and 30 kHz VBW, set sweep time = span/3 kHz. The power spectral density was measured and recorded.

The sweep time is allowed to be longer than span/3 kHz for a full response of the mixer in the spectrum analyzer.

5.7.4 DEVIATION FROM TEST STANDARD

No deviation

5.7.5 TEST SETUP

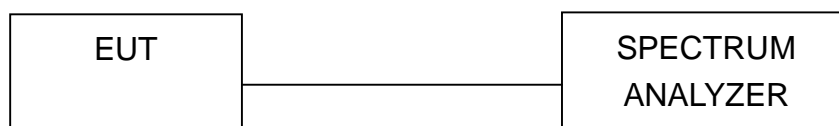

5.7.6 EUT OPERATING CONDITION

Same as Item 4.3.6



A D T

CH157

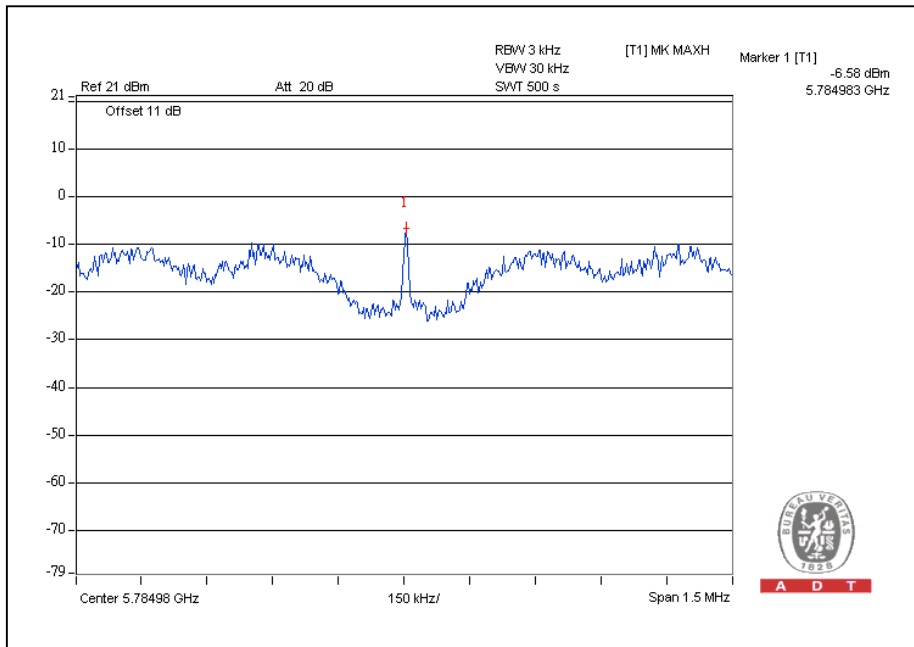

CH165

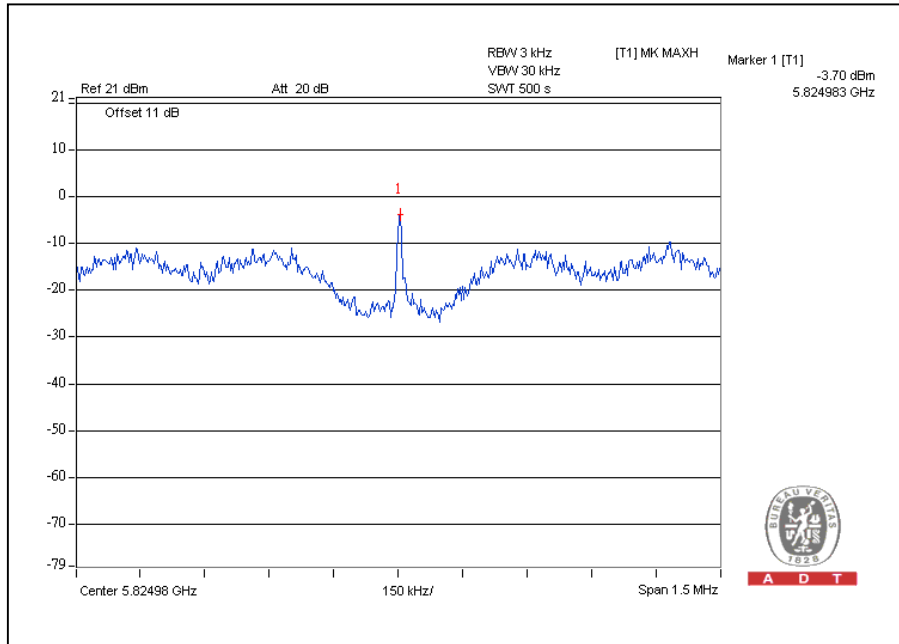



A D T

802.11n (20MHz) OFDM MODULATION:

CHANNEL	CHANNEL FREQUENCY (MHz)	RF POWER LEVEL IN 3kHz BW (dBm)	MAXIMUM LIMIT (dBm)	PASS / FAIL
149	5745	-5.4	8	PASS
157	5785	-5.1	8	PASS
165	5825	-10.0	8	PASS

CH149

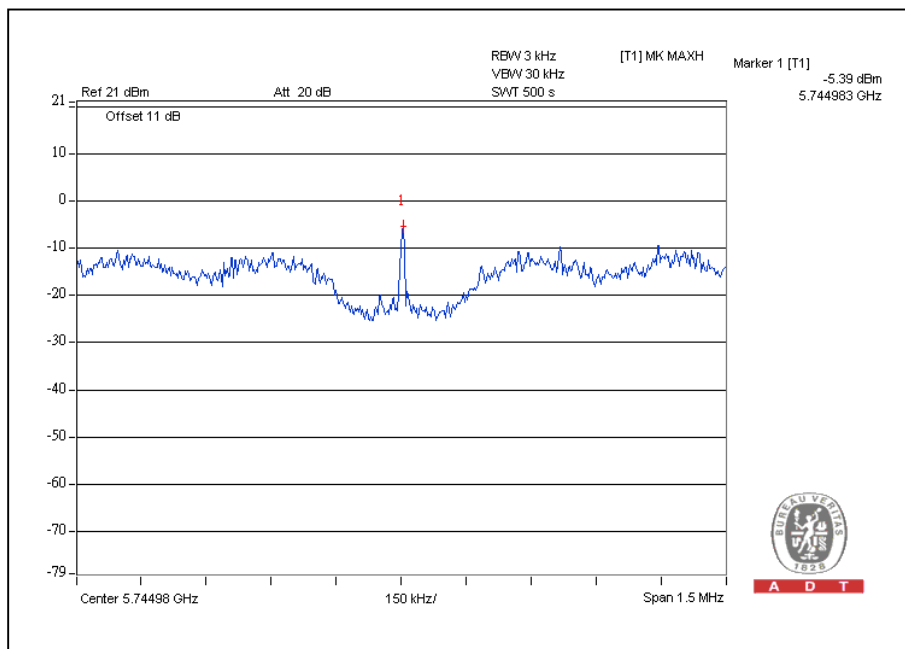



A D T

CH157

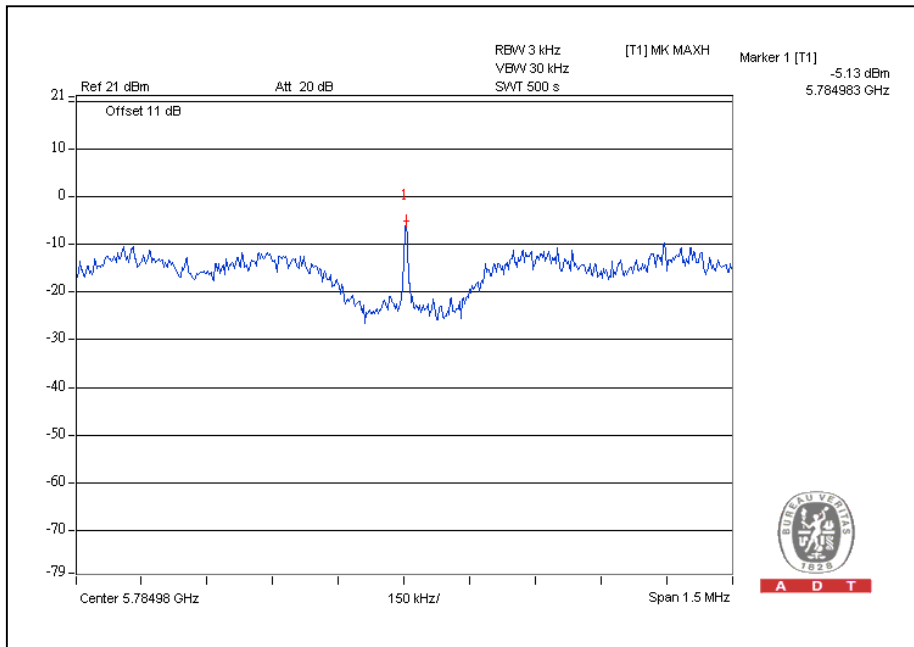

CH165

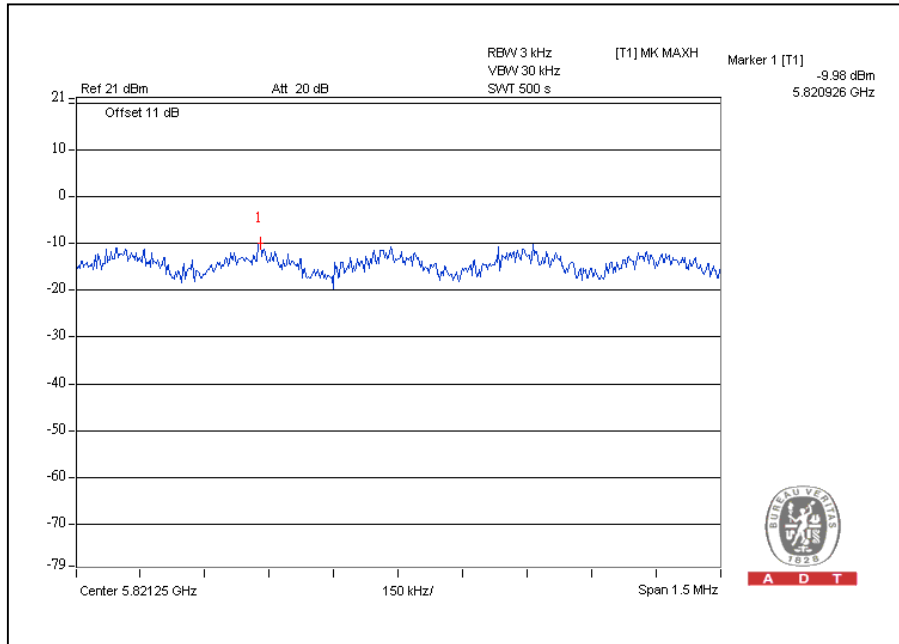



A D T

802.11n (40MHz) OFDM MODULATION:

CHANNEL	CHANNEL FREQUENCY (MHz)	RF POWER LEVEL IN 3kHz BW (dBm)	MAXIMUM LIMIT (dBm)	PASS / FAIL
151	5755	-7.6	8	PASS
159	5795	-9.6	8	PASS

CH151

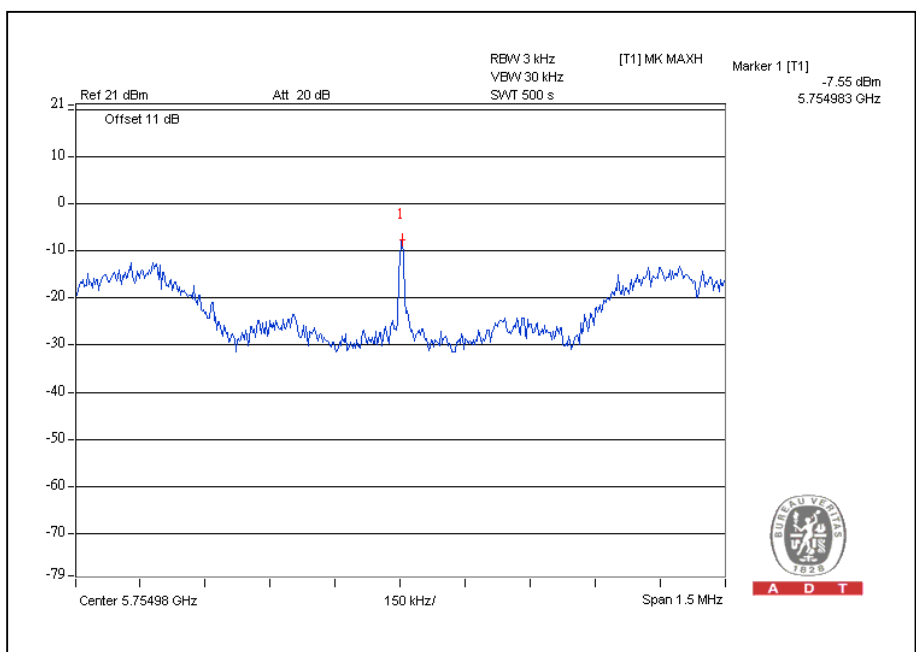



A D T

CH159

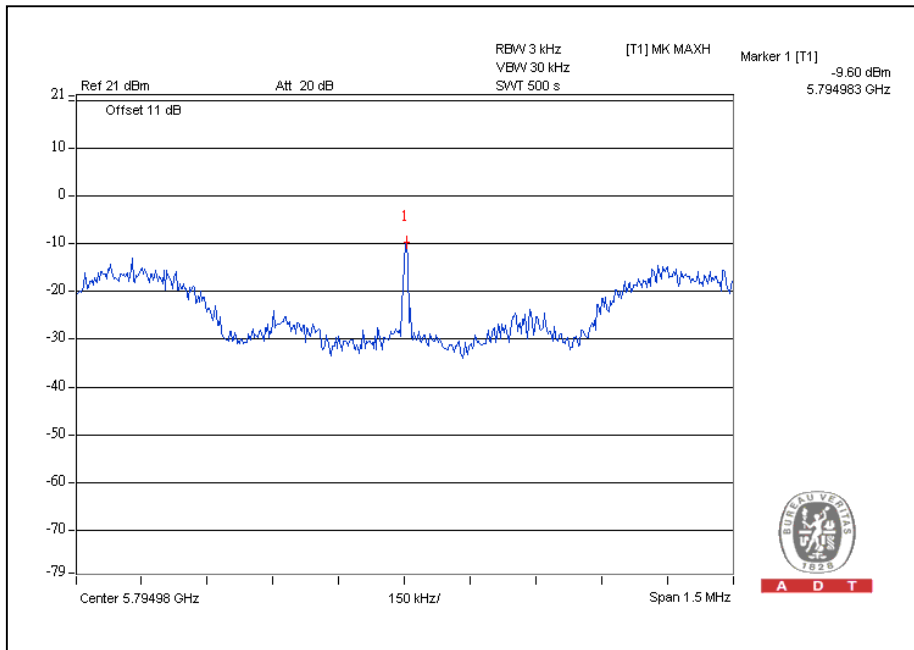

5.8 CONDUCTED OUT-BAND EMISSION MEASUREMENT

5.8.1 LIMITS OF CONDUCTED OUT-BAND EMISSION MEASUREMENT

Below -20dB of the highest emission level of operating band (in 100kHz Resolution Bandwidth).

5.8.2 TEST INSTRUMENTS

DESCRIPTION & MANUFACTURER	MODEL NO.	SERIAL NO.	CALIBRATED DATE	CALIBRATED UNTIL
Spectrum Analyzer	E4446A	MY48250254	July 14, 2010	July 13, 2011

NOTE: The calibration interval of the above test instruments is 12 months and the calibrations are traceable to NML/ROC and NIST/USA.

5.8.3 TEST PROCEDURE

The transmitter output was connected to the spectrum analyzer via a low loss cable. Set RBW of spectrum analyzer to 100 kHz with suitable frequency span including 100 MHz bandwidth from band edge. The band edges was measured and recorded.

5.8.4 DEVIATION FROM TEST STANDARD

No deviation

5.8.5 EUT OPERATING CONDITION

Same as Item 4.3.6

5.8.6 TEST RESULTS

The spectrum plots are attached on the following pages. D2 line indicates the highest level, D1 line indicates the 20dB offset below D2. It shows compliance with the requirement in part 15.247(d).

802.11a OFDM modulation

CH149

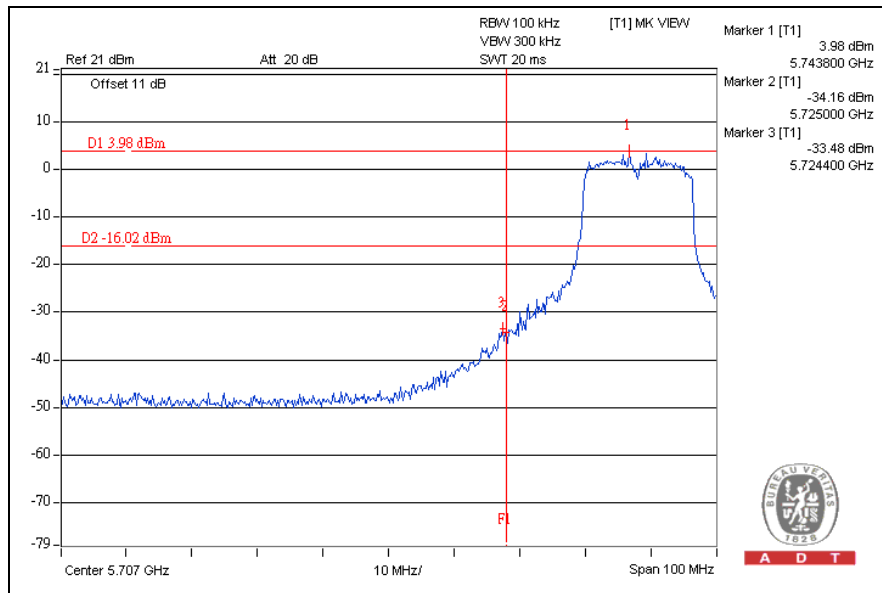

CH165

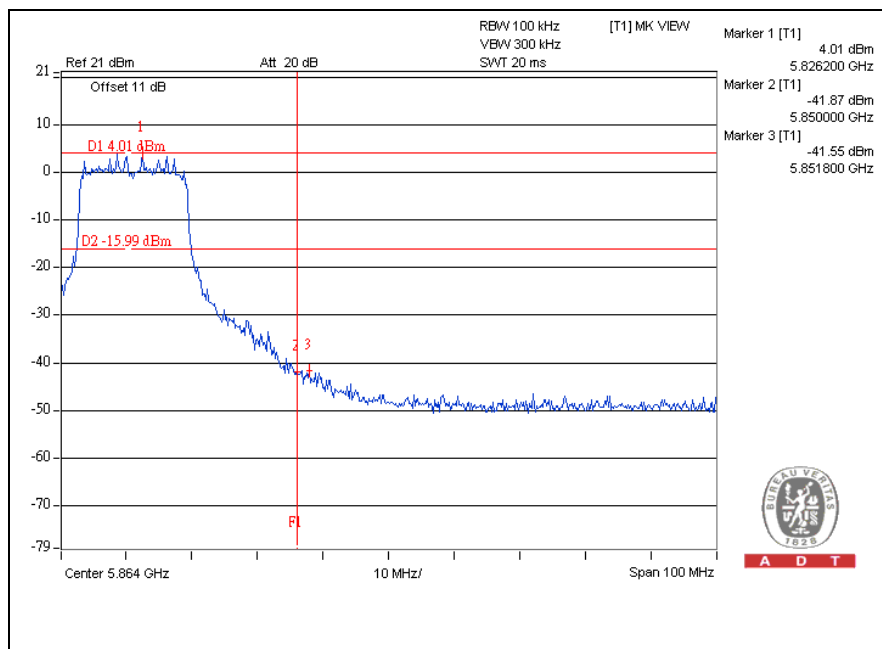

CH149

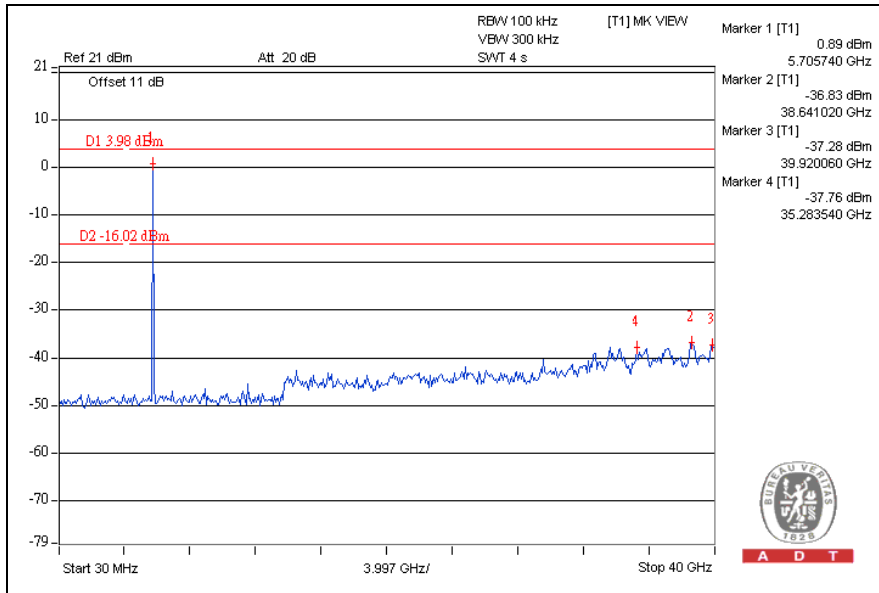

CH165

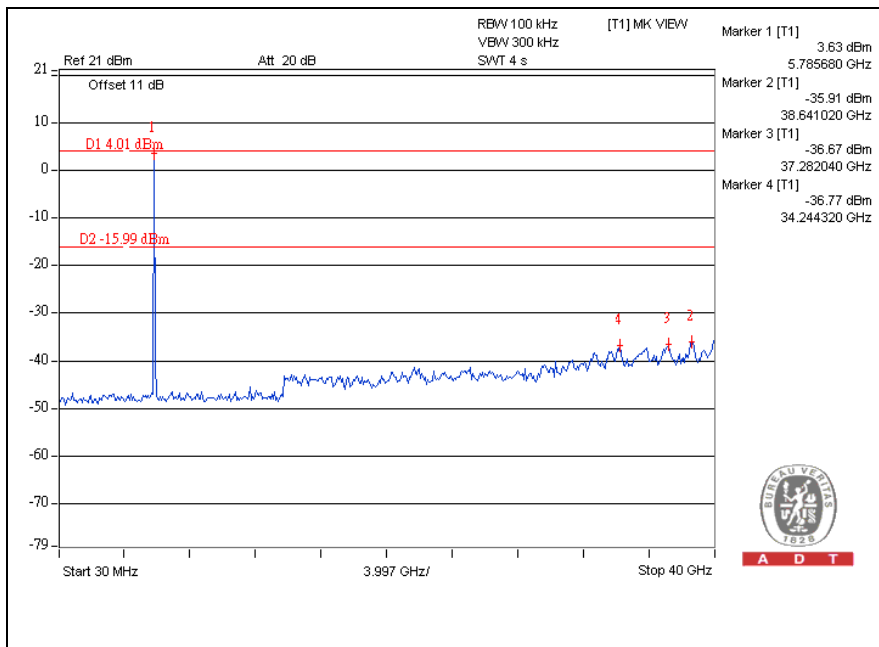



A D T

802.11n (20MHz) OFDM MODULATION:

CH149

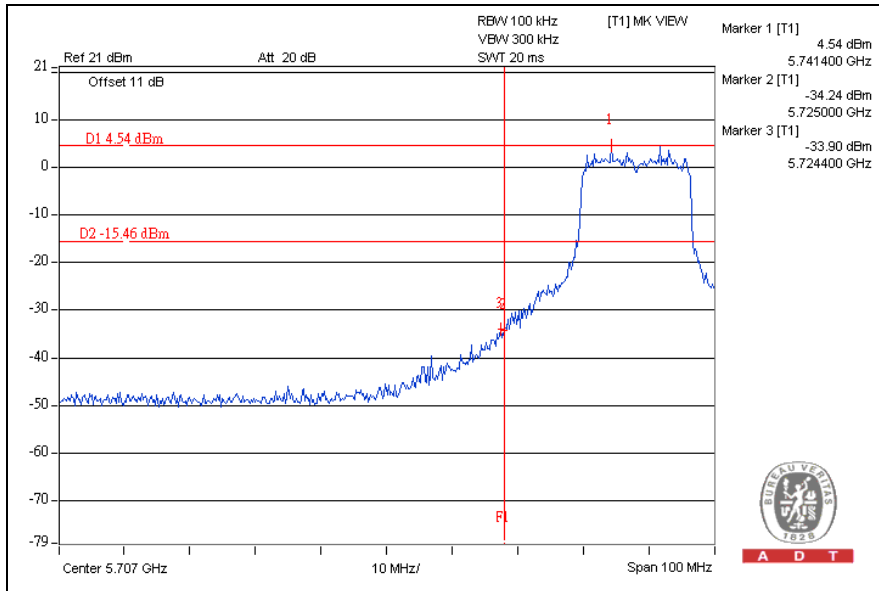

CH165

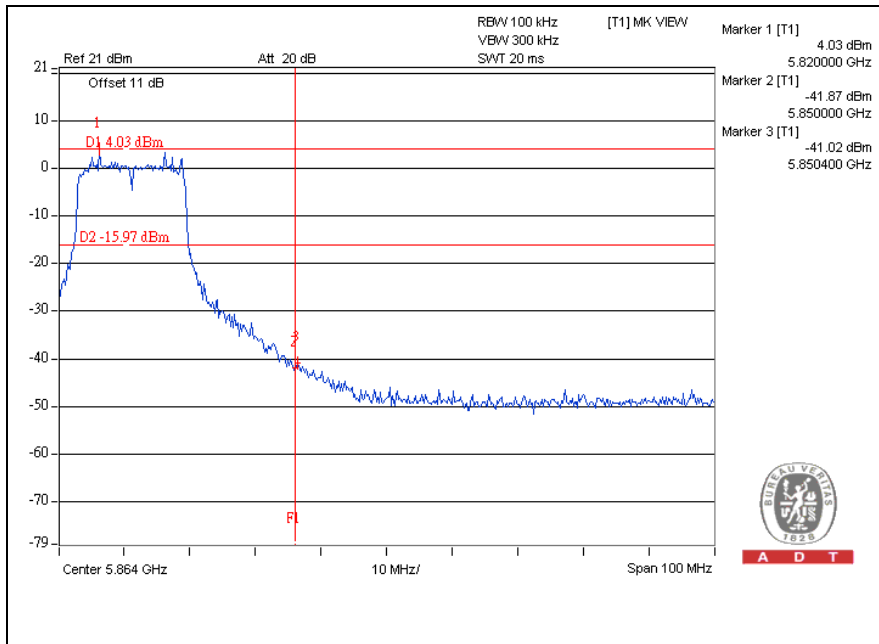



A D T

CH149

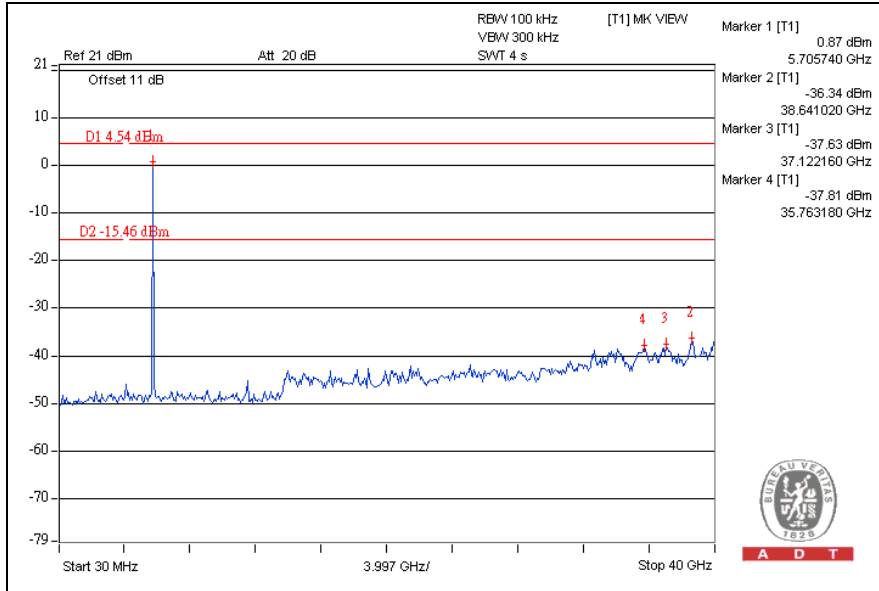

CH165

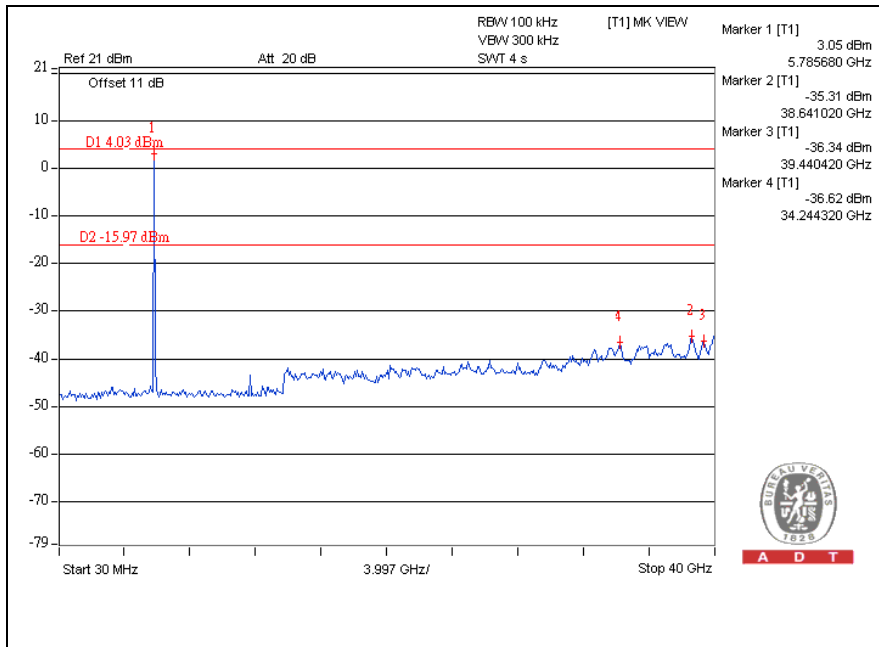

802.11n (40MHz) OFDM MODULATION:

CH151

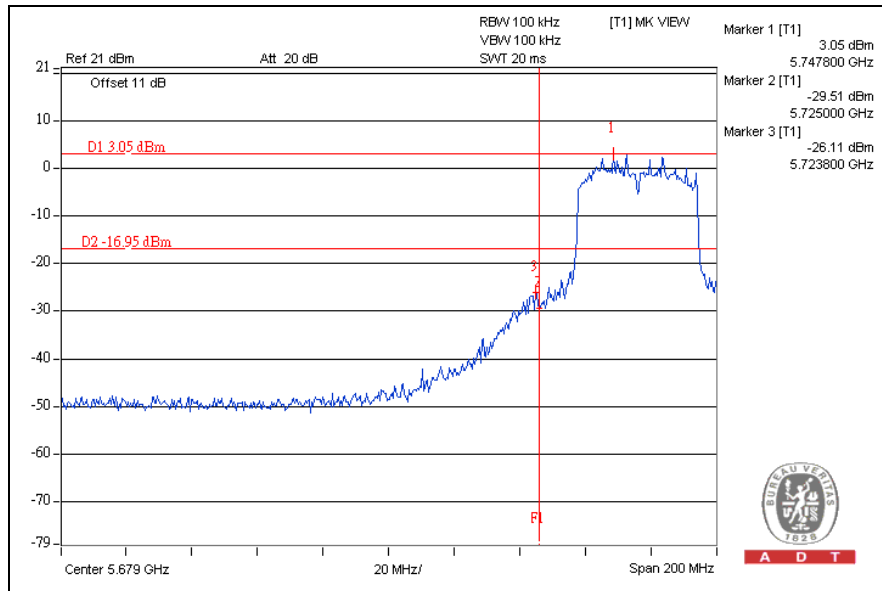

CH159

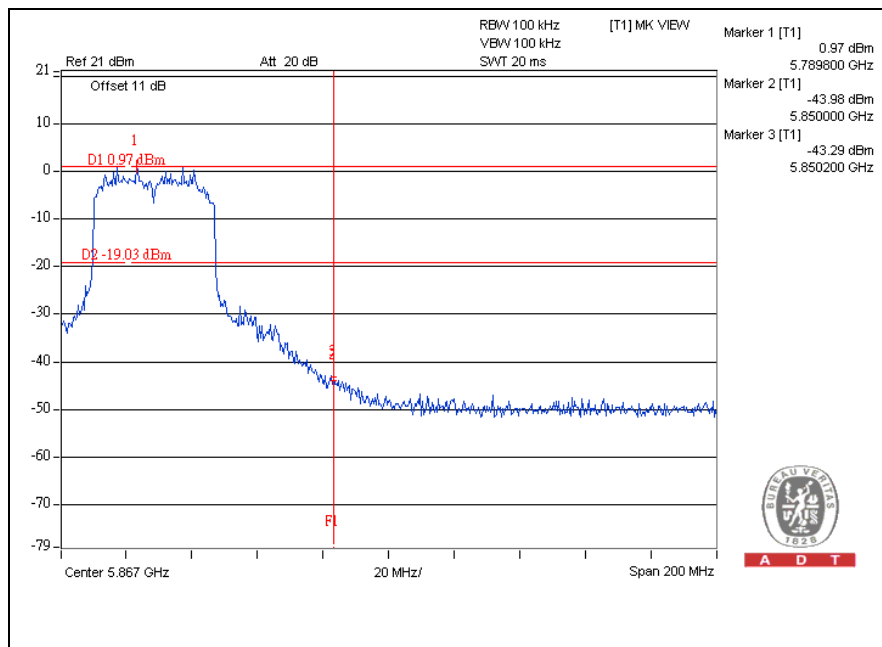

CH151

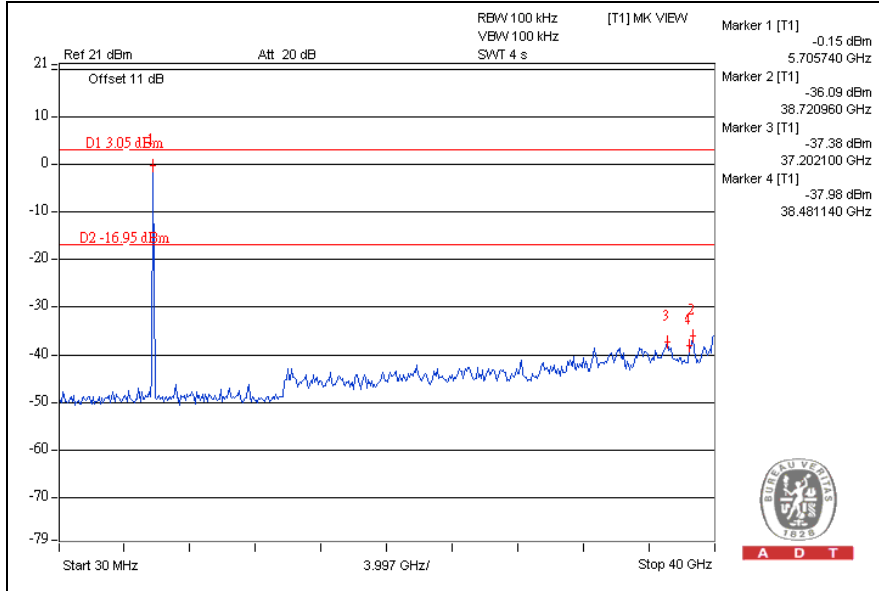

CH159

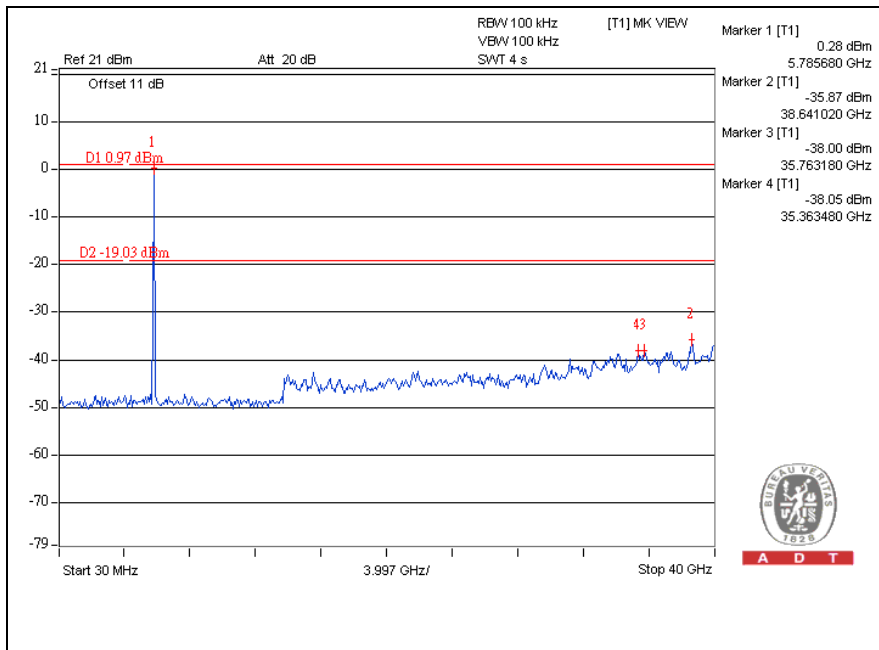



6. INFORMATION ON THE TESTING LABORATORIES

We, Bureau Veritas Consumer Products Services (H.K.) Ltd., Taoyuan Branch, were founded in 1988 to provide our best service in EMC, Radio, Telecom and Safety consultation. Our laboratories are accredited and approved according to ISO/IEC 17025.

Copies of accreditation certificates of our laboratories obtained from approval agencies can be downloaded from our web site:

www.adt.com.tw/index.5/phtml. If you have any comments, please feel free to contact us at the following:

Linko EMC/RF Lab:

Tel: 886-2-26052180

Fax: 886-2-26052943

Hsin Chu EMC/RF Lab:

Tel: 886-3-5935343

Fax: 886-3-5935342

Hwa Ya EMC/RF/Safety Telecom Lab:

Tel: 886-3-3183232

Fax: 886-3-3185050

Web Site: www.adt.com.tw

The address and road map of all our labs can be found in our web site also



A D T

7.APPENDIX A - MODIFICATIONS RECORDERS FOR ENGINEERING CHANGES TO THE EUT BY THE LAB

No any modifications are made to the EUT by the lab during the test.

--- END ---