



**FCC CFR47 PART 15 SUBPART E  
CLASS II PERMISSIVE CHANGE  
TEST REPORT**

**FOR**

**802.11A/B/G/N PCIEXPRESS MINICARD**

**MODEL NUMBER: AR5BXB72P**

**FCC ID: PPD-AR5BXB72P**

**REPORT NUMBER: 07U11030-1**

**ISSUE DATE: JULY 13, 2007**

*Prepared for*

**ATHEROS COMMUNICATIONS, INC.  
5480 GREAT AMERICA PARKWAY  
SANTA CLARA, CA 95054, USA**

*Prepared by*

**COMPLIANCE CERTIFICATION SERVICES  
47173 BENICIA STREET  
FREMONT, CA 94538, USA  
TEL: (510) 771-1000  
FAX: (510) 661-0888**



NVLAP LAB CODE 200065-0

Revision History

<u>Rev.</u>	<u>Issue Date</u>	<u>Revisions</u>	<u>Revised By</u>
A	7/13/07	Initial Issue based on CCS report 06U10382-1C FCC UNII C2PC Report, modified model and FCC ID, added Closing Time close-up plot.	M. Heckrotte

## TABLE OF CONTENTS

<b>1. ATTESTATION OF TEST RESULTS</b> .....	<b>5</b>
<b>2. TEST METHODOLOGY</b> .....	<b>6</b>
<b>3. FACILITIES AND ACCREDITATION</b> .....	<b>6</b>
<b>4. CALIBRATION AND UNCERTAINTY</b> .....	<b>6</b>
4.1. <i>MEASURING INSTRUMENT CALIBRATION</i> .....	6
4.2. <i>MEASUREMENT UNCERTAINTY</i> .....	6
<b>5. EQUIPMENT UNDER TEST</b> .....	<b>7</b>
5.1. <i>DESCRIPTION OF EUT</i> .....	7
5.2. <i>DESCRIPTION OF MODEL DIFFERENCES</i> .....	7
5.3. <i>DESCRIPTION OF CLASS II PERMISSIVE CHANGE</i> .....	7
5.4. <i>MAXIMUM OUTPUT POWER</i> .....	7
5.5. <i>DESCRIPTION OF AVAILABLE ANTENNAS</i> .....	8
5.6. <i>SOFTWARE AND FIRMWARE</i> .....	8
5.7. <i>WORST-CASE CONFIGURATION AND MODE</i> .....	8
5.8. <i>DESCRIPTION OF TEST SETUP</i> .....	9
<b>6. TEST AND MEASUREMENT EQUIPMENT</b> .....	<b>11</b>
<b>7. LIMITS AND RESULTS</b> .....	<b>12</b>
7.1. <i>CHANNEL TESTS FOR THE 5470 TO 5725 MHz BAND</i> .....	12
7.1.1. 99% BANDWIDTH AND 26 dB BANDWIDTH .....	12
7.1.2. MAXIMUM POWER .....	31
7.1.3. AVERAGE POWER.....	51
7.1.4. PEAK POWER SPECTRAL DENSITY .....	53
7.1.5. PEAK EXCURSION .....	73
7.1.6. CONDUCTED SPURIOUS EMISSIONS.....	93
7.2. <i>MAXIMUM PERMISSIBLE EXPOSURE</i> .....	121
7.3. <i>RADIATED EMISSIONS</i> .....	124
7.3.1. TRANSMITTER RADIATED SPURIOUS EMISSIONS .....	124
7.3.2. TRANSMITTER ABOVE 1 GHz FOR 5470 TO 5725 MHz BAND WITH PIFA ANTENNAS .....	127
7.3.3. TRANSMITTER ABOVE 1 GHz FOR 5470 TO 5725 MHz BAND WITH MONOPOLE ANTENNAS .....	154
7.3.4. WORST-CASE RADIATED EMISSIONS BELOW 1 GHz WITH PIFA ANTENNAS	181
7.3.5. WORST-CASE RADIATED EMISSIONS BELOW 1 GHz WITH MONOPOLE ANTENNAS .....	183
7.4. <i>DYNAMIC FREQUENCY SELECTION</i> .....	185

7.4.1. LIMITS ..... 185  
7.4.2. DESCRIPTION OF EUT ..... 188  
7.4.3. TEST AND MEASUREMENT SYSTEM ..... 189  
7.4.4. SETUP OF EUT AND SUPPORT EQUIPMENT ..... 193  
7.4.5. PLOTS OF NOISE, RADAR WAVEFORMS, AND WLAN SIGNALS ..... 195  
7.4.6. TEST CHANNEL AND METHOD ..... 198  
7.4.7. CHANNEL MOVE TIME AND CHANNEL CLOSING TRANSMISSION TIME ..... 198  
7.5. *POWERLINE CONDUCTED EMISSIONS* ..... 202  
**8. SETUP PHOTOS ..... 206**  
**9. APPENDIX A: MANUFACTURER’S DECLARATION OF MODEL DIFFERENCES..... 217**

## 1. ATTESTATION OF TEST RESULTS

**COMPANY NAME:** Atheros Communications, Inc.  
5480 Great America Parkway  
Santa Clara, CA 95054, USA

**EUT DESCRIPTION:** 802.11A/B/G/N PCIEXPRESS MINICARD

**MODEL:** AR5BXB72P

**MFR / MODEL TESTED:** Atheros AR5BXB72  
**SERIAL NUMBER TESTED:** XB72-060-L0416  
**DATE TESTED:** JUNE 16 - OCTOBER 11, 2006, and JUNE 7, 2007

APPLICABLE STANDARDS	
STANDARD	TEST RESULTS
FCC PART 15 SUBPART E	NO NON-COMPLIANCE NOTED

Compliance Certification Services, Inc. tested the above equipment in accordance with the requirements set forth in the above standards. The test results show that the equipment tested is capable of demonstrating compliance with the requirements as documented in this report.

**Note:** The results documented in this report apply only to the tested sample, under the conditions and modes of operation as described herein. This document may not be altered or revised in any way unless done so by Compliance Certification Services and all revisions are duly noted in the revisions section. Any alteration of this document not carried out by Compliance Certification Services will constitute fraud and shall nullify the document. No part of this report may be used to claim product certification, approval, or endorsement by NVLAP, NIST, or any government agency.

Approved & Released For CCS By:

Tested By:



---

MIKE HECKROTTE  
ENGINEERING MANAGER  
COMPLIANCE CERTIFICATION SERVICES

---

CAN CHUNG  
EMC ENGINEER  
COMPLIANCE CERTIFICATION SERVICES

## 2. TEST METHODOLOGY

The tests documented in this report were performed in accordance with ANSI C63.4-2003, FCC CFR 47 Part 2, FCC CFR 47 Part 15 and FCC 06-96 APPENDIX "COMPLIANCE MEASUREMENT PROCEDURES FOR UNLICENSED-NATIONAL INFORMATION INFRASTRUCTURE DEVICES OPERATING IN THE 5250-5350 MHz AND 5470-5725 MHz BANDS INCORPORATING DYNAMIC FREQUENCY SELECTION".

## 3. FACILITIES AND ACCREDITATION

The test sites and measurement facilities used to collect data are located at 561F Monterey Road, Morgan Hill, California, USA. The sites are constructed in conformance with the requirements of ANSI C63.4, ANSI C63.7 and CISPR Publication 22. All receiving equipment conforms to CISPR Publication 16-1, "Radio Interference Measuring Apparatus and Measurement Methods."

CCS is accredited by NVLAP, Laboratory Code 200065-0. The full scope of accreditation can be viewed at <http://www.ccsemc.com>.

## 4. CALIBRATION AND UNCERTAINTY

### 4.1. MEASURING INSTRUMENT CALIBRATION

The measuring equipment utilized to perform the tests documented in this report has been calibrated in accordance with the manufacturer's recommendations, and is traceable to recognized national standards.

### 4.2. MEASUREMENT UNCERTAINTY

Where relevant, the following measurement uncertainty levels have been estimated for tests performed on the apparatus:

PARAMETER	UNCERTAINTY
Radiated Emission, 30 to 200 MHz	+/- 3.3 dB
Radiated Emission, 200 to 1000 MHz	+4.5 / -2.9 dB
Radiated Emission, 1000 to 2000 MHz	+4.5 / -2.9 dB
Power Line Conducted Emission	+/- 2.9 dB

Uncertainty figures are valid to a confidence level of 95%.

## 5. EQUIPMENT UNDER TEST

### 5.1. DESCRIPTION OF EUT

The AR5BXB72P is designed for 802.11a/b/g/n applications using the AR541X/51XX chipset with a PCIExpress Minicard interface. It has three receive chains and two transmit chains (2x3 configuration).

The 2x3 configuration is implemented with two outside chains (Chain 0 and 2) as Tx/Rx and the middle chain (chain 1) as Rx only.

A 2x2 configuration is implemented by depopulating the middle receive chain; in this configuration the transmit chains are identical to the 2x3 configuration. The 2x2 version, when marketed, will have a unique model ID to differentiate it from the fully configured version.

### 5.2. DESCRIPTION OF MODEL DIFFERENCES

Appendix A contains the applicant's attestation that the hardware and firmware of the EUT is identical to the sample tested.

### 5.3. DESCRIPTION OF CLASS II PERMISSIVE CHANGE

The change under this application is to add DFS compliance and support for 5.47-5.725 GHz operation.

### 5.4. MAXIMUM OUTPUT POWER

The transmitter has a maximum peak conducted output power as follows:

#### 5250 to 5350 MHz Authorized Band

Frequency Band (MHz)	Mode	Output Power (dBm)	Output Power (mW)
5260 - 5320	802.11a	18.03	63.53
5260 - 5320	802.11n HT20	20.48	111.69
5260 - 5310	802.11n HT40	21.23	132.74

#### 5470 to 5725 MHz Authorized Band

Frequency Band (MHz)	Mode	Output Power (dBm)	Output Power (mW)
5500 - 5700	802.11a	18.51	70.96
5500 - 5700	802.11n HT20	20.68	116.95
5510 - 5690	802.11n HT40	20.55	113.50

## 5.5. DESCRIPTION OF AVAILABLE ANTENNAS

The 2x3 configuration utilizes a set of three identical PIFA antennas (maximum gain is 5.56 dBi from 5250 – 5350 MHz and 5.34 dBi from 5470 – 5725 MHz) or a set of three identical Monopole antennas (maximum gain is 6.2 dBi from 5250 – 5350 MHz and is 5.3 dBi from 5470 – 5725 MHz).

Two identical antennas as otherwise described above are used in the 2x2 configuration.

## 5.6. SOFTWARE AND FIRMWARE

The EUT driver software installed in the host support equipment during testing was AR5002, ANWI Diagnostic Kernel Drive.

The test utility software used during testing was Art Software Revision 0.3 Build #4 Art 11n.

## 5.7. WORST-CASE CONFIGURATION AND MODE

The 2x3 configuration was used for all testing in this report.

The worst-case data rates are determined to be as follows for each mode, based on the investigations by measuring the average power, peak power and PPSD across all the data rates, bandwidths, modulations and spatial stream modes.

Thus all emissions tests were made with following data rates:

- 802.11a mode, 20 MHz Channel Bandwidth, 9 Mb/s, OFDM Modulation, Spatial Stream 1.
- 802.11n HT20 mode, 20 MHz Channel Bandwidth, MCS0, 6.5 Mb/s, OFDM Modulation, Spatial Stream 1.
- 802.11n HT40 mode, 40 MHz Channel Bandwidth, MCS0, 13.5 Mb/s, OFDM Modulation, Spatial Stream 1.

The worst-case configuration for tests below 1 GHz is the mode and channel with the highest power: 802.11b mode, mid channel.

Baseline testing demonstrated that the Power Spectral Density as measured through a combiner with both chains operating simultaneously is less than the sum of the Power Spectral Density of each individual chain when added linearly.



## 5.8. DESCRIPTION OF TEST SETUP

### SUPPORT EQUIPMENT

PERIPHERAL SUPPORT EQUIPMENT LIST				
Description	Manufacturer	Model	Serial Number	FCC ID
Laptop	IBM	Thindthind R52	L3-GR045	DoC
AC Adapter	IBM	92P1016	11S92P1016Z1ZAC65C71HZ	DoC

### I/O CABLES

I/O CABLE LIST						
Cable No.	Port	# of Identical Ports	Connector Type	Cable Type	Cable Length	Remarks
1	AC	1	US 115V	Un-shielded	2m	NA
2	DC	1	DC	Un-shielded	2m	NA

### TEST SETUP

The EUT is installed in a host laptop computer via a PCIExpress Minicard extender board during the tests. Test software exercised the radio card.

**SETUP DIAGRAM FOR TESTS**

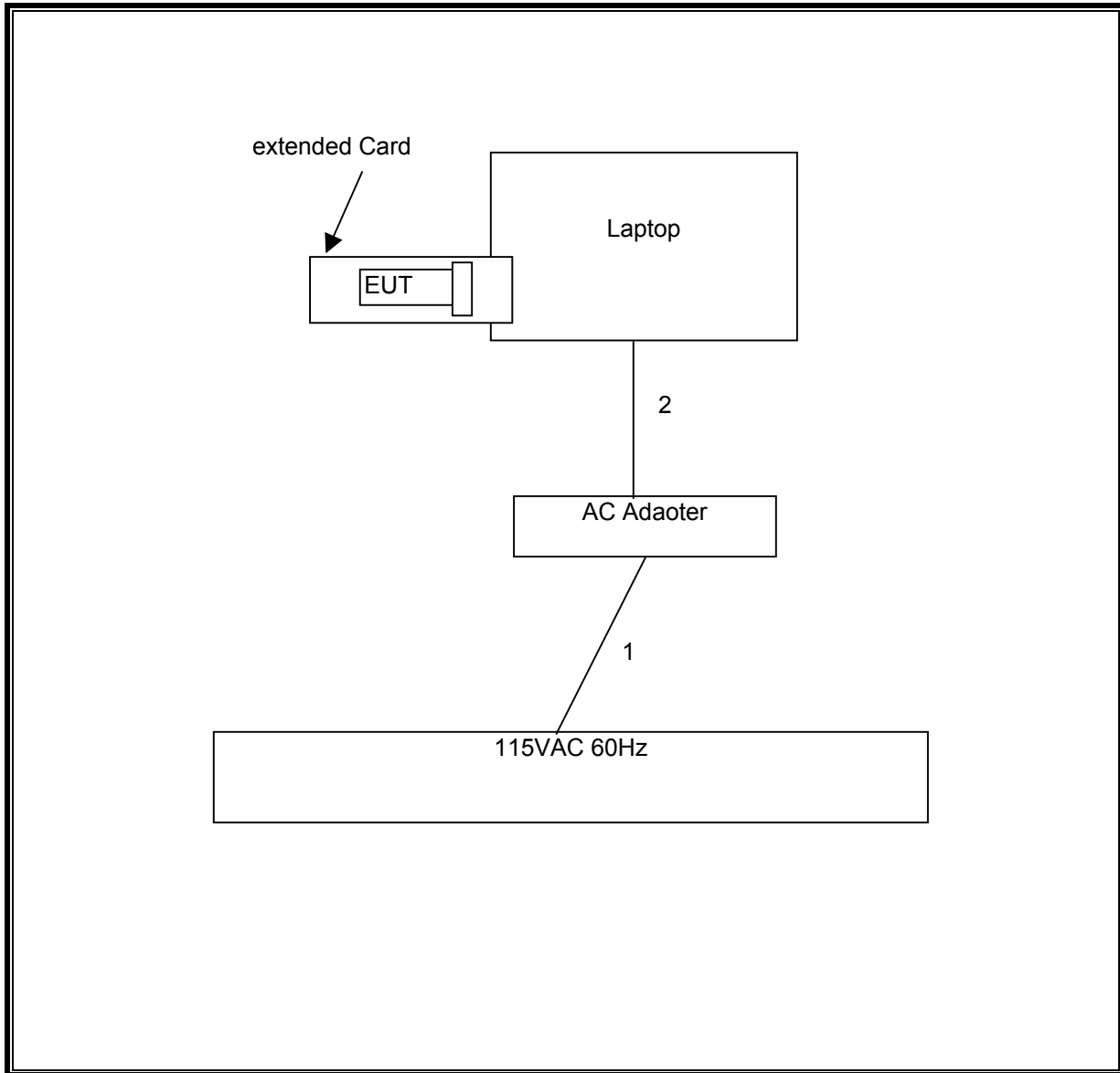

## 6. TEST AND MEASUREMENT EQUIPMENT

The following test and measurement equipment was utilized for the tests documented in this report:

TEST EQUIPMENT LIST				
Description	Manufacturer	Model	Serial Number	Cal Due
Antenna, Bilog 30 MHz ~ 2 Ghz	Sunol Sciences	JB1	A121003	9/3/2006
RF Filter Section	Agilent / HP	85420E	3705A00256	2/4/2007
EMI Receiver, 9 kHz ~ 2.9 GHz	Agilent / HP	8542E	3942A00286	2/4/2007
Antenna, Horn 1 ~ 18 GHz	EMCO	3115	6717	4/22/2007
Preamplifier, 1 ~ 26.5 GHz	Agilent / HP	8449B	3008A00369	8/17/2006
Spectrum Analyzer 3 Hz ~ 44 GHz	Agilent / HP	E4446A	MY45300064	12/19/2006
Peak / Average Power Sensor	Agilent	E9327A	US40440755	12/2/2007
Peak Power Meter	Agilent / HP	E4416A	GB41291160	12/2/2007
EMI Test Receiver	R & S	ESHS 20	827129/006	6/3/2007
LISN, 10 kHz ~ 30 MHz	FCC	LISN-50/250-25-2	2023	8/30/2006
Antenna, Horn 18 ~ 26 GHz	ARA	MWH-1826/B	1049	9/12/06
Preamplifier, 26 ~ 40 GHz	Miteq	NSP4000-SP2	924343	8/18/06
Spectrum Analyzer 3 Hz ~ 44 GHz	Agilent / HP	E4446A	US42070220	7/29/2006
Vector Signal Generator 250kHz-20GHz	Agilent / HP	E8267C	US43320336	11/2/2007

The following test and measurement equipment was utilized for the tests performed on June 7, 2007:

TEST EQUIPMENT LIST				
Description	Manufacturer	Model	Serial Number	Cal Due
Spectrum Analyzer 3 Hz ~ 44 GHz	Agilent / HP	E4446A	US42070220	11/26/2007
Vector Signal Generator 250kHz-20GHz	Agilent / HP	E8267C	US43320336	11/2/2007

## 7. LIMITS AND RESULTS

### 7.1. CHANNEL TESTS FOR THE 5470 TO 5725 MHz BAND

#### 7.1.1. 99% BANDWIDTH AND 26 dB BANDWIDTH

##### LIMIT

None; for reporting purposes only.

##### TEST PROCEDURE

The transmitter output is connected to the spectrum analyzer. The RBW is set to 1% to 3% of the 99 % bandwidth. The VBW is set to 3 times the RBW. The sweep time is coupled. The spectrum analyzer internal 99% bandwidth and 26 dB bandwidth functions are utilized.

##### RESULTS

No non-compliance noted:

Mode Channel	Frequency (MHz)	99% BW Chain 0 (MHz)	99% BW Chain 2 (MHz)	26 dB BW Chain 0 (MHz)	26 dB BW Chain 2 (MHz)	Worst Case 10 Log B (dB)
--------------	-----------------	----------------------	----------------------	------------------------	------------------------	--------------------------

##### 802.11a Mode

Low	5500	16.44	16.46	18.4	20.81	13.18
Middle	5600	16.46	16.48	19.35	18.97	12.87
High	5700	16.46	16.45	18.5	18.41	12.67

##### 802.11n HT20 Mode

Low	5500	17.69	17.71	19.86	20.83	13.19
Mid	5600	17.65	17.67	19.72	20.59	13.14
High	5700	17.71	17.69	19.84	20.12	13.04

##### 802.11n HT40 Mode

Low	5510	36.19	36.41	38.09	38.42	15.85
Mid	5600	36.29	36.35	39.53	38.76	15.97
High	5690	36.43	36.39	38.57	38.11	15.86

**(802.11a MODE CHAIN 0)**

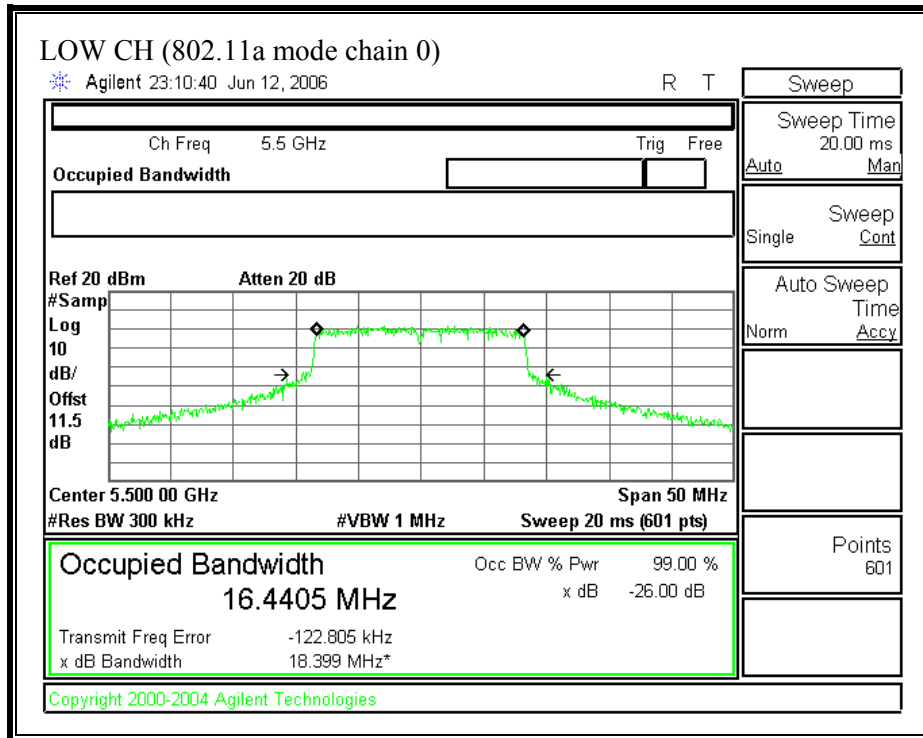

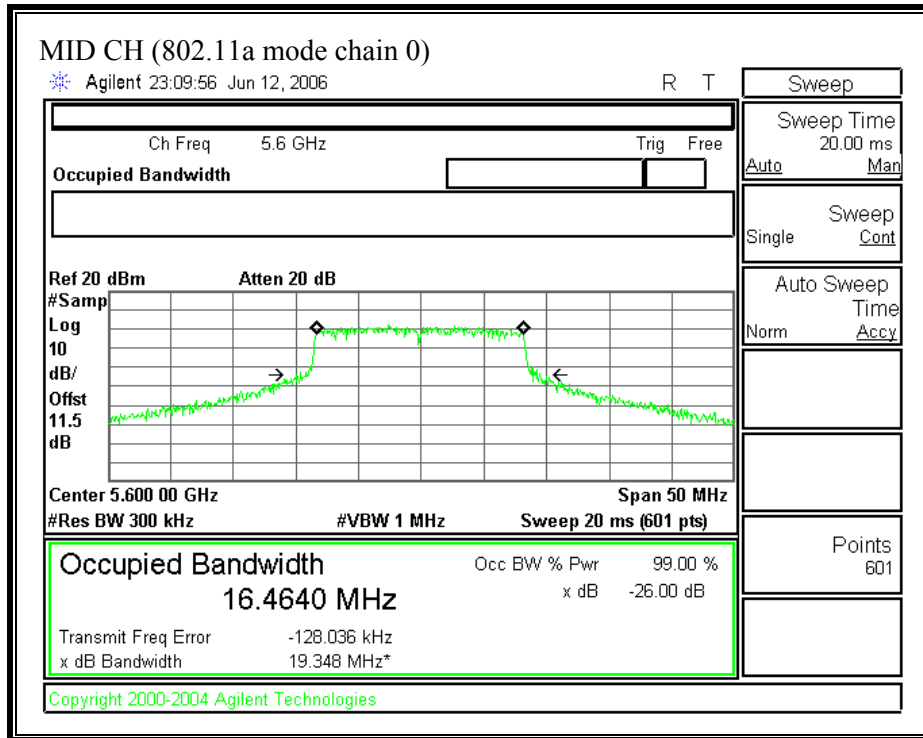

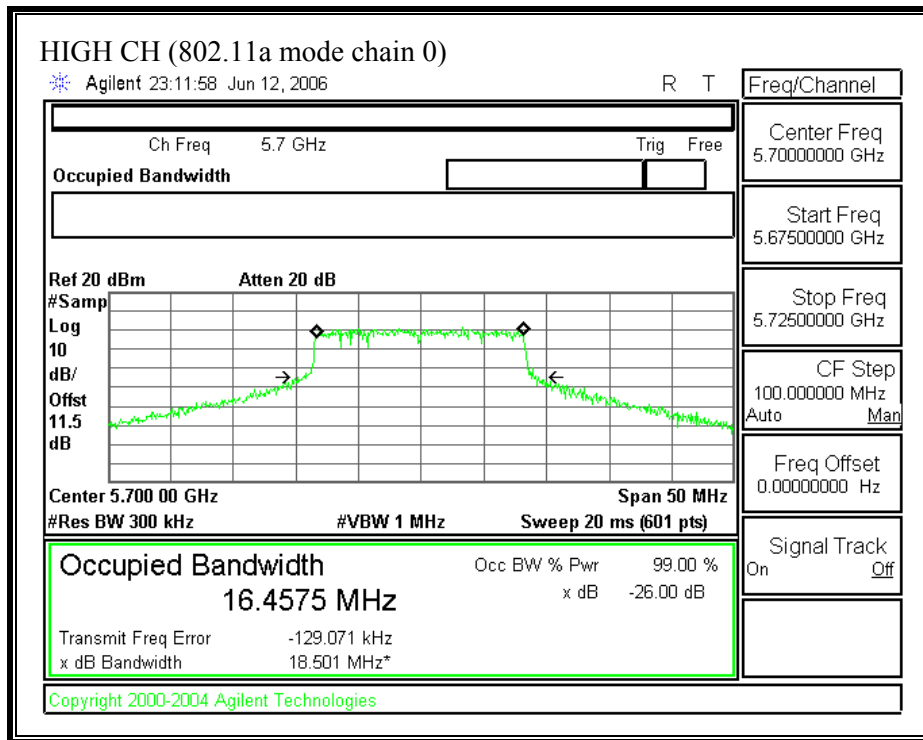

**(802.11a MODE CHAIN 2)**

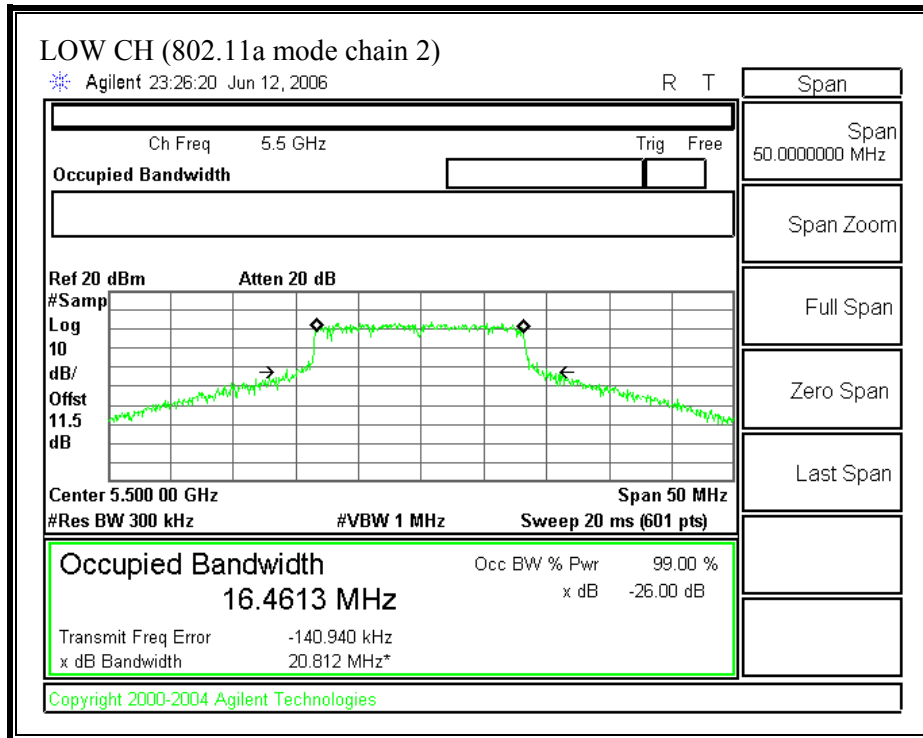



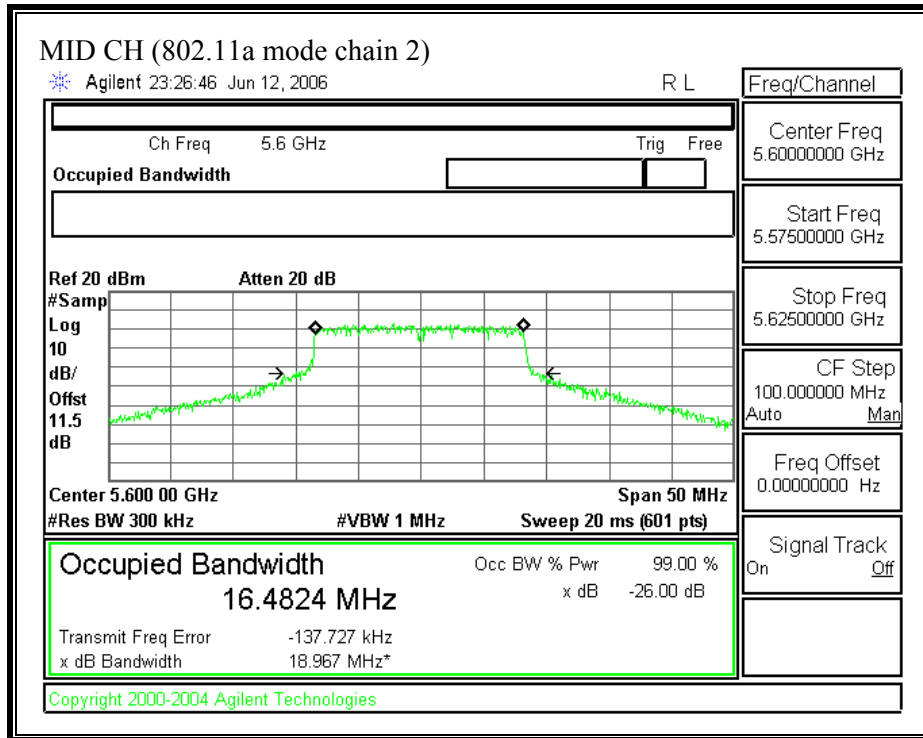

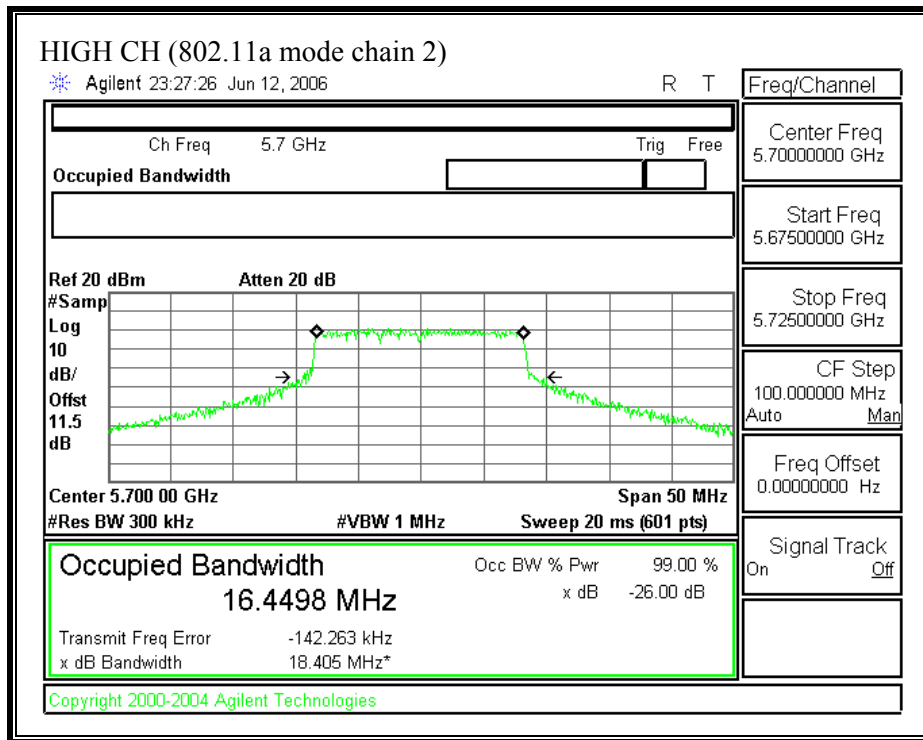

**(802.11n HT20 MODE CHAIN 0)**

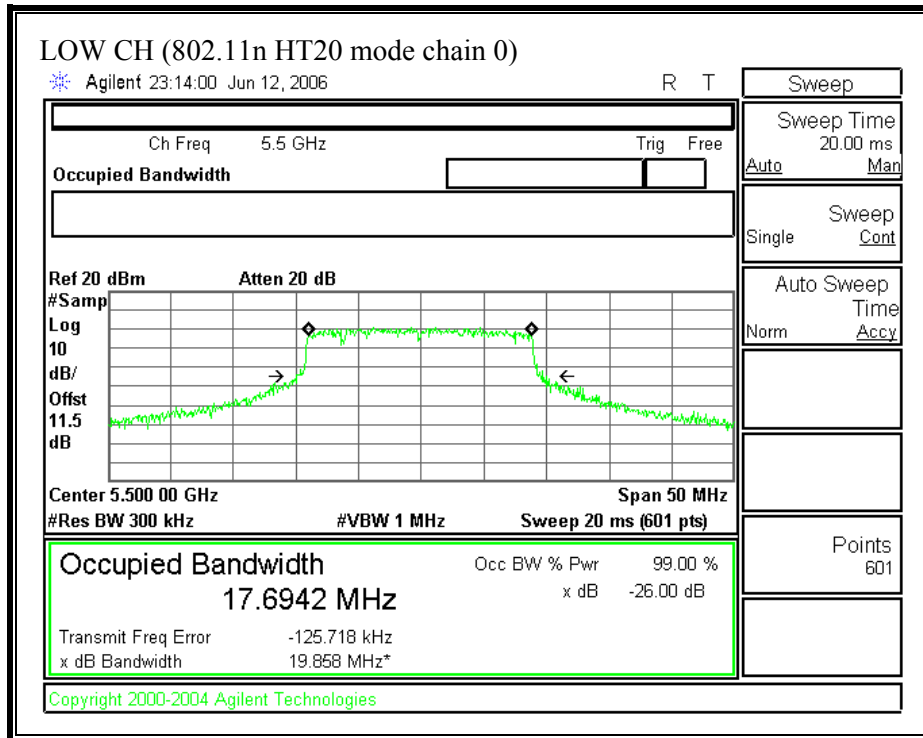

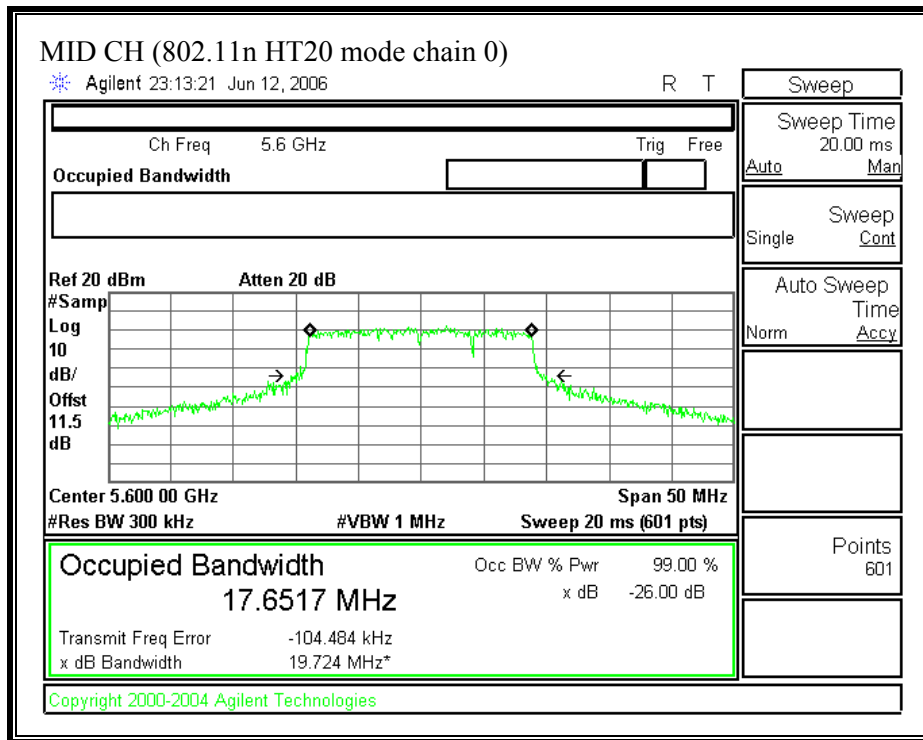

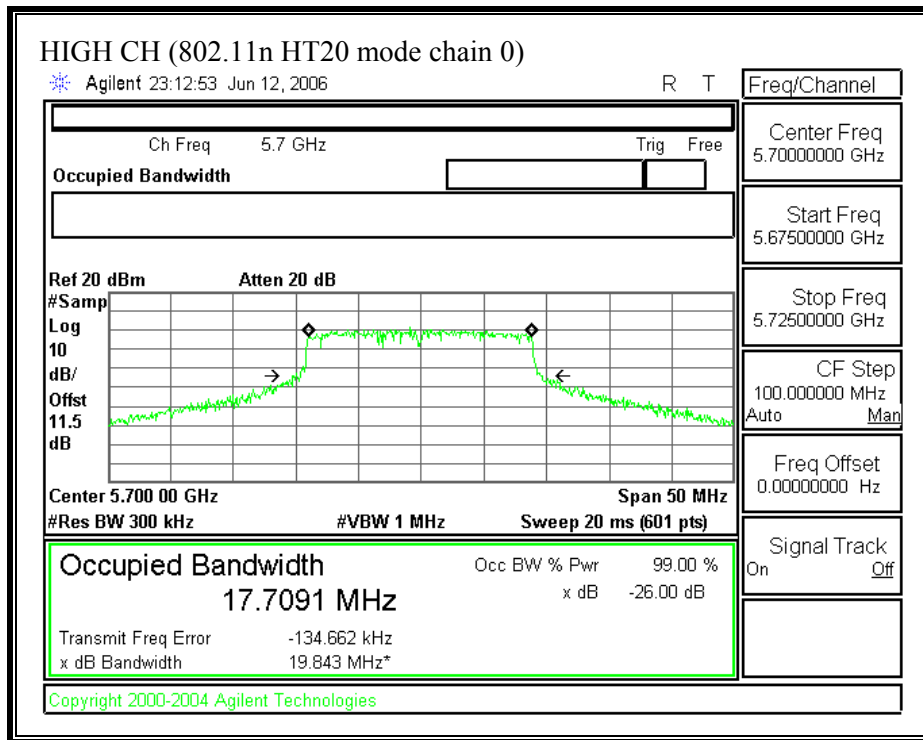

**(802.11 HT20 MODE CHAIN 2)**

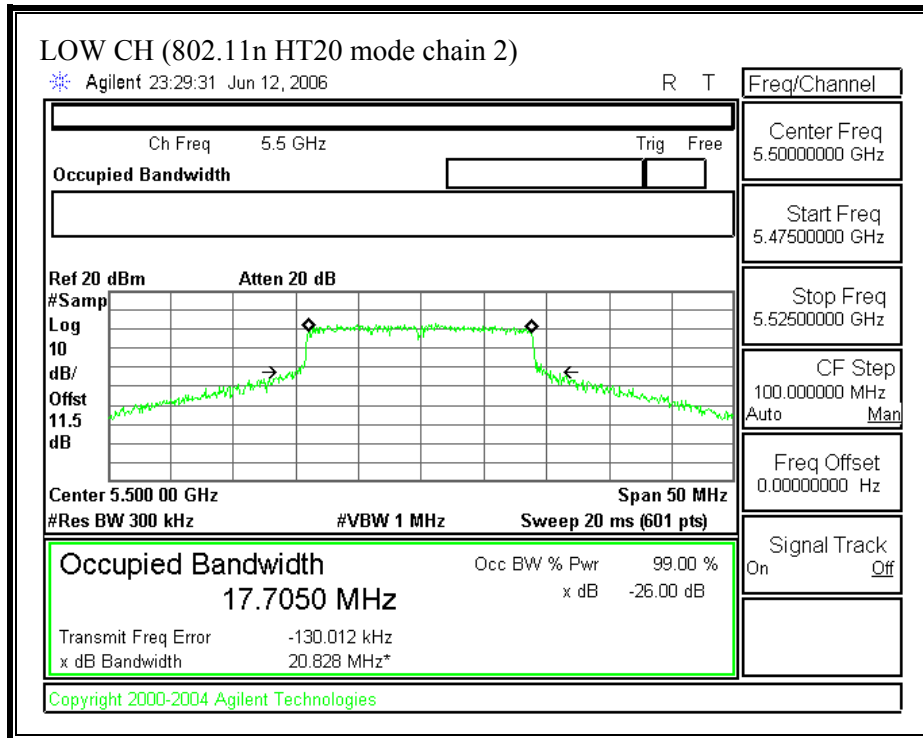

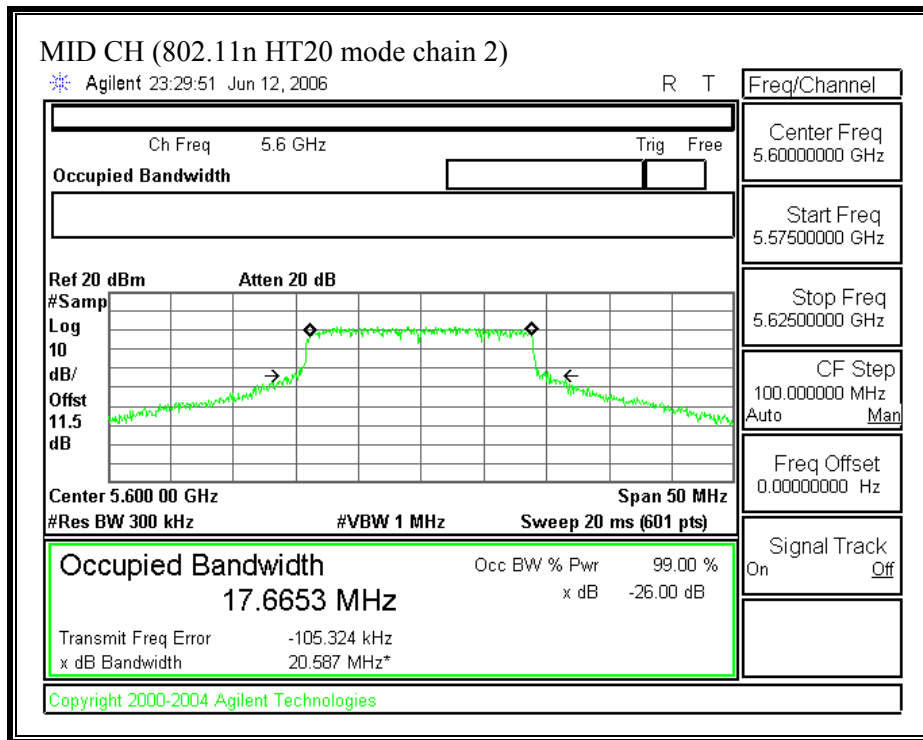

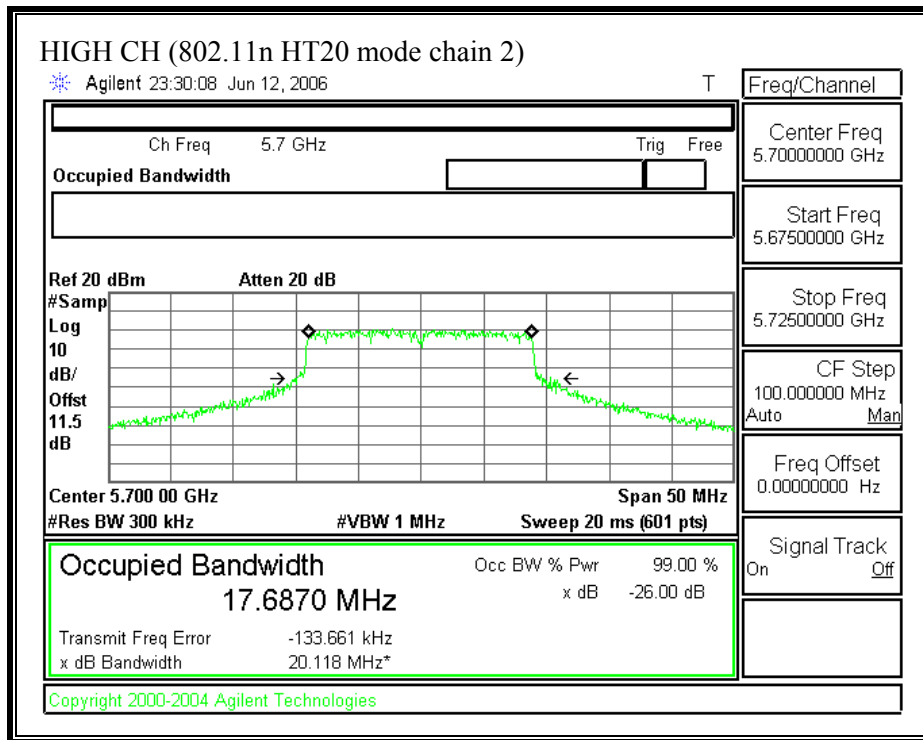



**(802.11 HT40 MODE CHAIN 0)**

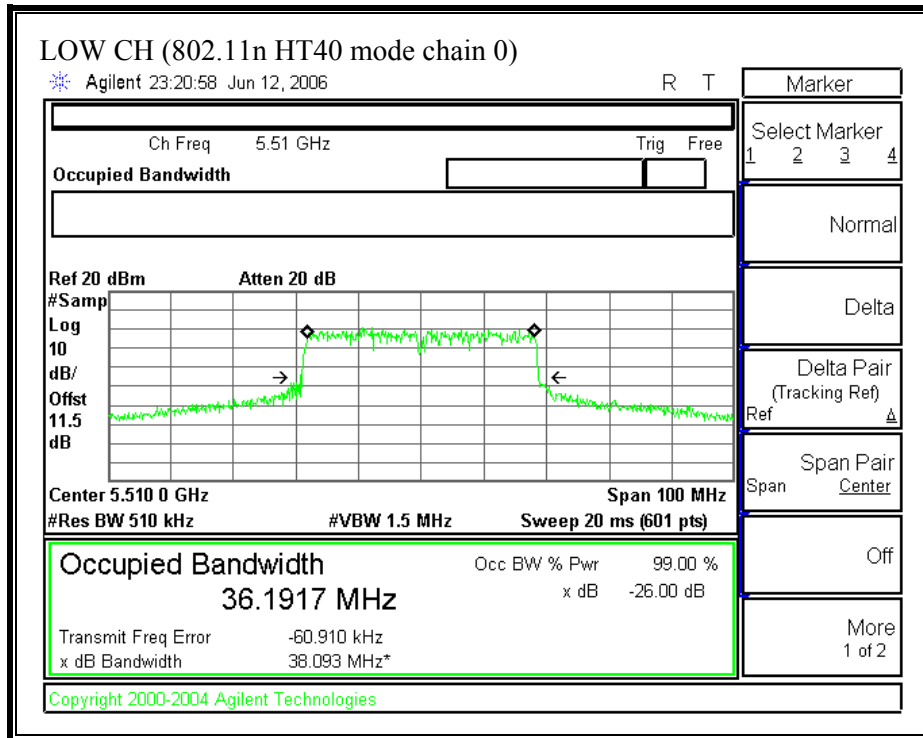

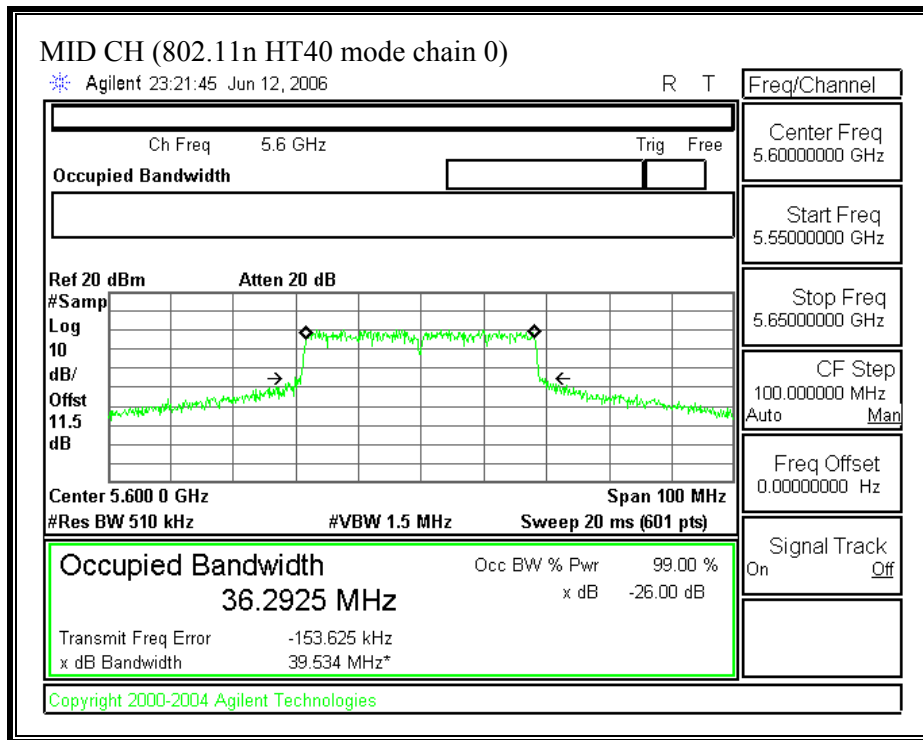

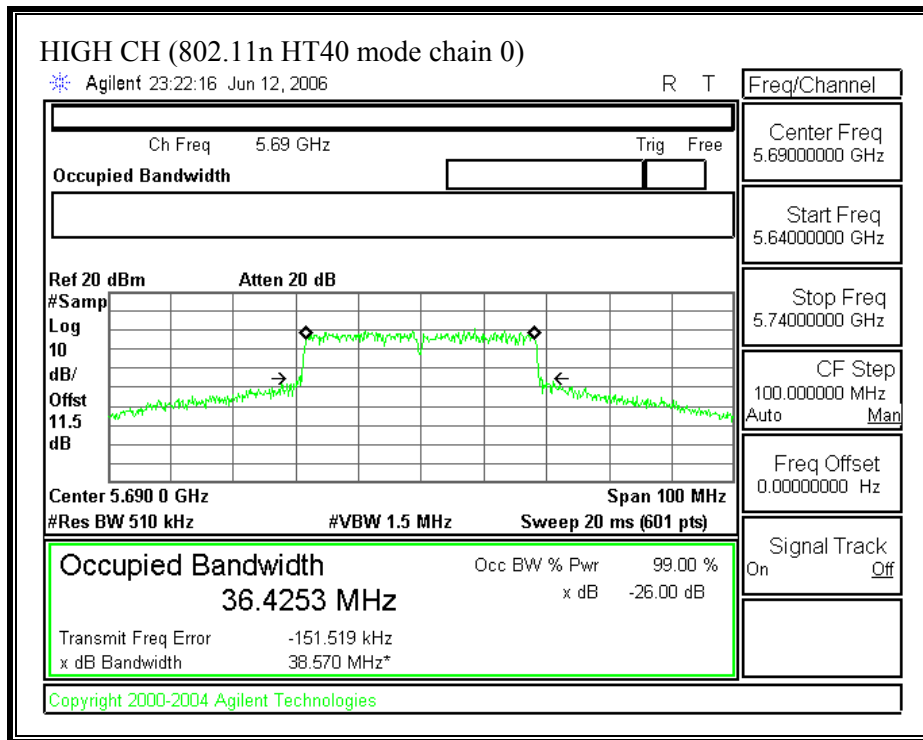

**(802.11 HT40 MODE CHAIN 2)**

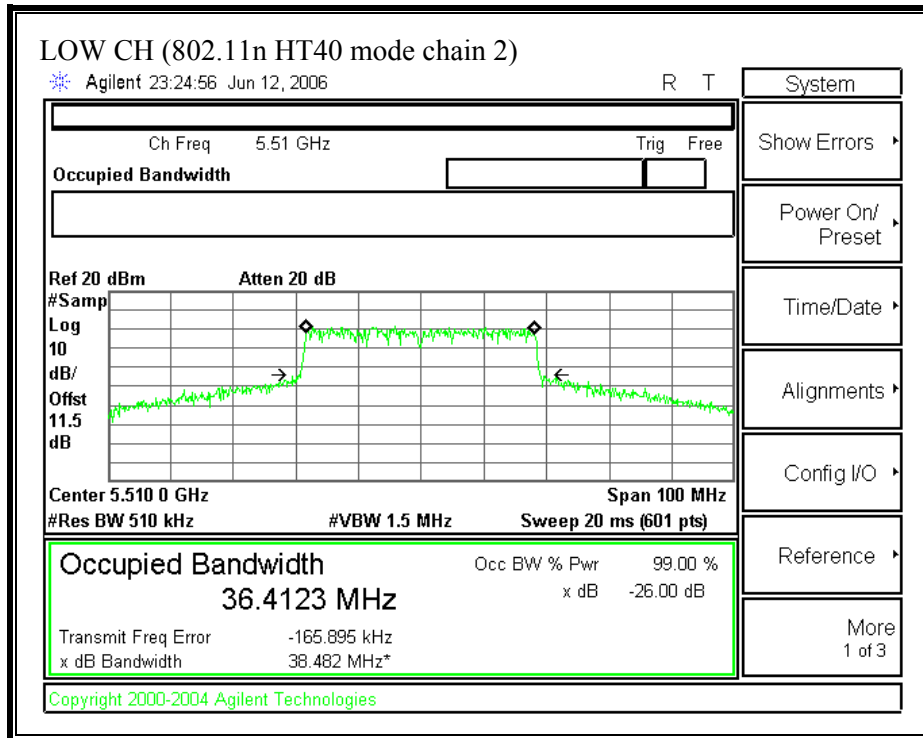

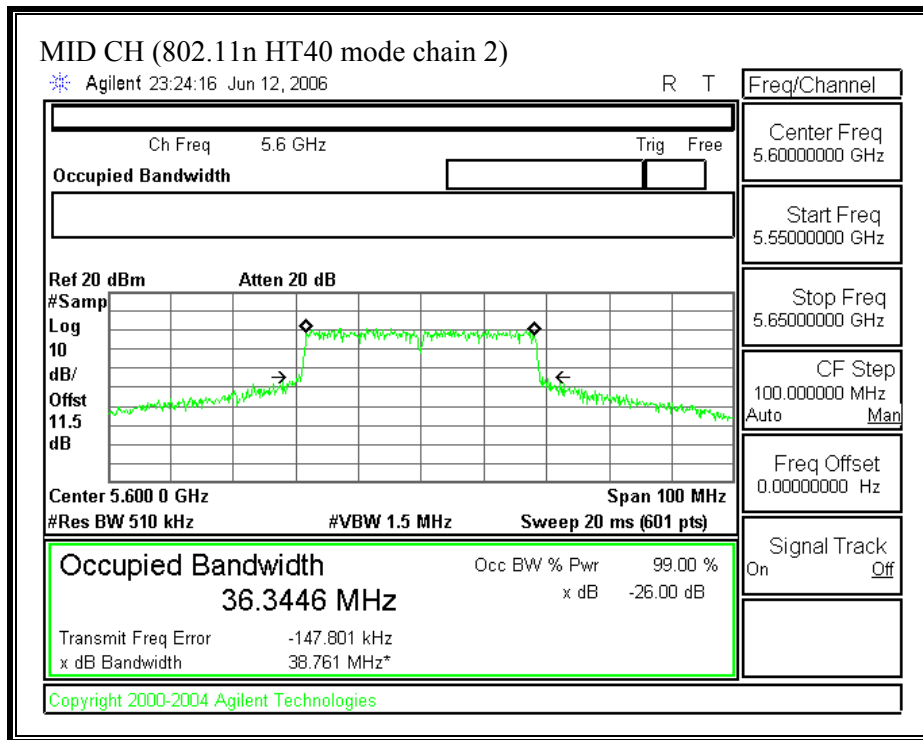

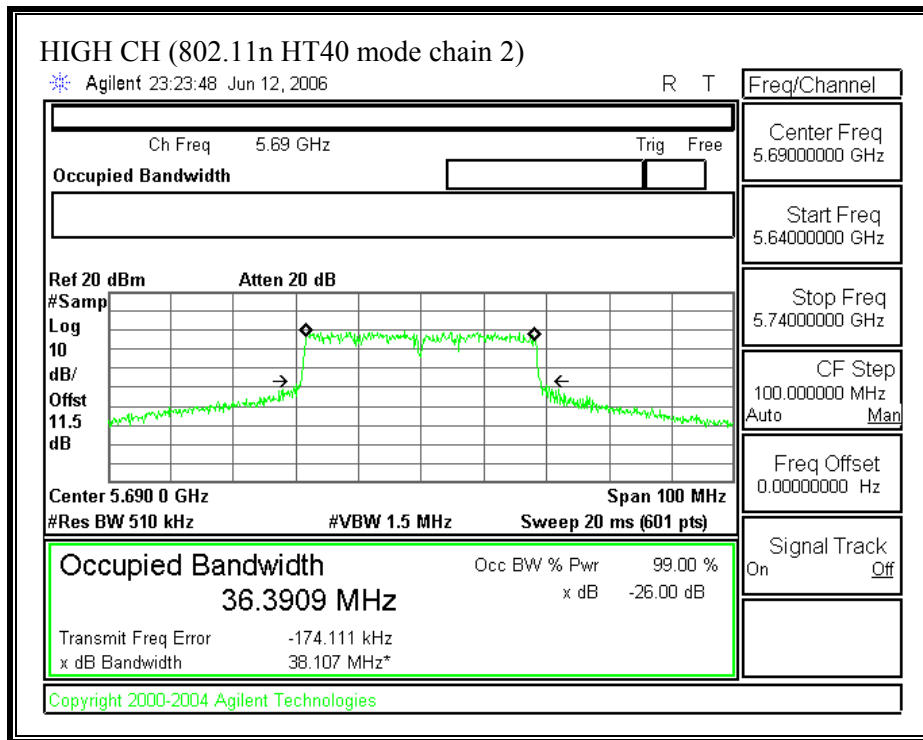

## 7.1.2. MAXIMUM POWER

### LIMIT

§15.407 (a) (2) For the 5.47–5.725 GHz band, the peak transmit power over the frequency band of operation shall not exceed the lesser of 250 mW or 11 dBm + 10 log B, where B is the 26-dB emission bandwidth in MHz. If transmitting antennas of directional gain greater than 6 dBi are used, both the peak transmit power and the peak power spectral density shall be reduced by the amount in dB that the directional gain of the antenna exceeds 6 dBi.

### TEST PROCEDURE

The test is performed in accordance with FCC Public Notice: APPENDIX A Guidelines for Assessing Unlicensed National Information Infrastructure (U-NII) Devices – Part 15, Subpart E, August 2002.

The transmitter output operates continuously therefore Method # 1 is used.

Each chain is measured separately and the total power is calculated using:

Total Power =  $10 \log (10^{\text{Chain 0 Power} / 10} + 10^{\text{Chain 2 Power} / 10})$

No non-compliance noted:

<b>Fixed Limit (dBm)</b>	24
<b>Antenna Gain (dBi)</b>	5.34
<b>10 Log (# Tx Chains)</b>	3.01
<b>Effective Legacy Gain</b>	8.35

<b>Mode Chan</b>	<b>Freq (MHz)</b>	<b>10LogB (dBm)</b>	<b>11+10LogB Limit (dBm)</b>	<b>Limit (dBm)</b>	<b>Chain 0 Power (dBm)</b>	<b>Chain 2 Power (dBm)</b>	<b>Total Power (dBm)</b>	<b>Margin (dB)</b>
------------------	-------------------	---------------------	------------------------------	--------------------	----------------------------	----------------------------	--------------------------	--------------------

802.11a Mode

Low	5500	13.18	24.18	21.65	15.54	15.45	18.51	-3.14
Mid	5600	12.87	23.87	21.52	15.56	14.91	18.26	-3.26
High	5700	12.67	23.67	21.32	15.44	15.07	18.27	-3.05

802.11n HT20 Mode

Low	5500	13.19	24.19	24.00	17.64	17.69	20.68	-3.32
Mid	5600	13.14	24.14	24.00	17.76	17.14	20.47	-3.53
High	5700	13.04	24.04	24.00	17.14	17.04	20.10	-3.90

802.11n HT40 Mode

Low	5510	15.85	26.85	24.00	17.52	17.55	20.55	-3.45
Mid	5600	15.97	26.97	24.00	17.73	16.82	20.31	-3.69
High	5690	15.86	26.86	24.00	17.26	17.19	20.24	-3.76



**(802.11a MODE CHAIN 0)**

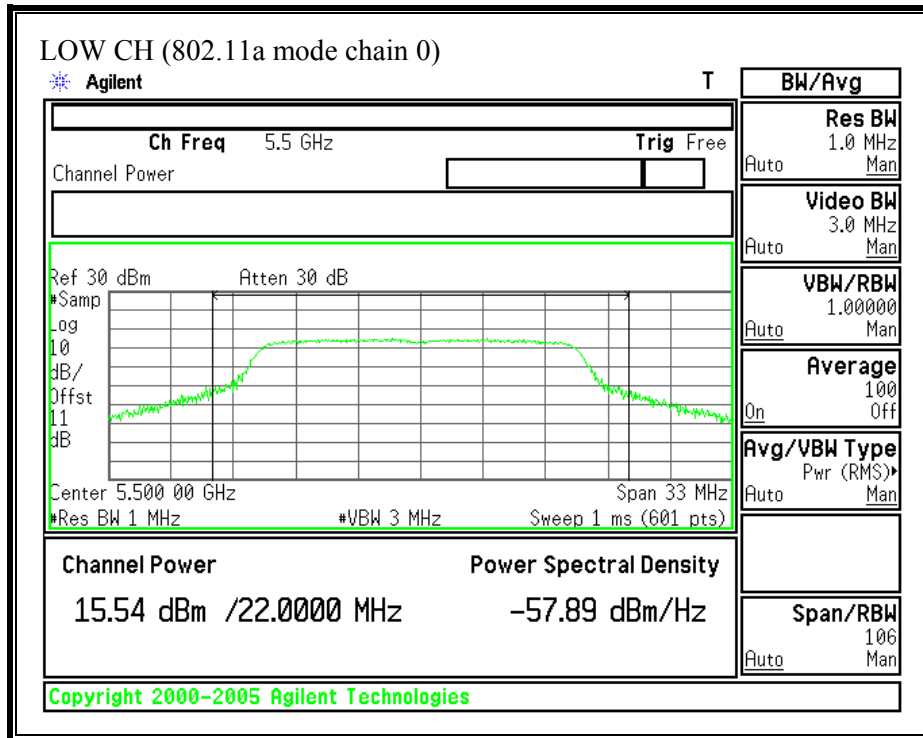

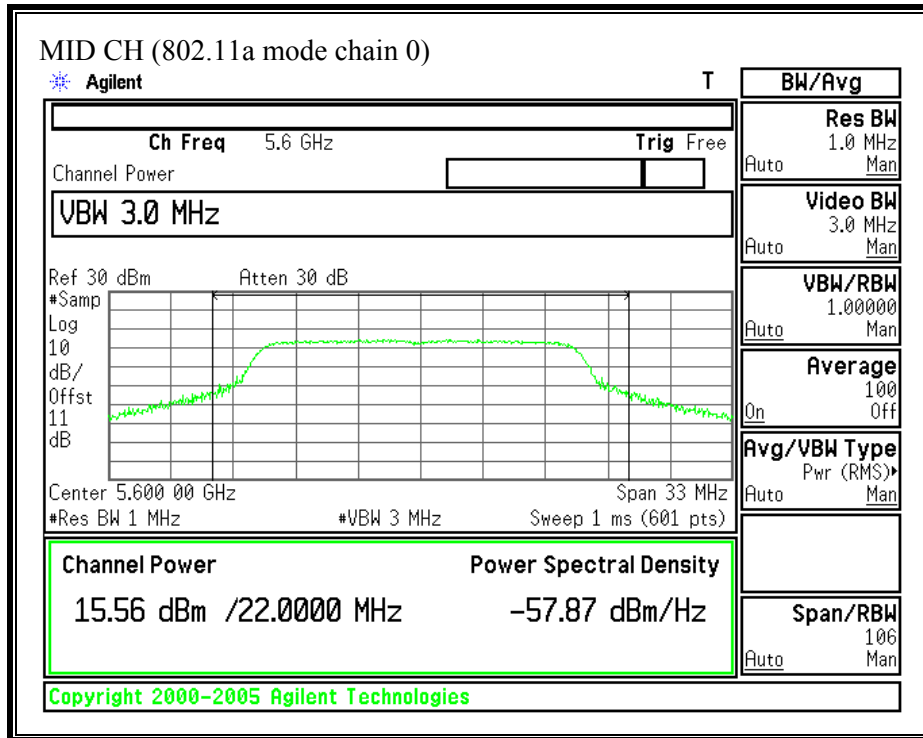

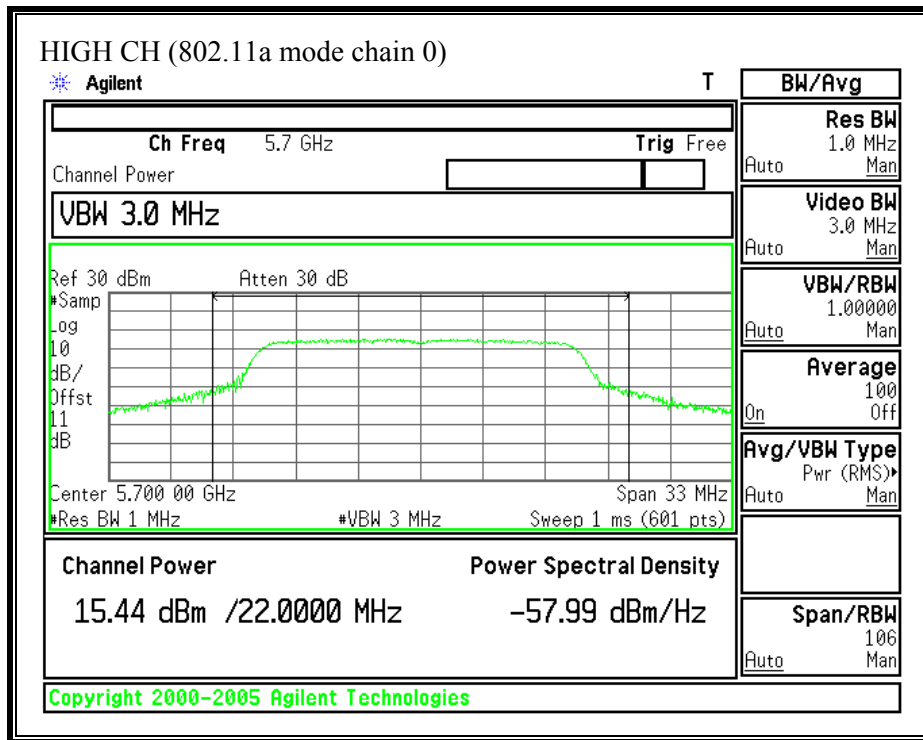

**(802.11a MODE CHAIN 2)**

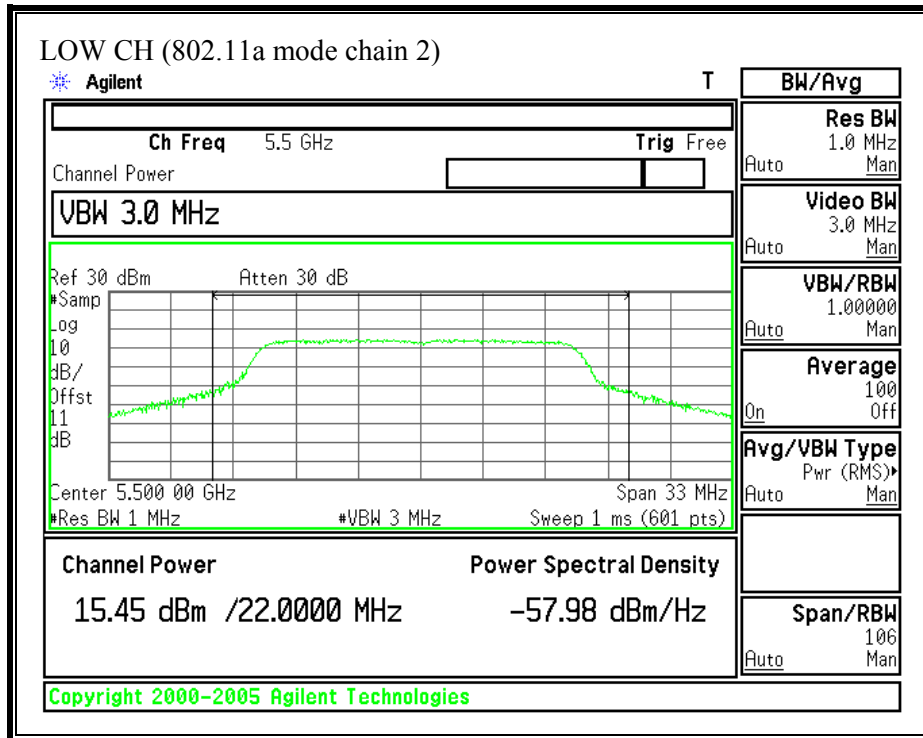

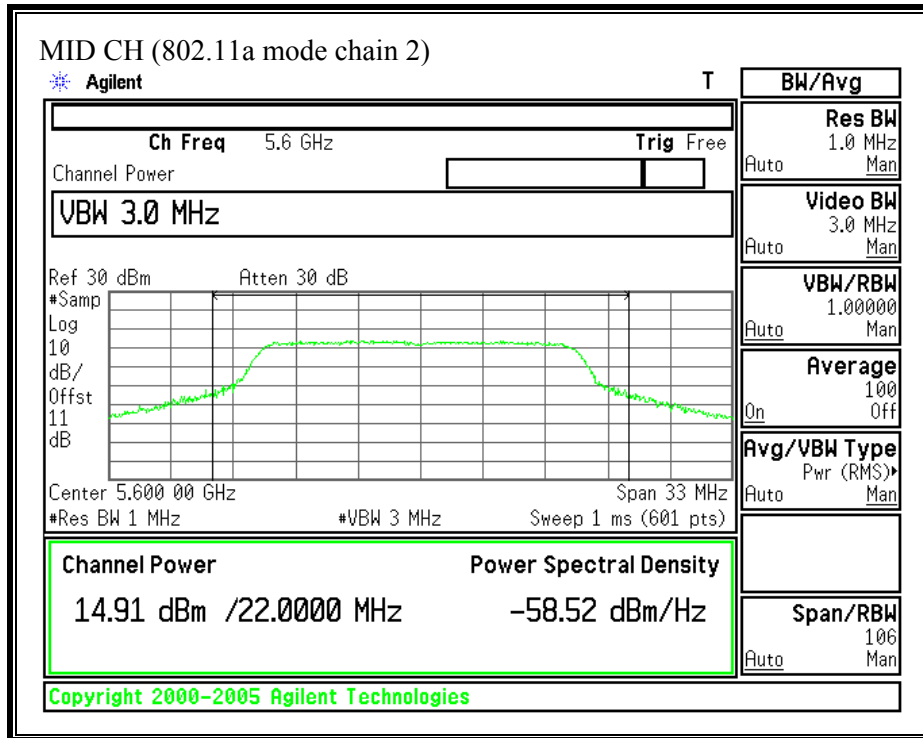

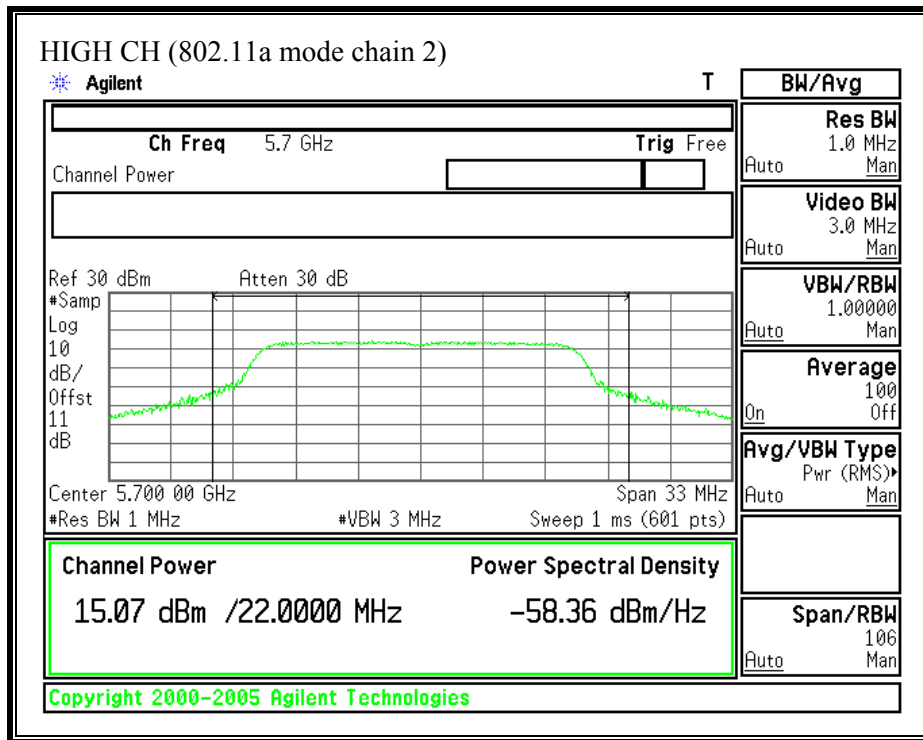

**(802.11n HT20 MODE CHAIN 0)**

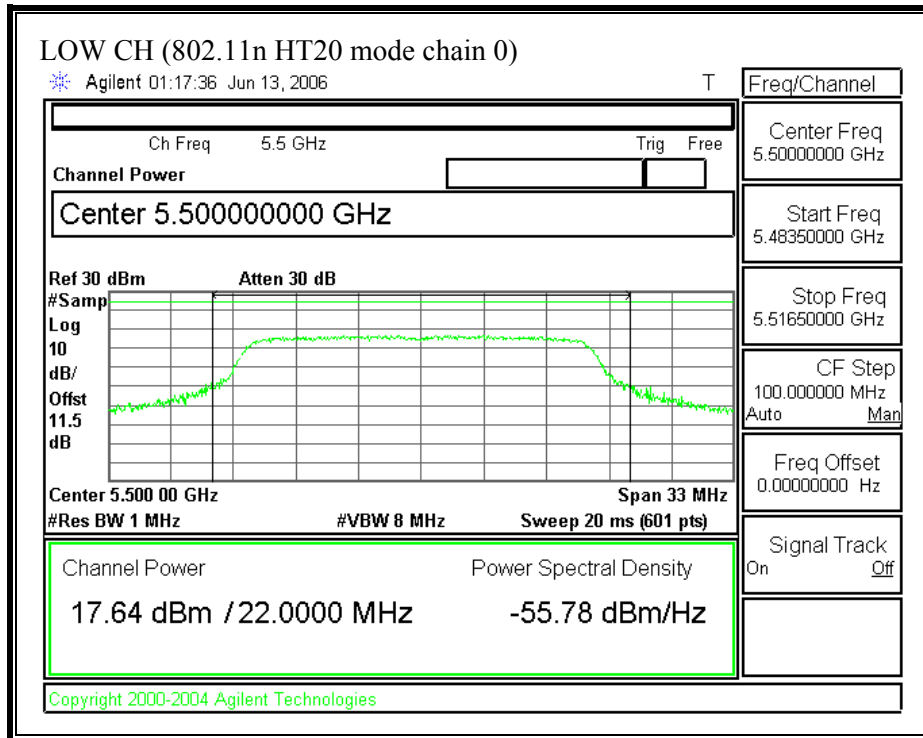

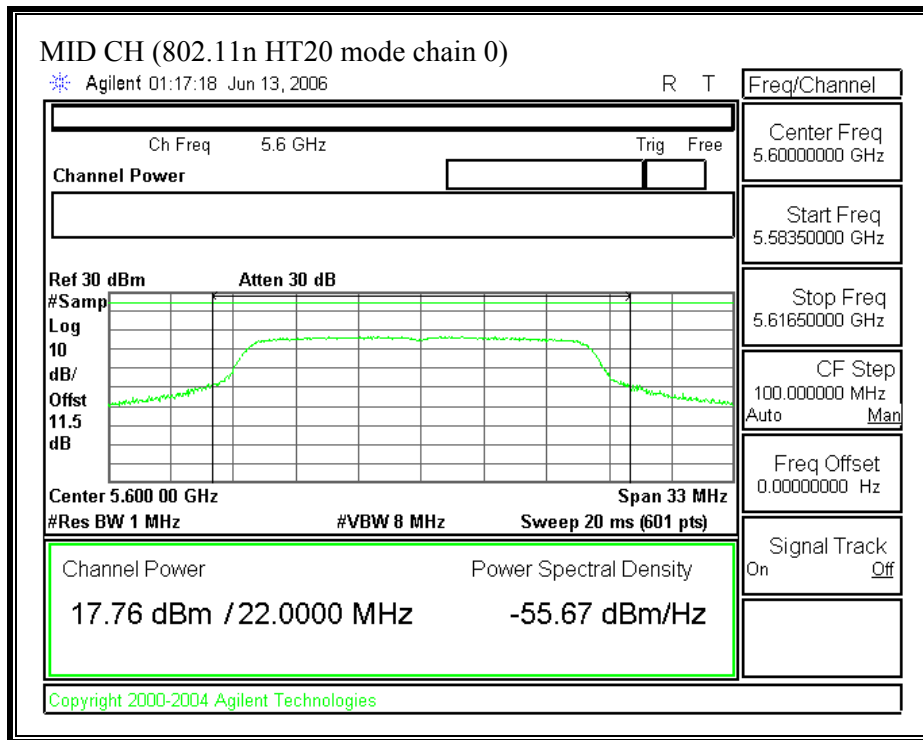



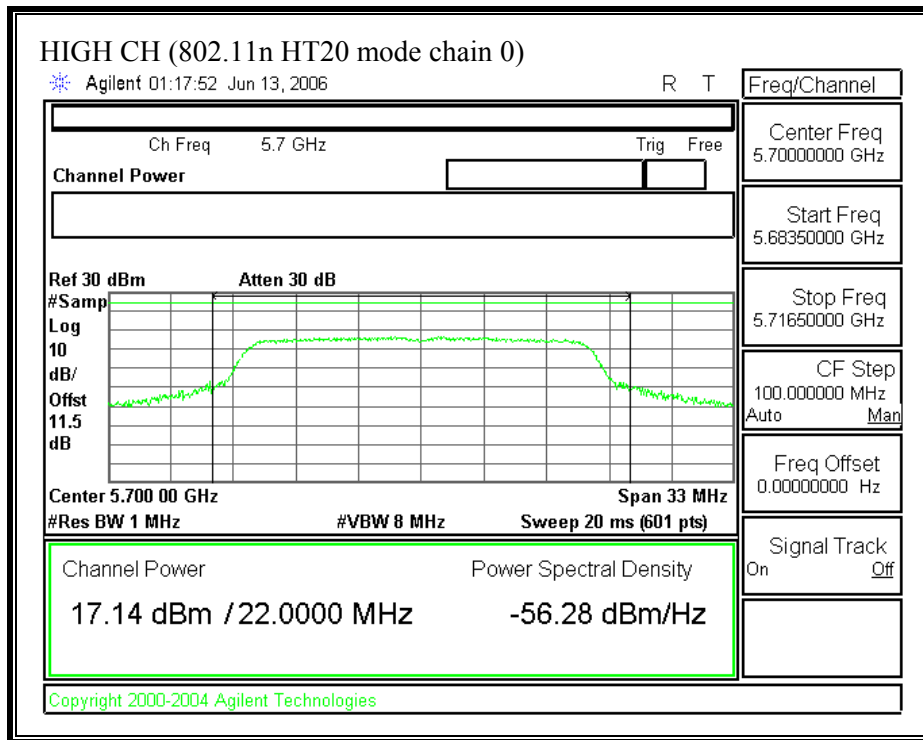

**(802.11 HT20 MODE CHAIN 2)**

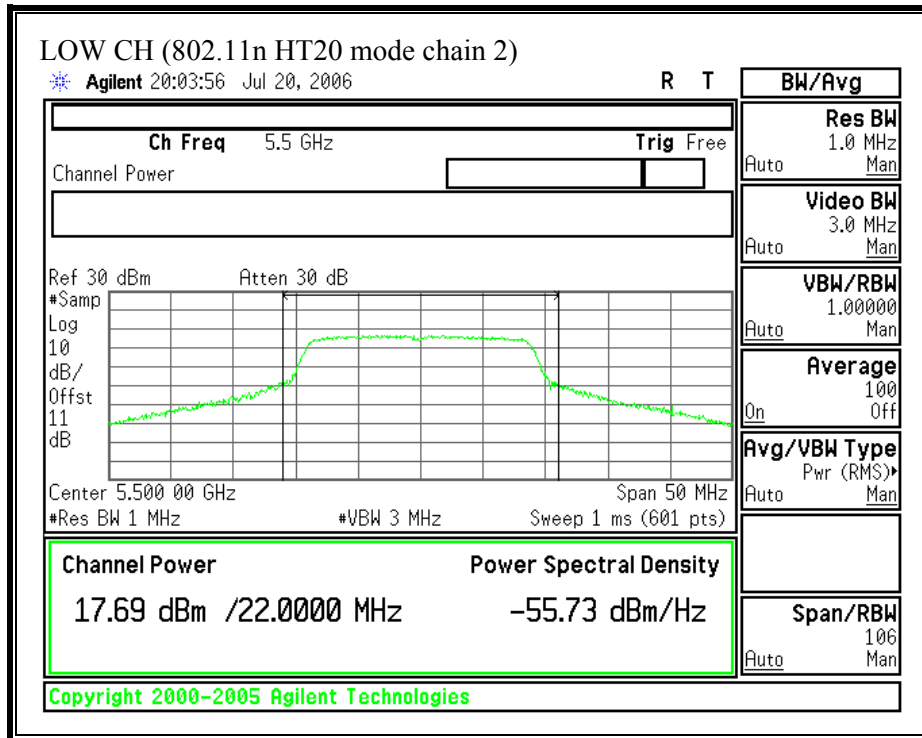

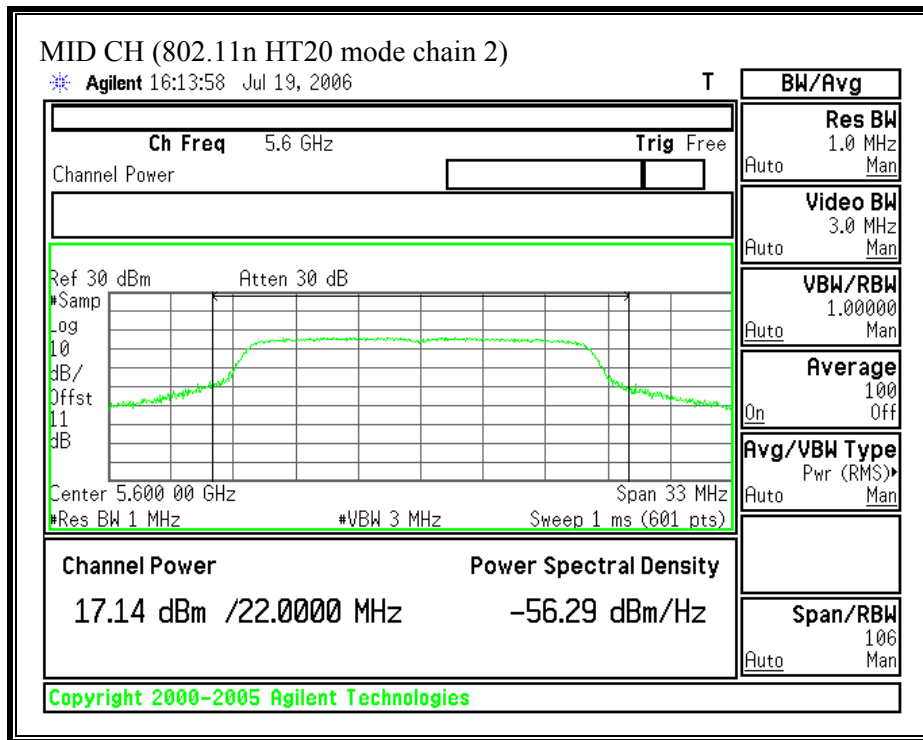

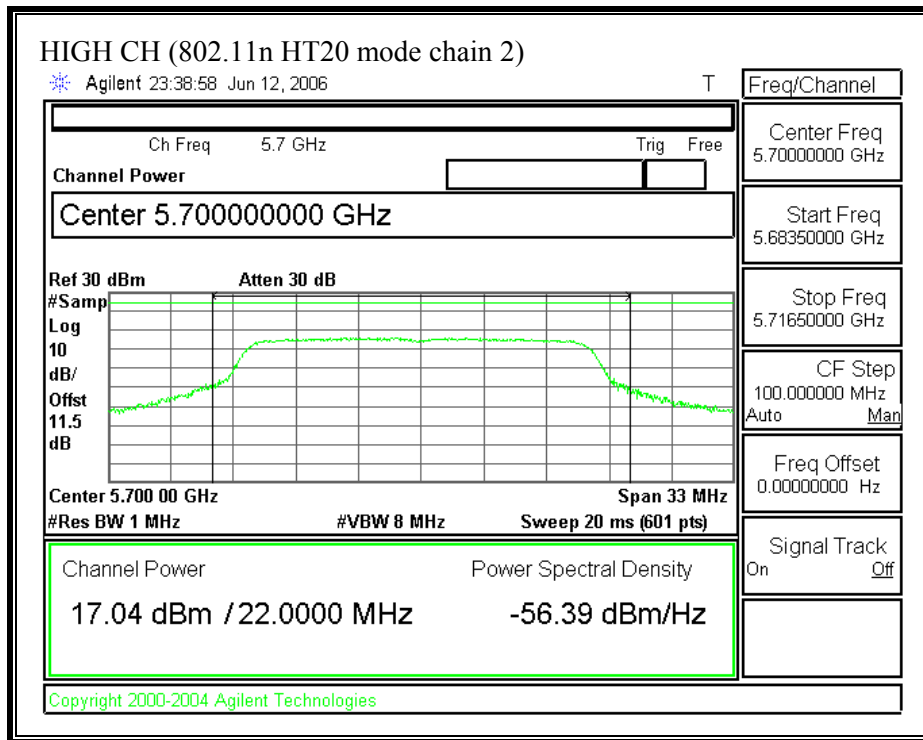

**(802.11 HT40 MODE CHAIN 0)**

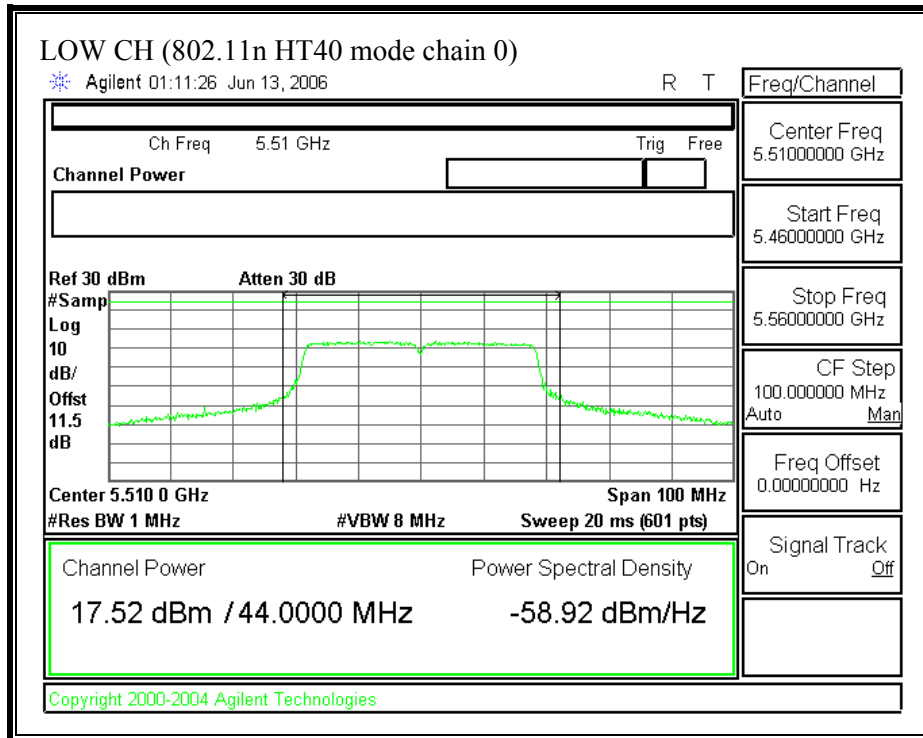

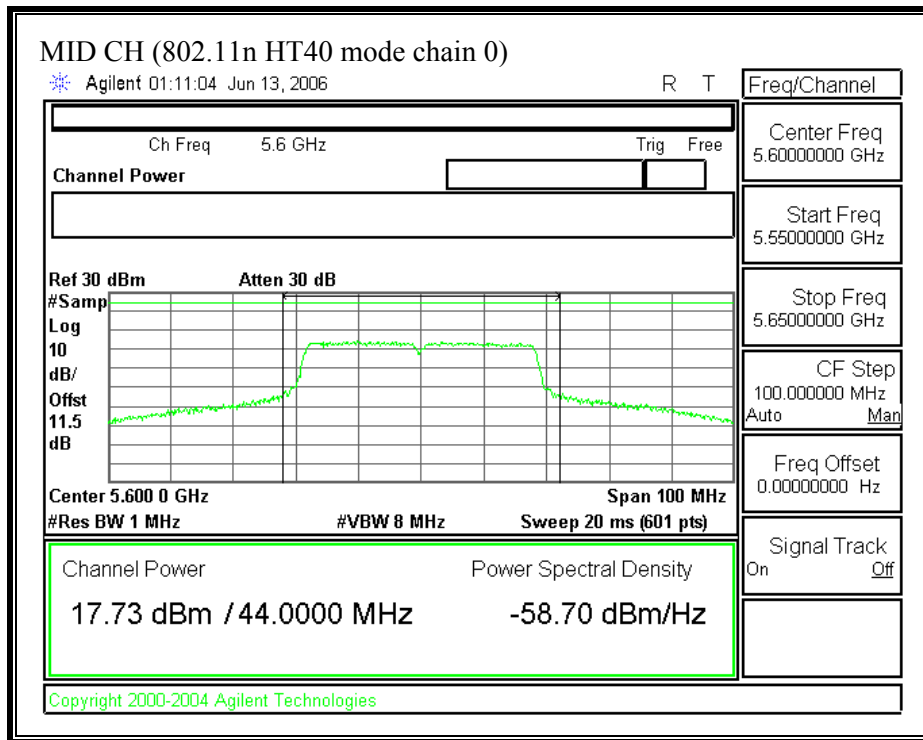

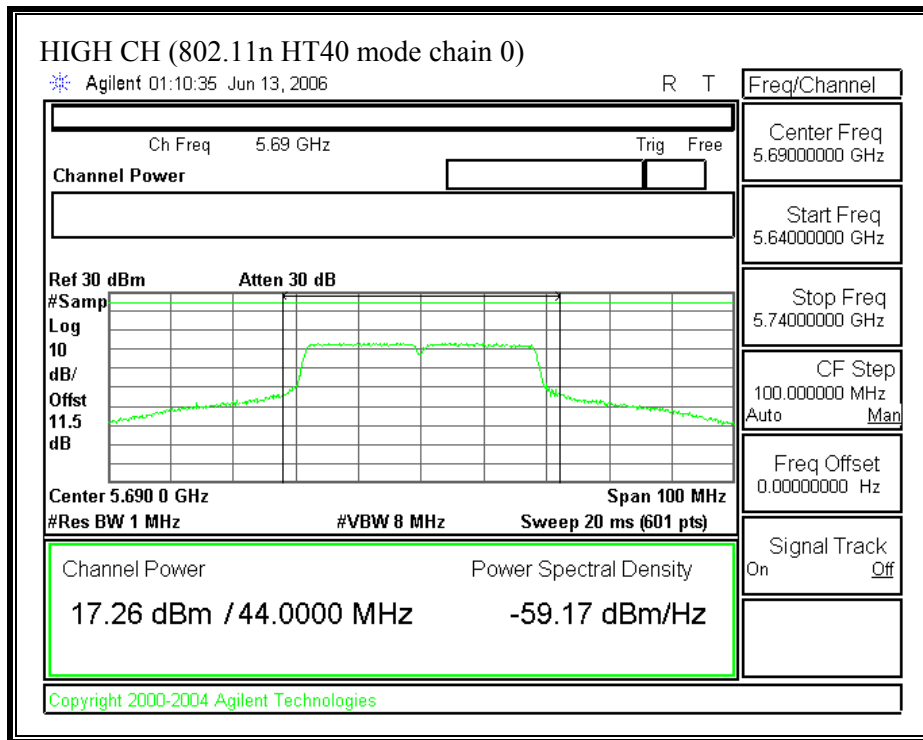

**(802.11 HT40 MODE CHAIN 2)**

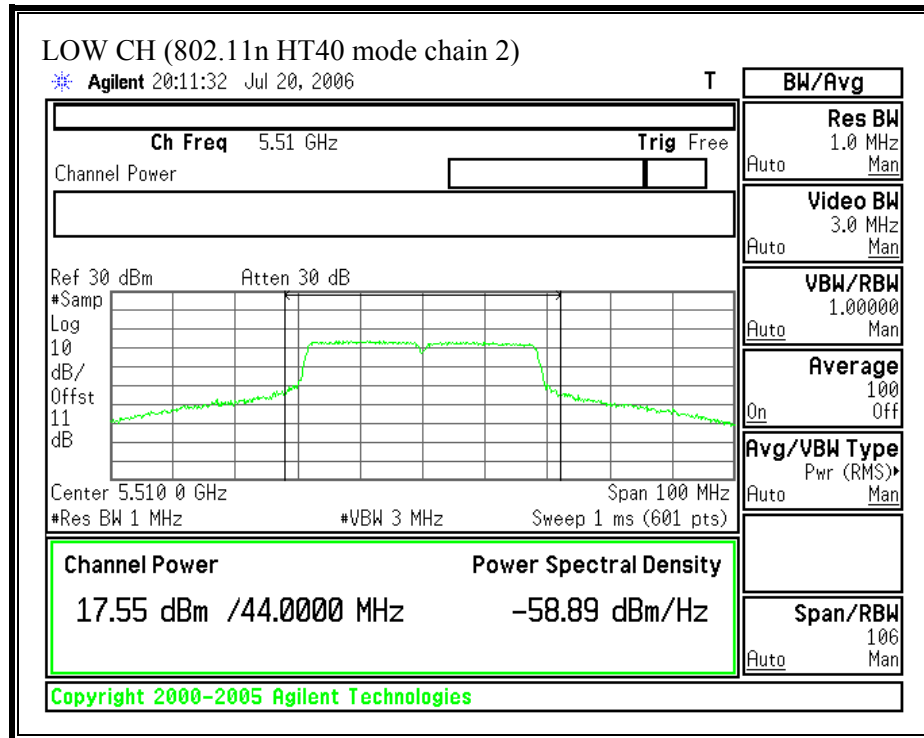



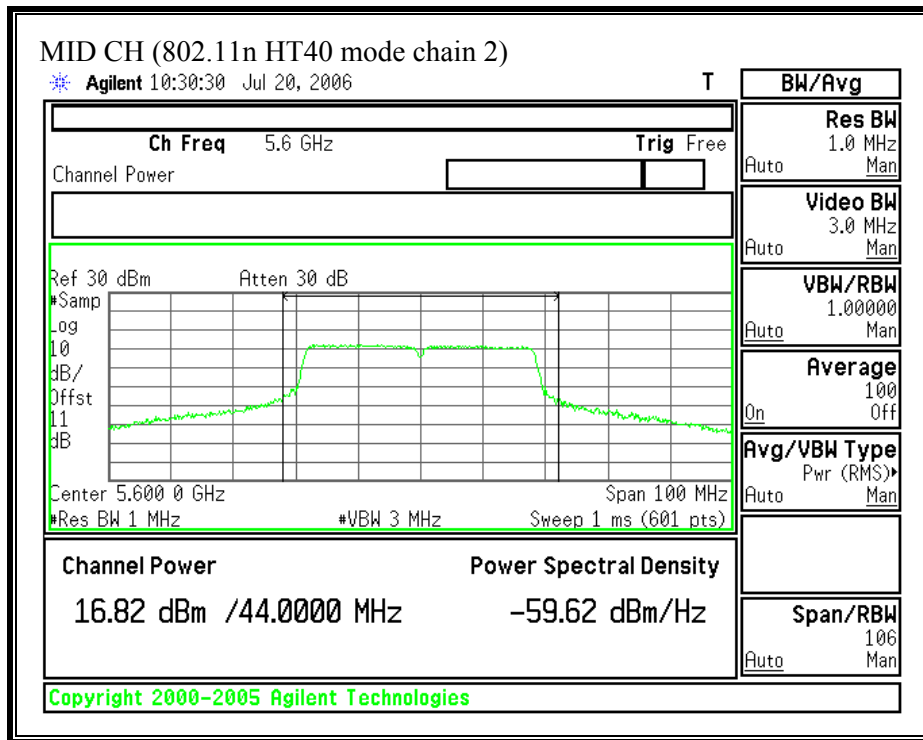

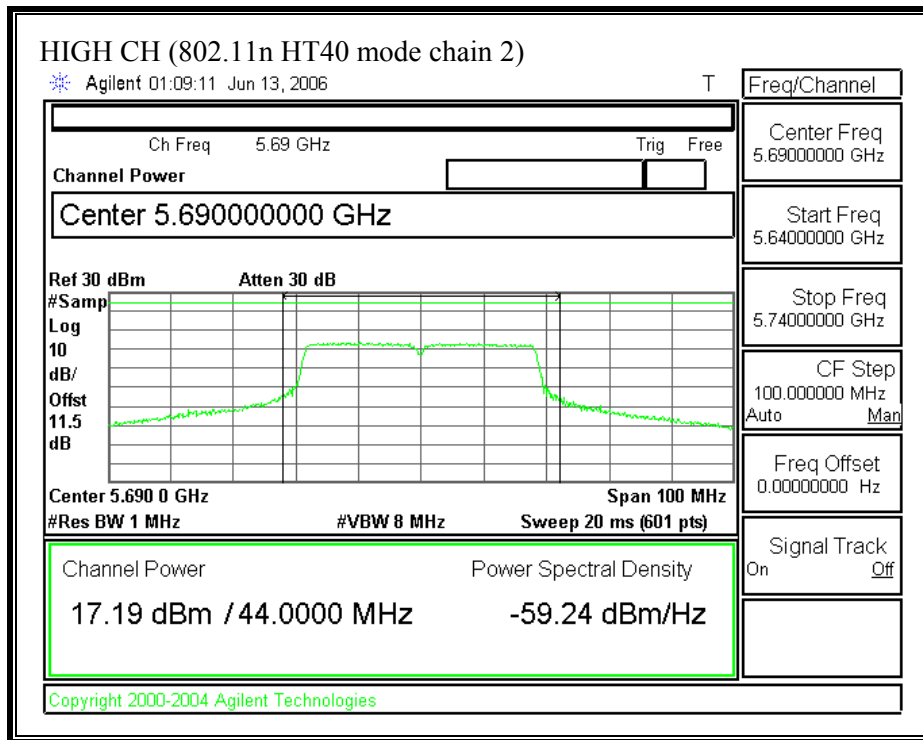

### **7.1.3. AVERAGE POWER**

#### **AVERAGE POWER LIMIT**

None; for reporting purposes only.

#### **TEST PROCEDURE**

The transmitter output is connected to a power meter.

Each chain is measured separately and the total power is calculated using:

Total Power =  $10 \log (10^{\text{Chain 0 Power} / 10} + 10^{\text{Chain 2 Power} / 10})$

**RESULTS**

No non-compliance noted:

The cable assembly insertion loss of 11.5 dB (including 10 dB pad and 1.5 dB cable) was entered as an offset in the power meter to allow for direct reading of power.

Mode Channel	Frequency (MHz)	Average Power Chain 0 (dBm)	Average Power Chain 2 (dBm)	Average Power Total (dBm)
--------------	-----------------	-----------------------------	-----------------------------	---------------------------

802.11a Mode

Low	5500	15.6	15.5	18.6
Middle	5600	15.7	15.1	18.4
High	5700	15.6	15.2	18.4

802.11n HT20 Mode

Low	5500	17.7	17.6	20.7
Middle	5600	17.6	17.3	20.4
High	5700	17.1	17.0	20.1

802.11n HT40 Mode

Low	5510	17.3	17.9	20.6
Middle	5600	17.8	17.0	20.4
High	5690	17.0	17.1	20.1

## 7.1.4. PEAK POWER SPECTRAL DENSITY

### LIMIT

§15.407 (a) (2) For the 5.47–5.725 GHz band, the peak power spectral density shall not exceed 11 dBm in any 1-MHz band. If transmitting antennas of directional gain greater than 6 dBi are used, both the peak transmit power and the peak power spectral density shall be reduced by the amount in dB that the directional gain of the antenna exceeds 6 dBi.

### TEST PROCEDURE

The test is performed in accordance with FCC Public Notice: APPENDIX A Guidelines for Assessing Unlicensed National Information Infrastructure (U-NII) Devices – Part 15, Subpart E, August 2002. PPSD method #2 was used.

Each chain is measured separately and the total PPSD is calculated using:

Total PPSD =  $10 \log (10^{(\text{Chain 0 PPSD} / 10)} + 10^{(\text{Chain 2 PPSD} / 10)})$

**RESULTS**

No non-compliance noted:

<b>Antenna Gain (dBi)</b>	5.34
<b>10 Log (# Tx Chains)</b>	3.01
<b>Effective Legacy Gain</b>	8.35

<b>Mode Channel</b>	<b>Frequency (MHz)</b>	<b>PPSD Chain 0 (dBm)</b>	<b>PPSD Chain 2 (dBm)</b>	<b>PPSD Total (dBm)</b>	<b>Limit (dBm)</b>	<b>Margin (dB)</b>
---------------------	------------------------	---------------------------	---------------------------	-------------------------	--------------------	--------------------

802.11a Mode

Low	5500	4.40	4.73	7.58	8.65	-1.07
Middle	5600	4.28	4.50	7.40	8.65	-1.25
High	5700	4.69	4.55	7.63	8.65	-1.02

802.11n HT20 Mode

Low	5500	6.20	8.15	10.29	11.00	-0.71
Middle	5600	6.51	6.94	9.74	11.00	-1.26
High	5700	6.05	5.55	8.82	11.00	-2.18

802.11n HT40 Mode

Low	5510	3.05	4.77	7.00	11.00	-4.00
Middle	5600	3.40	4.21	6.83	11.00	-4.17
High	5690	2.68	2.77	5.74	11.00	-5.26

**(802.11a MODE CHAIN 0)**

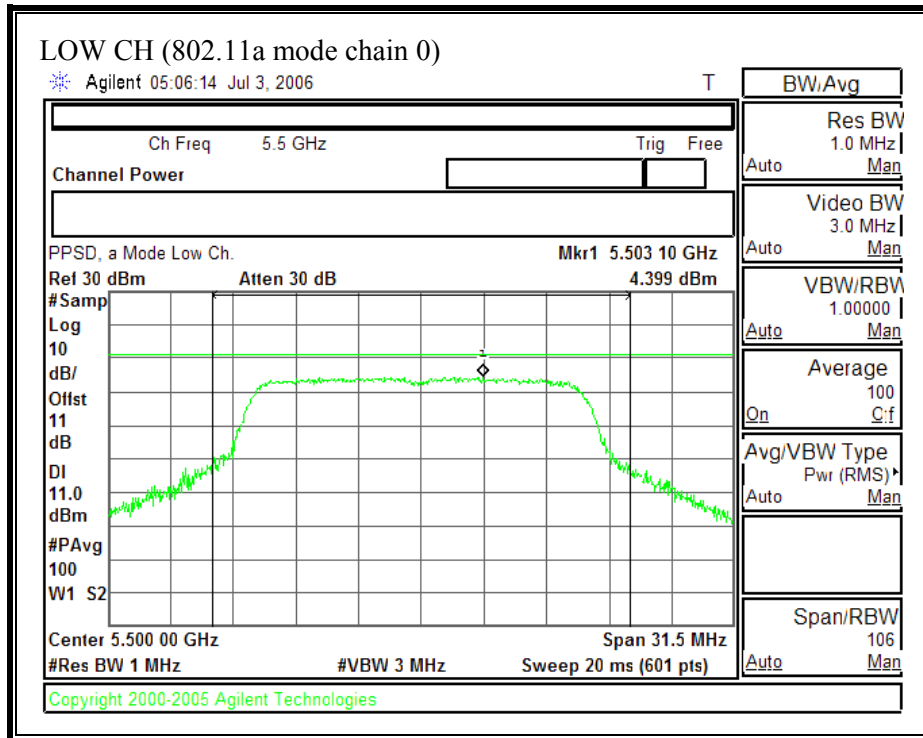

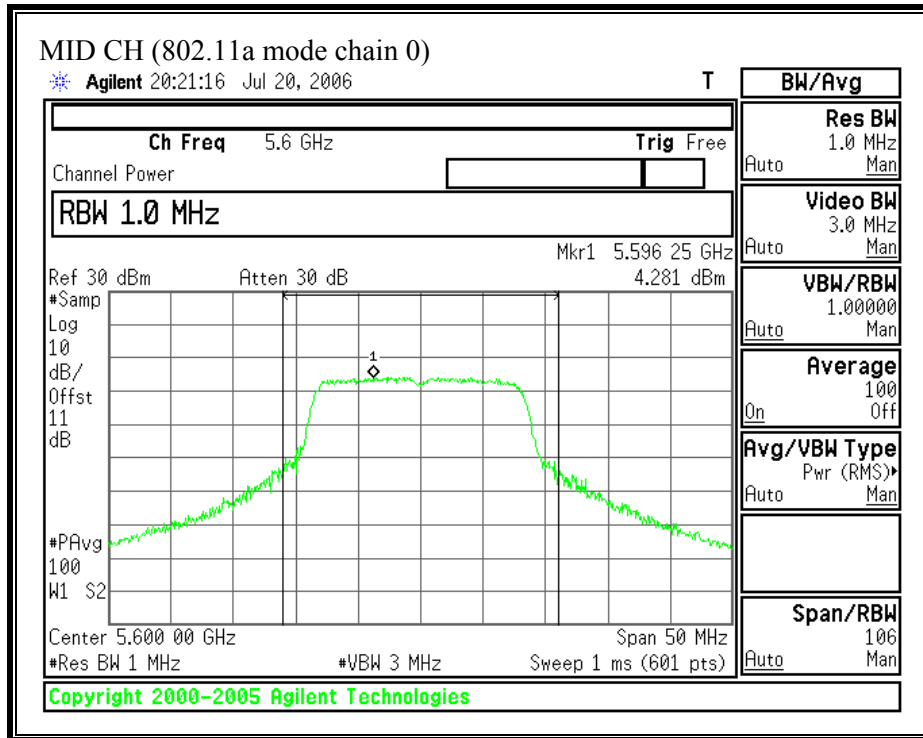



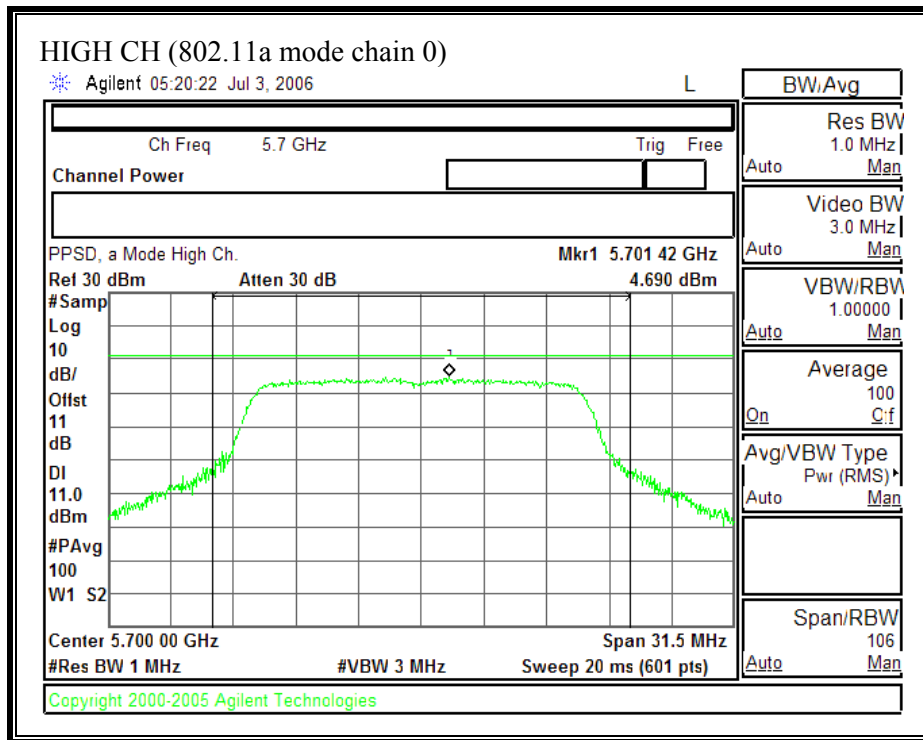

**(802.11a MODE CHAIN 2)**

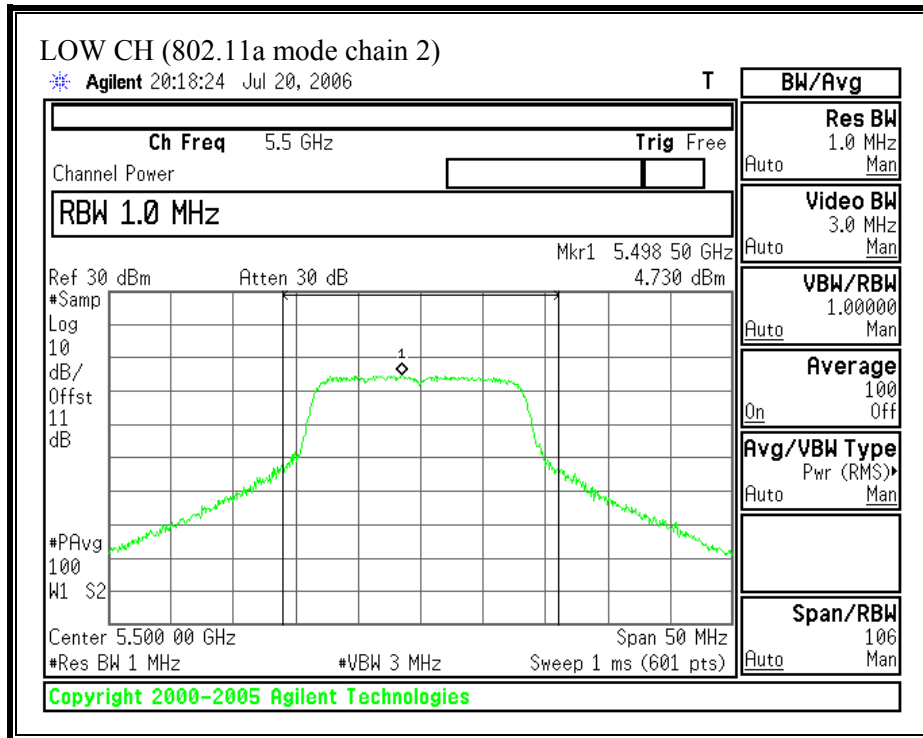

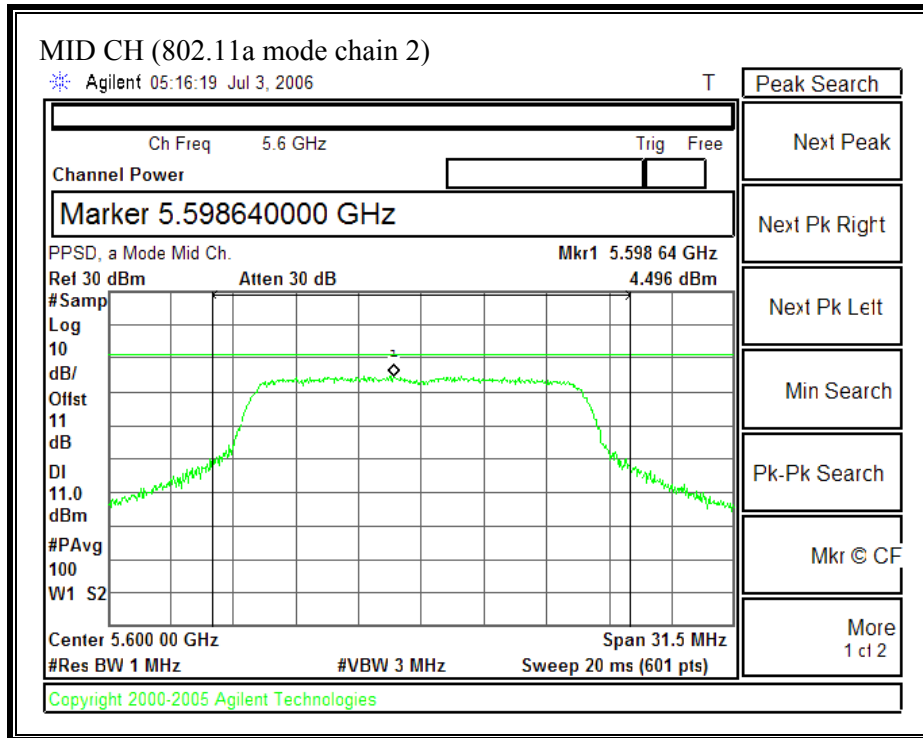

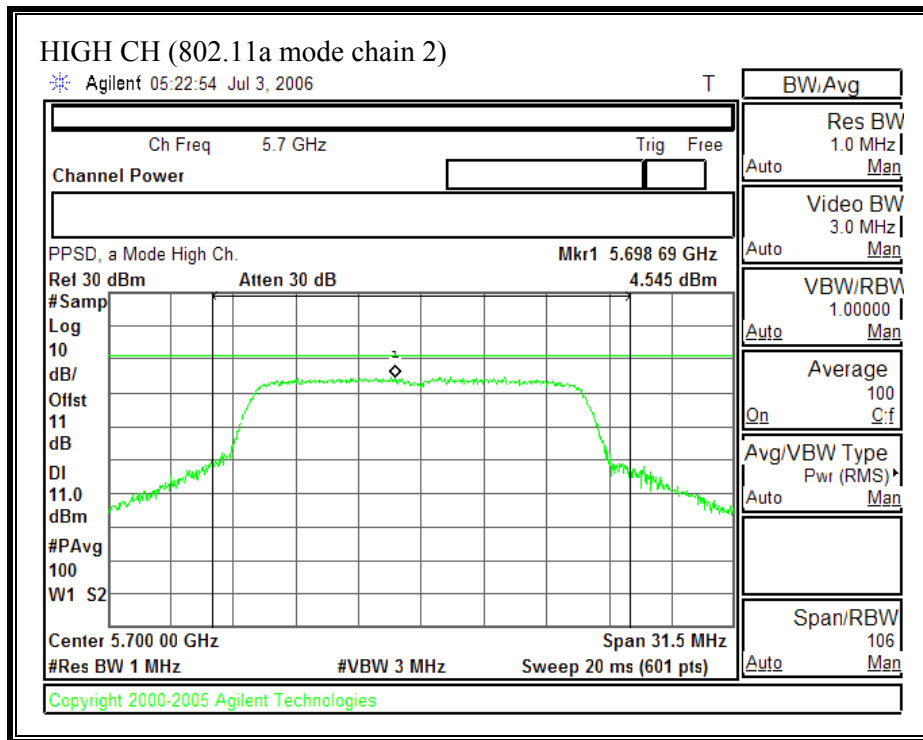

**(802.11n HT20 MODE CHAIN 0)**

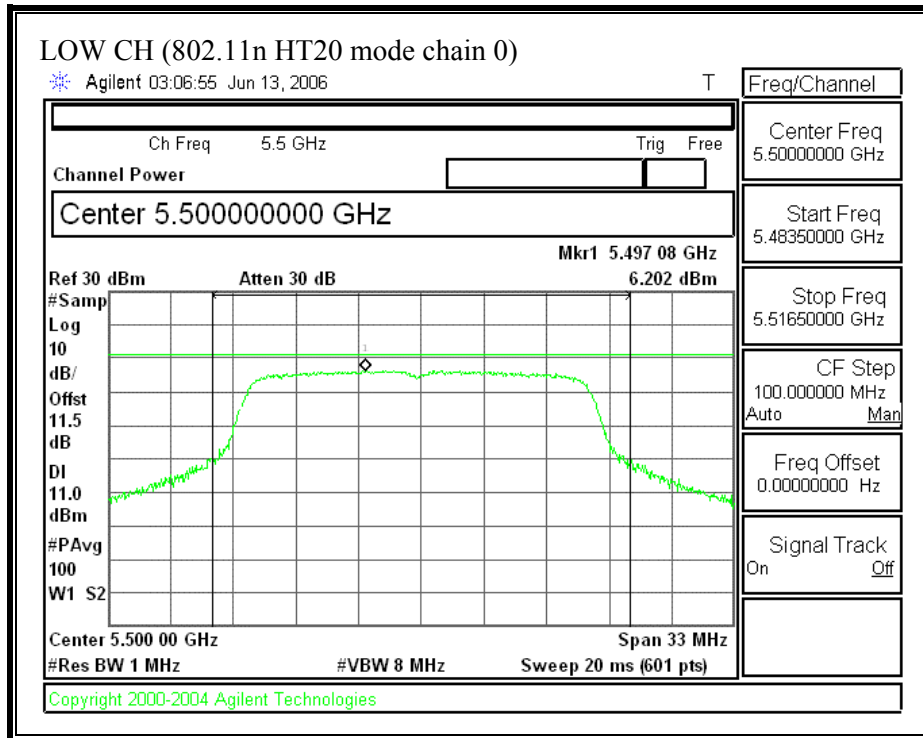

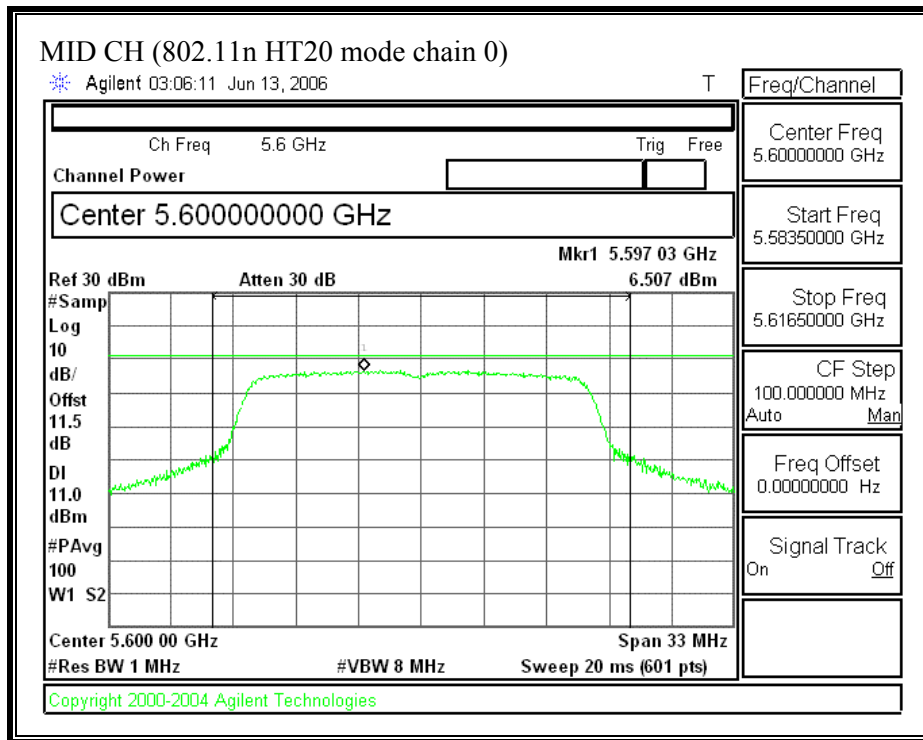

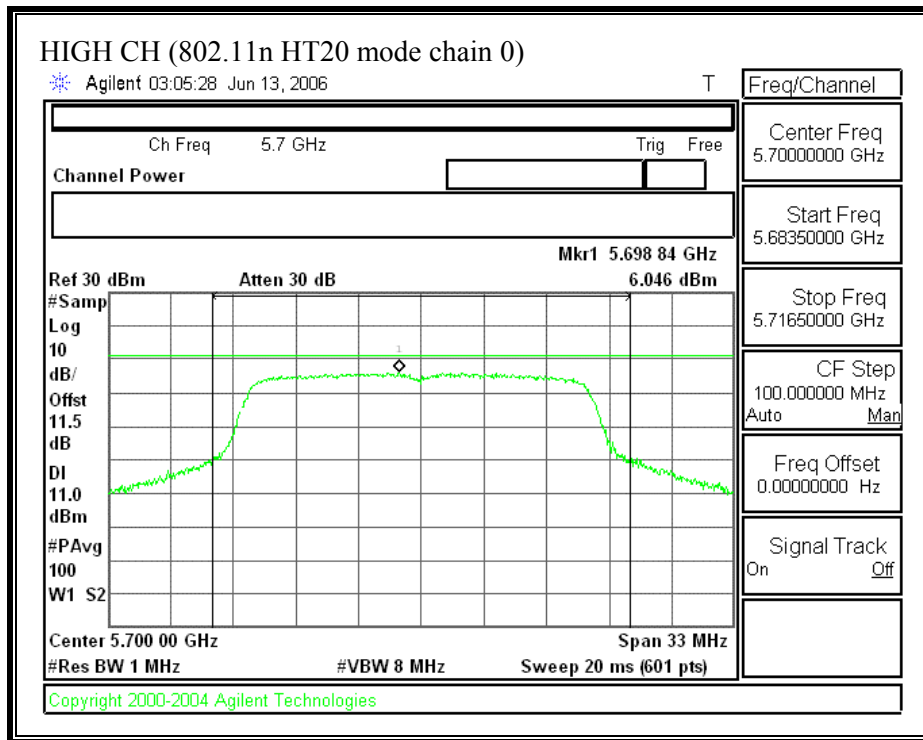

**(802.11 HT20 MODE CHAIN 2)**

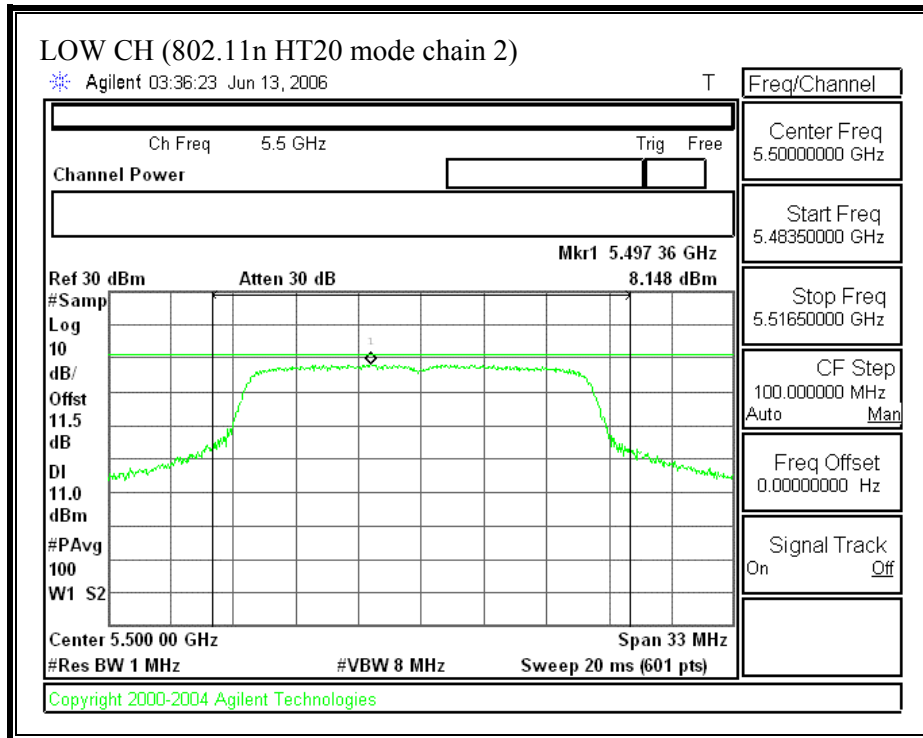



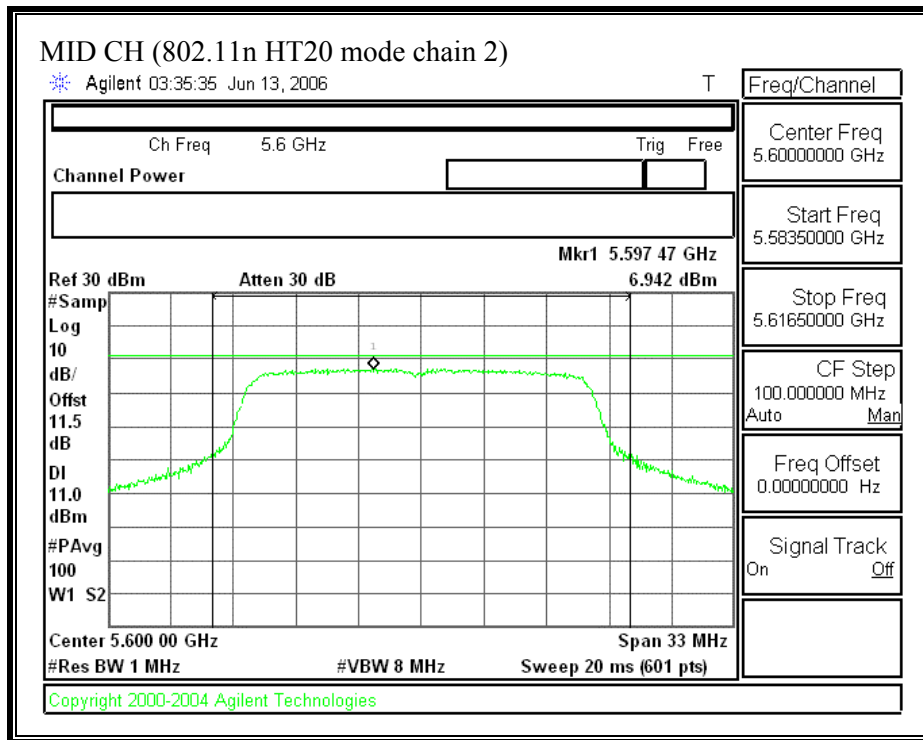

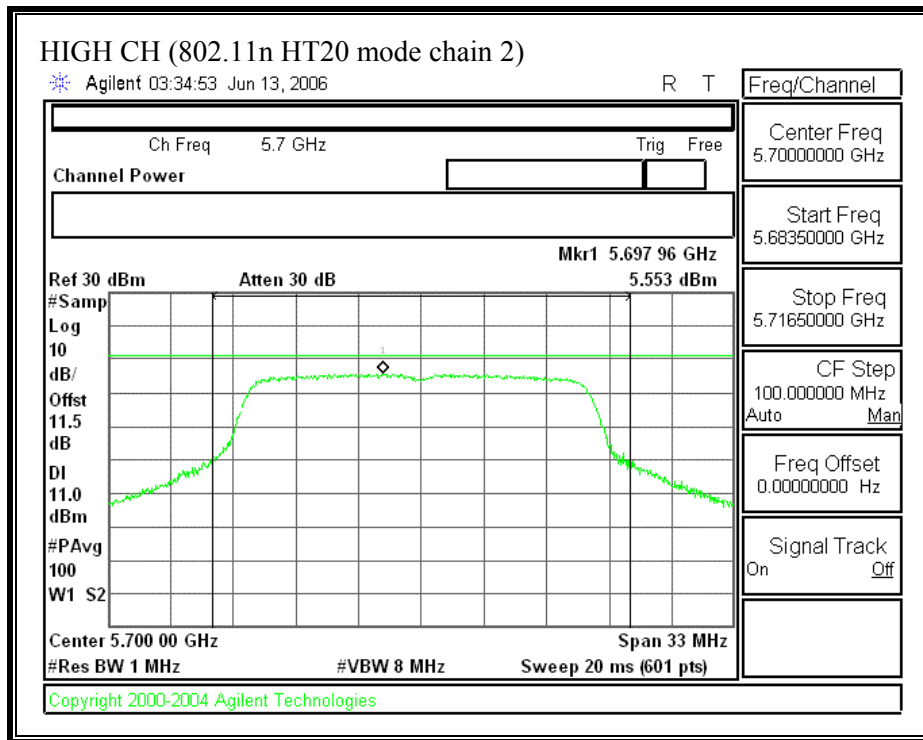

**(802.11 HT40 MODE CHAIN 0)**

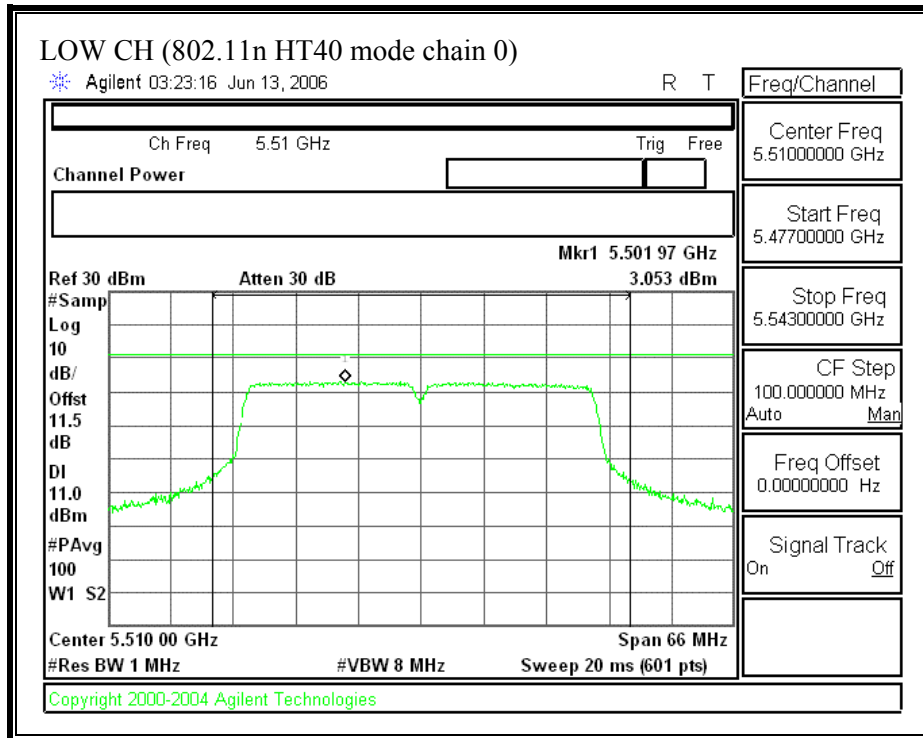

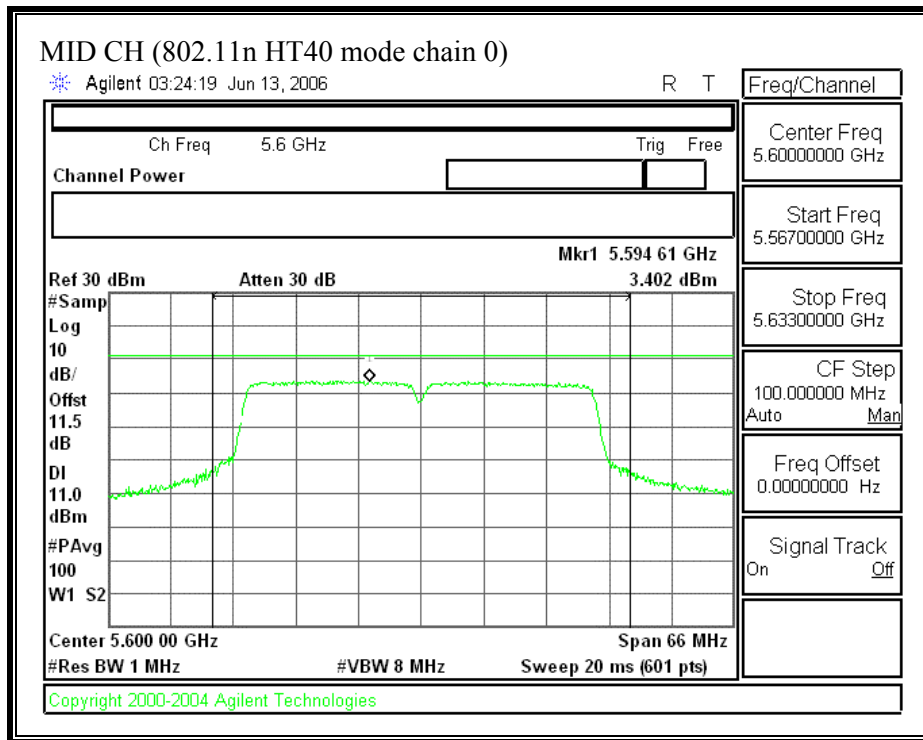

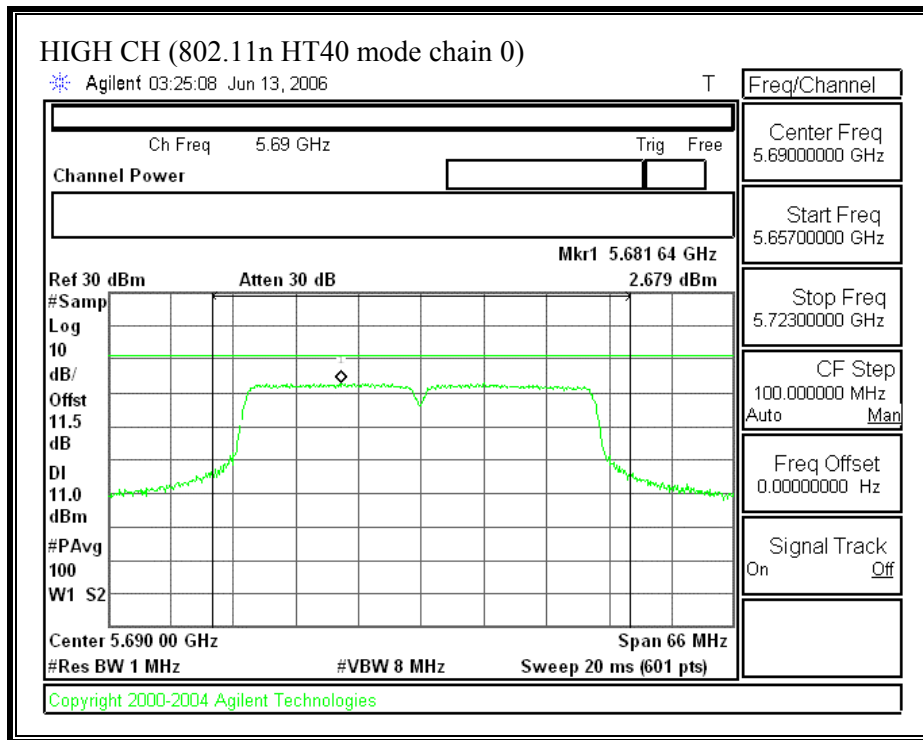

**(802.11 HT40 MODE CHAIN 2)**

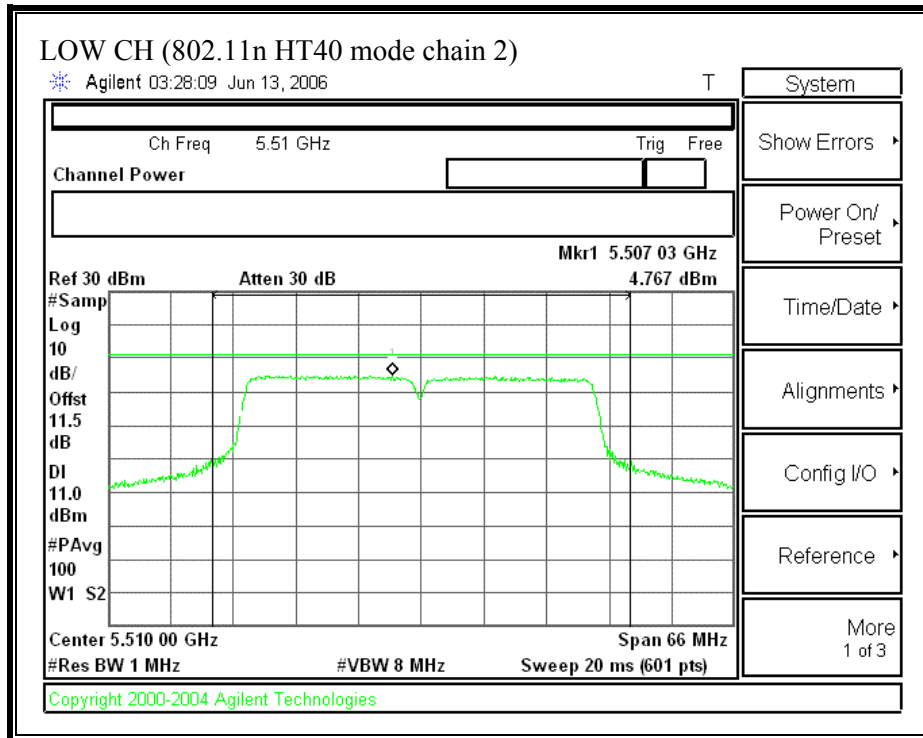

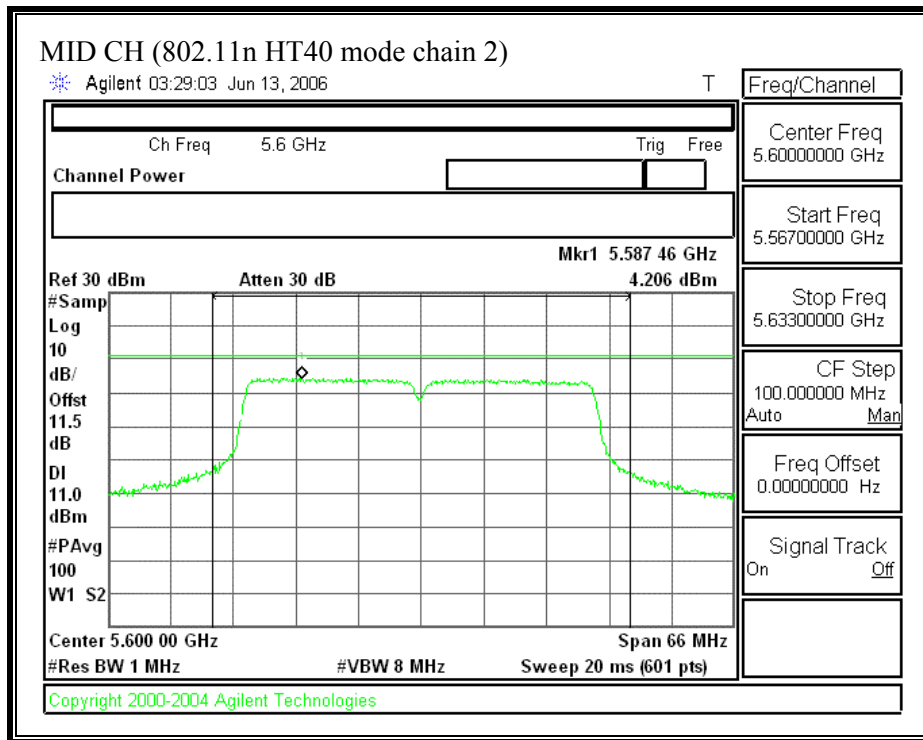

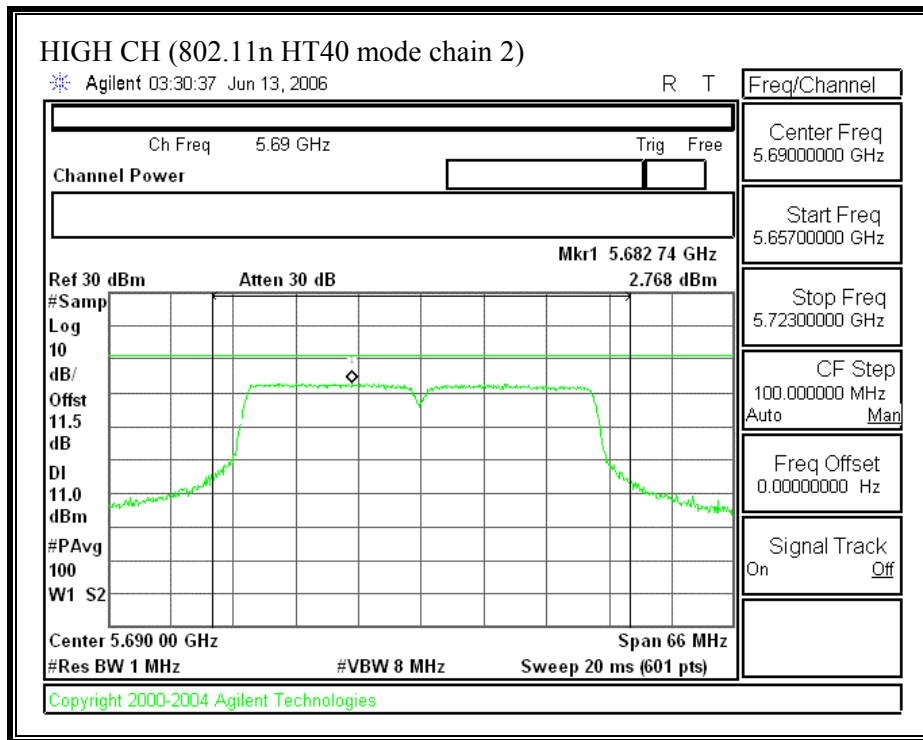



### **7.1.5. PEAK EXCURSION**

#### **LIMIT**

§15.407 (a) (6) The ratio of the peak excursion of the modulation envelope (measured using a peak hold function) to the peak transmit power (measured as specified above) shall not exceed 13 dB across any 1 MHz bandwidth or the emission bandwidth whichever is less.

#### **TEST PROCEDURE**

The test is performed in accordance with FCC Public Notice: APPENDIX A Guidelines for Assessing Unlicensed National Information Infrastructure (U-NII) Devices – Part 15, Subpart E, August 2002.

Since Method # 1 was used for peak power measurements, Method # 1 settings are used for the second PPSD trace.

**RESULTS**

No non-compliance noted:

<b>Mode Channel</b>	<b>Frequency (MHz)</b>	<b>Peak Excursion Chain 0 (dBm)</b>	<b>Peak Excursion Chain 2 (dBm)</b>	<b>Limit (dBm)</b>	<b>Worst Case Margin (dB)</b>
---------------------	------------------------	-------------------------------------	-------------------------------------	--------------------	-------------------------------

802.11a Mode

Low	5500	9.76	10.90	13	-2.10
Middle	5600	9.23	10.15	13	-2.85
High	5700	9.93	10.01	13	-2.99

802.11n HT20 Mode

Low	5500	9.88	10.69	13	-2.31
Middle	5600	9.54	8.84	13	-3.46
High	5700	8.94	7.77	13	-4.06

802.11n HT40 Mode

Low	5510	10.37	10.99	13	-2.01
Middle	5600	9.43	10.12	13	-2.88
High	5690	9.39	11.44	13	-1.56

**(802.11a MODE CHAIN 0)**

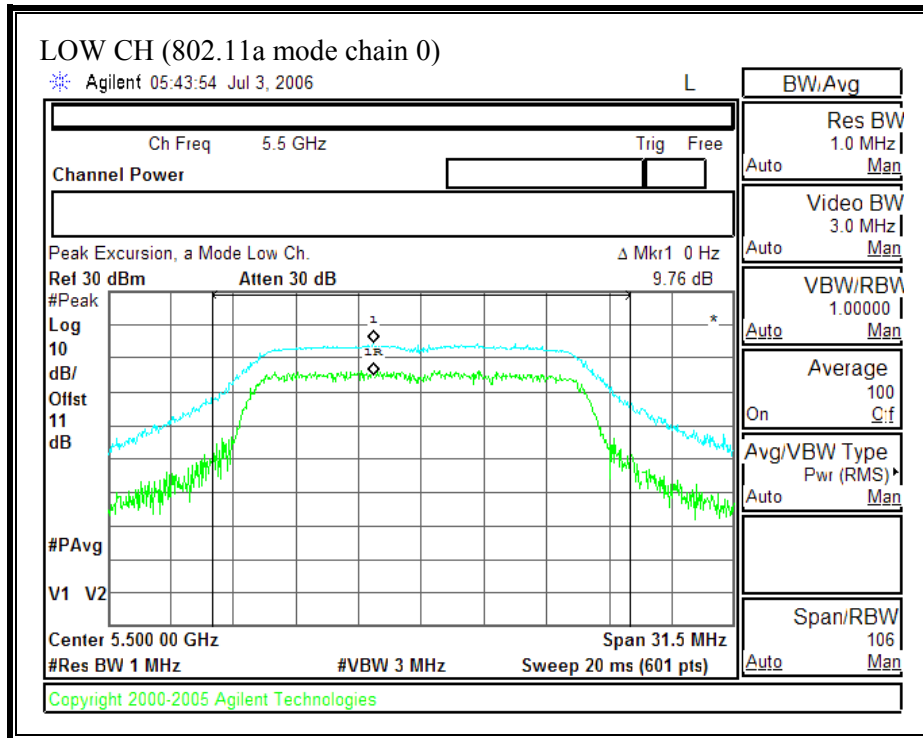

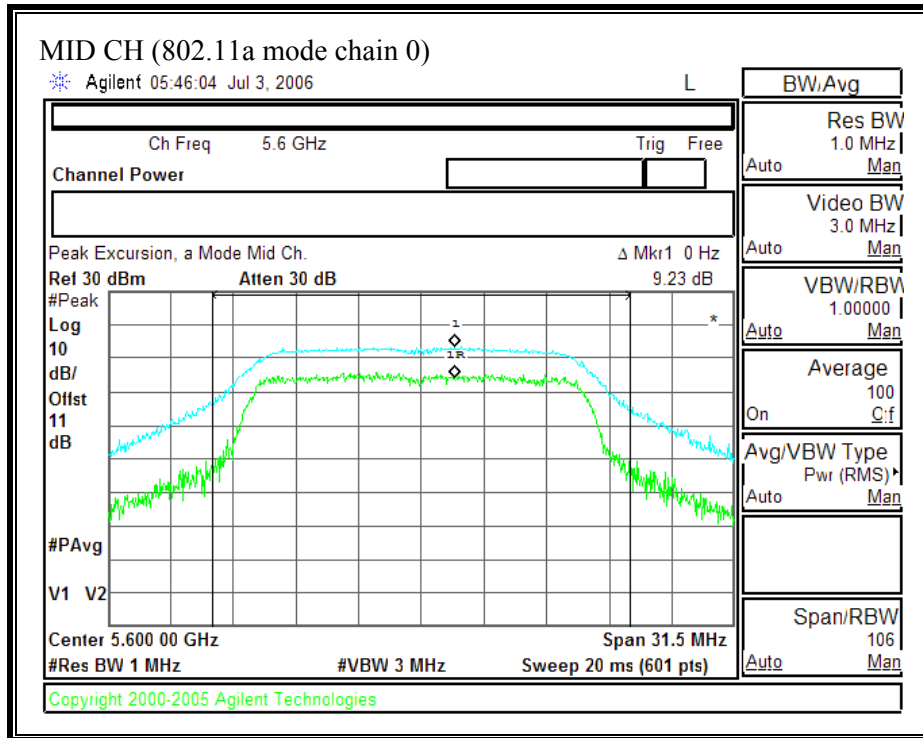

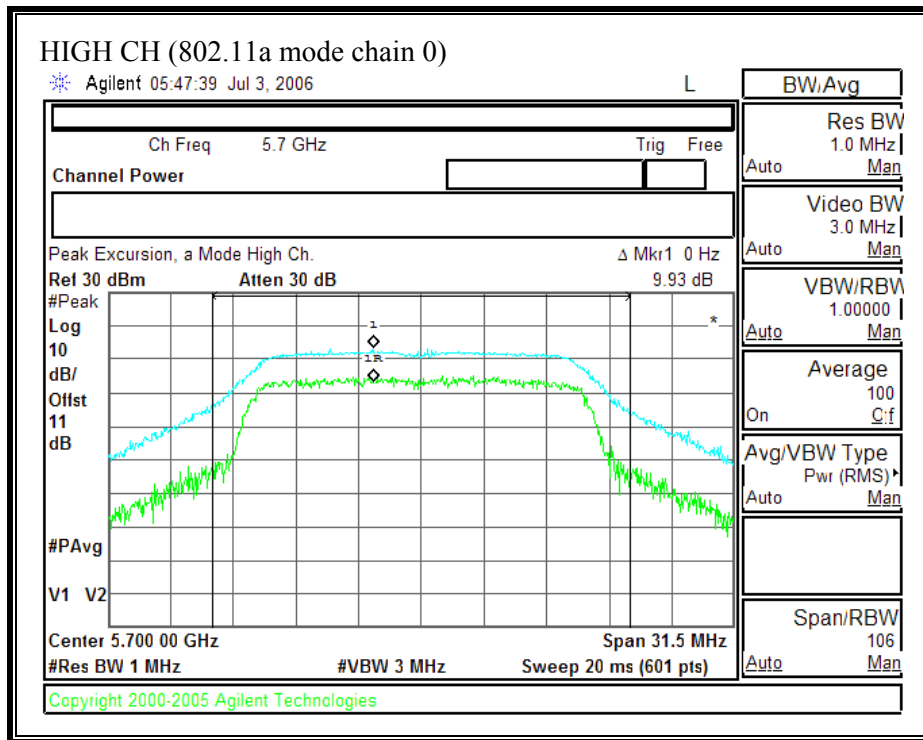

**(802.11a MODE CHAIN 2)**

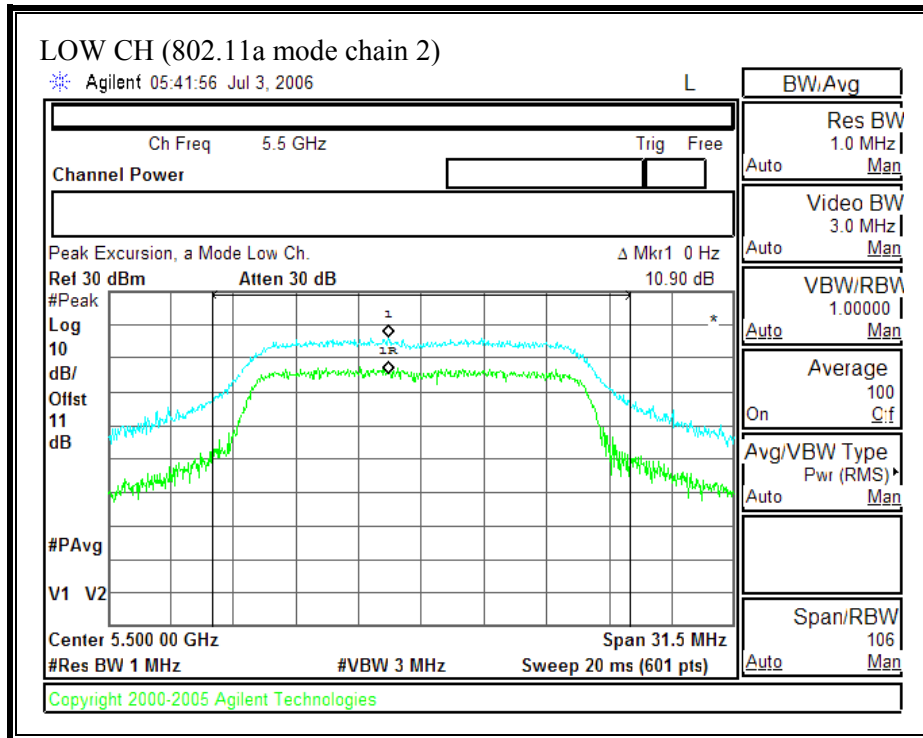

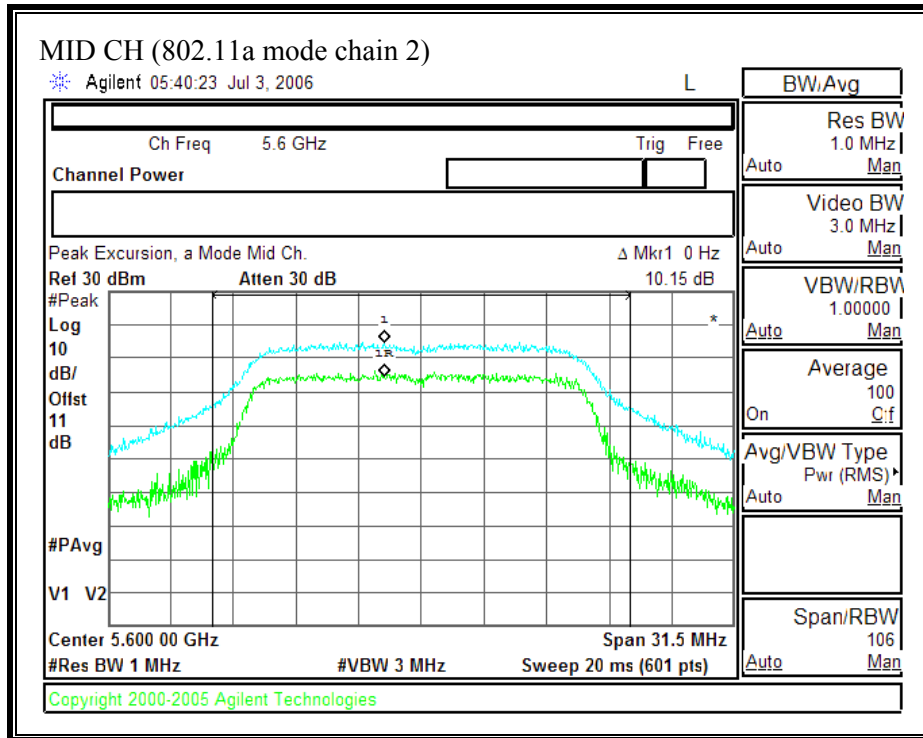

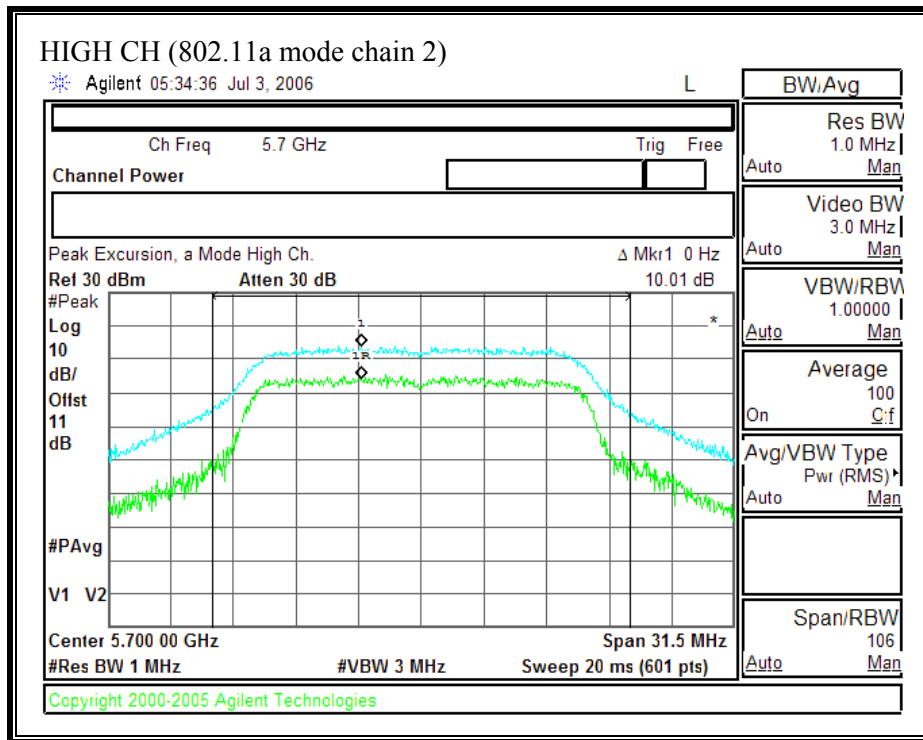



**(802.11n HT20 MODE CHAIN 0)**

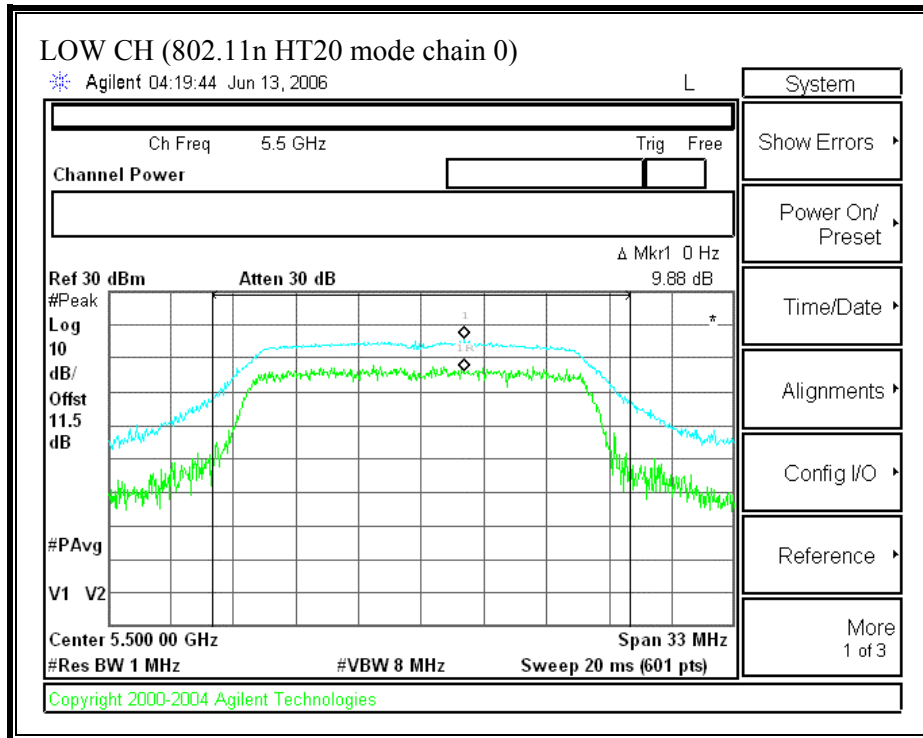

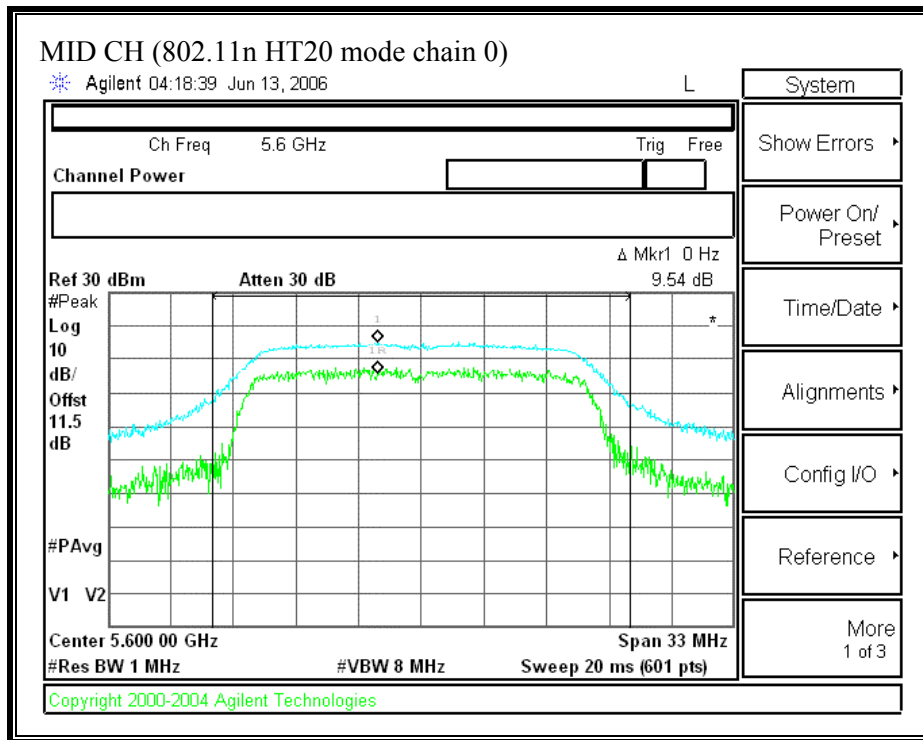

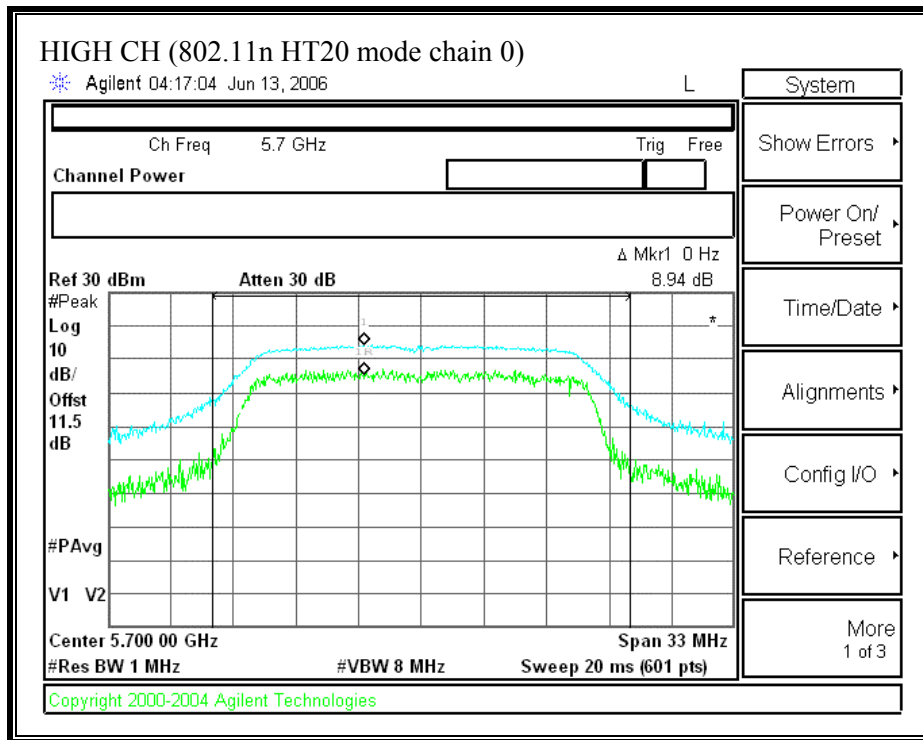

**(802.11 HT20 MODE CHAIN 2)**

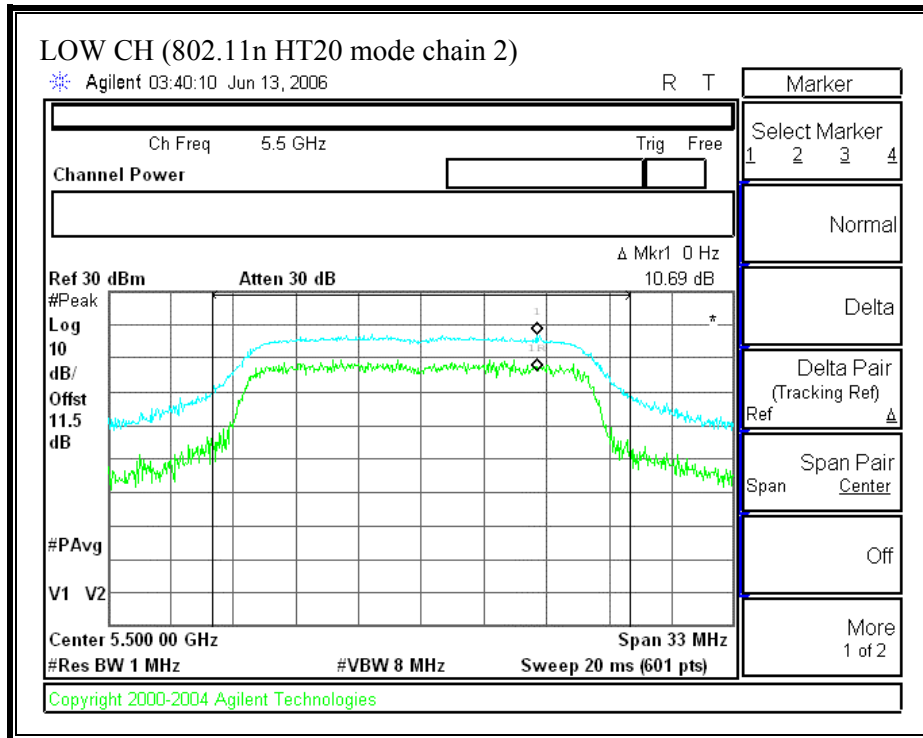

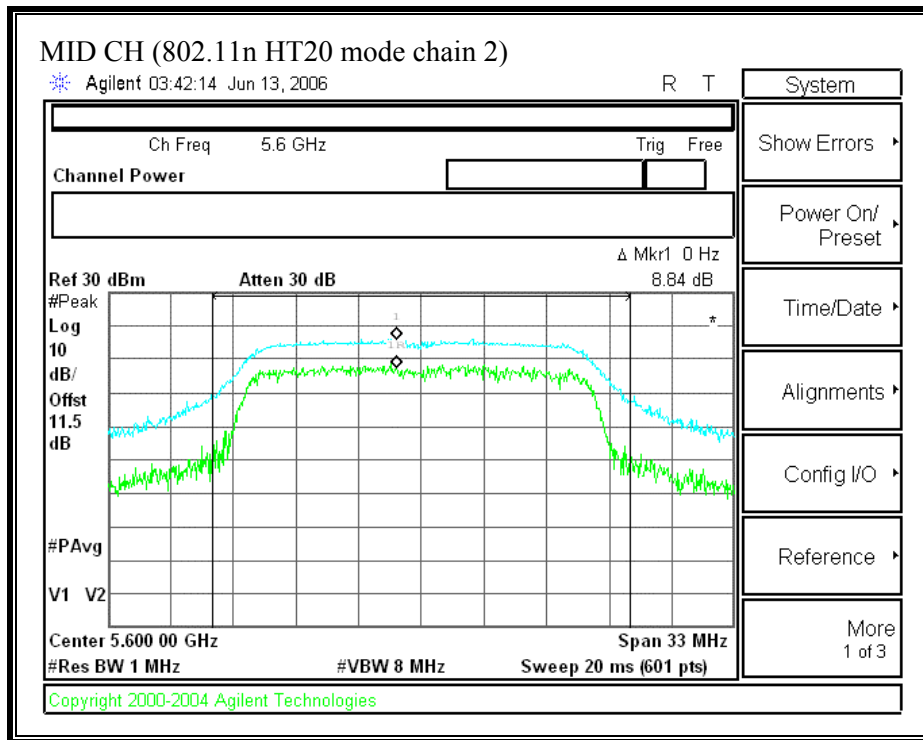

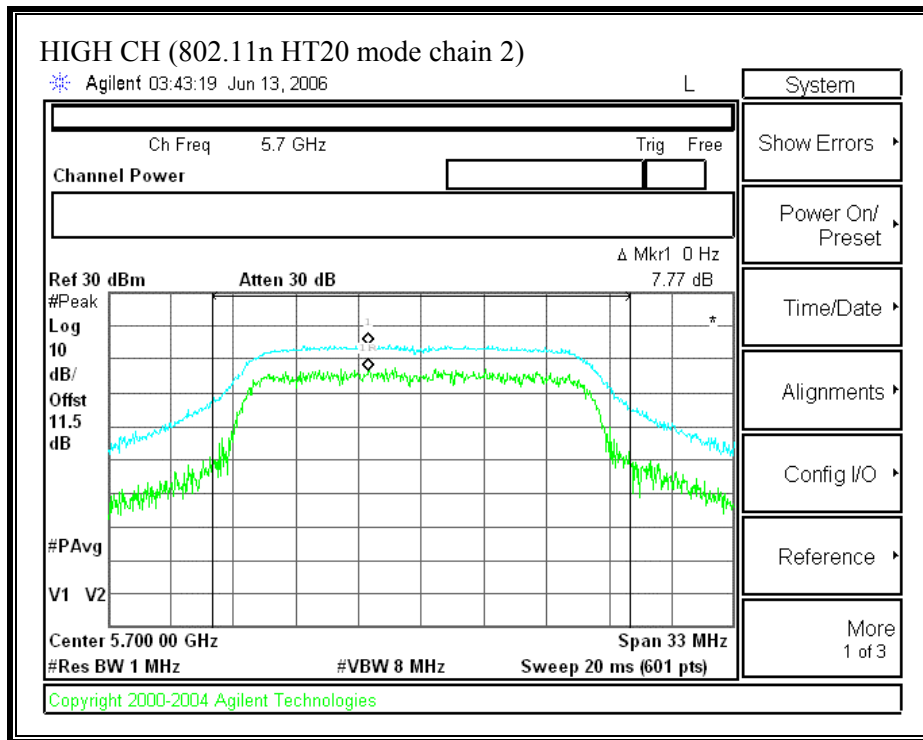

**(802.11 HT40 MODE CHAIN 0)**

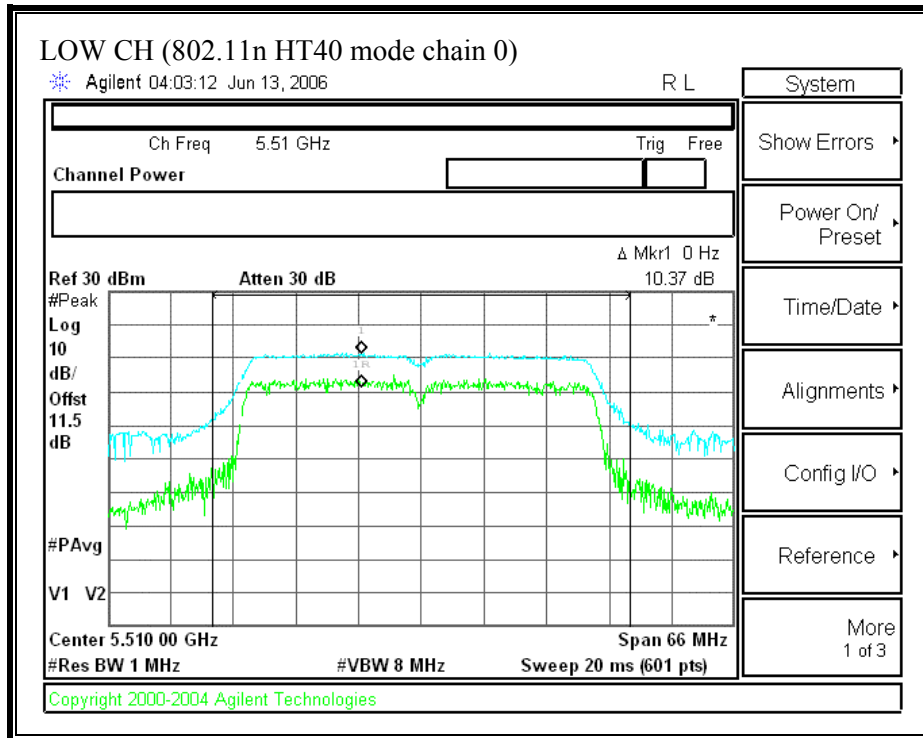

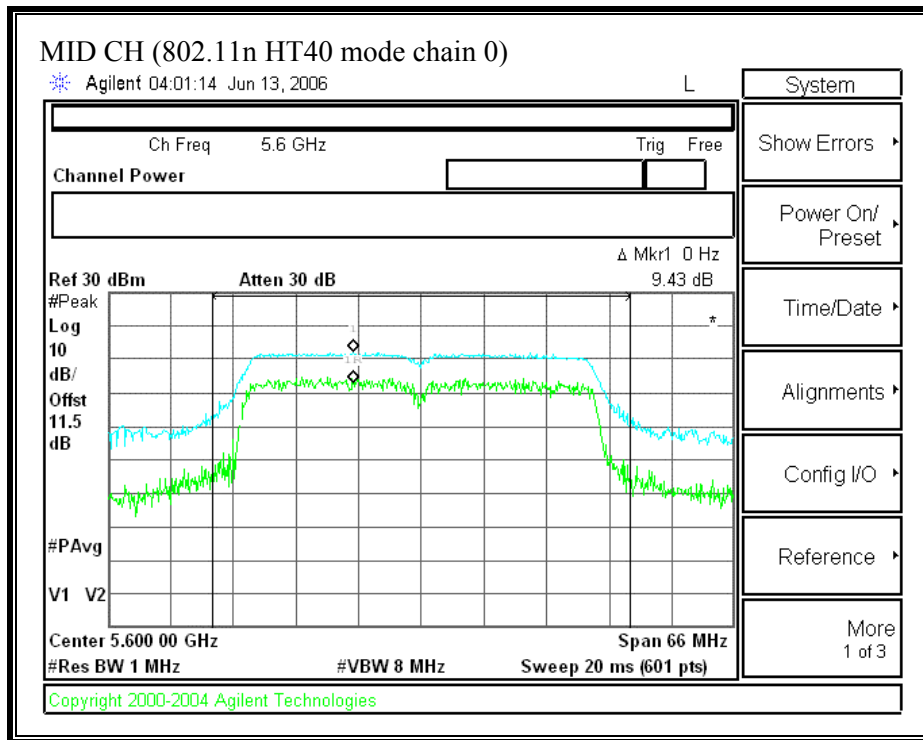



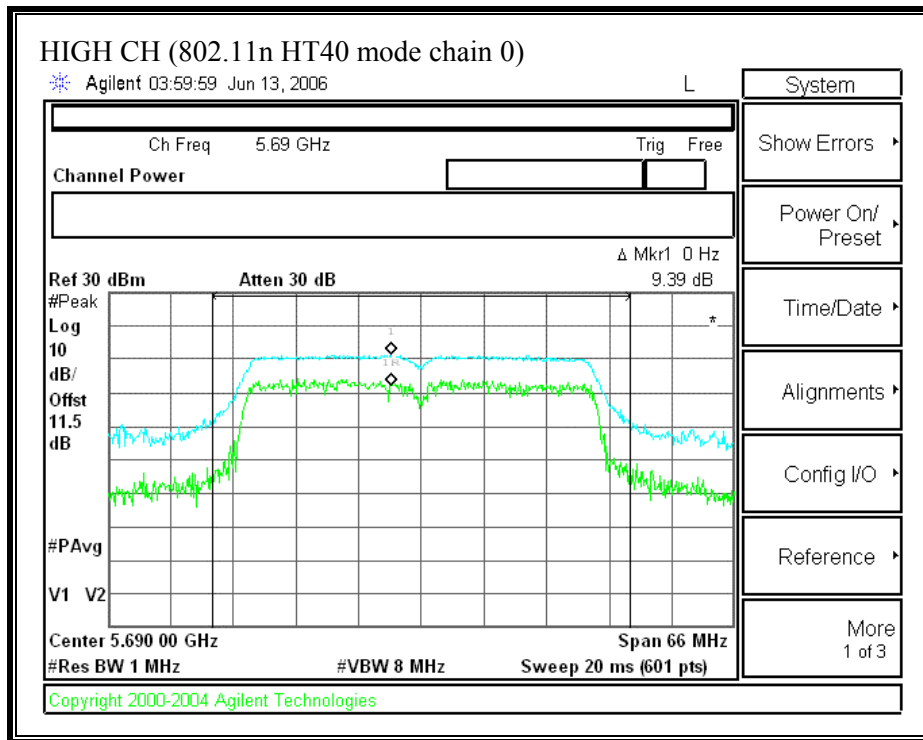

**(802.11 HT40 MODE CHAIN 2)**

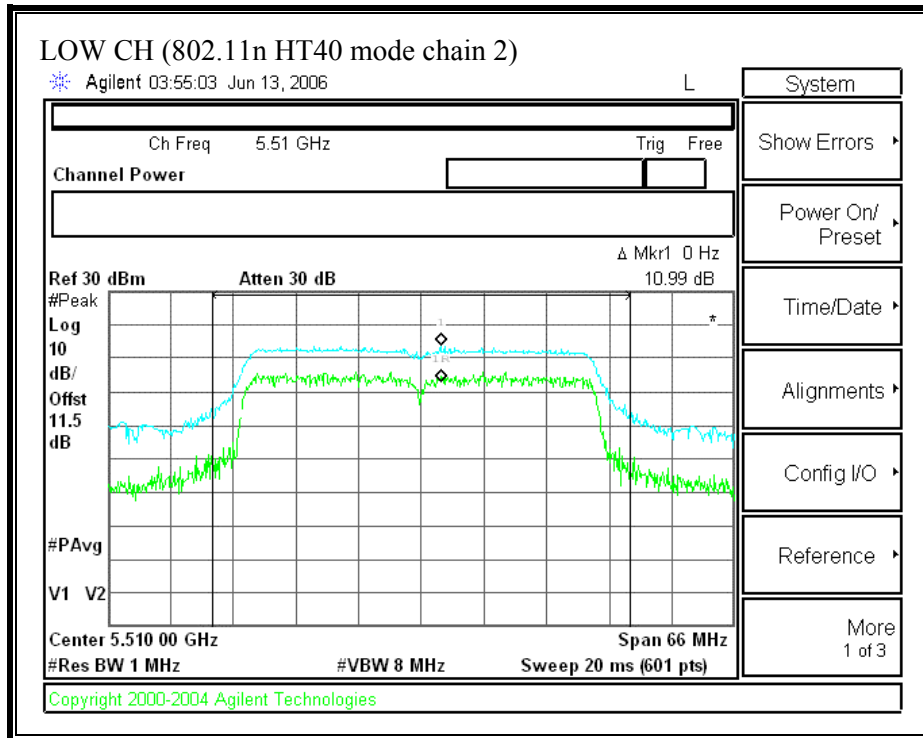

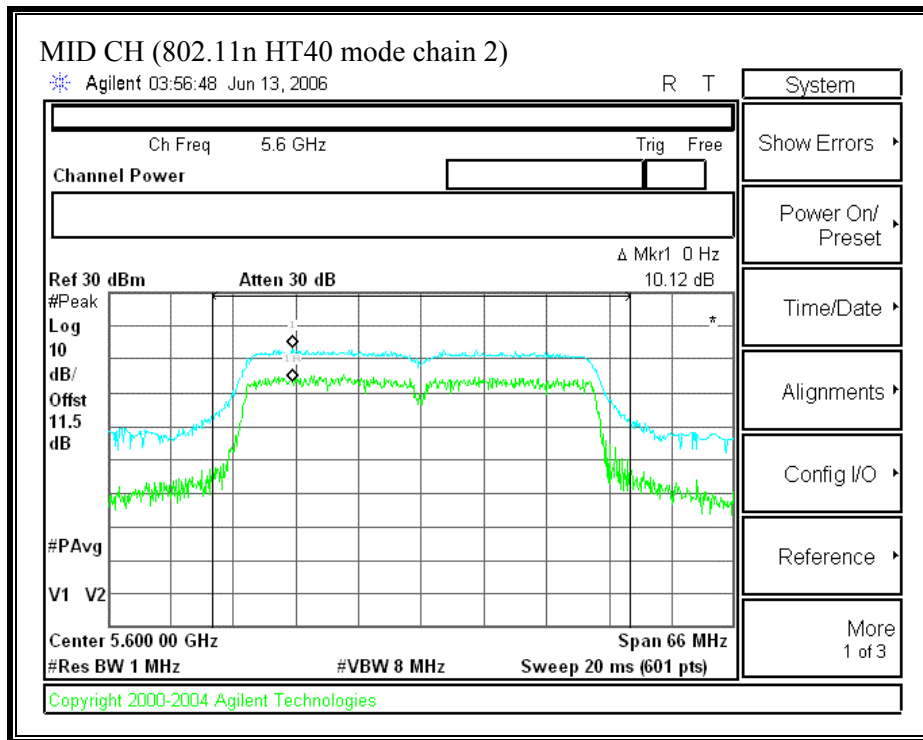

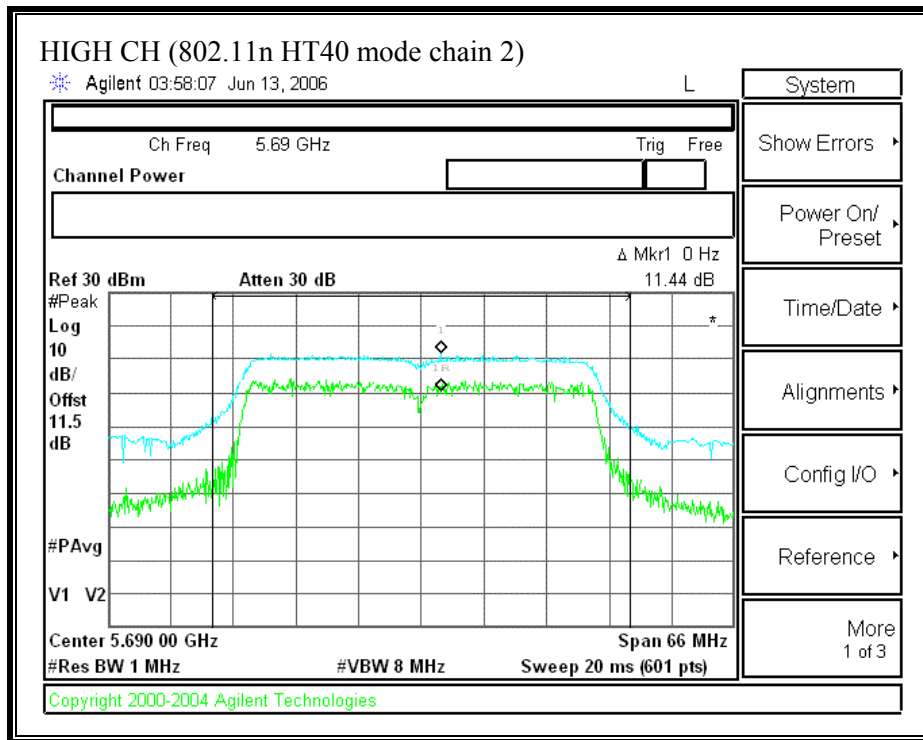

## 7.1.6. CONDUCTED SPURIOUS EMISSIONS

### LIMITS

§15.407 (b) (3) For transmitters operating in the 5.47–5.725 GHz band: all emissions outside of the 5.47–5.725 GHz band shall not exceed an EIRP of -27 dBm / MHz.

### TEST PROCEDURE

Conducted RF measurements of the transmitter output are made to confirm that the EUT antenna port conducted emissions meet the specified limit and to identify any spurious signals that require further investigation or measurements on the radiated emissions site.

The transmitter output is connected to the spectrum analyzer. The resolution bandwidth is set to 1 MHz. The video bandwidth is set to 1 MHz. Peak detection measurements are compared to the average EIRP limit, adjusted for the maximum antenna gain. If necessary, additional average detection measurements are made.

Measurements are made over the 30 MHz to 40 GHz range with the transmitter set to the lowest, middle, and highest channels.

### RESULTS

No non-compliance noted:

**SPURIOUS EMISSIONS (802.11a MODE CHAIN 0)**

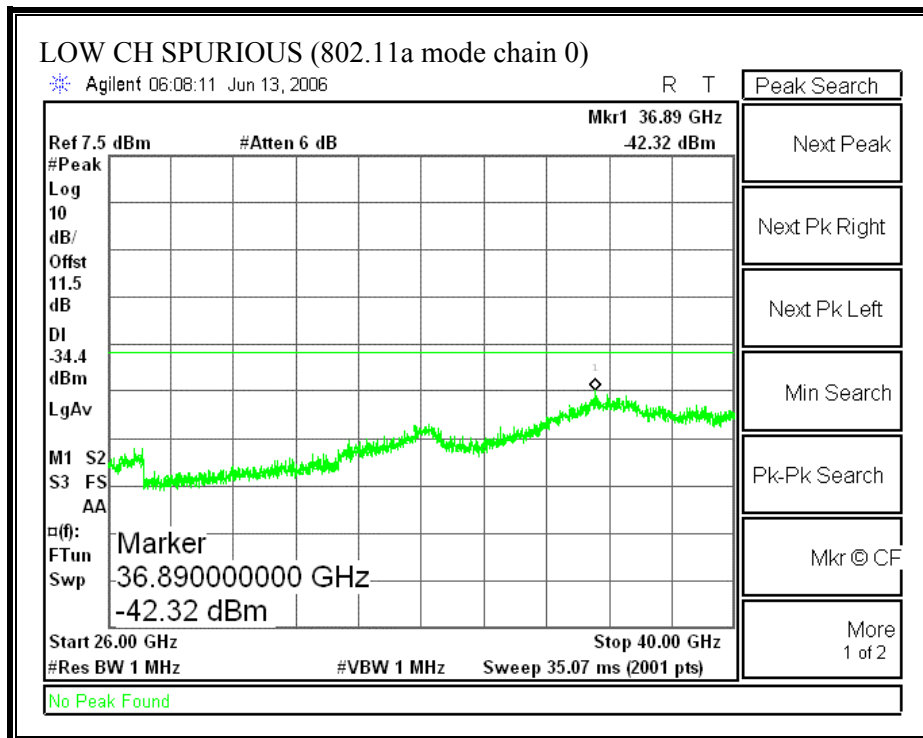
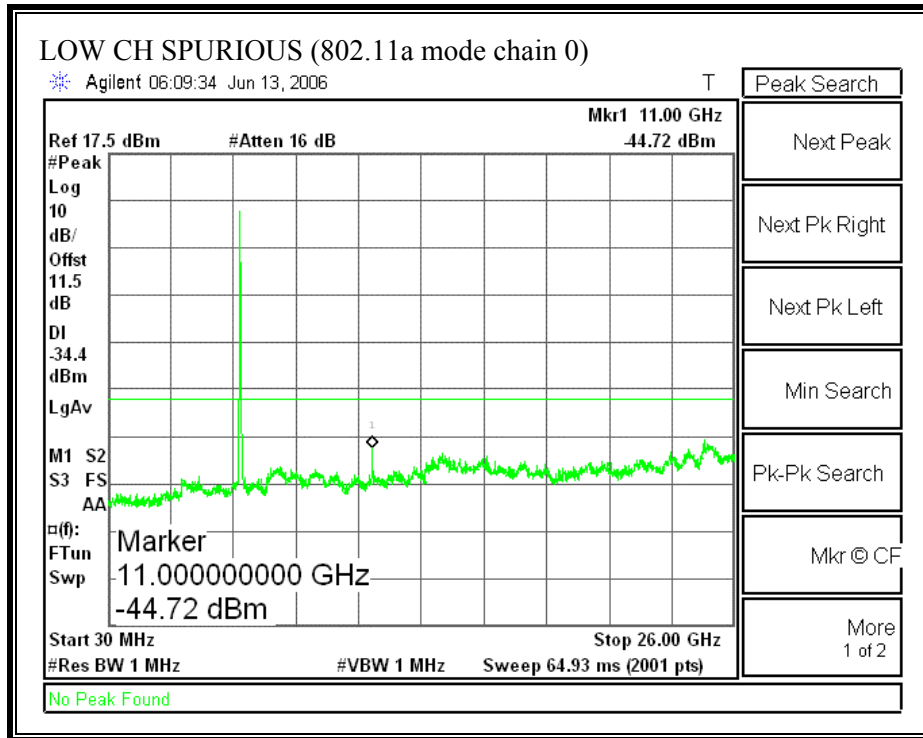

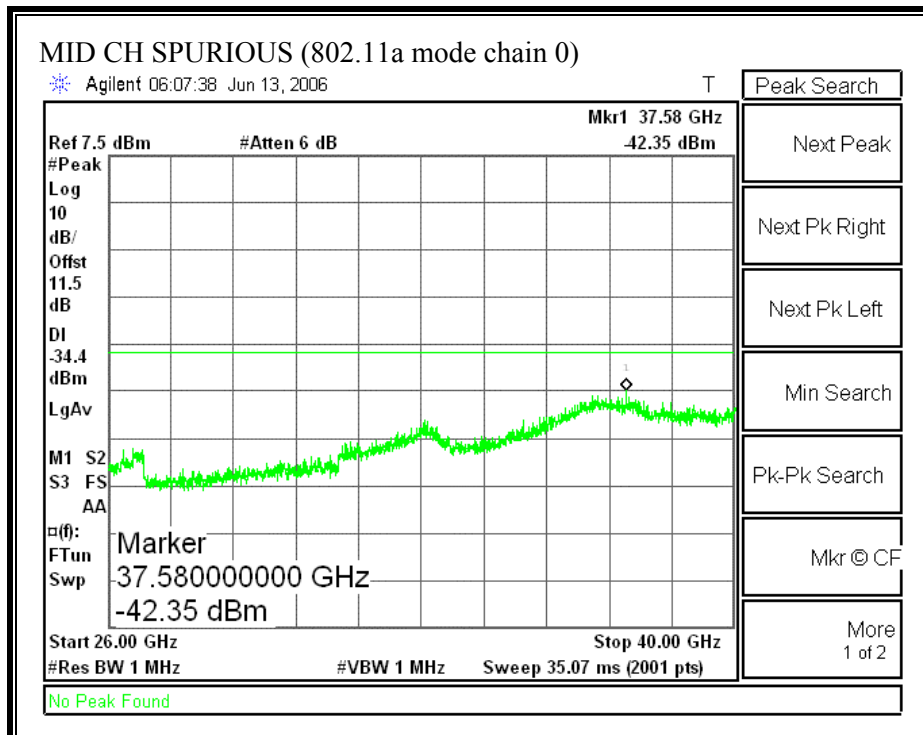
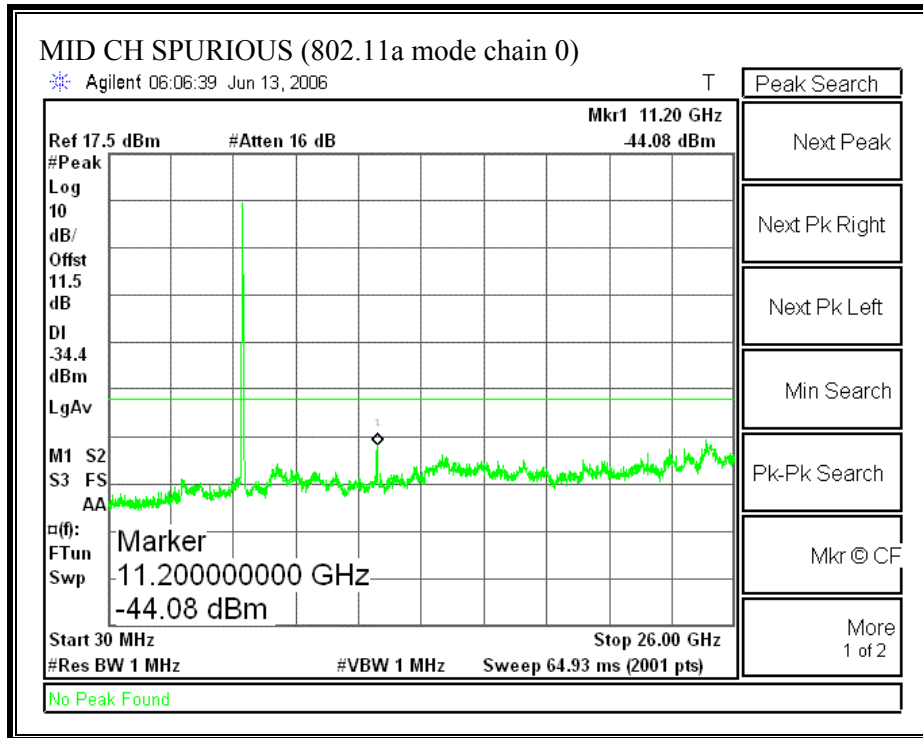

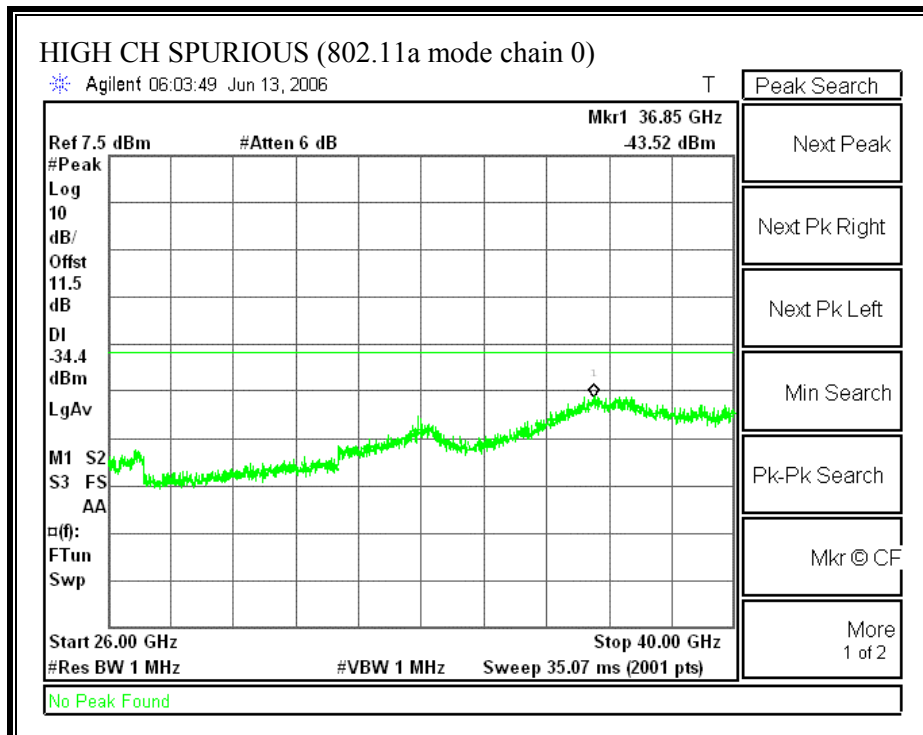
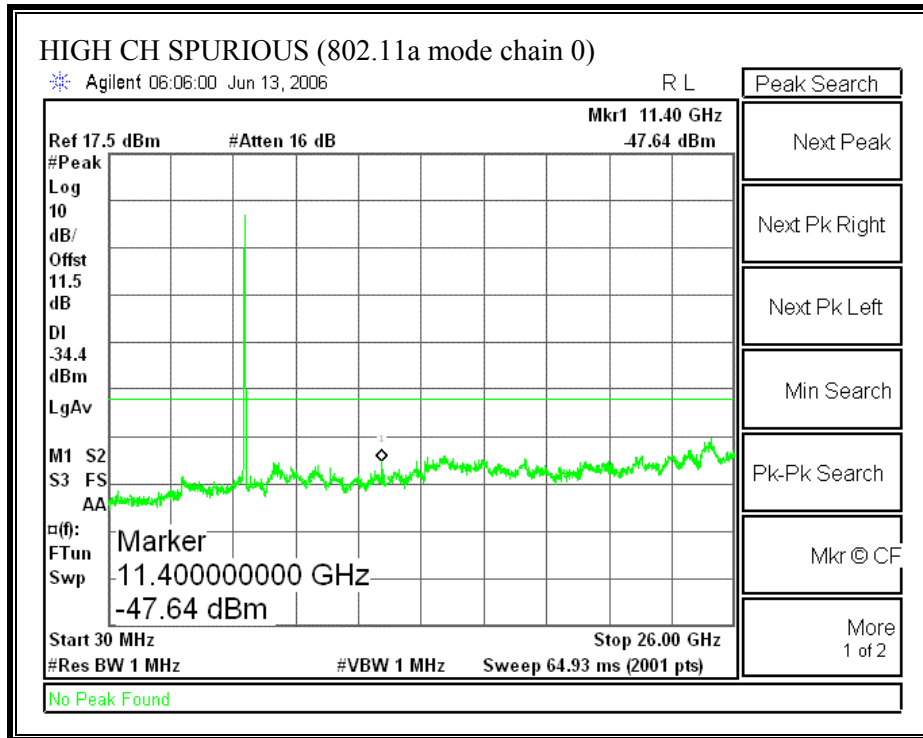



**SPURIOUS EMISSIONS (802.11a MODE CHAIN 2)**

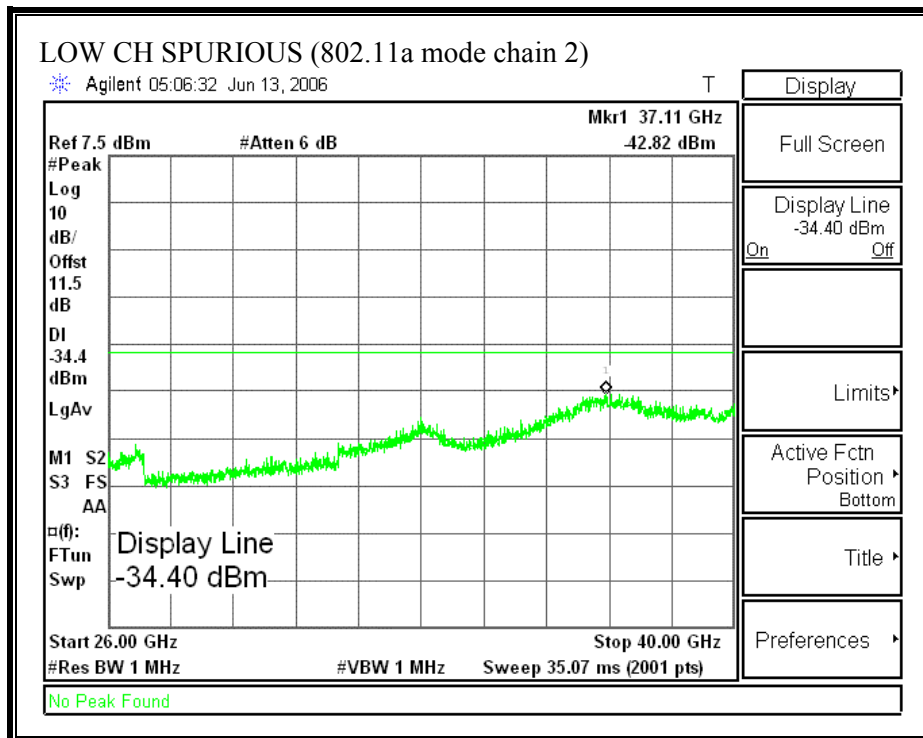
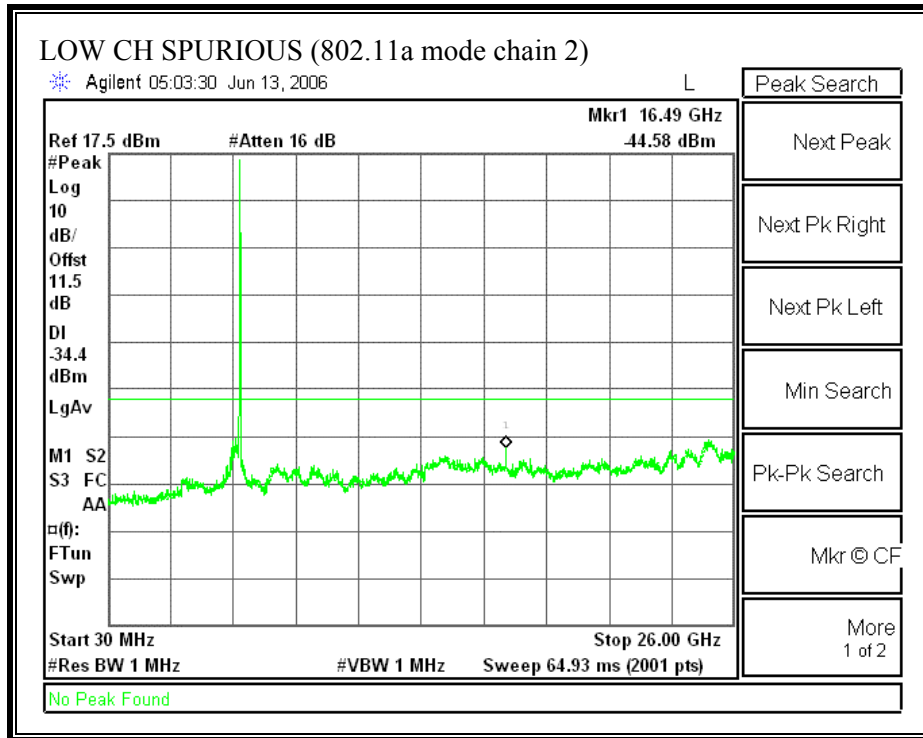

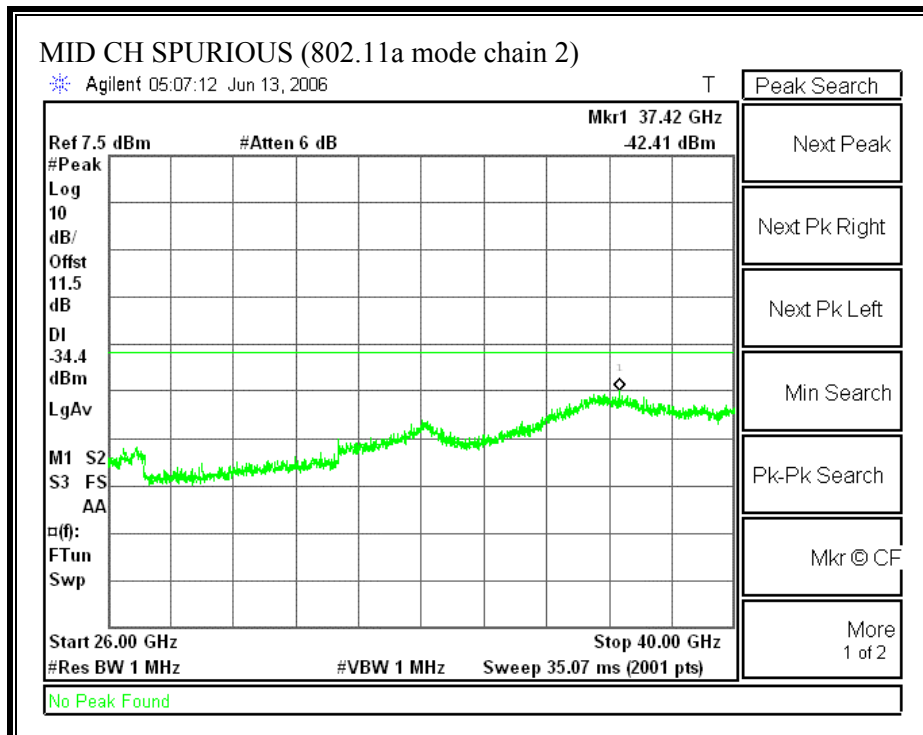
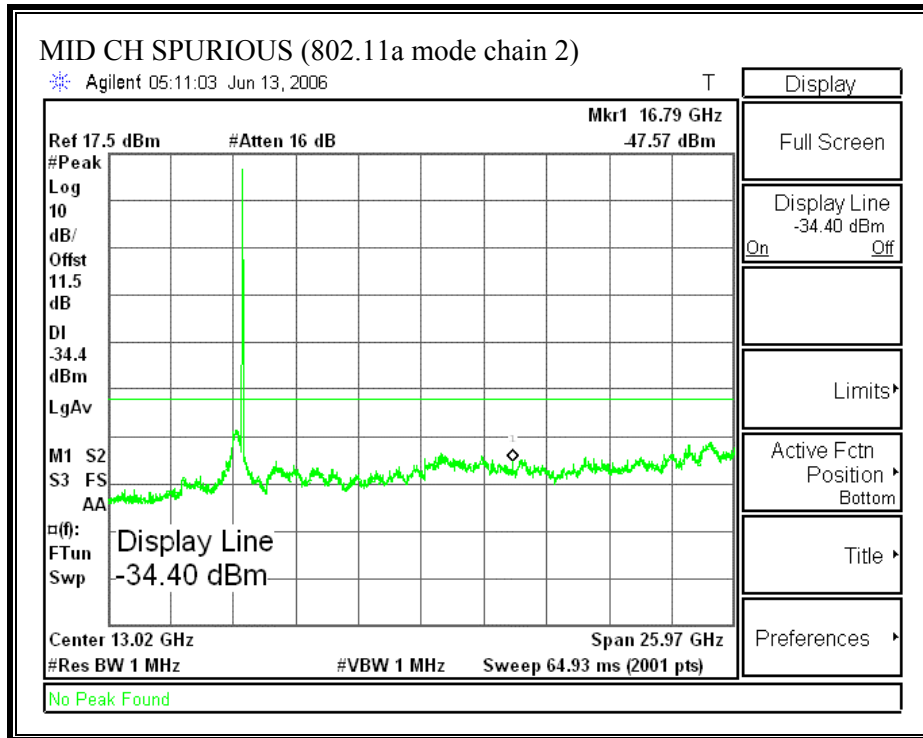

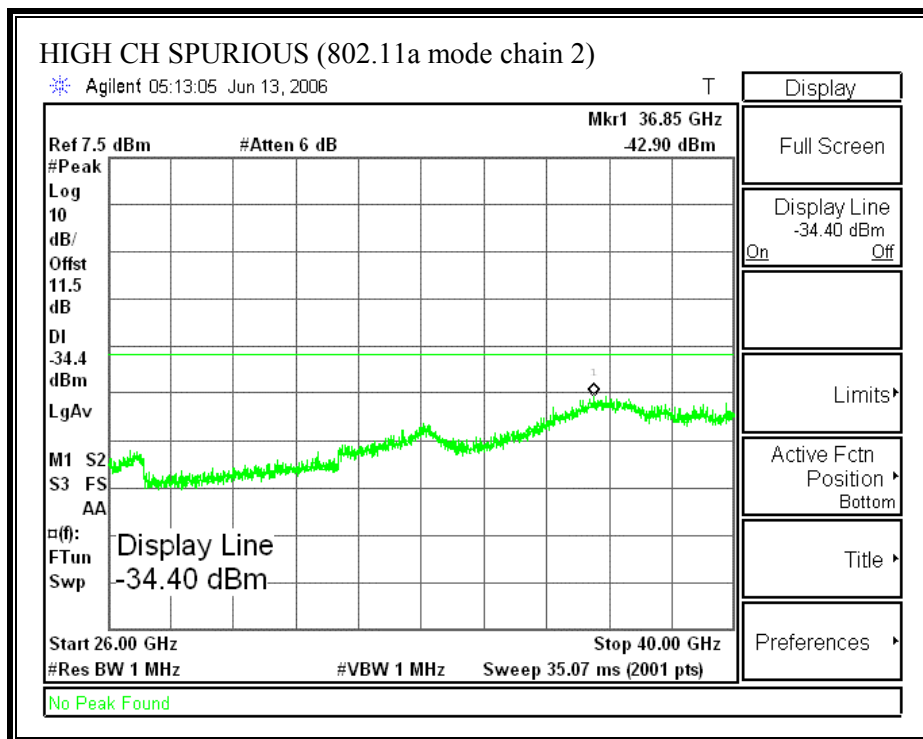
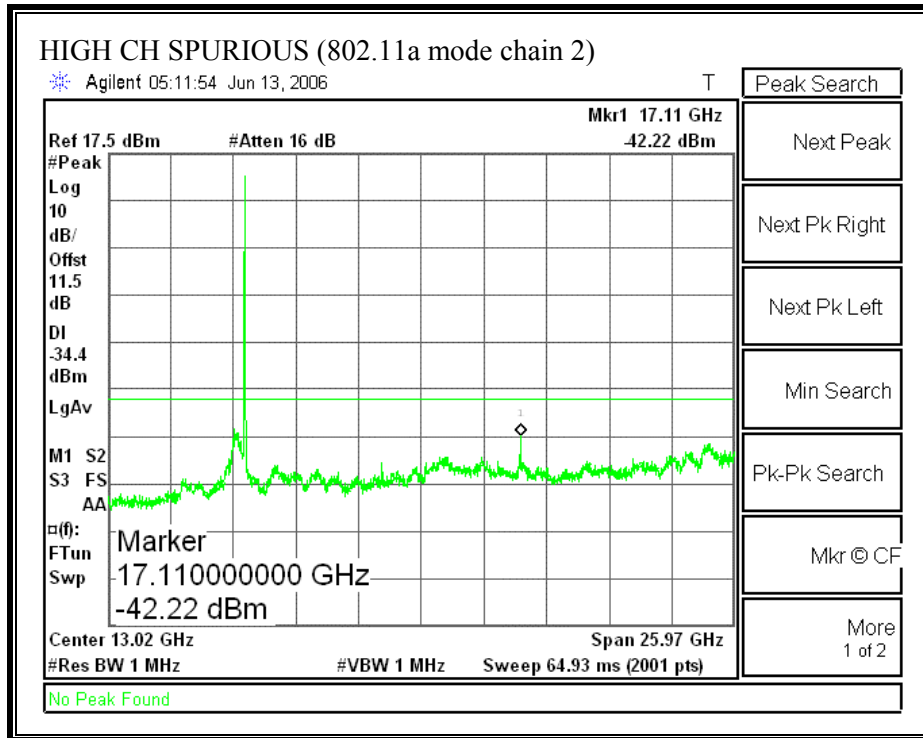

**SPURIOUS EMISSIONS (802.11n HT20 MODE CHAIN 0)**

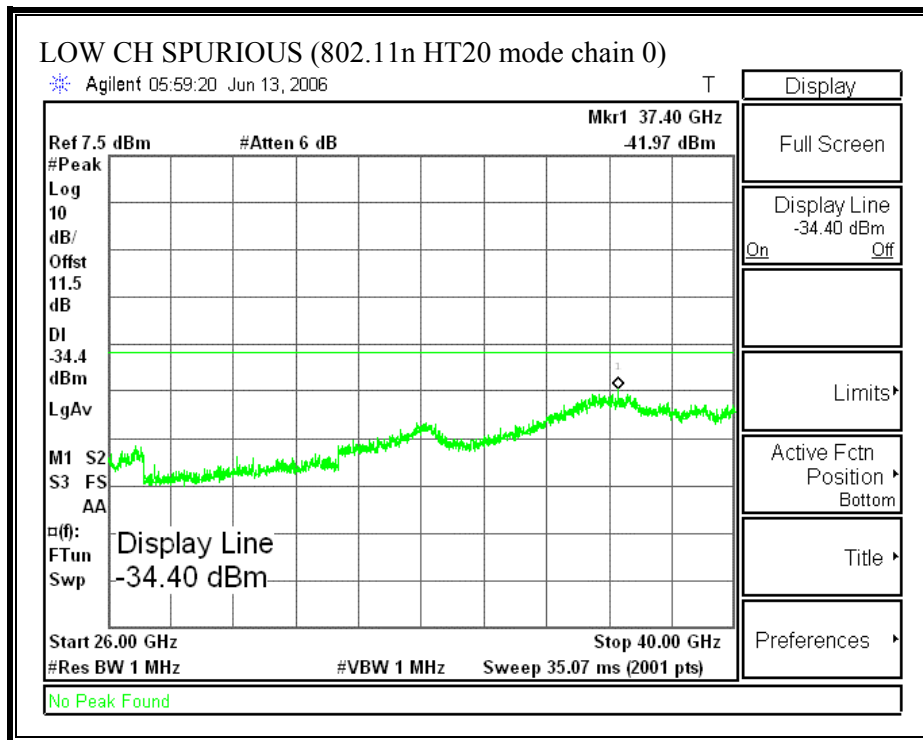
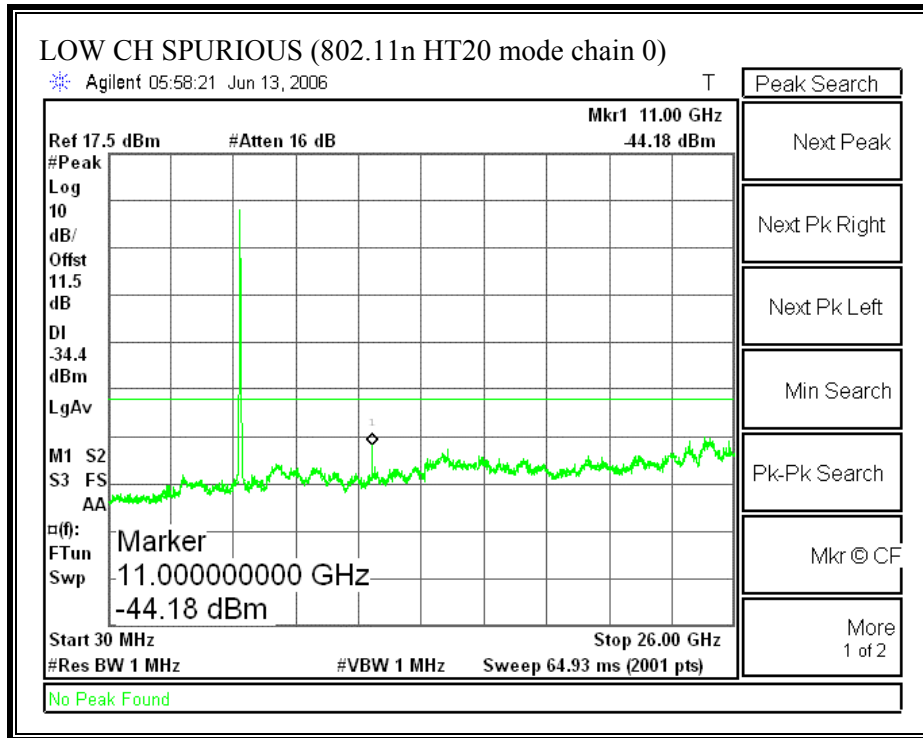

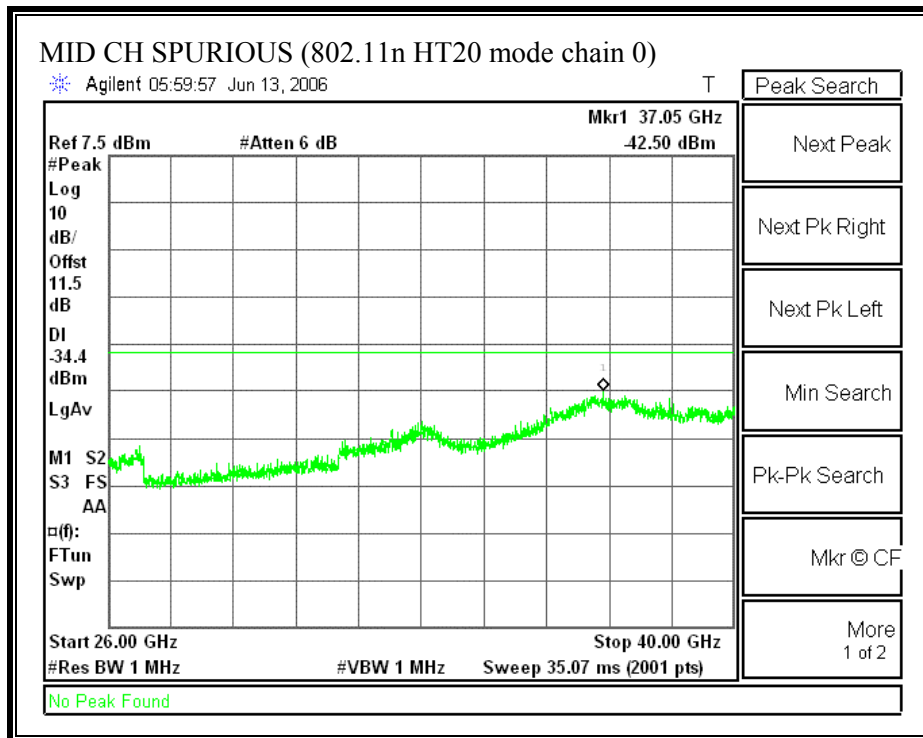
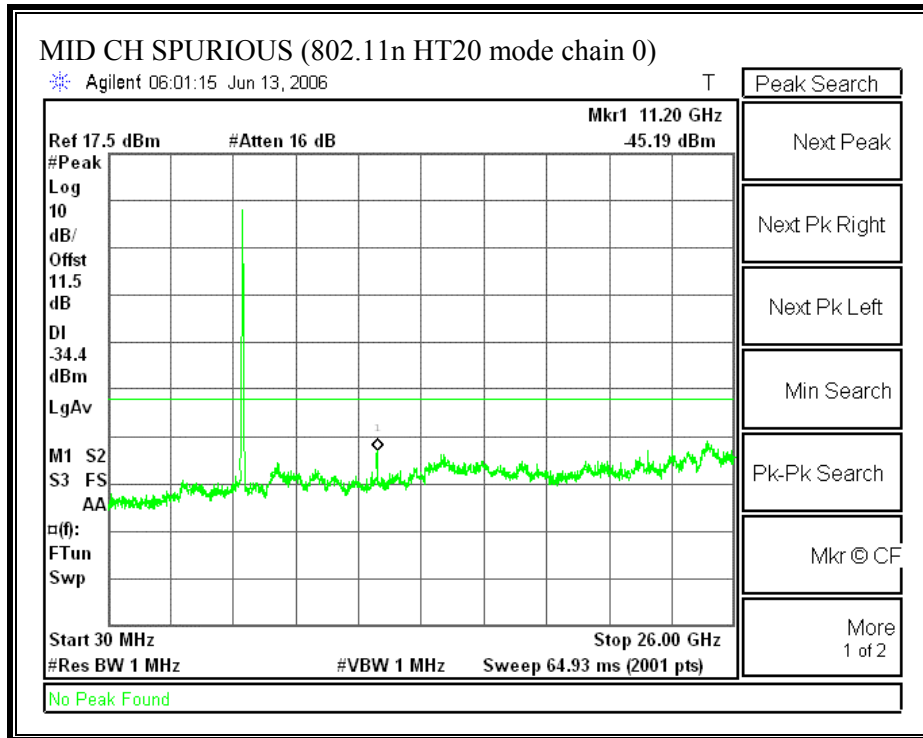

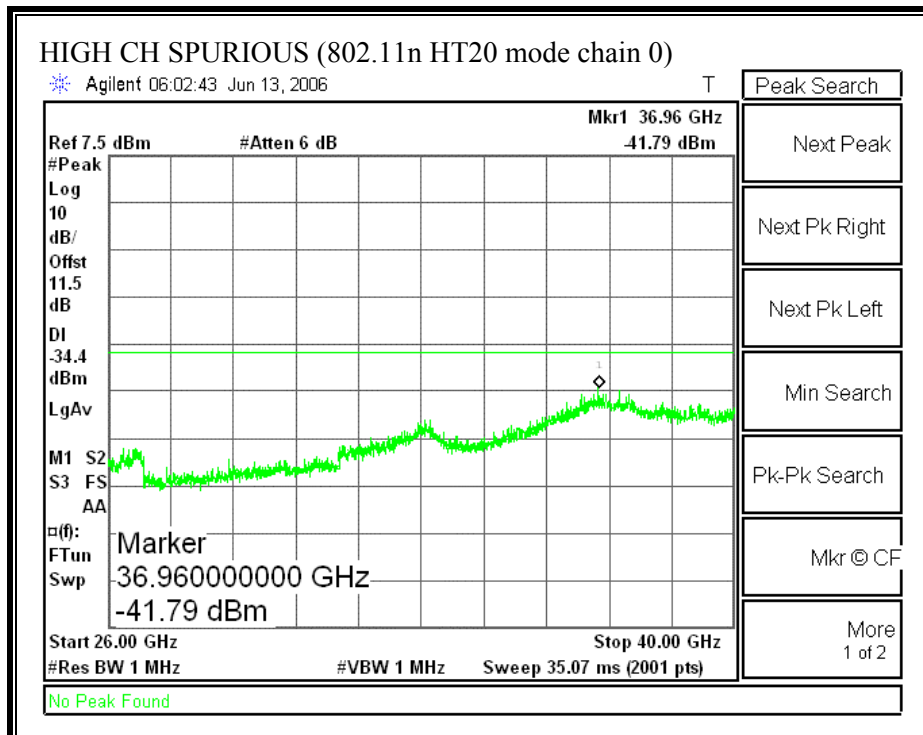
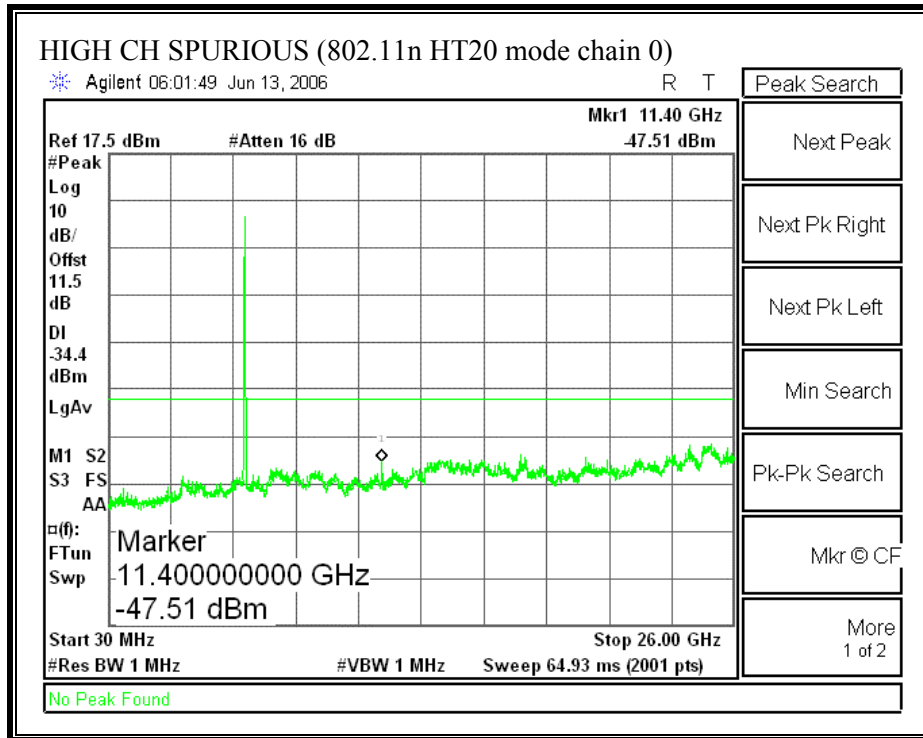

**SPURIOUS EMISSIONS (802.11 HT20 MODE CHAIN 2)**

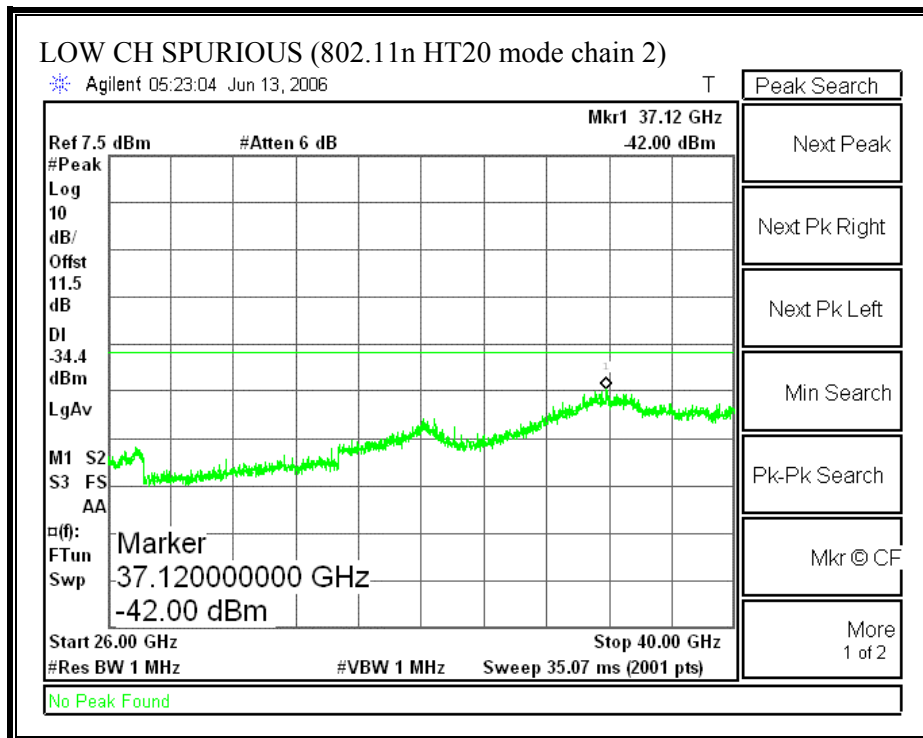
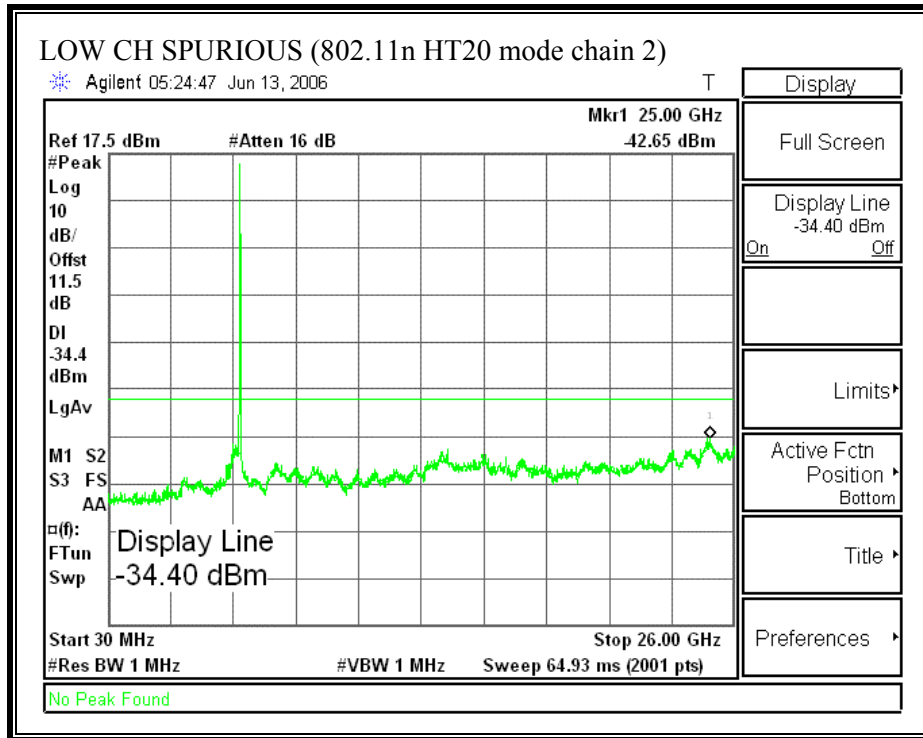

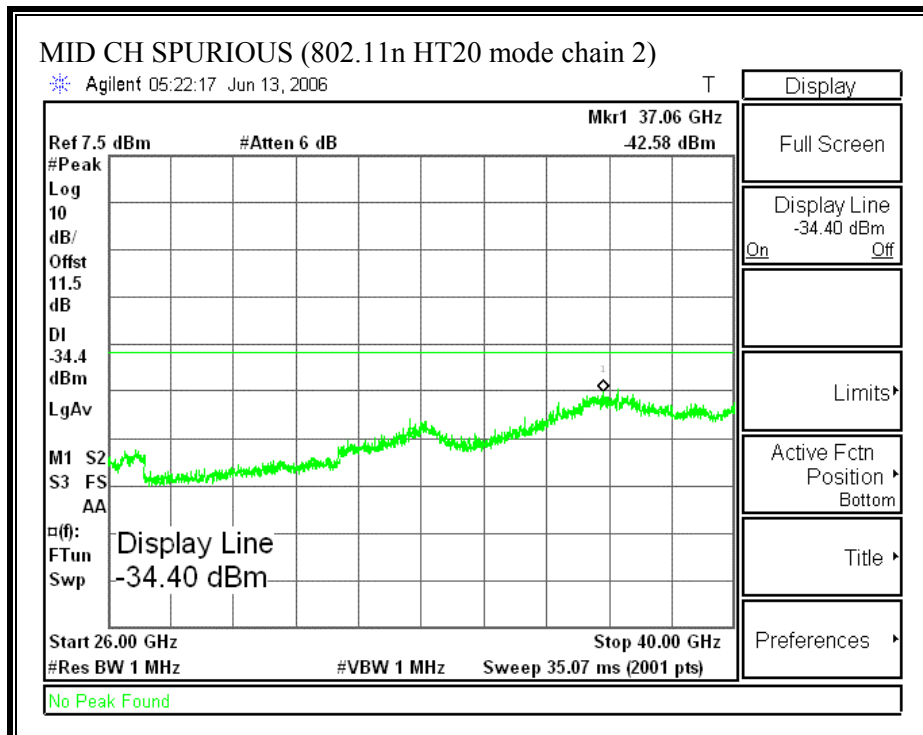
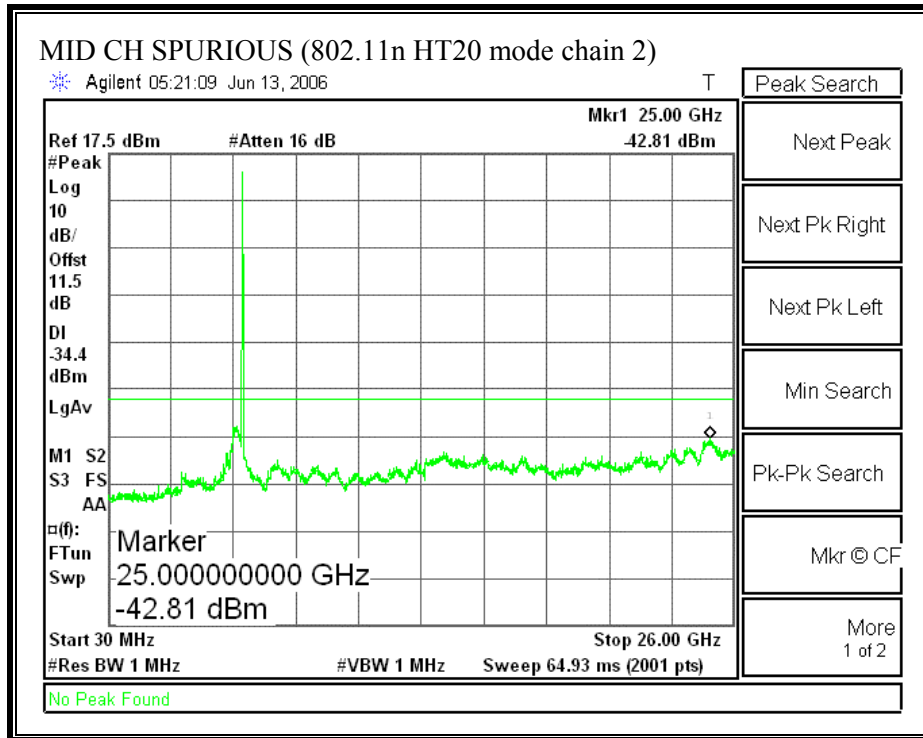



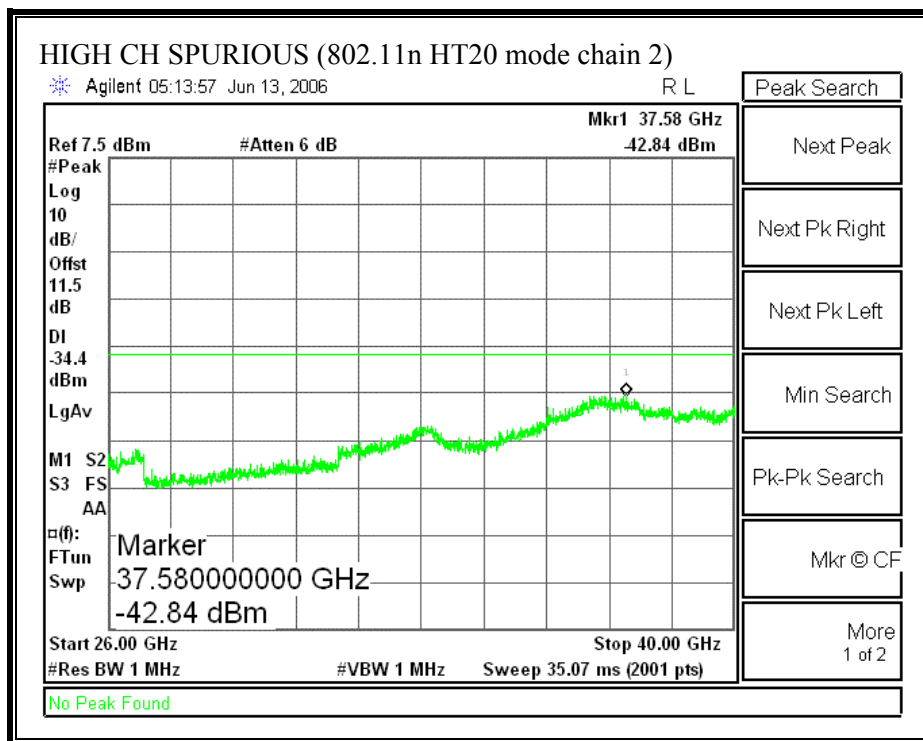
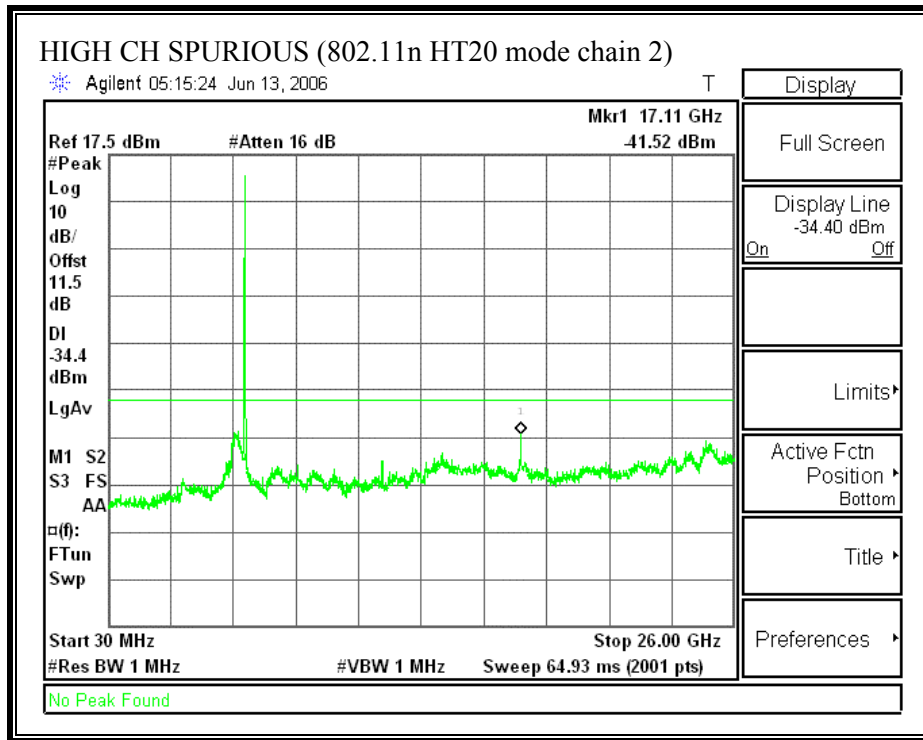

**SPURIOUS EMISSIONS (802.11 HT40 MODE CHAIN 0)**

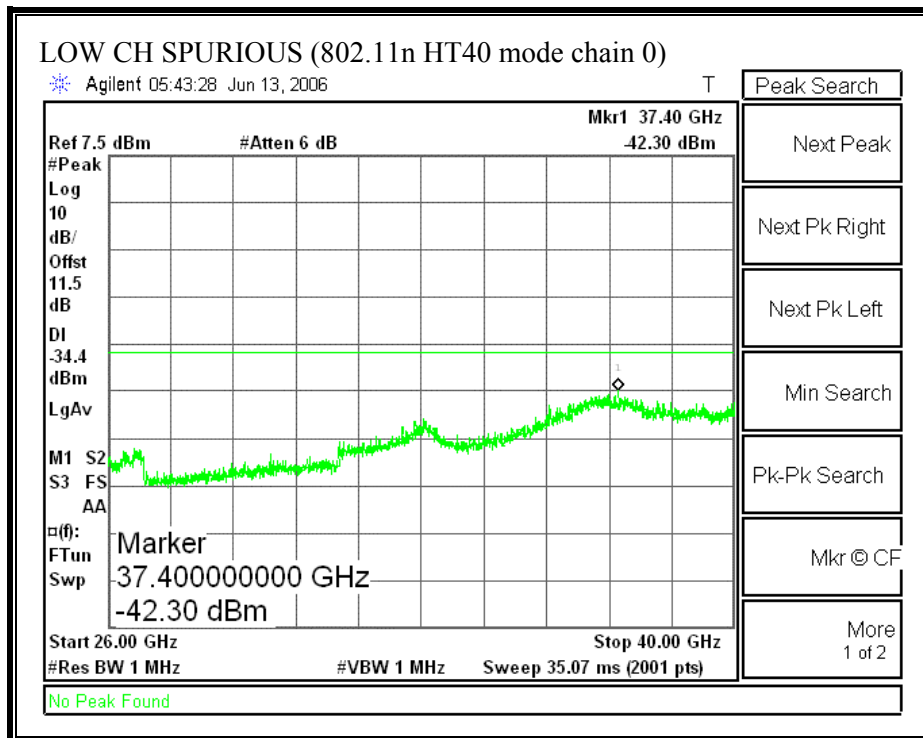
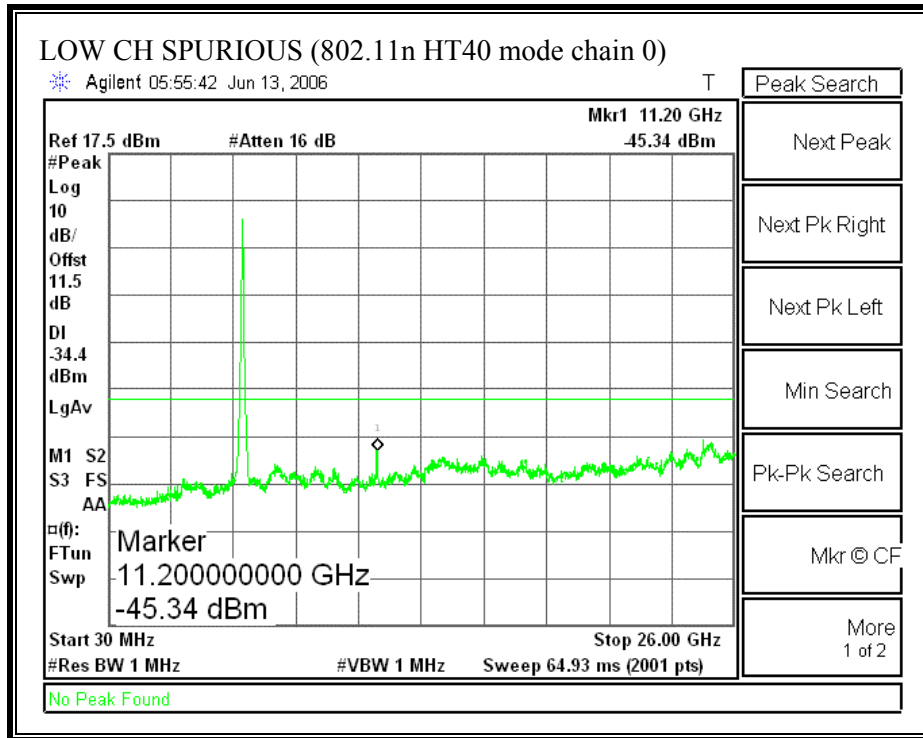

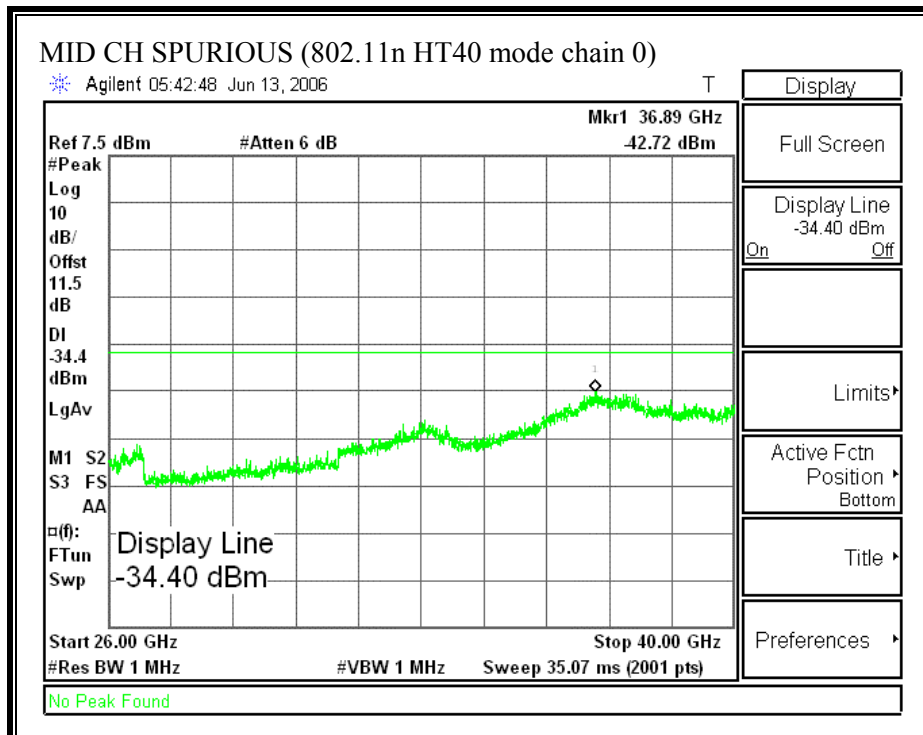
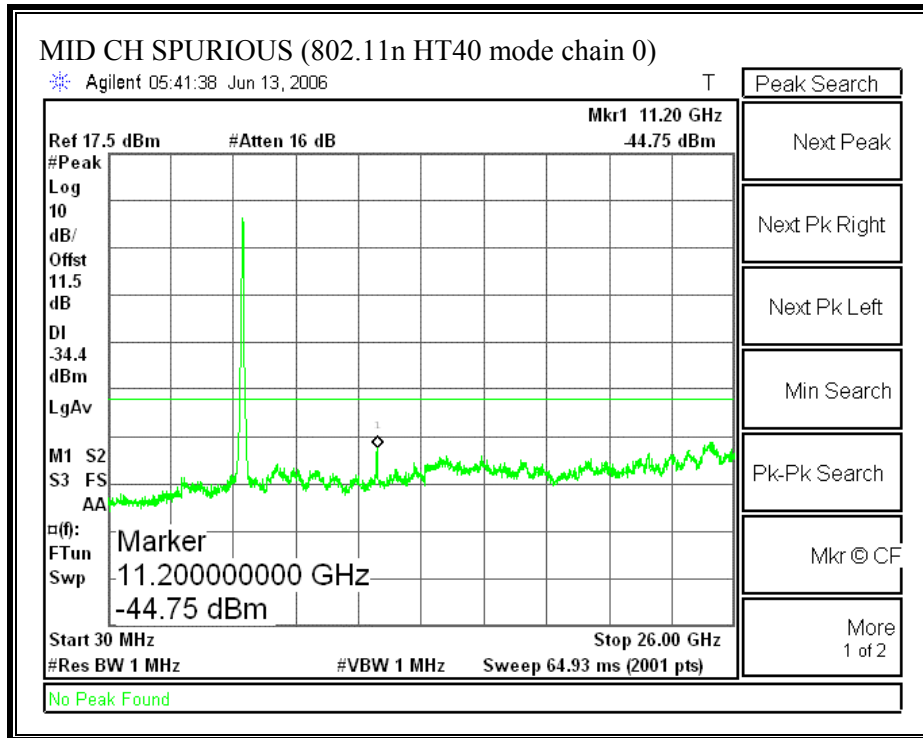

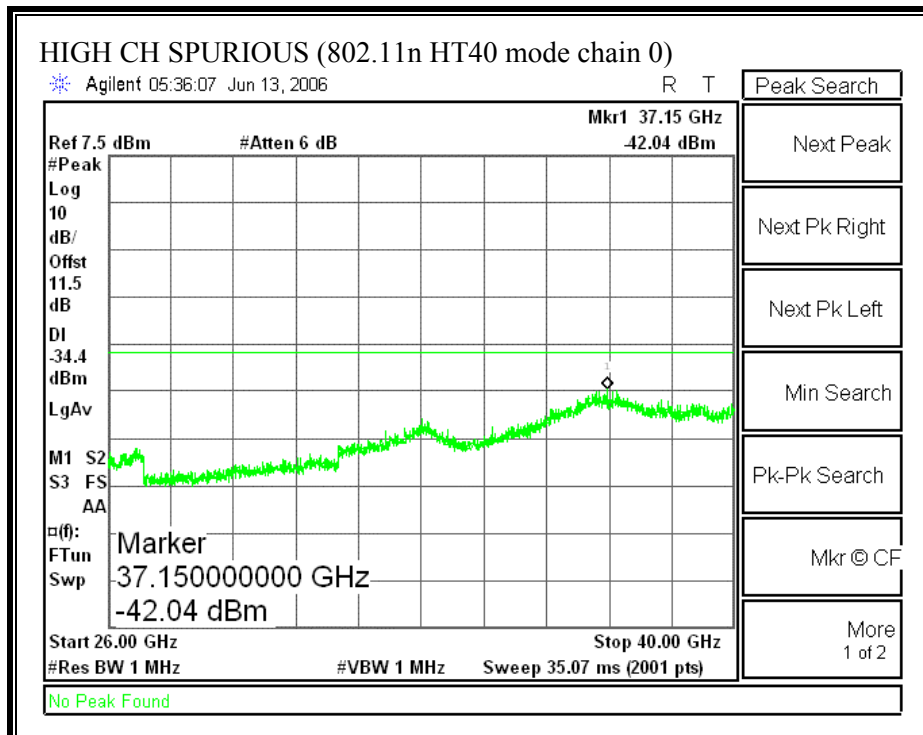
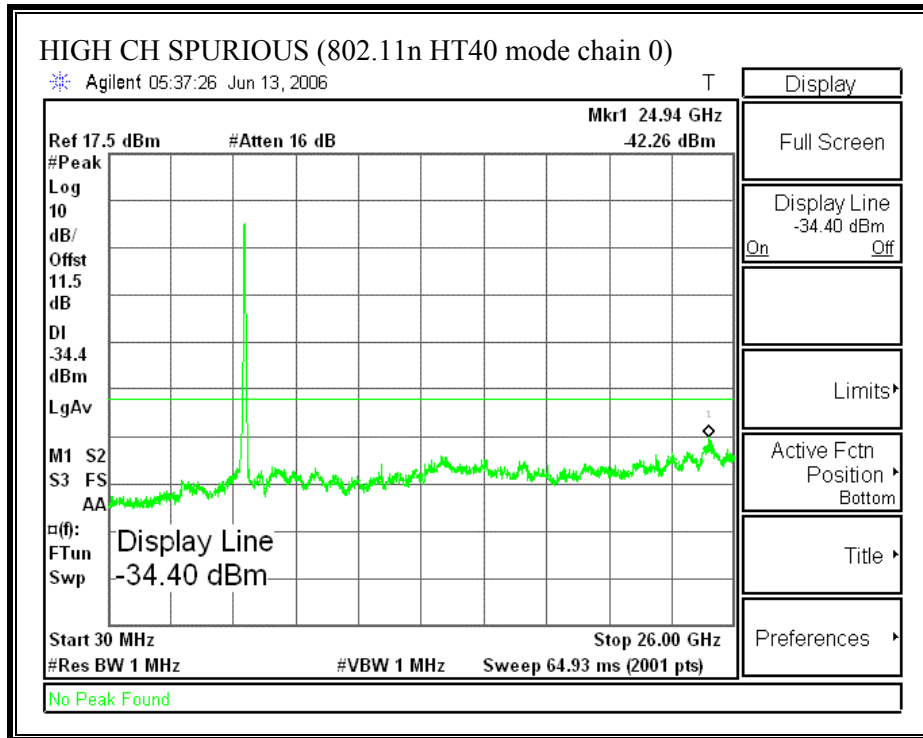

**SPURIOUS EMISSIONS (802.11 HT40 MODE CHAIN 2)**

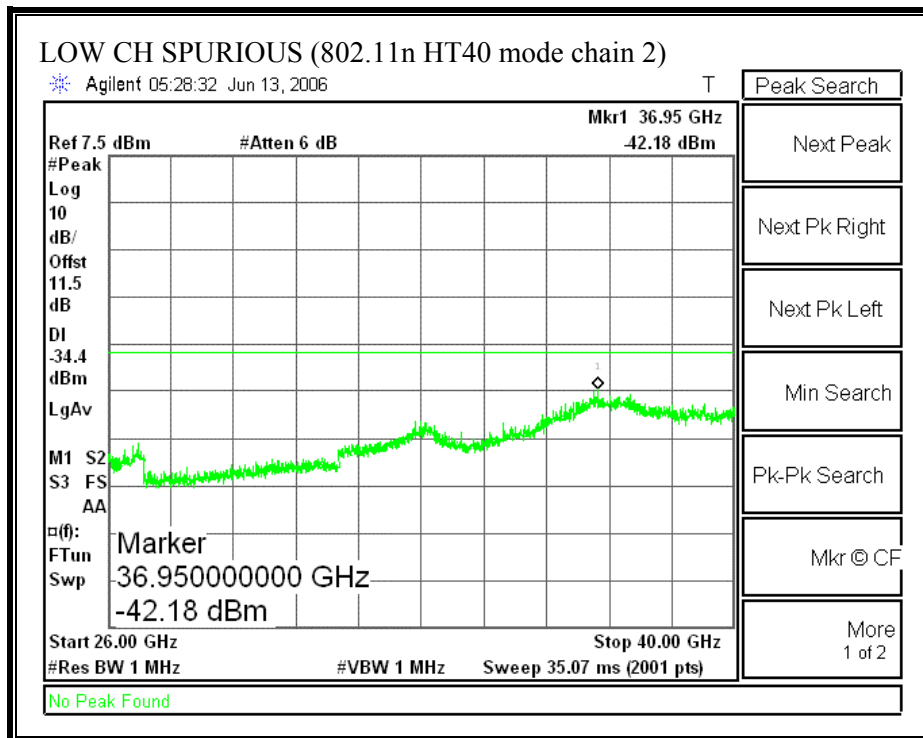
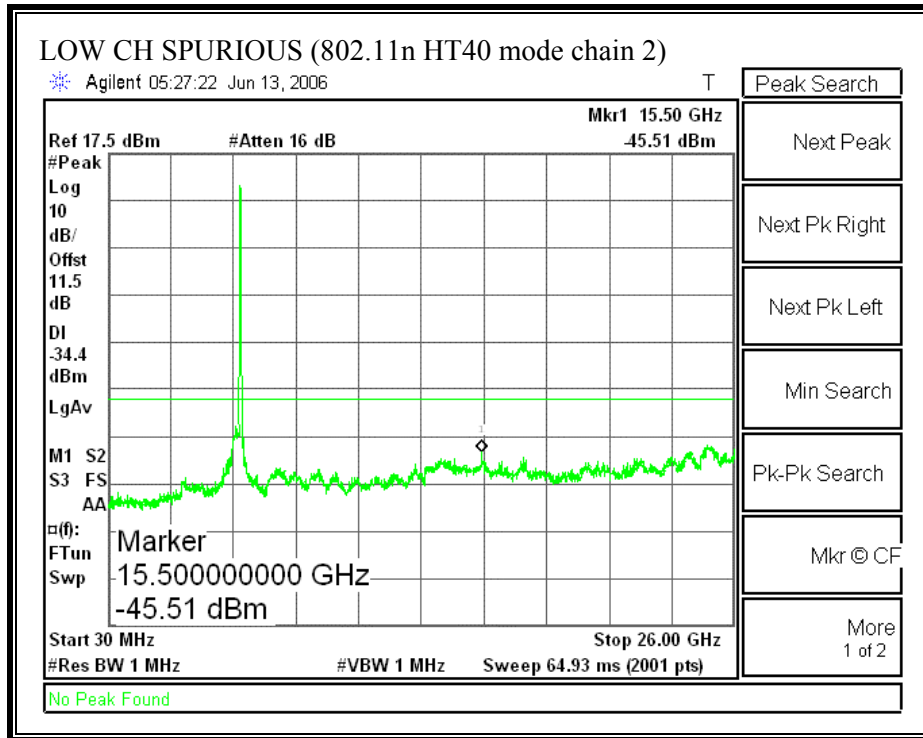

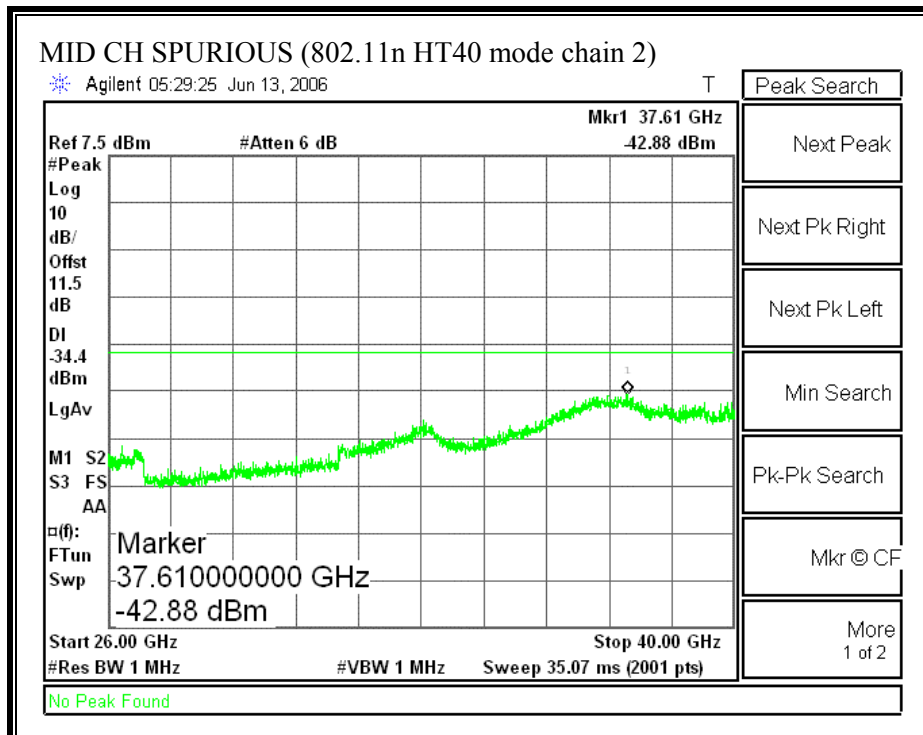
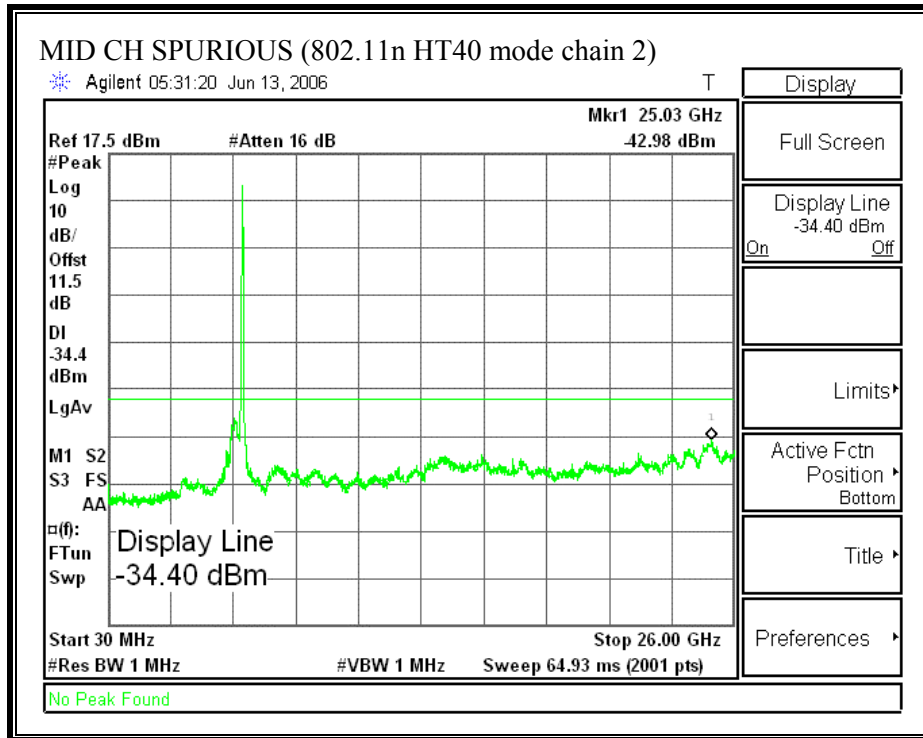

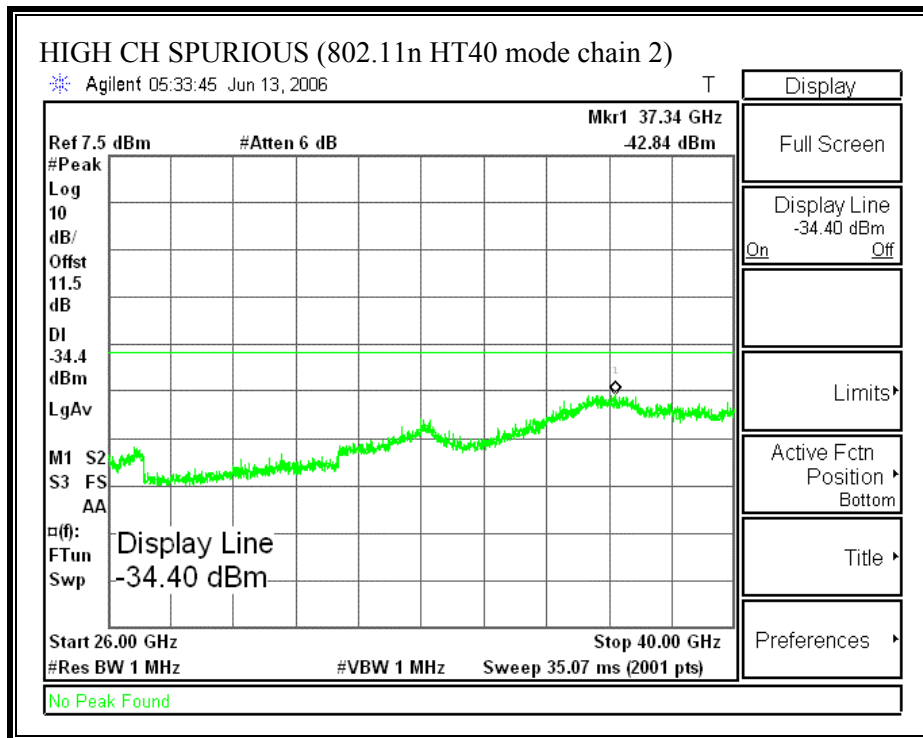
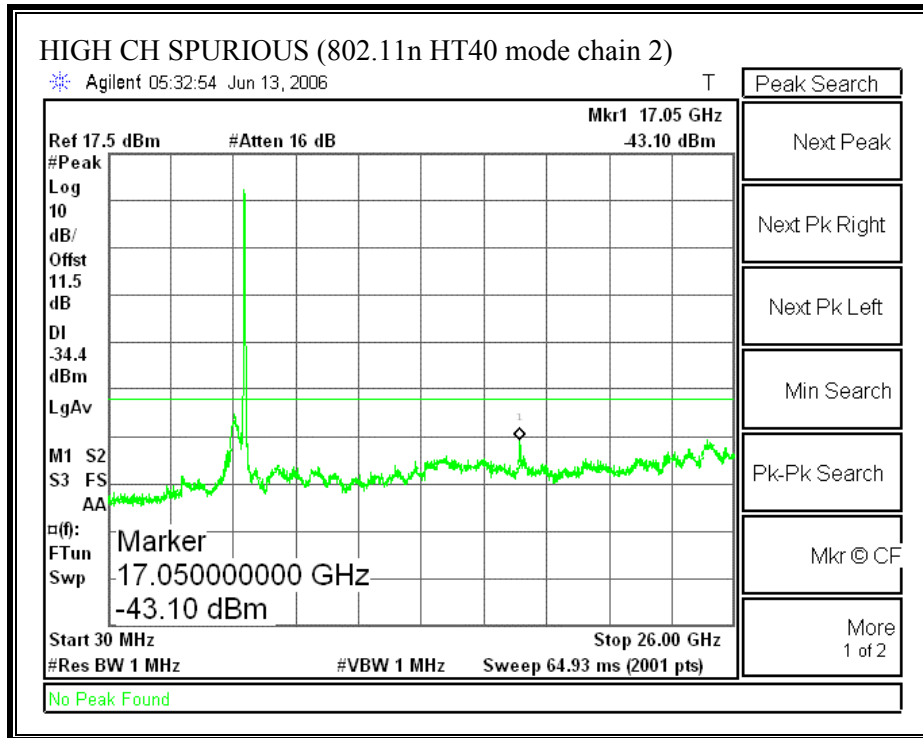

**SPURIOUS EMISSIONS (802.11a MODE COMBINED)**

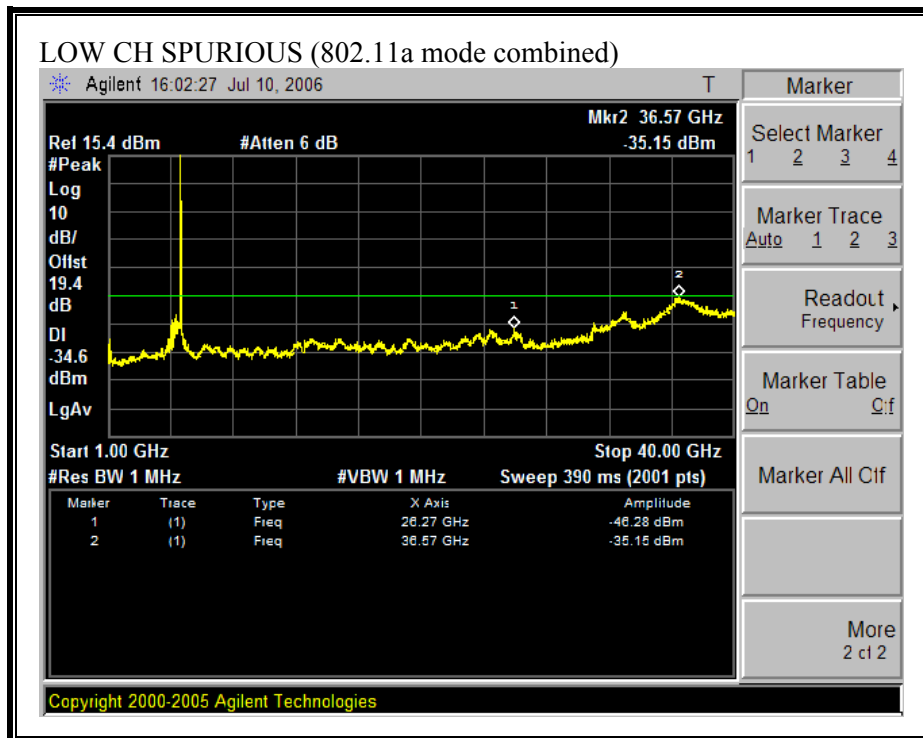
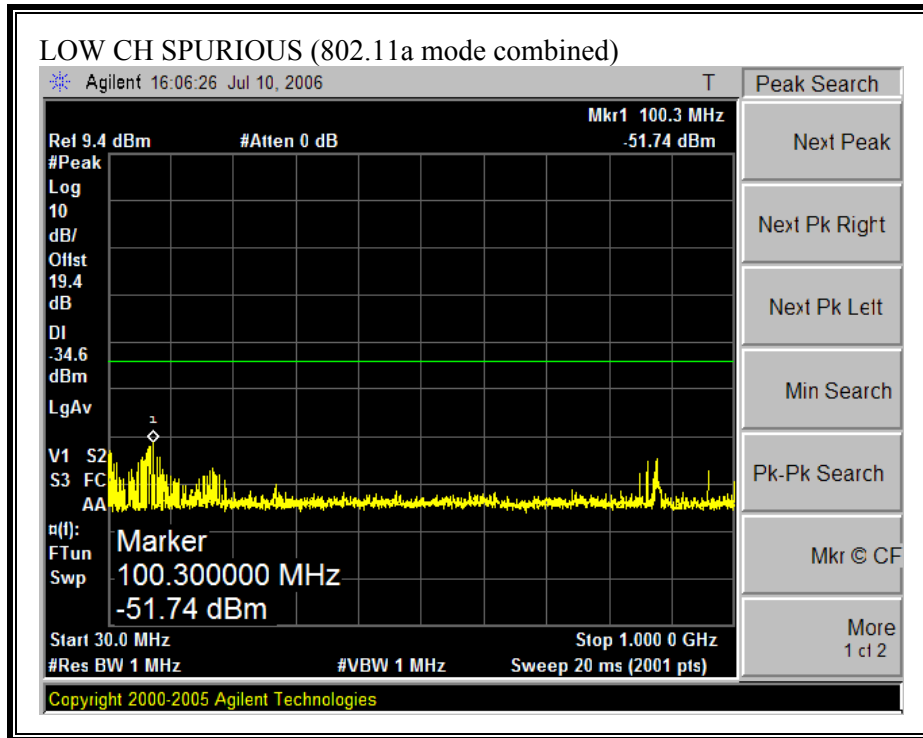



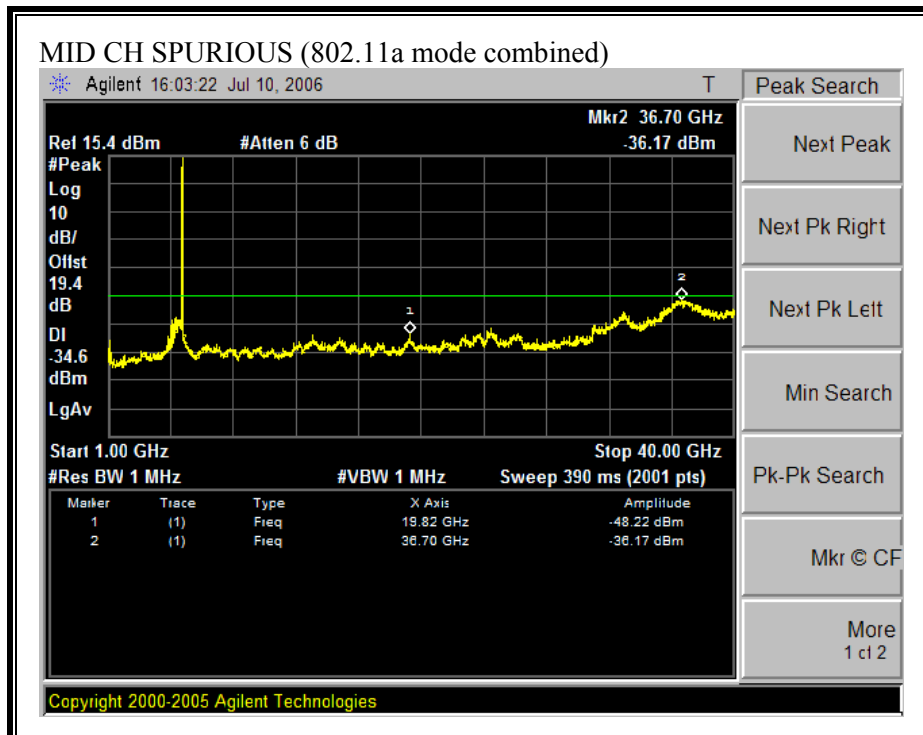
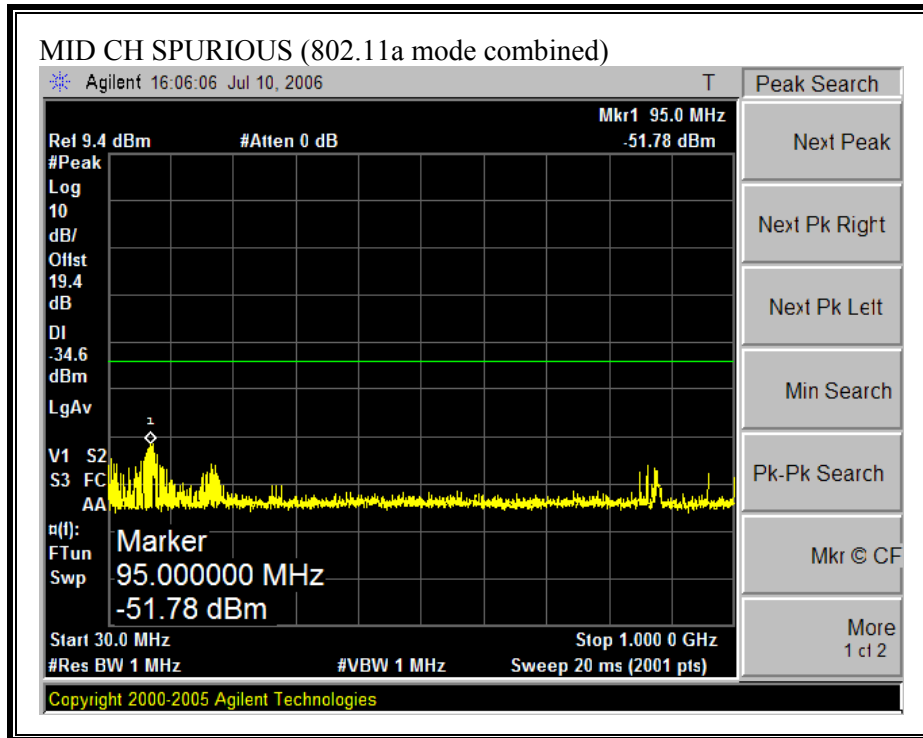

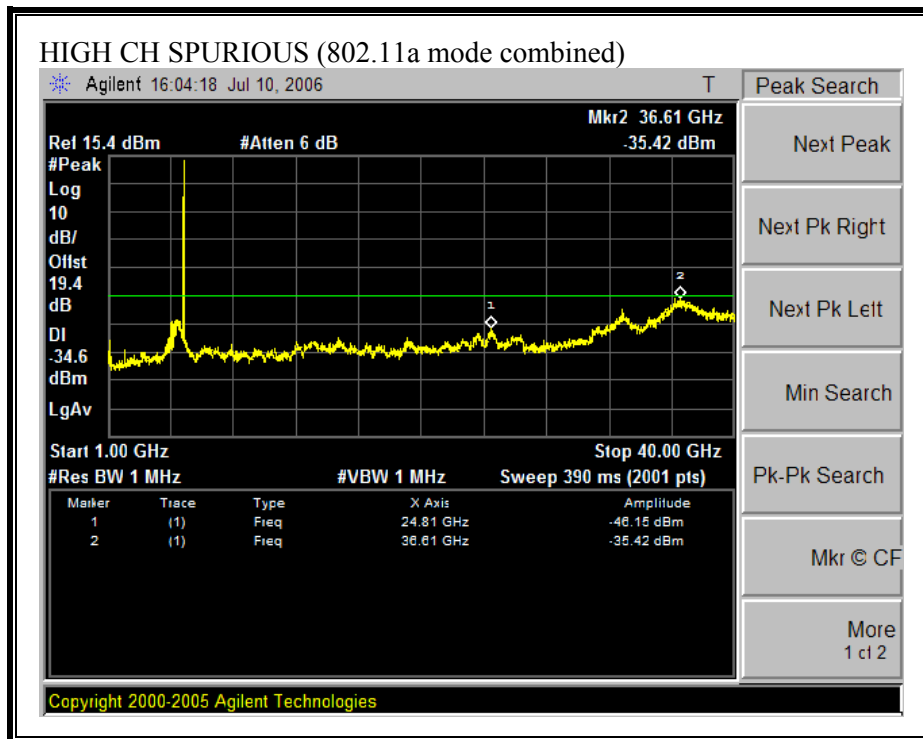
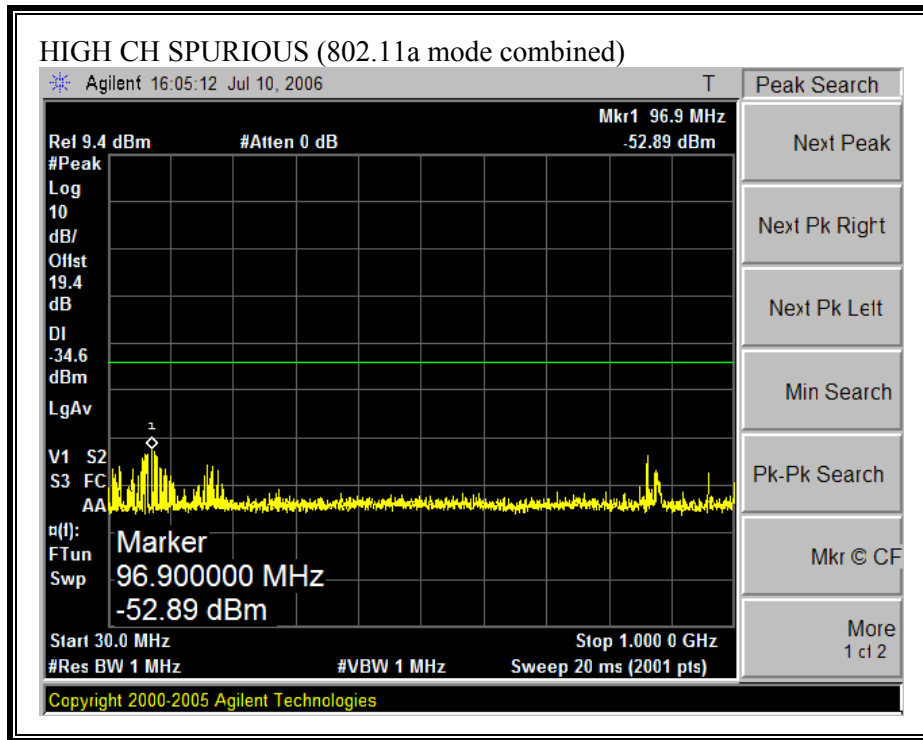

**SPURIOUS EMISSIONS (802.11n HT20 MODE COMBINED)**

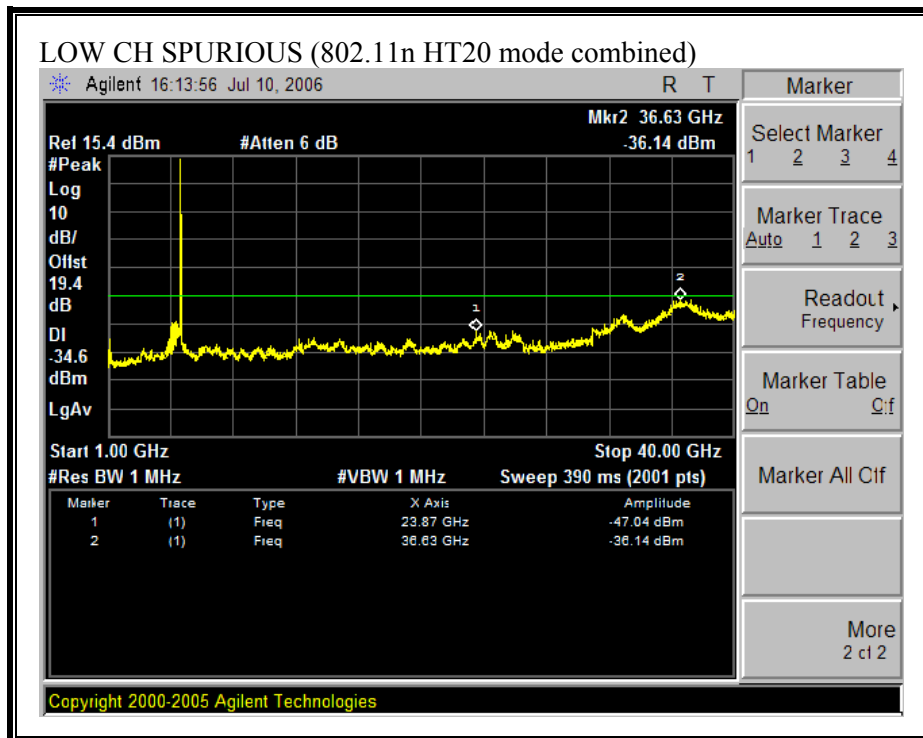
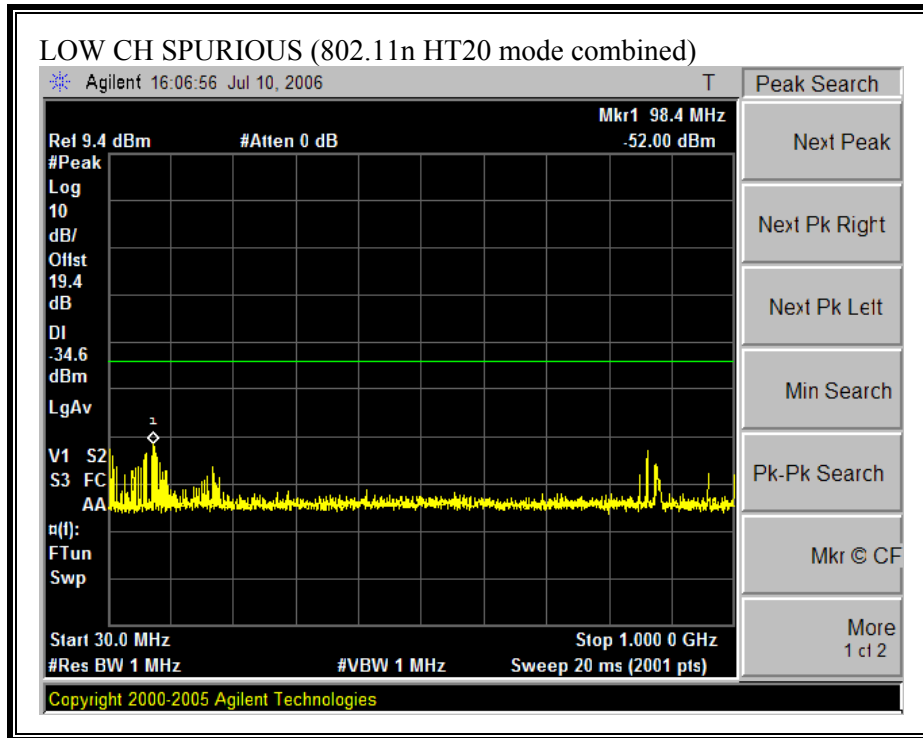

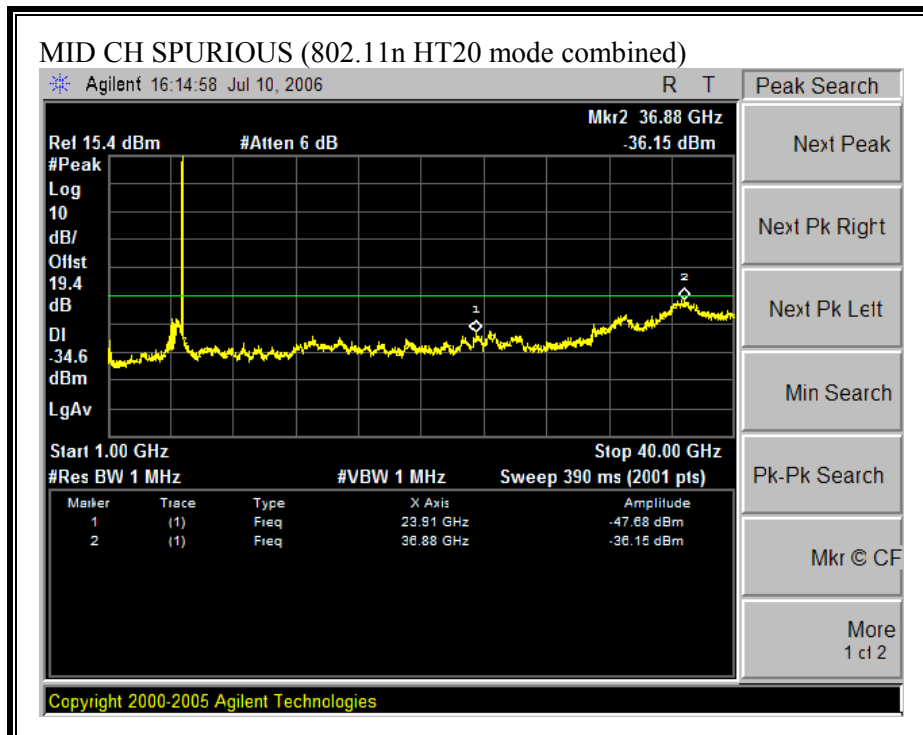
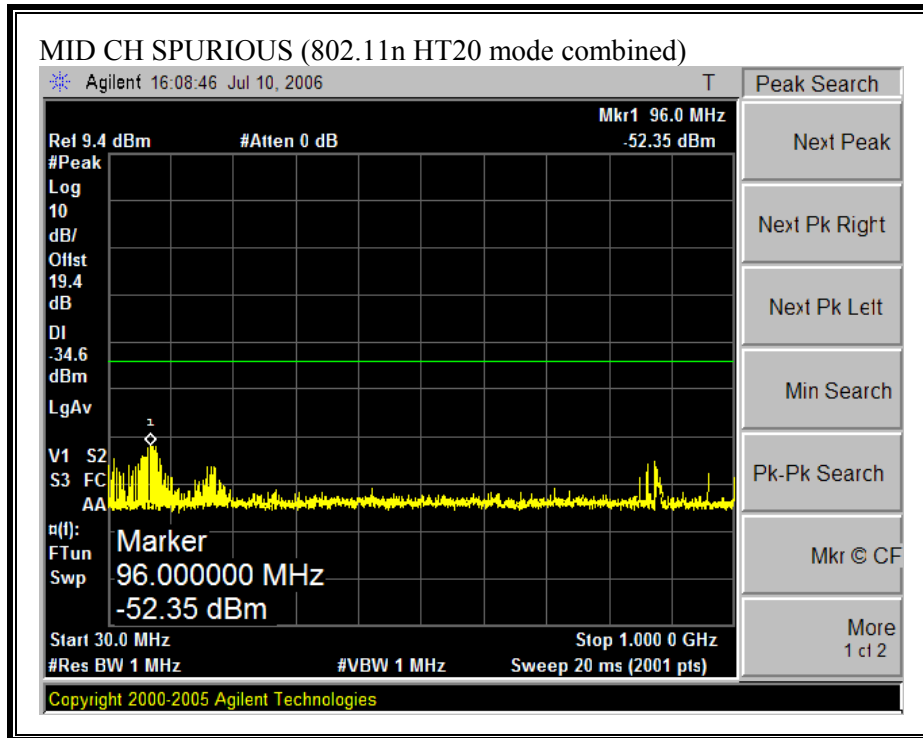

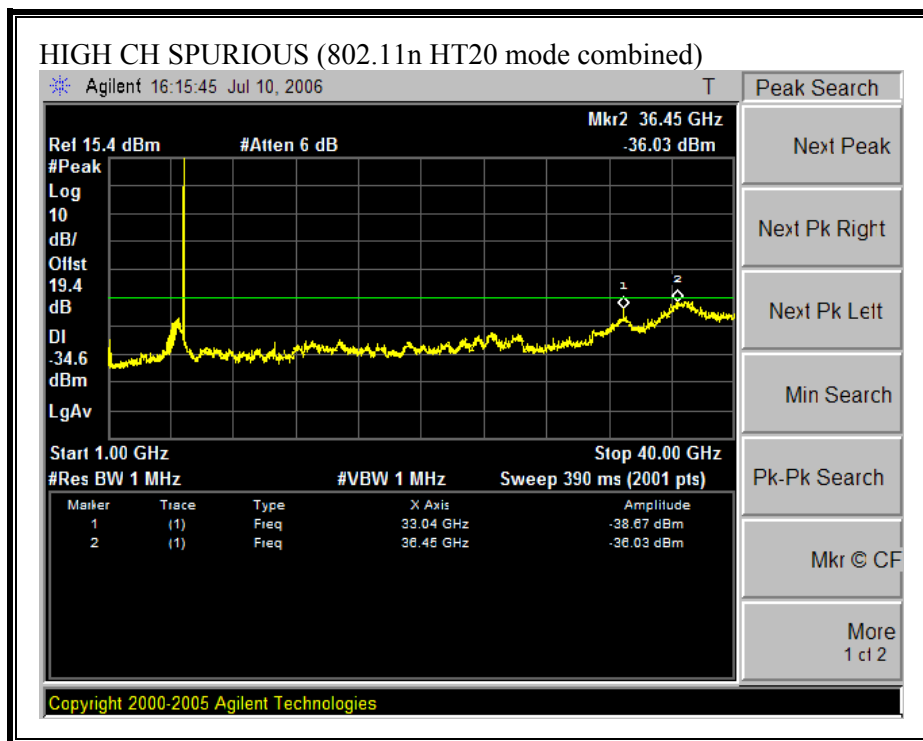
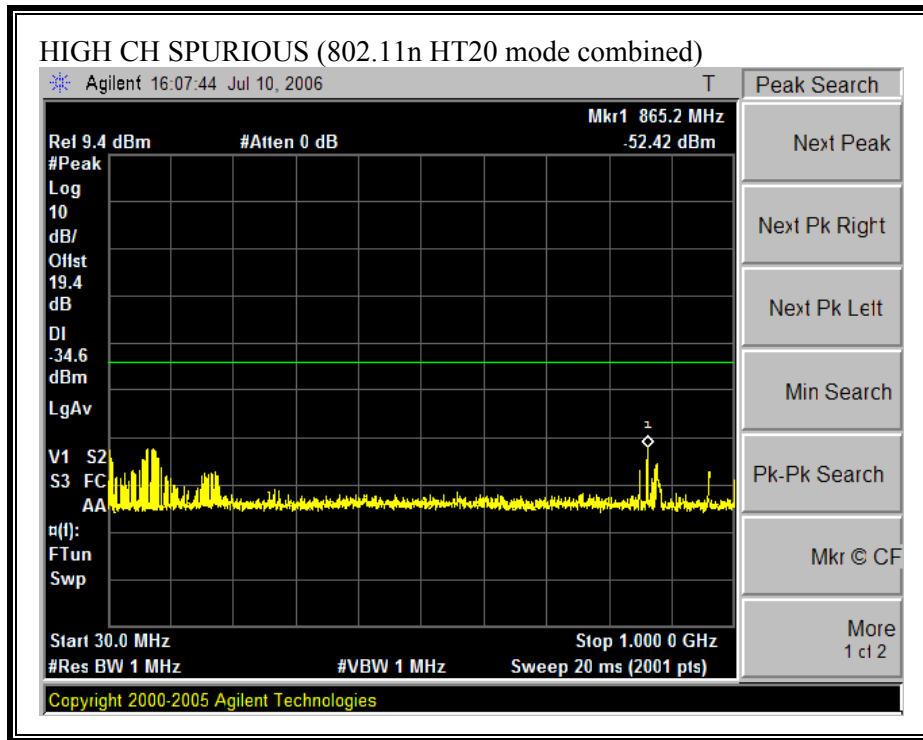

**SPURIOUS EMISSIONS (802.11n HT40 MODE COMBINED)**

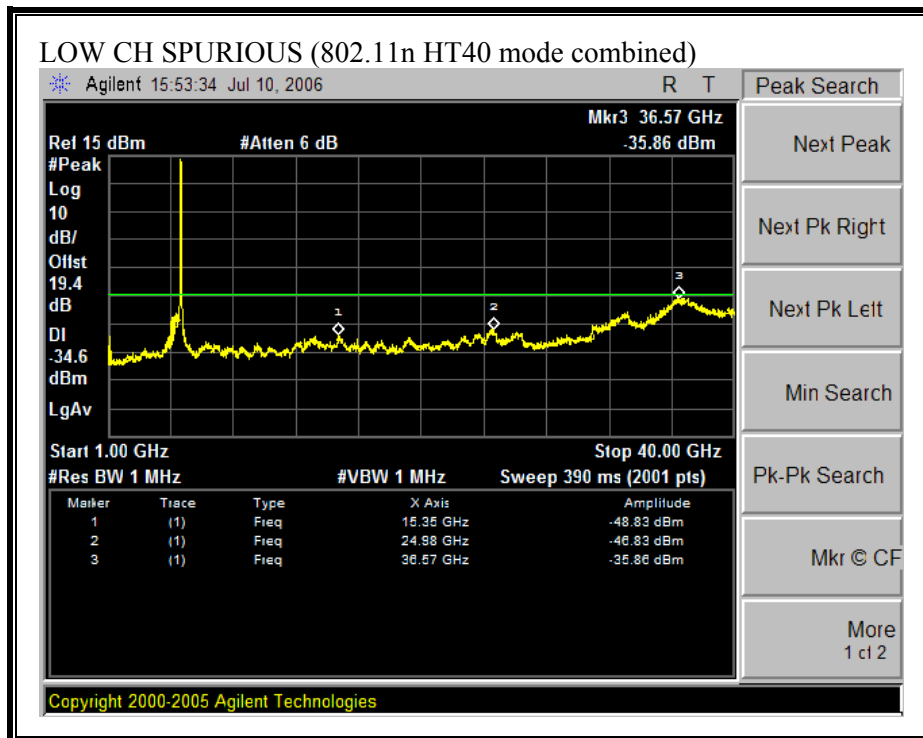
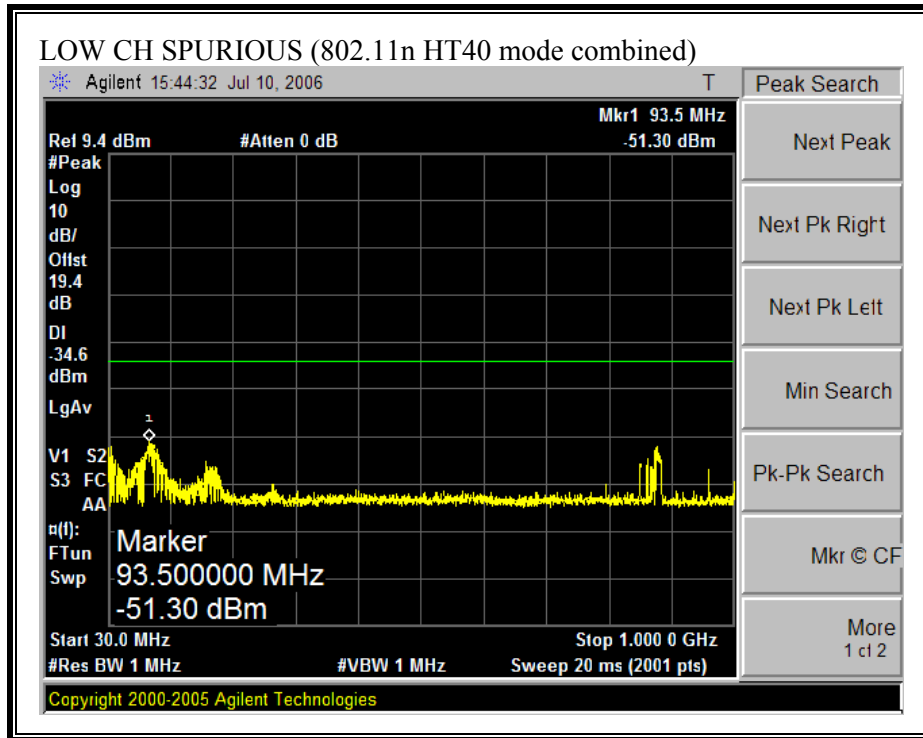

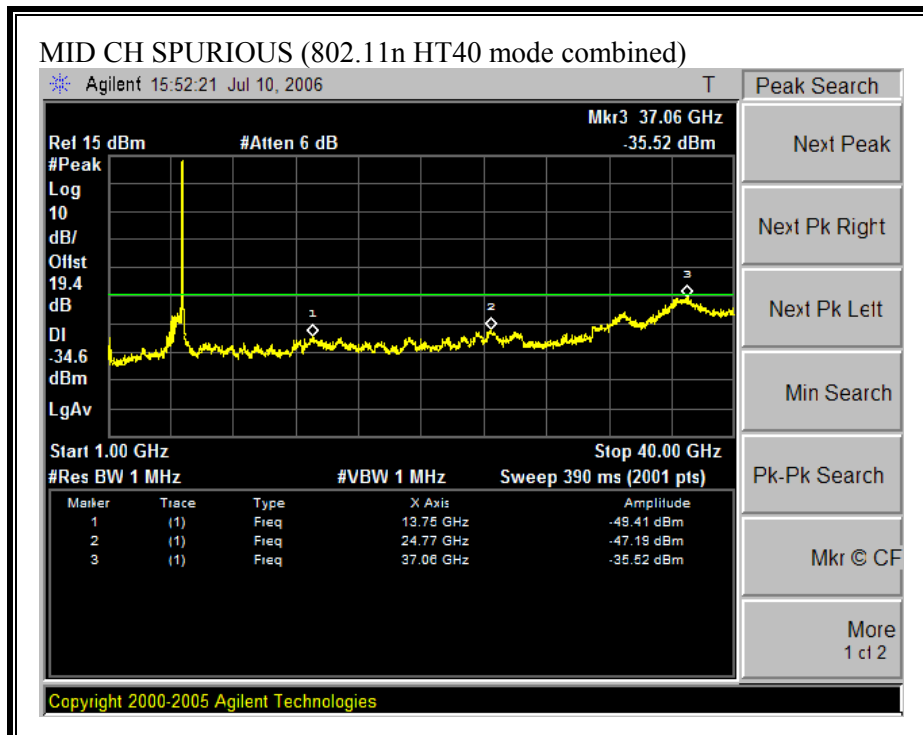
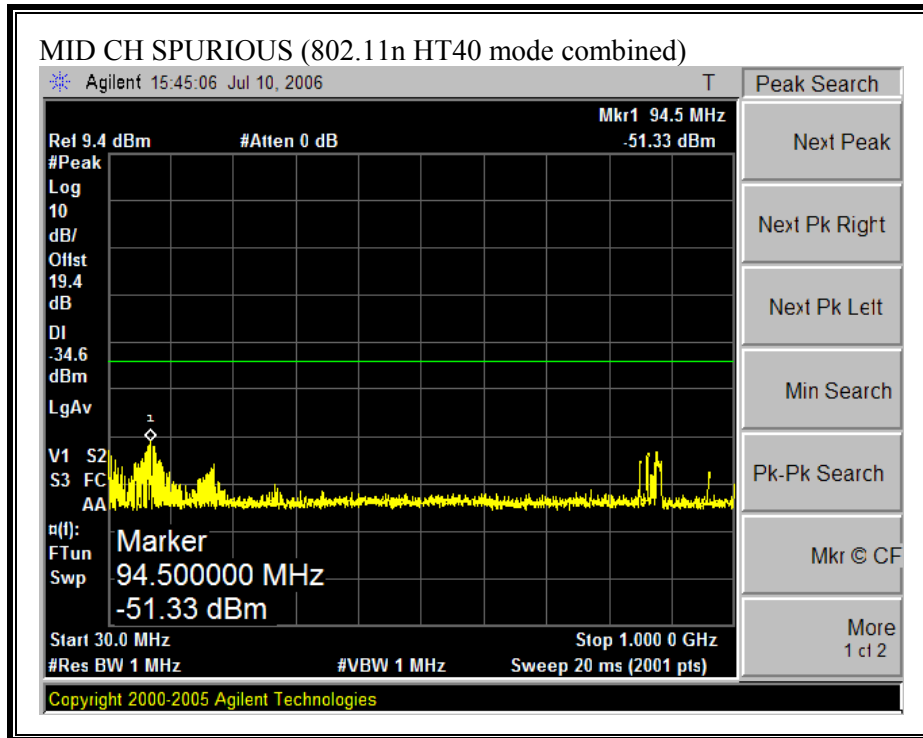

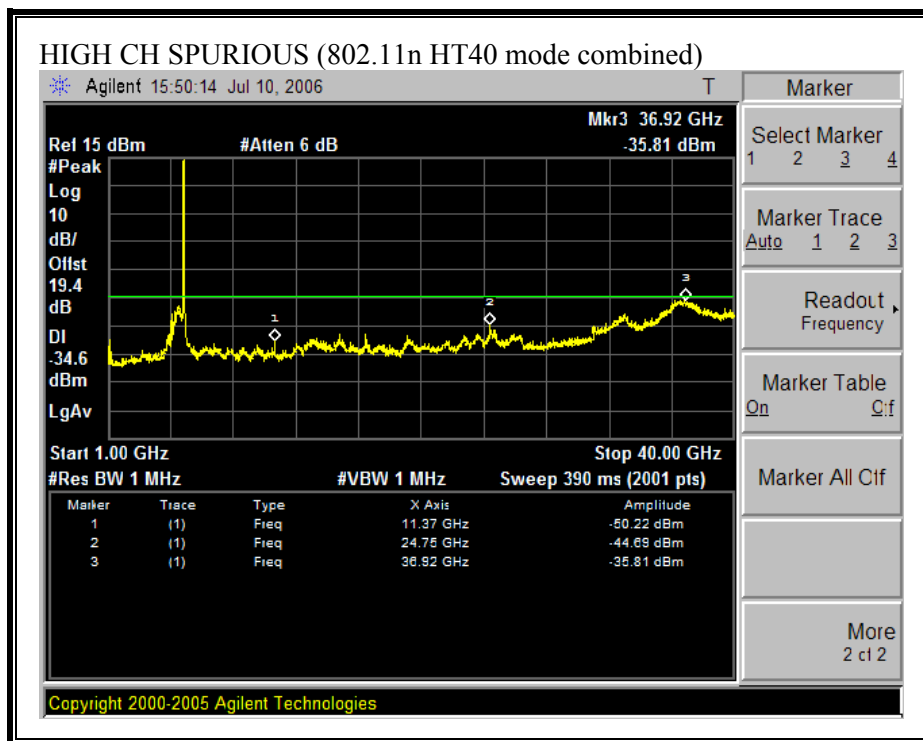
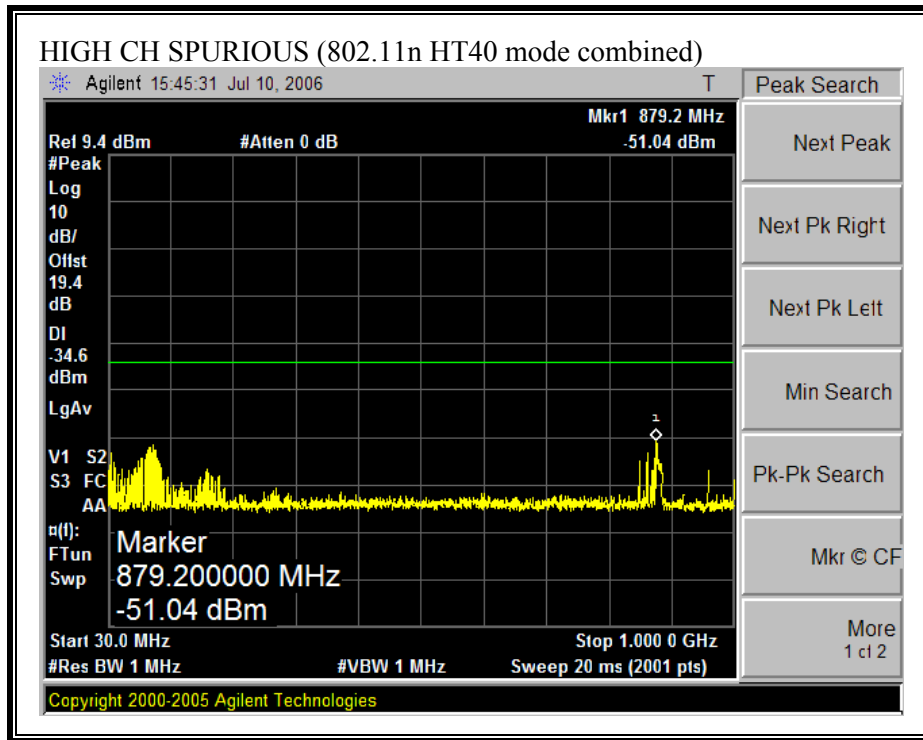



## 7.2. MAXIMUM PERMISSIBLE EXPOSURE

### LIMITS

§1.1310 The criteria listed in Table 1 shall be used to evaluate the environmental impact of human exposure to radio-frequency (RF) radiation as specified in §1.1307(b), except in the case of portable devices which shall be evaluated according to the provisions of §2.1093 of this chapter.

TABLE 1—LIMITS FOR MAXIMUM PERMISSIBLE EXPOSURE (MPE)

Frequency range (MHz)	Electric field strength (V/m)	Magnetic field strength (A/m)	Power density (mW/cm <sup>2</sup> )	Averaging time (minutes)
(A) Limits for Occupational/Controlled Exposures				
0.3–3.0 .....	614	1.63	*(100)	6
3.0–30 .....	1842/f	4.89/f	*(900/f <sup>2</sup> )	6
30–300 .....	61.4	0.163	1.0	6
300–1500 .....	.....	.....	f/300	6
1500–100,000 .....	.....	.....	5	6
(B) Limits for General Population/Uncontrolled Exposure				
0.3–1.34 .....	614	1.63	*(100)	30
1.34–30 .....	824/f	2.19/f	*(180/f <sup>2</sup> )	30

TABLE 1—LIMITS FOR MAXIMUM PERMISSIBLE EXPOSURE (MPE)—Continued

Frequency range (MHz)	Electric field strength (V/m)	Magnetic field strength (A/m)	Power density (mW/cm <sup>2</sup> )	Averaging time (minutes)
30–300 .....	27.5	0.073	0.2	30
300–1500 .....	.....	.....	f/1500	30
1500–100,000 .....	.....	.....	1.0	30

f = frequency in MHz

\* = Plane-wave equivalent power density

NOTE 1 TO TABLE 1: Occupational/controlled limits apply in situations in which persons are exposed as a consequence of their employment provided those persons are fully aware of the potential for exposure and can exercise control over their exposure. Limits for occupational/controlled exposure also apply in situations when an individual is transient through a location where occupational/controlled limits apply provided he or she is made aware of the potential for exposure.

NOTE 2 TO TABLE 1: General population/uncontrolled exposures apply in situations in which the general public may be exposed, or in which persons that are exposed as a consequence of their employment may not be fully aware of the potential for exposure or can not exercise control over their exposure.

## **CALCULATIONS**

Given

$$E = \sqrt{(30 * P * G) / d}$$

and

$$S = E^2 / 3770$$

where

E = Field Strength in Volts/meter

P = Power in Watts

G = Numeric antenna gain

d = Distance in meters

S = Power Density in milliwatts/square centimeter

Combining equations yields:

$$S = (30 * P * G) / (3770 * (d^2))$$

Changing to units of Power to mW and Distance to cm, using:

$$P (W) = P (mW) / 1000 \text{ and}$$

$$d (m) = d (cm) / 100$$

and substituting the logarithmic form of power and gain using:

$$P (mW) = 10^{(P (dBm) / 10)} \text{ and}$$

$$G (\text{numeric}) = 10^{(G (dBi) / 10)}$$

yields

$$S = 0.0795 * 10^{((P + G) / 10)} / (d^2)$$

where

d = MPE distance in cm

P = Power in dBm

G = Antenna Gain in dBi

S = Power Density Limit in mW/cm<sup>2</sup>

**LIMITS**

From §1.1310 Table 1 (B), the maximum value of S = 1.0 mW/cm<sup>2</sup>

**RESULTS**

No non-compliance noted: (MPE distance equals 20 cm)

5250 to 5350 MHz Band

Mode	MPE Distance (cm)	Total Power (dBm)	Antenna Gain (dBi)	Power Density (mW/cm <sup>2</sup> )
802.11a *	20.0	17.77	9.21	0.10
802.11n HT20	20.0	20.48	6.20	0.09
802.11n HT40	20.0	19.83	6.20	0.08

5470 to 5725 MHz Band

Mode	MPE Distance (cm)	Total Power (dBm)	Antenna Gain (dBi)	Power Density (mW/cm <sup>2</sup> )
802.11a *	20.0	18.51	8.35	0.10
802.11n HT20	20.0	20.68	5.34	0.08
802.11n HT40	20.0	20.55	5.34	0.08

\* Note: The antenna gain for this mode is the effective legacy gain.

NOTE: For mobile or fixed location transmitters, the minimum separation distance is 20 cm, even if calculations indicate that the MPE distance would be less.

### 7.3. RADIATED EMISSIONS

#### 7.3.1. TRANSMITTER RADIATED SPURIOUS EMISSIONS

##### LIMITS

§15.205 (a) Except as shown in paragraph (d) of this section, only spurious emissions are permitted in any of the frequency bands listed below:

MHz	MHz	MHz	GHz
0.090 - 0.110	16.42 - 16.423	399.9 - 410	4.5 - 5.15
<sup>1</sup> 0.495 - 0.505	16.69475 - 16.69525	608 - 614	5.35 - 5.46
2.1735 - 2.1905	16.80425 - 16.80475	960 - 1240	7.25 - 7.75
4.125 - 4.128	25.5 - 25.67	1300 - 1427	8.025 - 8.5
4.17725 - 4.17775	37.5 - 38.25	1435 - 1626.5	9.0 - 9.2
4.20725 - 4.20775	73 - 74.6	1645.5 - 1646.5	9.3 - 9.5
6.215 - 6.218	74.8 - 75.2	1660 - 1710	10.6 - 12.7
6.26775 - 6.26825	108 - 121.94	1718.8 - 1722.2	13.25 - 13.4
6.31175 - 6.31225	123 - 138	2200 - 2300	14.47 - 14.5
8.291 - 8.294	149.9 - 150.05	2310 - 2390	15.35 - 16.2
8.362 - 8.366	156.52475 - 156.52525	2483.5 - 2500	17.7 - 21.4
8.37625 - 8.38675	156.7 - 156.9	2655 - 2900	22.01 - 23.12
8.41425 - 8.41475	162.0125 - 167.17	3260 - 3267	23.6 - 24.0
12.29 - 12.293	167.72 - 173.2	3332 - 3339	31.2 - 31.8
12.51975 - 12.52025	240 - 285	3345.8 - 3358	36.43 - 36.5
12.57675 - 12.57725	322 - 335.4	3600 - 4400	( <sup>2</sup> )
13.36 - 13.41			

<sup>1</sup> Until February 1, 1999, this restricted band shall be 0.490-0.510 MHz.

<sup>2</sup> Above 38.6

§15.205 (b) Except as provided in paragraphs (d) and (e), the field strength of emissions appearing within these frequency bands shall not exceed the limits shown in Section 15.209. At frequencies equal to or less than 1000 MHz, compliance with the limits in Section 15.209 shall be demonstrated using measurement instrumentation employing a CISPR quasi-peak detector. Above 1000 MHz, compliance with the emission limits in Section 15.209 shall be demonstrated based on the average value of the measured emissions. The provisions in Section 15.35 apply to these measurements.

§15.209 (a) Except as provided elsewhere in this Subpart, the emissions from an intentional radiator shall not exceed the field strength levels specified in the following table:

Frequency (MHz)	Field Strength (microvolts/meter)	Measurement Distance (meters)
30 - 88	100 **	3
88 - 216	150 **	3
216 - 960	200 **	3
Above 960	500	3

\*\* Except as provided in paragraph (g), fundamental emissions from intentional radiators operating under this Section shall not be located in the frequency bands 54-72 MHz, 76-88 MHz, 174-216 MHz or 470-806 MHz. However, operation within these frequency bands is permitted under other sections of this Part, e.g., Sections 15.231 and 15.241.

§15.209 (b) In the emission table above, the tighter limit applies at the band edges.

## **TEST PROCEDURE**

The EUT is placed on a non-conducting table 80 cm above the ground plane. The antenna to EUT distance is 3 meters. The EUT is configured in accordance with ANSI C63.4. The EUT is set to transmit in a continuous mode.

For measurements below 1 GHz the resolution bandwidth is set to 100 kHz for peak detection measurements or 120 kHz for quasi-peak detection measurements. Peak detection is used unless otherwise noted as quasi-peak.

For measurements above 1 GHz the resolution bandwidth is set to 1 MHz, then the video bandwidth is set to 1 MHz for peak measurements and 10 Hz for average measurements.

The spectrum from 30 MHz to 40 GHz is investigated with the transmitter set to the lowest, middle, and highest channels in each band.

The frequency range of interest is monitored at a fixed antenna height and EUT azimuth. The EUT is rotated through 360 degrees to maximize emissions received. The antenna is scanned from 1 to 4 meters above the ground plane to further maximize the emission. Measurements are made with the antenna polarized in both the vertical and the horizontal positions.

## **REPORTING NOTES**

The nearby restricted band stops 10 MHz below the authorized band. A single plot is taken to show both restricted band emission levels and out-of-band radiated spurious emission levels at and near the lower authorized bandedge. The out-of-band spurious limits of -7 dBm Peak EIRP and -27 dBm Average EIRP are converted to the equivalent 3 meter field strengths of 88.2 dBuV/m Peak and 68.2 dBuV/m Average, respectively, for reporting purposes.

The out-of- band radiated spurious emission levels at and near the upper authorized bandedge are reported as EIRP values.

### 7.3.2. TRANSMITTER ABOVE 1 GHz FOR 5470 TO 5725 MHz BAND WITH PIFA ANTENNAS

#### RESTRICTED BANDEDGE (802.11a MODE, LOW CHANNEL)

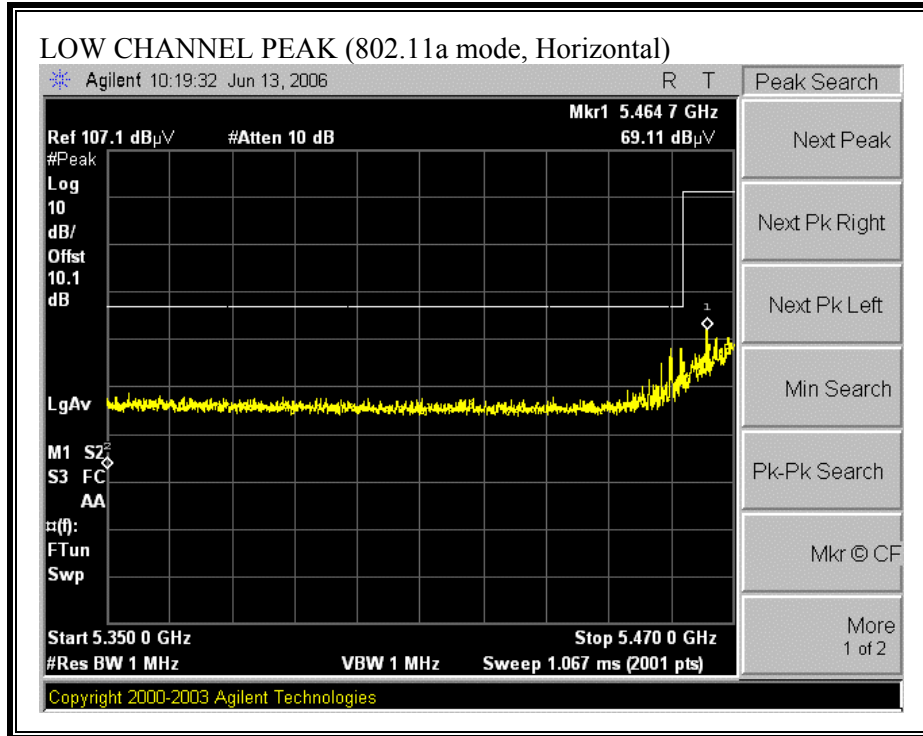

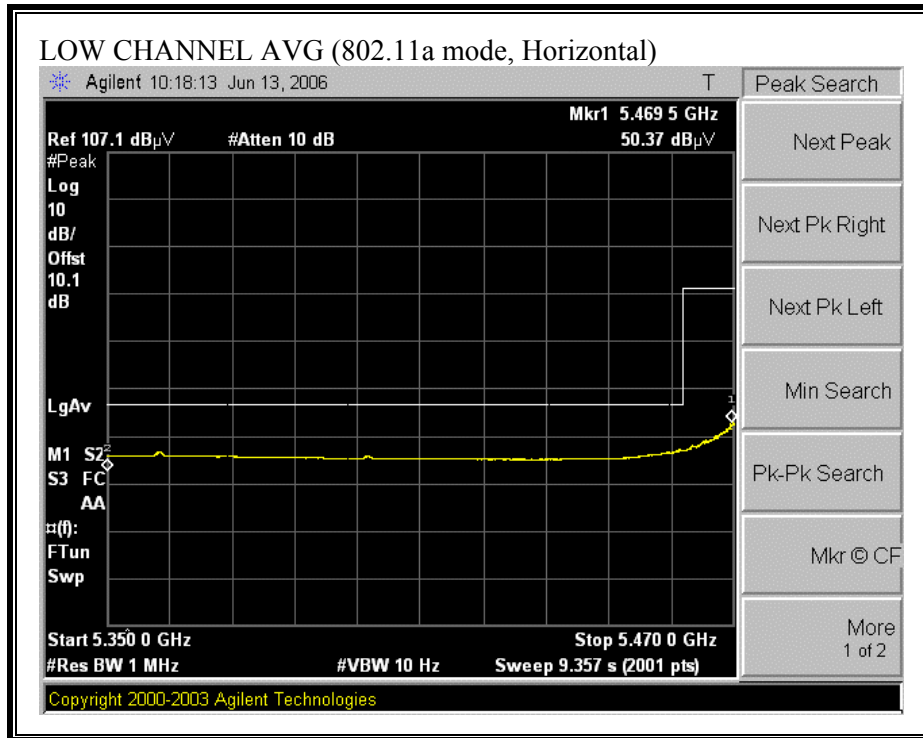



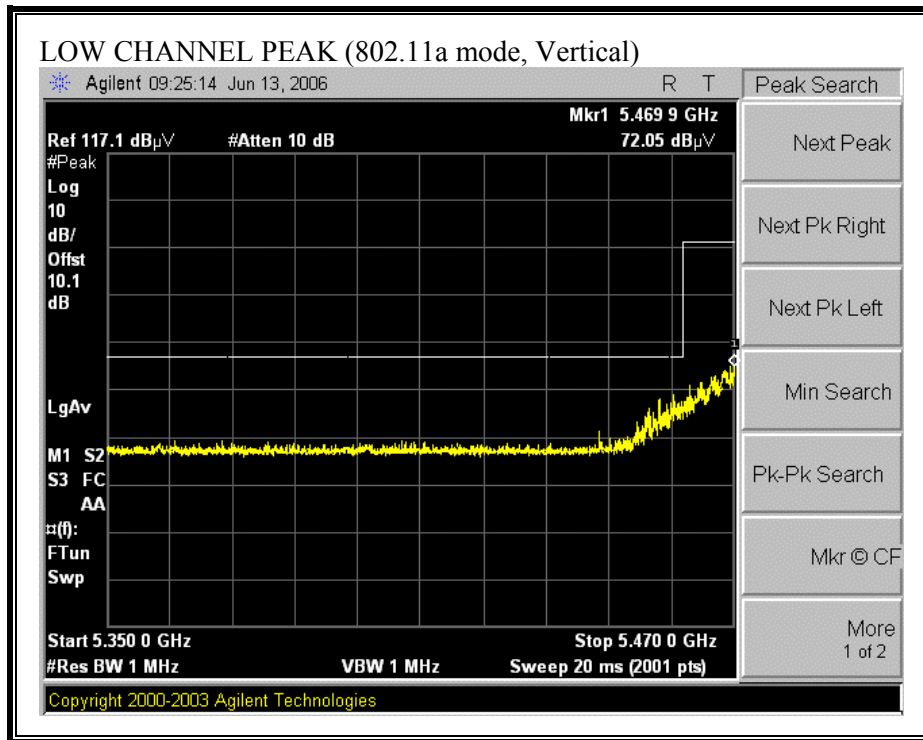

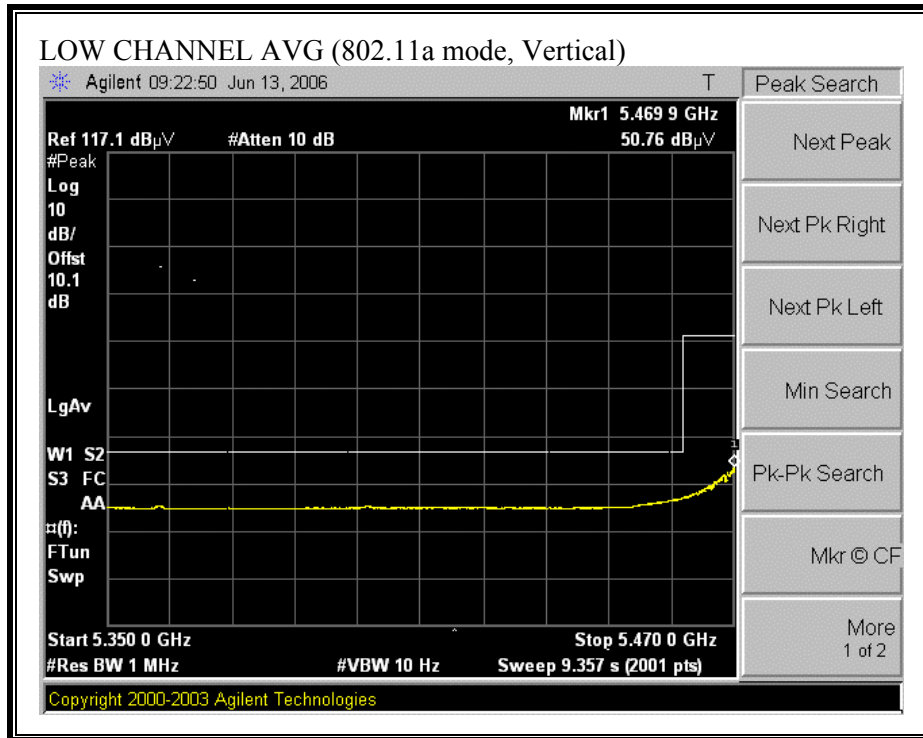

**BANDEDGE (802.11a MODE, HIGH CHANNEL)**

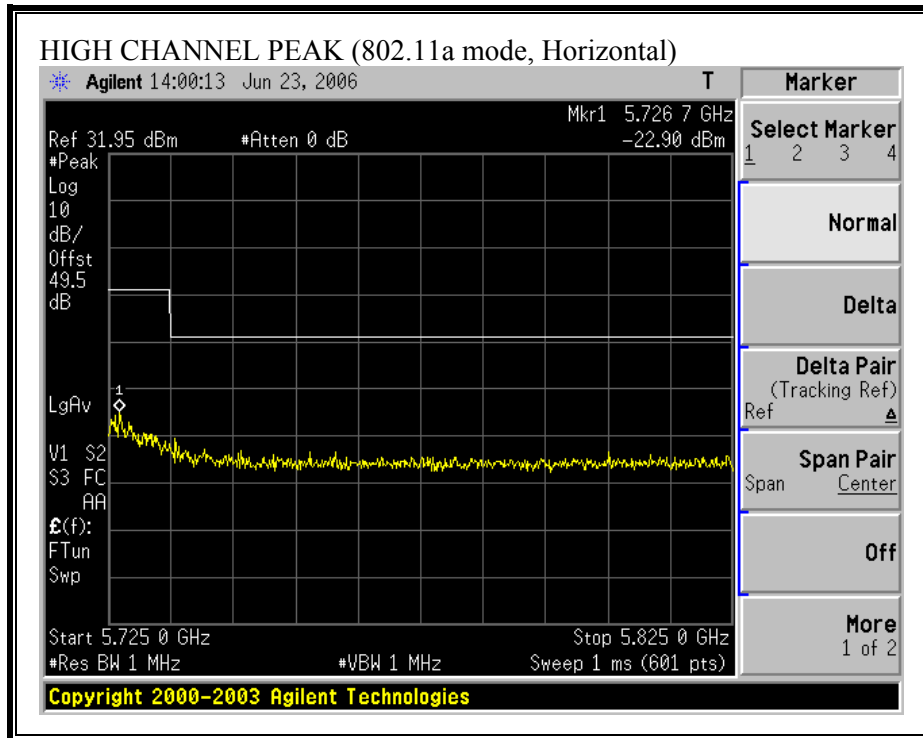

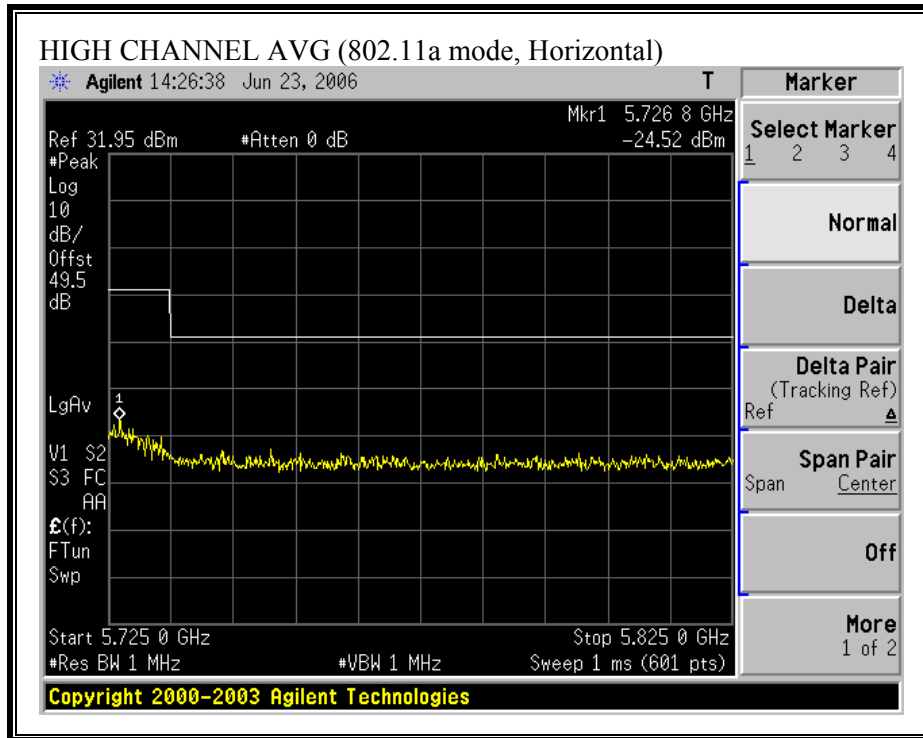

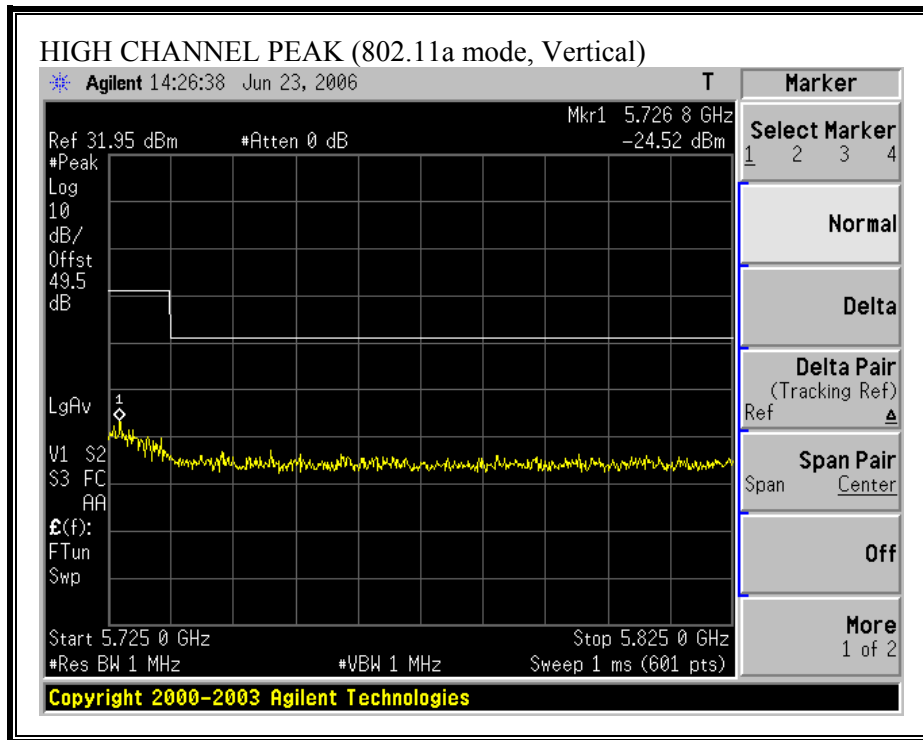

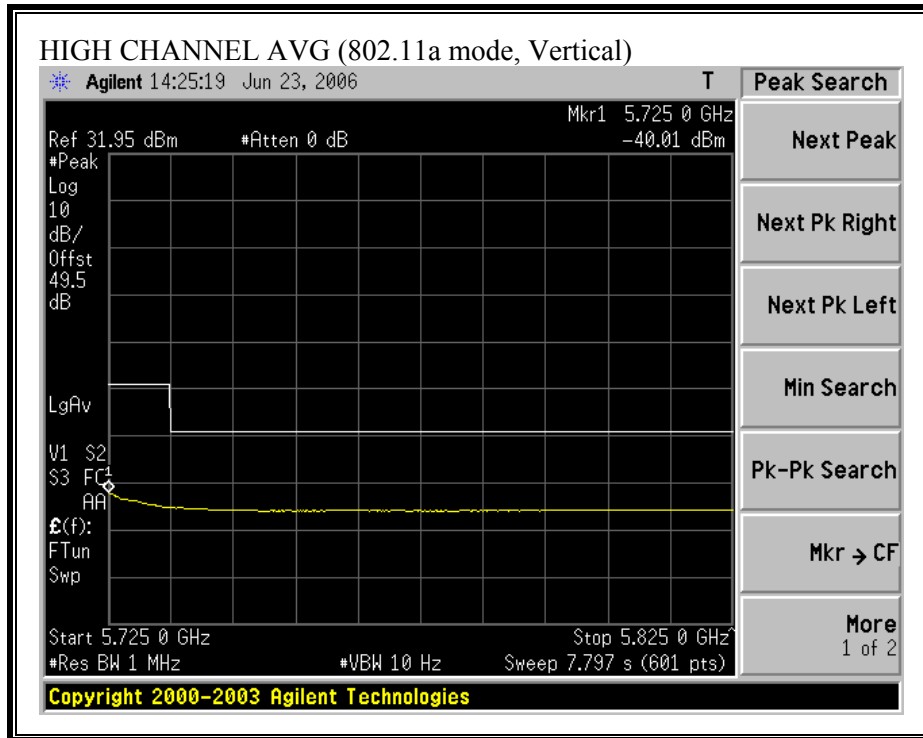

**RESTRICTED BANDEDGE (802.11n MODE HT20, LOW CHANNEL)**

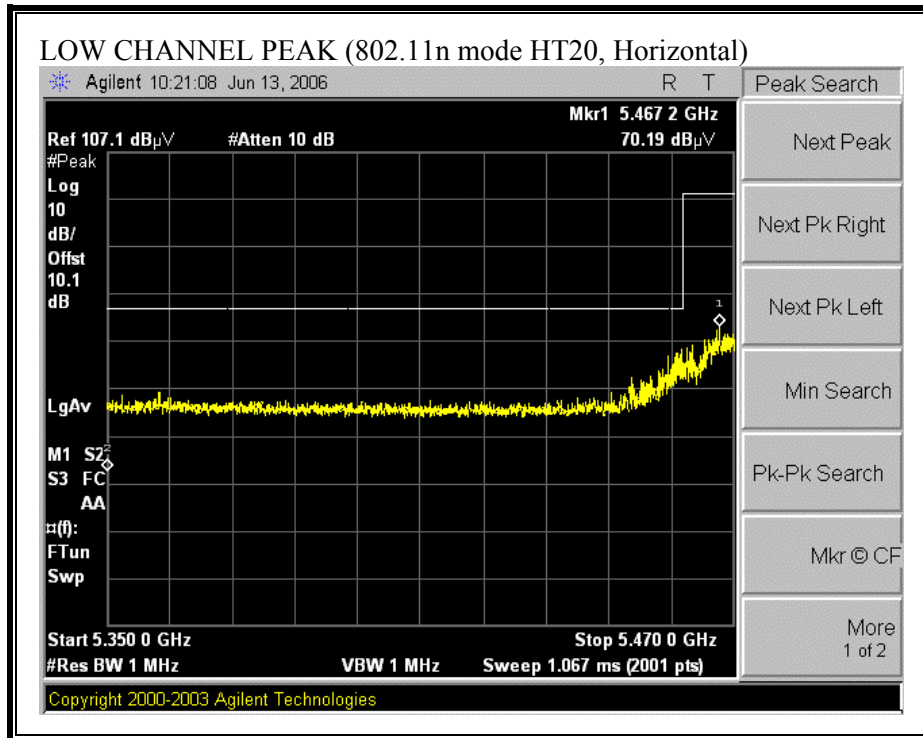

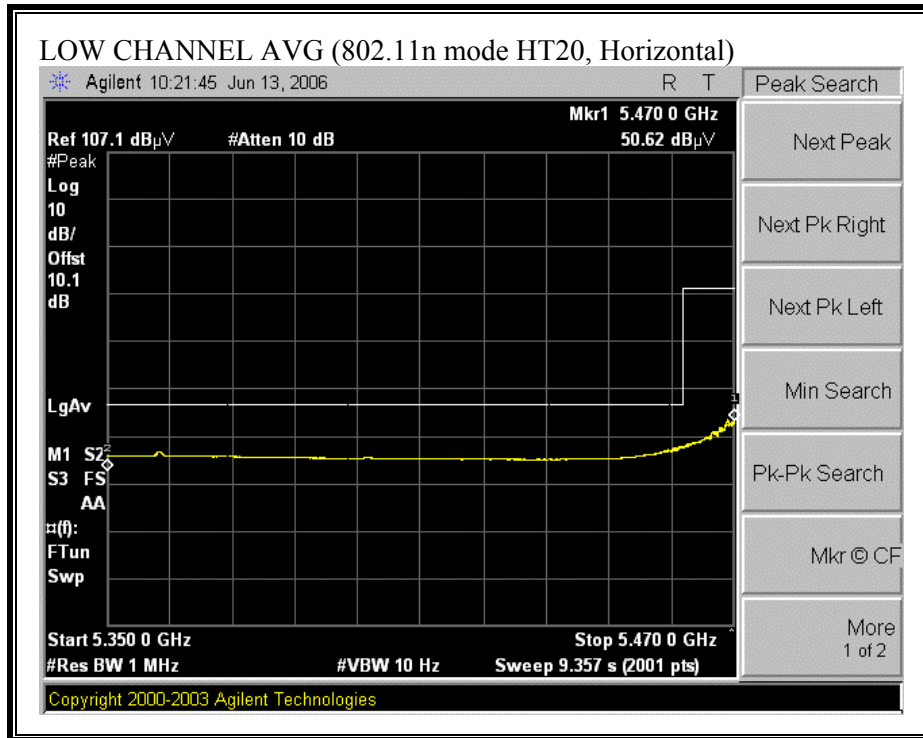



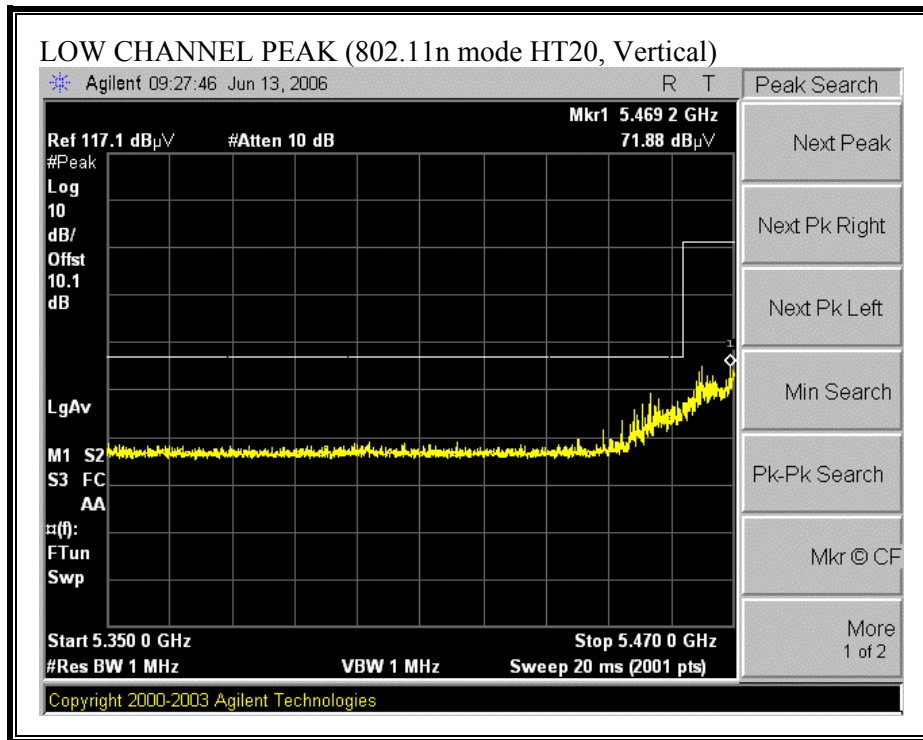

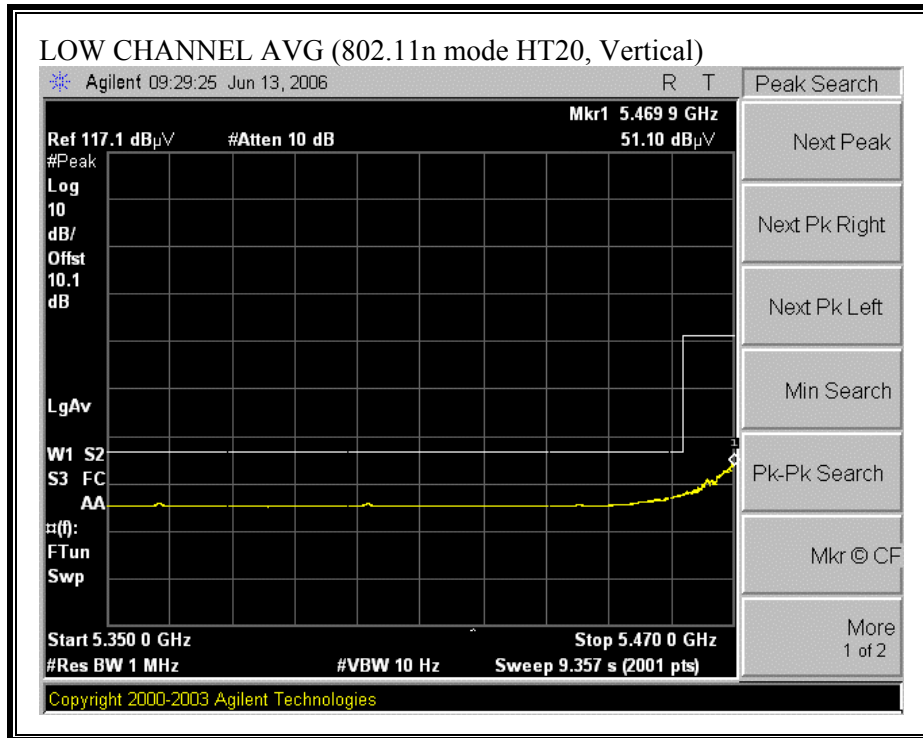

**BANDEDGE (802.11n MODE HT20, HIGH CHANNEL)**

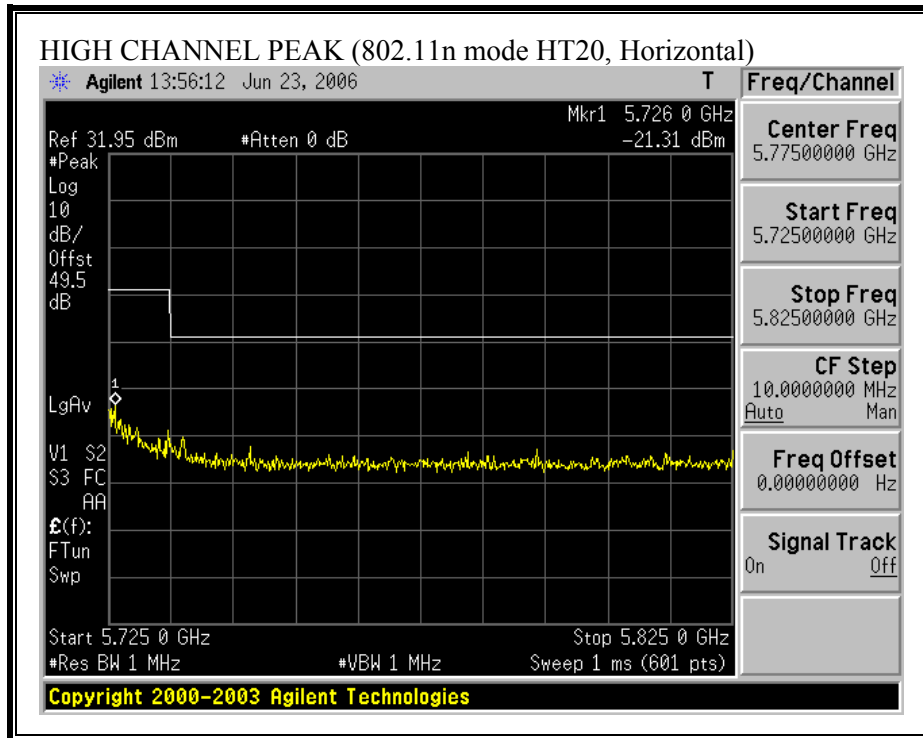

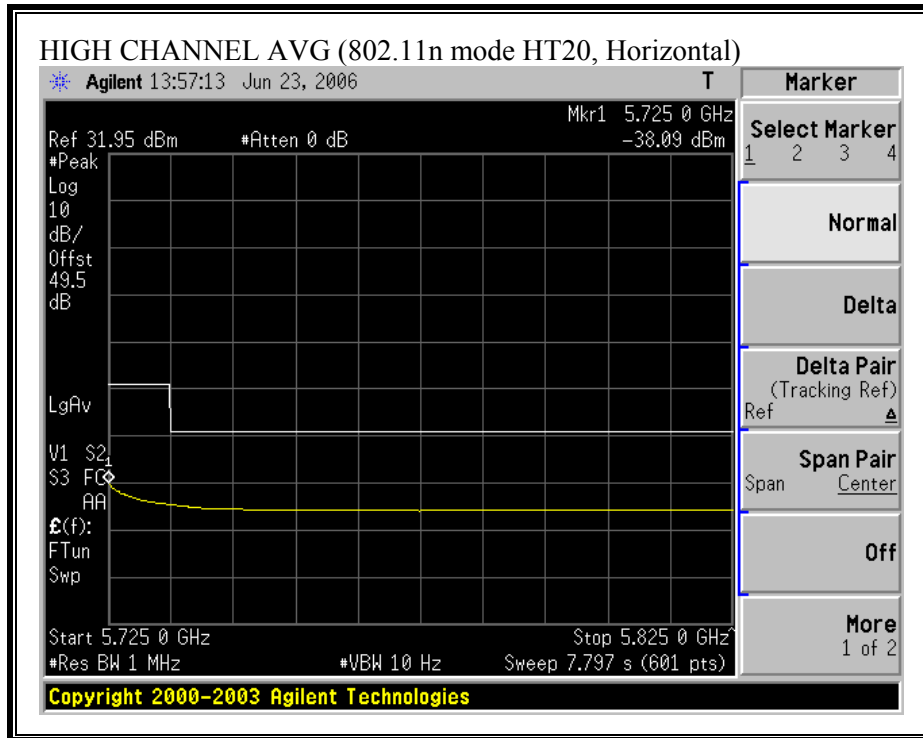

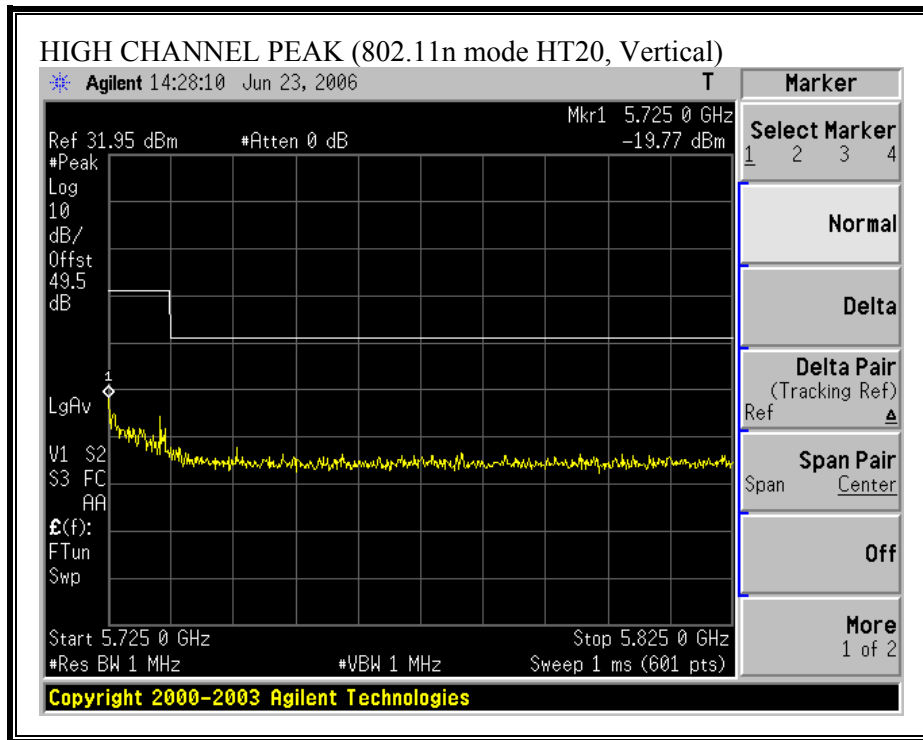

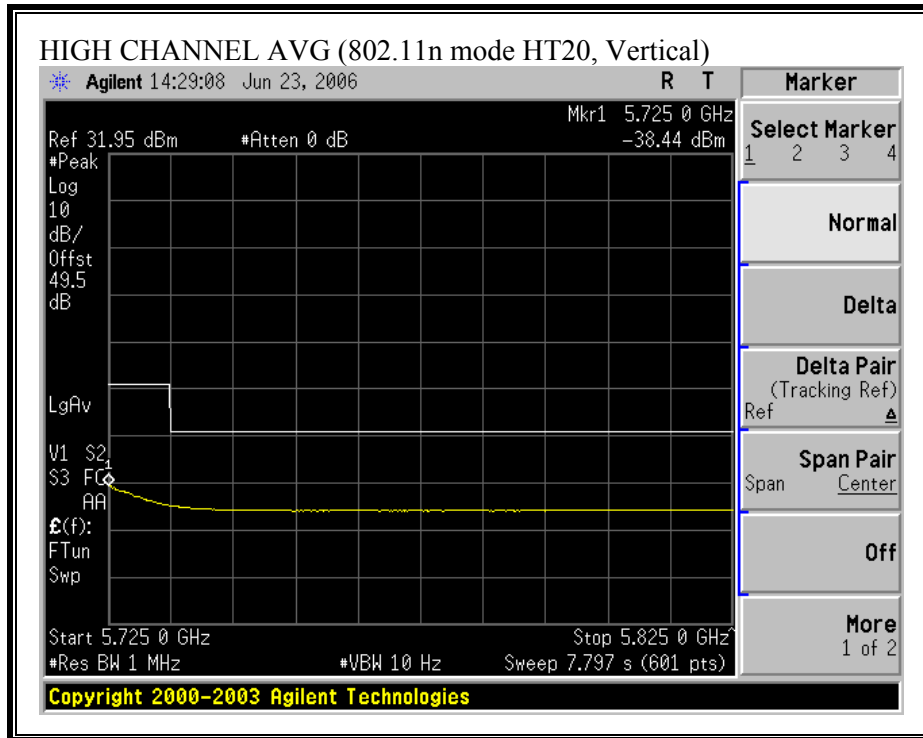

**RESTRICTED BANDEDGE (802.11n MODE HT40, LOW CHANNEL)**

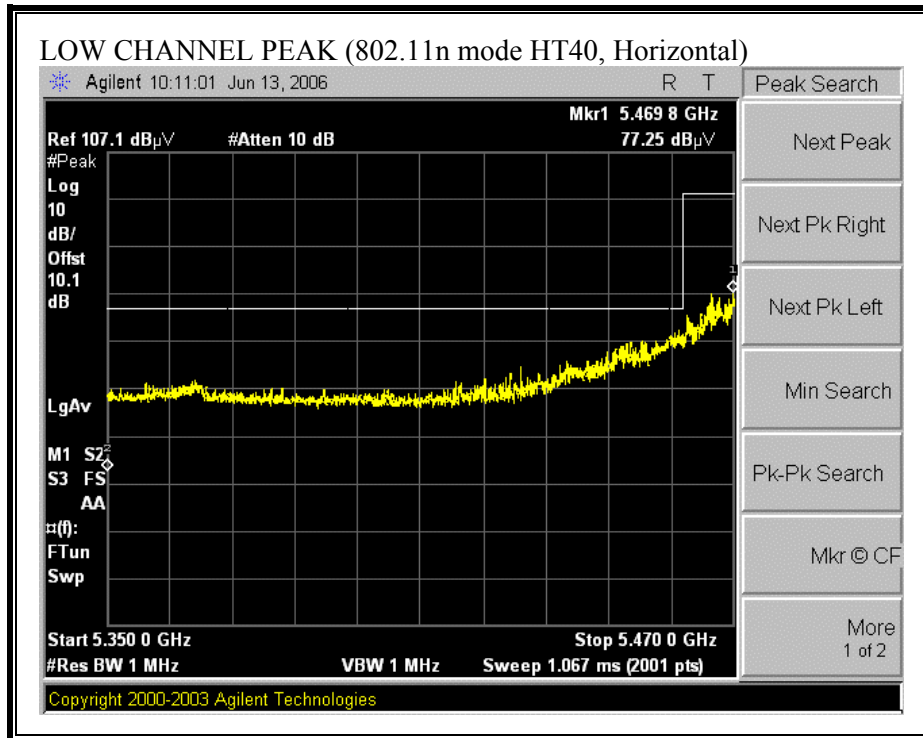

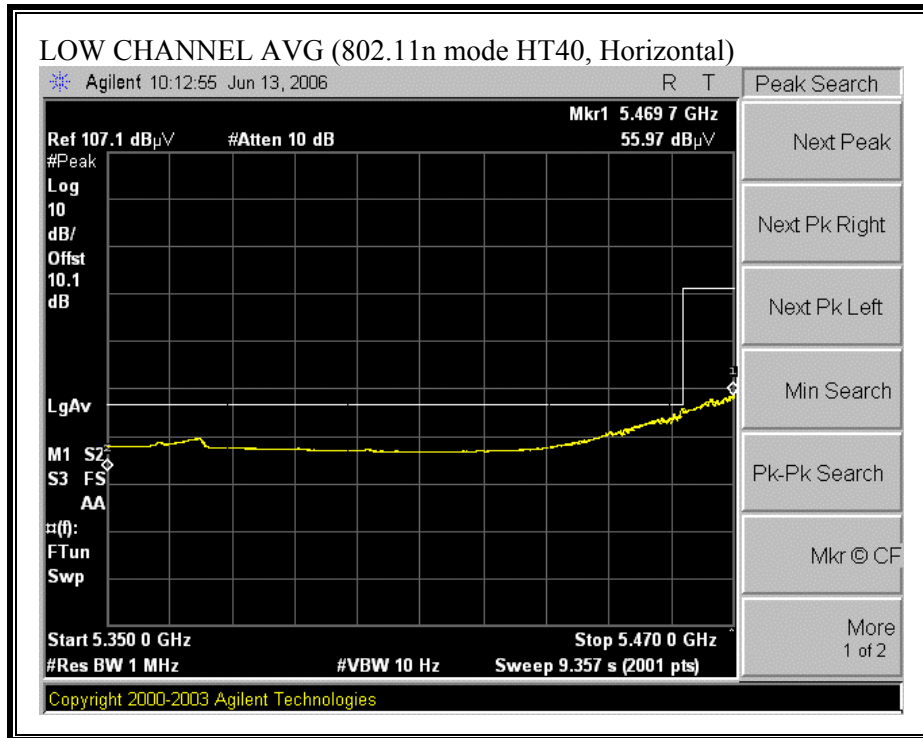



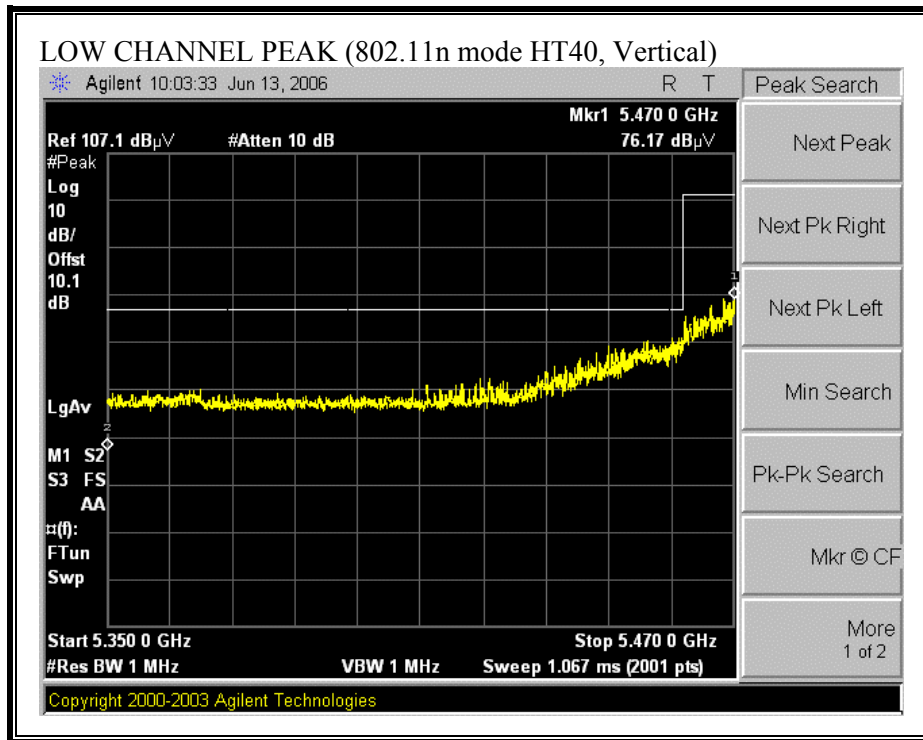

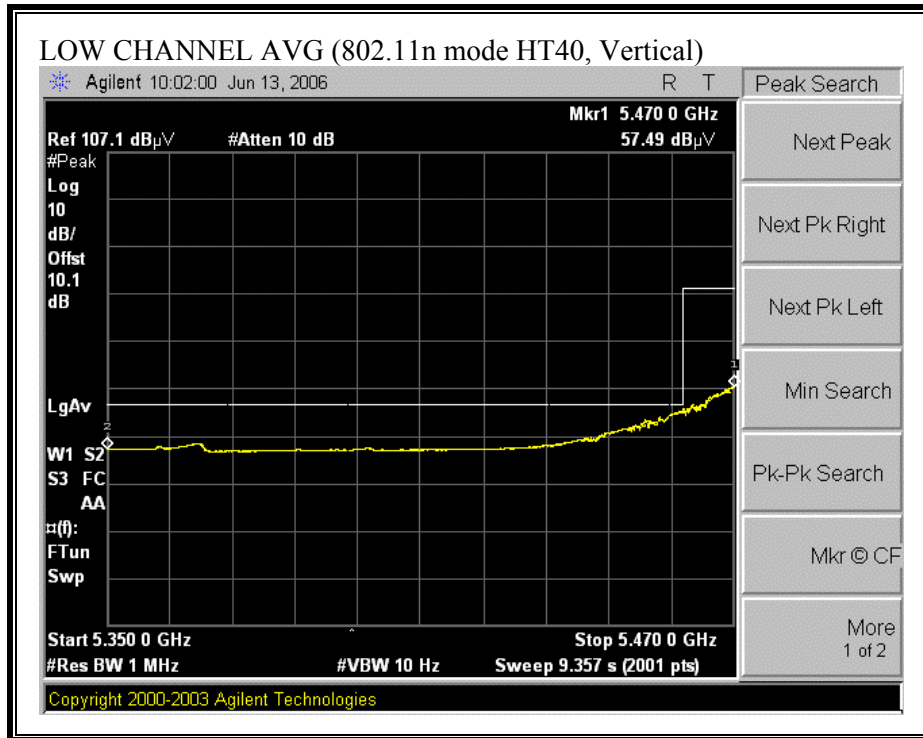

**BANDEDGE (802.11n MODE HT40, HIGH CHANNEL)**

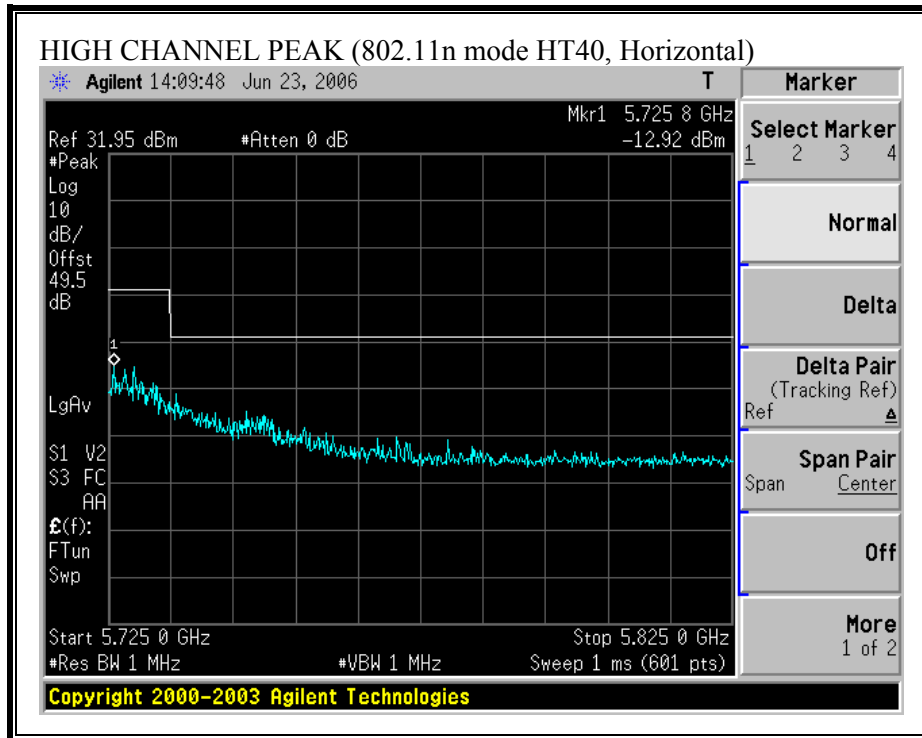

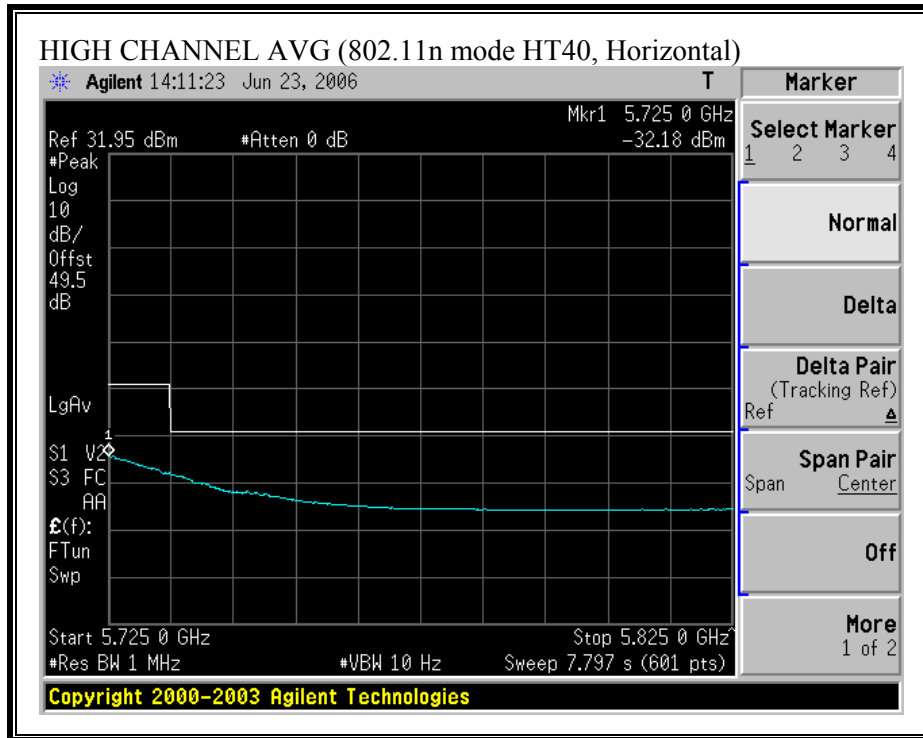

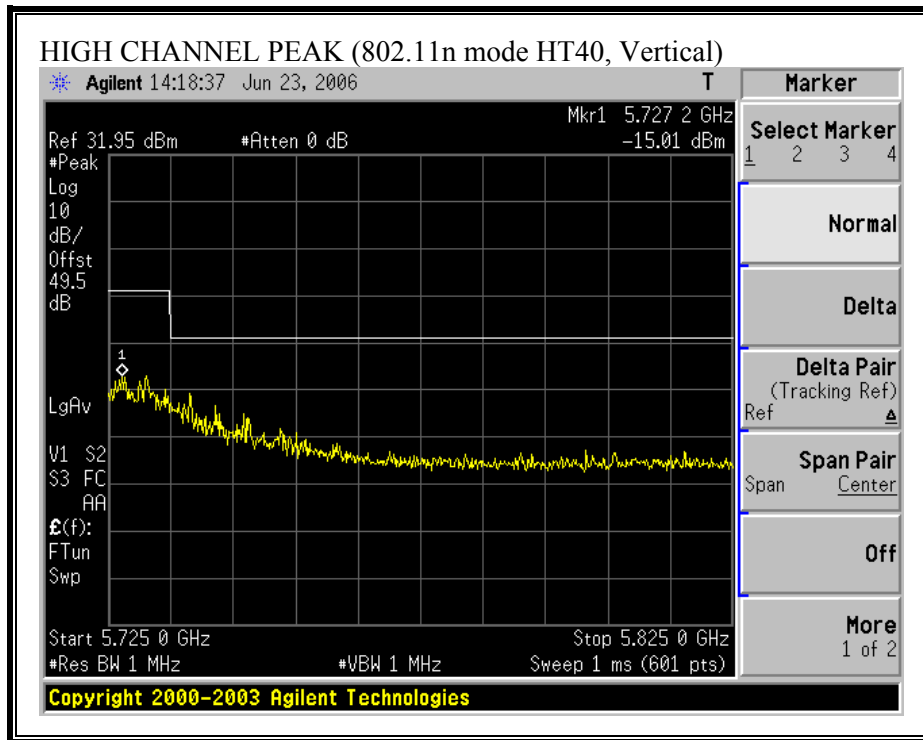

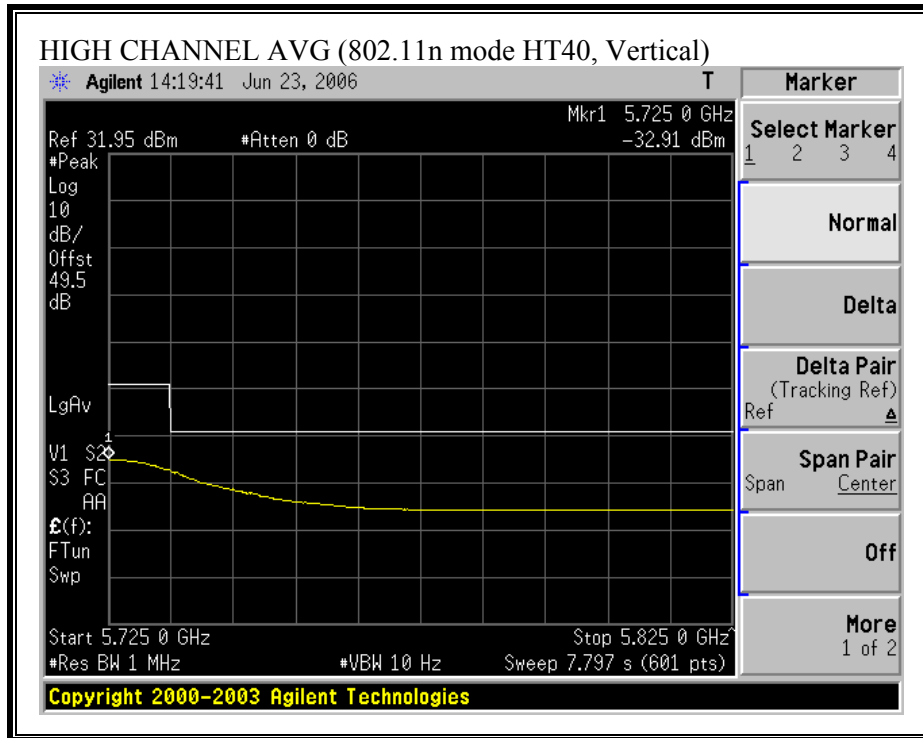

**HARMONICS AND SPURIOUS EMISSIONS (802.11a MODE)**

High Frequency Measurement																	
Compliance Certification Services, Morgan Hill Open Field Site																	
Company: Atheros																	
Project #: 06U10365																	
Date: 6/21/2006																	
Test Engineer: Chin Pang																	
Configuration: EUT/ED4 Antenna																	
Mode: TX, 5.5GHz Band, Legacy																	
Test Equipment:																	
Horn 1-18GHz			Pre-amplifier 1-26GHz			Pre-amplifier 26-40GHz			Horn > 18GHz			Limit					
T60; S/N: 2238 @3m			T144 Miteq 3008A00931									FCC 15.205					
Hi Frequency Cables																	
2 foot cable			3 foot cable			12 foot cable			HPF		Reject Filter		Peak Measurements RBW=VBW=1MHz				
			Chin 197538001			Chin 200354001			HPF_7.6GHz				Average Measurements RBW=1MHz ; VBW=10Hz				
f GHz	Dist (m)	Read Pk dBuV	Read Avg. dBuV	AF dB/m	CL dB	Amp dB	D Corr dB	Filtr dB	Peak dBuV/m	Avg dBuV/m	Pk Lim dBuV/m	Avg Lim dBuV/m	Pk Mar dB	Avg Mar dB	Notes (V/H)		
<b>Low Ch, 5500MHz</b>																	
11.000	3.0	52.0	37.4	37.3	4.3	-36.3	0.0	0.7	58.1	43.5	74	54	-15.9	-10.5	V		
11.000	3.0	52.6	37.6	37.3	4.3	-36.3	0.0	0.7	58.7	43.7	74	54	-15.3	-10.3	H		
<b>Mid Ch, 5600MHz</b>																	
11.200	3.0	54.0	40.0	37.3	4.4	-36.1	0.0	0.7	60.3	46.3	74	54	-13.7	-7.7	V		
11.200	3.0	58.2	43.5	37.3	4.4	-36.1	0.0	0.7	64.5	49.8	74	54	-9.5	-4.2	H		
<b>High Ch, 5700MHz</b>																	
11.400	3.0	58.6	43.3	37.4	4.4	-35.9	0.0	0.7	65.2	49.8	74	54	-8.8	-4.2	V		
11.400	3.0	61.0	46.9	37.4	4.4	-35.9	0.0	0.7	67.5	53.4	74	54	-6.5	-0.6	H		
Rev. 5.1.6																	
Note: No other emissions were detected above the system noise floor.																	
f	Measurement Frequency					Amp	Preamp Gain					Avg Lim	Average Field Strength Limit				
Dist	Distance to Antenna					D Corr	Distance Correct to 3 meters					Pk Lim	Peak Field Strength Limit				
Read	Analyzer Reading					Avg	Average Field Strength @ 3 m					Avg Mar	Margin vs. Average Limit				
AF	Antenna Factor					Peak	Calculated Peak Field Strength					Pk Mar	Margin vs. Peak Limit				
CL	Cable Loss					HPF	High Pass Filter										

**HARMONICS AND SPURIOUS EMISSIONS (802.11n HT20 MODE)**

**High Frequency Measurement**

Compliance Certification Services, Morgan Hill Open Field Site

Company: Atheros  
 Project #: 06U10365  
 Date: 6/21/2006  
 Test Engineer: Chin Pang  
 Configuration: EUT/ED4 Antenna  
 Mode: TX, 5.5GHz Band, HT20

**Test Equipment:**

Horn 1-18GHz	Pre-amplifier 1-26GHz	Pre-amplifier 26-40GHz	Horn > 18GHz	Limit
T60; S/N: 2238 @3m	T144 Miteq 3008A00931			FCC 15.205

Hi Frequency Cables

2 foot cable	3 foot cable	12 foot cable	HPF	Reject Filter	Peak Measurements RBW=VBW=1MHz
	Chin 197538001	Chin 200354001	HPF_7.6GHz		Average Measurements RBW=1MHz ; VBW=10Hz

f GHz	Dist (m)	Read Pk dBuV	Read Avg. dBuV	AF dB/m	CL dB	Amp dB	D Corr dB	Fltr dB	Peak dBuV/m	Avg dBuV/m	Pk Lim dBuV/m	Avg Lim dBuV/m	Pk Mar dB	Avg Mar dB	Notes (V/H)
<b>Low Ch, 5500MHz</b>															
11.000	3.0	53.3	37.5	37.3	4.3	-36.3	0.0	0.7	59.4	43.6	74	54	-14.6	-10.4	V
11.000	3.0	54.5	38.0	37.3	4.3	-36.3	0.0	0.7	60.6	44.1	74	54	-13.4	-9.9	H
<b>Mid Ch, 5600MHz</b>															
11.200	3.0	56.0	43.0	37.3	4.4	-36.1	0.0	0.7	62.3	49.3	74	54	-11.7	-4.7	V
11.200	3.0	58.0	43.5	37.3	4.4	-36.1	0.0	0.7	64.3	49.8	74	54	-9.7	-4.2	H
<b>High Ch, 5700MHz</b>															
11.400	3.0	59.6	46.5	37.4	4.4	-35.9	0.0	0.7	66.1	53.0	74	54	-7.9	-1.0	V
11.400	3.0	60.3	47.2	37.4	4.4	-35.9	0.0	0.7	66.8	53.7	74	54	-7.2	-0.3	H

Rev. 5.1.6  
 Note: No other emissions were detected above the system noise floor.

f	Measurement Frequency	Amp	Preamp Gain	Avg Lim	Average Field Strength Limit
Dist	Distance to Antenna	D Corr	Distance Correct to 3 meters	Pk Lim	Peak Field Strength Limit
Read	Analyzer Reading	Avg	Average Field Strength @ 3 m	Avg Mar	Margin vs. Average Limit
AF	Antenna Factor	Peak	Calculated Peak Field Strength	Pk Mar	Margin vs. Peak Limit
CL	Cable Loss	HPF	High Pass Filter		



**HARMONICS AND SPURIOUS EMISSIONS (802.11n HT40 MODE)**

**High Frequency Measurement**

Compliance Certification Services, Morgan Hill Open Field Site

Company: Atheros  
 Project #: 06U10365  
 Date: 6/21/2006  
 Test Engineer: Chin Pang  
 Configuration: EUT/ED4 Antenna  
 Mode: TX, 5.5GHz Band, HT40

**Test Equipment:**

Horn 1-18GHz	Pre-amplifier 1-26GHz	Pre-amplifier 26-40GHz	Horn > 18GHz	Limit
T60; S/N: 2238 @3m	T144 Miteq 3008A00931			FCC 15.205

Hi Frequency Cables

2 foot cable	3 foot cable	12 foot cable	HPF	Reject Filter	Peak Measurements RBW=VBW=1MHz
	Chin 197538001	Chin 200354001	HPF_7.6GHz		Average Measurements RBW=1MHz ; VBW=10Hz

f GHz	Dist (m)	Read Pk dBuV	Read Avg. dBuV	AF dB/m	CL dB	Amp dB	D Corr dB	Fltr dB	Peak dBuV/m	Avg dBuV/m	Pk Lim dBuV/m	Avg Lim dBuV/m	Pk Mar dB	Avg Mar dB	Notes (V/H)
<b>Low Ch, 5510MHz</b>															
11.020	3.0	51.0	36.0	37.3	4.3	-36.3	0.0	0.7	57.1	42.1	74	54	-16.9	-11.9	V
11.020	3.0	50.0	35.6	37.3	4.3	-36.3	0.0	0.7	56.1	41.7	74	54	-17.9	-12.3	H
<b>Mid Ch, 5600MHz</b>															
11.200	3.0	54.0	40.0	37.3	4.4	-36.1	0.0	0.7	60.3	46.3	74	54	-13.7	-7.7	V
11.200	3.0	55.2	41.0	37.3	4.4	-36.1	0.0	0.7	61.5	47.3	74	54	-12.5	-6.7	H
<b>High Ch, 5700MHz</b>															
11.380	3.0	57.0	43.0	37.4	4.4	-35.9	0.0	0.7	63.5	49.5	74	54	-10.5	-4.5	V
11.380	3.0	58.0	44.0	37.4	4.4	-35.9	0.0	0.7	64.5	50.5	74	54	-9.5	-3.5	H

Rev. 5.1.6  
 Note: No other emissions were detected above the system noise floor.

f	Measurement Frequency	Amp	Preamp Gain	Avg Lim	Average Field Strength Limit
Dist	Distance to Antenna	D Corr	Distance Correct to 3 meters	Pk Lim	Peak Field Strength Limit
Read	Analyzer Reading	Avg	Average Field Strength @ 3 m	Avg Mar	Margin vs. Average Limit
AF	Antenna Factor	Peak	Calculated Peak Field Strength	Pk Mar	Margin vs. Peak Limit
CL	Cable Loss	HPF	High Pass Filter		

### 7.3.3. TRANSMITTER ABOVE 1 GHz FOR 5470 TO 5725 MHz BAND WITH MONOPOLE ANTENNAS

#### RESTRICTED BANDEDGE (802.11a MODE, LOW CHANNEL)

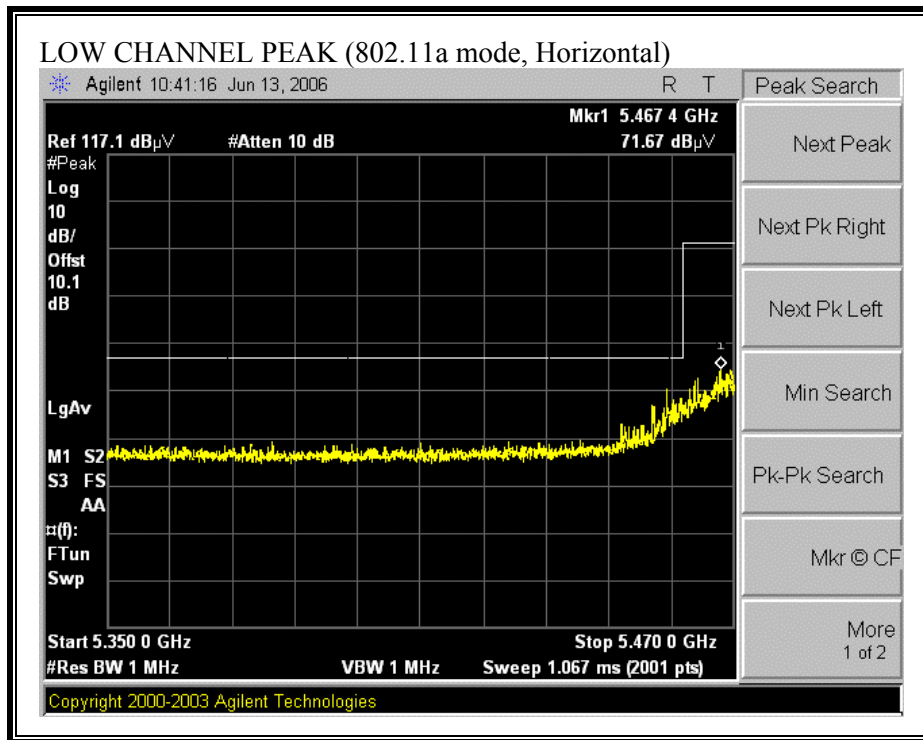

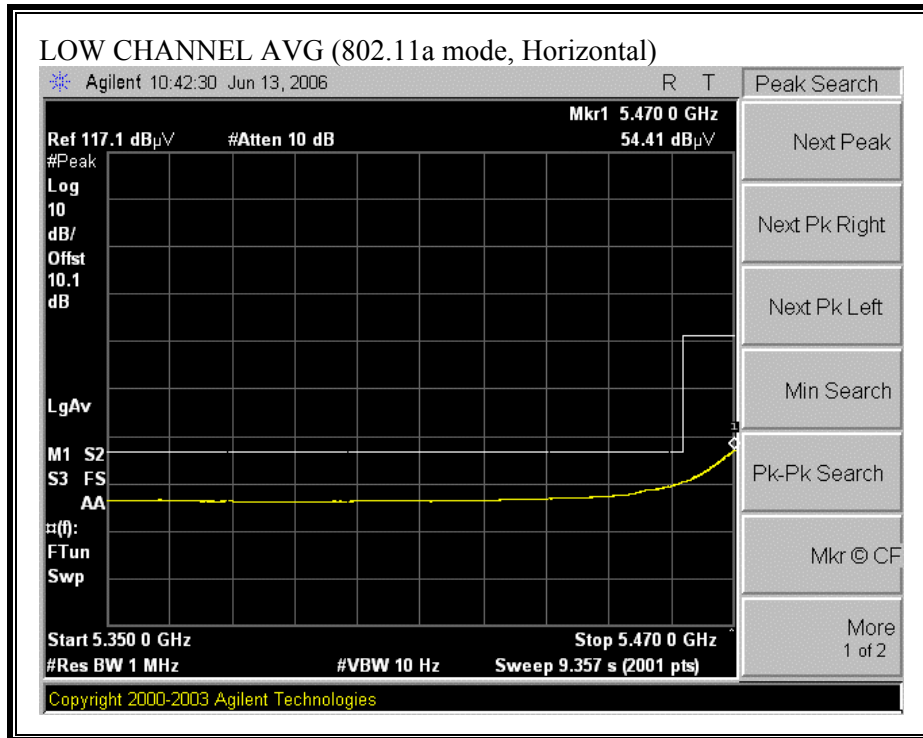

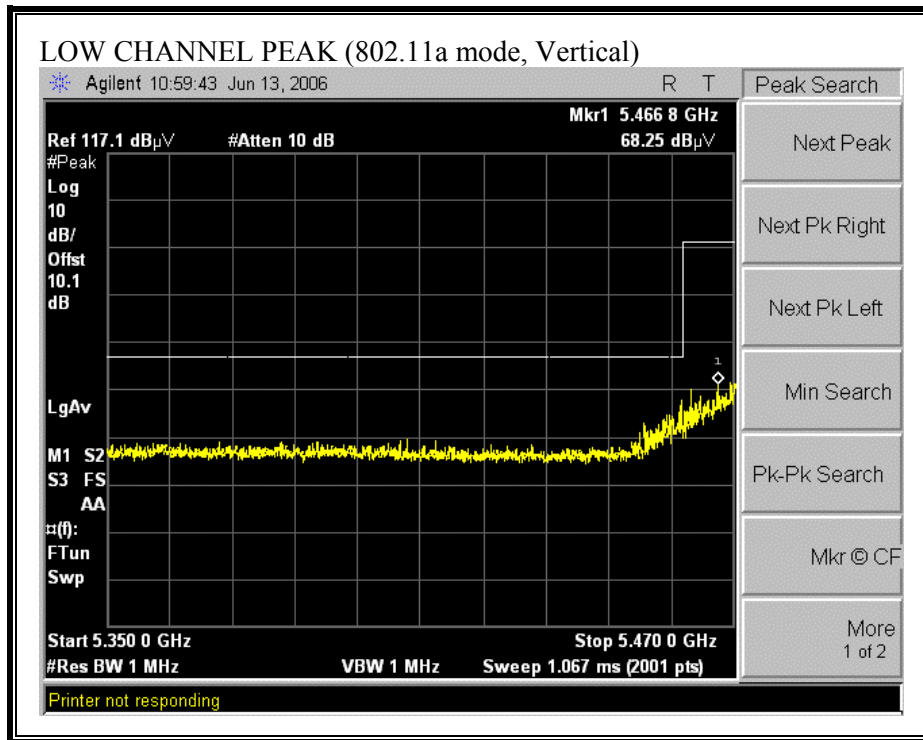

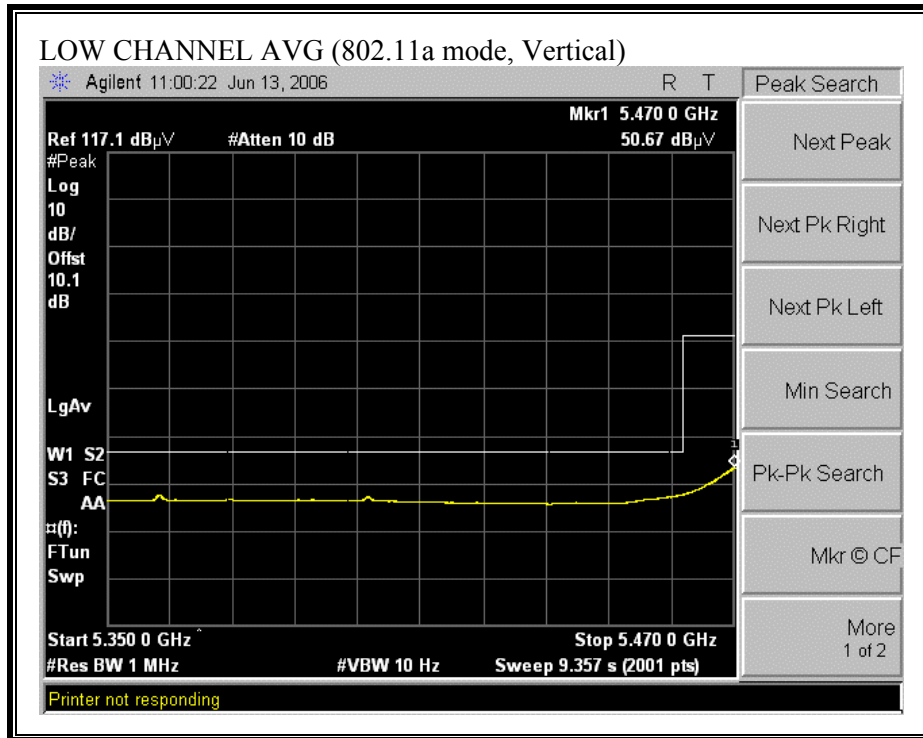

**BANDEDGE (802.11a MODE, HIGH CHANNEL)**

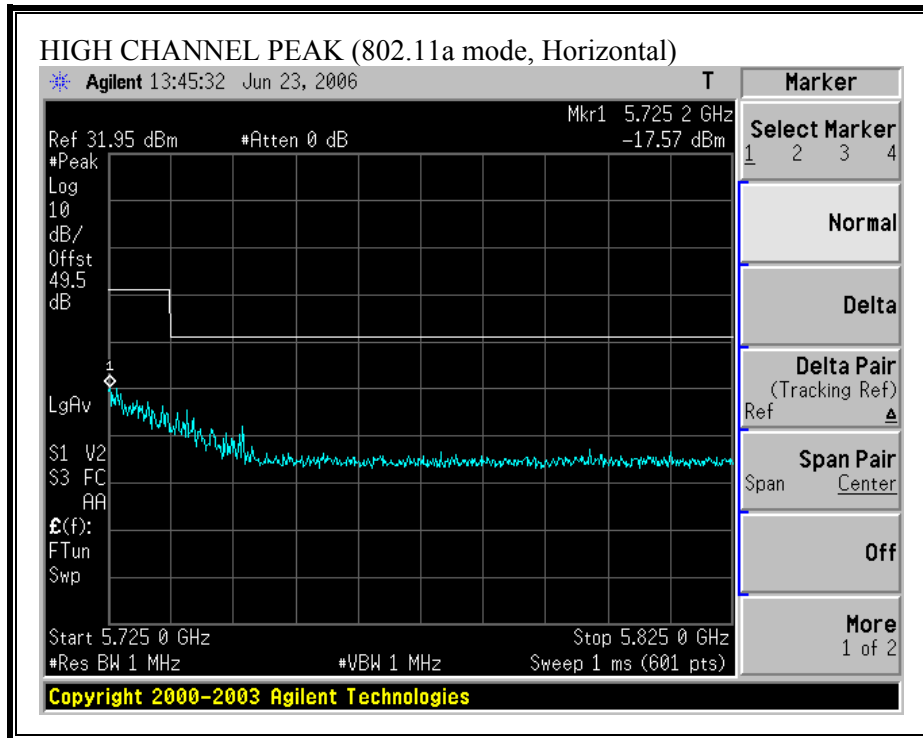

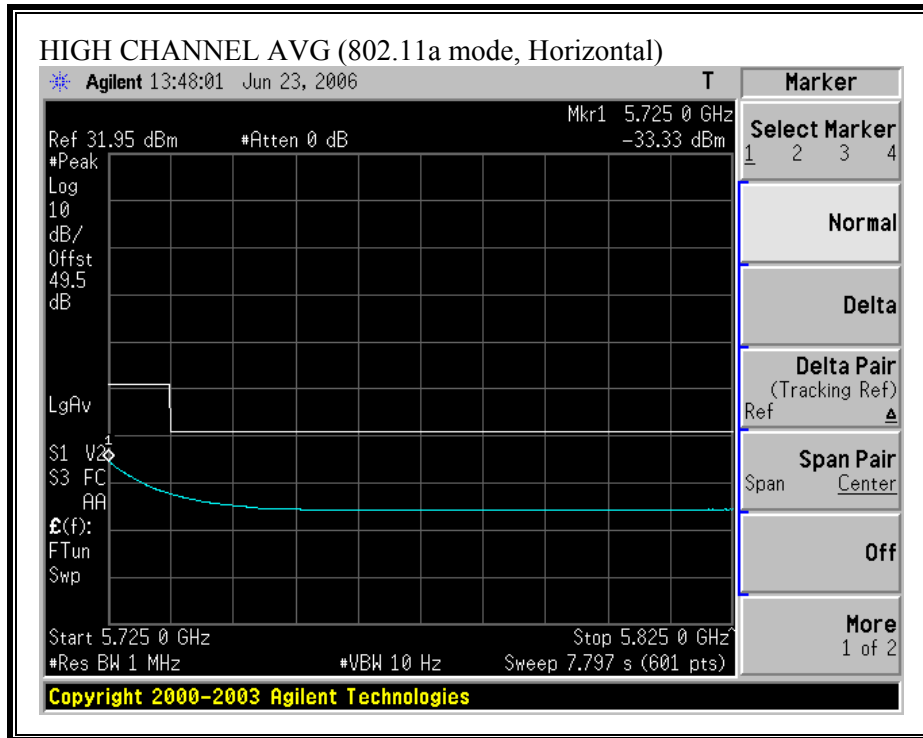

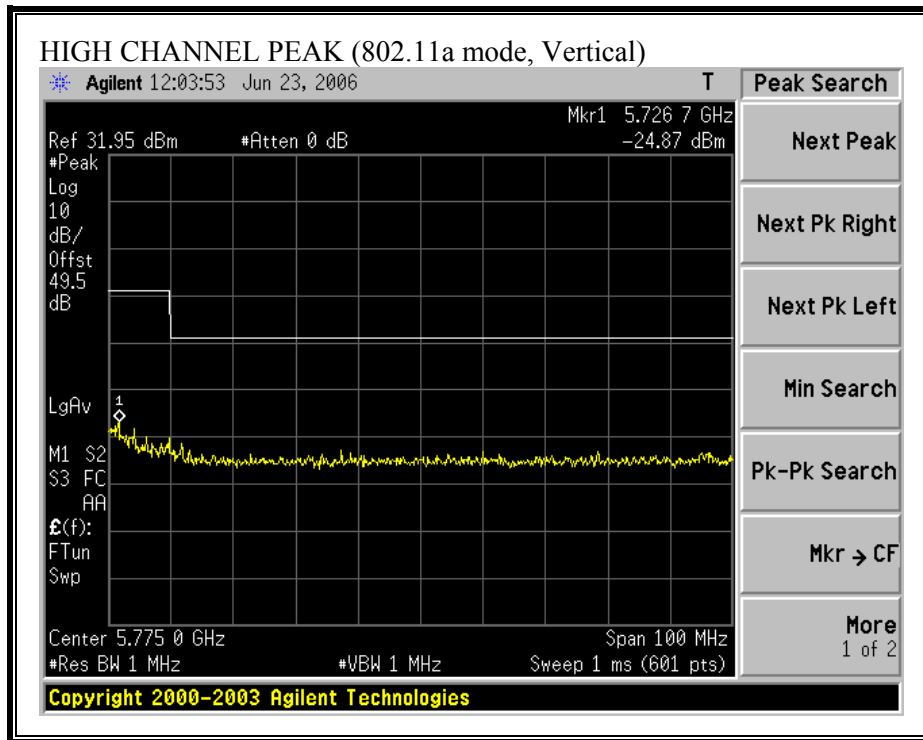



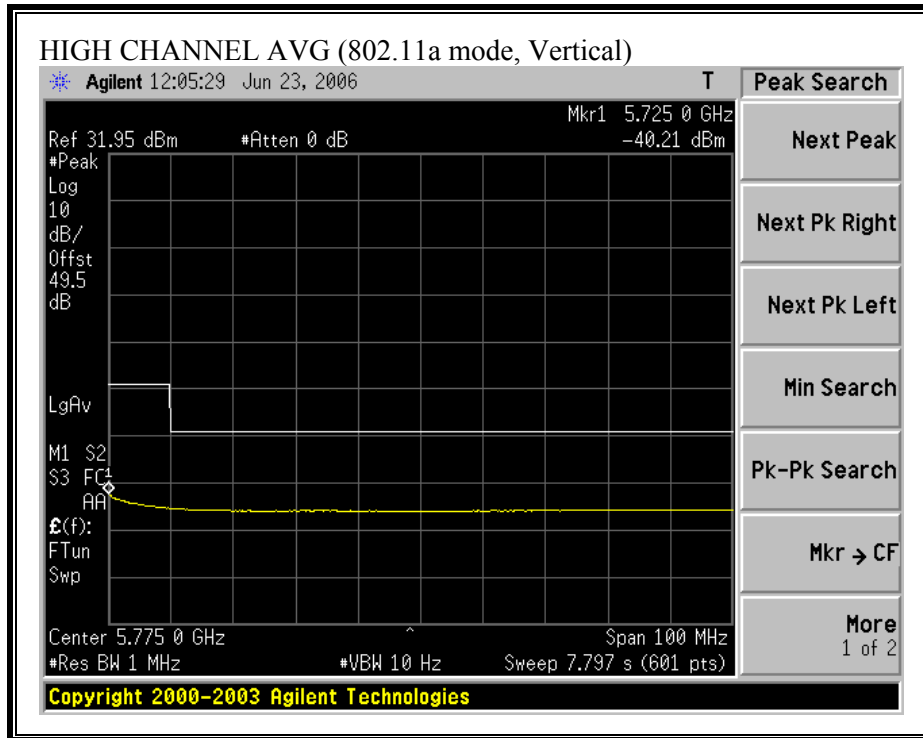

**RESTRICTED BANDEDGE (802.11n MODE HT20, LOW CHANNEL)**

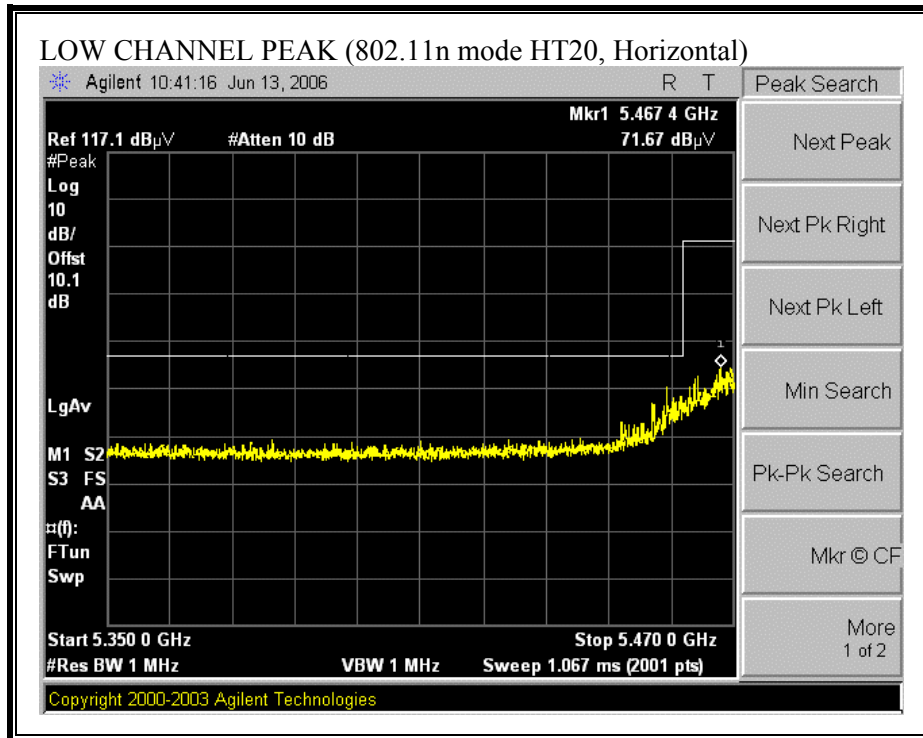

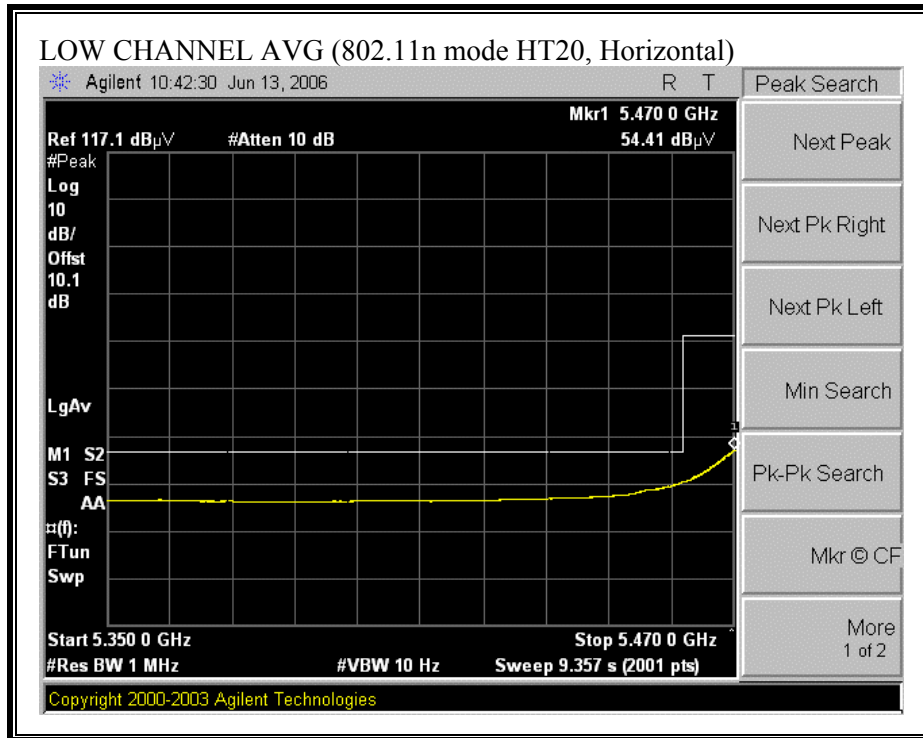

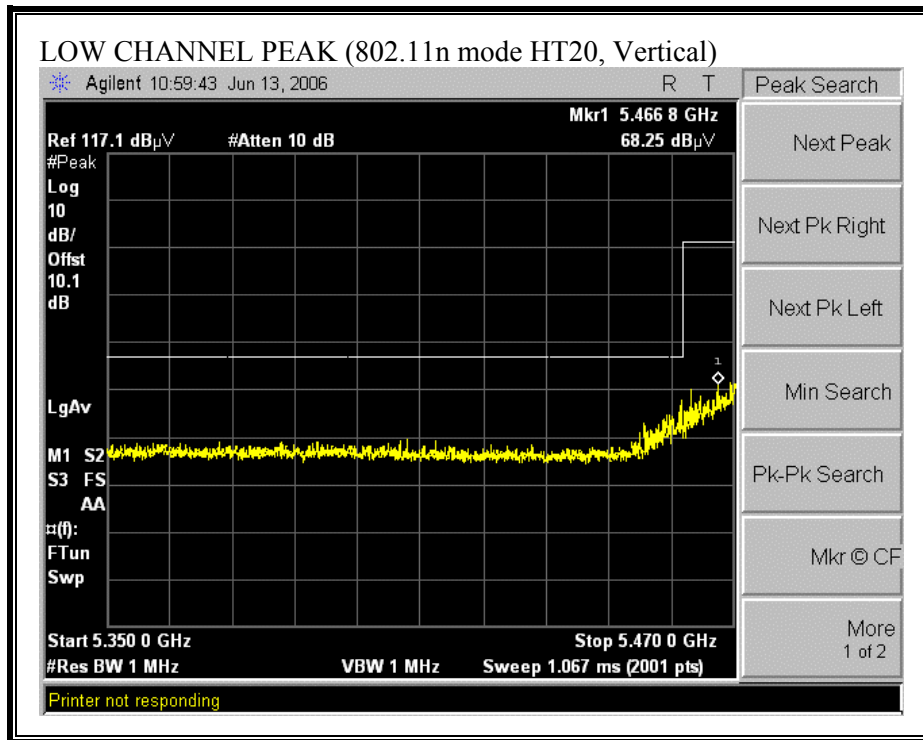

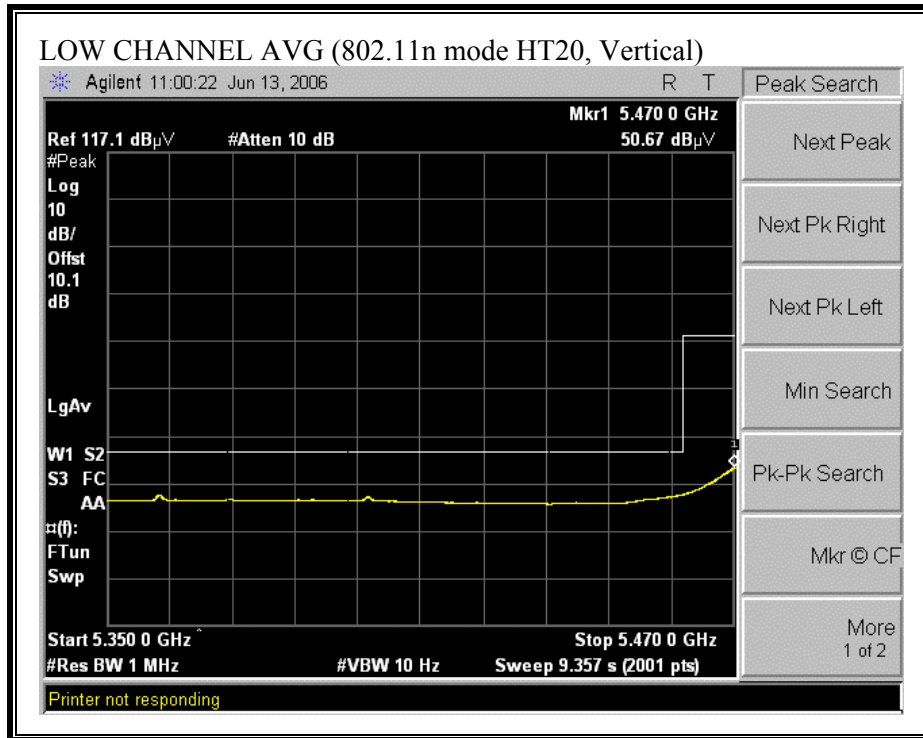

**BANDEDGE (802.11n MODE HT20, HIGH CHANNEL)**

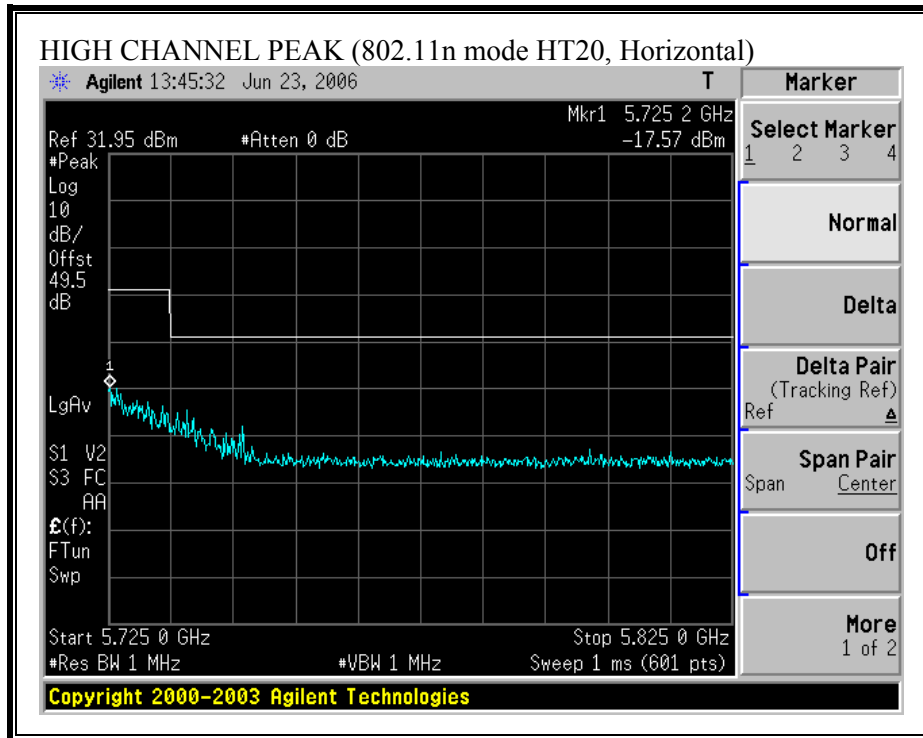

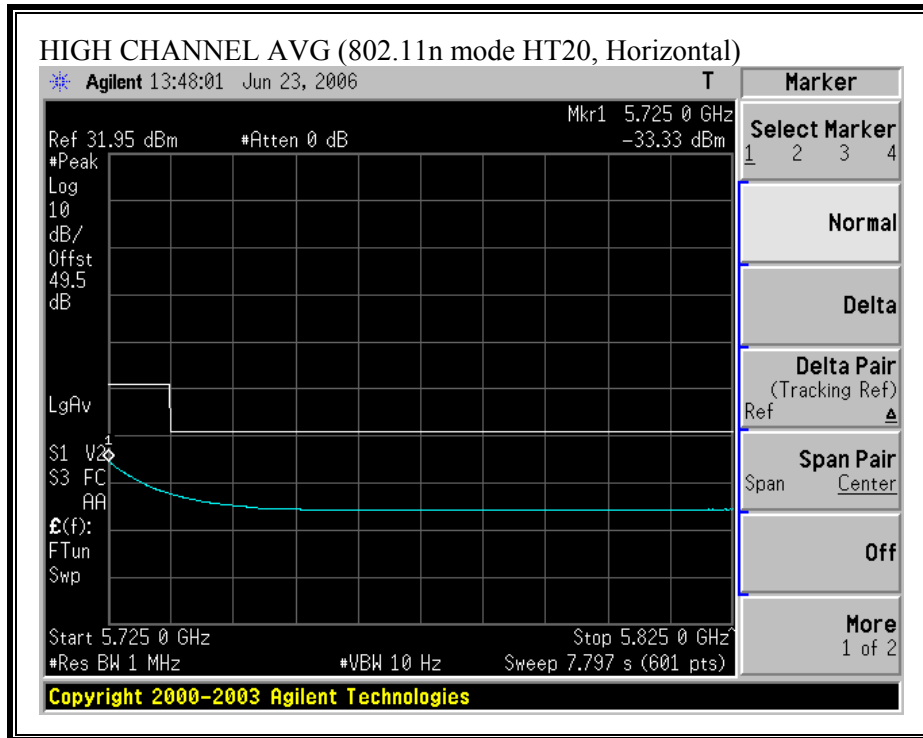

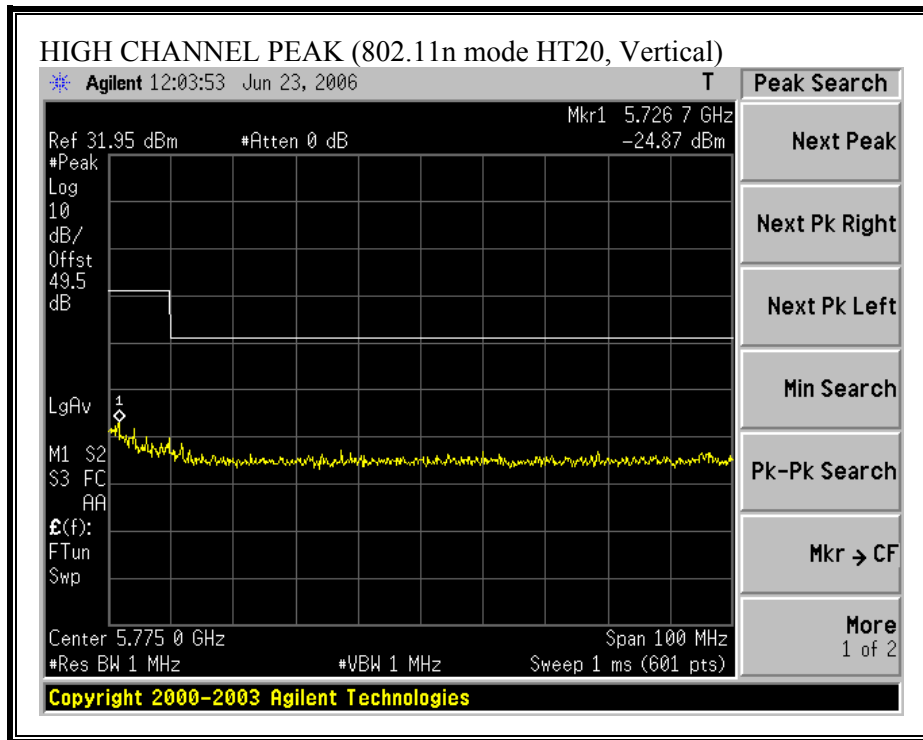



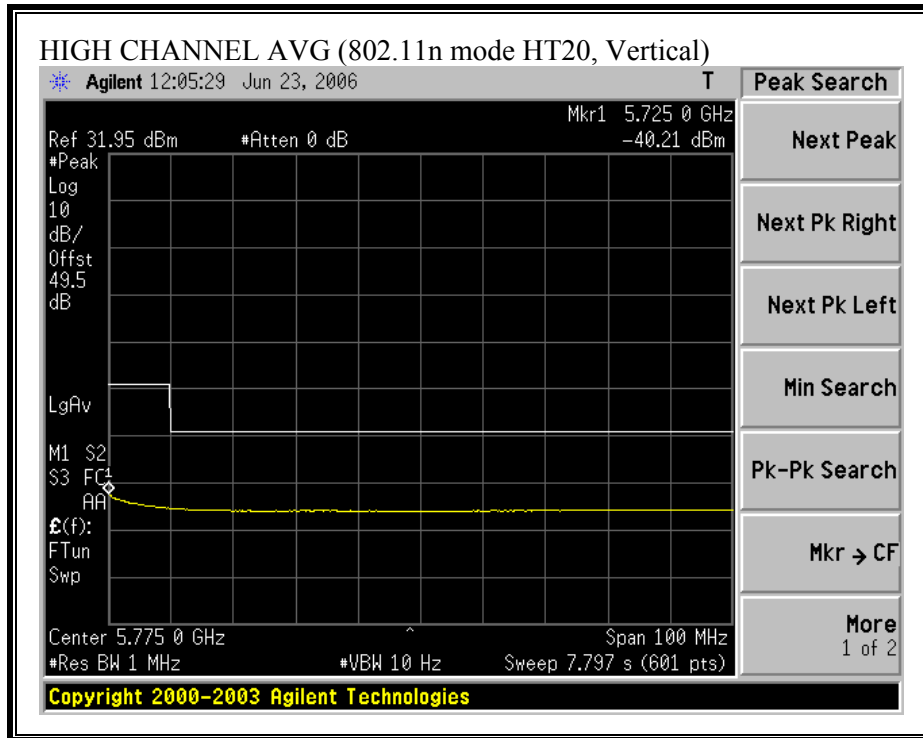

**RESTRICTED BANDEDGE (802.11n MODE HT40, LOW CHANNEL)**

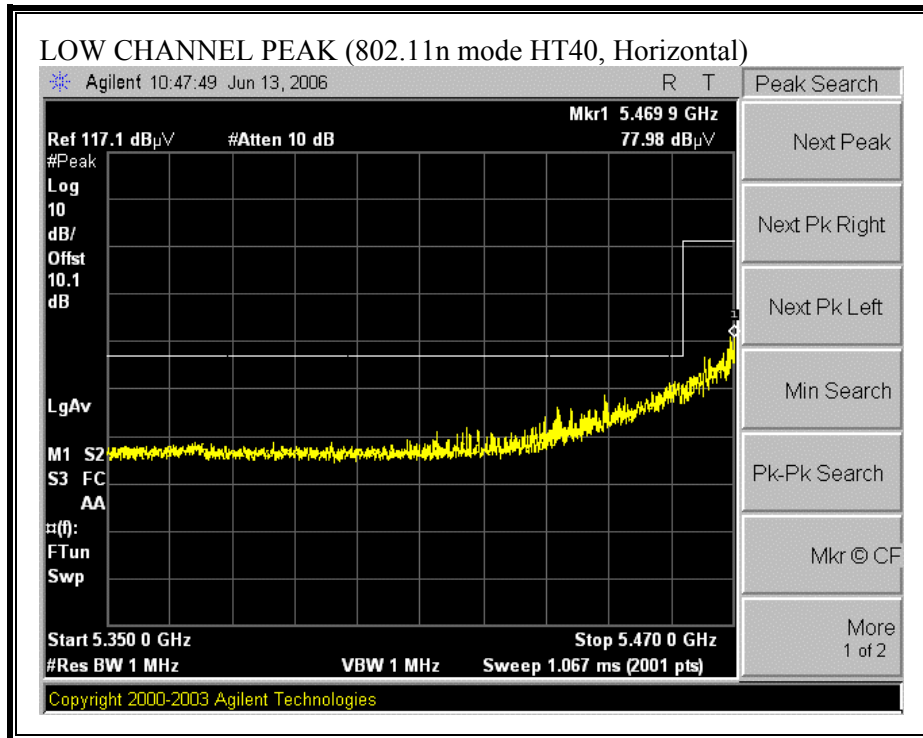

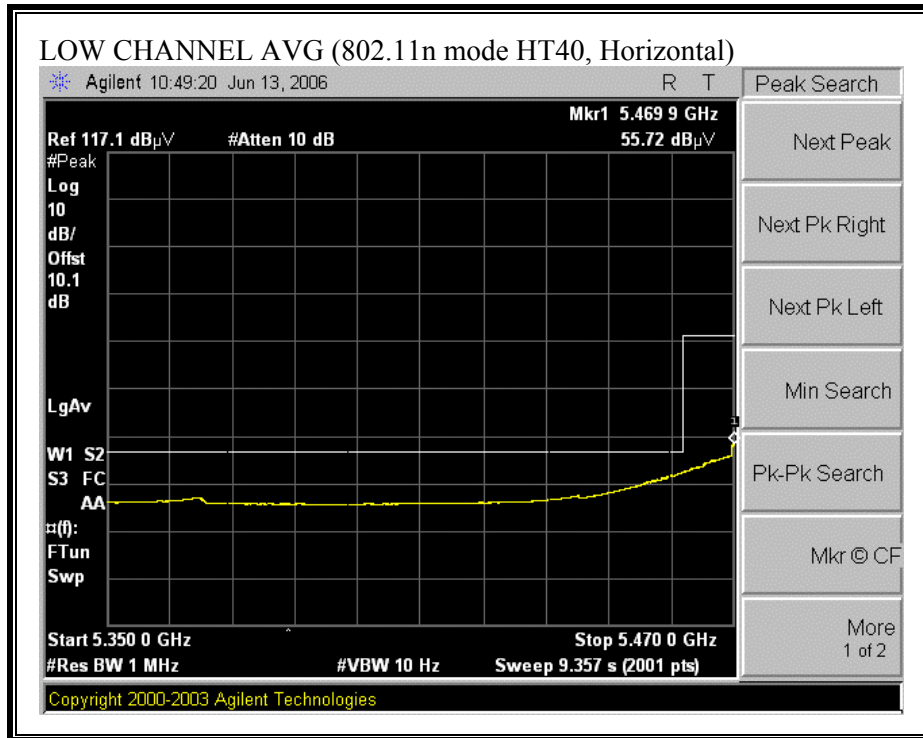

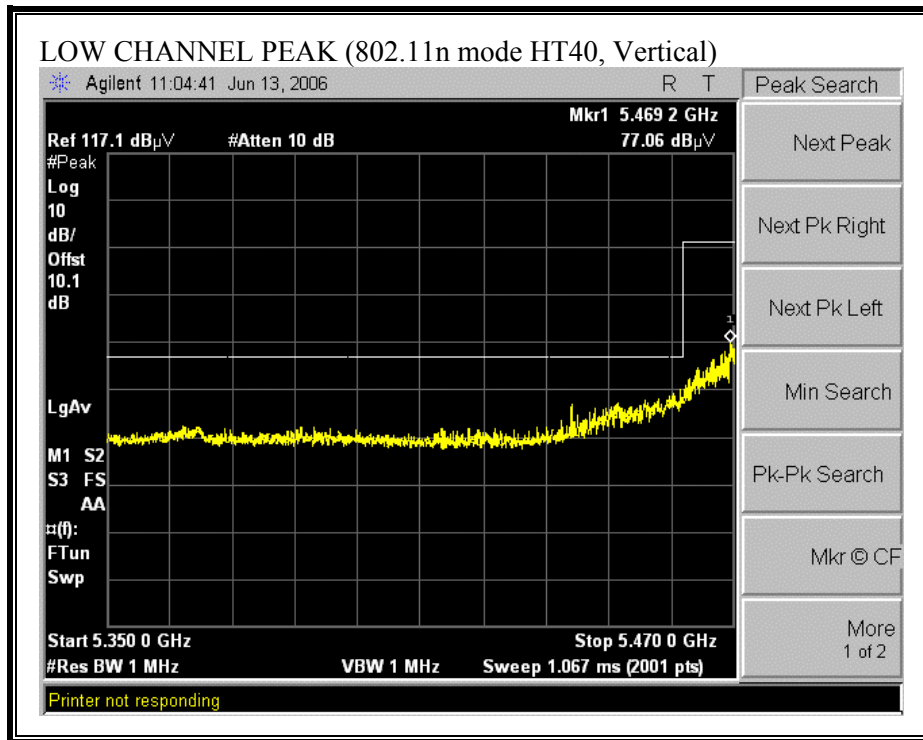

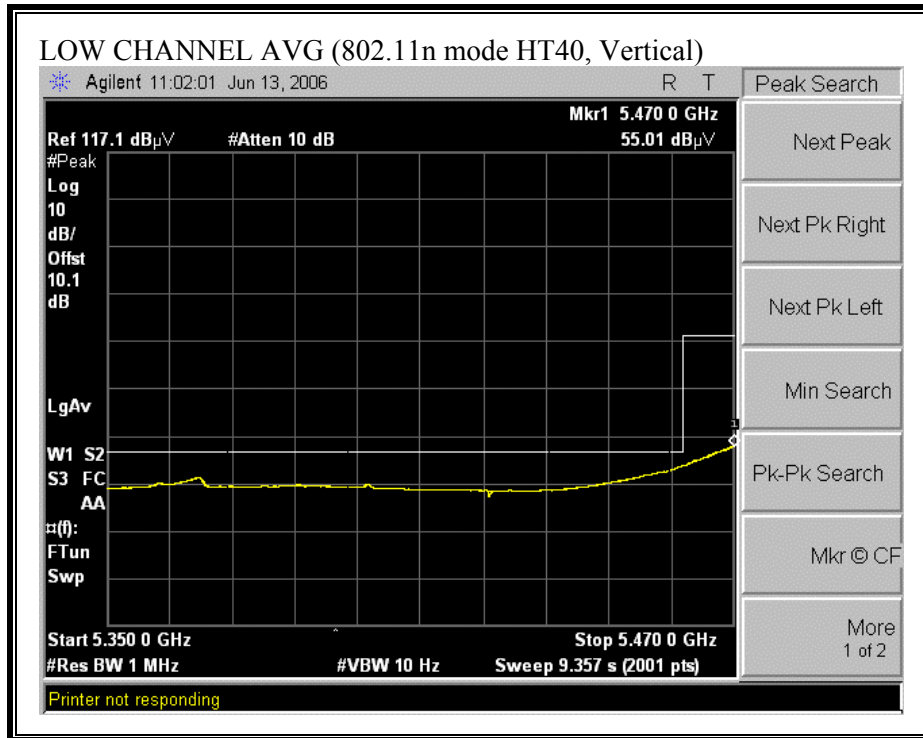

**BANDEDGE (802.11n MODE HT40, HIGH CHANNEL)**

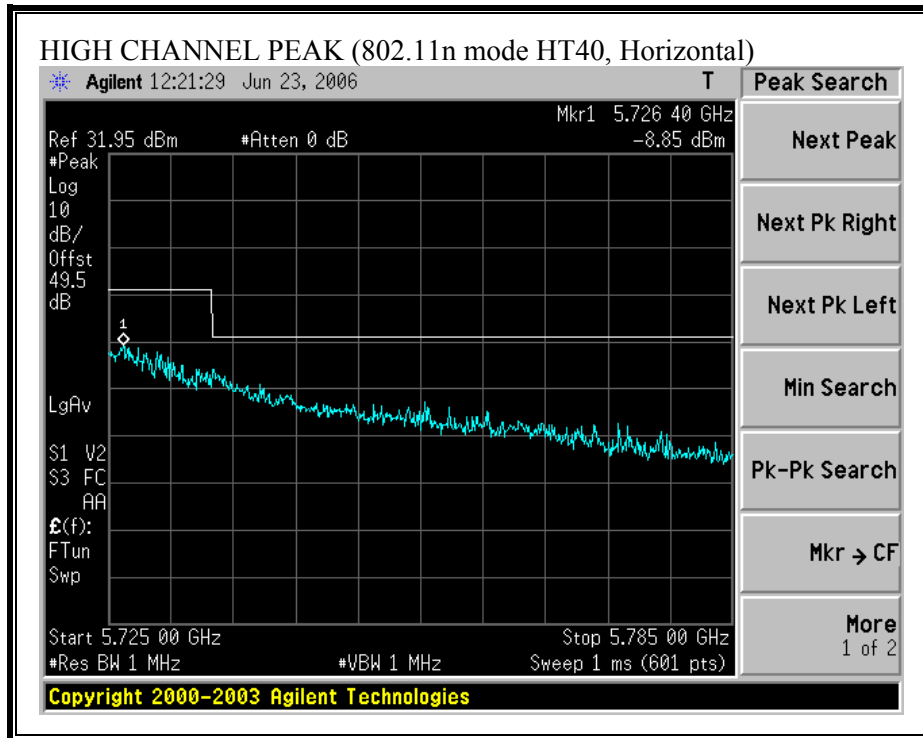

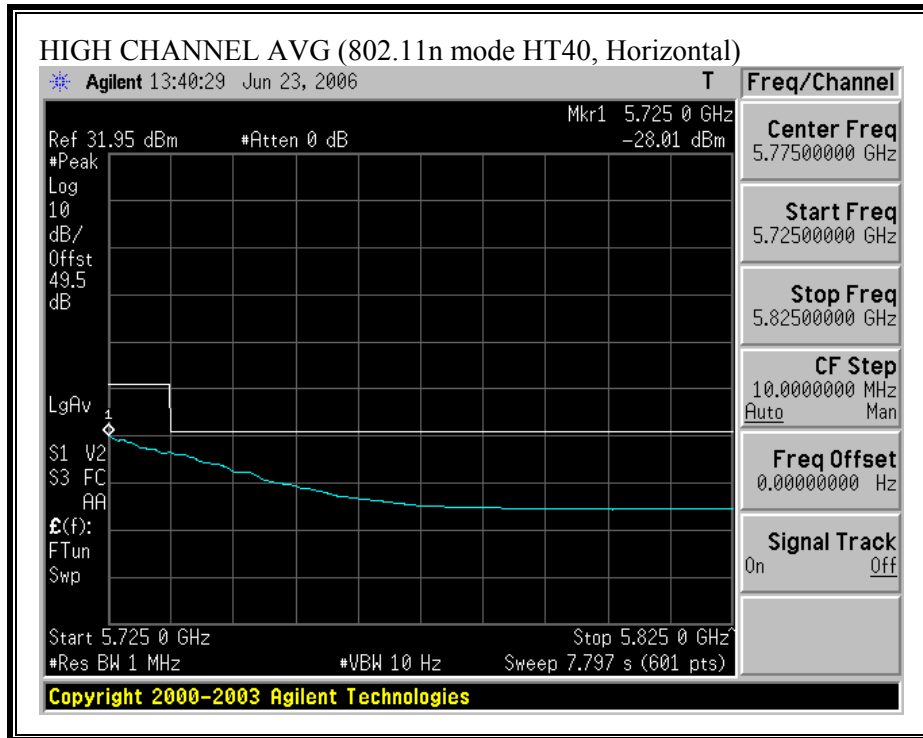

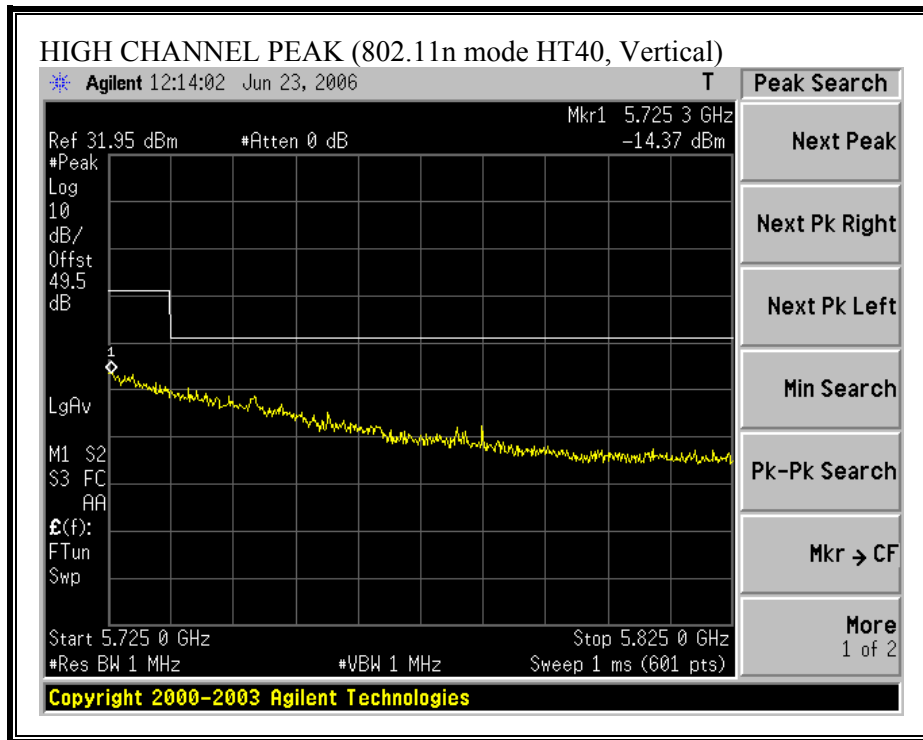



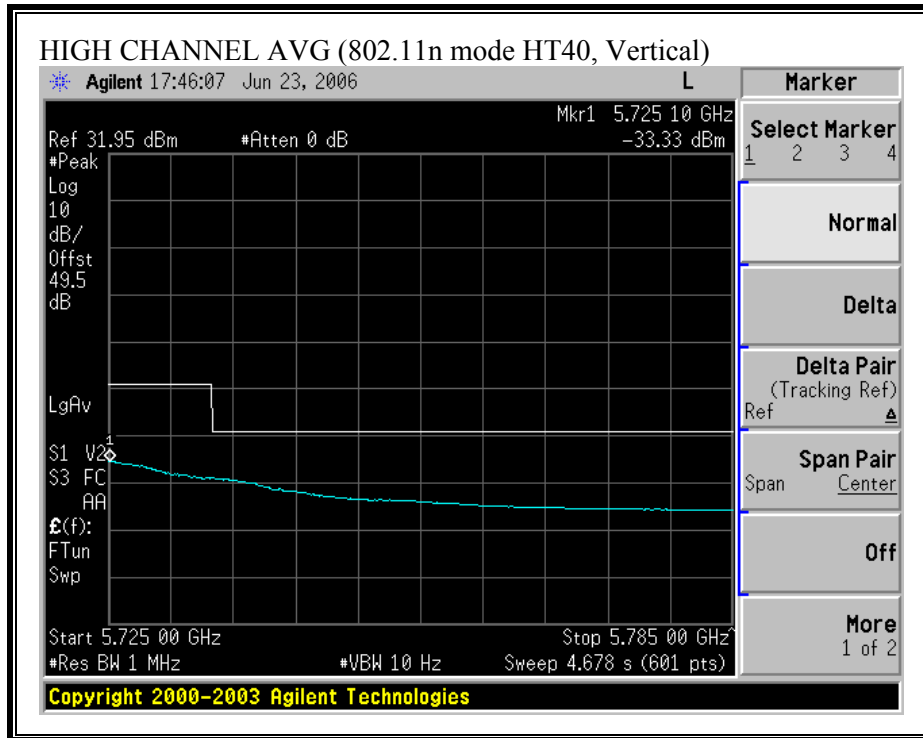

**HARMONICS AND SPURIOUS EMISSIONS (802.11a MODE)**

High Frequency Measurement																	
Compliance Certification Services, Morgan Hill Open Field Site																	
Company: Atheros																	
Project #: 06U10365																	
Date: 6/21/2006																	
Test Engineer: Chin Pang																	
Configuration: EUT / Foxconn Antenna																	
Mode: TX, 5.5GHz Band, Legacy																	
<b>Test Equipment:</b>																	
Horn 1-18GHz			Pre-amplifier 1-26GHz			Pre-amplifier 26-40GHz			Horn > 18GHz			Limit					
T60; S/N: 2238 @3m			T144 Miteq 3008A00931									FCC 15.205					
Hi Frequency Cables																	
2 foot cable			3 foot cable			12 foot cable			HPF		Reject Filter		Peak Measurements RBW=VBW=1MHz				
			Chin 197538001			Chin 200354001			HPF_7.6GHz				Average Measurements RBW=1MHz ; VBW=10Hz				
f GHz	Dist (m)	Read Pk dBuV	Read Avg. dBuV	AF dB/m	CL dB	Amp dB	D Corr dB	Filtr dB	Peak dBuV/m	Avg dBuV/m	Pk Lim dBuV/m	Avg Lim dBuV/m	Pk Mar dB	Avg Mar dB	Notes (V/H)		
<b>Low Ch, 5500MHz</b>																	
11.000	3.0	50.0	36.7	37.3	4.3	-36.3	0.0	0.7	56.1	42.8	74	54	-17.9	-11.2	V		
11.000	3.0	48.5	35.4	37.3	4.3	-36.3	0.0	0.7	54.6	41.5	74	54	-19.4	-12.5	H		
<b>Mid Ch, 5600MHz</b>																	
11.200	3.0	53.5	40.0	37.3	4.4	-36.1	0.0	0.7	59.8	46.3	74	54	-14.2	-7.7	V		
11.200	3.0	51.2	36.5	37.3	4.4	-36.1	0.0	0.7	57.5	42.8	74	54	-16.5	-11.2	H		
<b>High Ch, 5700MHz</b>																	
11.400	3.0	59.8	46.7	37.4	4.4	-35.9	0.0	0.7	66.3	53.2	74	54	-7.7	-0.8	V		
11.400	3.0	53.0	40.0	37.4	4.4	-35.9	0.0	0.7	59.5	46.5	74	54	-14.5	-7.5	H		
Rev. 5.1.6																	
Note: No other emissions were detected above the system noise floor.																	
f	Measurement Frequency					Amp	Preamp Gain					Avg Lim	Average Field Strength Limit				
Dist	Distance to Antenna					D Corr	Distance Correct to 3 meters					Pk Lim	Peak Field Strength Limit				
Read	Analyzer Reading					Avg	Average Field Strength @ 3 m					Avg Mar	Margin vs. Average Limit				
AF	Antenna Factor					Peak	Calculated Peak Field Strength					Pk Mar	Margin vs. Peak Limit				
CL	Cable Loss					HPF	High Pass Filter										

**HARMONICS AND SPURIOUS EMISSIONS (802.11n HT20 MODE)**

High Frequency Measurement																	
Compliance Certification Services, Morgan Hill Open Field Site																	
Company: Atheros																	
Project #: 06U10365																	
Date: 6/21/2006																	
Test Engineer: Chin Pang																	
Configuration: EUT / Foxconn Antenna																	
Mode: TX, 5.5GHz Band, HT20																	
Test Equipment:																	
Horn 1-18GHz			Pre-amplifier 1-26GHz			Pre-amplifier 26-40GHz			Horn > 18GHz			Limit					
T60; S/N: 2238 @3m			T144 Miteq 3008A00931									FCC 15.205					
Hi Frequency Cables																	
2 foot cable			3 foot cable			12 foot cable			HPF		Reject Filter		Peak Measurements RBW=VBW=1MHz Average Measurements RBW=1MHz ; VBW=10Hz				
			Chin 197538001			Chin 200354001			HPF_7.6GHz								
f GHz	Dist (m)	Read Pk dBuV	Read Avg. dBuV	AF dB/m	CL dB	Amp dB	D Corr dB	Filtr dB	Peak dBuV/m	Avg dBuV/m	Pk Lim dBuV/m	Avg Lim dBuV/m	Pk Mar dB	Avg Mar dB	Notes (V/H)		
<b>Low Ch, 5500MHz</b>																	
11.000	3.0	52.0	38.2	37.3	4.3	-36.3	0.0	0.7	58.1	44.3	74	54	-15.9	-9.7	V		
11.000	3.0	47.0	33.7	37.3	4.3	-36.3	0.0	0.7	53.1	39.8	74	54	-20.9	-14.2	H		
<b>Mid Ch, 5600MHz</b>																	
11.200	3.0	57.0	42.5	37.3	4.4	-36.1	0.0	0.7	63.3	48.8	74	54	-10.7	-5.2	V		
11.200	3.0	50.0	35.0	37.3	4.4	-36.1	0.0	0.7	56.3	41.3	74	54	-17.7	-12.7	H		
<b>High Ch, 5700MHz</b>																	
11.400	3.0	59.5	45.0	37.4	4.4	-35.9	0.0	0.7	66.0	51.5	74	54	-8.0	-2.5	V		
11.400	3.0	55.0	41.0	37.4	4.4	-35.9	0.0	0.7	61.5	47.5	74	54	-12.5	-6.5	H		
Rev. 5.1.6																	
Note: No other emissions were detected above the system noise floor.																	
f	Measurement Frequency					Amp	Preamp Gain					Avg Lim	Average Field Strength Limit				
Dist	Distance to Antenna					D Corr	Distance Correct to 3 meters					Pk Lim	Peak Field Strength Limit				
Read	Analyzer Reading					Avg	Average Field Strength @ 3 m					Avg Mar	Margin vs. Average Limit				
AF	Antenna Factor					Peak	Calculated Peak Field Strength					Pk Mar	Margin vs. Peak Limit				
CL	Cable Loss					HPF	High Pass Filter										

**HARMONICS AND SPURIOUS EMISSIONS (802.11n HT40 MODE)**

High Frequency Measurement																	
Compliance Certification Services, Morgan Hill Open Field Site																	
Company: Atheros																	
Project #: 06U10365																	
Date: 6/21/2006																	
Test Engineer: Chin Pang																	
Configuration: EUT / Foxconn Antenna																	
Mode: TX, 5.5GHz Band, HT40																	
<b>Test Equipment:</b>																	
Horn 1-18GHz			Pre-amplifier 1-26GHz			Pre-amplifier 26-40GHz			Horn > 18GHz			Limit					
T60; S/N: 2238 @3m			T144 Miteq 3008A00931									FCC 15.205					
Hi Frequency Cables																	
2 foot cable			3 foot cable			12 foot cable			HPF			Reject Filter			Peak Measurements		
			Chin 197538001			Chin 200354001			HPF_7.6GHz						RBW=VBW=1MHz		
Average Measurements																	
RBW=1MHz ; VBW=10Hz																	
f GHz	Dist (m)	Read Pk dBuV	Read Avg. dBuV	AF dB/m	CL dB	Amp dB	D Corr dB	Filtr dB	Peak dBuV/m	Avg dBuV/m	Pk Lim dBuV/m	Avg Lim dBuV/m	Pk Mar dB	Avg Mar dB	Notes (V/H)		
<b>Low Ch, 5510MHz</b>																	
11.020	3.0	51.4	36.5	37.3	4.3	-36.3	0.0	0.7	57.5	42.6	74	54	-16.5	-11.4	V		
11.020	3.0	47.5	33.0	37.3	4.3	-36.3	0.0	0.7	53.6	39.1	74	54	-20.4	-14.9	H		
<b>Mid Ch, 5600MHz</b>																	
11.200	3.0	53.4	40.0	37.3	4.4	-36.1	0.0	0.7	59.7	46.3	74	54	-14.3	-7.7	V		
11.200	3.0	48.0	35.0	37.3	4.4	-36.1	0.0	0.7	54.3	41.3	74	54	-19.7	-12.7	H		
<b>High Ch, 5690MHz</b>																	
11.380	3.0	57.0	43.4	37.4	4.4	-35.9	0.0	0.7	63.5	49.9	74	54	-10.5	-4.1	V		
11.380	3.0	52.0	38.0	37.4	4.4	-35.9	0.0	0.7	58.5	44.5	74	54	-15.5	-9.5	H		
Rev. 5.1.6																	
Note: No other emissions were detected above the system noise floor.																	
f	Measurement Frequency					Amp	Preamp Gain					Avg Lim	Average Field Strength Limit				
Dist	Distance to Antenna					D Corr	Distance Correct to 3 meters					Pk Lim	Peak Field Strength Limit				
Read	Analyzer Reading					Avg	Average Field Strength @ 3 m					Avg Mar	Margin vs. Average Limit				
AF	Antenna Factor					Peak	Calculated Peak Field Strength					Pk Mar	Margin vs. Peak Limit				
CL	Cable Loss					HPF	High Pass Filter										

### 7.3.4. WORST-CASE RADIATED EMISSIONS BELOW 1 GHz WITH PIFA ANTENNAS

#### SPURIOUS EMISSIONS 30 TO 1000 MHz (WORST-CASE CONFIGURATION, HORIZONTAL)

##### HORIZONTAL DATA

Condition: FCC CLASS-B HORIZONTAL  
Test Operator: : Chin Pang  
Company: : Atheros  
Project #: : 06U10365  
Model: : AR5BXB72  
Configuration: : EUT/Laptop  
Mode of Operation: TX ( b mode Mid Ch with ED4 Antennas)

Page: 1

	Freq	Read Level	Factor	Level	Limit Line	Over Limit	Remark
	MHz	dBuV	dB	dBuV/m	dBuV/m	dB	
1	251.160	25.63	13.93	39.56	46.00	-6.44	Peak
2	373.380	21.29	17.46	38.75	46.00	-7.25	Peak
3	456.800	19.55	19.36	38.91	46.00	-7.09	Peak
4	609.090	22.14	21.66	43.80	46.00	-2.20	Peak
5	708.030	15.71	23.23	38.94	46.00	-7.06	Peak
6	807.940	17.99	24.69	42.68	46.00	-3.32	Peak

**SPURIOUS EMISSIONS 30 TO 1000 MHz (WORST-CASE CONFIGURATION, VERTICAL)**

VERTICAL DATA

Condition: FCC CLASS-B VERTICAL  
Test Operator: : Chin Pang  
Company: : Atheros  
Project #: : 06U10365  
Model: : AR5BXB72  
Configuration: : EUT/Laptop  
Mode of Operation: TX ( b mode Mid Ch with ED4 Antennas)

Page: 1

	Freq	Read Level	Factor	Level	Limit Line	Over Limit	Remark
	MHZ	dBuV	dB	dBuV/m	dBuV/m	dB	
1	48.430	28.04	10.29	38.33	40.00	-1.67	Peak
2	177.440	25.04	13.11	38.15	43.50	-5.35	Peak
3	371.440	22.16	17.44	39.60	46.00	-6.40	Peak
4	407.330	21.65	18.21	39.86	46.00	-6.14	Peak
5	567.380	19.12	21.12	40.24	46.00	-5.76	Peak
6	806.000	16.55	24.64	41.19	46.00	-4.81	Peak

### 7.3.5. WORST-CASE RADIATED EMISSIONS BELOW 1 GHz WITH MONOPOLE ANTENNAS

#### SPURIOUS EMISSIONS 30 TO 1000 MHz (WORST-CASE CONFIGURATION, HORIZONTAL

##### HORIZONTAL DATA

Condition: FCC CLASS-B HORIZONTAL  
Test Operator: : Chin Pang  
Company: : Atheros  
Project #: : 06U10365  
Model: : AR5BXB72  
Configuration: : EUT/Laptop  
Mode of Operation: TX ( b mode Mid Ch with Foxconn Antenna)

Page: 1

	Freq	Read	Factor	Level	Limit	Over	Remark
	MHz	dBuV	dB	dBuV/m	dBuV/m	dB	
1	150.280	22.34	14.10	36.44	43.50	-7.06	Peak
2	239.520	29.20	13.47	42.67	46.00	-3.33	QP
3	239.520	31.57	13.47	45.03	46.00	-0.97	Peak
4	303.540	27.70	15.75	43.45	46.00	-2.55	QP
5	303.540	28.71	15.75	44.46	46.00	-1.54	Peak
6	371.440	26.20	17.44	43.64	46.00	-2.36	QP
7	371.440	27.96	17.44	45.40	46.00	-0.60	Peak
8	405.390	23.83	18.18	42.01	46.00	-3.99	Peak
9	606.180	18.99	21.63	40.62	46.00	-5.38	Peak
10	707.060	16.80	23.20	40.00	46.00	-6.00	Peak
11	853.530	17.17	25.30	42.47	46.00	-3.53	Peak

VERTICAL DATA

Condition: FCC CLASS-B VERTICAL  
Test Operator: : Chin Pang  
Company: : Atheros  
Project #: : 06U10365  
Model: : AR5BXB72  
Configuration: : EUT/Laptop  
Mode of Operation: TX ( b mode Mid Ch with Foxconn Antenna)

Page: 1

	Freq	Read Level	Factor	Level	Limit Line	Over Limit	Remark
	MHZ	dBuV	dB	dBuV/m	dBuV/m	dB	
1	48.430	26.78	10.29	37.07	40.00	-2.93	Peak
2	305.480	24.68	15.80	40.48	46.00	-5.52	Peak
3	373.380	22.00	17.46	39.46	46.00	-6.54	Peak
4	403.450	21.55	18.12	39.67	46.00	-6.33	Peak
5	606.180	16.46	21.63	38.09	46.00	-7.91	Peak
6	706.090	17.19	23.17	40.36	46.00	-5.64	Peak
7	924.340	14.47	26.20	40.67	46.00	-5.33	Peak



## 7.4. DYNAMIC FREQUENCY SELECTION

### 7.4.1. LIMITS

§15.407 (h) and FCC 06-96 APPENDIX “COMPLIANCE MEASUREMENT PROCEDURES FOR UNLICENSED-NATIONAL INFORMATION INFRASTRUCTURE DEVICES OPERATING IN THE 5250-5350 MHz AND 5470-5725 MHz BANDS INCORPORATING DYNAMIC FREQUENCY SELECTION”.

**Table 1: Applicability of DFS requirements prior to use of a channel**

Requirement	Operational Mode		
	Master	Client (without radar detection)	Client (with radar detection)
<i>Non-Occupancy Period</i>	Yes	Not required	Yes
<i>DFS Detection Threshold</i>	Yes	Not required	Yes
<i>Channel Availability Check Time</i>	Yes	Not required	Not required
<i>Uniform Spreading</i>	Yes	Not required	Not required

**Table 2: Applicability of DFS requirements during normal operation**

Requirement	Operational Mode		
	Master	Client (without DFS)	Client (with DFS)
<i>DFS Detection Threshold</i>	Yes	Not required	Yes
<i>Channel Closing Transmission Time</i>	Yes	Yes	Yes
<i>Channel Move Time</i>	Yes	Yes	Yes

**Table 3: Interference Threshold values, Master or Client incorporating In-Service Monitoring**

Maximum Transmit Power	Value (see note)
≥ 200 milliwatt	-64 dBm
< 200 milliwatt	-62 dBm
Note 1: This is the level at the input of the receiver assuming a 0 dBi receive antenna Note 2: Throughout these test procedures an additional 1 dB has been added to the amplitude of the test transmission waveforms to account for variations in measurement equipment. This will ensure that the test signal is at or above the detection threshold level to trigger a DFS response.	

**Table 4: DFS Response requirement values**

Parameter	Value
<i>Non-occupancy period</i>	30 minutes
<i>Channel Availability Check Time</i>	60 seconds
<i>Channel Move Time</i>	10 seconds
<i>Channel Closing Transmission Time</i>	200 milliseconds + approx. 60 milliseconds over remaining 10 second period
The instant that the <i>Channel Move Time</i> and the <i>Channel Closing Transmission Time</i> begins is as follows: <ul style="list-style-type: none"> <li>• For the Short pulse radar Test Signals this instant is the end of the <i>Burst</i>.</li> <li>• For the Frequency Hopping radar Test Signal, this instant is the end of the last radar burst generated.</li> <li>• For the Long Pulse radar Test Signal this instant is the end of the 12 second period defining the radar transmission.</li> </ul> The Channel Closing Transmission Time is comprised of 200 milliseconds starting at the beginning of the Channel Move Time plus any additional intermittent control signals required to facilitate channel changes (an aggregate of approximately 60 milliseconds) during the remainder of the 10 second period. The aggregate duration of control signals will not count quiet periods in between transmissions.	

**Table 5 – Short Pulse Radar Test Waveforms**

Radar Type	Pulse Width (Microseconds)	PRI (Microseconds)	Pulses	Minimum Percentage of Successful Detection	Minimum Trials
1	1	1428	18	60%	30
2	1-5	150-230	23-29	60%	30
3	6-10	200-500	16-18	60%	30
4	11-20	200-500	12-16	60%	30
Aggregate (Radar Types 1-4)				80%	120

**Table 6 – Long Pulse Radar Test Signal**

Radar Waveform	Bursts	Pulses per Burst	Pulse Width (µsec)	Chirp Width (MHz)	PRI (µsec)	Minimum Percentage of Successful Detection	Minimum Trials
5	8-20	1-3	50-100	5-20	1000-2000	80%	30

**Table 7 – Frequency Hopping Radar Test Signal**

Radar Waveform	Pulse Width (µsec)	PRI (µsec)	Burst Length (ms)	Pulses per Hop	Hopping Rate (kHz)	Minimum Percentage of Successful Detection	Minimum Trials
6	1	333	300	9	.333	70%	30

## 7.4.2. DESCRIPTION OF EUT

### **OVERVIEW OF EUT WITH RESPECT TO §15.407 (h) REQUIREMENTS**

The EUT operates over the 5250-5350 MHz and 5470-5725 MHz ranges.

The EUT is a Client Device that does not have radar detection capability.

The EUT is a MIMO device that uses two transmitters and three receivers; each of the three RF ports are connected to identical antennas via three separate coaxial connectors.

The highest gain antenna assembly utilized with the EUT has a gain of 6.2 dBi in the 5250-5350 MHz band and 5.34 dBi in the 5470-5725 MHz band. The highest gain antenna assembly utilized with the EUT has an effective 802.11a legacy mode gain of 9.21 dBi in the 5250-5350 MHz band and 8.35 dBi in the 5470-5725 MHz band. The lowest gain antenna assembly utilized with the EUT has a gain of -2.0 dBi in the 5250-5350 MHz band and -1.2 dBi in the 5470-5725 MHz band.

The highest combined power level within these bands for the 802.11n mode is 26.68 dBm EIRP in the 5250-5350 MHz band and 26.02 dBm EIRP in the 5470-5725 MHz band. The highest combined power level within these bands for the 802.11a legacy mode is 26.98 dBm EIRP in the 5250-5350 MHz band and 26.86 dBm EIRP in the 5470-5725 MHz band.

Both of the 50-ohm Tx/Rx antenna ports are connected to the test system via a power combiner/divider to perform conducted tests.

WLAN traffic is generated by streaming the video file TestFile.mp2 "6 ½ Magic Hours" from the Master to the Slave in full motion video mode using the media player with the V2.61 Codec package.

TPC is not required since the maximum EIRP is less than 500 mW (27 dBm).

The EUT utilizes an 802.11a/n IP based architecture. Two nominal channel bandwidths, 20 MHz and 40 MHz, are implemented.

### **OVERVIEW OF MASTER DEVICE WITH RESPECT TO §15.407 (h) REQUIREMENTS**

The Master Device is an Atheros Access Point, FCC ID: PPD-AR5BAP-00032. The DFS software installed in the Master Device is revision 5.1.0.42.

The rated output power of the Master unit is > 23dBm (EIRP). Therefore the required interference threshold level is -64 dBm. After correction for antenna gain and procedural adjustments, the required conducted threshold at the antenna port is  $-64 + 4 + 1 = -59$  dBm.

The calibrated conducted DFS Detection Threshold level is set to -64 dBm. The tested level is lower than the required level hence it provides margin to the limit.

### **7.4.3. TEST AND MEASUREMENT SYSTEM**

#### **SYSTEM OVERVIEW**

The measurement system is based on a conducted test method.

The short pulse and long pulse signal generating system utilizes the NTIA software and the same manufacturer / model Vector Signal Generator as the NTIA. The hopping signal generating system utilizes the simulated hopping method.

The software selects waveform parameters from within the bounds of the signal type on a random basis using uniform distribution. The short pulse types 2, 3 and 4, and the long pulse type 5 parameters are randomized at run-time. The hopping type 6 pulse parameters are fixed while the hopping sequence is based on the August 2005 NTIA Hopping Frequency List, with the initial starting point randomized at run-time.

The signal monitoring equipment consists of a spectrum analyzer with the capacity to display 8192 bins on the horizontal axis. A time-domain resolution of 2 msec / bin is achievable with a 16 second sweep time, meeting the 10 second short pulse reporting criteria. The aggregate ON time is calculated by multiplying the number of bins above a threshold during a particular observation period by the dwell time per bin, with the analyzer set to peak detection and max hold. A time-domain resolution of 3 msec / bin is achievable with a 24 second sweep time, meeting the 22 second long pulse reporting criteria and allowing a minimum of 10 seconds after the end of the long pulse waveform.

#### **FREQUENCY HOPPING SIGNAL GENERATION**

The hopping burst generator is a High Speed Digital I/O card plugged into the control computer. This card utilizes an independent hardware clock reference therefore the output pulse timing is unaffected by host computer operating system latency times.

The software selects the hopping sequence as a 100-length segment of the August 2005 NTIA hopping frequency list. This list contains 274 unique pseudorandom sequences. Each such sequence contains 475 frequencies ordered on a random without replacement basis. Each successive trial uses a contiguous 100-length segment from within each successive 475-length sequence in the list. The initial starting point within the list is randomized at run-time such that the first 100-length segment is entirely contained within the first 475-length sequence. The starting point of each successive trial is incremented by 475.

Each frequency in the 100-length segment is compared to the boundaries of the EUT Detection Bandwidth and the software creates a hopping burst pattern in accordance with Section 7.4.1.3 Method #2 Simulated Frequency Hopping Radar Waveform Generating Subsystem of FCC 06-96 APPENDIX. The frequency of the signal generator is incremented in 1 MHz steps from  $F_L$  to  $F_H$  for each successive trial. This incremental sequence is repeated as required to generate a minimum of 30 total trials and to maintain a uniform frequency distribution over the entire Detection Bandwidth.

**CONDUCTED METHOD SYSTEM BLOCK DIAGRAM**

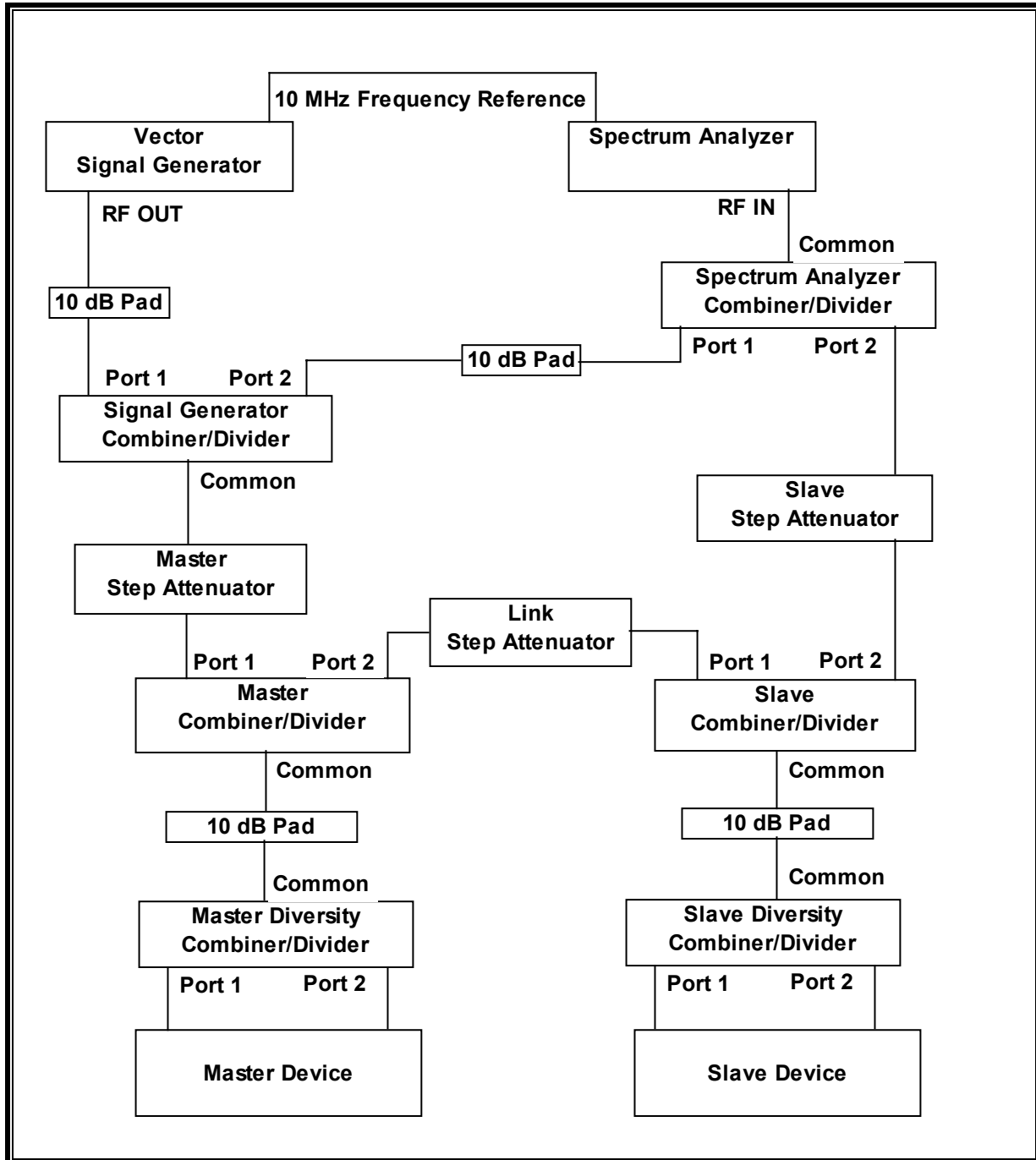

## **MEASUREMENT SYSTEM FREQUENCY REFERENCE**

Lock the signal generator and the spectrum analyzer to the same reference source as follows: Connect the 10 MHz OUT (SWITCHED) on the spectrum analyzer to the 10 MHz IN on the signal generator and set the spectrum analyzer 10 MHz Out to On.

## **SYSTEM CALIBRATION**

Adjust the Master Step Attenuator to 30 dB, the Link Step Attenuator to 70 dB, and the Slave Step Attenuator to 70 dB.

If required, disconnect the spectrum analyzer, Master Device, and Slave Device from the test system. Terminate the Common port of the Spectrum Analyzer Combiner/Divider, Port 2 of the Master Diversity Combiner/Divider, and Ports 1 and 2 of the Slave Diversity Combiner/Divider. Leave, or connect, the appropriate cable to Port 1 of the Master Diversity Combiner/Divider and connect the free end (Master Device end) of this cable to the spectrum analyzer.

Adjust the signal generator and spectrum analyzer to the center frequency of the channel to be measured. Set the signal generator to CW mode. Set the RBW of the spectrum analyzer to 10 kHz and the span to 100 kHz. Adjust the amplitude of the signal generator to yield a measured level of -64 dBm on the spectrum analyzer.

Without changing any of the instrument settings, reconnect the spectrum analyzer to the Common port of the Spectrum Analyzer Combiner/Divider, then remove the cable from Port 1 of the Master Diversity Combiner/Divider and replace this cable with a termination. Measure the amplitude and calculate the difference from -64 dBm. Adjust the Reference Level Offset of the spectrum analyzer to this difference. Confirm that the signal is displayed at -64 dBm. Readjust the RBW and VBW to 3 MHz, set the span to 10 MHz, and confirm that the signal is still displayed at -64 dBm.

This Reference Level Offset setting is used for all tests for which the Master Step Attenuator is set to 30 dB. The spectrum analyzer displays the level of the signal generator as received at the antenna ports of the Master Device. The interference detection threshold may be varied from the calibrated value of -64 dBm and the spectrum analyzer will still indicate the level as received by the Master Device.

The Link Step Attenuator and Slave Step Attenuator settings may be changed without affecting the System Calibration. The System Calibration process must be repeated for different settings of the Master Step Attenuator to determine the Reference Level Offset associated with each Master Step Attenuator setting.

### **INTERFERENCE DETECTION THRESHOLD ADJUSTMENT**

Set the signal generator to produce the specified radar waveform, trigger a burst manually and measure the amplitude on the spectrum analyzer. Readjust the amplitude of the signal generator as required so that the peak level of the waveform is at a displayed level equal to the required or desired interference detection threshold.

### **ADJUSTMENT OF DISPLAYED TRAFFIC LEVEL**

Establish a link between the Master and Slave, adjusting the Link Step Attenuator as needed to provide an adequate RSS level at the Master and Slave devices. Stream the video test file to generate WLAN traffic. Adjust the Slave Step Attenuator so that the WLAN traffic level from the Slave, as displayed on the spectrum analyzer, is at lower amplitude than the radar detection threshold.

Confirm that the displayed traffic is from the Slave Device by changing the setting of the Slave Step Attenuator and verifying that the displayed traffic level changes accordingly. Confirm that the displayed traffic does not include Master Device traffic by changing the setting of the Master Step Attenuator and the Link Step Attenuator and verifying that the displayed traffic level does not change. Reset all Step Attenuators to their previous settings.

If the above conditions cannot be met, use a different setting of the Master Step Attenuator, performing a new System Calibration and Interference Detection Threshold Adjustment as required for the new Master Step Attenuator setting.



### 7.4.4. SETUP OF EUT AND SUPPORT EQUIPMENT

#### SUPPORT EQUIPMENT

PERIPHERAL SUPPORT EQUIPMENT LIST				
Description	Manufacturer	Model	Serial Number	FCC ID
AC Adapter	CUI	DSA-0151A	4403	DoC
Access Point	Atheros	AP 30	AP 30-50-D7323	PPD-AR5BAP-00032
Laptop	IBM	Thinkpad T42	ZZ-27004	DoC
AC Adapter	IBM	08K8204	85910TF	DoC
Laptop	IBM	Thinkpad T42p	ZZ-27259	DoC
AC Adapter	IBM	02K6746	28106J	DoC

#### I/O CABLES

I/O CABLE LIST					
Cable No.	Port	# of Identical Ports	Connector Type	Cable Type	Cable Length
1	AC	1	US 115V	Direct Plug	0m
2	DC	1	DC	Un-shielded	2m
3	AC	1	US 115V	Un-shielded	1m
4	DC	1	DC	Un-shielded	2m
5	Ethernet	1	RJ45	Un-shielded	2m
6	Serial	1	USB to DIN	Shielded	2.5m
7	AC	1	US 115V	Un-shielded	2m
8	DC	1	DC	Un-shielded	2m

**TEST SETUP**

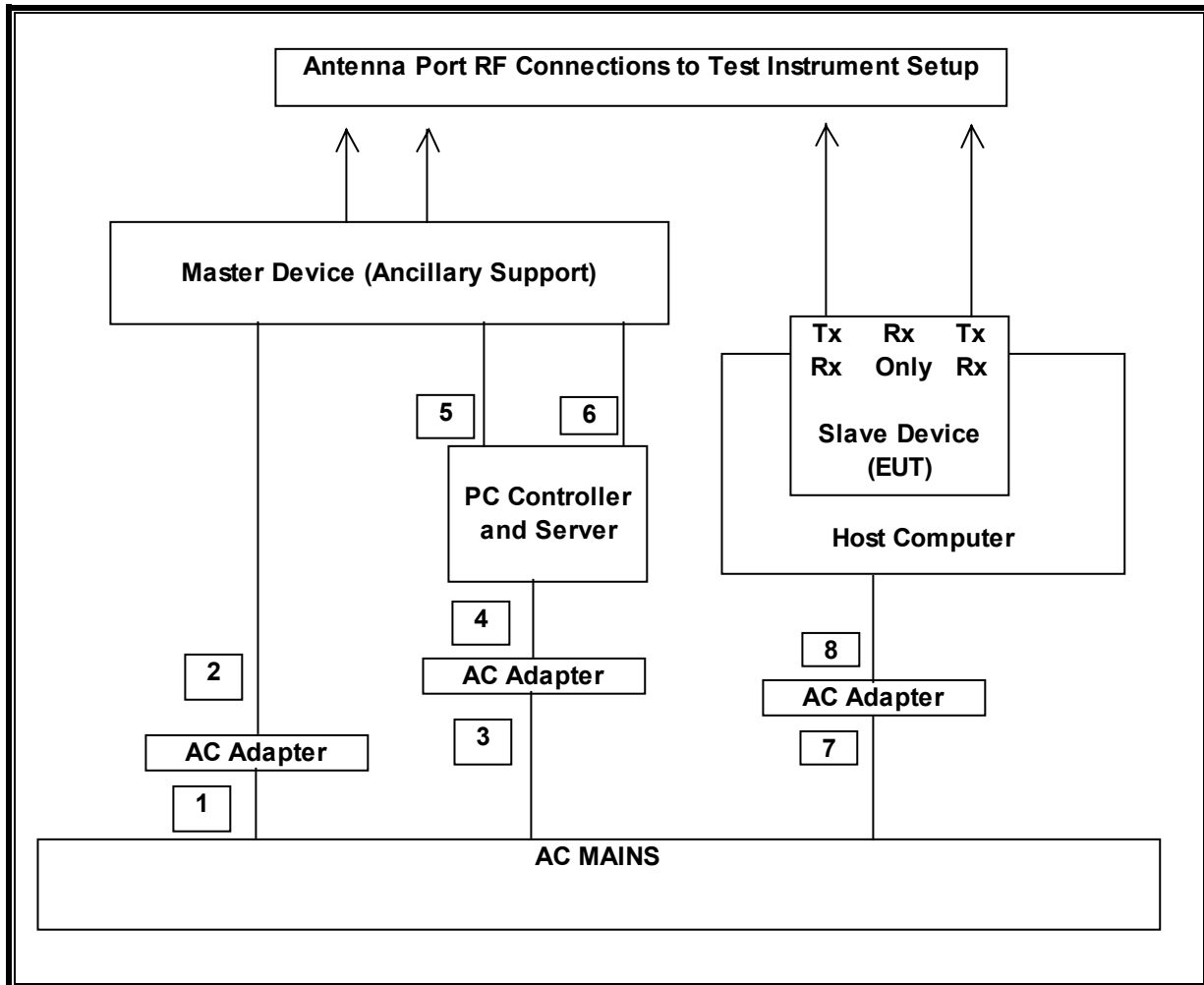

### 7.4.5. PLOTS OF NOISE, RADAR WAVEFORMS, AND WLAN SIGNALS

#### PLOT OF SYSTEM NOISE FLOOR

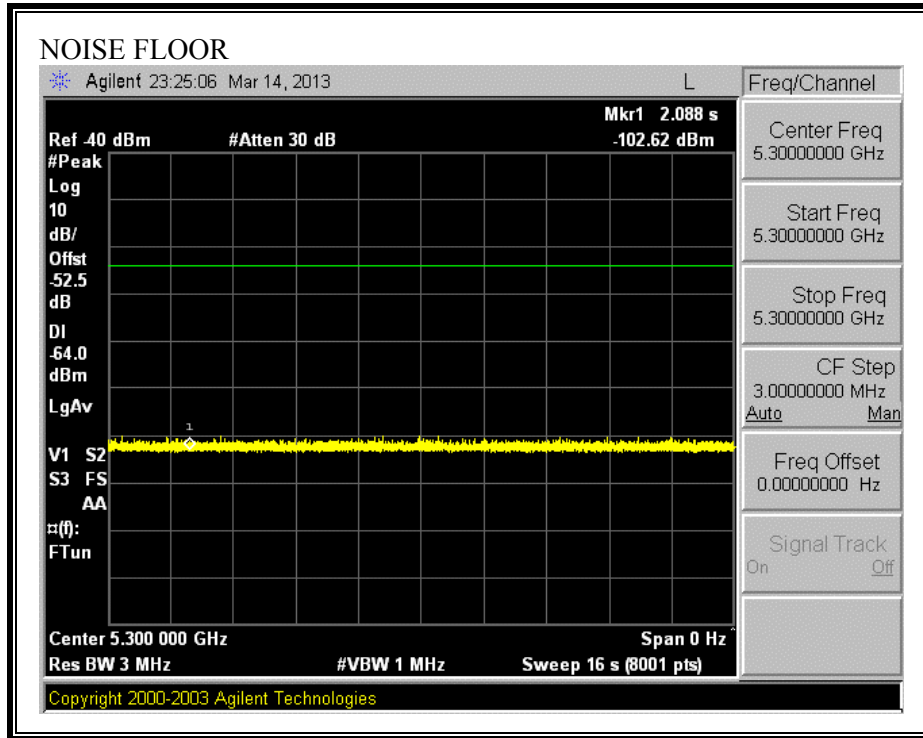

**PLOTS OF RADAR WAVEFORM**

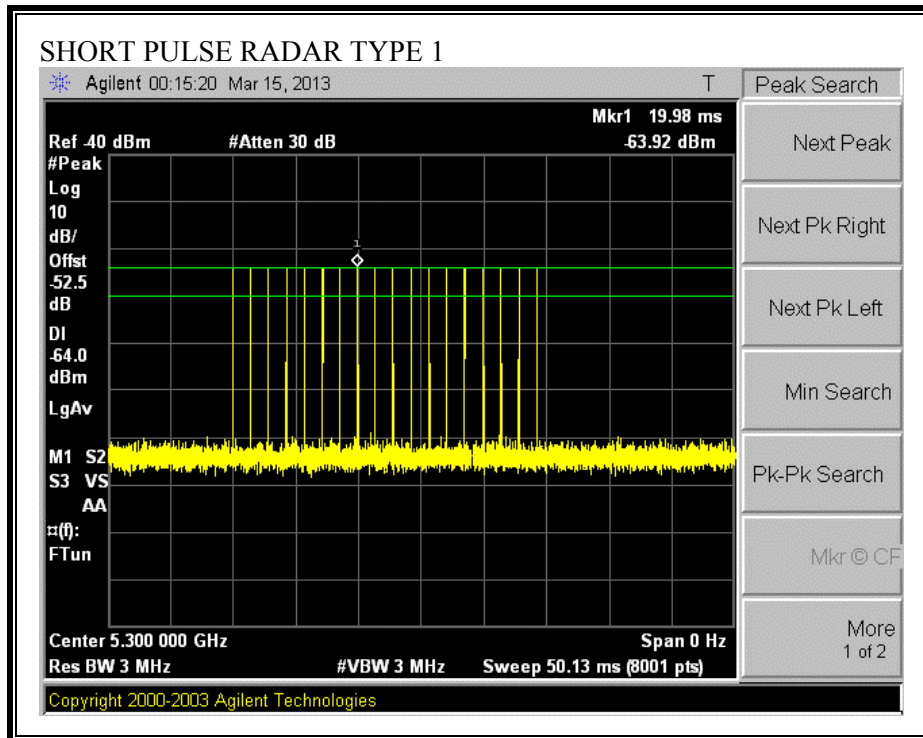

**PLOT OF WLAN TRAFFIC FROM SLAVE**

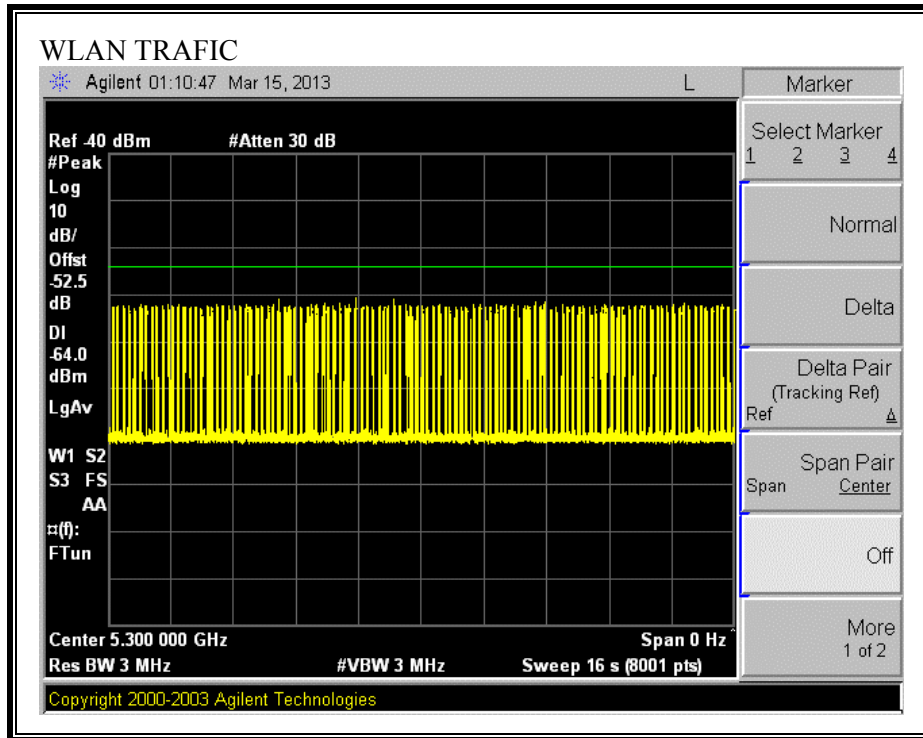

#### **7.4.6. TEST CHANNEL AND METHOD**

All tests were performed at a channel center frequency of 5300 MHz utilizing a conducted test method.

#### **7.4.7. CHANNEL MOVE TIME AND CHANNEL CLOSING TRANSMISSION TIME**

##### **GENERAL REPORTING NOTES**

The reference marker is set at the end of last radar pulse.

The delta marker is set at the end of the last WLAN transmission following the radar pulse. This delta is the channel move time.

The aggregate channel closing transmission time is calculated as follows:

Aggregate Transmission Time =  
(Number of analyzer bins showing transmission) \* (dwell time per bin)

The observation period over which the aggregate time is calculated  
Begins no later than (Reference Marker + 200 msec)  
and  
Ends no earlier than (Reference Marker + 10 sec).

**TYPE 1 CHANNEL MOVE TIME RESULTS**

No non-compliance noted:

Channel Move Time (s)	Limit (s)
2.124	10

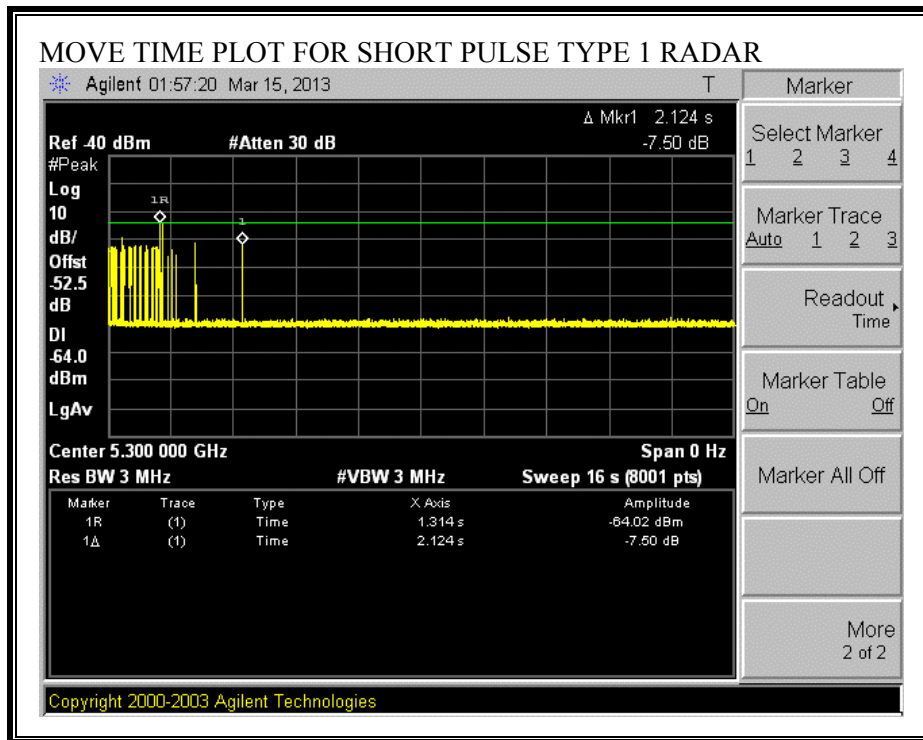

**CHANNEL CLOSING TIME RESULTS**

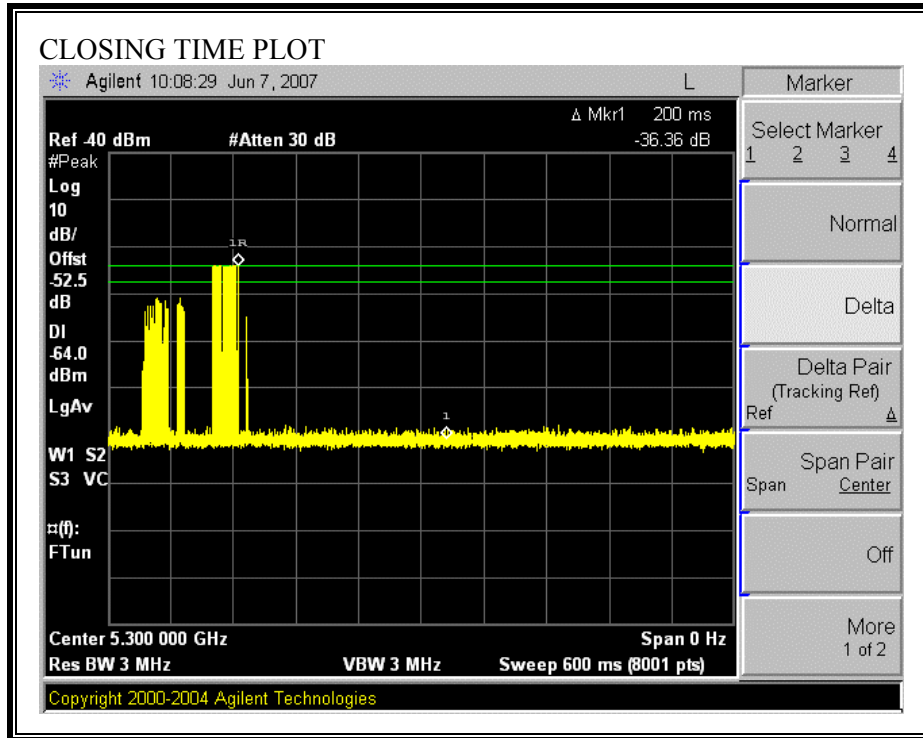



**TYPE 1 CHANNEL CLOSING TRANSMISSION TIME RESULTS**

No non-compliance noted:

Aggregate Transmission Time (ms)	Limit (ms)	Margin (ms)
16.00	60	44.00

Only intermittent transmissions are observed during the aggregate monitoring period.

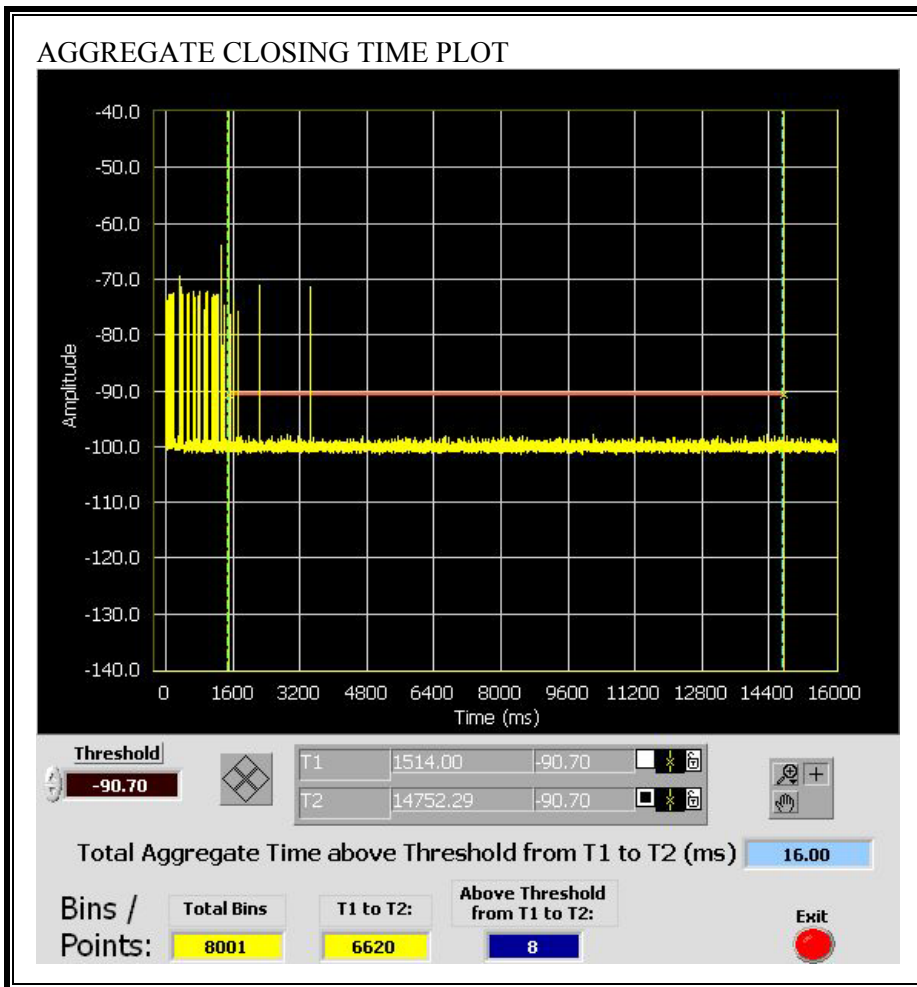

## 7.5. POWERLINE CONDUCTED EMISSIONS

### LIMIT

§15.207 (a) Except as shown in paragraphs (b) and (c) of this section, for an intentional radiator that is designed to be connected to the public utility (AC) power line, the radio frequency voltage that is conducted back onto the AC power line on any frequency or frequencies within the band 150 kHz to 30 MHz shall not exceed the limits in the following table, as measured using a 50  $\mu$ H/50 ohms line impedance stabilization network (LISN). Compliance with the provisions of this paragraph shall be based on the measurement of the radio frequency voltage between each power line and ground at the power terminal.

The lower limit applies at the boundary between the frequency ranges.

Frequency of Emission (MHz)	Conducted Limit (dBuV)	
	Quasi-peak	Average
0.15-0.5	66 to 56*	56 to 46*
0.5-5	56	46
5-30	60	50

\*Decreases with the logarithm of the frequency.

### TEST PROCEDURE

The EUT is placed on a non-conducting table 40 cm from the vertical ground plane and 80 cm above the horizontal ground plane. The EUT is configured in accordance with ANSI C63.4.

The resolution bandwidth is set to 9 kHz for both peak detection and quasi-peak detection measurements. Peak detection is used unless otherwise noted as quasi-peak.

Line conducted data is recorded for both NEUTRAL and HOT lines.

### RESULTS

No non-compliance noted:

**6 WORST EMISSIONS**

CONDUCTED EMISSIONS DATA (115VAC 60Hz)									
Freq.	Reading			Closs	Limit	EN_B	Margin		Remark
(MHz)	PK (dBuV)	QP (dBuV)	AV (dBuV)	(dB)	QP	AV	QP (dB)	AV (dB)	L1 / L2
0.22	54.94	--	42.83	0.00	62.82	52.82	-7.88	-9.99	L1
0.33	45.00	--	31.89	0.00	59.45	49.45	-14.45	-17.56	L1
0.89	33.94	--	33.94	0.00	56.00	46.00	-22.06	-12.06	L1
0.22	50.22	--	39.72	0.00	62.82	52.82	-12.60	-13.10	L2
0.33	39.44	--	30.03	0.00	59.45	49.45	-20.01	-19.42	L2
0.89	34.90	--	33.89	0.00	56.00	46.00	-21.10	-12.11	L2
6 Worst Data									

**LINE 1 RESULTS**

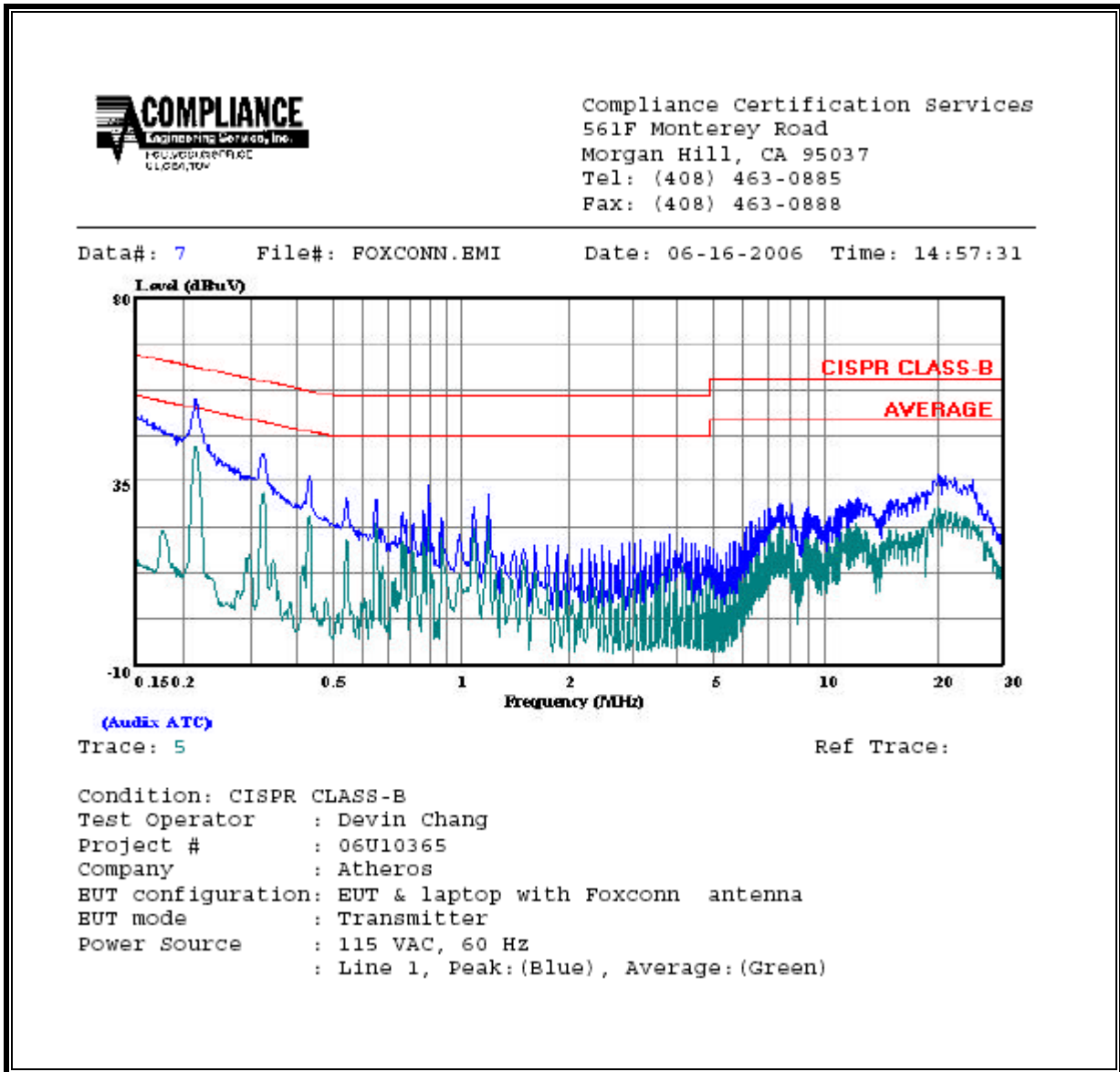

**LINE 2 RESULTS**

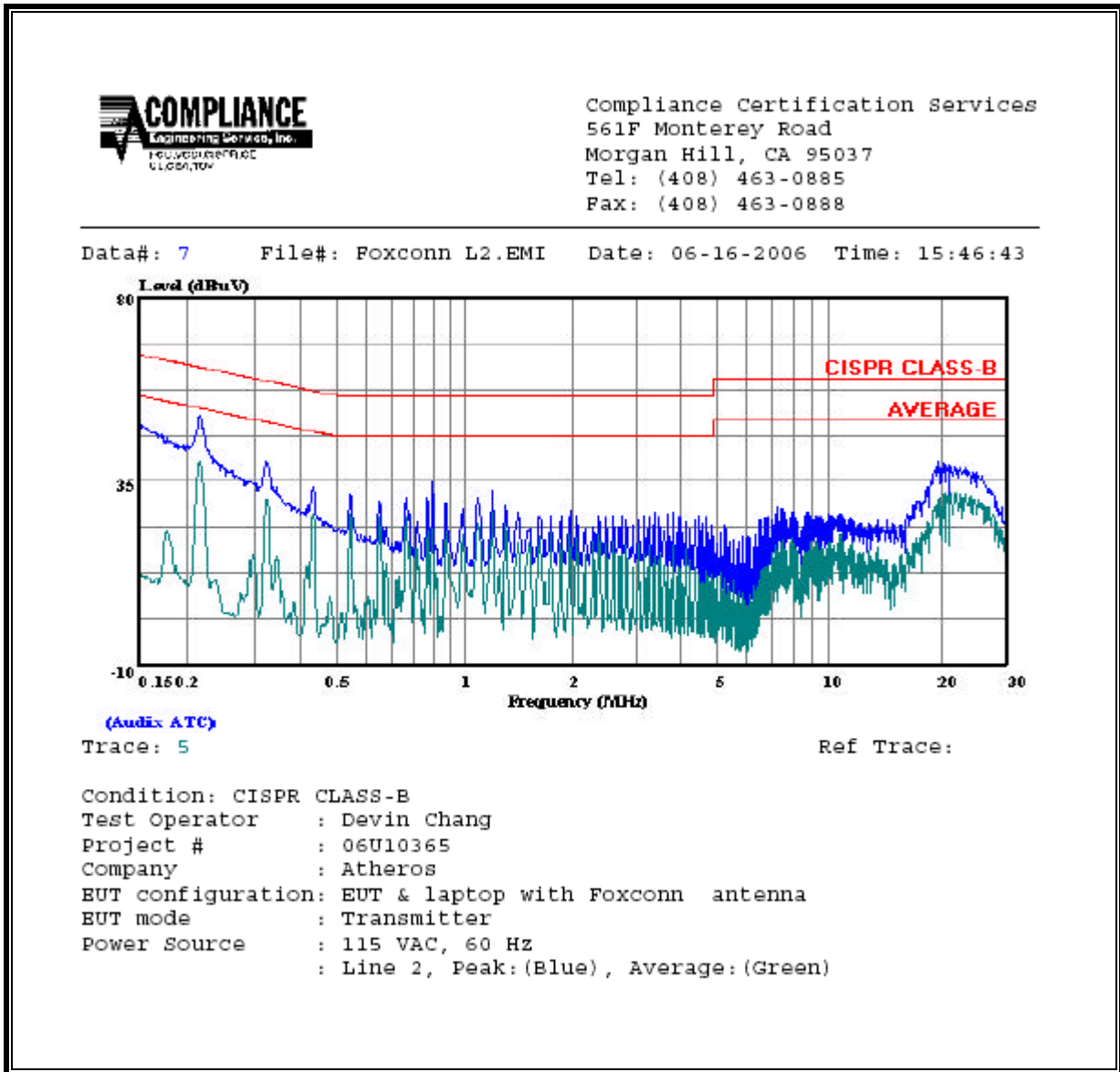

## 9. APPENDIX A: MANUFACTURER'S DECLARATION OF MODEL DIFFERENCES



**ATHEROS**  
COMMUNICATIONS

Federal Communications Commission  
Authorization and Evaluation Division  
7435 Oakland Mills Road  
Columbia, MD 21046

Attn: OET Dept.

Ref: FCC Class II Permissive change for FCC ID: PPD-AR5BXB72P  
(Original Grant date: 7/5/2006)  
Applicant: Atheros Communications, Inc.

Dear Examiner,

We hereby attest that the hardware & firmware of the EUT, are identical to the sample originally tested under Model name: AR5BXB72 for FCC ID: PPD-AR5BXB72.

Sincerely,

  
\_\_\_\_\_

Michael Green / Manager, Global Product Compliance  
Atheros Communications Inc.

Atheros Communications, Inc. 5480 Great America Parkway Santa Clara CA 95054  
t 408 773 5200 f 408-773-9940 www.atheros.com

**END OF REPORT**