



**FCC CFR47 PART 15 SUBPART C
CERTIFICATION
TEST REPORT**

FOR

802.11 b/g ACCESS POINT

MODEL NUMBER: AR5BAP-00031

BRAND NAME: ATHEROS

FCC ID: PPD-AR5BAP-00031

REPORT NUMBER: 03U2013-1

ISSUE DATE: JULY 1, 2003

Prepared for
**ATHEROS COMMUNICATIONS
529 ALMANOR AVE.
SUNNYVALE
CA 94085, USA**

Prepared by
**COMPLIANCE CERTIFICATION SERVICES
561F MONTEREY ROAD,
MORGAN HILL, CA 95037, USA
TEL: (408) 463-0885
FAX: (408) 463-0888**

TABLE OF CONTENTS

1. TEST RESULT CERTIFICATION.....	3
2. EUT DESCRIPTION.....	4
3. TEST METHODOLOGY.....	5
4. FACILITIES AND ACCREDITATION.....	5
4.1. <i>FACILITIES AND EQUIPMENT.....</i>	<i>5</i>
4.2. <i>TABLE OF ACCREDITATIONS AND LISTINGS.....</i>	<i>6</i>
5. CALIBRATION AND UNCERTAINTY.....	7
5.1. <i>MEASURING INSTRUMENT CALIBRATION.....</i>	<i>7</i>
5.2. <i>MEASUREMENT UNCERTAINTY.....</i>	<i>7</i>
5.3. <i>TEST AND MEASUREMENT EQUIPMENT.....</i>	<i>8</i>
6. SETUP OF EQUIPMENT UNDER TEST.....	9
7. APPLICABLE RULES AND TEST RESULTS.....	12
7.1. <i>6 dB BANDWIDTH.....</i>	<i>13</i>
7.2. <i>99% BANDWIDTH.....</i>	<i>21</i>
7.3. <i>PEAK OUTPUT POWER.....</i>	<i>29</i>
7.4. <i>MAXIMUM PERMISSIBLE EXPOSURE.....</i>	<i>38</i>
7.5. <i>AVERAGE POWER.....</i>	<i>40</i>
7.6. <i>PEAK POWER SPECTRAL DENSITY.....</i>	<i>41</i>
7.7. <i>CONDUCTED SPURIOUS EMISSIONS.....</i>	<i>49</i>
7.8. <i>RADIATED EMISSIONS.....</i>	<i>61</i>
7.9. <i>POWERLINE CONDUCTED EMISSIONS.....</i>	<i>99</i>
8. SETUP PHOTOS.....	103

1. TEST RESULT CERTIFICATION

COMPANY NAME: ATHEROS COMMUNICATIONS
529 ALMANOR AVE.
SUNNYVALE, CA 94085

EUT DESCRIPTION: 802.11B/G ACCESS POINT

MODEL: AR5BAP-00031

DATE TESTED: JUNE 1 – JUNE 30, 2003

APPLICABLE STANDARDS	
STANDARD	TEST RESULTS
FCC PART 15 SUBPART C	NO NON-COMPLIANCE NOTED

Compliance Certification Services, Inc. tested the above equipment in accordance with the requirements set forth in the above standards. The test results show that the equipment tested is capable of demonstrating compliance with the requirements as documented in this report.

Note: This document reports conditions under which testing was conducted and results of tests performed. This document may not be altered or revised in any way unless done so by Compliance Certification Services and all revisions are duly noted in the revisions section. Any alteration of this document not carried out by Compliance Certification Services will constitute fraud and shall nullify the document.

Approved & Released For CCS By:

Tested By:



MIKE HECKROTTE
CHIEF ENGINEER
COMPLIANCE CERTIFICATION SERVICES

VIEN TRAN
EMC ENGINEER
COMPLIANCE CERTIFICATION SERVICES

2. EUT DESCRIPTION

The model AR5BAP-00032 Access Point contains two radios capable of simultaneous 802.11b/g (2.4 GHz) and 802.11a (5 GHz) operation.

The AR5BAP-00031 is a depopulated version of the AR5BAP-00032 Access Point and is designed only for 802.11b/g operation. The only difference in the depopulated version is that the 5 GHz circuitry is removed. Tests were performed on the AR5BAP-00032 and the applicable portions are applied to the AR5BAP-00031.

The EUT has an output power of 28.04 dBm (637 mW) and an antenna gain of 1.5 dBi in the 2400 – 2483.5 MHz band.

3. TEST METHODOLOGY

The tests documented in this report were performed in accordance with ANSI C63.4/1992, FCC CFR 47 Part 2 and FCC CFR 47 Part 15.







4. FACILITIES AND ACCREDITATION

4.1. FACILITIES AND EQUIPMENT

The open area test sites and conducted measurement facilities used to collect the radiated data are located at 561F Monterey Road, Morgan Hill, California, USA. The sites are constructed in conformance with the requirements of ANSI C63.7, ANSI C63.4 and CISPR Publication 22.

All receiving equipment conforms to CISPR Publication 16-1, "Radio Interference Measuring Apparatus and Measurement Methods."

4.2. TABLE OF ACCREDITATIONS AND LISTINGS

Country	Agency	Scope of Accreditation	Logo
USA	FCC	3/10 meter Open Area Test Sites to perform FCC Part 15/18 measurements	 1300
Japan	VCCI	CISPR 22 Two OATS and one conducted Site	 R-1014, R-619, C-640
Norway	NEMKO	EN50081-1, EN50081-2, EN50082-1, EN50082-2, IEC61000-6-1, IEC61000-6-2, EN50083-2, EN50091-2, EN50130-4, EN55011, EN55013, EN55014-1, EN55104, EN55015, EN61547, EN55022, EN55024, EN61000-3-2, EN61000-3-3, EN60945, EN61326-1	 ELA 117
Norway	NEMKO	EN60601-1-2 and IEC 60601-1-2, the Collateral Standards for Electro-Medical Products. MDD, 93/42/EEC, AIMD 90/385/EEC	 ELA-171
Taiwan	BSMI	CNS 13438	 SL2-IN-E-1012
Canada	Industry Canada	RSS210 Low Power Transmitter and Receiver	 IC2324 A,B,C, and F

5. CALIBRATION AND UNCERTAINTY

5.1. MEASURING INSTRUMENT CALIBRATION

The measurement instruments utilized to perform the tests documented in this report have been calibrated in accordance with the manufacturer's recommendations, and are traceable to national standards.

5.2. MEASUREMENT UNCERTAINTY

Where relevant, the following measurement uncertainty levels have been estimated for tests performed on the apparatus:

Radiated Emission, 30 to 200 MHz	+/- 3.3 dB
Radiated Emission, 200 to 1000 MHz	+4.5 / -2.9 dB
Radiated Emission, 1000 to 2000 MHz	+4.5 / -2.9 dB
Power Line Conducted Emission	+/- 2.9 dB

Uncertainty figures are valid to a confidence level of 95%.

5.3. TEST AND MEASUREMENT EQUIPMENT

The following test and measurement equipment was utilized for the tests documented in this report:

TEST AND MEASUREMENT EQUIPMENT LIST				
Name of Equipment	Manufacturer	Model	Serial Number	Calibration Due Date
Quasi-Peak Adapter	HP	85650A	2521A01038	7/16/04
SA Display Section	HP	85662A	2314A04793	7/16/04
SA RF Section	HP	85680A	2314A02604	7/16/04
Horn Antenna (1 - 18GHz)	EMCO	3115	6739	2/4/04
Antenna, Biconical	Eaton	94455-1	1214	3/6/04
Antenna, Log Periodic 200-1000MHz	EMCO	3146	9107-3163	3/06/04
Preamplifier	Miteq	NSP10023988	646456	4/26/04
Spectrum Analyzer	HP	8564E	3943A01643	7/22/03
High Pass Filter (4.57GHz)	FSY Microwave	FM-4570-9SS	003	N.C.R.
Spectrum Analyzer	Agilent	E4446A	US42070220	03/01/04
Spectrum Analyzer	Rohde &Schwarz	FSP	100112	06/28/03
Power Sensor	Agilent	E9327A	US40440755	08/09/03

6. SETUP OF EQUIPMENT UNDER TEST

SETUP INFORMATION FOR TRANSMITTER TESTS

SUPPORT EQUIPMENT

PERIPHERAL SUPPORT EQUIPMENT LIST				
Device Type	Manufacturer	Model	Serial Number	FCC ID
Laptop	Toshiba	NA	J291200E8019	Doc
Power Adapter	Toshiba	PA3083U-1ACA	0536906G	Doc
5V DC power adapter	Switching Adapter	RHC-060200-1	0319	DOC

I/O CABLES

Cable No.	Port	# of Identical Ports	Connector Type	Cable Type	Cable Length	Remarks
1	AC	1	US115V	Un-Shielded	2m	NA
2	AC	1	US115V	Un-Shielded	2m	NA
3	DC	1	DC	Un-Shielded	2m	Integral with adapter, ferrite
4	DC	1	DC	Un-Shielded	2m	Integral with adapter
5	RJ45	1	RJ45	Un-Shielded	2m	NA

TEST SETUP

The EUT was controlled by the laptop via Ethernet cable.

SETUP DIAGRAM FOR TRANSMITTER TESTS

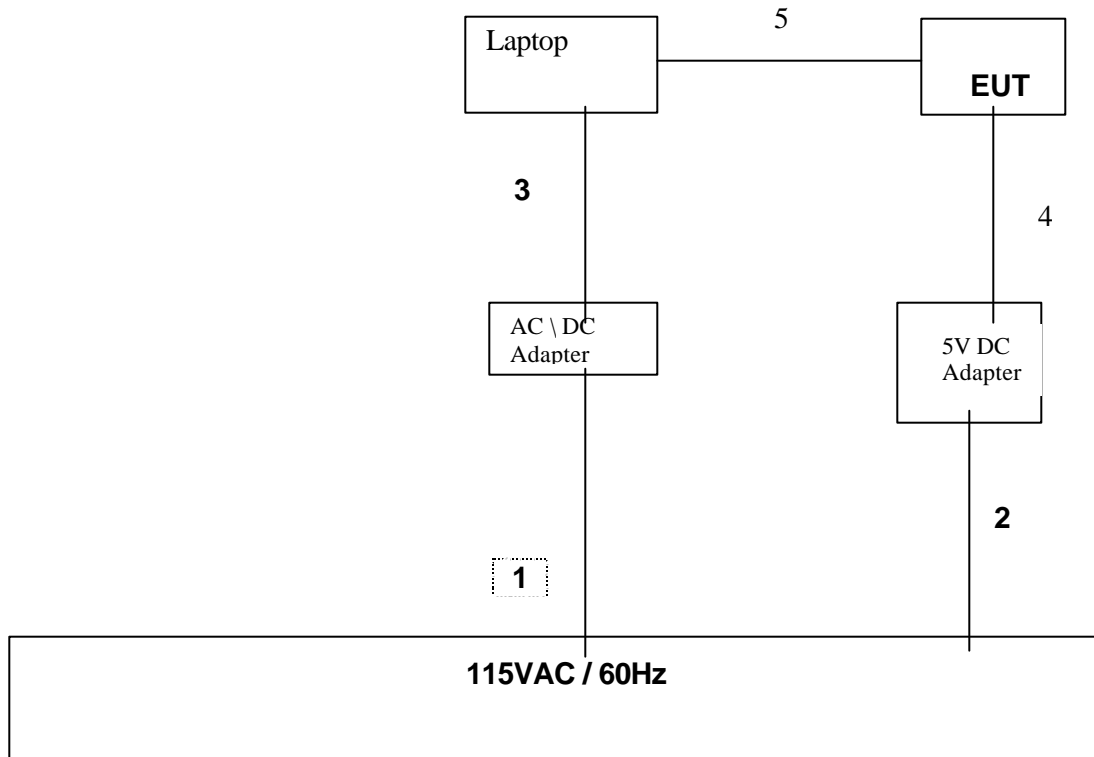

SETUP INFORMATION FOR DIGITAL DEVICE TESTS

SUPPORT EQUIPMENT

PERIPHERAL SUPPORT EQUIPMENT LIST				
Device Type	Manufacturer	Model	Serial Number	FCC ID
Laptop	Toshiba	NA	J291200E8019	Doc
Power Adapter	Toshiba	PA3083U-1ACA	0536906G	Doc
MOUSE	HP	M-S34	LZB75062022	DZL211029
MOUSE	HP	M-S34	LZB80450240	DZL211029
PRINTER	HP	2225C	2541S41679	BS46XU2225C
5V DC power adapter	Switching Adapter	RHC-060200-1	0319	DOC
Modem	Aceex	NA	NA	IFAXDM1414
Power Adapter	Aceex	FB13100	NA	DoC

I/O CABLES

Cable No.	Port	# of Identical Ports	Connector Type	Cable Type	Cable Length	Remarks
1	AC	1	US115V	Un-Shielded	2m	NA
2	AC	3	US115V	Un-Shielded	2m	NA
3	DC	2	DC	Un-Shielded	2m	Integral with adapter
4	DC	1	DC	Un-Shielded	2m	Integral with adapter, ferrite
5	RJ45	1	RJ45	Un-Shielded	2m	NA
6	RJ45	1	RJ45	Un-Shielded	5m	NA
7	RJ45	1	RJ45	Un-Shielded	5m	NA
8	RJ45	1	RJ45	Un-Shielded	5m	NA
9	RJ45	1	RJ45	Un-Shielded	5m	NA
10	Parallel	1	DB25	Shielded	2m	NA
11	Mouse	2	Mini	Shielded	1m	Integral with mouse
12	Serial	1	DB9	Shielded	1m	N/A

TEST SETUP

The EUT was controlled by the laptop via Ethernet cable.

SETUP DIAGRAM FOR DIGITAL DEVICE TESTS

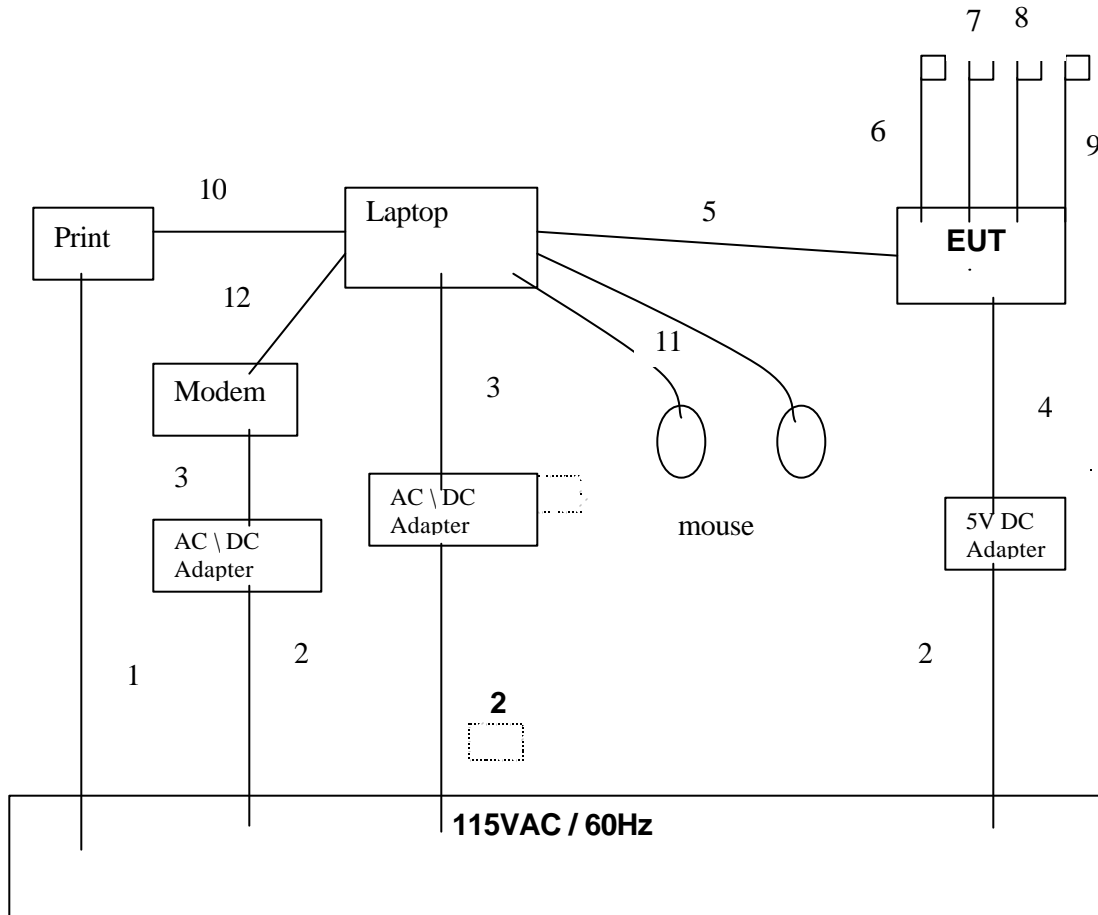

7. APPLICABLE RULES AND TEST RESULTS

7.1. 6 dB BANDWIDTH

LIMIT

§15.247 (a) (2) For direct sequence systems, the minimum 6 dB bandwidth shall be at least 500 kHz.

TEST PROCEDURE

The transmitter output is connected to a spectrum analyzer. The RBW is set to 100 kHz and the VBW is set to 100 kHz. The sweep time is coupled.

RESULTS

No non-compliance noted:

802.11b Mode

Channel	Frequency (MHz)	6 dB Bandwidth (kHz)	Minimum Limit (kHz)	Margin (kHz)
Low	2412	12160	500	11660
Middle	2437	12000	500	11500
High	2462	12000	500	11500

802.11g Normal Mode

Channel	Frequency (MHz)	6 dB Bandwidth (kHz)	Minimum Limit (kHz)	Margin (kHz)
Low	2412	16480	500	15980
Middle	2437	16280	500	15780
High	2462	16240	500	15740

802.11g Turbo Mode

Channel	Frequency (MHz)	6 dB Bandwidth (kHz)	Minimum Limit (kHz)	Margin (kHz)
Middle	2437	32600	500	32100

6 DB BANDWIDTH (802.11b MODE)

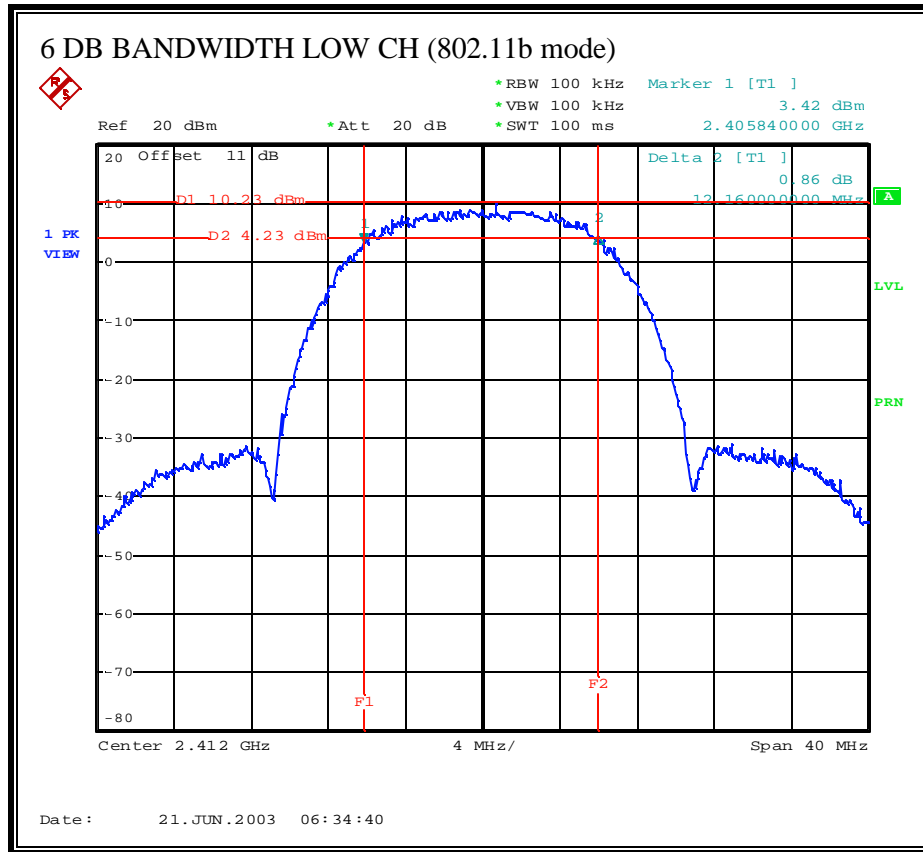

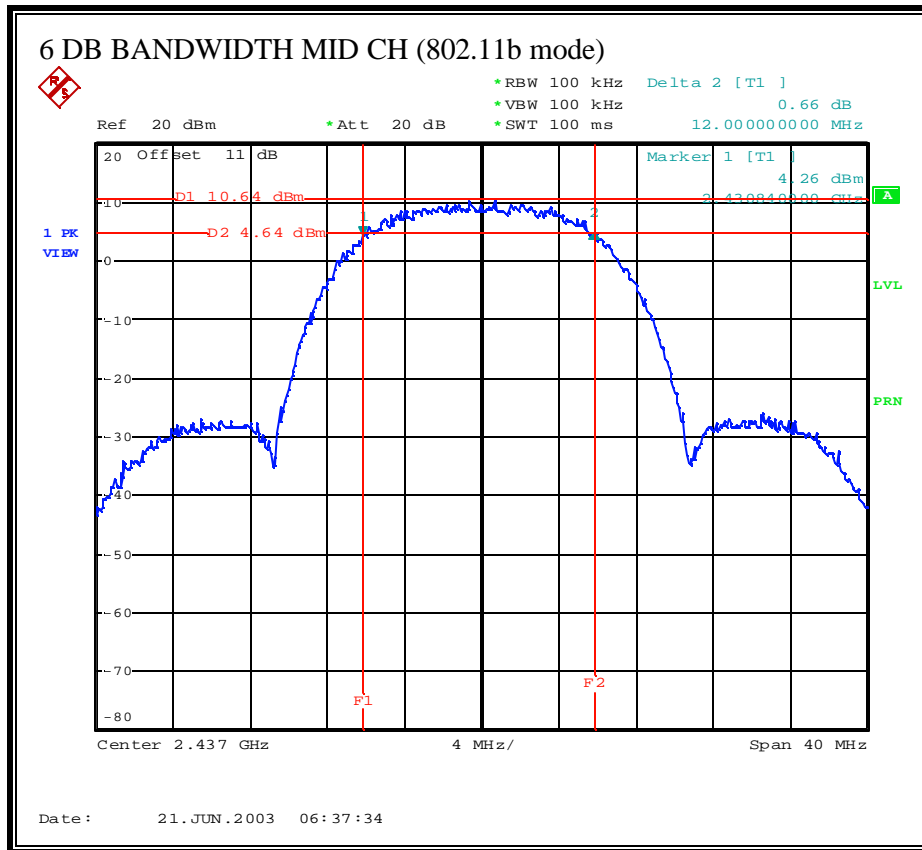

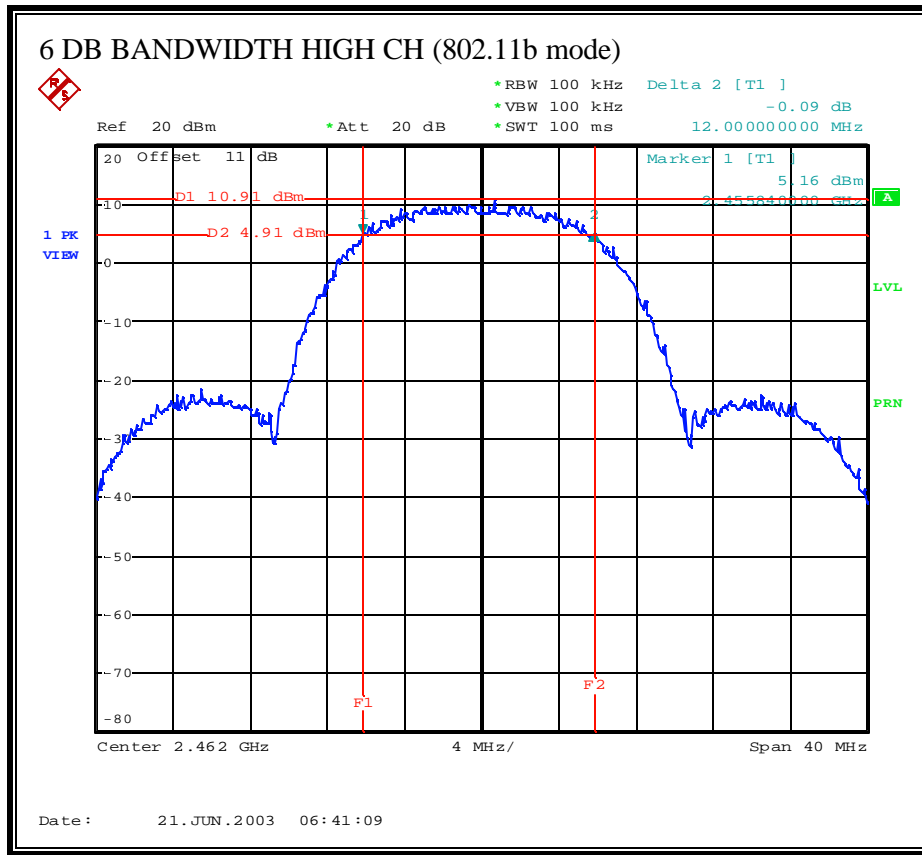

6 DB BANDWIDTH (802.11g NORMAL MODE)

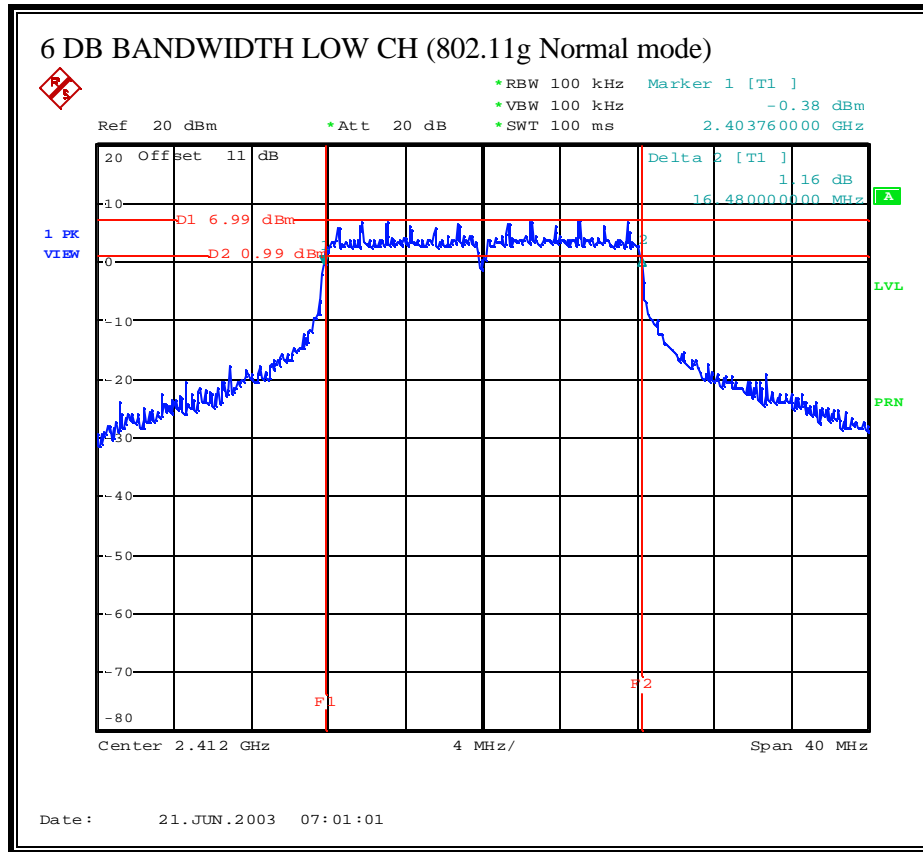

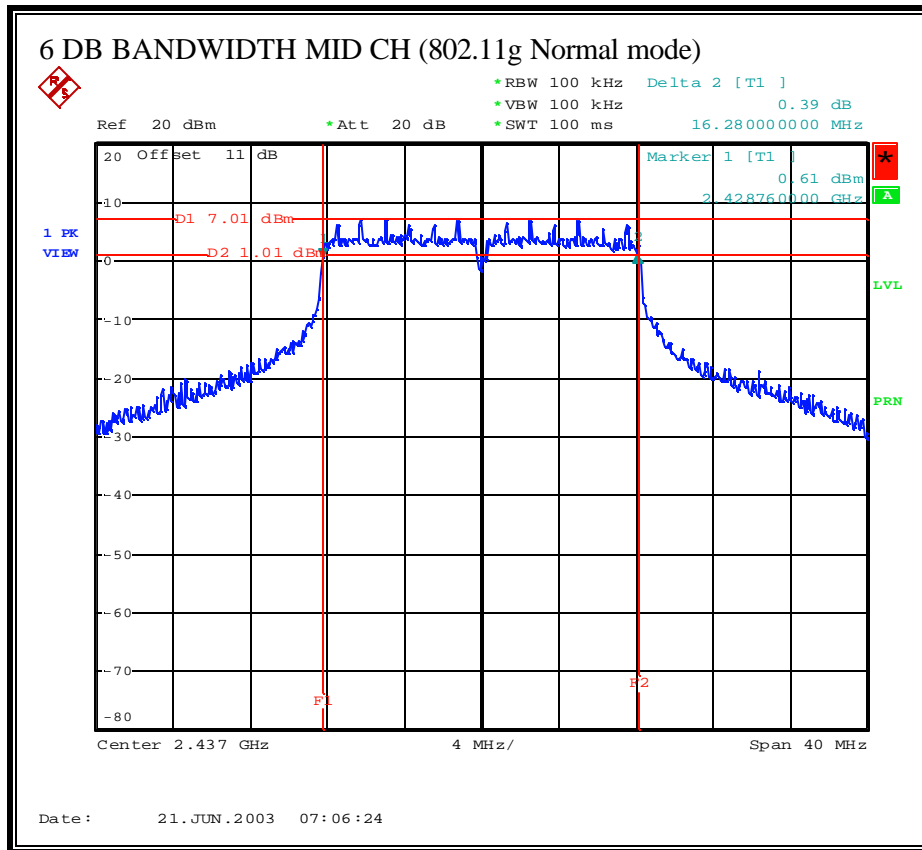

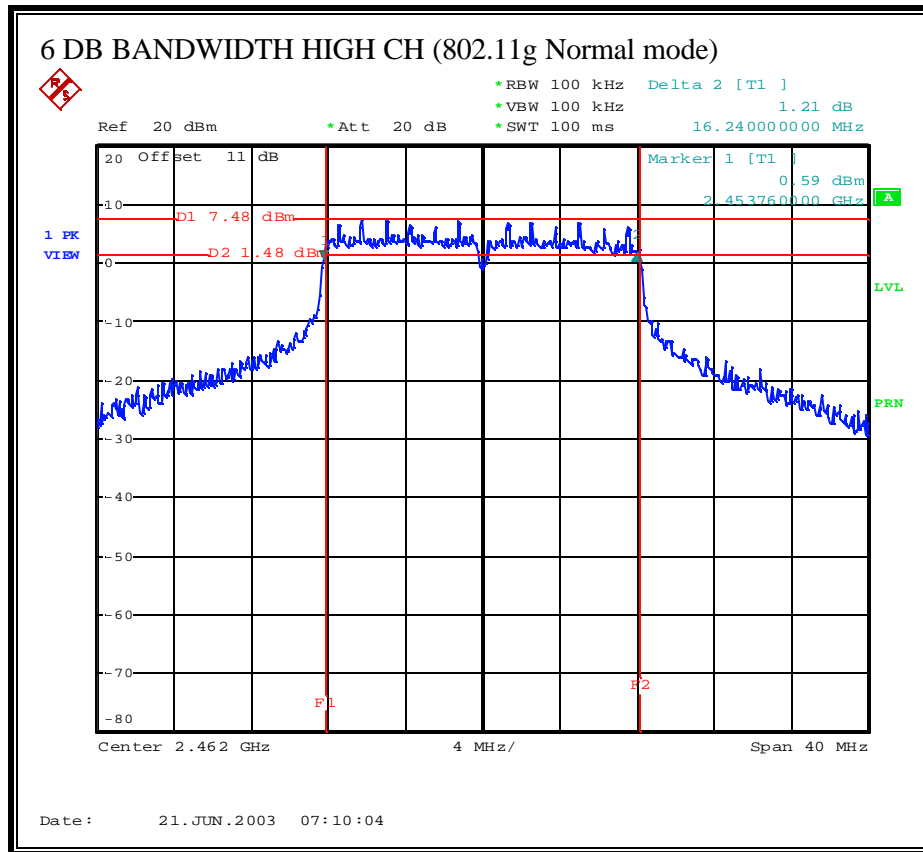

6 DB BANDWIDTH (802.11g TURBO MODE)

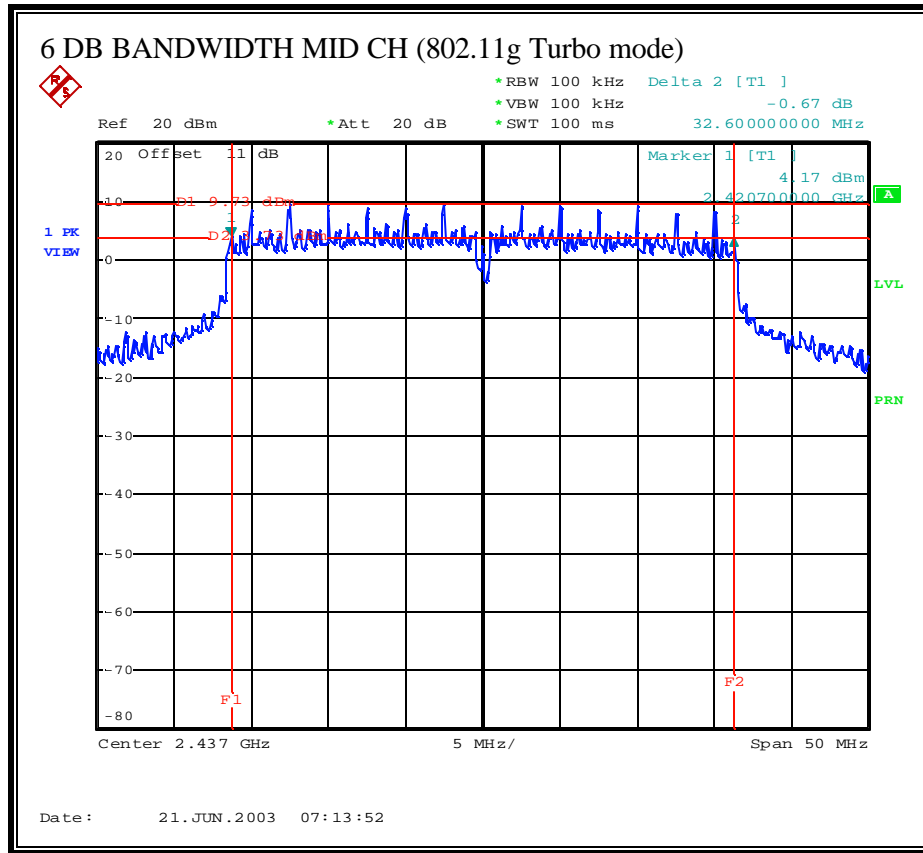

7.2. 99% BANDWIDTH

LIMIT

None; for reporting purposes only.

TEST PROCEDURE

The transmitter output is connected to the spectrum analyzer. The RBW is set to 1% to 3% of the 99 % bandwidth. The VBW is set to 3 times the RBW. The sweep time is coupled. The spectrum analyzer internal 99% bandwidth function is utilized.

RESULTS

No non-compliance noted:

802.11b Mode

Channel	Frequency (MHz)	99% Bandwidth (MHz)
Low	2412	15.5
Middle	2437	15.4
High	2462	15.4

802.11g Normal Mode

Channel	Frequency (MHz)	99% Bandwidth (MHz)
Low	2412	17.05
Middle	2437	17.05
High	2462	17.05

802.11g Turbo Mode

Channel	Frequency (MHz)	99% Bandwidth (MHz)
Middle	2437	35.8

99% BANDWIDTH (802.11b MODE)

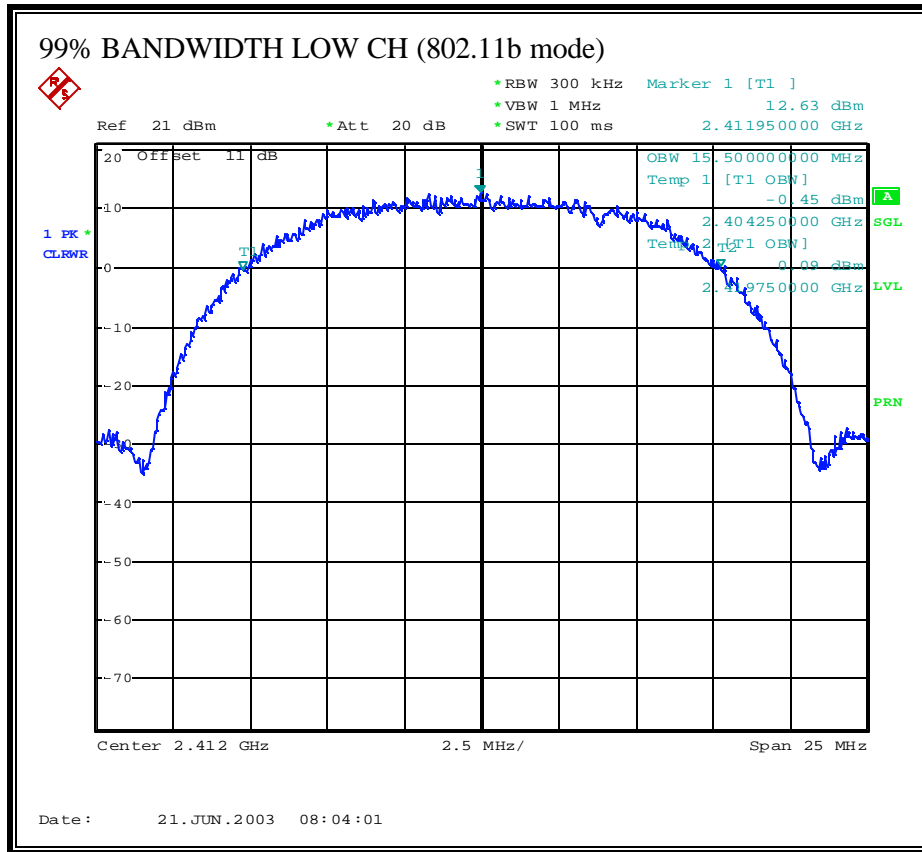

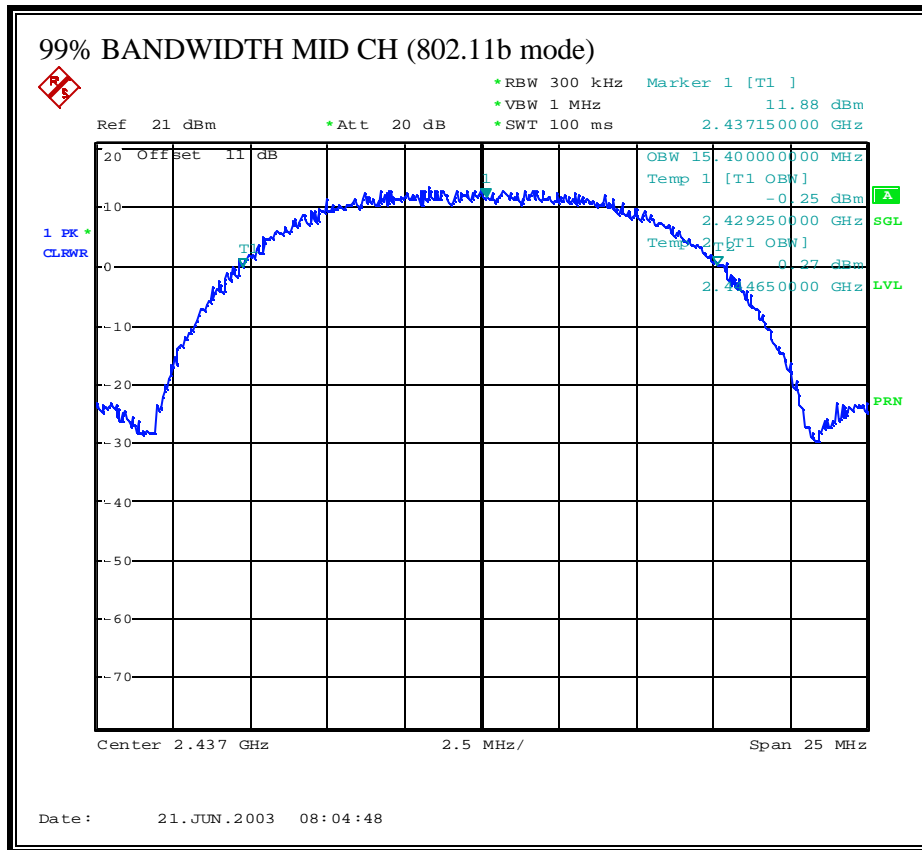

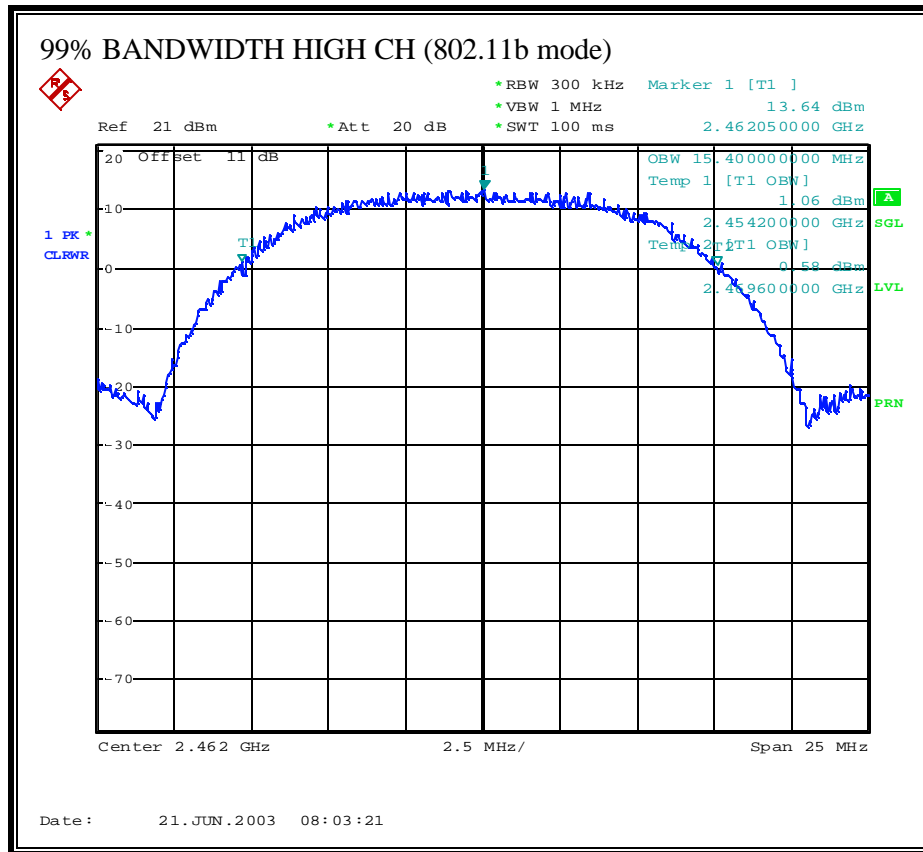

99% BANDWIDTH (802.11g NORMAL MODE)

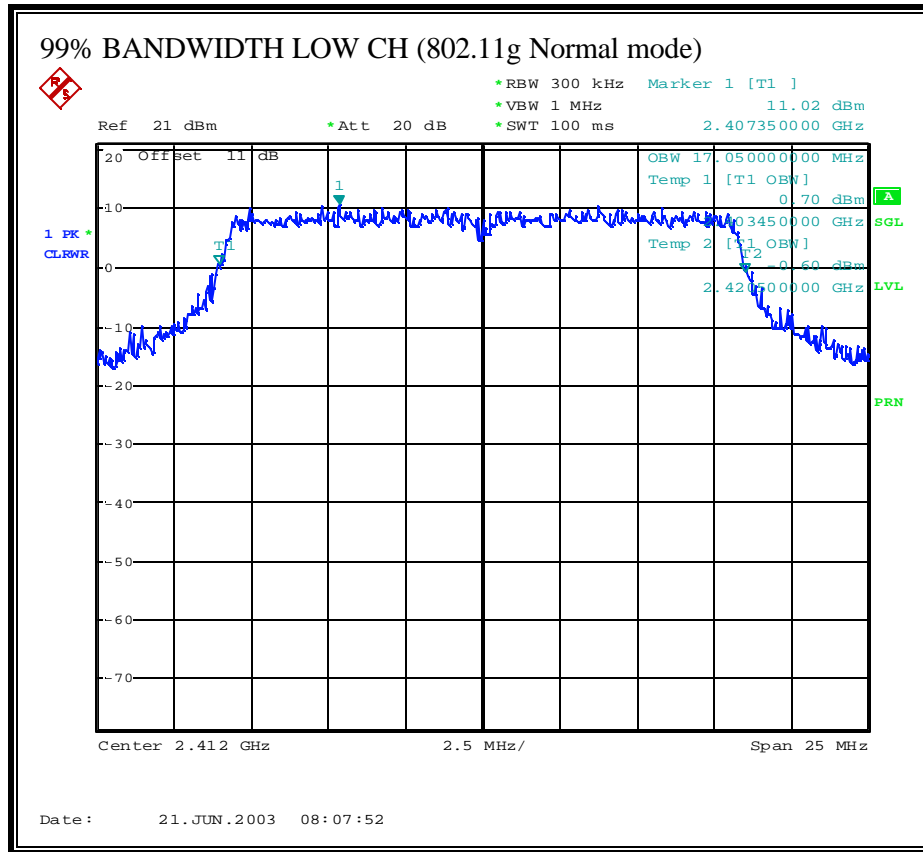

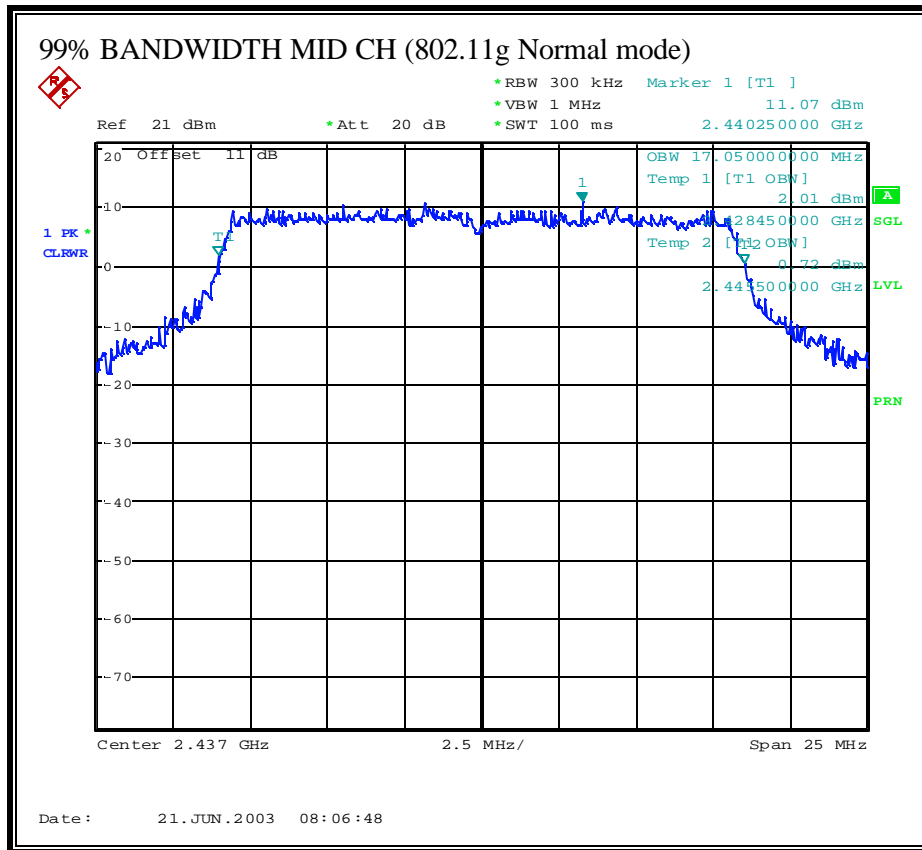

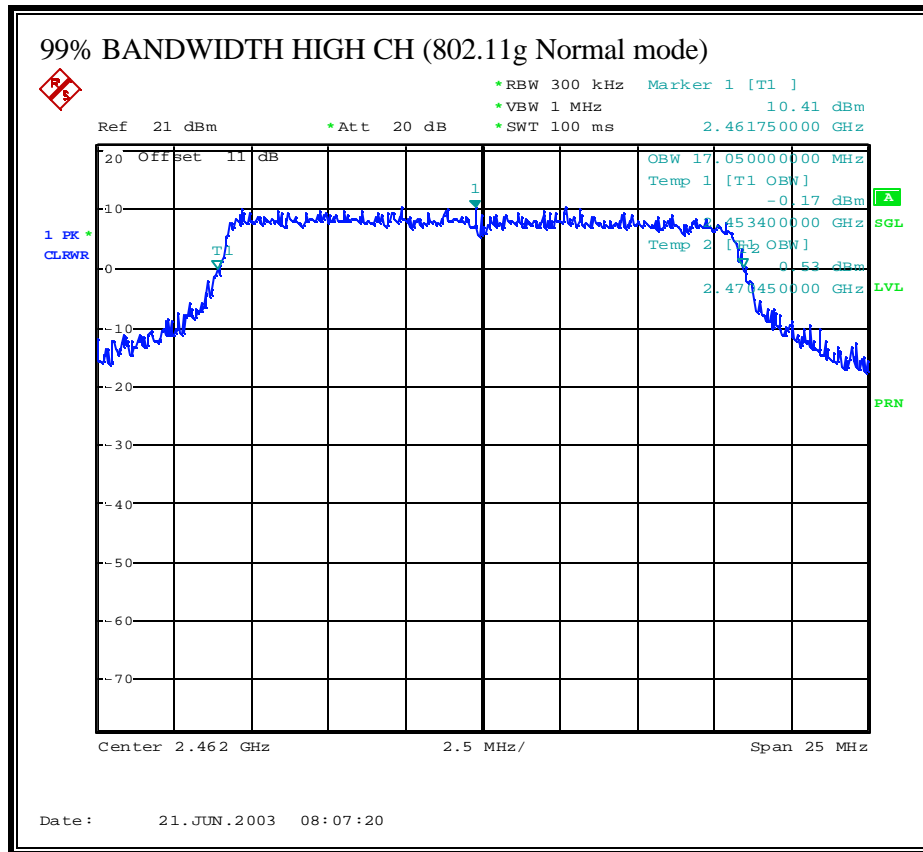

99% BANDWIDTH (802.11g TURBO MODE)

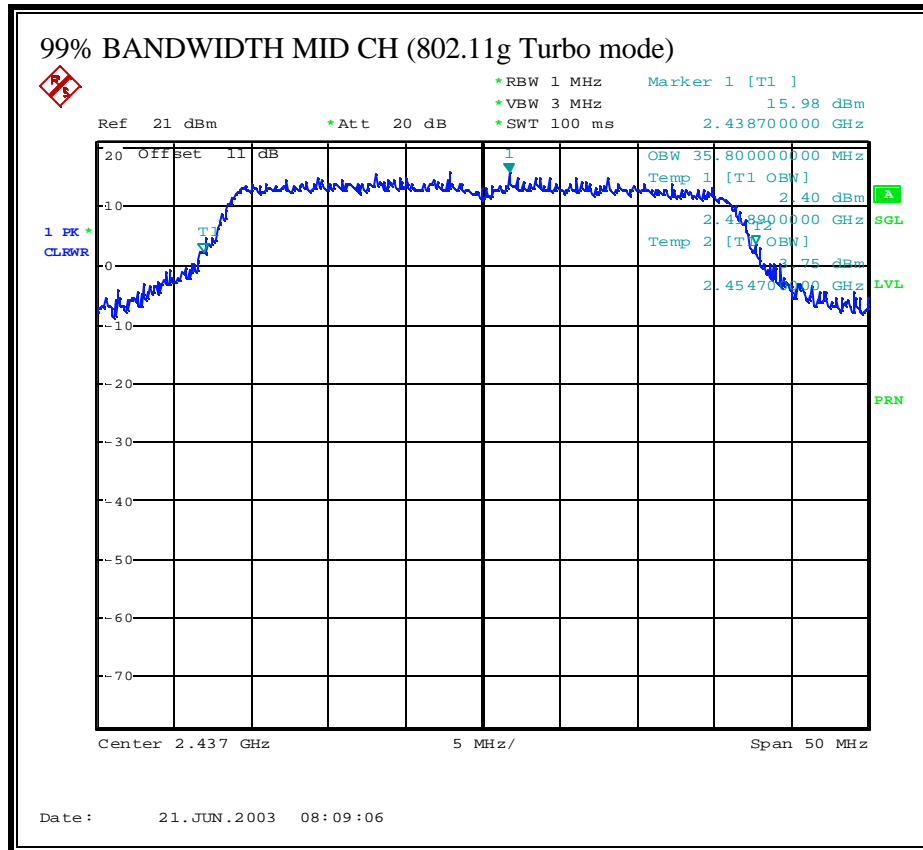

7.3. PEAK OUTPUT POWER

PEAK POWER LIMIT

§15.247 (b) The maximum peak output power of the intentional radiator shall not exceed the following:

§15.247 (b) (3) For systems using digital modulation in the 902-928 MHz, 2400-2483.5 MHz , and 5725-5850 MHz bands: 1 watt.

§15.247 (b) (4) Except as shown in paragraphs (b)(3) (i), (ii) and (iii) of this section, if transmitting antennas of directional gain greater than 6 dBi are used the peak output power from the intentional radiator shall be reduced below the stated values in paragraphs (b)(1) or (b)(2) of this section, as appropriate, by the amount in dB that the directional gain of the antenna exceeds 6 dBi.

The maximum antenna gain is 1.5 dBi, therefore the limit is 30 dBm.

TEST PROCEDURE

The transmitter output is connected to a spectrum analyzer and the analyzer's internal channel power integration function is used to integrate the power.

RESULTS

No non-compliance noted:

802.11b Mode

Channel	Frequency (MHz)	Peak Power (dBm)	Limit (dBm)	Margin (dB)
Low	2412	25.51	30	-4.49
Middle	2437	26.22	30	-3.78
High	2462	26.28	30	-3.72

802.11g Normal Mode

Channel	Frequency (MHz)	Peak Power (dBm)	Limit (dBm)	Margin (dB)
Low	2412	23.07	30	-6.93
Middle	2437	25.94	30	-4.06
High	2462	23.09	30	-6.91

802.11g Turbo Mode

Channel	Frequency (MHz)	Peak Power (dBm)	Limit (dBm)	Margin (dB)
Middle	2437	28.04	30	-1.96

OUTPUT POWER (802.11b MODE)

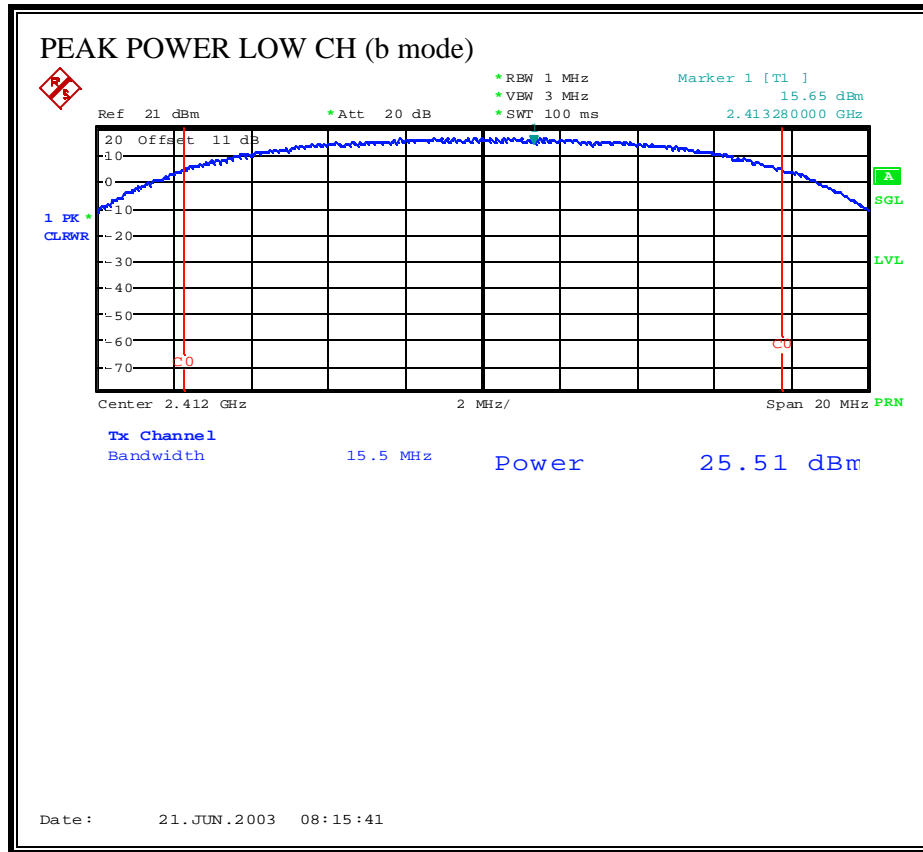

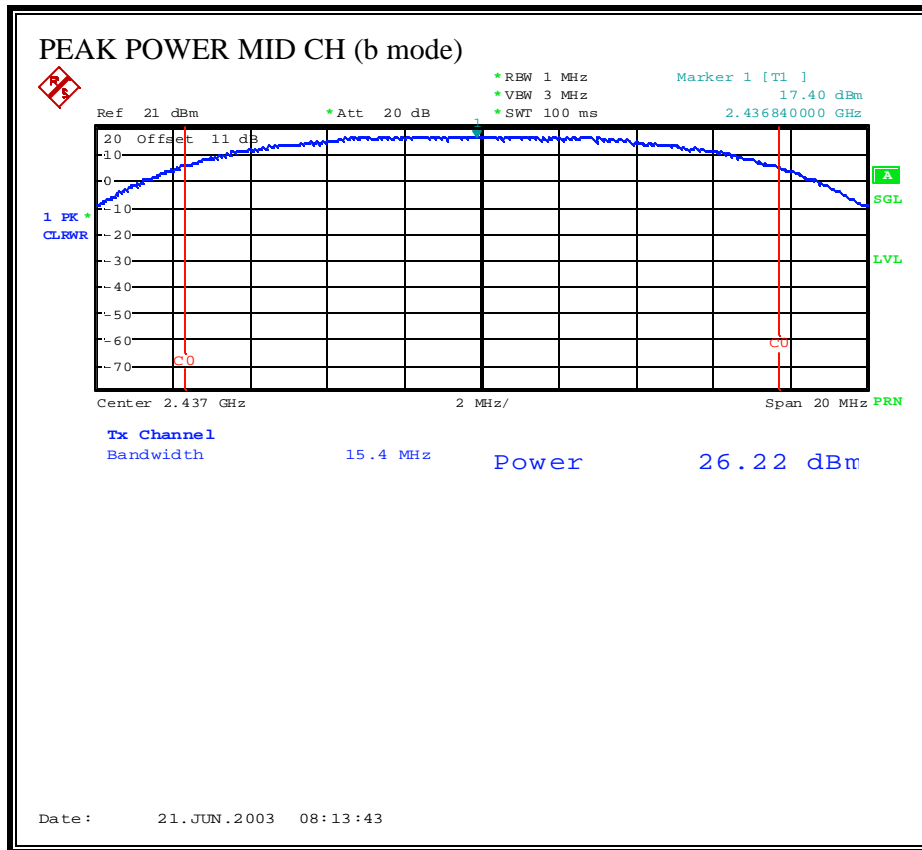

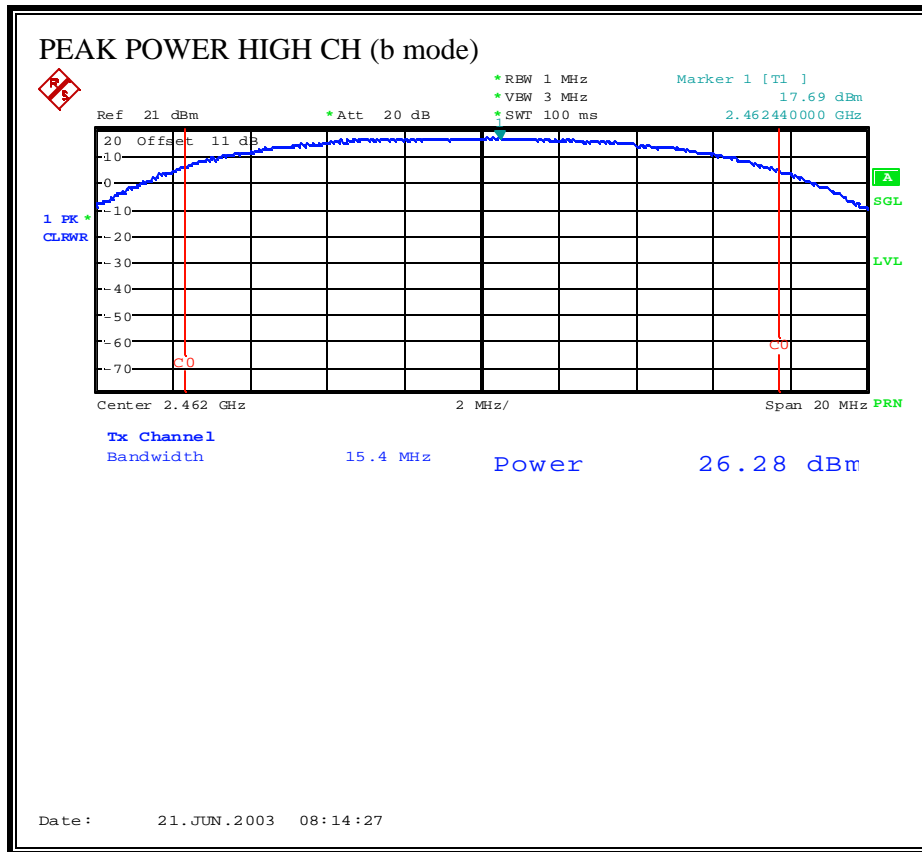

OUTPUT POWER (802.11g NORMAL MODE)

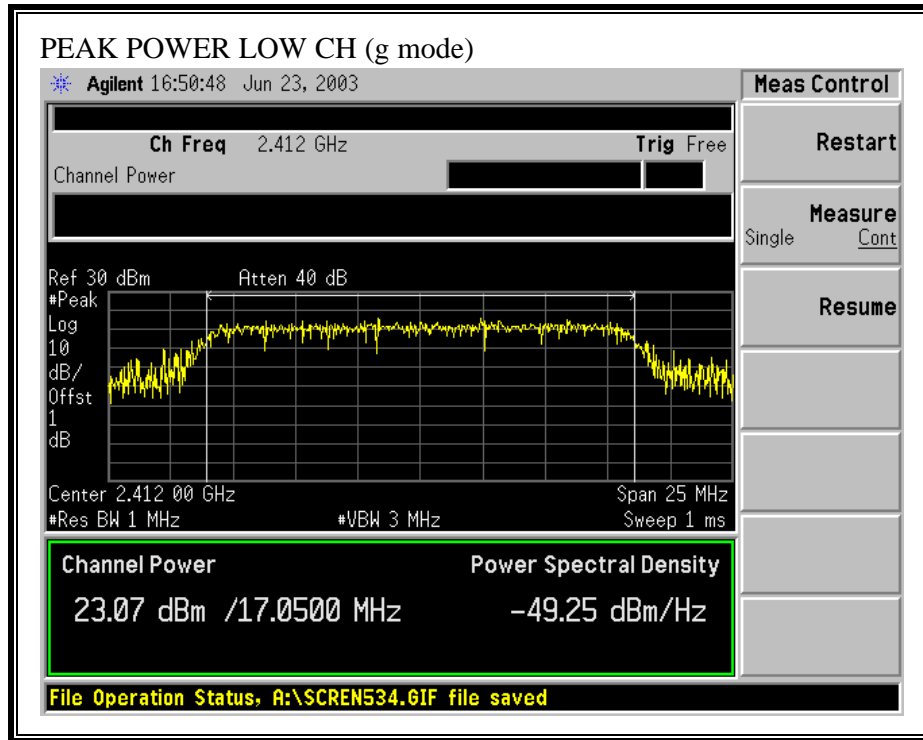

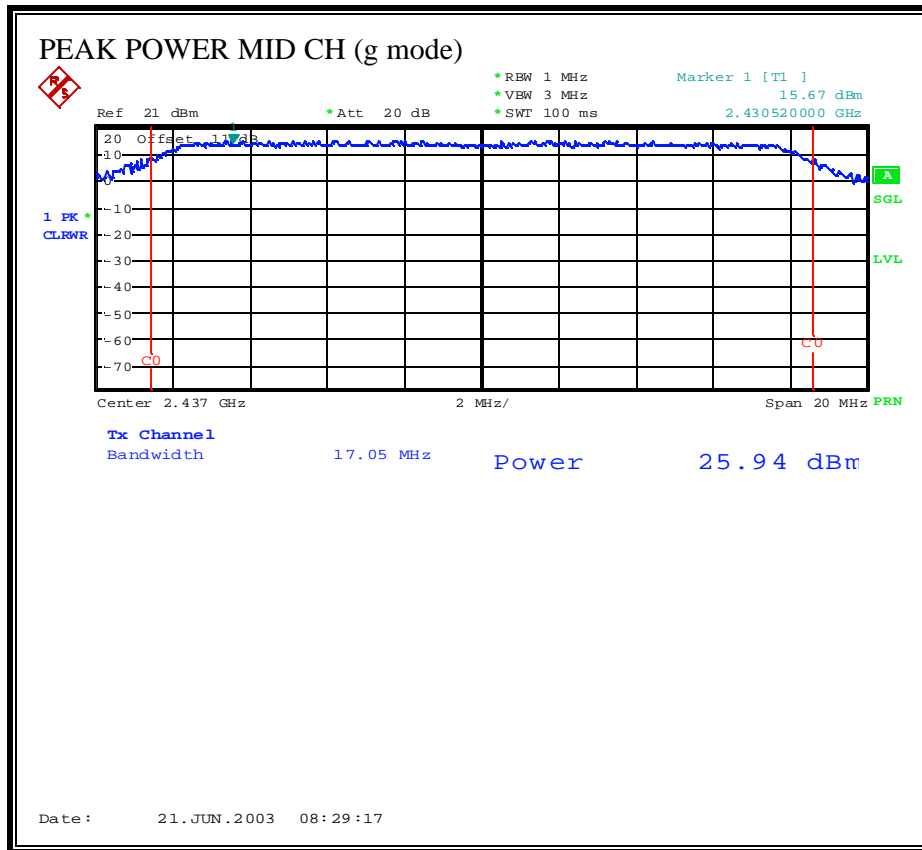

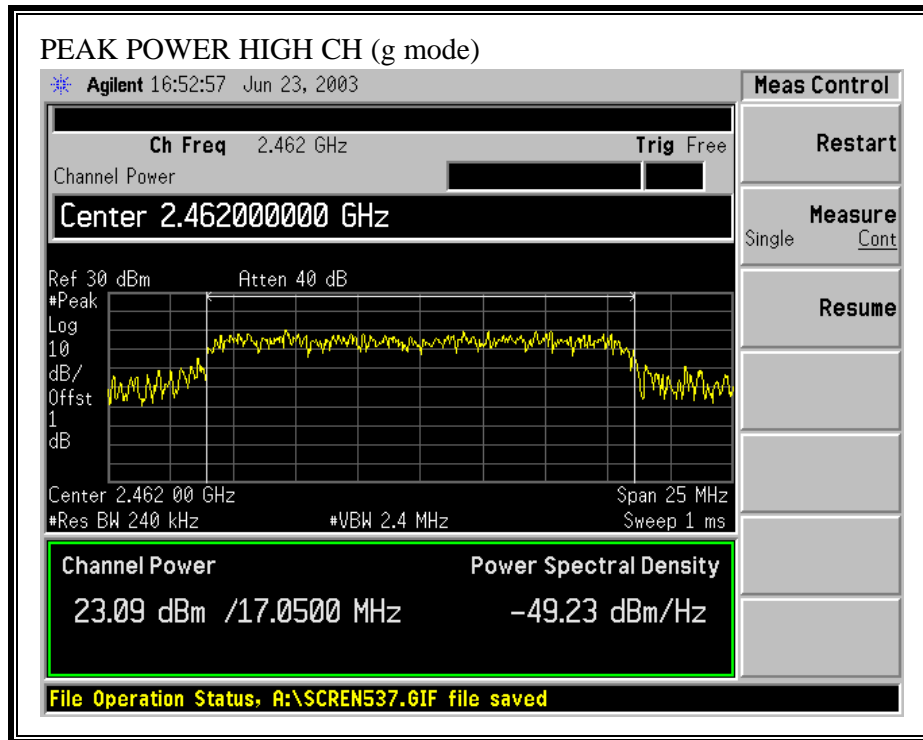

OUTPUT POWER (802.11g TURBO MODE)

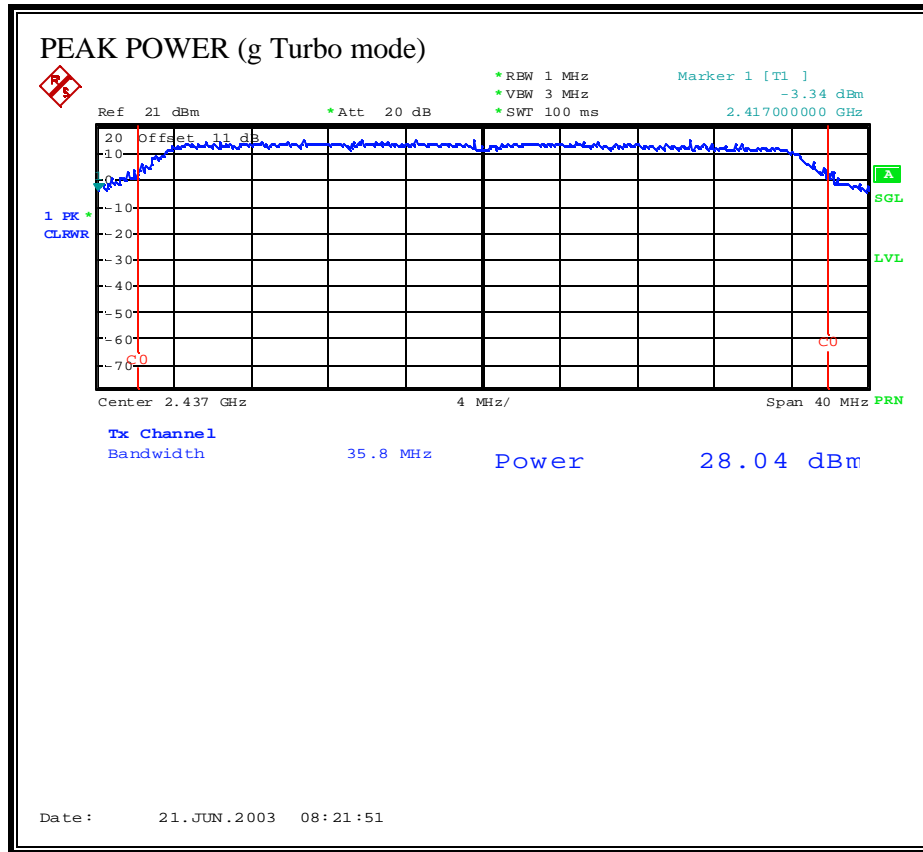

7.4. MAXIMUM PERMISSIBLE EXPOSURE

LIMITS

§15.247 (b) (5) Systems operating under the provisions of this section shall be operated in a manner that ensures that the public is not exposed to radio frequency energy levels in excess of the Commission's guidelines. See §1.1307(b)(1) of this chapter.

CALCULATIONS

Given

$$E = \sqrt{(30 * P * G) / d}$$

and

$$S = E^2 / 3770$$

where

E = Field Strength in Volts / meter

P = Power in Watts

G = Numeric antenna gain

d = distance in meters

S = Power Density in milliwatts / square centimeter

Combining equations and rearranging the terms to express the distance as a function of the remaining variables yields:

$$d = \sqrt{((30 * P * G) / (3770 * S))}$$

Changing to units of mW and cm, using:

$$P \text{ (mW)} = P \text{ (W)} / 1000 \text{ and}$$

$$d \text{ (cm)} = 100 * d \text{ (m)}$$

yields

$$d = 100 * \sqrt{((30 * (P / 1000) * G) / (3770 * S))}$$

$$d = 0.282 * \sqrt{(P * G / S)}$$

where

d = distance in cm

P = Power in mW

G = Numeric antenna gain

S = Power Density in mW / cm²

Substituting the logarithmic form of power and gain using:

$$P \text{ (mW)} = 10^{(P \text{ (dBm)} / 10)} \text{ and}$$
$$G \text{ (numeric)} = 10^{(G \text{ (dBi)} / 10)}$$

yields

$$d = 0.282 * 10^{((P + G) / 20) / \sqrt{S}} \quad \text{Equation (1)}$$

where

- d = MPE distance in cm
- P = Power in dBm
- G = Antenna Gain in dBi
- S = Power Density Limit in mW / cm²

Equation (1) and the measured peak power is used to calculate the MPE distance.

LIMITS

S = 1.0 mW / cm² from 1.1310 Table 1

RESULTS

No non-compliance noted:

Mode	Power Density Limit (mW/cm ²)	Output Power (dBm)	Antenna Gain (dBi)	MPE Distance (cm)
802.11b	1.0	26.28	1.50	6.91
802.11g Normal	1.0	25.94	1.50	6.64
802.11g Turbo	1.0	28.04	1.50	8.46

NOTE: For mobile or fixed location transmitters, the minimum separation distance is 20 cm, even if calculations indicate that the MPE distance would be less.

7.5. AVERAGE POWER

AVERAGE POWER LIMIT

None; for reporting purposes only.

TEST PROCEDURE

The transmitter output is connected to a power meter.

RESULTS

No non-compliance noted:

The cable assembly insertion loss of 1 dB (including 10 dB pad and 1 dB cable) was entered as an offset in the power meter to allow for direct reading of power.

802.11b Mode

Channel	Frequency (MHz)	Average Power (dBm)
Low	2412	19.90
Middle	2437	20.50
High	2462	20.38

802.11g Normal Mode

Channel	Frequency (MHz)	Average Power (dBm)
Low	2412	16.45
Middle	2437	20.45
High	2462	17.24

802.11g Turbo Mode

Channel	Frequency (MHz)	Average Power (dBm)
Middle	2437	18.94

7.6. PEAK POWER SPECTRAL DENSITY

LIMIT

§15.247 (d) For direct sequence systems, the peak power spectral density conducted from the intentional radiator to the antenna shall not be greater than 8 dBm in any 3 kHz band during any time interval of continuous transmission.

TEST PROCEDURE

The transmitter output is connected to a spectrum analyzer, the maximum level in a 3 kHz bandwidth is measured with the spectrum analyzer using RBW = 3 kHz and VBW \geq 3KHz, sweep time = span / 3 kHz, and video averaging is turned off. The PPSD is the highest level found across the emission in any 3 kHz band.

2.4 GHz BAND RESULTS

No non-compliance noted:

802.11b Mode

Channel	Frequency (MHz)	PPSD (dBm)	Limit (dBm)	Margin (dB)
Low	2412	-1.01	8	-9.01
Middle	2437	-0.12	8	-8.12
High	2462	-0.19	8	-8.19

802.11g Normal Mode

Channel	Frequency (MHz)	PPSD (dBm)	Limit (dBm)	Margin (dB)
Low	2412	-3.04	8	-11.04
Middle	2437	-2.51	8	-10.51
High	2462	-2.42	8	-10.42

802.11g Turbo Mode

Channel	Frequency (MHz)	PPSD (dBm)	Limit (dBm)	Margin (dB)
Middle	2437	-2.68	8	-10.68

PEAK POWER SPECTRAL DENSITY (802.11b MODE)

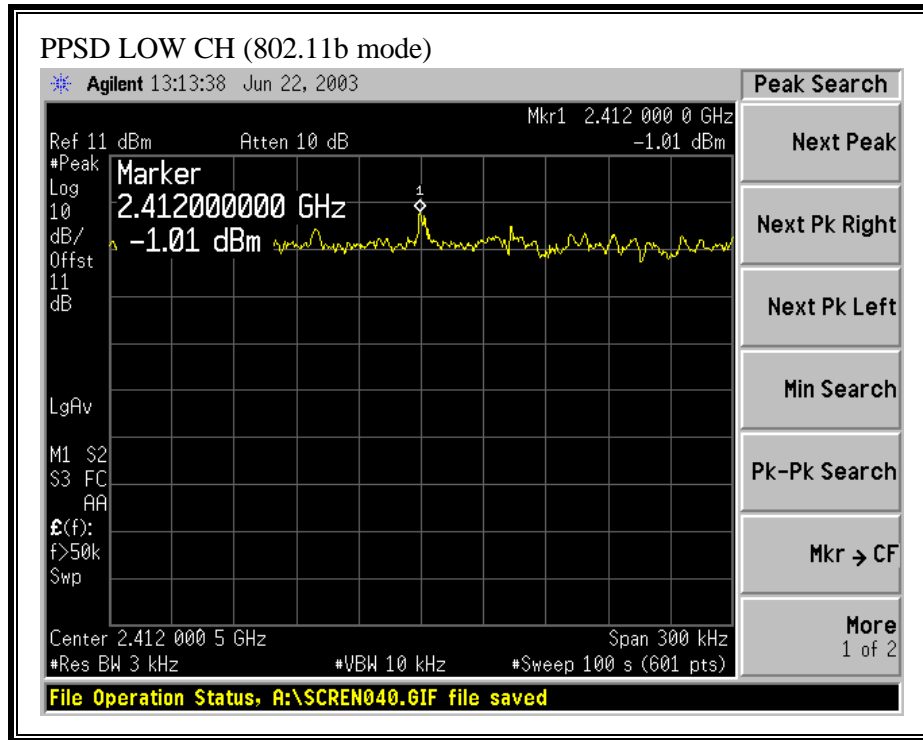

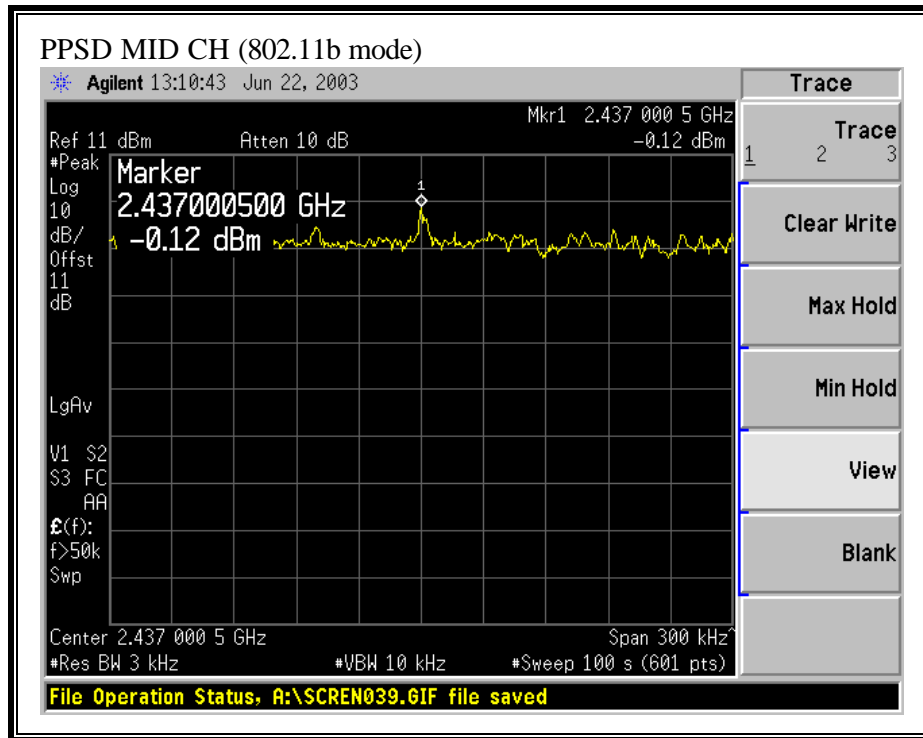

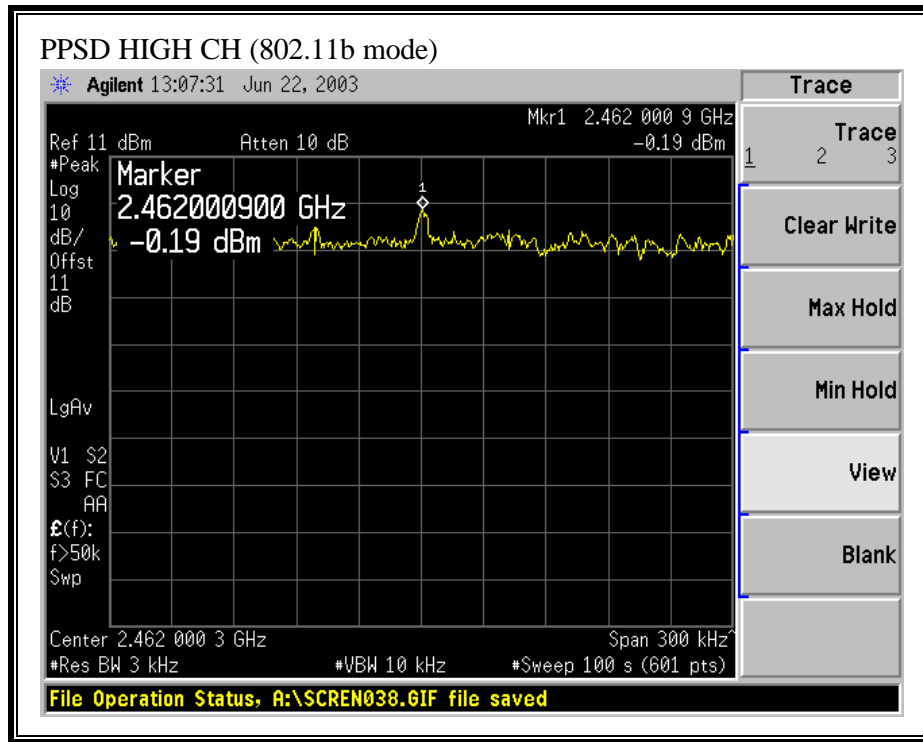

PEAK POWER SPECTRAL DENSITY (802.11g NORMAL MODE)

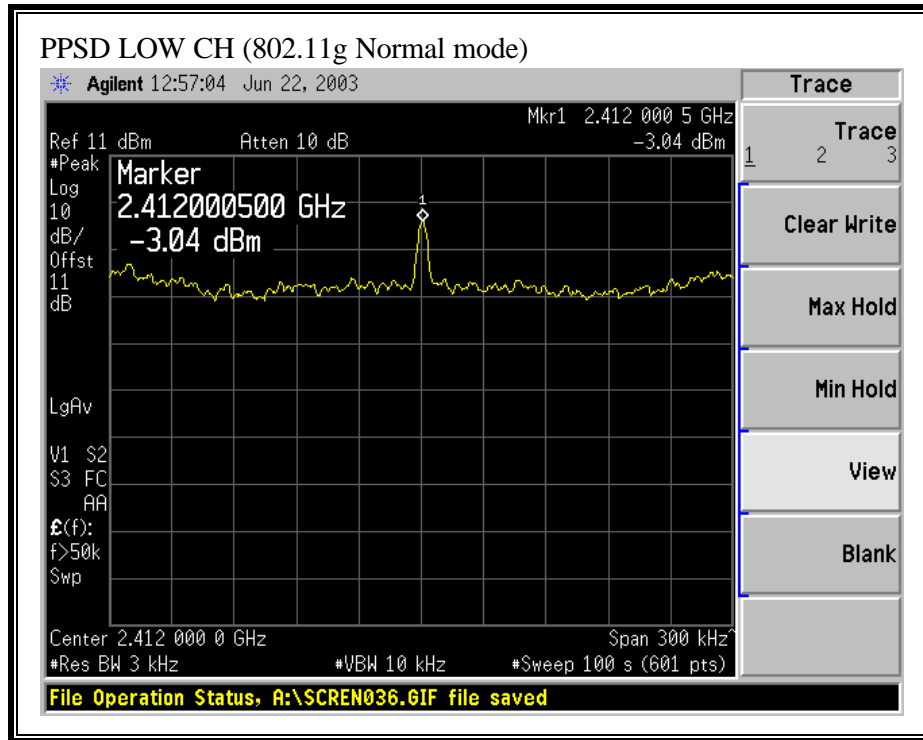

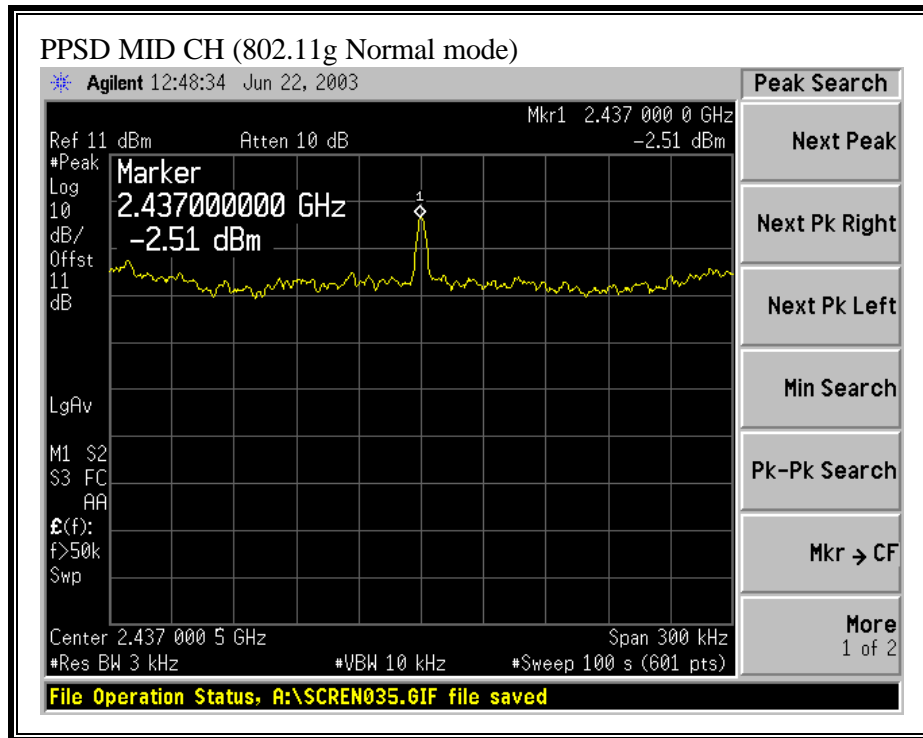

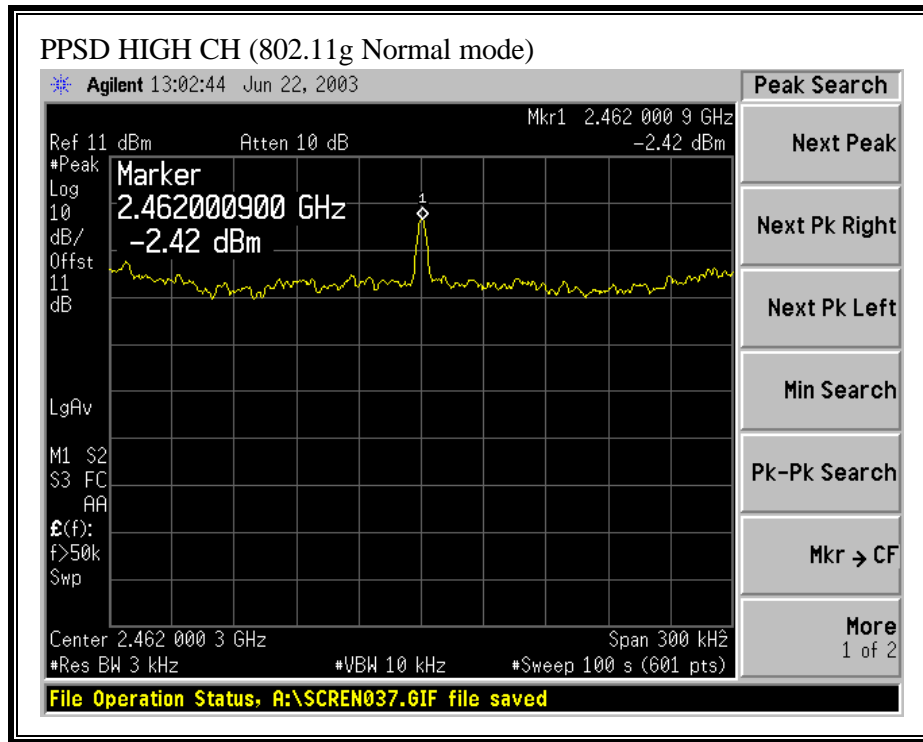

PEAK POWER SPECTRAL DENSITY (802.11g TURBO MODE)

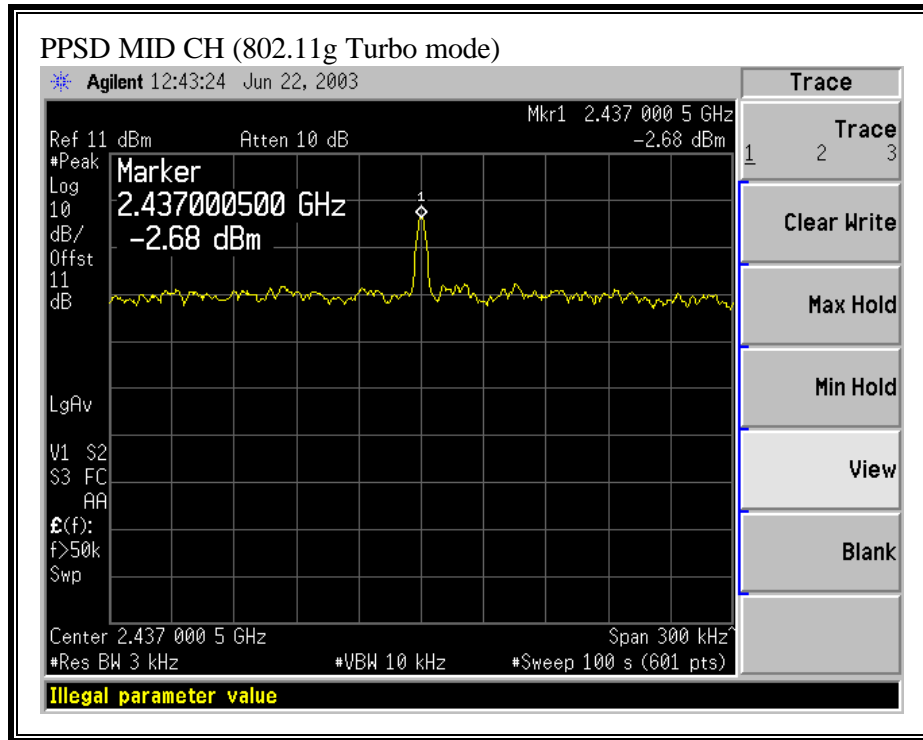

7.7. CONDUCTED SPURIOUS EMISSIONS

LIMITS

§15.247 (c) In any 100 kHz bandwidth outside the frequency band in which the spread spectrum intentional radiator is operating, the radio frequency power that is produced by the intentional radiator shall be at least 20 dB below that in the 100 kHz bandwidth within the band that contains the highest level of the desired power, based on either an RF conducted or a radiated measurement. Attenuation below the general limits specified in §15.209(a) is not required. In addition, radiated emissions which fall in the restricted bands, as defined in §15.205(a), must also comply with the radiated emission limits specified in §15.209(a) (see §15.205(c)).

TEST PROCEDURE

The transmitter output is connected to a spectrum analyzer. The resolution bandwidth is set to 100 kHz. The video bandwidth is set to 100 kHz.

The spectrum from 30 MHz to 26 GHz is investigated with the transmitter set to the lowest, middle, and highest channels.

RESULTS

No non-compliance noted:

SPURIOUS EMISSIONS, LOW CHANNEL (802.11b MODE)

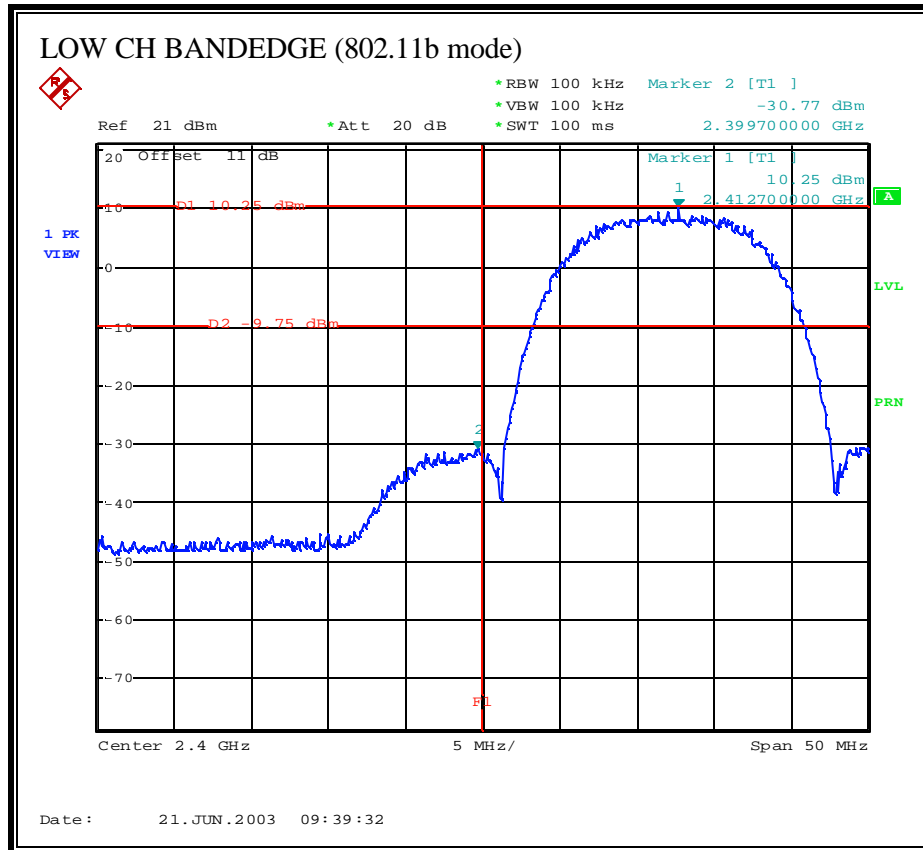

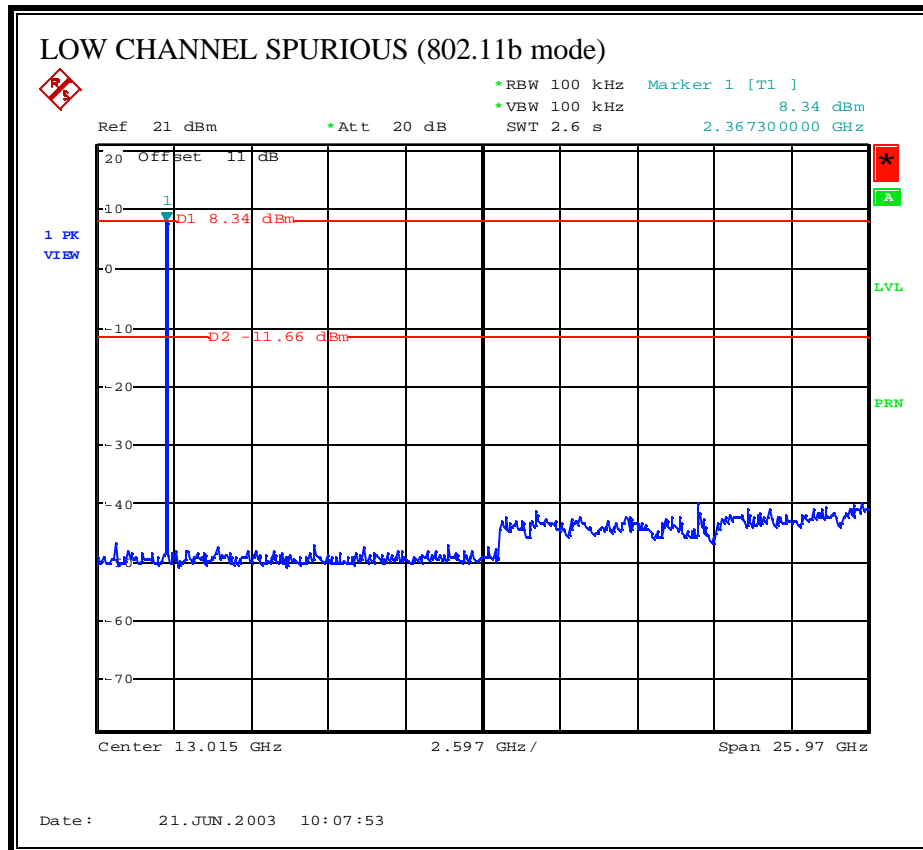

SPURIOUS EMISSIONS, MID CHANNEL (802.11b MODE)

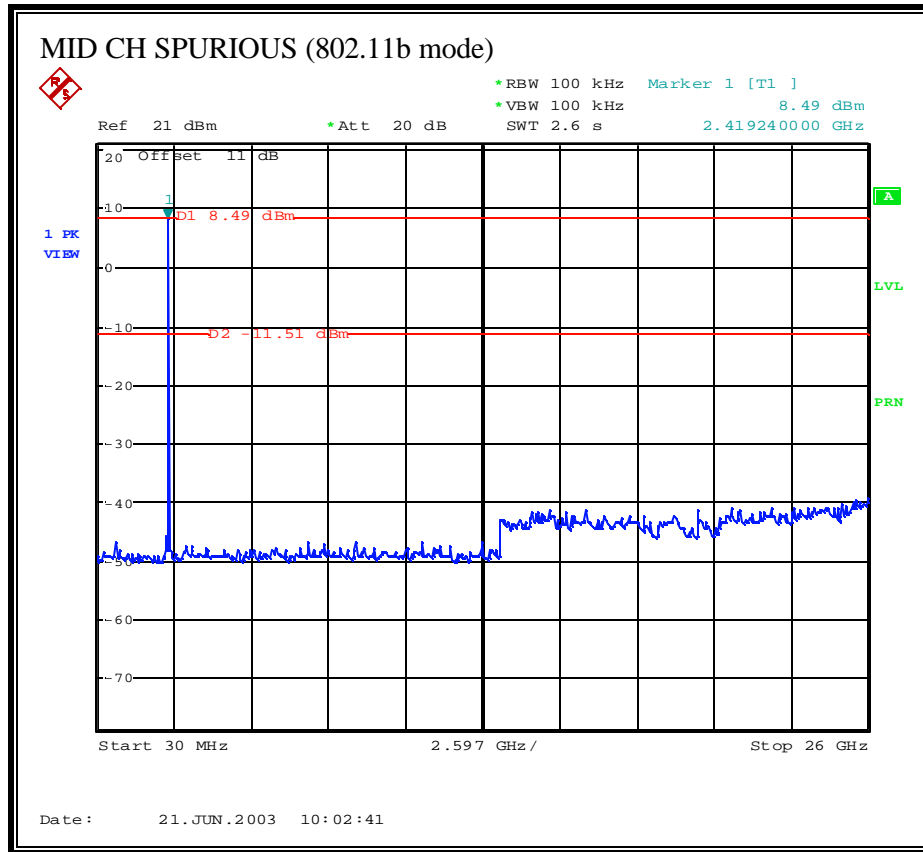

SPURIOUS EMISSIONS, HIGH CHANNEL (802.11b MODE)

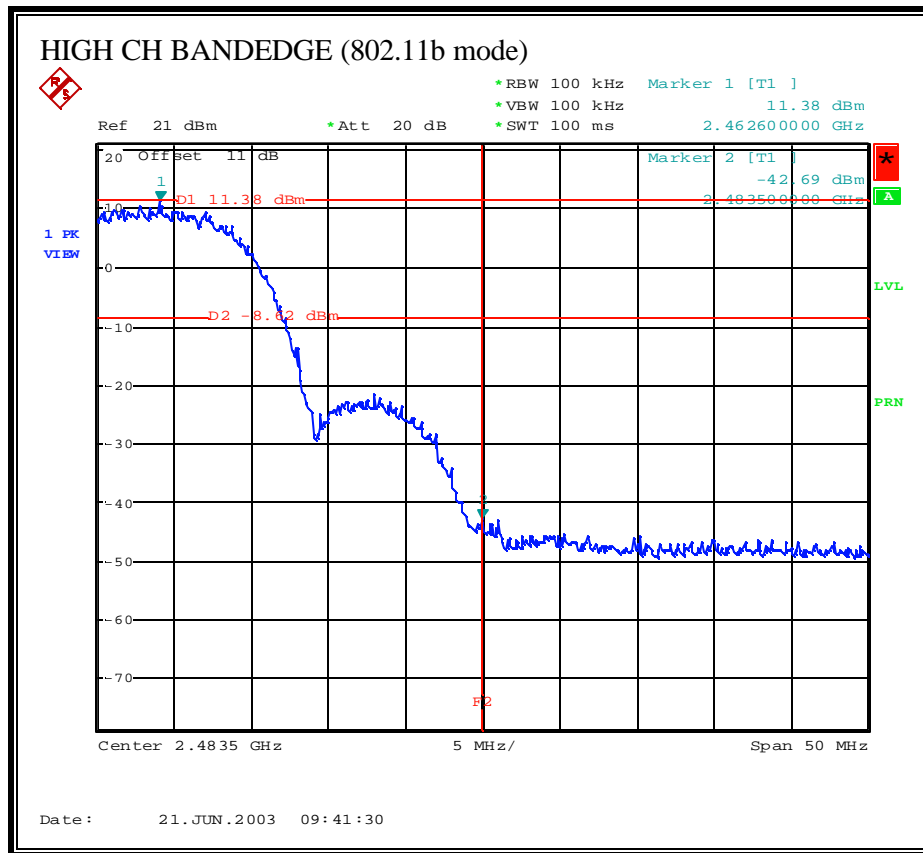

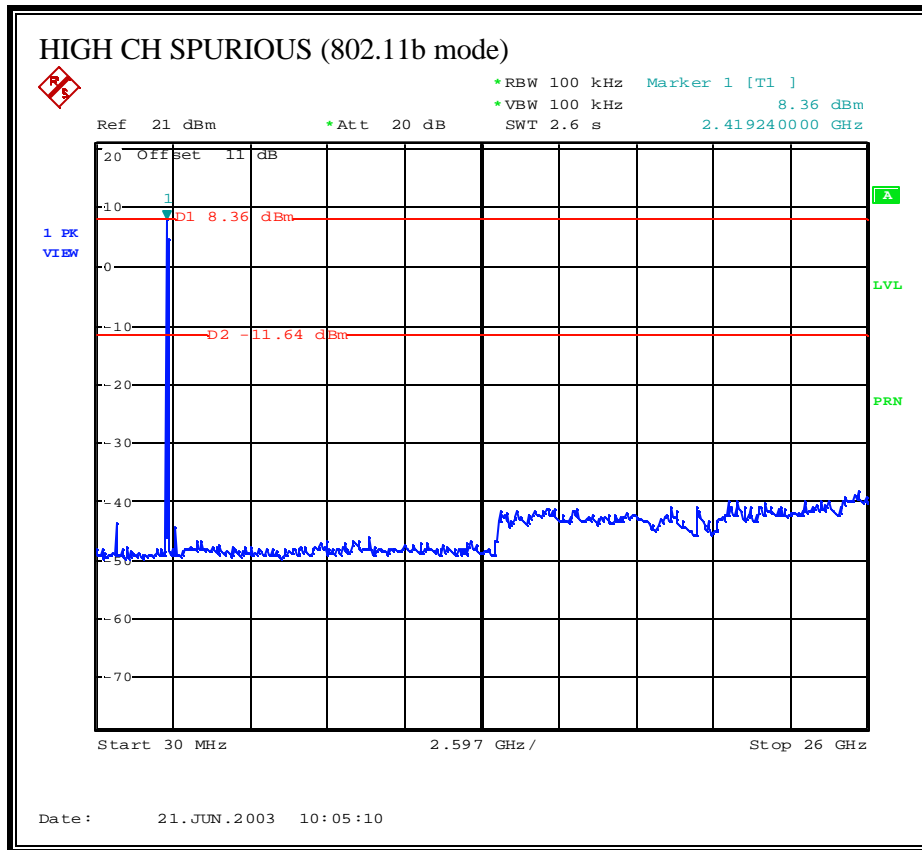

SPURIOUS EMISSIONS, LOW CHANNEL (802.11g NORMAL MODE)

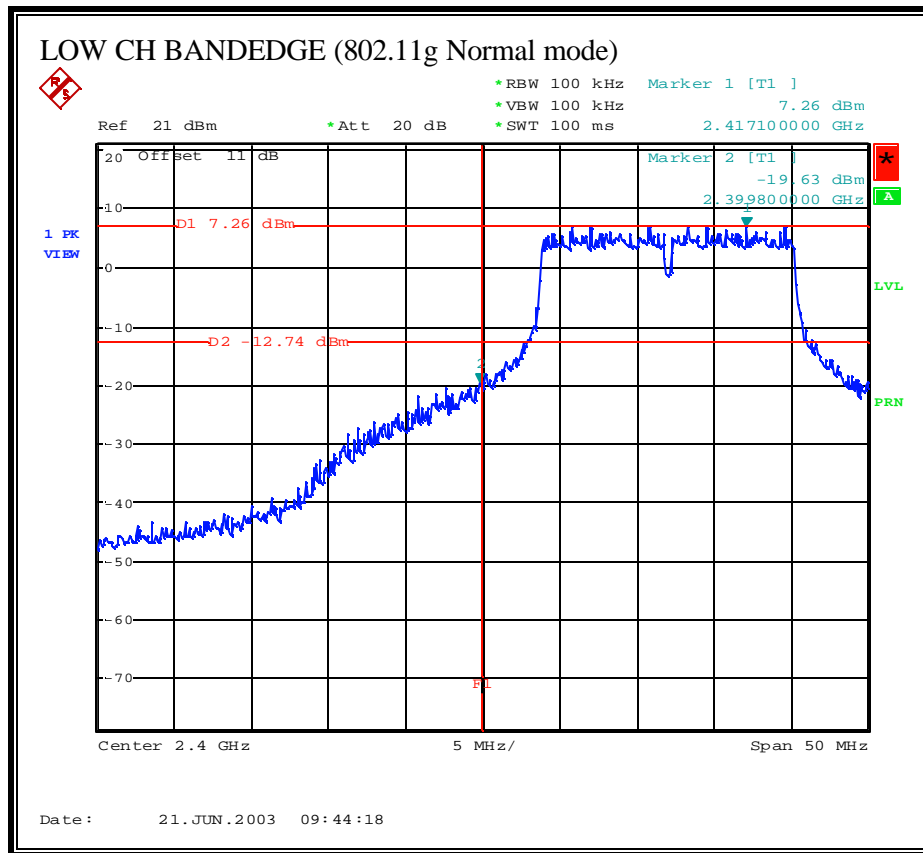

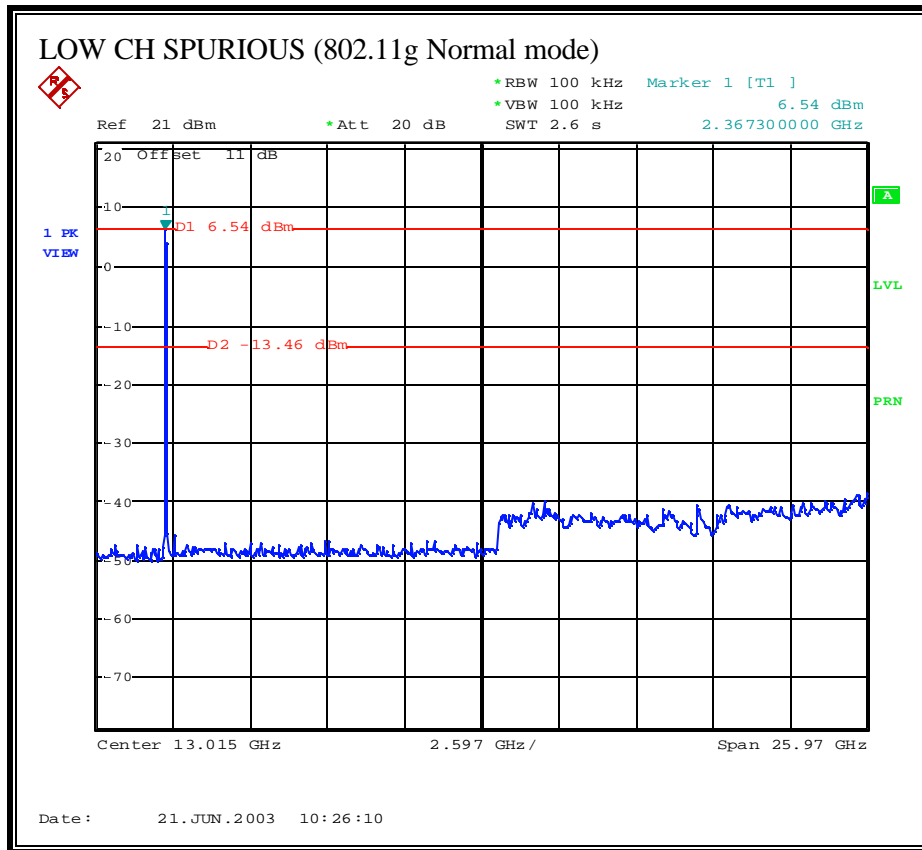

SPURIOUS EMISSIONS, MID CHANNEL (802.11g NORMAL MODE)

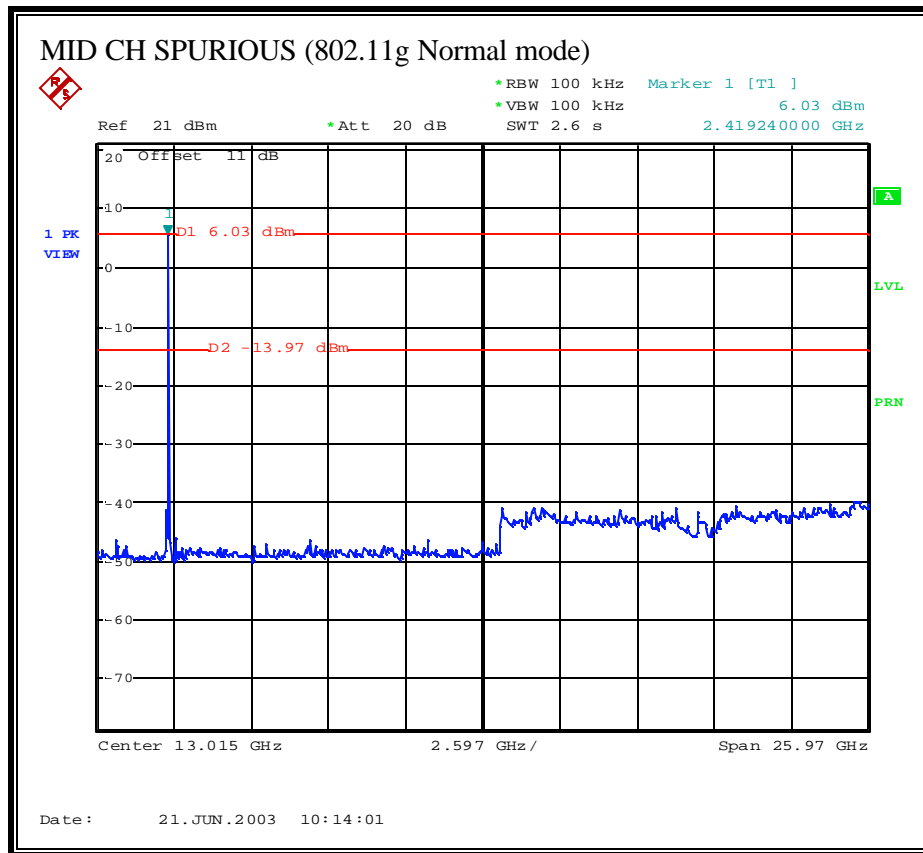

SPURIOUS EMISSIONS, HIGH CHANNEL (802.11g NORMAL MODE)

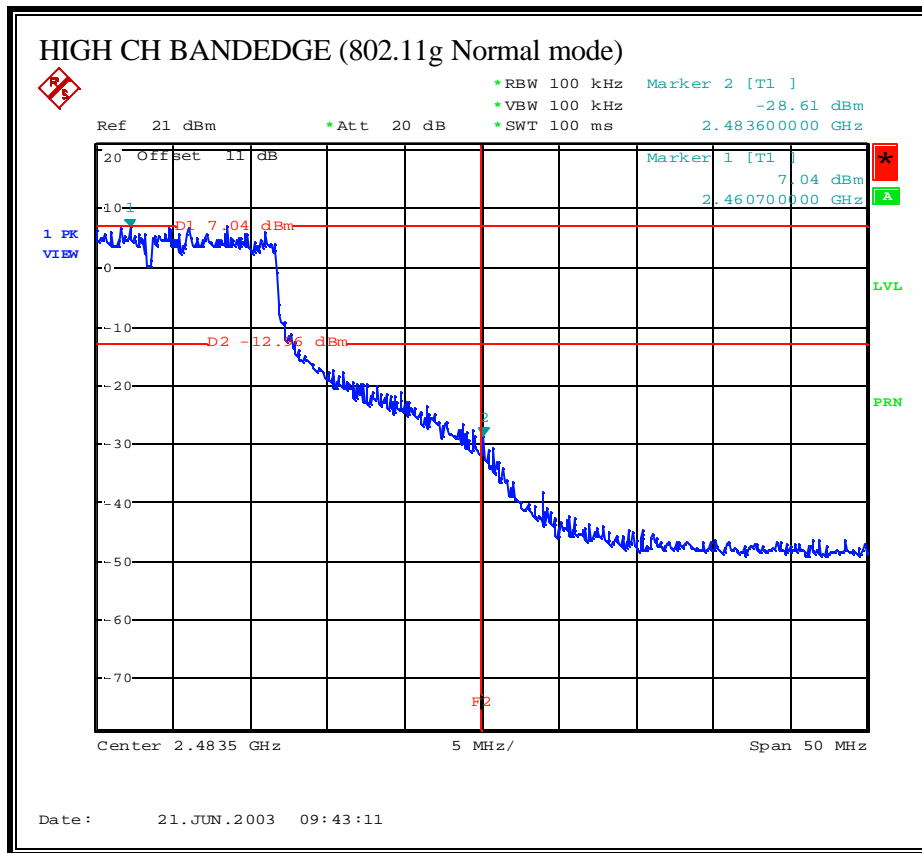

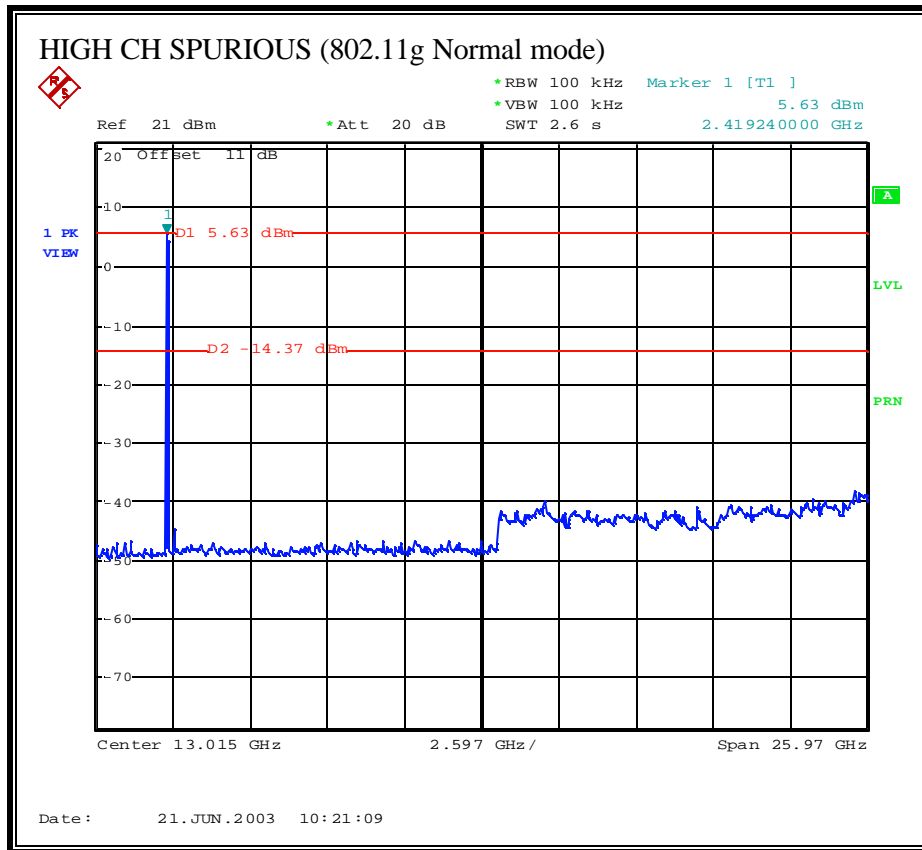

SPURIOUS EMISSIONS, MID CHANNEL (802.11g TURBO MODE)

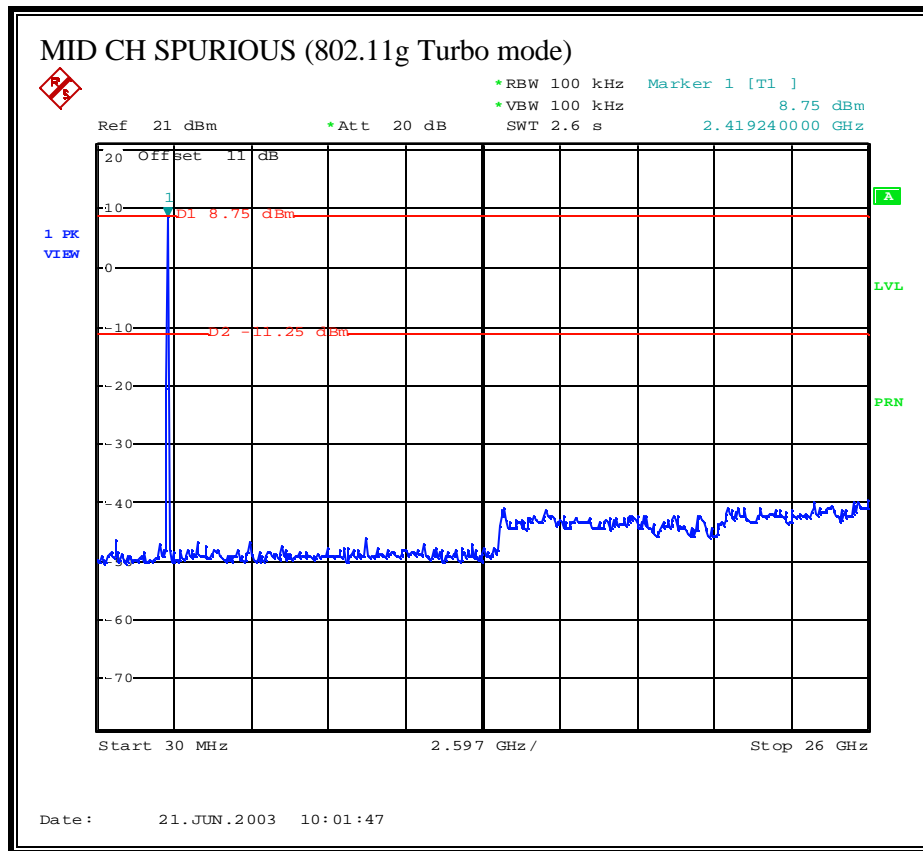

7.8. RADIATED EMISSIONS

LIMITS

§15.205 (a) Except as shown in paragraph (d) of this section, only spurious emissions are permitted in any of the frequency bands listed below:

MHz	MHz	MHz	GHz
0.090 - 0.110	16.42 - 16.423	399.9 - 410	4.5 - 5.15
¹ 0.495 - 0.505	16.69475 - 16.69525	608 - 614	5.35 - 5.46
2.1735 - 2.1905	16.80425 - 16.80475	960 - 1240	7.25 - 7.75
4.125 - 4.128	25.5 - 25.67	1300 - 1427	8.025 - 8.5
4.17725 - 4.17775	37.5 - 38.25	1435 - 1626.5	9.0 - 9.2
4.20725 - 4.20775	73 - 74.6	1645.5 - 1646.5	9.3 - 9.5
6.215 - 6.218	74.8 - 75.2	1660 - 1710	10.6 - 12.7
6.26775 - 6.26825	108 - 121.94	1718.8 - 1722.2	13.25 - 13.4
6.31175 - 6.31225	123 - 138	2200 - 2300	14.47 - 14.5
8.291 - 8.294	149.9 - 150.05	2310 - 2390	15.35 - 16.2
8.362 - 8.366	156.52475 - 156.52525	2483.5 - 2500	17.7 - 21.4
8.37625 - 8.38675	156.7 - 156.9	2655 - 2900	22.01 - 23.12
8.41425 - 8.41475	162.0125 - 167.17	3260 - 3267	23.6 - 24.0
12.29 - 12.293	167.72 - 173.2	3332 - 3339	31.2 - 31.8
12.51975 - 12.52025	240 - 285	3345.8 - 3358	36.43 - 36.5
12.57675 - 12.57725	322 - 335.4	3600 - 4400	(²)
13.36 - 13.41			

¹ Until February 1, 1999, this restricted band shall be 0.490-0.510 MHz.

² Above 38.6

§15.205 (b) Except as provided in paragraphs (d) and (e), the field strength of emissions appearing within these frequency bands shall not exceed the limits shown in Section 15.209. At frequencies equal to or less than 1000 MHz, compliance with the limits in Section 15.209 shall be demonstrated using measurement instrumentation employing a CISPR quasi-peak detector. Above 1000 MHz, compliance with the emission limits in Section 15.209 shall be demonstrated based on the average value of the measured emissions. The provisions in Section 15.35 apply to these measurements.

§15.209 (a) Except as provided elsewhere in this Subpart, the emissions from an intentional radiator shall not exceed the field strength levels specified in the following table:

Frequency (MHz)	Field Strength (microvolts/meter)	Measurement Distance (meters)
30 - 88	100 **	3
88 - 216	150 **	3
216 - 960	200 **	3
Above 960	500	3

** Except as provided in paragraph (g), fundamental emissions from intentional radiators operating under this Section shall not be located in the frequency bands 54-72 MHz, 76-88 MHz, 174-216 MHz or 470-806 MHz. However, operation within these frequency bands is permitted under other sections of this Part, e.g., Sections 15.231 and 15.241.

§15.209 (b) In the emission table above, the tighter limit applies at the band edges.

TEST PROCEDURE

The EUT is placed on a non-conducting table 80 cm above the ground plane. The antenna to EUT distance is 3 meters. The EUT is configured in accordance with ANSI C63.4. The EUT is set to transmit in a continuous mode.

For measurements below 1 GHz the resolution bandwidth is set to 100 kHz for peak detection measurements or 120 kHz for quasi-peak detection measurements. Peak detection is used unless otherwise noted as quasi-peak.

For measurements above 1 GHz the resolution bandwidth is set to 1 MHz, then the video bandwidth is set to 1 MHz for peak measurements and 10 Hz for average measurements.

The spectrum from 30 MHz to 26 GHz is investigated with the transmitter set to the lowest, middle, and highest channels.

The frequency range of interest is monitored at a fixed antenna height and EUT azimuth. The EUT is rotated through 360 degrees to maximize emissions received. The antenna is scanned from 1 to 4 meters above the ground plane to further maximize the emission. Measurements are made with the antenna polarized in both the vertical and the horizontal positions.

RESULTS

No non-compliance noted:

RESTRICTED BANDEDGE (b MODE, LOW CHANNEL, HORIZONTAL)

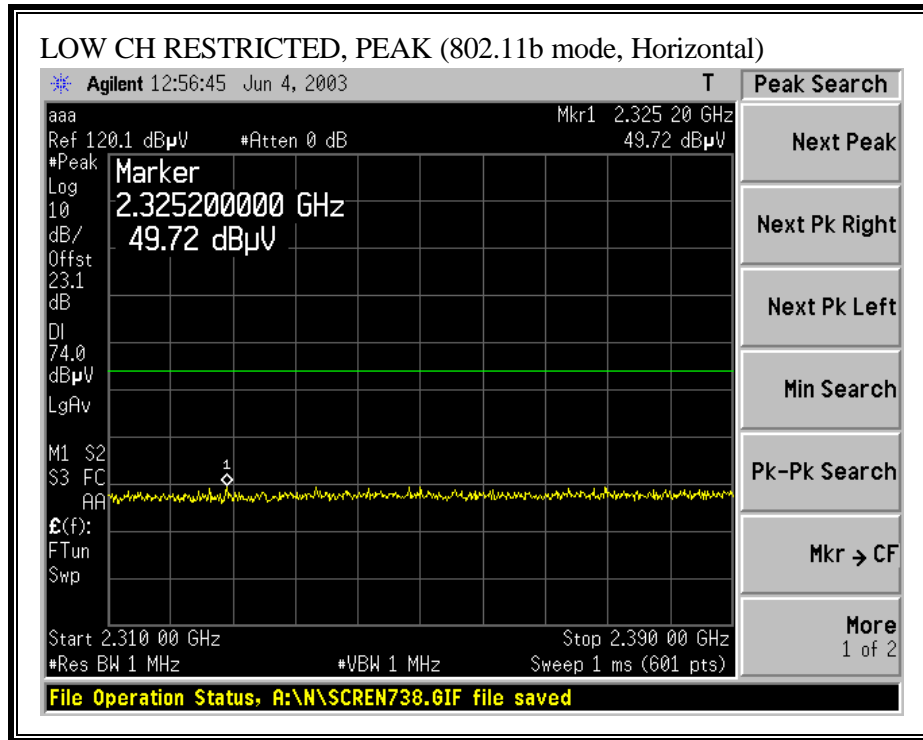

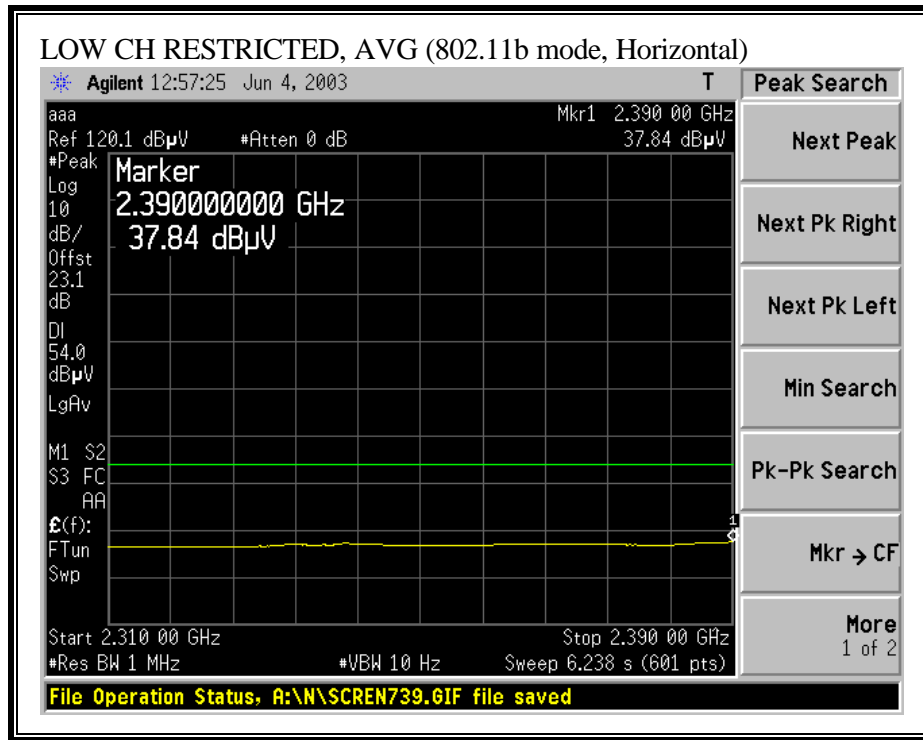

RESTRICTED BANDEDGE (b MODE, LOW CHANNEL, VERTICAL)

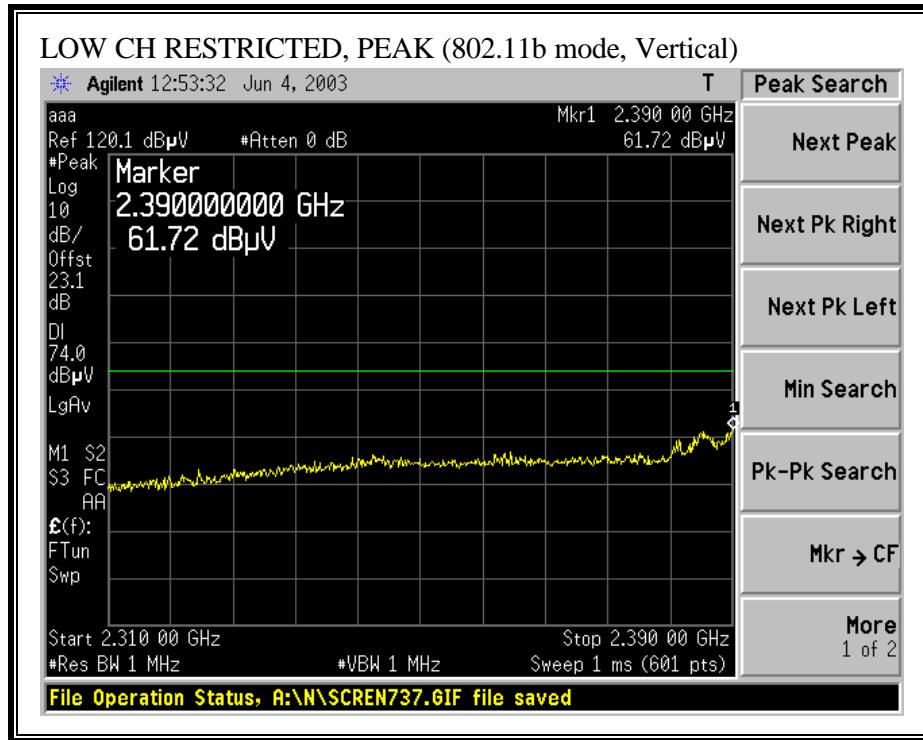

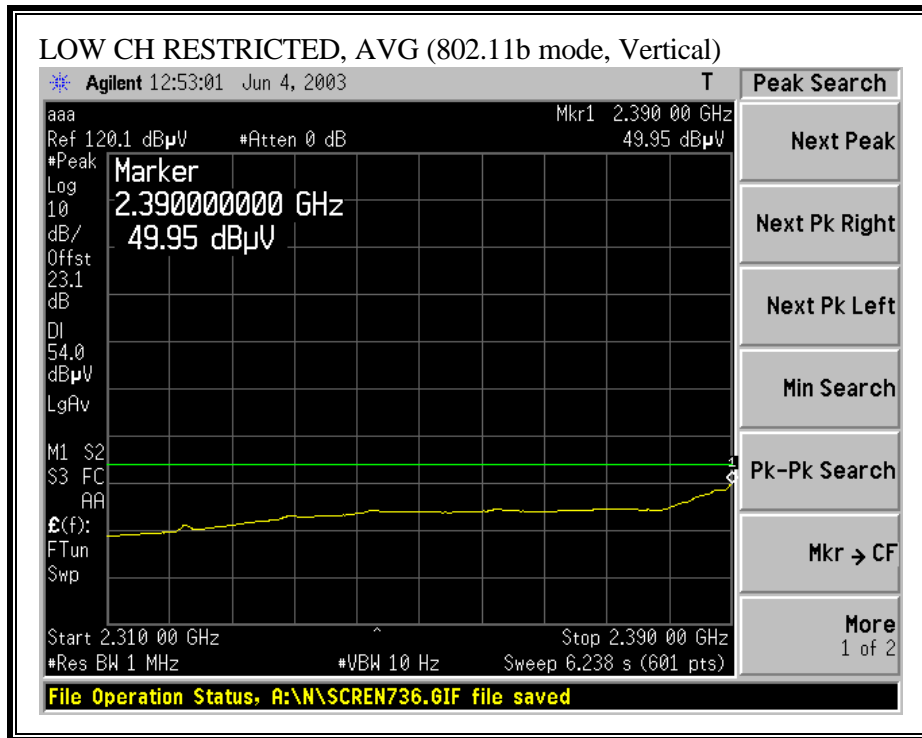

RESTRICTED BANDEDGE (b MODE, HIGH CHANNEL, HORIZONTAL)

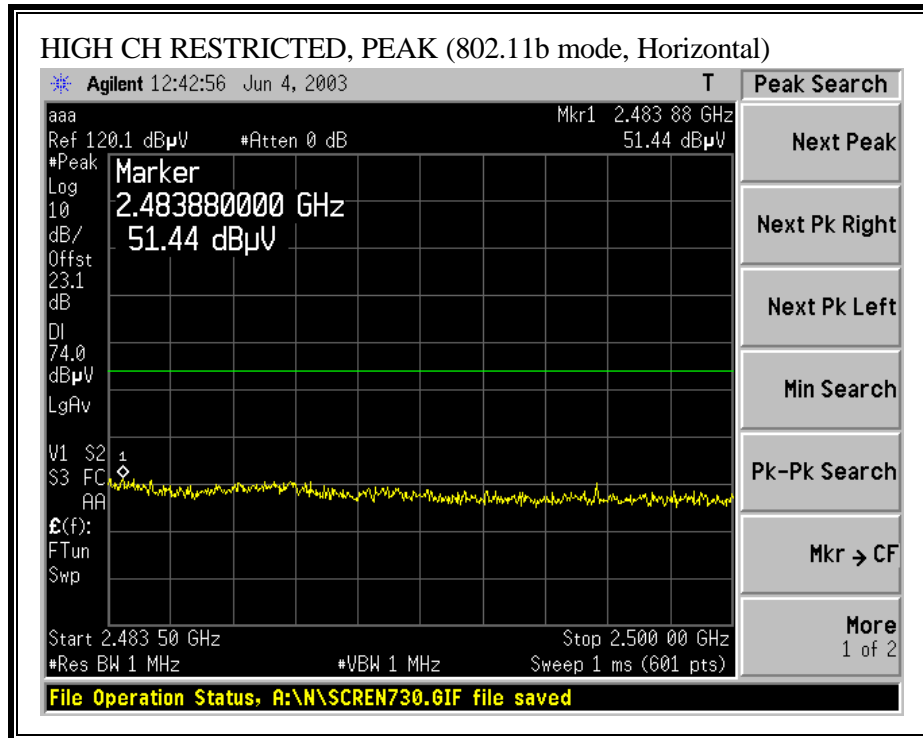

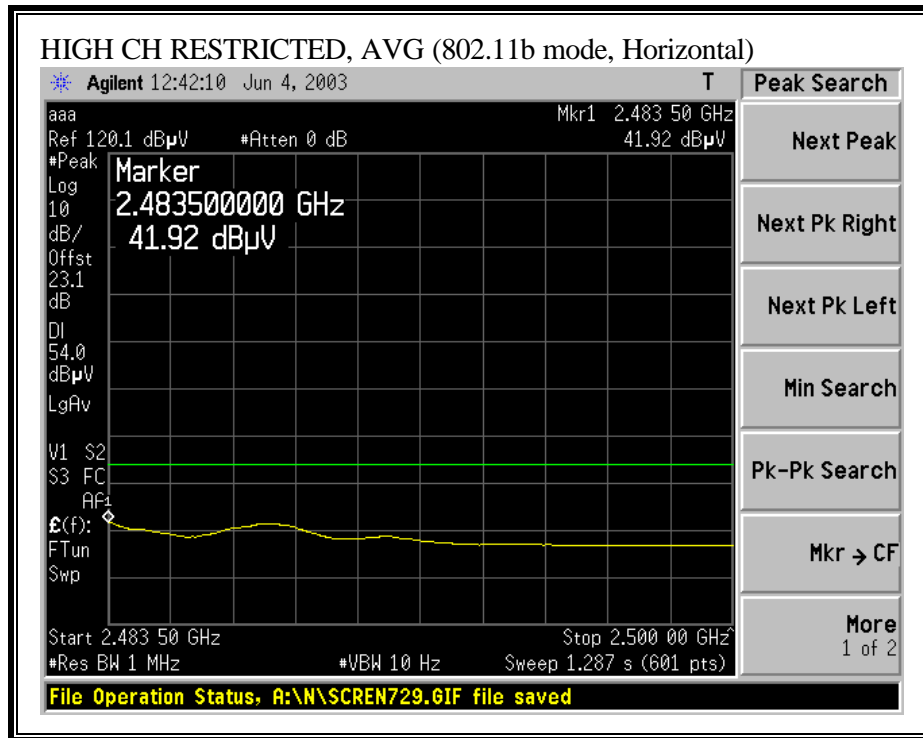

RESTRICTED BANDEDGE (b MODE, HIGH CHANNEL, VERTICAL)

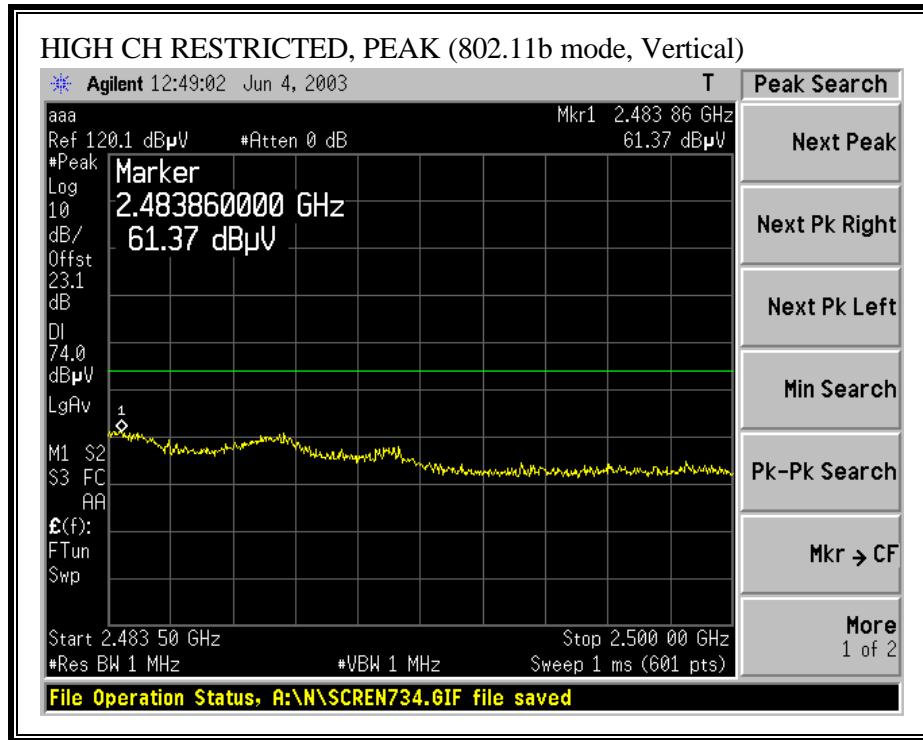

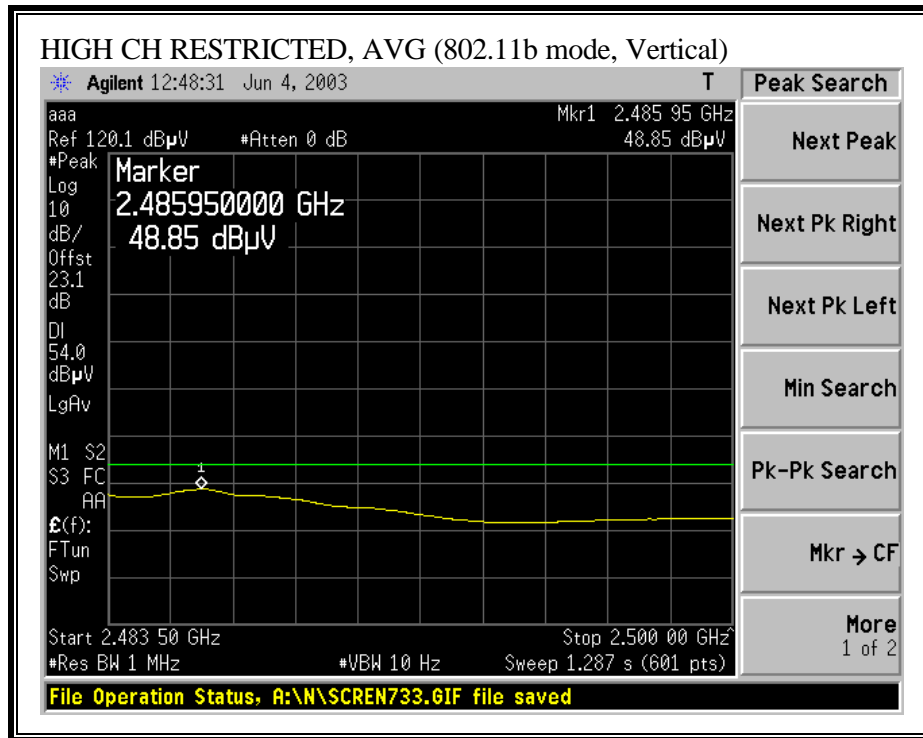

HARMONICS AND SPURIOUS EMISSIONS (b MODE, LOW CHANNEL)

06/24/03 **High Frequency Measurement**
 Compliance Certification Services, Morgan Hill Open Field Site

Test Engr: Yan Zheng
 Project #: 03U2005
 Company: Atheros
 EUT Descrip.: 802.11b,20dBm
 EUT M/N: AP30-401
 Test Target:
 Mode Oper: Transmitt

Test Equipment:

EMCO Horn, 1-18GHz
 T73; S/N: 6717 @3m

Pre-amplifier 1-26GHz
 100mVeq, 20dB

Spectrum Analyzer
 HP 8566B Analyzer

Horn > 18GHz
 T117; ARA 18-26GHz; S/N:1013

Hi Frequency Cables:
 (2 ft) (2-3 ft) (4-6 ft) (12 ft)

Peak Measurements:
 1 MHz Resolution Bandwidth
 1MHz Video Bandwidth

Average Measurements:
 1 MHz Resolution Bandwidth
 10Hz Video Bandwidth

f GHz	Dist feet	Read Pk dBuV	Read Avg. dBuV	AF dB/m	CL dB	Amp dB	D Corr dB	HPF	Peak dBuV/m	Avg dBuV/m	Pk Lim dBuV/m	Avg Lim dBuV/m	Pk Mar dB	Avg Mar dB	Notes
Channel 1 (2412MHz)															
4.824	9.8	51.2	38.8	33.4	3.7	-45.6	0.0	1.0	43.7	31.3	74.0	54.0	-30.3	-22.7	H
4.824	9.8	51.7	39.1	33.4	3.7	-45.6	0.0	1.0	44.2	31.6	74.0	54.0	-29.8	-22.4	V

f Measurement Frequency Amp Preamp Gain Avg Lim Average Field Strength Limit
 Dist Distance to Antenna D Corr Distance Correct to 3 meters Pk Lim Peak Field Strength Limit
 Read Analyzer Reading Avg Average Field Strength @ 3 m Avg Mar Margin vs. Average Limit
 AF Antenna Factor Peak Calculated Peak Field Strength Pk Mar Margin vs. Peak Limit
 CL Cable Loss HPF High Pass Filter

HARMONICS AND SPURIOUS EMISSIONS (b MODE, MID CHANNEL)

06/24/03 **High Frequency Measurement**
 Compliance Certification Services, Morgan Hill Open Field Site

Test Engr: Yan Zheng
Project #: 03U2012
Company: Atheros
EUT Descrip.: 802.11b, 20dBm
EUT M/N: AP30-401
Test Target:
Mode Oper: Transmitt

Test Equipment:

EMCO Horn 1-18GHz
 T72; S/N: 6739 @ 1m

Pre-amplifier 1-26GHz
 T87 Miteq 924342

Spectrum Analyzer
 HP 8566B Analyzer

Horn > 48GHz
 T117; ARA 18-26GHz; S/N:1013

Hi Frequency Cables
 (2 ft) (2 - 3 ft) (4 - 6 ft) (12 ft)

Peak Measurements:
 1 MHz Resolution Bandwidth
 1MHz Video Bandwidth

Average Measurements:
 1 MHz Resolution Bandwidth
 10Hz Video Bandwidth

f GHz	Dist feet	Read Pk dBuV	Read Avg. dBuV	AF dB/m	CL dB	Amp dB	D Corr dB	HPF	Peak dBuV/m	Avg dBuV/m	Pk Lim dBuV/m	Avg Lim dBuV/m	Pk Mar dB	Avg Mar dB	Notes
Channe 6 (2437MHz)															
4.874	9.8	50.0	43.1	33.9	3.8	-45.6	0.0	1.0	43.1	36.1	74.0	54.0	-30.9	-17.9	H
7.311	9.8	52.7	45.0	36.8	4.8	-46.6	0.0	1.0	48.8	41.0	74.0	54.0	-25.2	-13.0	H
7.311	9.8	57.2	52.0	36.8	4.8	-46.6	0.0	1.0	53.2	48.0	74.0	54.0	-20.8	-6.0	V
4.874	9.8	52.1	49.3	33.9	3.8	-45.6	0.0	1.0	45.1	42.4	74.0	54.0	-28.9	-11.6	V

f Measurement Frequency
 Dist Distance to Antenna
 Read Analyzer Reading
 AF Antenna Factor
 CL Cable Loss

Amp Preamp Gain
 D Corr Distance Correct to 3 meters
 Avg Average Field Strength @ 3 m
 Peak Calculated Peak Field Strength
 HPF High Pass Filter

Avg Lim Average Field Strength Limit
 Pk Lim Peak Field Strength Limit
 Avg Mar Margin vs. Average Limit
 Pk Mar Margin vs. Peak Limit

HARMONICS AND SPURIOUS EMISSIONS (b MODE, HIGH CHANNEL)

Compliance Certification Services, Morgan Hill Open Field Site

Test Engr: Yan Zheng
Project #: 03U2012
Company: Atheros
EUT Descrip.: 802.11b, 20dBm
EUT M/N: AP30-401
Test Target:
Mode Oper: Transmitt

Test Equipment:

EMCO Horn 1-18GHz Pre-amplifier 1-26GHz Spectrum Analyzer Horn > 18GHz
 T72; SN: 6739 @ 1m HP 8566B Analyzer T117; ARA 18-26GHz; SN:1013

HI Frequency Cables: (2 ft) (2 - 3 ft) (4 - 6 ft) (12 ft)

Peak Measurements: 1 MHz Resolution Bandwidth
 1MHz Video Bandwidth

Average Measurements: 1 MHz Resolution Bandwidth
 10Hz Video Bandwidth

f GHz	Dist feet	Read Pk dBuV	Read Avg. dBuV	AF dB/m	CL dB	Amp dB	D Corr dB	HPF	Peak dBuV/m	Avg dBuV/m	Pk Lim dBuV/m	Avg Lim dBuV/m	Pk Mar dB	Avg Mar dB	Notes
Channe 11 (2462MHz)															
4924	9.8	51.1	38.8	34.1	3.8	-44.8	0.0	1.0	45.2	32.9	74.0	54.0	-28.8	-21.1	H
7386	9.8	51.9	39.1	37.1	4.9	-44.5	0.0	1.0	50.4	37.6	74.0	54.0	-23.6	-16.4	H
7386	9.8	51.8	39.1	37.1	4.9	-44.5	0.0	1.0	50.3	37.6	74.0	54.0	-23.7	-16.4	V
4924	9.8	51.5	38.5	34.1	3.8	-44.8	0.0	1.0	45.6	32.6	74.0	54.0	-28.4	-21.4	V

f Measurement Frequency Amp Preamp Gain Avg Lim Average Field Strength Limit
 Dist Distance to Antenna D Corr Distance Correct to 3 meters Pk Lim Peak Field Strength Limit
 Read Analyzer Reading Avg Average Field Strength @ 3 m Avg Mar Margin vs. Average Limit
 AF Antenna Factor Peak Calculated Peak Field Strength Pk Mar Margin vs. Peak Limit
 CL Cable Loss HPF High Pass Filter

RESTRICTED BANDEDGE (g MODE, LOW CHANNEL, HORIZONTAL)

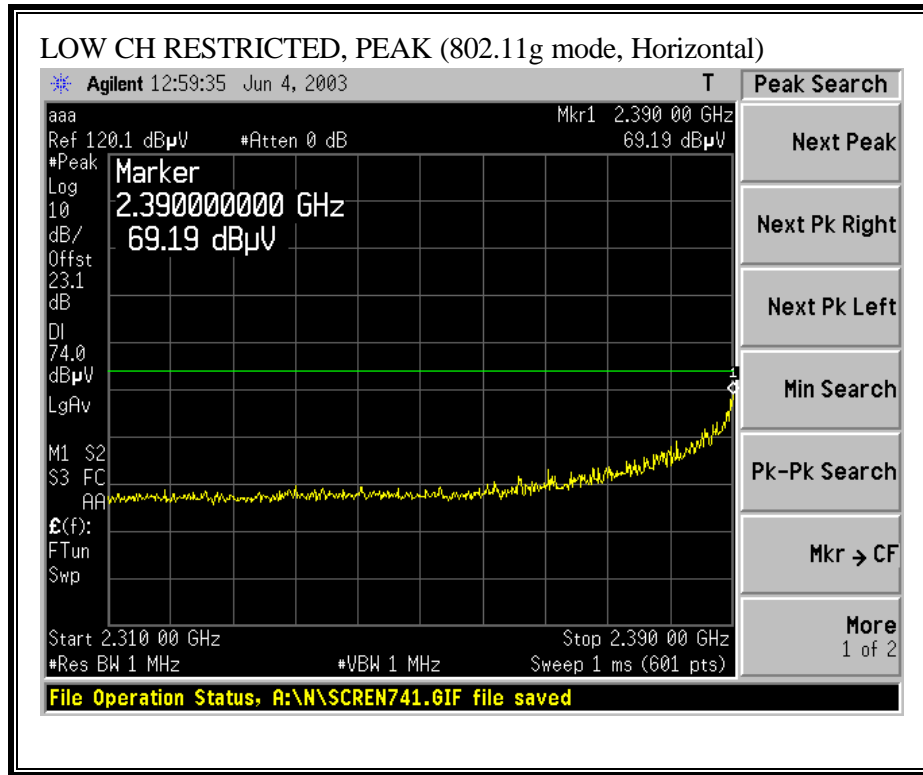

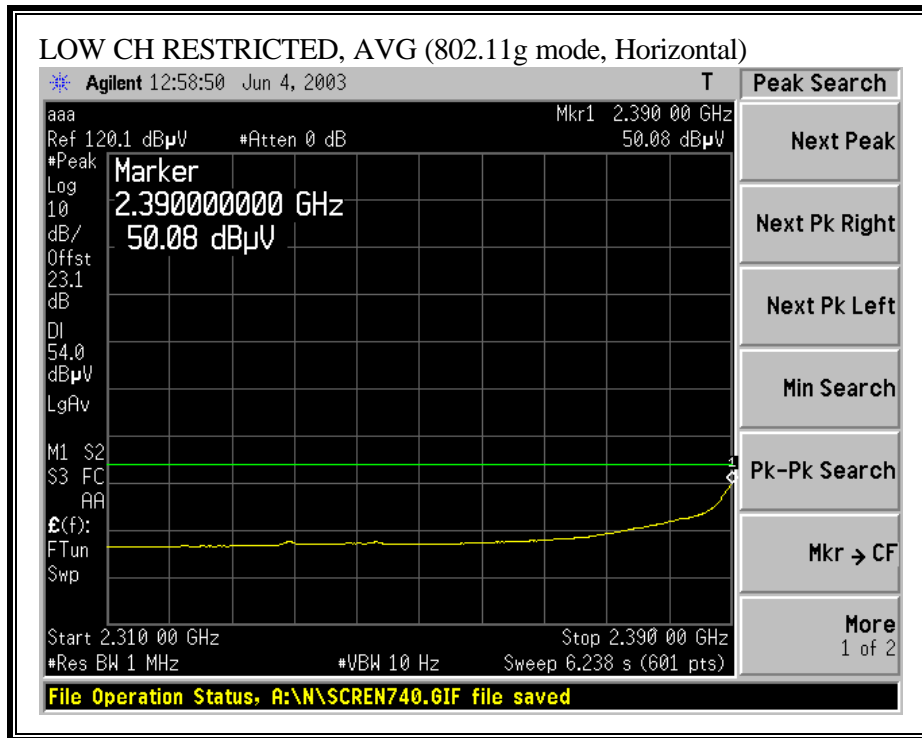

RESTRICTED BANDEDGE (g MODE, LOW CHANNEL, VERTICAL)

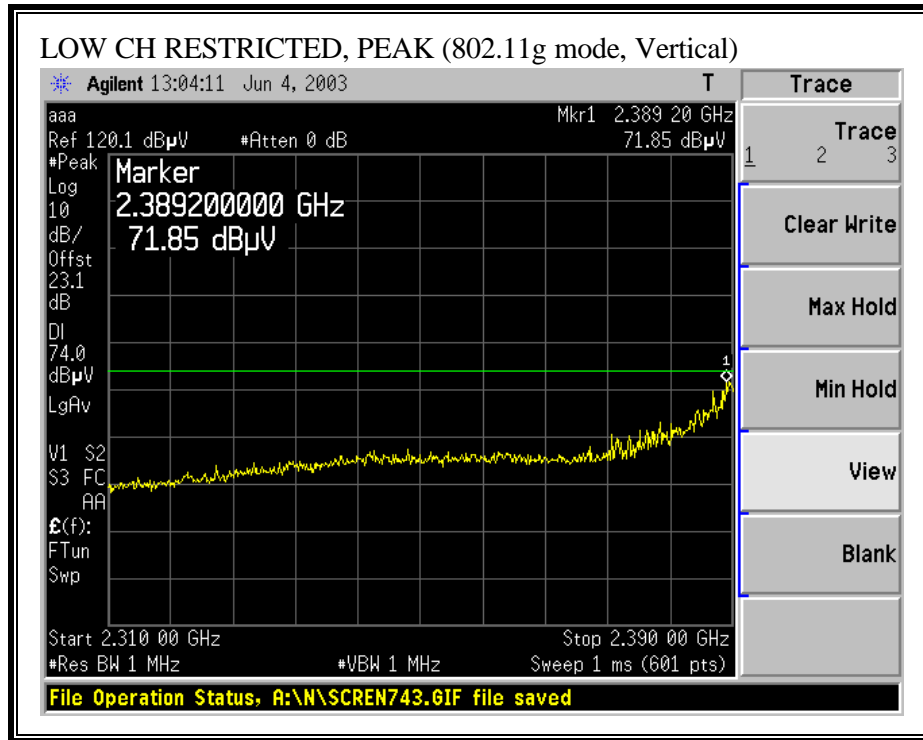

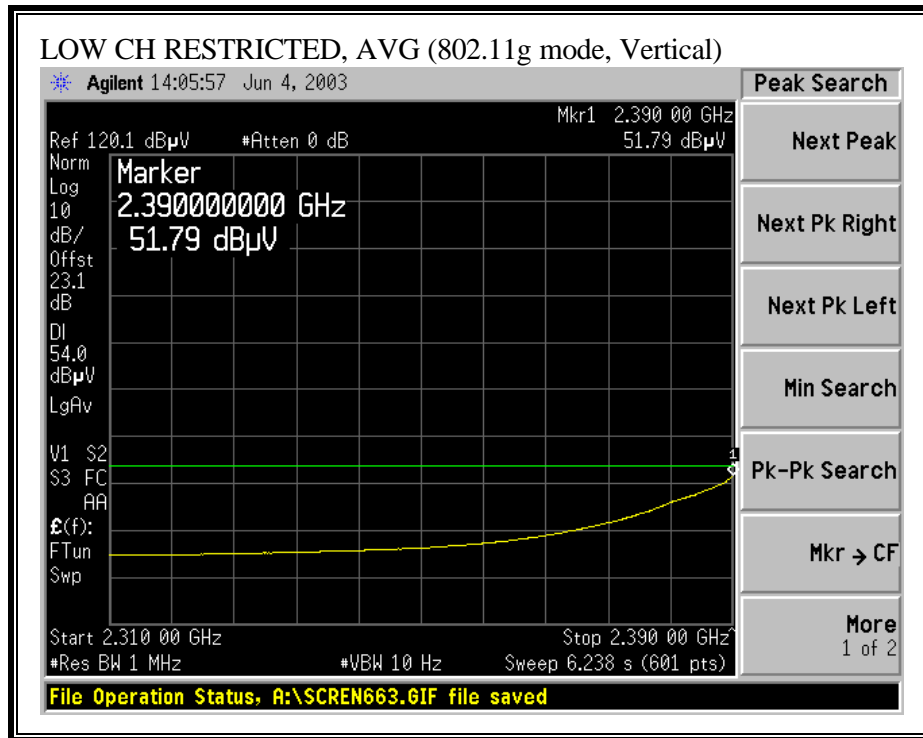

RESTRICTED BANDEDGE (g MODE, HIGH CHANNEL, HORIZONTAL)

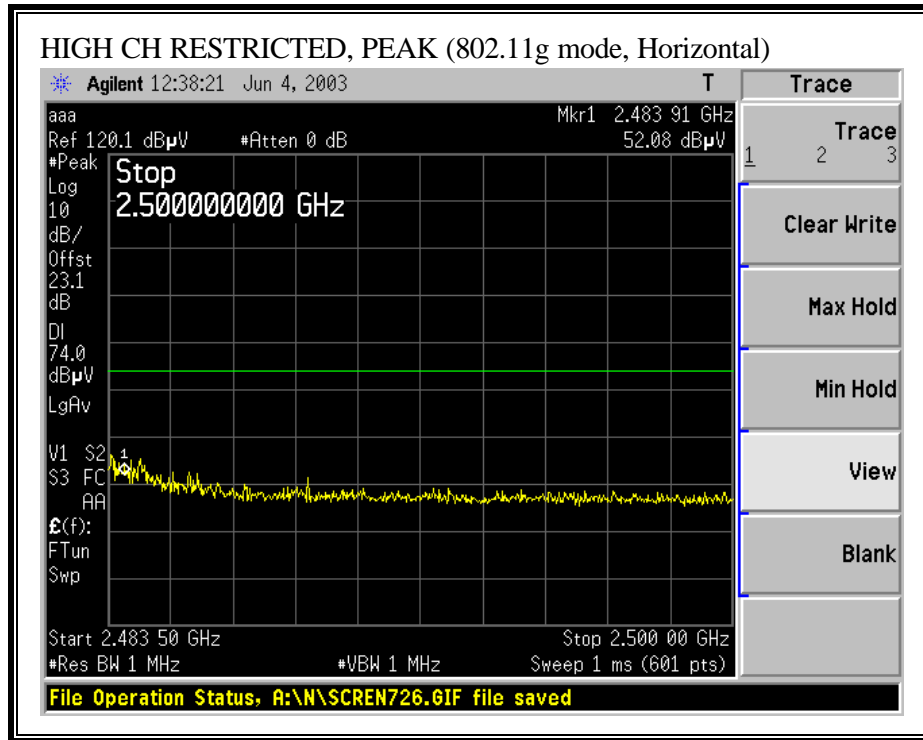

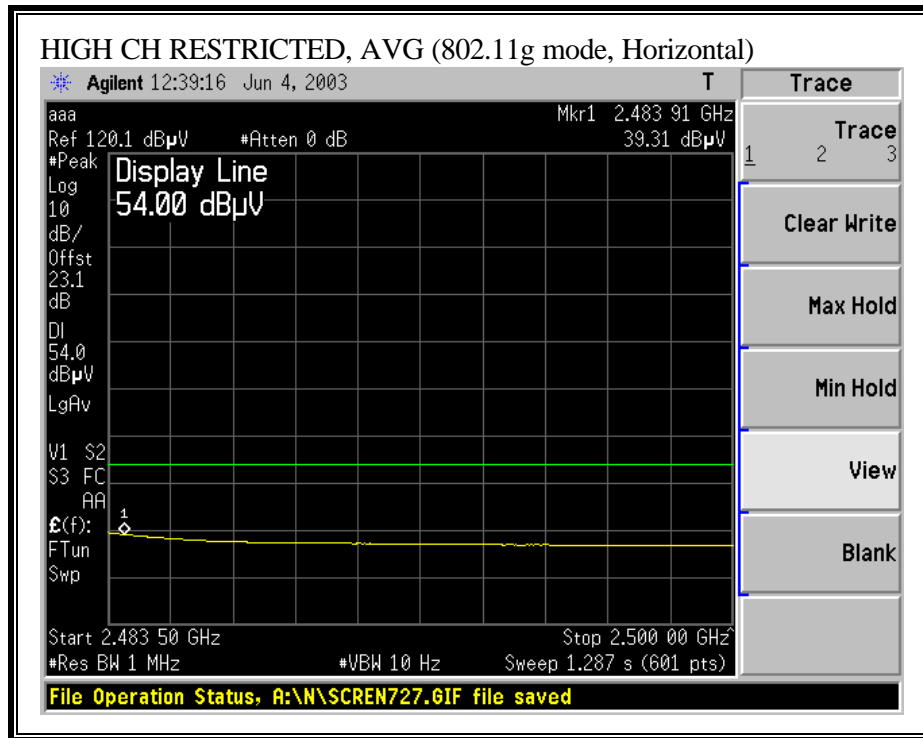

RESTRICTED BANDEDGE (g MODE, HIGH CHANNEL, VERTICAL)

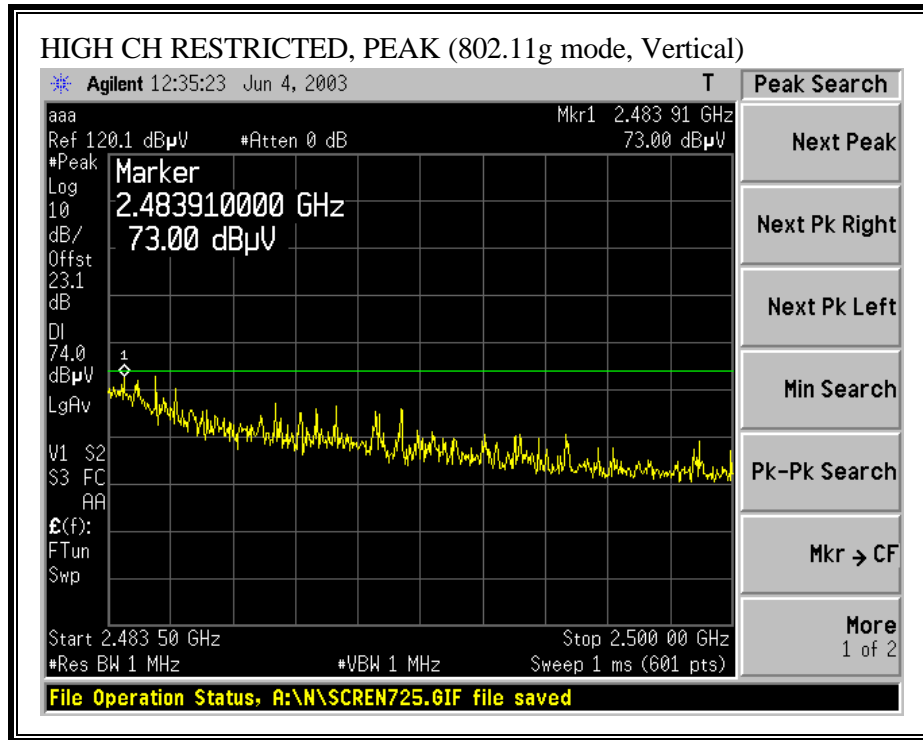

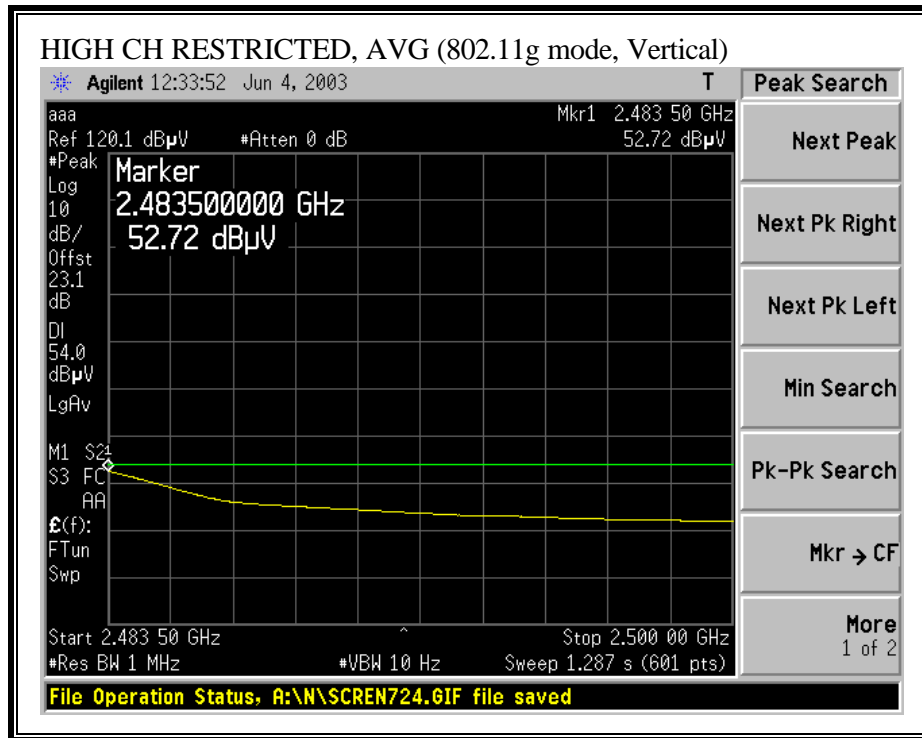

HARMONICS AND SPURIOUS EMISSIONS (g NORMAL MODE, LOW CHANNEL)

06/24/03 **High Frequency Measurement**
 Compliance Certification Services, Morgan Hill Open Field Site

Test Engr: Yan Zheng
Project #: 03U2005
Company: Atheros
EUT Descrip.: 802.11g, Dac=42
EUT M/N: TB74-105
Test Target:
Mode Oper: Transmitt

Test Equipment:

EMCO Horn, 1-18GHz T72; S/N: 6739 @ 1m	Pre-amplifier 1-26GHz for miteq sz49z	Spectrum Analyzer HP 8566B Analyzer	Horn > 18GHz T117; ARA 18-26GHz; S/N:1013
---	--	--	--

Hi Frequency Cables: (2 ft) (2-3 ft) (4-6 ft) (12 ft)

Peak Measurements:
 1 MHz Resolution Bandwidth
 1MHz Video Bandwidth

Average Measurements:
 1 MHz Resolution Bandwidth
 10Hz Video Bandwidth

f	Dist	Read Pk	Read Avg.	AF	CL	Amp	D Corr	HPF	Peak	Avg	Pk Lim	Avg Lim	Pk Mar	Avg Mar	Notes
GHz	feet	dBuV	dBuV	dB/m	dB	dB	dB		dBuV/m	dBuV/m	dBuV/m	dBuV/m	dB	dB	
Channel 1 (2412MHz)															
4.824	9.8	51.7	39.1	34.0	3.7	-44.7	0.0	1.0	45.8	33.2	74.0	54.0	-28.2	-20.8	H
4.824	9.8	51.3	39.1	34.0	3.7	-44.7	0.0	1.0	45.4	33.2	74.0	54.0	-28.6	-20.8	V

f	Measurement Frequency	Amp	Preamp Gain	Avg Lim	Average Field Strength Limit
Dist	Distance to Antenna	D Corr	Distance Correct to 3 meters	Pk Lim	Peak Field Strength Limit
Read	Analyzer Reading	Avg	Average Field Strength @ 3 m	Avg Mar	Margin vs. Average Limit
AF	Antenna Factor	Peak	Calculated Peak Field Strength	Pk Mar	Margin vs. Peak Limit
CL	Cable Loss	HPF	High Pass Filter		

HARMONICS AND SPURIOUS EMISSIONS (g NORMAL MODE, MID CHANNEL)

06/24/03 **High Frequency Measurement**
 Compliance Certification Services, Morgan Hill Open Field Site

Test Engr: Yan Zheng
Project #: 03U2012
Company: Atheros
EUT Descrip.: 802.11g, 20dBm
EUT M/N: AP30-401
Test Target:
Mode Oper: Transmitt

Test Equipment:

EMCO Horn, 1-18GHz T73; S/N: 6717 @3m	Pre-amplifier 1-26GHz 100 miteq sz404	Spectrum Analyzer HP 8566B Analyzer	Horn > 18GHz T117; ARA 18-26GHz; S/N:1013
---	---	---	--

Hi Frequency Cables: (2 ft) (2-3 ft) (4-6 ft) (12ft)

Peak Measurements: 1 MHz Resolution Bandwidth
1MHz Video Bandwidth

Average Measurements: 1 MHz Resolution Bandwidth
10Hz Video Bandwidth

f GHz	Dist feet	Read Pk dBuV	Read Avg. dBuV	AF dB/m	CL dB	Amp dB	D Corr dB	HPF	Peak dBuV/m	Avg dBuV/m	Pk Lim dBuV/m	Avg Lim dBuV/m	Pk Mar dB	Avg Mar dB	Notes
Channel (2437MHz)															
4874	9.8	52.2	39.4	33.4	3.8	-45.6	0.0	1.0	44.7	31.9	74.0	54.0	-29.3	-22.1	V
7.311	9.8	52.5	39.7	35.8	4.8	-46.6	0.0	1.0	47.5	34.7	74.0	54.0	-26.5	-19.3	V
7.311	9.8	52.5	40.7	35.8	4.8	-46.6	0.0	1.0	47.5	35.7	74.0	54.0	-26.5	-18.3	H
4874	9.8	53.5	39.9	33.4	3.8	-45.6	0.0	1.0	46.0	32.4	74.0	54.0	-28.0	-21.6	H
								1.0							

f	Measurement Frequency	Amp	Preamp Gain	Avg Lim	Average Field Strength Limit
Dist	Distance to Antenna	D Corr	Distance Correct to 3 meters	Pk Lim	Peak Field Strength Limit
Read	Analyzer Reading	Avg	Average Field Strength @ 3 m	Avg Mar	Margin vs. Average Limit
AF	Antenna Factor	Peak	Calculated Peak Field Strength	Pk Mar	Margin vs. Peak Limit
CL	Cable Loss	HPF	High Pass Filter		

HARMONICS AND SPURIOUS EMISSIONS (g NORMAL MODE, HIGH CHANNEL)

06/24/03 **High Frequency Measurement**
 Compliance Certification Services, Morgan Hill Open Field Site

Test Engr: Yan Zheng
Project #: 03U2012
Company: Atheros
EUT Descrip.: 802.11g, 17dBm
EUT M/N: AP30-401
Test Target:
Mode Oper: Transmitt

Test Equipment:

EMCO Horn, 1-18GHz T72; S/N: 6739 @ 1m	Pre-amplifier 1-26GHz T07; S/N: 6739 @ 1m	Spectrum Analyzer HP 8566B Analyzer	Horn > 18GHz T117; ARA 18-26GHz; S/N:1013
---	--	--	--

Hi Frequency Cables: (2 ft) (2-3 ft) (4-6 ft) (12 ft)

Peak Measurements:
 1 MHz Resolution Bandwidth
 1MHz Video Bandwidth

Average Measurements:
 1 MHz Resolution Bandwidth
 10Hz Video Bandwidth

f GHz	Dist feet	Read Pk dBuV	Read Avg. dBuV	AF dB/m	CL dB	Amp dB	D Corr dB	HPF	Peak dBuV/m	Avg dBuV/m	Pk Lim dBuV/m	Avg Lim dBuV/m	Pk Mar dB	Avg Mar dB	Notes
Channe 11 (2462MHz)															
4924	9.8	50.8	38.6	34.1	3.8	-44.8	0.0	1.0	44.9	32.7	74.0	54.0	-29.1	-21.3	H
7386	9.8	54.6	41.1	37.1	4.9	-44.5	0.0	1.0	53.1	39.6	74.0	54.0	-20.9	-14.4	H
7386	9.8	65.6	45.6	37.1	4.9	-44.5	0.0	1.0	64.1	44.1	74.0	54.0	-9.9	-9.9	V
4924	9.8	51.5	38.3	34.1	3.8	-44.8	0.0	1.0	45.6	32.4	74.0	54.0	-28.4	-21.6	V

f	Measurement Frequency	Amp	Preamp Gain	Avg Lim	Average Field Strength Limit
Dist	Distance to Antenna	D Corr	Distance Correct to 3 meters	Pk Lim	Peak Field Strength Limit
Read	Analyzer Reading	Avg	Average Field Strength @ 3 m	Avg Mar	Margin vs. Average Limit
AF	Antenna Factor	Peak	Calculated Peak Field Strength	Pk Mar	Margin vs. Peak Limit
CL	Cable Loss	HPF	High Pass Filter		

LOW RESTRICTED BANDEDGE (g TURBO MODE, HORIZONTAL)

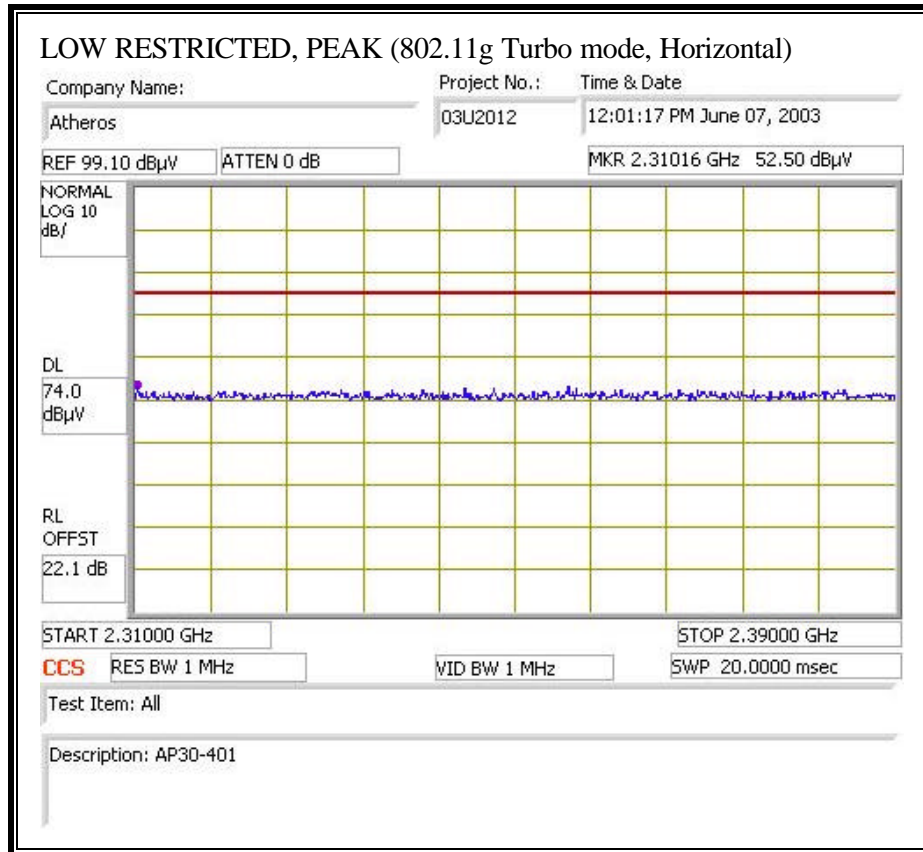

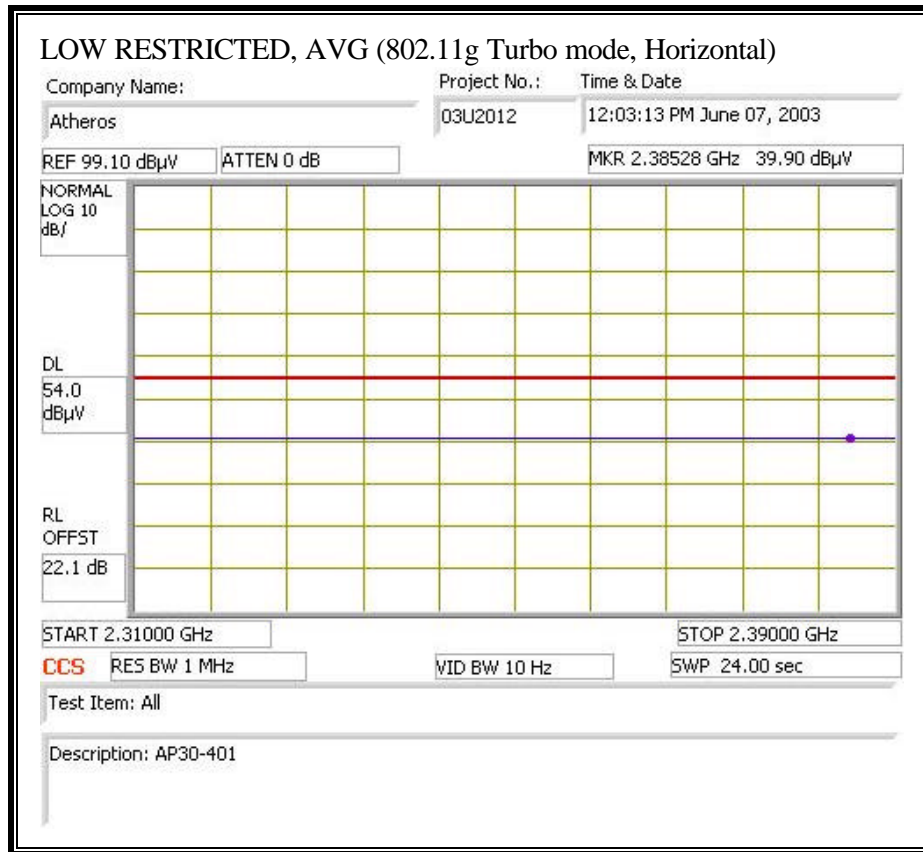

LOW RESTRICTED BANDEDGE (g TURBO MODE, VERTICAL)

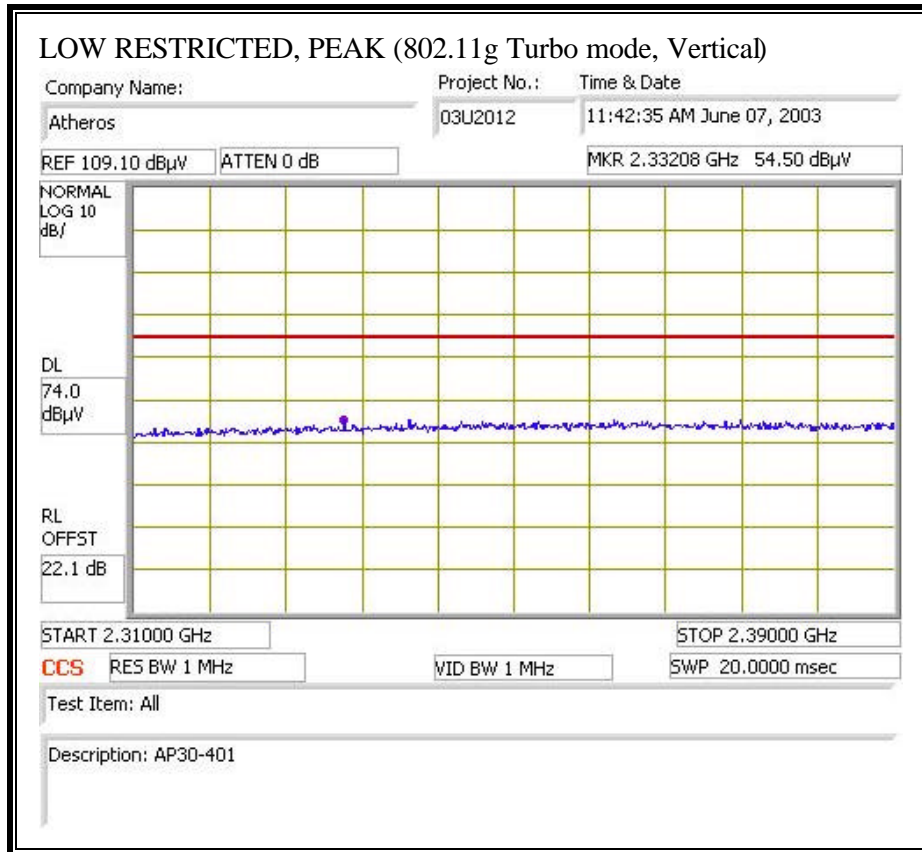

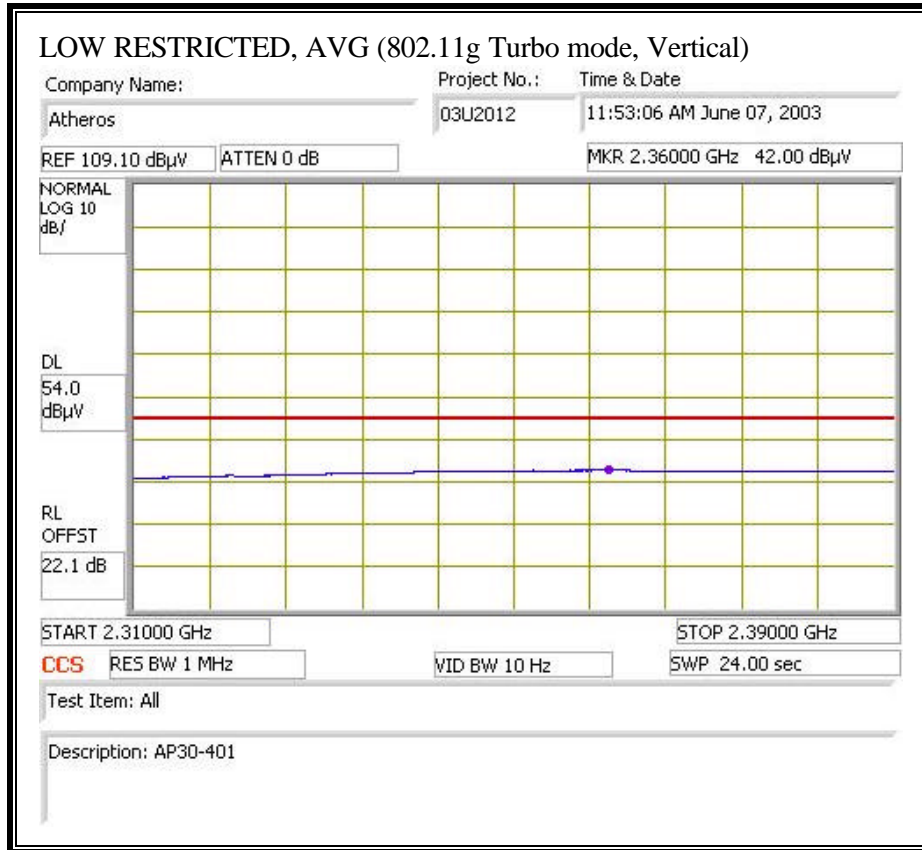

HIGH RESTRICTED BANDEDGE (g TURBO MODE, HORIZONTAL)

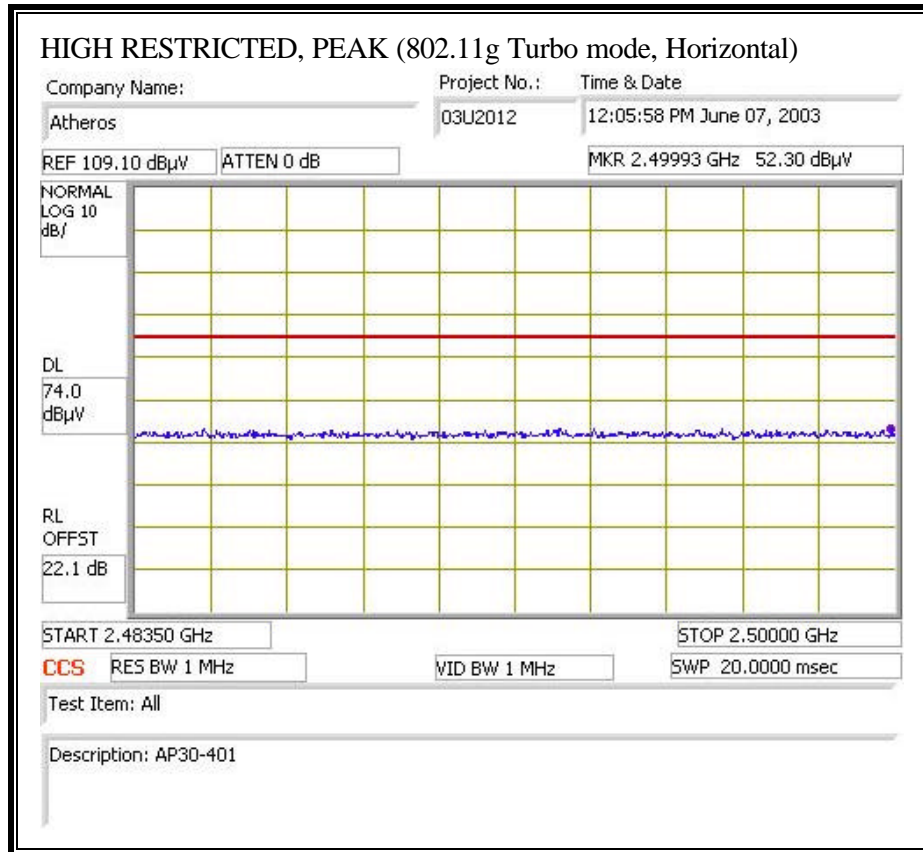

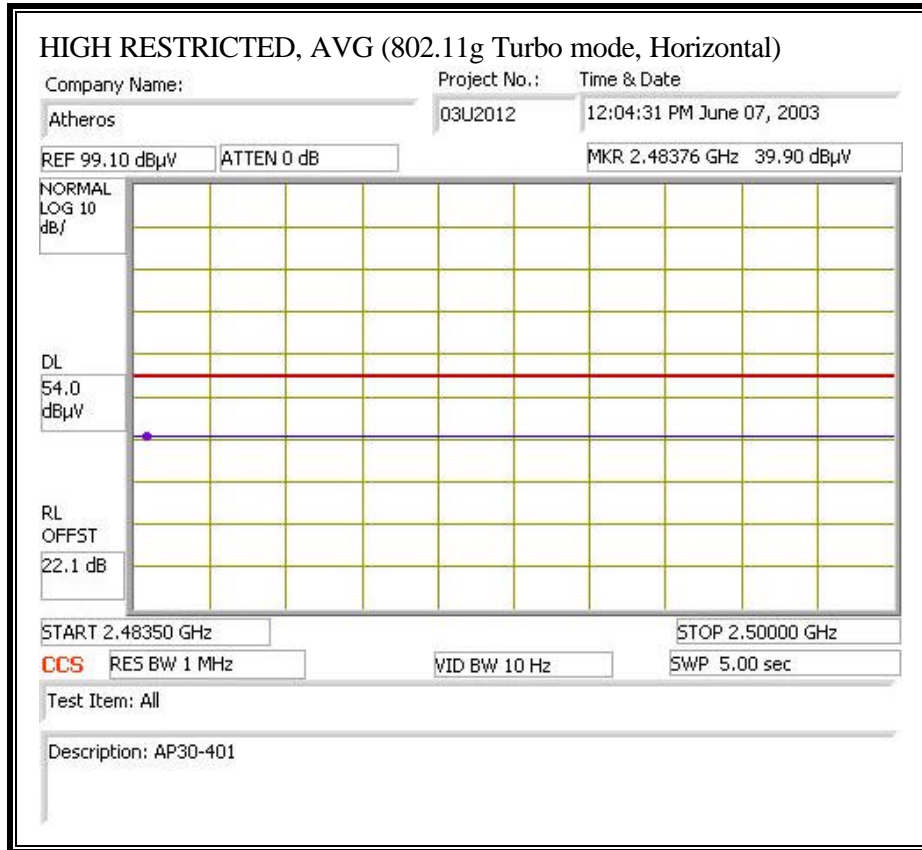

RESTRICTED BANDEDGE (g TURBO MODE, VERTICAL)

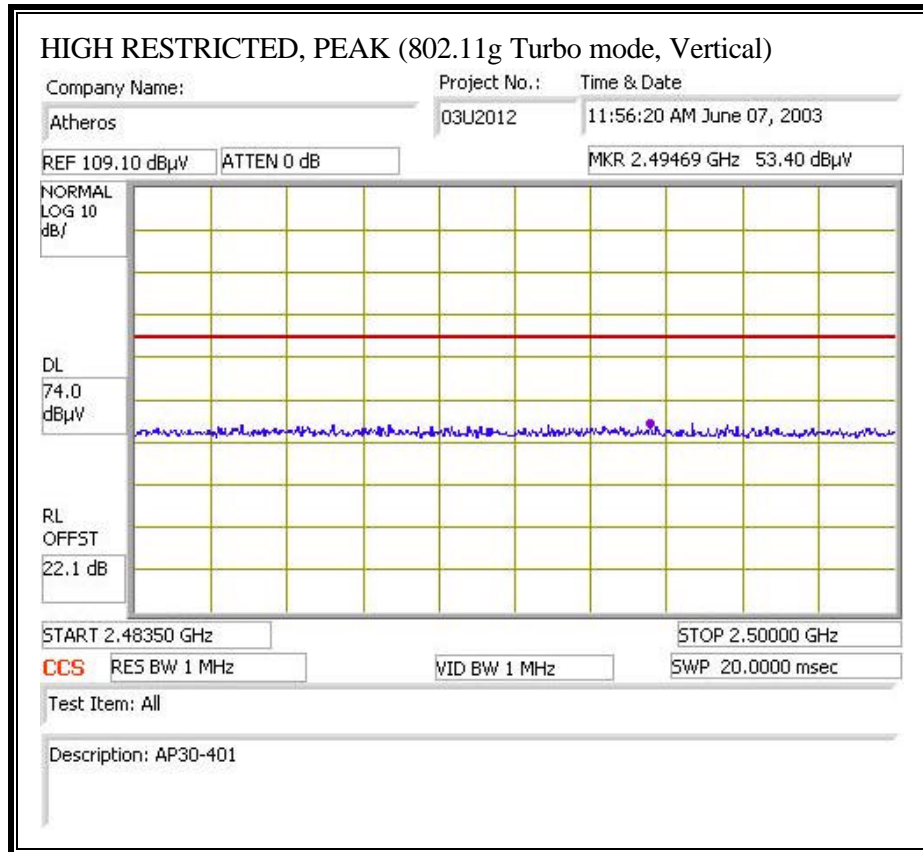

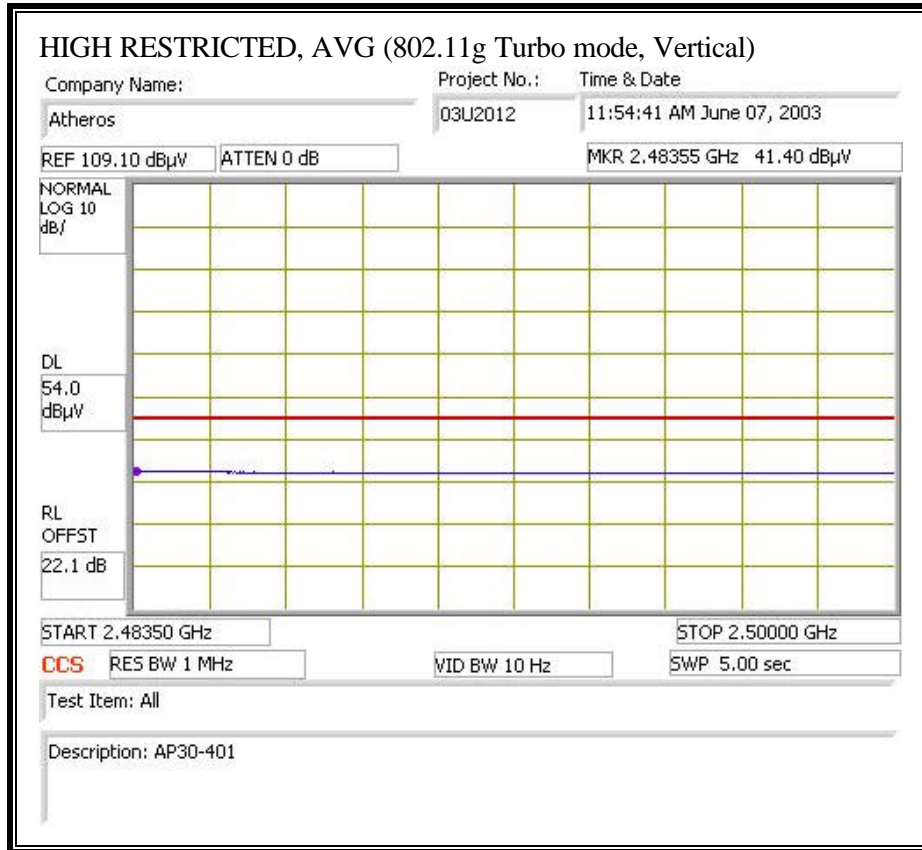

HARMONICS AND SPURIOUS EMISSIONS (g TURBO MODE)

06/24/03 **High Frequency Measurement**
 Compliance Certification Services, Morgan Hill Open Field Site

Test Engr: Yan Zheng
Project #: 03U2012
Company: Atheros
EUT Descrip.: 802.11g, turbo, 20dBm
EUT M/N: AP30-401
Test Target:
Mode Oper: Transmitt

Test Equipment:

EMCO Horn 1-18GHz T73; S/N: 6717 @3m	Pre-amplifier 1-26GHz 100 Witeq 524041	Spectrum Analyzer HP 8566B Analyzer	Horn > 18GHz T117; ARA 18-26GHz; S/N:1013
---	---	--	--

Hi Frequency Cables:
 (2 ft) (2 ~ 3 ft) (4 ~ 6 ft) (12 ft)

Peak Measurements:
 1 MHz Resolution Bandwidth
 1MHz Video Bandwidth

Average Measurements:
 1 MHz Resolution Bandwidth
 10Hz Video Bandwidth

f GHz	Dist feet	Read Pk dBuV	Read Avg. dBuV	AF dB/m	CL dB	Amp dB	D Corr dB	HPF	Peak dBuV/m	Avg dBuV/m	Pk Lim dBuV/m	Avg Lim dBuV/m	Pk Mar dB	Avg Mar dB	Notes
Channel (2437MHz)															
4874	9.8	51.9	39.4	33.4	3.8	-45.6	0.0	1.0	44.4	31.9	74.0	54.0	-29.6	-22.1	V
7311	9.8	51.9	39.5	35.8	4.8	-46.6	0.0	1.0	46.9	34.5	74.0	54.0	-27.1	-19.5	V
7311	9.8	51.9	39.7	35.8	4.8	-46.6	0.0	1.0	46.9	34.7	74.0	54.0	-27.1	-19.3	H
4874	9.8	52.0	39.1	33.4	3.8	-45.6	0.0	1.0	44.5	31.6	74.0	54.0	-29.5	-22.4	H
								1.0							

f Measurement Frequency	Amp Preamp Gain	Avg Lim Average Field Strength Limit
Dist Distance to Antenna	D Corr Distance Correct to 3 meters	Pk Lim Peak Field Strength Limit
Read Analyzer Reading	Avg Average Field Strength @ 3 m	Avg Mar Margin vs. Average Limit
AF Antenna Factor	Peak Calculated Peak Field Strength	Pk Mar Margin vs. Peak Limit
CL Cable Loss	HPF High Pass Filter	

DIGITAL DEVICE EMISSIONS 30 TO 200 MHz (WORST-CASE HORIZONTAL)

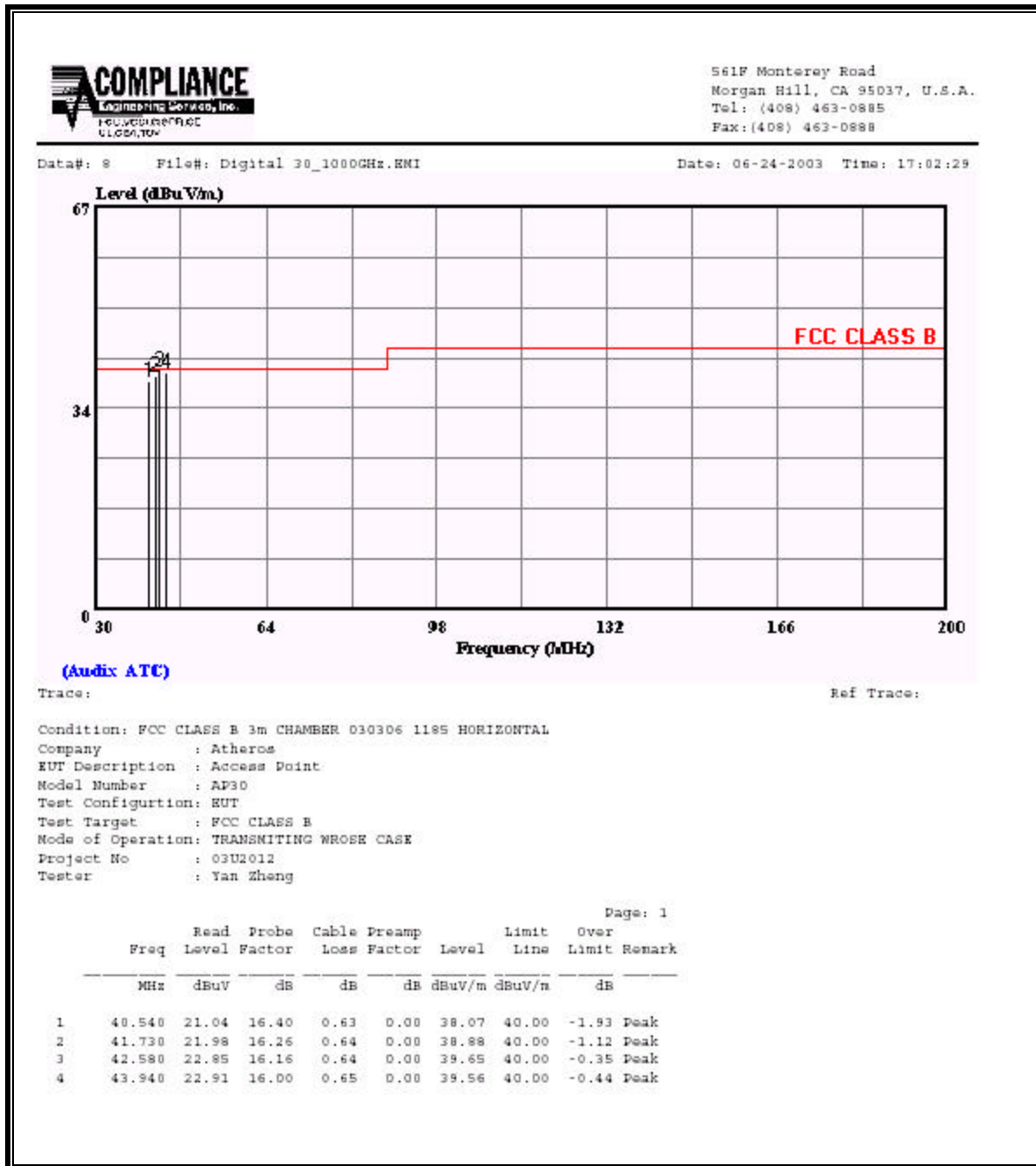

DIGITAL DEVICE EMISSIONS 200 TO 1000 MHz (WORST-CASE HORIZONTAL)

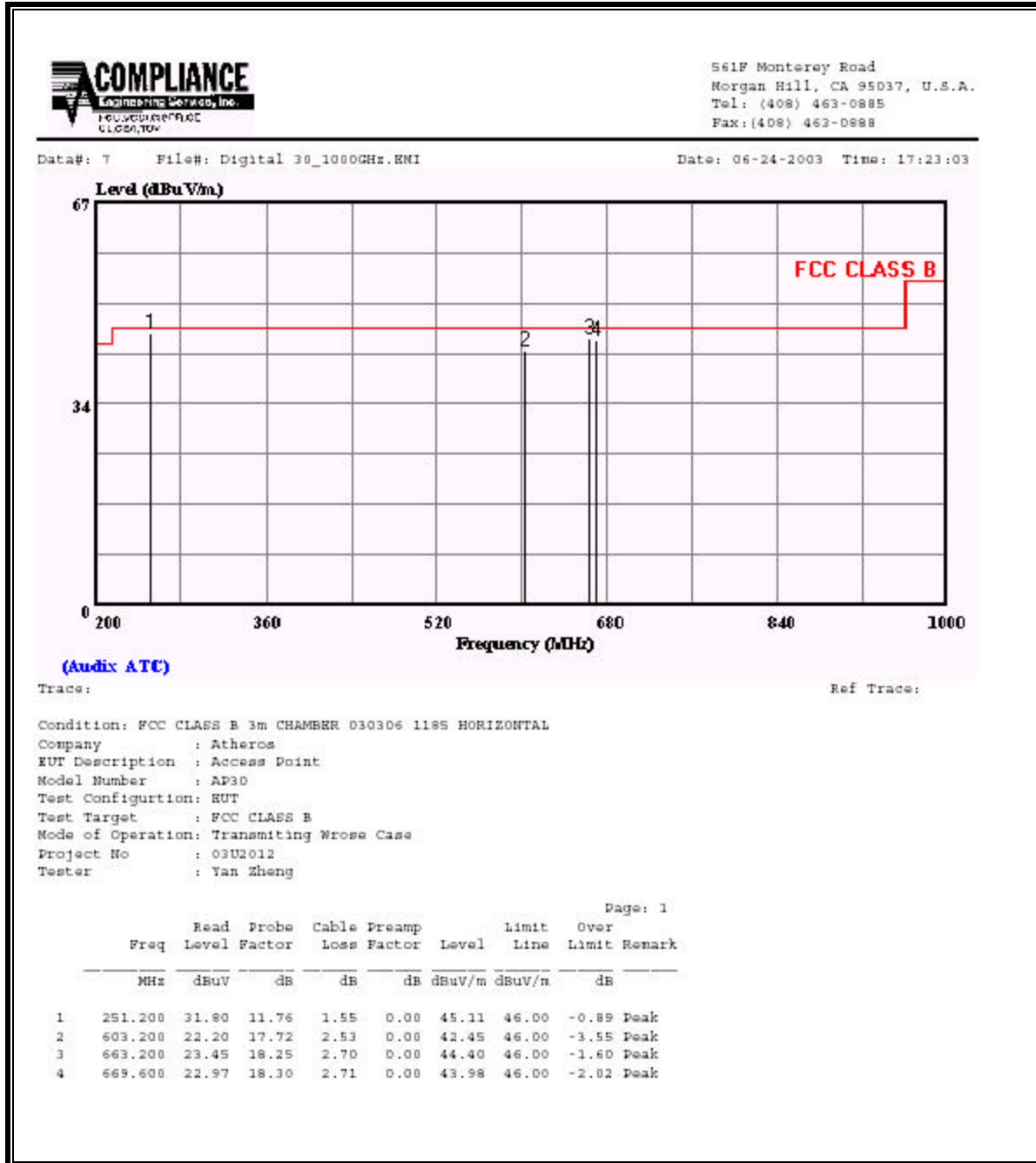

DIGITAL DEVICE EMISSIONS 30 TO 200 MHz (WORST-CASE VERTICAL)

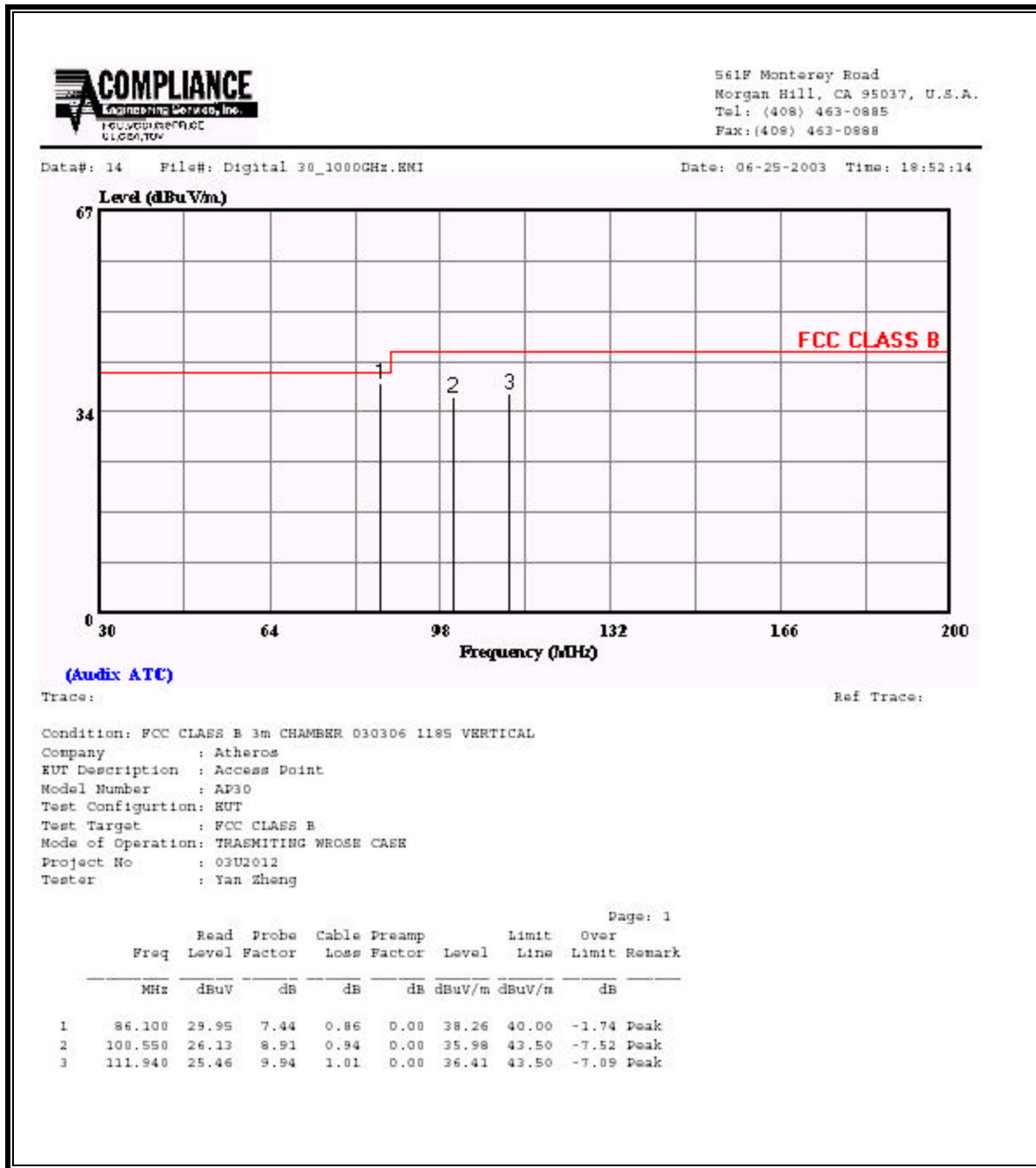

DIGITAL DEVICE EMISSIONS 200 TO 1000 MHz (WORST-CASE VERTICAL)

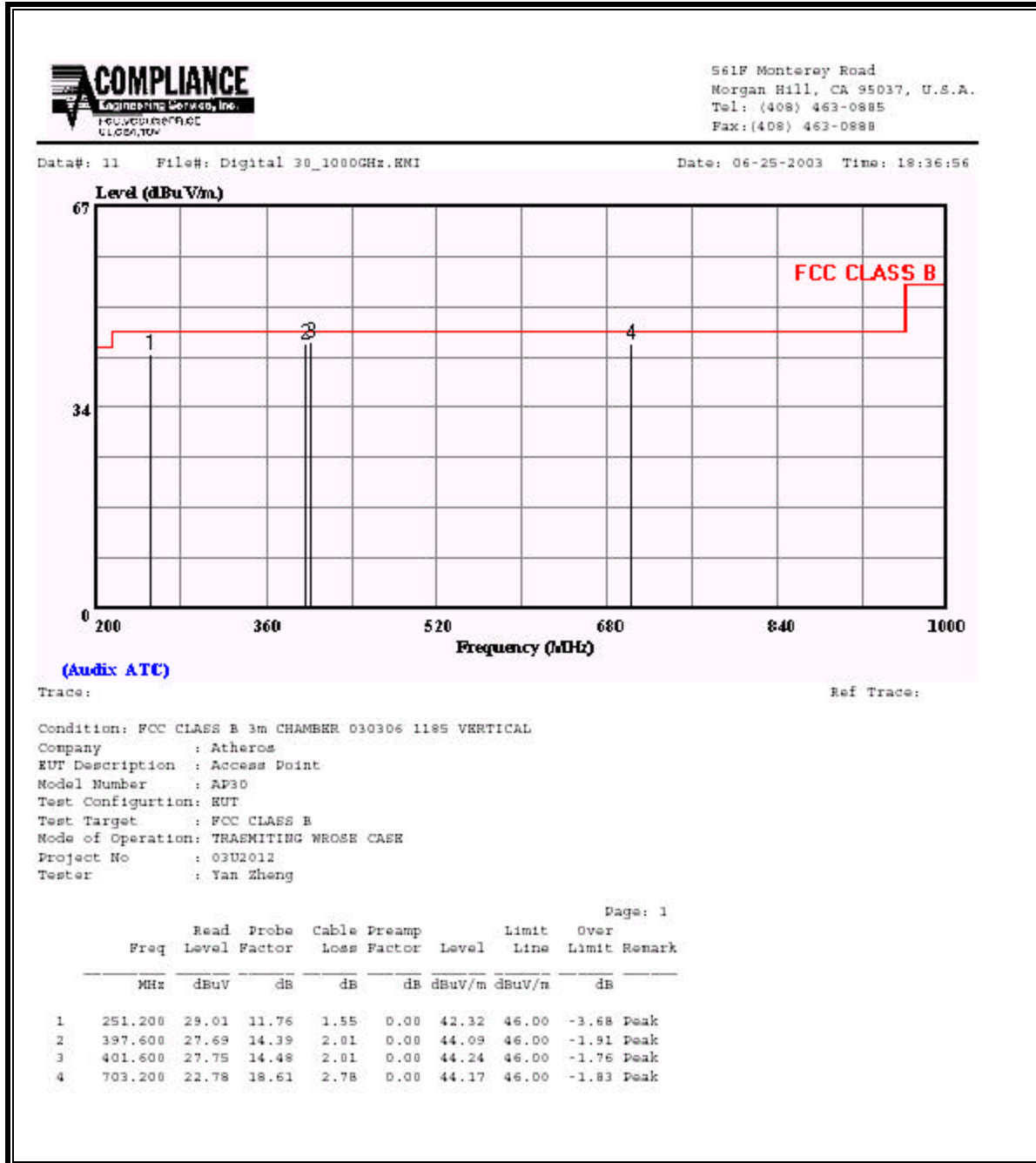

7.9. POWERLINE CONDUCTED EMISSIONS

LIMIT

§ 15.207 (a) Except as shown in paragraphs (b) and (c) of this section, for an intentional radiator that is designed to be connected to the public utility (AC) power line, the radio frequency voltage that is conducted back onto the AC power line on any frequency or frequencies within the band 150 kHz to 30 MHz shall not exceed the limits in the following table, as measured using a 50 μ H/50 ohms line impedance stabilization network (LISN). Compliance with the provisions of this paragraph shall be based on the measurement of the radio frequency voltage between each power line and ground at the power terminal.

The lower limit applies at the boundary between the frequency ranges.

Frequency of Emission (MHz)	Conducted Limit (dBuV)	
	Quasi-peak	Average
0.15-0.5	66 to 56*	56 to 46*
0.5-5	56	46
5-30	60	50

*Decreases with the logarithm of the frequency.

TEST PROCEDURE

The EUT is placed on a non-conducting table 40 cm from the vertical ground plane and 80 cm above the horizontal ground plane. The EUT is configured in accordance with ANSI C63.4.

The resolution bandwidth is set to 9 kHz for both peak detection and quasi-peak detection measurements. Peak detection is used unless otherwise noted as quasi-peak.

Line conducted data is recorded for both NEUTRAL and HOT lines.

RESULTS

No non-compliance noted:

6 WORST EMISSIONS

CONDUCTED EMISSIONS DATA (115VAC 60Hz)									
Freq. (MHz)	Reading			Class (dB)	Limit QP	EN B AV	Margin		Remark L1 / L2
	PK (dBuV)	QP (dBuV)	AV (dBuV)				QP (dB)	AV (dB)	
0.15	53.44	--	--	0.00	65.97	55.97	-12.53	-2.53	L1
0.24	41.80	--	--	0.00	63.51	53.51	-21.71	-11.71	L1
2.20	43.62	--	--	0.00	56.00	46.00	-12.38	-2.38	L1
1.93	48.92	--	36.74	0.00	56.00	46.00	-7.08	-9.26	L2
2.08	48.92	--	36.30	0.00	56.00	46.00	-7.08	-9.70	L2
2.18	48.82	--	35.51	0.00	56.00	46.00	-7.18	-10.49	L2
6 Worst Data									

LINE 1 RESULTS

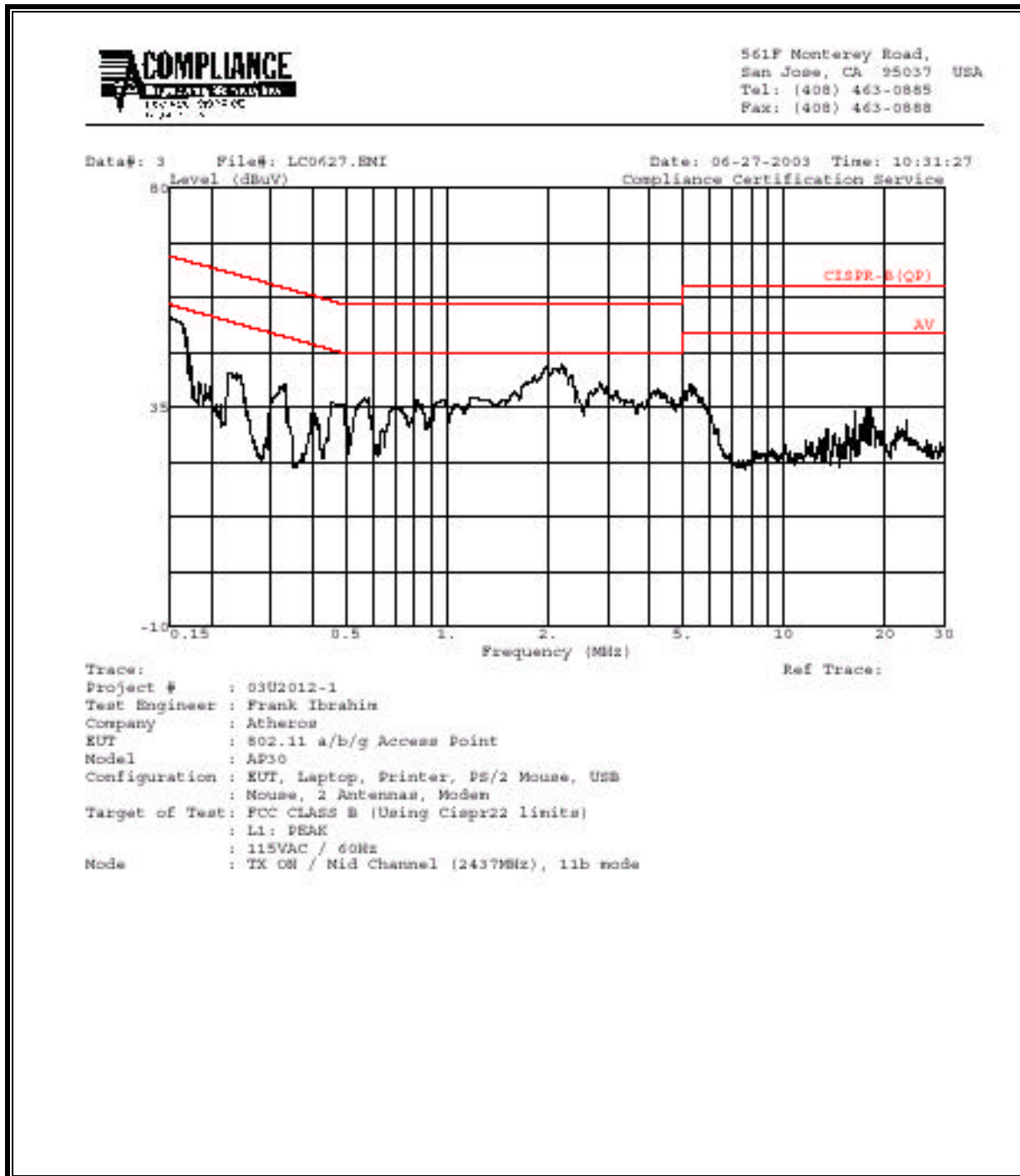

LINE 2 RESULTS

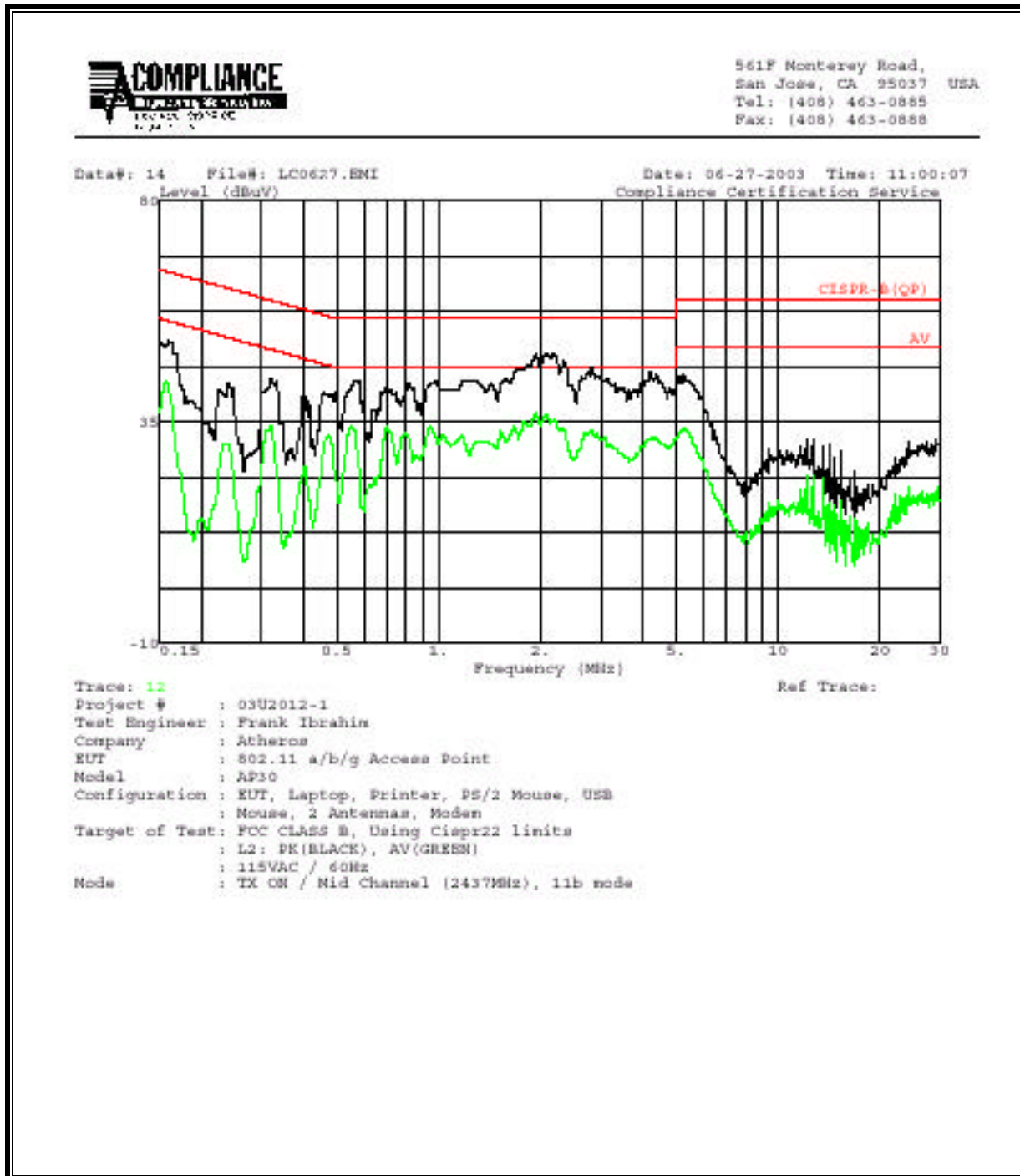

8. SETUP PHOTOS

ANTENNA PORT CONDUCTED RF MEASUREMENT SETUP

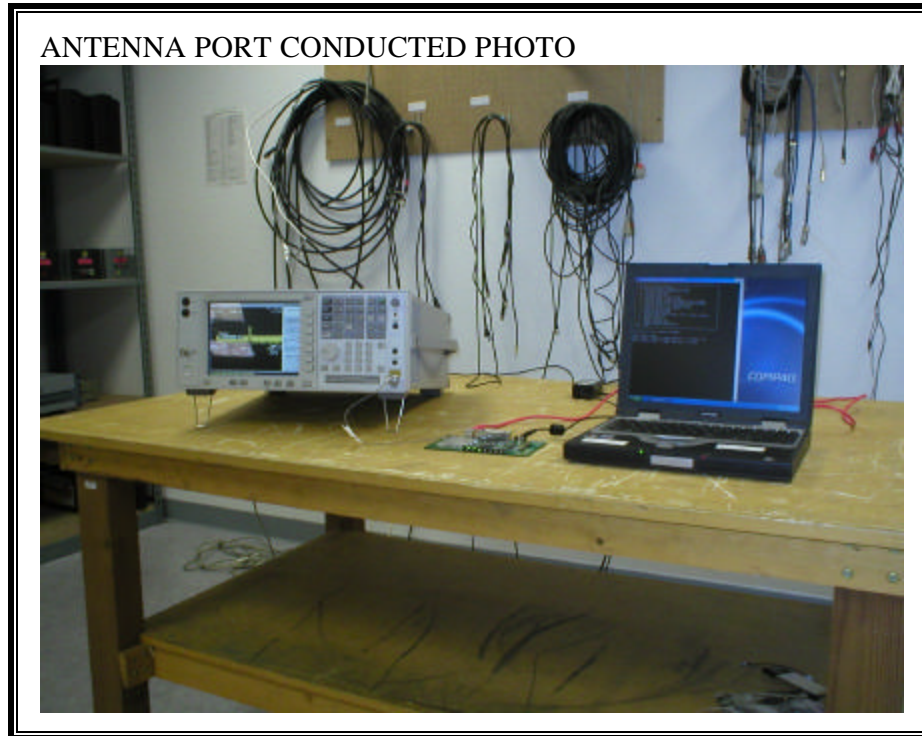

RADIATED RF MEASUREMENT SETUP

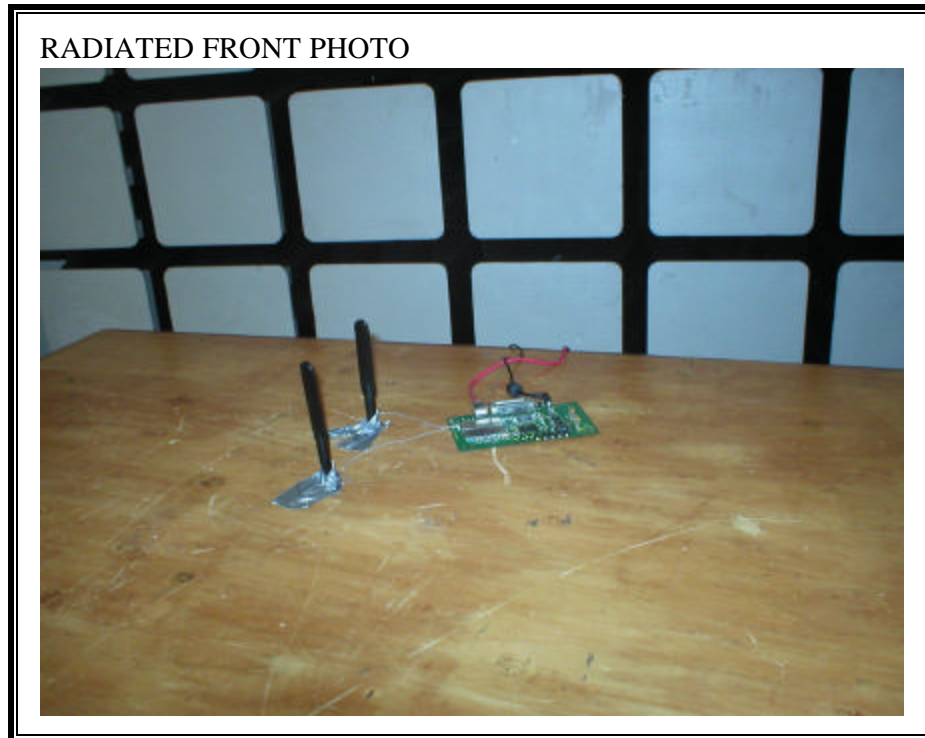

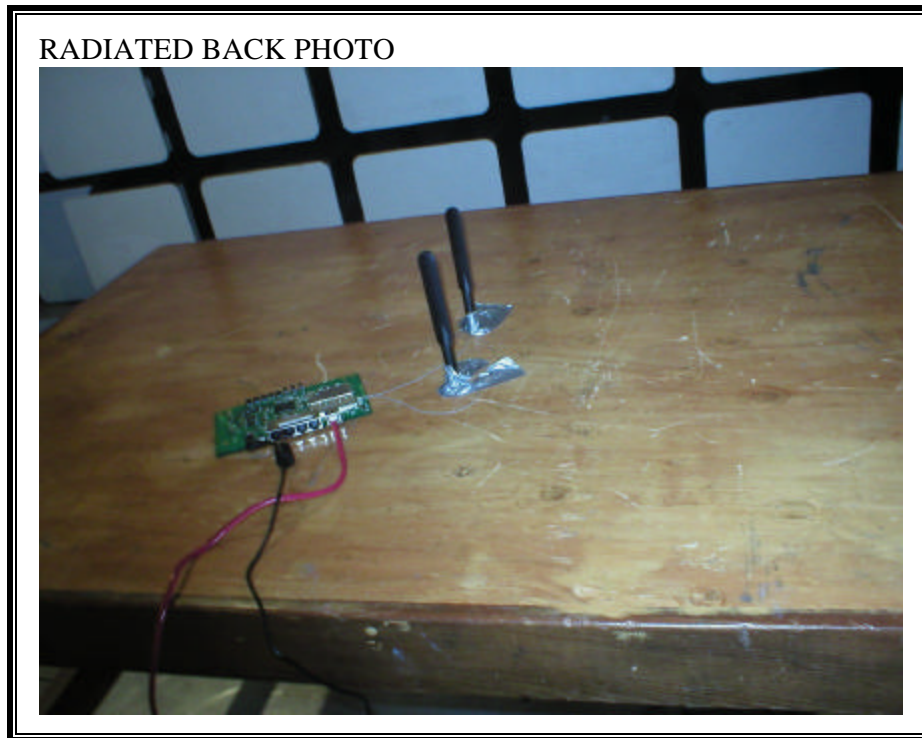

DIGITAL DEVICE RADIATED EMISSIONS SETUP

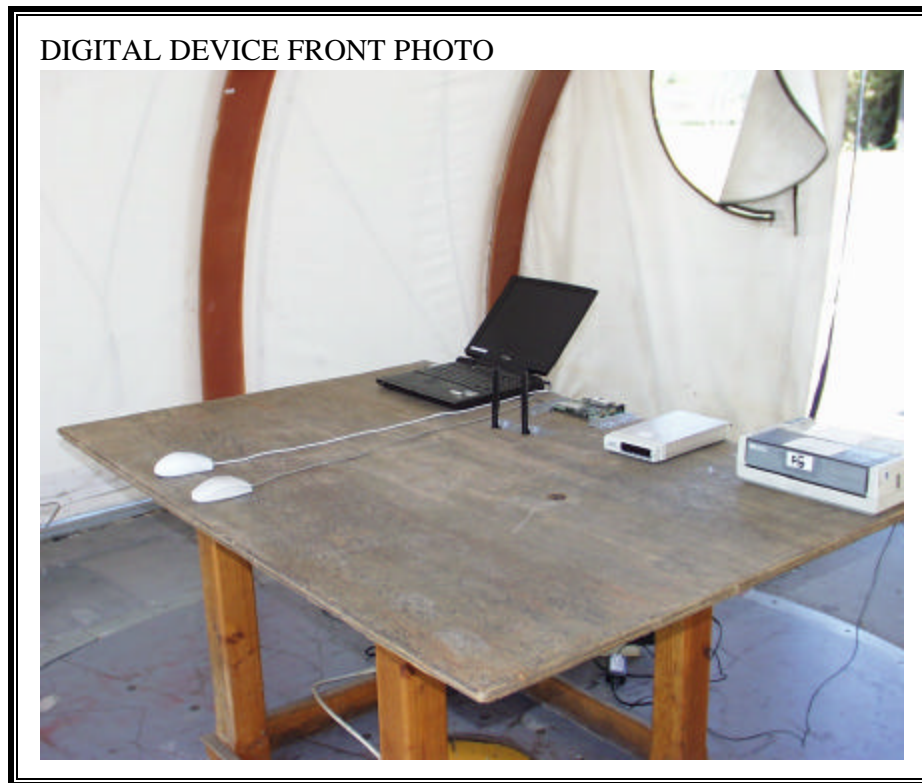

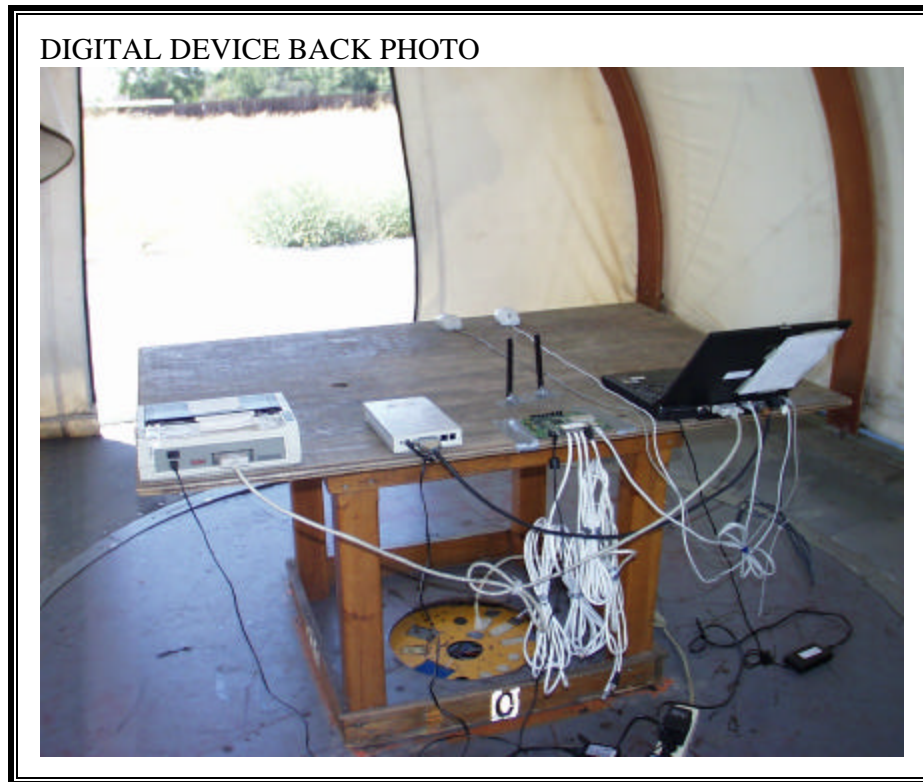

POWERLINE CONDUCTED EMISSIONS MEASUREMENT SETUP

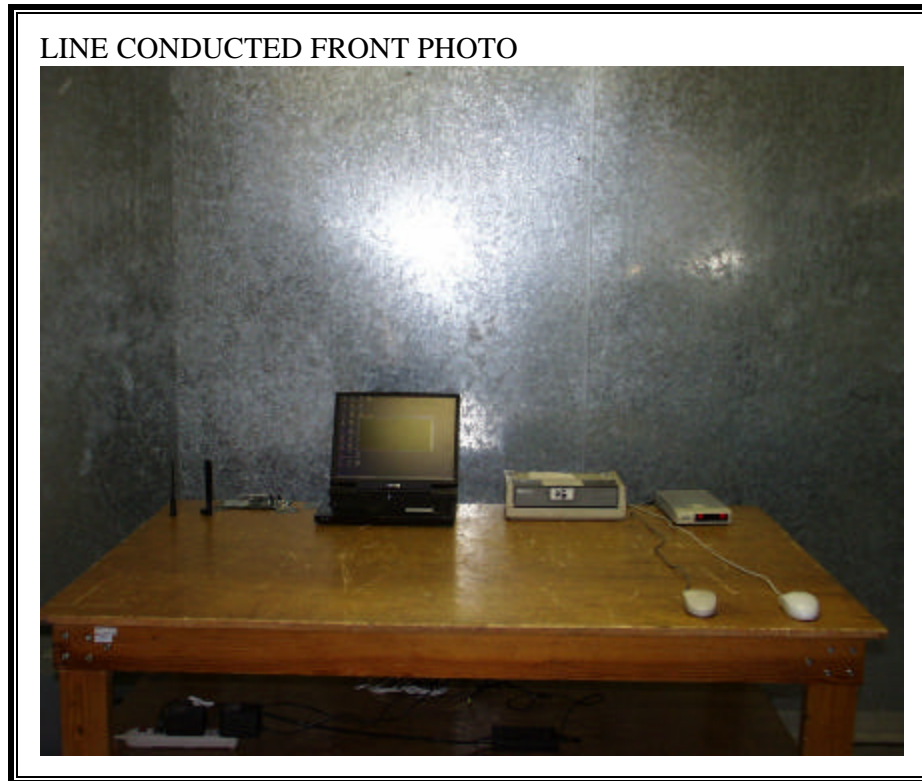



END OF REPORT