

HP TouchSmart User Guide

TouchSmart tm2

© Copyright 2009 Hewlett-Packard Development Company, L.P.

Microsoft and Windows are U.S. registered trademarks of Microsoft Corporation. Bluetooth is a trademark owned by its proprietor and used by Hewlett-Packard Company under license. SD Logo is a trademark of its proprietor.

The information contained herein is subject to change without notice. The only warranties for HP products and services are set forth in the express warranty statements accompanying such products and services. Nothing herein should be construed as constituting an additional warranty. HP shall not be liable for technical or editorial errors or omissions contained herein.

First Edition: January 2010

Document Part Number: 582064-001

Product notice

This user guide describes features that are common to most models. Some features may not be available on your computer.

Antenna House XSL Formatter

Safety warning notice

⚠ WARNING! To reduce the possibility of heat-related injuries or of overheating the computer, do not place the computer directly on your lap or obstruct the computer air vents. Use the computer only on a hard, flat surface. Do not allow another hard surface, such as an adjoining optional printer, or a soft surface, such as pillows or rugs or clothing, to block airflow. Also, do not allow the AC adapter to contact the skin or a soft surface, such as pillows or rugs or clothing, during operation. The computer and the AC adapter comply with the user-accessible surface temperature limits defined by the International Standard for Safety of Information Technology Equipment (IEC 60950).

EVALUATION XSL Formatter

Table of contents

1 Getting started

Charging the battery	1
Identifying the installed hardware and software	1
Identifying hardware	1
Identifying software	1
Rotating the display	2
Finding more information	3
Locating Help and Support	3
Locating regulatory, safety, and environmental notices	3

2 What's next

Creating recovery discs	4
Connecting to the Internet	4
Updating your antivirus software	4
Getting to know the computer	4

3 Using Instant Web

Starting Instant Web	6
Starting Microsoft Windows	6
Disabling and enabling HP Instant Web	7

4 Features

Components	8
Top components	8
TouchPad	8
Lights	9
Keys	10
Front components	10
Right-side components	11
Left-side components	12
Display components	13
Bottom components	14

5 Networking

Choosing an ISP	15
Using Internet Services & Offers	15
Using ISP-provided icons	15

Using the Windows Connect to the Internet Wizard	16
Creating a wireless connection	16
Identifying wireless icons and controls	16
Identifying wireless and network status icons	16
Using the wireless key	17
Using Wireless Assistant software	18
Using operating system controls	18
Connecting to a WLAN	18
Connecting to an existing wireless network	19
Setting up a wireless network	19
Step 1: Purchase high-speed Internet service	20
Step 2: Purchase and install a wireless router	20
Step 3: Configure the computer to connect to the wireless network	20
Protecting your WLAN	21
Roaming to another network	21
Using HP Mobile Broadband	21
Inserting a SIM	22
Removing a SIM	23
Using Bluetooth wireless devices	24
Bluetooth and Internet Connection Sharing (ICS)	24
Connecting to a wired network	25

6 Pointing devices and keyboard

Using pointing devices	26
Setting pointing device preferences	26
Using the TouchPad	26
Using TouchPad gestures	26
Scrolling	26
Pinching	27
Rotating	27
Using the digitizer pen	28
Identifying the pen components	28
Holding the pen	28
Storing the pen	28
Using the touch screen	29
Tapping (or clicking)	29
Flicking	29
Dragging	30
Scrolling	30
Rotating	30
Pinching	31
Setting touch screen preferences	32
Using the action keys	32

Using the hotkeys	33
7 Multimedia	
Using the media activity keys	35
Multimedia software	36
Using HP TouchSmart software or HP MediaSmart software	36
Using multimedia software	36
Installing multimedia software from a disc	37
Audio	37
Adjusting the volume	37
Connecting external audio devices	38
Webcam	38
Adjusting webcam properties	39
Video	40
Using the external monitor port	40
Connecting an HDMI device	40
Configuring audio for HDMI	41
8 Power management	
Shutting down the computer	42
Setting power devices	42
Using power-saving states	42
Initiating and exiting Sleep	43
Initiating and exiting Hibernation	43
Conserving power	44
Using the battery meter	44
Using power plans	44
Viewing the current power plan	44
Selecting a different power plan	44
Customizing power plans	45
Setting password protection on wakeup	45
Using battery power	45
Finding battery information in Help and Support	46
Using Battery Check	46
Displaying the remaining battery charge	46
Removing or inserting the battery	46
Charging a battery	47
Maximizing battery discharge time	48
Managing low battery levels	48
Identifying low battery levels	48
Resolving a low battery level	49
Resolving a low battery level when external power is available	49

Resolving a low battery level when a charged battery is available	49
Resolving a low battery level when no power source is available	49
Resolving a low battery level when the computer cannot exit Hibernation	49
Calibrating a battery	49
Storing a battery	49
Disposing of a used battery	50
Replacing the battery	50
Using external AC power	50
Connecting AC power	50
Testing an AC adapter	51

9 External devices

Using Digital Media Slot cards	52
Inserting a digital card	52
Removing a digital card	53
Using a USB device	53
Connecting a USB device	53
Removing a USB device	54

10 Drives

Handling drives	55
Improving hard drive performance	55
Using Disk Defragmenter	55
Using Disk Cleanup	56
Using HP ProtectSmart Hard Drive Protection	56
Identifying HP ProtectSmart Hard Drive Protection status	56
Managing power with a parked hard drive	57
Using HP ProtectSmart Hard Drive Protection software	57
Inserting and removing a hard drive	58
Using external drives	60
Connecting optional external drives	60
Using an external optical drive	60
Removing an optical disc when the disc tray will not open	61
Sharing an optical drive	61

11 Memory modules

12 Security

Protecting the computer	66
Using passwords	66

Setting passwords in Windows	67
Setting passwords in Setup Utility	67
Administrator password	68
Managing an administrator password	68
Entering an administrator password	68
Power-on password	68
Managing a power-on password	69
Entering a power-on password	69
Using antivirus software	69
Using firewall software	69
Installing critical security updates	70
Installing an optional security cable	70
Using the fingerprint reader (select models only)	71
Registering fingerprints	71
Using your registered fingerprint to log on to Windows	72
13 Backup and recovery	
Creating recovery discs	73
Backing up your information	74
Using Windows Backup and Restore	75
Using system restore points	75
When to create restore points	75
Create a system restore point	75
Restore to a previous date and time	75
Performing a recovery	76
Recovering from the recovery discs	76
Recovering from the dedicated recovery partition (select models only)	76
14 Setup Utility (BIOS)	
Starting Setup Utility	77
Using Setup Utility	77
Changing the language of Setup Utility	77
Navigating and selecting in Setup Utility	78
Displaying system information	78
Restoring default settings in Setup Utility	78
Exiting Setup Utility	79
Setup Utility Menus	79
Main menu	79
Security menu	79
System Configuration menu	79
Diagnostics menu	80
Updating the BIOS	80
Updating the BIOS	80

	Determining the BIOS version	80
	Downloading a BIOS update	81
Appendix A Product information		
	Input power	83
	Operating environment	83
	Traveling with the computer	84
	Routine care	84
	Cleaning the display	84
	Cleaning the TouchPad and keyboard	85
	Labels	85
Appendix B Troubleshooting		
	Quick troubleshooting	87
	The computer is unable to start up	87
	The TouchPad is behaving erratically	87
	The computer screen is blank	87
	Software is functioning abnormally	88
	The computer is on but is not responding	88
	The computer is unusually warm	88
	Checking your audio functions	88
	An external device is not working	89
	The wireless network connection is not working	89
	Cannot connect to a preferred network	90
	Network icon for WLAN is not displayed	90
	Current WLAN network security codes are unavailable	90
	WLAN connection is very weak	91
	Cannot connect to the wireless router	91
	Contacting customer support	91
Index		92

1 Getting started

Charging the battery

To fully charge the battery, leave the computer plugged into external power until the battery light on the computer turns white.



⚠ WARNING! To reduce the risk of electric shock or damage to your equipment, observe these guidelines:

Plug the power cord into an AC outlet that is easily accessible at all times.

Disconnect power from the computer by unplugging the power cord from the AC outlet (not by unplugging the power cord from the computer).

If provided with a 3-pin attachment plug on your power cord, plug the cord into a grounded (earthed) 3-pin outlet. Do not disable the power cord grounding pin, for example, by attaching a 2-pin adapter. The grounding pin is an important safety feature.

📝 NOTE: A partially charged new battery can run the computer after software setup is complete, but battery charge displays will not be accurate until the new battery has been fully charged. The battery light turns white when the battery is fully charged.

Identifying the installed hardware and software

Identifying hardware

To see a list of hardware installed in the computer:

- Select **Start > Control Panel > System and Security**. Then in the **System** area, click **Device Manager**.

You can also add hardware or modify device configurations using Device Manager.

📝 NOTE: Windows® includes the User Account Control feature to improve the security of your computer. You may be prompted for your permission or password for tasks such as installing applications, running utilities, or changing Windows settings. Refer to Help and Support for more information.

Identifying software

To see a list of the software installed on the computer:

- Select **Start > All Programs**.

Rotating the display

To use the computer in slate mode:

1. Open the display.
2. Rotate the display clockwise 180 degrees.



3. Lower the display over the keyboard.



△ **CAUTION:** To reduce the risk of damage to your computer, do not force the display past 180 degrees, and do not transport the computer while it is in slate mode.

Finding more information

Locating Help and Support

In addition to the user guides, Help and Support provides information about the operating system, power management, software updates, networking, drivers, troubleshooting tools, and accessing technical support.

 **NOTE:** You do not need to connect to the Internet to access the user guides in Help and Support.

To access Help and Support:

- Select **Start > Help and Support**.

– or –

For country- or region-specific support, go to <http://www.hp.com/support>, select your country or region, and follow the on-screen instructions.

Locating regulatory, safety, and environmental notices

 **WARNING!** To reduce the risk of serious injury, read the *Safety & Comfort Guide*. It describes proper workstation setup and proper posture, health, and work habits for computer users. The *Safety & Comfort Guide* also provides important electrical and mechanical safety information. To access this guide, select **Start > Help and Support > User Guides**. The *Safety & Comfort Guide* is also available on the Web at <http://www.hp.com/ergo>.

For more safety and regulatory information, and for battery disposal information, refer to the *Regulatory, Safety and Environmental Notices*.

To access the notices:

- Select **Start > Help and Support > User Guides**.

2 What's next

After you set up and register the computer, it is important to take the next steps in this chapter before you begin using the computer. For help in identifying specific components of the computer, refer to [Features on page 8](#).

Creating recovery discs

After setting up the computer, one of the first and most important steps to take is to create a set of recovery discs of the full factory image. The recovery discs are essential in case of system instability or failure, when they are used to recover the operating system and software to factory settings. For instructions, refer to [Backup and recovery on page 73](#).

Connecting to the Internet

After creating the recovery discs, set up your wired or wireless network so that you can send and receive e-mail and connect to the Internet. For more information, refer to [Networking on page 15](#).

Updating your antivirus software

After you have connected to the Internet, be sure to update your antivirus software. The software is preinstalled on the computer and includes a limited subscription for free updates. Antivirus software helps protect your computer from damage caused by viruses. For more information, refer to [Using antivirus software on page 69](#).

Getting to know the computer

When you have completed the preceding steps, familiarize yourself with the features of the computer and set up any additional components, such as optional external audio devices.

The following list highlights the entertainment features of the computer and explains where to get additional information for each feature.

- **HP Instant Web**—You can perform many of your favorite activities without the need to start the main operating system. If you like to browse the Internet, view digital photos, listen to music, or keep in touch through e-mail, instant messages, or Skype (select models only), you will enjoy the many features of HP Instant Web. For details, refer to [Using Instant Web on page 6](#).
- **Multimedia software**—The computer comes with preinstalled multimedia software, including HP TouchSmart software, which turns the computer into a mobile entertainment center. For details, refer to [Multimedia software on page 36](#).
- **Audio**—The computer includes integrated speakers. For more information on using the integrated speakers and setting up optional external audio devices, refer to [Audio on page 37](#).

- **Video**—You can connect an optional display device or an HDMI (High Definition Multimedia Interface) device to the computer. You can also connect an optional optical drive. For more information about the video features, refer to [Video on page 40](#).
- **Webcam**—Adjustable, with low-light image technology and built-in microphones, the webcam is a perfect companion to your instant messaging program. For more information on the webcam, refer to [Webcam on page 38](#).

3 Using Instant Web

HP Instant Web provides a fun and engaging way to perform many of your favorite activities. Your computer is ready to go within seconds of sliding the power switch and you can rapidly access several applications without the need to start the main operating system. If you like to browse the Internet, view digital photos, listen to music, or keep in touch through e-mail, instant messages, or Skype (select models only), you will enjoy the many features of HP Instant Web.

 **NOTE:** Instant Web is an optional, instant-on environment that is separate from your Windows operating system.

Instant Web includes the following features:

- **Web browser**—Browsing the Internet has never been faster or easier. Web browser is optimized to give you a great Internet experience instantly. Enjoy surfing the Web and bookmarking your favorite sites at your convenience.
- **Chat**—Access popular Instant Messaging programs such as Google Talk, Windows Live Messenger, or Yahoo! Messenger to chat with friends.
- **Skype (select models only)**—Skype is a voice over Internet protocol (VoIP) that lets you communicate free of charge with other Skype users. Skype permits long-distance phone calls to land lines and also offers video chat capability.
- **Web e-mail**—View your Web-based e-mail using Gmail, Hotmail, Yahoo, and other webmail providers.
- **Web calendar**—Schedule and manage your activities using your favorite online calendar application.
- **Music Player**—Listen to your favorite music files with Music Player. When you are suddenly in the mood, your favorite tunes are only moments away.
- **Photo Viewer**—Browse through photos, create albums, take pictures, and view slide shows using Photo Viewer. If a picture is worth a thousand words, it is worth even more to view your pictures when you want to.

For detailed information on Instant Web, refer to the software Help.

Starting Instant Web

To start Instant Web when the computer is powered off:

1. Turn on your computer. The Instant Web Home screen appears.
2. Click an icon on the Instant Web Home screen to launch a program.

Starting Microsoft Windows

To start the main operating system:

1. Click the Windows **Start** button on the far left of the Instant Web Home screen.
2. A dialog box appears, asking if you are sure you want to start Windows. Click **Yes**.

 **NOTE:** Clicking on the **Make Windows your default Power On experience** in this dialog box disables Instant Web. For more information on disabling and enabling Instant Web, refer to [Disabling and enabling HP Instant Web on page 7](#).

Disabling and enabling HP Instant Web

You can disable or reenable Instant Web in two ways.

To disable or reenable Instant Web from the Windows operating system:

1. Click **Start > All Programs > HP Instant Web**. The **HP Instant Web Installer** folder displays.
2. Click **HP Instant Web Configuration Tool**.
3. Select the **Enable HP Instant Web** check box.
4. Click **OK**.

 **NOTE:** The HP Instant Web Configuration Tool can also be accessed by clicking **Start > Control Panel**.

To disable or reenable Instant Web from within Setup Utility:

1. Open Setup Utility by turning on or restarting the computer. Immediately press **f10** repeatedly to enter Setup Utility.
2. Use the arrow keys to select **System Configuration**.
3. Use the down arrow key to select **HP Instant Web Support**, and then press **enter**.
4. Use the arrow key to select **Enable** or **Disable**, and then press **enter**.
5. Press **enter** to confirm your change.
6. To save your change and exit Setup Utility, use the arrow keys to select **Exit**, select **Exit Saving Changes**, and then press **enter**.

4 Features

Components

Top components

TouchPad

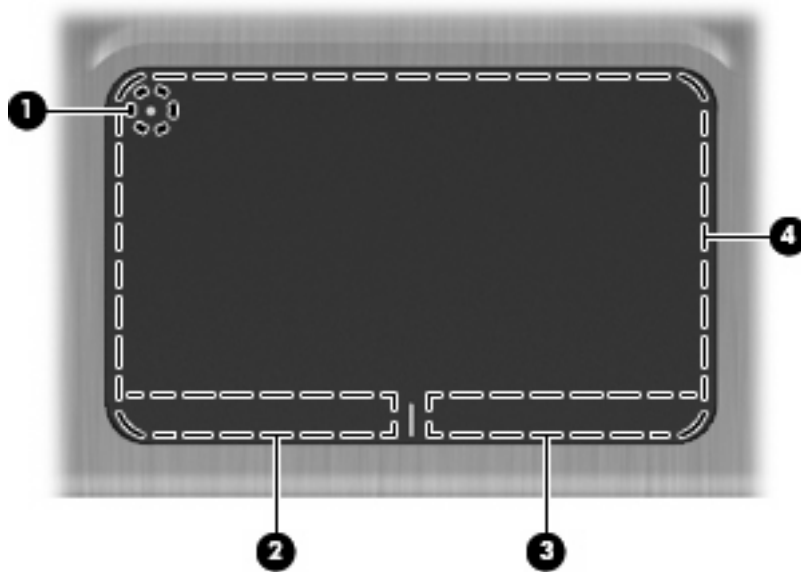



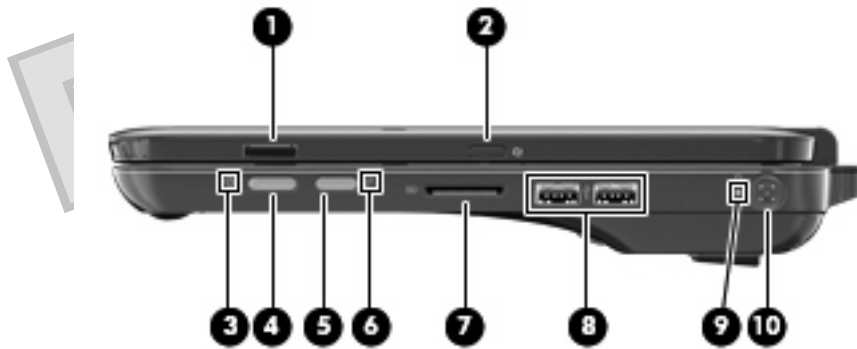

Component	Description
(1)  TouchPad on/off button	Turns the TouchPad on and off. Lightly press the button and hold for 3 seconds to turn the TouchPad on and off.
(2) Left TouchPad button*	Functions like the left button on an external mouse.
(3) Right TouchPad button*	Functions like the right button on an external mouse.
(4) TouchPad*	Moves the pointer and selects or activates items on the screen.

*This table describes factory settings. To view and change pointing device preferences, select **Start > Devices and Printers**. Then, right-click the device representing your computer, and select **Mouse settings**.

Right-side components





Component	Description
(1) Fingerprint reader	Allows a fingerprint logon to Windows instead of a password logon.
(2)  Rotate button	Rotates the screen image counter-clockwise into 4 orientations: landscape primary, portrait primary, landscape secondary, and portrait secondary.
(3)  Power light	<ul style="list-style-type: none"> • White: The computer is on. • Blinking white: The computer is in the Sleep state. • Off: The computer is off or in Hibernation.
(4) Power switch	<ul style="list-style-type: none"> • When the computer is off, slide the power switch to turn on the computer. • When the computer is on, briefly slide the power switch to exit Sleep. • When the computer is in the Sleep state, briefly slide the power switch to exit Sleep. • When the computer is in Hibernation, briefly slide the power switch to exit Hibernation. <p>If the computer has stopped responding and Windows® shutdown procedures are ineffective, slide and hold the power switch for at least 5 seconds to turn off the computer.</p> <p>To learn more about your power settings, select Start > Control Panel > System and Security > Power Options.</p>
(5) Wireless button	<p>Turns the wireless feature on or off, but does not establish a wireless connection.</p> <p>NOTE: A wireless network must be set up in order to establish a wireless connection.</p>
(6)  Wireless light	<ul style="list-style-type: none"> • Off: An integrated wireless device, such as a wireless local area network (WLAN) device and/or a Bluetooth® device, is on. • NOTE: Wireless devices are enabled at the factory. • Amber: All wireless devices are off.

Component	Description
(7) Digital Media Slot	Supports the following digital card formats: <ul style="list-style-type: none"> • Memory Stick • Memory Stick Pro • MultiMediaCard • Secure Digital Memory Card • xD-Picture Card
(8)  USB ports (2)	Connect optional USB devices.
(9)  Battery light	<ul style="list-style-type: none"> • Off: The computer is running on battery power. • Blinking amber: The battery has reached a low battery level, a critical battery level, or there is a battery error. • Amber: A battery is charging. • White: The computer is connected to external power and the battery is fully charged.
(10) Power connector	Connects an AC adapter.

Left-side components



Component	Description
(1) Vent	Enables airflow to cool internal components. NOTE: The computer fan starts up automatically to cool internal components and prevent overheating. It is normal for the internal fan to cycle on and off during routine operation.
(2) HDMI port	Connects an optional video or audio device, such as a high-definition television, or any compatible digital or audio component.
(3)  USB port	Connects an optional USB device.
(4)  Audio-out (headphone) jack/Audio-in (microphone) jack	Produces sound when connected to optional powered stereo speakers, headphones, earbuds, a headset, or television audio. Also connects an optional headset microphone. NOTE: When a device is connected to the jack, the device speakers are disabled.

Component	Description
(5)  Security cable slot	Attaches an optional security cable to the computer. NOTE: The security cable is designed to act as a deterrent, but it may not prevent the computer from being mishandled or stolen.
(6) Pen holder	Holds the pen.

Display components





Component	Description
(1) WWAN antennas (2)*	Send and receive wireless signals to communicate with wireless wide-area networks (WWAN).
(2) WLAN antennas (2)*	Send and receive wireless signals to communicate with wireless local area networks (WLAN).
(3) Internal microphones (2)	Record sound.
(4) Webcam light	On: The webcam is in use.
(5) Webcam	Records video and captures still photographs.
(6) Speakers (2)	Produce sound.
(7) Convertible hinge	Swivels the display and converts the computer from traditional notebook mode into slate mode or vice versa. In slate mode, the display is rotated and folded flat, so that you can view content while carrying the computer.

*The antennas are not visible from the outside of the computer. For optimal transmission, keep the areas immediately around the antennas free from obstructions. To see wireless regulatory notices, refer to the section of the *Regulatory, Safety and Environmental Notices* that applies to your country or region. These notices are located in Help and Support.

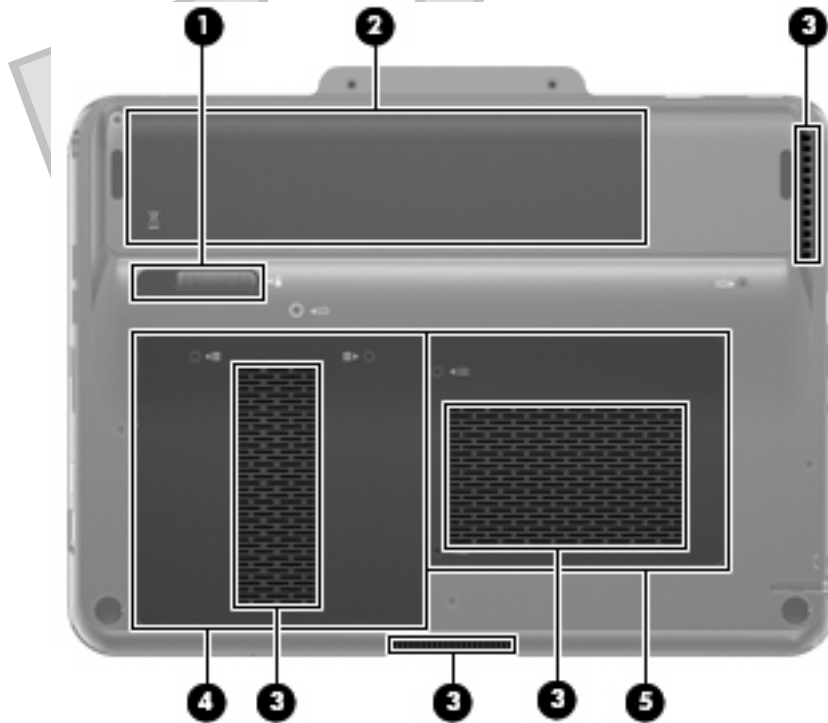
Bottom components



Component	Description
(1)  Battery release latch	Releases the battery from the battery bay.
(2) Battery bay	Holds the battery. NOTE: The battery is preinstalled in the battery bay at the factory.
(3) Vents (4)	Enable airflow to cool internal components. NOTE: The computer fan starts up automatically to cool internal components and prevent overheating. It is normal for the internal fan to cycle on and off during routine operation.
(4)  Hard drive bay	Holds the hard drive.
(5)  Memory module compartment	Contains the memory module slots.

5 Networking

The computer supports 2 types of Internet access:

- **Wireless**—For mobile Internet access, you can use a wireless connection. To learn about adding the computer to an existing network or setting up a wireless network, refer to [Creating a wireless connection on page 16](#).
- **Wired**—You can access the Internet by connecting to a broadband network using the RJ-45 (network) jack. To learn about connecting using the RJ-45 jack, refer to [Connecting to a wired network on page 25](#).

Choosing an ISP

You must set up Internet service before you can connect to the Internet. The computer includes the following software features to help you set up a new Internet account or configure the computer to use an existing account:

- Internet Services & Offers (available in some locations)
- ISP-provided icons (available in some locations)
- Windows Connect to the Internet Wizard (available in all locations)

Using Internet Services & Offers

If the Internet Service & Offers utility is supported in the country or region in which you purchased the computer, you can access the utility by using the following method:

- Select **Start > All Programs > Online Services > Get Online**.

The Internet Services & Offers utility assists with these tasks:

- Signing up for a new Internet account
- Configuring the computer to use an existing account

Using ISP-provided icons

If ISP-provided icons are supported in the country or region in which you purchased the computer, the icons may be displayed either individually on the Windows desktop or grouped in a desktop folder named Online Services.

- To set up a new Internet account or configure the computer to use an existing account, double-click an icon, and then follow the instructions on the screen.

Using the Windows Connect to the Internet Wizard

You can use the Windows Connect to the Internet Wizard to connect to the Internet in any of these situations:

- If you already have an account with an ISP.
- If you have a disc from an ISP.
- If you do not have an Internet account and would like to select an ISP from the list provided within the wizard. (The list of ISP providers is not available in all regions.)
- If you have selected an unlisted ISP and the ISP has provided you with such information as a specific IP address and POP3 and SMTP settings.

To access the Windows Connect To The Internet Wizard and instructions for using the wizard, click **Start**, and then click **Help and Support**.

 **NOTE:** If you are prompted within the wizard to choose between enabling or disabling Windows Firewall, choose to enable the firewall.

Creating a wireless connection

Wireless technology transfers data across radio waves instead of wires. Your computer may be equipped with one or more of the following wireless devices:







- Wireless local area network (WLAN) device—Connects the computer to wireless local area networks (commonly referred to as Wi-Fi networks, wireless LANs, or WLANs) in corporate offices, your home, and public places such as airports, restaurants, coffee shops, hotels, and universities. In a WLAN, each mobile wireless device communicates with a wireless router or a wireless access point.
- HP Mobile Broadband Module—A wireless wide area network (WWAN) device that provides access to information wherever mobile network operator service is available. In a WWAN, each mobile device communicates to a mobile network operator's base station. Mobile network operators install networks of base stations (similar to cell phone towers) throughout large geographic areas, effectively providing coverage across entire states, regions, or even countries.
- Bluetooth® device—Creates a personal area network (PAN) to connect to other Bluetooth-enabled devices such as computers, phones, printers, headsets, speakers, and cameras. In a PAN, each device communicates directly with other devices, and devices must be relatively close together—typically within 10 meters (approximately 33 feet) of each other.

For more information on wireless technology, refer to the information and Web site links provided in Help and Support.

Identifying wireless icons and controls

Identifying wireless and network status icons

Icon	Name	Description
	Wireless (connected)	Identifies the location of the wireless light and the wireless key on the computer. Also identifies the Wireless Assistant software on the computer and indicates that one or more of the wireless devices are on.

	Wireless (disconnected)	Identifies the Wireless Assistant software on the computer and indicates that all of the wireless devices are off.
	Wired network (connected)	Indicates that one or more network drivers on your computer are installed and one or more network devices are connected to the network.
	Wired network (disabled/disconnected)	Indicates that one or more of your network drivers are installed, all network devices or all wireless devices are disabled in Windows Control Panel, and no network devices are connected to a wired network.
	Network (connected)	Indicates that one or more of your network drivers are installed, one or more network devices are connected to a wireless network, and one or more network devices may be connected to a wired network.
	Network (disabled/disconnected)	Indicates that one or more of your network drivers are installed, no wireless connections are available or all wireless network devices are disabled by the wireless button or Wireless Assistant, and no network devices are connected to a wired network.
	Network (disconnected)	Indicates that one or more of your network drivers are installed and wireless connections are available, but no network devices are connected to a wired or wireless network.

Using the wireless key

The computer has a **wireless key (1)**, one or more wireless devices, and one wireless light **(2)**. All of the wireless devices on your computer are enabled at the factory.

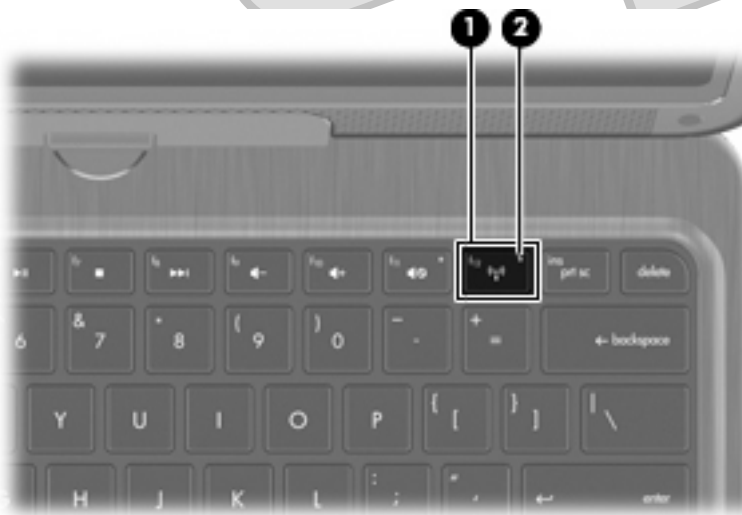

If the wireless light is amber, one or more wireless devices are off. If the wireless light is off, an integrated wireless device, such as a wireless local area network (WLAN) device and/or a Bluetooth® device, is on.

The wireless light indicates the overall power state of your wireless devices, not the status of individual devices. Press the **wireless** key to turn the wireless devices off or on.

Because the wireless devices are enabled at the factory, you can use the [wireless](#) key to turn on or turn off the wireless devices simultaneously. Individual wireless devices can be controlled through Wireless Assistant software.

Using Wireless Assistant software

A wireless device can be turned on or off using the Wireless Assistant software. If a wireless device is disabled in Setup Utility, it must be reenabled in Setup Utility before it can be turned on or off using Wireless Assistant.

 **NOTE:** Enabling or turning on a wireless device does not automatically connect the computer to a network or a Bluetooth-enabled device.

To view the state of the wireless devices, click the **Show hidden icons** icon, the arrow at the left of the notification area, and position the mouse pointer over the wireless icon.

If the wireless icon is not displayed in the notification area, complete the following steps to change Wireless Assistant properties:

1. Select **Start > Control Panel > Hardware and Sound > Windows Mobility Center**.
2. Click the wireless icon in the Wireless Assistant tile, which is located in the bottom row of Windows® Mobility Center.
3. Click **Properties**.
4. Select the check box next to **HP Wireless Assistant icon in notification area**.
5. Click **Apply**.
6. Click **Close**.

For more information, refer to the Wireless Assistant software Help:

1. Open Wireless Assistant by clicking the wireless icon in Windows Mobility Center.
2. Click the **Help** button.

Using operating system controls

Some operating systems also offer a way to manage integrated wireless devices and the wireless connection. For example, Windows provides the Network and Sharing Center that allows you to set up a connection or network, connect to a network, manage wireless networks, and diagnose and repair network problems.

To access the Network and Sharing Center, select **Start > Control Panel > Network and Internet > Network and Sharing Center**.

For more information, select **Start > Help and Support**.

Connecting to a WLAN

With a WLAN device, you can access a wireless local area network (WLAN), which is composed of other computers and accessories that are linked by a wireless router or a wireless access point.

 **NOTE:** The terms *wireless router* and *wireless access point* are often used interchangeably.

- A large-scale WLAN, such as a corporate or public WLAN, typically uses wireless access points that can accommodate a large number of computers and accessories and can separate critical network functions.
- A home or small office WLAN typically uses a wireless router, which allows several wireless and wired computers to share an Internet connection, a printer, and files without requiring additional pieces of hardware or software.

To use the WLAN device in your computer, you must connect to a WLAN infrastructure (provided through a service provider or a public or corporate network).

Connecting to an existing wireless network

To connect the computer to an existing wireless network, follow these steps:

1. Be sure that the wireless device is on (wireless light is off). If the wireless light is amber, press the **wireless** key.
2. Click the network icon in the notification area, at the far right of the taskbar.
3. Select a network to connect to.
4. Click **Connect**.
5. If the network is a security-enabled WLAN, you are prompted to enter a network security key, which is a security code. Type the code, and then click **OK** to complete the connection.

Setting up a wireless network

To set up a WLAN and connect to the Internet, you need the following equipment:

- A broadband modem (either DSL or cable) **(1)** and high-speed Internet service purchased from an Internet service provider (ISP)
- A wireless router (purchased separately) **(2)**
- The wireless computer **(3)**

The illustration below shows an example of a wireless network installation that is connected to the Internet.

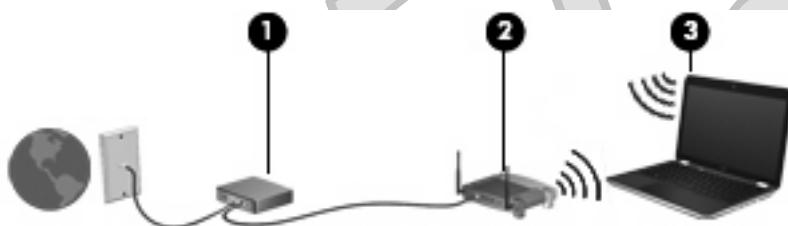

 **NOTE:** When setting up a wireless connection, be sure that your computer and wireless router are synchronized. To synchronize your computer and wireless router, turn your computer and wireless router off and then back on.

As your network grows, additional wireless and wired computers can be connected to the network to access the Internet.

For additional help in setting up your WLAN, refer to the information provided by your router manufacturer or your ISP.

Step 1: Purchase high-speed Internet service

If you already have high-speed Internet service (DSL, cable, or satellite), begin with . If you do not have high-speed Internet service, follow these steps:

1. Contact a local ISP to purchase high-speed Internet service and a DSL or cable modem. The ISP will help set up the modem, install a network cable to connect your wireless computer to the modem, and test the Internet service.
2. Your ISP will give you a User ID and password to access the Internet. Record this information and store it in a safe place.

Step 2: Purchase and install a wireless router

Read this section carefully before you install the wireless router using the router manufacturer's instructions and your wireless computer. If you need technical assistance during the router installation, contact the router manufacturer.

 **NOTE:** It is recommended that you temporarily connect your new wireless computer to the router by using the network cable provided with the router. This will ensure that the computer can access the Internet.

1. Be sure that the wireless light on the computer is off. If the wireless light is on, turn it off by pressing the wireless key.
2. During the router installation, the router manufacturer's software allows you to change the network name (SSID) and enable security to protect the privacy of your wireless network. Many routers are shipped with a default network name and with security disabled. If you change the default network name or enable security during the router setup, record the information and store it in a safe place. You will need this information when you configure the computer and any other existing computers to access the router.

 **NOTE:** If you do not enable security, an unauthorized wireless user can access the data on the computer and use your Internet connection without your knowledge. For more information on securing your wireless network, refer to the Wireless guide in Help and Support.

The Windows operating system also provides tools to help you set up your wireless network for the first time. To use the Windows tools to set up your network:

- Click **Start > Network > Network and Sharing Center > Set up a connection or network > Set up a wireless router or access point**. Then follow the on-screen instructions.

Step 3: Configure the computer to connect to the wireless network

1. Be sure that the wireless device is on (wireless light is off). If the wireless light is amber, press the [wireless](#) key.
2. Click the network icon in the notification area, at the far right of the taskbar.
3. Select a network to connect to.
4. Click **Connect**.
5. If the network is a security-enabled WLAN, you are prompted to enter a network security key, which is a security code. Type the code, and then click **OK** to complete the connection.
6. Test the wireless network by opening your Web browser and accessing a Web site.

Protecting your WLAN

Because the WLAN standard was designed with only limited security capabilities—basically to foil casual eavesdropping rather than more powerful forms of attack—it is essential to understand that WLANs are vulnerable to well-known and well-documented security weaknesses.

WLANs in public areas, or “hotspots,” like coffee shops and airports may not provide any security. New technologies are being developed by wireless manufacturers and hotspot service providers that make the public environment more secure and anonymous. If you are concerned about the security of your computer in a hotspot, limit your network activities to noncritical e-mail and basic Internet surfing.

When you set up a WLAN or access an existing WLAN, always enable security features to protect your network from unauthorized access. The common security levels are Wi-Fi Protected Access (WPA)-Personal and Wired Equivalent Privacy (WEP). Because wireless radio signals travel outside the network, other WLAN devices can pick up unprotected signals and either connect to your network (uninvited) or capture information being sent across it. However, you can take precautions to protect your WLAN:

- **Use a wireless transmitter with built-in security**

Many wireless base stations, gateways, or routers provide built-in security features such as wireless security protocols and firewalls. With the correct wireless transmitter, you can protect your network from the most common wireless security risks.

- **Work behind a firewall**

A firewall is a barrier that checks both data and requests for data that are sent to your network, and discards any suspicious items. Firewalls are available in many varieties, both software and hardware. Some networks use a combination of both types.

- **Use wireless encryption**

A variety of sophisticated encryption protocols is available for your WLAN. Find the solution that works best for your network security:

- **Wired Equivalent Privacy (WEP)** is a wireless security protocol that encodes or encrypts all network data before it is transmitted using a WEP key. Usually, you can allow the network to assign the WEP key. Alternatively, you can set up your own key, generate a different key, or choose other advanced options. Without the correct key, others will not be able to use the WLAN.
- **WPA (Wi-Fi Protected Access)**, like WEP, uses security settings to encrypt and decrypt data that is transmitted over the network. However, instead of using one static security key for encryptions as WEP does, WPA uses “temporal key integrity protocol” (TKIP) to dynamically generate a new key for every packet. It also generates different sets of keys for each computer on the network.

Roaming to another network

When you move your computer within range of another WLAN, Windows attempts to connect to that network. If the attempt is successful, your computer is automatically connected to the new network. If Windows does not recognize the new network, follow the same procedure you used initially to connect to your WLAN.

Using HP Mobile Broadband

HP Mobile Broadband enables your computer to use wireless wide area networks (WWANs) to access the Internet from more places and over larger areas than it can by using WLANs. Using HP Mobile Broadband requires a network service provider (called a *mobile network operator*), which in most cases

is a mobile phone network operator. Coverage for HP Mobile Broadband is similar to mobile phone voice coverage.

When used with mobile network operator service, HP Mobile Broadband gives you the freedom to stay connected to the Internet, send e-mail, or connect to your corporate network whether you are on the road or outside the range of Wi-Fi hotspots.

HP Mobile Broadband supports the following technologies:

- HSPA (High Speed Packet Access), which provides access to networks based on the Global System for Mobile Communications (GSM) telecommunications standard.
- EV-DO (Evolution Data Optimized), which provides access to networks based on the code division multiple access (CDMA) telecommunications standard.

You may need the HP Mobile Broadband Module serial number to activate mobile broadband service. The serial number is printed on a label inside the battery bay of your computer.

Some mobile network operators require the use of a subscriber identity module (SIM). A SIM contains basic information about you, such as a personal identification number (PIN), as well as network information. Some computers include a SIM that is preinstalled in the battery bay. If the SIM is not preinstalled, it may be provided in the HP Mobile Broadband information provided with your computer, or the mobile network operator may provide it separately from the computer.

For information on inserting and removing the SIM, refer to the “Inserting a SIM” and “Removing a SIM” sections in this chapter.

For information on HP Mobile Broadband and how to activate service with a preferred mobile network operator, refer to the HP Mobile Broadband information included with your computer. For additional information, see the HP Web site at <http://www.hp.com/go/mobilebroadband> (US only).

Inserting a SIM

△ **CAUTION:** To prevent damage to the connectors, use minimal force when inserting a SIM.

To insert a SIM:

1. Shut down the computer. If you are not sure whether the computer is off or in Hibernation, turn the computer on by sliding the power switch. Then shut down the computer through the operating system.
2. Close the display.
3. Disconnect all external devices connected to the computer.
4. Unplug the power cord from the AC outlet.
5. Turn the computer upside down on a flat surface, with the battery bay toward you.
6. Remove the battery.

Verify that the SIM inserting and removal procedures are correct for Luke

7. Insert the SIM into the SIM slot, and gently push the SIM into the slot until it is firmly seated.

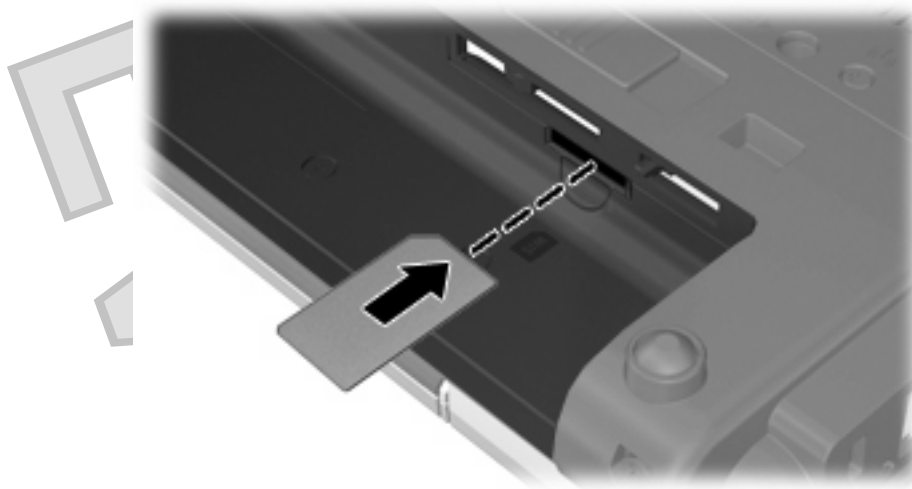

8. Replace the battery.

 **NOTE:** HP Mobile Broadband will be disabled if the battery is not replaced.

9. Reconnect external power.
10. Reconnect external devices.
11. Turn on the computer.

Removing a SIM

To remove a SIM:

1. Shut down the computer. If you are not sure whether the computer is off or in Hibernation, turn the computer on by sliding the power switch. Then shut down the computer through the operating system.
2. Close the display.
3. Disconnect all external devices connected to the computer.
4. Unplug the power cord from the AC outlet.
5. Turn the computer upside down on a flat surface, with the battery bay toward you.
6. Remove the battery.

7. Press in on the SIM (1), and then remove it from the slot (2).

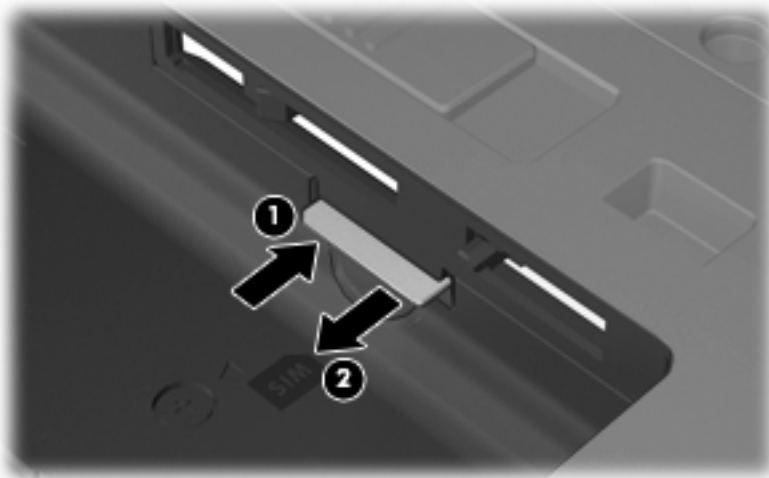

8. Replace the battery.
9. Reconnect external power.
10. Reconnect external devices.
11. Turn on the computer.

Using Bluetooth wireless devices

A Bluetooth device provides short-range wireless communications that replace the physical cable connections that traditionally link electronic devices such as the following:

- Computers (desktop, notebook, PDA)
- Phones (cellular, cordless, smart phone)
- Imaging devices (printer, camera)
- Audio devices (headset, speakers)

Bluetooth devices provide peer-to-peer capability that allows you to set up a personal area network (PAN) of Bluetooth devices. For information on configuring and using Bluetooth devices, refer to the Bluetooth software Help.

Bluetooth and Internet Connection Sharing (ICS)

HP does **not** recommend setting up one computer with Bluetooth as a host and using it as a gateway through which other computers may connect to the Internet. When two or more computers are connected using Bluetooth, and Internet Connection Sharing (ICS) is enabled on one of the computers, the other computers may not be able to connect to the Internet using the Bluetooth network.

The strength of Bluetooth is in synchronizing information transfers between your computer and wireless devices including cellular phones, printers, cameras, and PDAs. The inability to consistently connect two or more computers to share the Internet through Bluetooth is a limitation of Bluetooth and the Windows operating system.

Connecting to a wired network

Connecting to a local area network (LAN) requires an 8-pin, RJ-45 network cable (purchased separately). If the network cable contains noise suppression circuitry (1), which prevents interference from TV and radio reception, orient the circuitry end of the cable (2) toward the computer.



To connect to a LAN:

1. Plug the network cable into the network jack (1) on the computer.
2. Plug the other end of the network cable into a network wall jack (2).

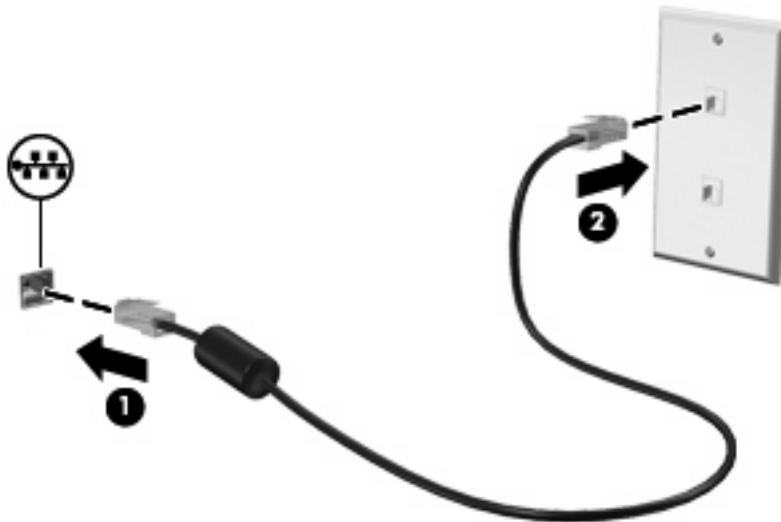

⚠ WARNING! To reduce the risk of electric shock, fire, or damage to the equipment, do not plug a modem cable or telephone cable into an RJ-45 (network) jack.

6 Pointing devices and keyboard

Using pointing devices

 **NOTE:** In addition to the TouchPad, you can also connect an external USB mouse to one of the USB ports on the computer.

Setting pointing device preferences

Use Mouse Properties in Windows® to customize settings for pointing devices, such as button configuration, click speed, and pointer options.

To access Mouse Properties, select **Start > Devices and Printers**. Then, right-click the device representing your computer, and select **Mouse settings**.

Using the TouchPad

To move the pointer, touch and slide one finger across the TouchPad surface in the direction you want the pointer to go. Use the left and right TouchPad buttons like the corresponding buttons on an external mouse.

 **NOTE:** For information on identifying the TouchPad components, refer to [TouchPad on page 8](#).

Using TouchPad gestures Review to ensure that the TouchPad gesture text and illustrations are correct for Luke

The TouchPad supports a variety of TouchPad gestures. To activate the TouchPad gestures, place two fingers on the TouchPad at the same time as described in the following sections.

The TouchPad gestures described in this section are enabled at the factory. To disable or reenab these gestures:

1. Double-click on the **Synaptics** icon in the notification area, at the far right of the taskbar, and then click the **Device Settings** tab.
2. Select the device, and then click **Settings**.
3. Select the checkbox to disable or reenab the TouchPad gesture.
4. Click **Apply**, and then click **OK**.

 **NOTE:** Your computer also supports additional TouchPad features that are disabled at the factory. To view and enable these features, click the **Synaptics** icon in the notification area, at the far right of the taskbar, and then click the **Device Settings** tab. Select the device, and then click **Settings**.

Scrolling

Scrolling is useful for moving up or down on a page or image. To scroll, place two fingers slightly apart on the TouchPad and drag them across the TouchPad in an up, down, left, or right motion.

 **NOTE:** Scrolling speed is controlled by finger speed.

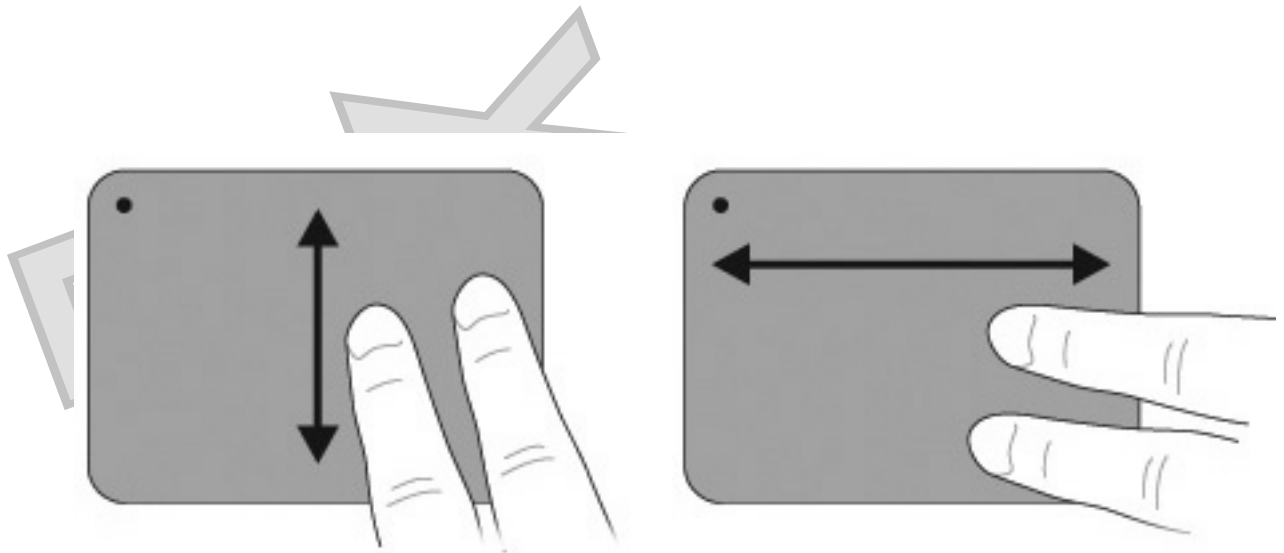

Pinching

Pinching allows you to zoom in or out on items such as PDFs, images, and photos.

To pinch:

- Zoom in by holding two fingers together on the TouchPad, and then pull the fingers apart to increase an object's size.
- Zoom out by holding two fingers apart on the TouchPad, and then pull the fingers together to decrease an object's size.

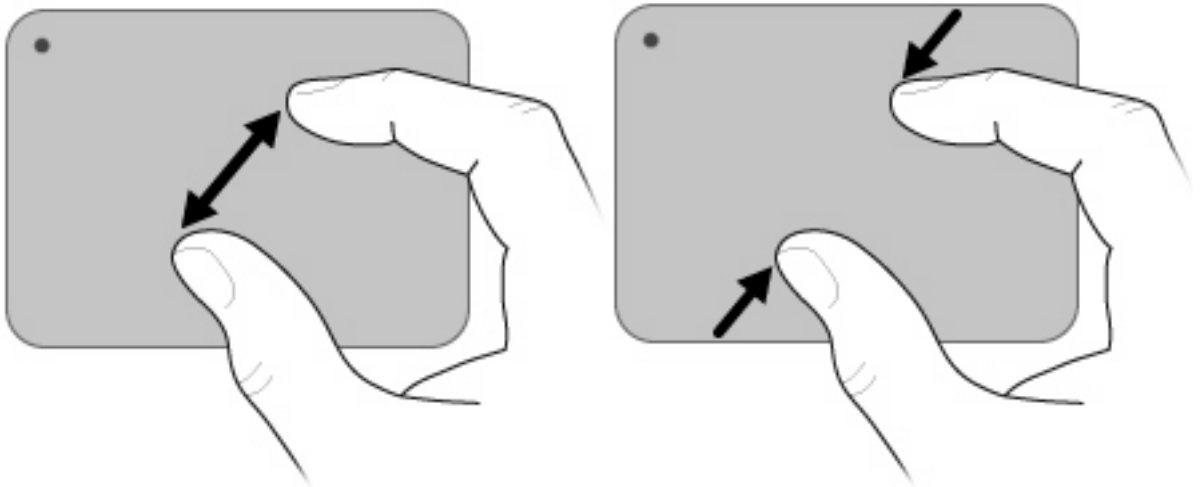

Rotating

Rotating allows you rotate items such as photos and pages. To rotate, move your thumb and forefinger in a circular motion on the TouchPad.

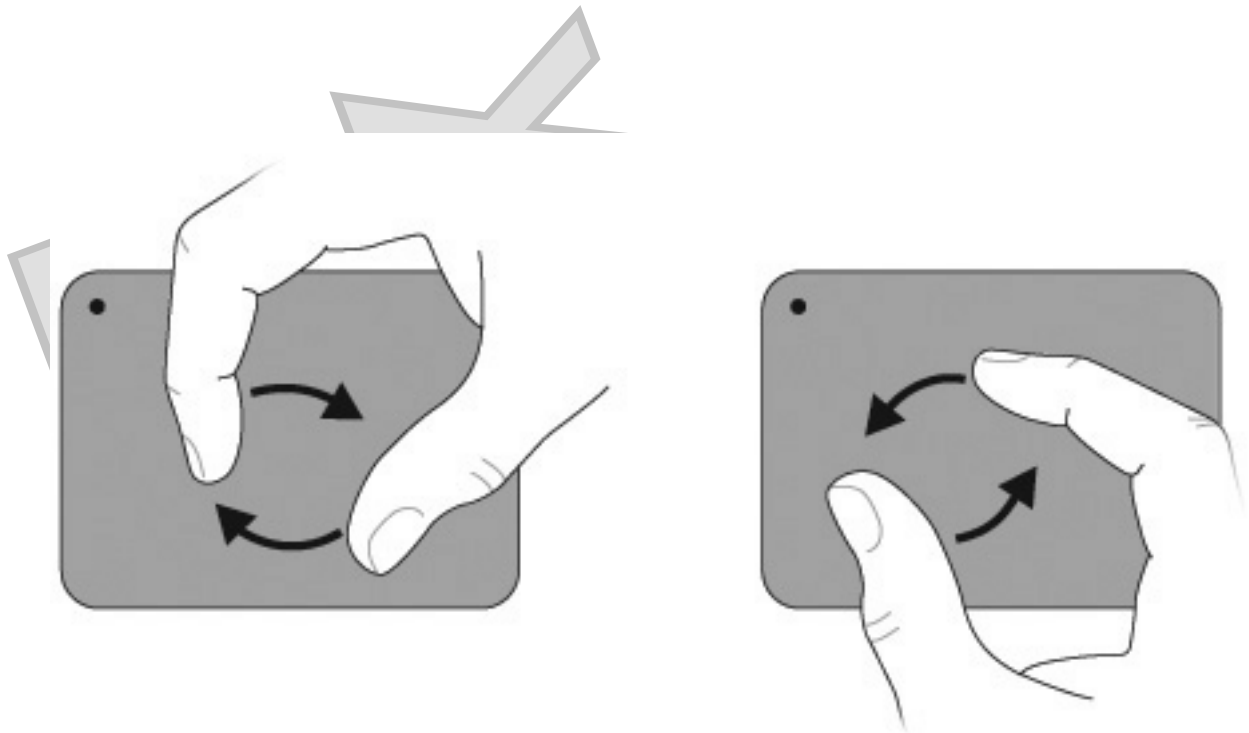

Using the digitizer pen

You can write with the pen in pen-specific programs such as Tablet PC Input Panel, in all Microsoft® Office applications, and in most other Windows programs and utilities. The information you write on the screen with the pen can be filed, searched, and shared among most Windows programs.

Identifying the pen components

The pen interacts with the computer whenever the tip (**1**) of the pen is pressed against the screen.

The pen tether eyelet (**2**) allows you to connect a tether from the pen to the pen tether hole on the computer.



Holding the pen

Hold the pen as if you were writing with a standard pen or pencil.

Storing the pen

To store the pen when you are not using it, insert the pen, tip first, into the pen holder on the computer.



Review to ensure the touch screen text and illustrations are correct for Luke

Using the touch screen

The computer allows you to use your fingers or the digitizer pen to perform certain actions on the touch screen.

 **NOTE:** The instructions in this section are based on the preferences set at the factory. To modify settings for recognized clicks and flicks, select **Start > Control Panel > Hardware and Sound > Pen and Touch**.

NOTE: All movements may not be supported in all programs.

Tapping (or clicking)

Tap or double-tap an item on the screen as you would click or double-click with the TouchPad or an external mouse. Tap and hold an item to see the context menu as you would with the right TouchPad button.

 **NOTE:** You must tap and hold your finger until the operating system draws a circle around the area you are touching, and then the context menu appears.

Flicking

Touch the screen in a light, quick flicking motion up, down, left, or right to navigate through screens or quickly scroll through documents.

 **NOTE:** For the flick movement to work, a scrollbar must be present and in the active window.

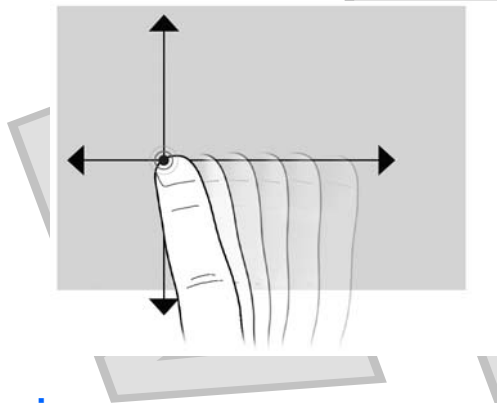

Dragging

Press your finger on an item on the screen and then move your finger to drag an item to a new location. You can also use this motion to slowly scroll through documents.

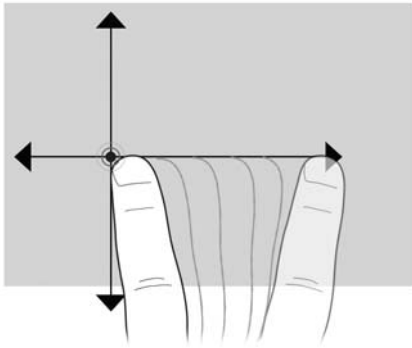

Scrolling

Scrolling is useful for moving up or down on a page or image. To scroll, place two fingers on the screen, and then drag them across the screen in an up, down, left, or right motion.

 **NOTE:** Scrolling speed is controlled by finger speed.

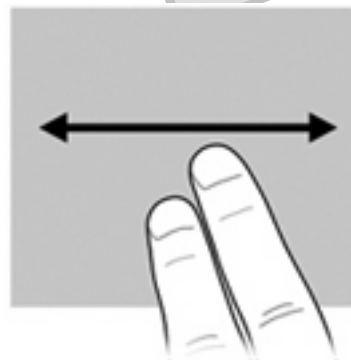
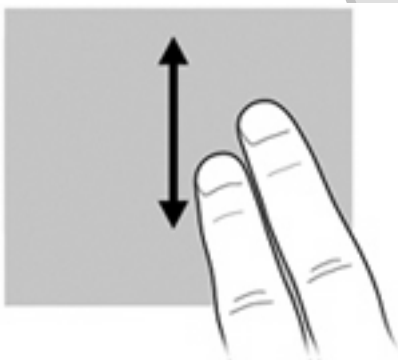

Rotating

Rotating allows you rotate items such as photos and pages. To rotate, anchor your thumb on the screen, and then move your forefinger in a semicircular motion around your thumb.

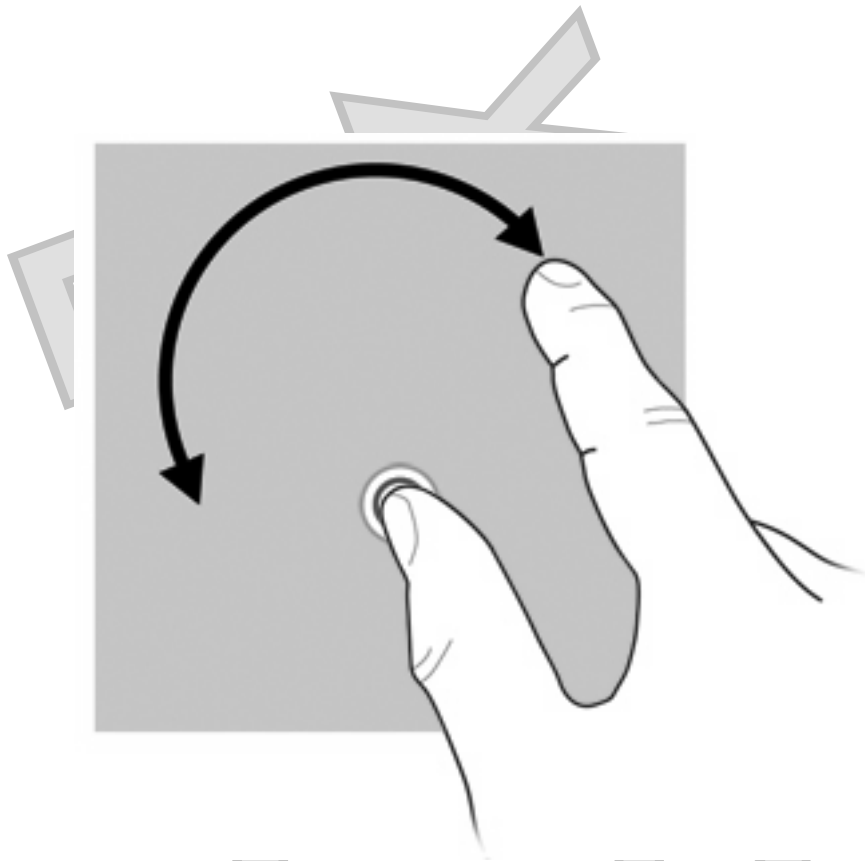

Pinching

Pinching allows you to zoom in or out on items such as PDFs, images, and photos.

To pinch:

- Zoom out by holding two fingers apart on the screen, and then pull the fingers together to decrease an object's size.
- Zoom in by holding two fingers together on the screen, and then pull the fingers apart to increase an object's size.

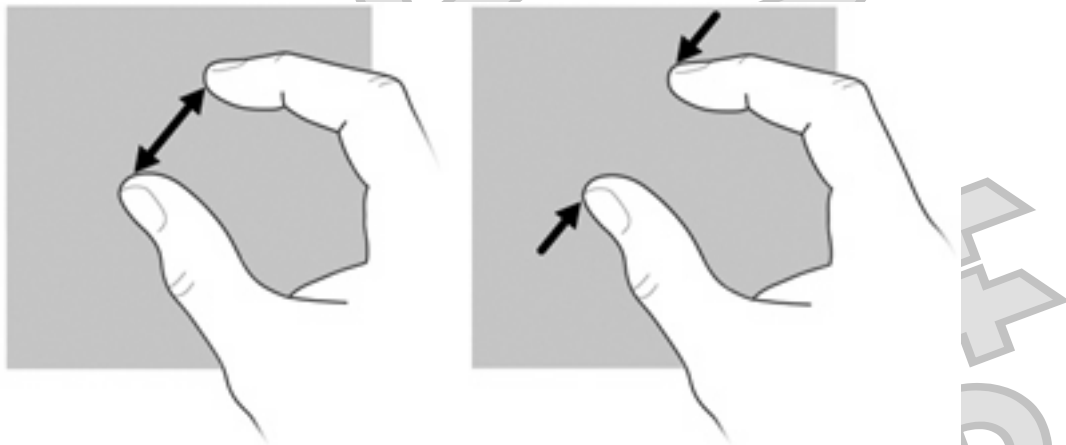

Setting touch screen preferences

- To set preferences for visual feedback, select **Start > Control Panel > Hardware and Sound > Pen and Touch**. These preferences are specific to the touch screen and the computer.
- To set preferences for left-handed or right-handed users, select **Start > Control Panel > Hardware and Sound > Tablet PC Settings > Other** tab. These preferences are specific to the touch screen and the computer.
- To set pointing device preferences such as pointer speed, click speed, and mouse trails, select **Start > Devices and Printers**. Then, right-click the device representing your computer, and select **Mouse settings**. These preferences apply to any pointing device in the system.

To change or test click settings:

1. Select **Start > Control Panel > Hardware and Sound > Pen and Touch > Pen Options** tab.
2. Under **Pen Actions**, select the action, and then click **Settings**.
3. After making any changes or testing the settings, click **OK**.

To change or create flick assignments:

1. Select **Start > Control Panel > Hardware and Sound > Pen and Touch > Flicks** tab.
2. Click **Navigational flicks and editing flicks**, and then click **Customize**.
3. Follow the on-screen instructions to change or create a flick assignment.
4. Click **OK**.

Using the action keys

Action keys are customized actions that are assigned to specific keys at the top of the keyboard.













To use an action key, press and hold this key to activate the assigned .

 **NOTE:** Depending on the application you are using, pressing **fn** and one of the action keys will open a specific shortcut menu within that application.

NOTE: The action key feature is enabled at the factory. You can disable this feature in Setup Utility (BIOS) and revert back to pressing the **fn** key and one of the action keys to activate the assigned . Refer to [Setup Utility \(BIOS\) on page 77](#) for additional information.



Icon	Action	Description
	Help and Support	Opens Help and Support, which provides information about your Windows operating system and computer, answers to questions and tutorials, and updates to your computer. Help and Support also provides automated troubleshooting and links to support specialists.

Icon	Action	Description
	Screen brightness down	Decreases the screen brightness level incrementally when you hold down this key.
	Screen brightness up	Increases the screen brightness level incrementally when you hold down this key.
	Switch screen image	<p>Switches the screen image among display devices connected to the system. For example, if a monitor is connected to the computer, pressing this key alternates the screen image from computer display to monitor display to simultaneous display on both the computer and the monitor.</p> <p>Most external monitors receive video information from the computer using the external VGA video standard. The switch screen image key can also alternate images among other devices that are receiving video information from the computer.</p>
	Previous track	Plays the previous track of an audio CD or the previous section of a DVD or a BD.
	Play/Pause	<p>Plays, pauses, or resumes an audio CD, a DVD, or a BD.</p> <ul style="list-style-type: none"> • If an audio CD, a DVD, or a BD is not playing, press this key to begin or resume the play. • If an audio CD, a DVD, or a BD is playing, press this key to pause the play.
	Stop	Stops audio or video playback of a CD, a DVD, or a BD.
	Next track	Plays the next track of an audio CD or the next section of a DVD or a BD.
	Volume down	Decreases speaker sound incrementally when you hold down this key.
	Volume up	Increases speaker sound incrementally when you hold down this key.
	Mute	Mutes or restores speaker sound.
	Wireless	<p>Turns the wireless feature on or off.</p> <p>NOTE: This key does not establish a wireless connection. To establish a wireless connection, a wireless network must be set up.</p>
	Print screen	Takes a snapshot or picture of your computer screen and copies it to the clipboard.

Using the hotkeys

Hotkeys are combinations of the **fn** key (1) and either the **esc** key (3) or one of the arrow keys (4).

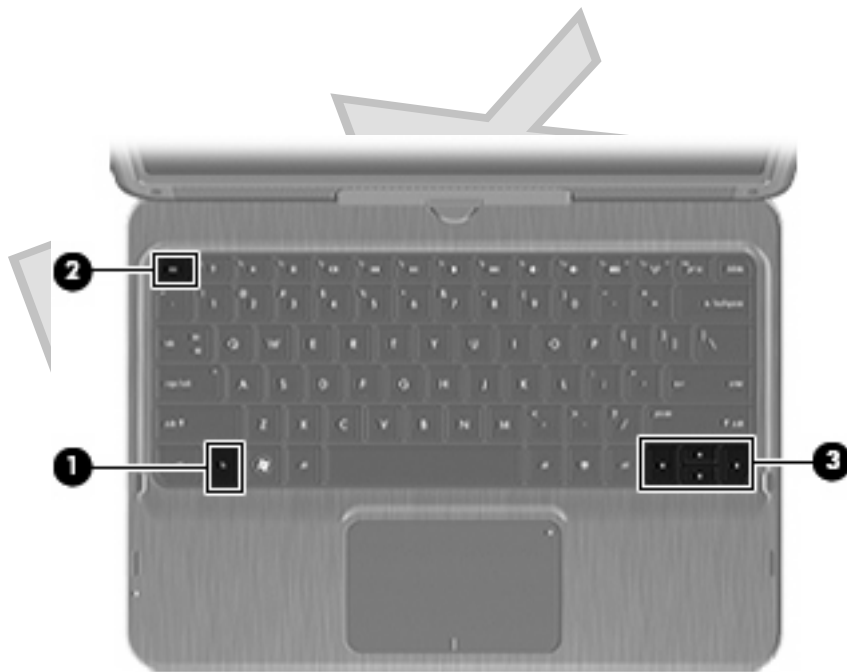

	Hotkey	Description
	<code>fn+esc</code>	Displays information about system hardware components and the system BIOS version number.
▲	<code>fn+up arrow</code>	Scrolls the page up.
▼	<code>fn+down arrow</code>	Scrolls the page down.
◀	<code>fn+left arrow</code>	Returns the cursor to the beginning of the line where the cursor is located or returns to the beginning of the document.
▶	<code>fn+right arrow</code>	Places the cursor at the end of the line or scrolls to the end of the document.

To use a hotkey command, follow either of these steps:

- Briefly press the `fn` key, and then briefly press the second key of the hotkey command.
– or –
- Press and hold down the `fn` key, briefly press the second key of the hotkey command, and then release both keys at the same time.

7 Multimedia

Your computer includes multimedia features that allow you to listen to music, watch movies, and view pictures. Your computer may include the following multimedia components:

- Integrated speakers for listening to music
- Integrated microphones for recording your own audio
- Integrated webcam that allows you to capture and share video
- Preinstalled multimedia software that allows you to play and manage your music, movies, and pictures
- Multimedia keys that provide fast access to multimedia tasks

The following sections explain how to use the multimedia components included with your computer.

Using the media activity keys

The media activity keys control the play of an audio CD or a DVD or BD that is inserted into an external optical drive (purchased separately).

- When an audio CD or a DVD is not playing, press the [play/pause](#) key **(2)** to play the disc.
- When an audio CD or a DVD is playing, use the following keys:
 - To play the previous track of an audio CD or the previous chapter of a DVD, press the [previous track](#) key **(1)**.
 - To pause or resume playing the disc, press [play/pause](#) key **(2)**.
 - To stop the disc, press the [stop](#) key **(3)**.
 - To play the next track of an audio CD or the next chapter of a DVD, press the [next track](#) key **(4)**.

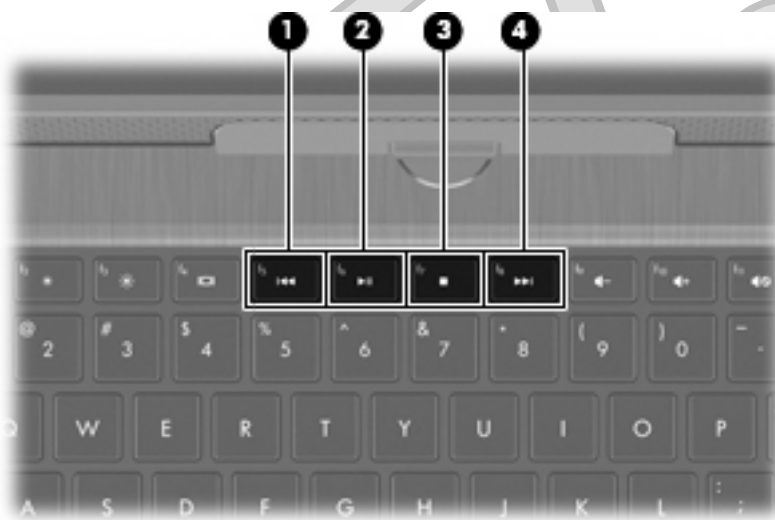

Installing multimedia software from a disc

Although your computer does not have an integrated optical drive, you can easily access software, install applications, and access data in either of the following ways:

- Connect an external optical drive (select models only or purchased separately) to one of the USB ports on your computer.

 **NOTE:** For additional information on external optical drives, refer to [Using external drives on page 60](#).

- Share the optical drive that is connected to another computer on your network.

 **NOTE:** You must have a network set up in order to share an optical drive. For additional information on sharing optical drives, refer to [Sharing an optical drive on page 61](#).

NOTE: Some discs, such as DVD movies and game discs, may be copy-protected and therefore unusable through DVD or CD sharing.

Audio

Your computer enables you to use a variety of audio features:

- Play music using your computer speakers and/or connected external speakers
- Record sound using the internal microphone or connect an external microphone
- Download music from the Internet
- Create multimedia presentations using audio and images
- Transmit sound and images with instant messaging programs
- Stream radio programs
- Create (burn) audio CDs with an optional optical drive

Adjusting the volume

You can adjust the volume using the computer volume keys.

- To decrease volume, press the [volume down](#) key (1).
- To increase volume, press the [volume up](#) key (2).
- To mute or restore volume, press the [mute](#) key (3).

- **Gamma**—Controls the contrast affecting the mid-level grays or midtones of an image. Adjusting the gamma of an image allows you to change the brightness values of the middle range of gray tones without dramatically altering the shadows and highlights. A lower gamma setting makes grays look black, and makes dark colors even darker.
- **Backlight Comp**—Compensates in cases where a subject with a large amount of background light would otherwise be obscured by blooming or silhouetting.

For more information about using the webcam, select **Start > Help and Support**.

Video

Your computer enables you to use a variety of video features:

- Watch movies
- Play games over the Internet
- Edit pictures and video and create presentations
- Connect external video devices
- Watch TV over the Internet

Using the external monitor port

The external monitor port connects an external display device, such as an external monitor or a projector, to the computer.

- To connect a display device, connect the device cable to the external monitor port.

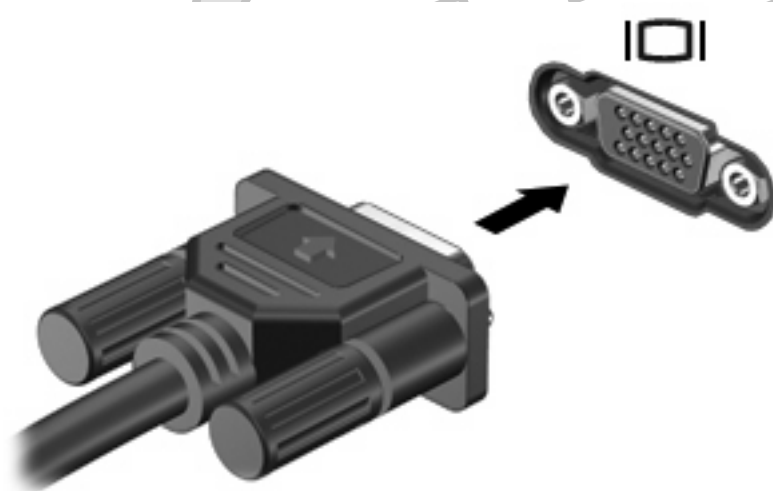

NOTE: If a properly connected external display device does not display an image, press the **switch screen image** key to transfer the image to the device. Repeatedly pressing this key alternates the screen image between the computer display and the device.

Connecting an HDMI device

The computer includes an HDMI (High Definition Multimedia Interface) port. The HDMI port connects the computer to an optional video or audio device, such as a high-definition television, or any compatible digital or audio component.

 **NOTE:** To transmit video signals through the HDMI port, you need an HDMI cable (purchased separately).

The computer can support one HDMI device connected to the HDMI port, while simultaneously supporting an image on the computer display or any other supported external display.

To connect a video or audio device to the HDMI port:

1. Connect one end of the HDMI cable to the HDMI port on the computer.

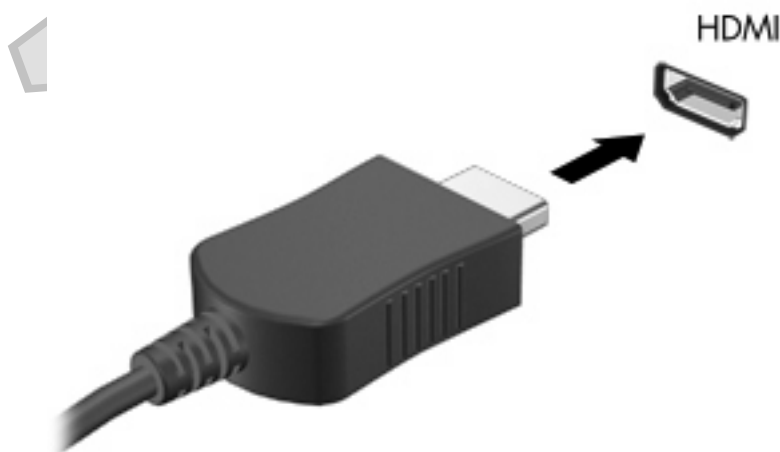

2. Connect the other end of the cable to the video device, according to the device manufacturer's instructions.
3. Press the [switch screen image](#) key on the computer to switch the image between the display devices connected to the computer.

Configuring audio for HDMI

To configure HDMI audio, first connect an audio or video device, such as a high-definition TV, to the HDMI port on your computer. Then configure the default audio playback device as follows:

1. Right-click the **Speakers** icon in the notification area, at the far right of the taskbar, and then click **Playback devices**.
2. On the **Playback** tab, click either **Digital Output** or **Digital Output Device (HDMI)**.
3. Click **Set Default**, and then click **OK**.

To return audio to the computer speakers, follow these steps:

1. Right-click the **Speakers** icon in the notification area, at the far right of the taskbar, and then click **Playback devices**.
2. On the **Playback** tab, click **Speakers**.
3. Click **Set Default**, and then click **OK**.

8 Power management

Shutting down the computer

△ **CAUTION:** Unsaved information will be lost when the computer is shut down.

The Shut down command closes all open programs, including the operating system, and then turns off the display and computer.

Shut down the computer under any of the following conditions:

- When you need to replace the battery or access components inside the computer
- When you are connecting an external hardware device that does not connect to a USB port
- When the computer will be unused and disconnected from external power for an extended period

Although you can shut down the computer with the power switch, the recommended procedure is to use the Windows Shut down command.

To shut down the computer:

📝 **NOTE:** If the computer is in the Sleep state or in Hibernation, you must first exit Sleep or Hibernation before shutdown is possible.

1. Save your work and close all open programs.
2. Click **Start**.
3. Click **Shut down**.

If the computer is unresponsive and you are unable to use the preceding shutdown procedures, try the following emergency procedures in the sequence provided:

- Press **ctrl+alt+delete**, and then click the **Power** button.
- Slide and hold the power switch for at least 5 seconds.
- Disconnect the computer from external power and remove the battery.

Setting power devices

Using power-saving states

The computer has two power-saving states enabled at the factory: Sleep and Hibernation.

When Sleep is initiated, the power light blinks and the screen clears. Your work is saved to memory, letting you exit Sleep faster than exiting Hibernation. If the computer is in the Sleep state for an extended period or if the battery reaches a critical battery level while in the Sleep state, the computer initiates Hibernation.

When Hibernation is initiated, your work is saved to a hibernation file on the hard drive and the computer turns off.

△ **CAUTION:** To prevent possible audio and video degradation, loss of audio or video playback functionality, or loss of information, do not initiate Sleep or Hibernation while reading from or writing to a disc or an external media card.

📝 **NOTE:** You cannot initiate any type of networking connection or perform any computer functions while the computer is in the Sleep state or in Hibernation.

Initiating and exiting Sleep

The system is set at the factory to initiate Sleep after 15 minutes of inactivity when running on battery power and 30 minutes of inactivity when running on external power.

Power settings and timeouts can be changed using Power Options in Windows® Control Panel.

With the computer on, you can initiate Sleep in any of the following ways:

- Briefly slide the power switch.
- Close the display.
- Click **Start**, click the arrow next to the Shut down button, and then click **Sleep**.

You can exit Sleep in any of the following ways:

- Briefly slide the power switch.
- If the display is closed, open the display.
- Press a key on the keyboard.
- Activate the TouchPad.

When the computer exits Sleep, the power light turns on and your work returns to the screen where you stopped working.

📝 **NOTE:** If you have set a password to be required on wakeup, you must enter your Windows password before your work will return to the screen.

Initiating and exiting Hibernation

The system is set at the factory to initiate Hibernation after 1,080 minutes (18 hours) of inactivity when running on battery power, 1,080 minutes (18 hours) of inactivity when running on external power, or when the battery reaches a critical battery level.

Power settings and timeouts can be changed using Power Options in Windows Control Panel.

To initiate Hibernation:

- Click **Start**, click the arrow next to the Shut down button, and then click **Hibernate**.

To exit Hibernation:

- Briefly slide the power switch.

The power light turns on and your work returns to the screen where you stopped working.

📝 **NOTE:** If you have set a password to be required on wakeup, you must enter your Windows password before your work will return to the screen.

Conserving power

- Select the Power saver power plan through Power Options under **System and Security** in Windows Control Panel.
- Turn off wireless and local area network (LAN) connections and exit modem applications when you are not using them.
- Disconnect external devices that are not plugged into an external power source, when you are not using them.
- Stop, disable, or remove any external media cards that you are not using.
- Use the screen brightness keys to adjust screen brightness as needed.
- If you leave your work, initiate Sleep or Hibernation, or shut down the computer.

Using the battery meter

The battery meter is located in the notification area, at the far right of the taskbar. The battery meter allows you to quickly access power settings, view remaining battery charge, and select a different power plan.

- To display the percentage of remaining battery charge and the current power plan, move the pointer over the battery meter icon.
- To access Power Options, or to change the power plan, click the battery meter icon and select an item from the list.

Different battery meter icons indicate whether the computer is running on battery or external power. The icon also displays a message if the battery has reached a low battery level, critical battery level, or reserve battery level.

To hide or display the battery meter icon:

1. Right-click the **Show hidden icons** icon (the arrow at the left side of the notification area).
2. Click **Customize notification icons**.
3. Under **Behaviors**, select **Show icon and notifications** for the Power icon.
4. Click **OK**.

Using power plans

A power plan is a collection of system settings that manages how the computer uses power. Power plans can help you conserve power or maximize performance.

You can change power plan settings or create your own power plan.

Viewing the current power plan

- Click the battery meter icon in the notification area, at the far right of the taskbar.

– or –

Select **Start > Control Panel > System and Security > Power Options**.

Selecting a different power plan

- Click the battery meter icon in the notification area, and then select a power plan from the list.

– or –

Select **Start > Control Panel > System and Security > Power Options**, and then select a power plan from the list.

Customizing power plans

1. Click the battery meter icon in the notification area and then click **More power options**.

– or –

Select **Start > Control Panel > System and Security > Power Options**.

2. Select a power plan, and then click **Change plan settings**.
3. Change the settings as needed.
4. To change additional settings, click **Change advanced power settings** and make your changes.

Setting password protection on wakeup

To set the computer to prompt for a password when the computer exits Sleep or Hibernation, follow these steps:

1. Select **Start > Control Panel > System and Security > Power Options**.
2. In the left pane, click **Require a password on wakeup**.
3. Click **Change Settings that are currently unavailable**.
4. Click **Require a password (recommended)**.

 **NOTE:** If you need to create a user account password or change your current user account password, click **Create or change your user account password**, and then follow the on-screen instructions. If you do not need to create or change a user account password, go to step 5.

5. Click **Save changes**.

Using battery power

When a charged battery is in the computer and the computer is not plugged into external power, the computer runs on battery power. When the computer is plugged into external AC power, the computer runs on AC power.

If the computer contains a charged battery and is running on external AC power supplied through the AC adapter, the computer switches to battery power if the AC adapter is disconnected from the computer.

 **NOTE:** The display brightness is decreased to save battery life when you disconnect AC power. To increase display brightness, press the [increase screen brightness](#) key or reconnect the AC adapter.

You can keep a battery in the computer or in storage, depending on how you work. Keeping the battery in the computer whenever the computer is plugged into AC power charges the battery and also protects your work in case of a power outage. However, a battery in the computer slowly discharges when the computer is off and unplugged from external power.

 **WARNING!** To reduce potential safety issues, use only the battery provided with the computer, a replacement battery provided by HP, or a compatible battery purchased from HP.

Computer battery life varies, depending on power management settings, programs running on the computer, display brightness, external devices connected to the computer, and other factors.

Finding battery information in Help and Support

Help and Support provides the following tools and information about the battery:

- Battery Check tool to test battery performance
- Information on calibration, power management, and proper care and storage to maximize battery life
- Information on battery types, specifications, life cycles, and capacity

To access battery information:

- Select **Start > Help and Support > Learn > Power Plans: Frequently Asked Questions**.

Using Battery Check

Battery Check in Help and Support provides information on the status of the battery installed in the computer.

To run Battery Check:

1. Connect the AC adapter to the computer.
 **NOTE:** The computer must be connected to external power for Battery Check to properly.
2. Select **Start > Help and Support > Troubleshoot > Power, Thermal and Mechanical**.
3. Click the **Power** tab, and then click **Battery Check**.

Battery Check examines the battery and its cells to see if they are functioning properly, and then reports the results of the examination.

Displaying the remaining battery charge

- Move the pointer over the battery meter icon in the notification area, at the far right of the taskbar.

Removing or inserting the battery

-  **CAUTION:** Removing a battery that is the sole power source can cause loss of information. To prevent loss of information, initiate Hibernation or shut down the computer through Windows before removing the battery.

To remove the battery:

1. Close the display and turn the computer upside down on a flat surface.
2. Slide the battery release latch **(1)** to release the battery.

-  **NOTE:** The battery release latch automatically returns to its original position.

3. Pivot the battery (2) upward and remove it from the computer (3).

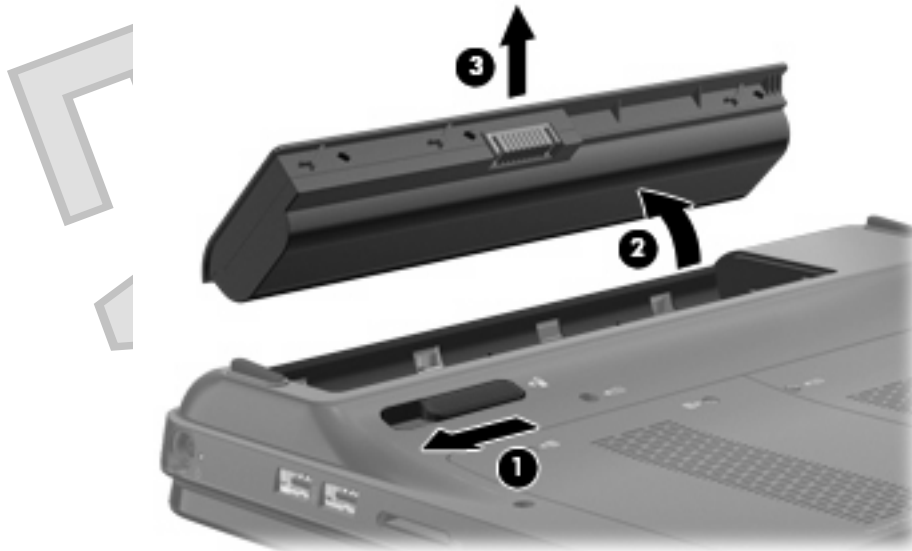

To insert the battery:

1. Close the display and turn the computer upside down on a flat surface.
2. Align the tabs on the battery with the notches on the outer edge of the battery bay (1) and rotate the battery into the battery bay until it is seated (2).
3. The battery release latch (3) automatically locks the battery into place.

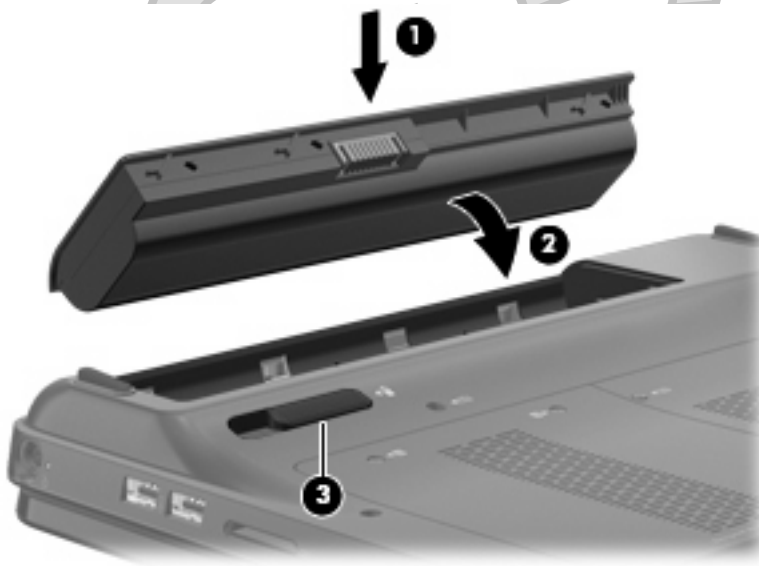

Charging a battery

- ⚠ **WARNING!** Do not charge the computer battery while you are onboard aircraft.

The battery charges whenever the computer is plugged into external power through an AC adapter or an optional power adapter.

The battery charges whether the computer is off or in use, but it charges faster when the computer is off.

Charging may take longer if a battery is new, has been unused for 2 weeks or more, or is much warmer or cooler than room temperature.

To prolong battery life and optimize the accuracy of battery charge displays, follow these recommendations:

- If you are charging a new battery, charge it fully before turning on the computer.
- Charge the battery until the battery light turns white.

 **NOTE:** If the computer is on while the battery is charging, the battery meter in the notification area may show 100 percent charge before the battery is fully charged.

- Allow the battery to discharge below 5 percent of a full charge through normal use before charging it.
- If the battery has been unused for one month or more, calibrate the battery instead of simply charging it.

Maximizing battery discharge time

Battery discharge time varies depending on the features you use while on battery power. Maximum discharge time gradually shortens, as the battery storage capacity naturally degrades.

Tips for maximizing battery discharge time:

- Lower the brightness on the display.
- Check the **Power saver** setting in Power Options.
- Remove the battery from the computer when it is not being used or charged.
- Store the battery in a cool, dry location.

Managing low battery levels

The information in this section describes the alerts and system responses set at the factory. Some low-battery alerts and system responses can be changed using Power Options in Windows Control Panel. Preferences set using Power Options do not affect lights.

Identifying low battery levels

When a battery that is the sole power source for the computer reaches a low or critical battery level, the battery meter icon in the notification area shows a low or critical battery notification.

When the battery reaches a critical battery level, a notification appears above the battery meter icon that shows how much battery charge remains.

 **NOTE:** For additional information on the battery meter, refer to [Using the battery meter on page 44](#).

The computer takes the following actions for a critical battery level:

- If Hibernation is enabled and the computer is on or in the Sleep state, the computer initiates Hibernation.
- If Hibernation is disabled and the computer is on or in the Sleep state, the computer remains briefly in the Sleep state, and then shuts down and loses any unsaved information.

Resolving a low battery level

- △ **CAUTION:** To reduce the risk of losing information when the computer reaches a critical battery level and has initiated Hibernation, do not restore power until the power light turns off.

Resolving a low battery level when external power is available

- Connect one of the following devices:
 - AC adapter
 - Optional power adapter purchased as an accessory from HP.

Resolving a low battery level when a charged battery is available

1. Turn off the computer or initiate Hibernation.
2. Remove the discharged battery, and then insert a charged battery.
3. Turn on the computer.

Resolving a low battery level when no power source is available

- Initiate Hibernation.
– or –
Save your work and shut down the computer.

Resolving a low battery level when the computer cannot exit Hibernation

When the computer lacks sufficient power to exit Hibernation, follow these steps:

1. Insert a charged battery or plug the computer into external power.
2. Exit Hibernation by sliding the power switch.

Calibrating a battery

To maximize battery performance, you should calibrate a battery under the following conditions:

- When battery charge displays seem inaccurate
- When you observe a significant change in battery run time

Even if a battery is heavily used, it should not need to be calibrated more than once a month. It is also not necessary to calibrate a new battery.

- To calibrate a battery and for additional information, select **Start > Help and Support**.

Storing a battery

- △ **CAUTION:** To prevent damage to a battery, do not expose it to high temperatures for extended periods of time.

If a computer will be unused and unplugged from external power for more than 2 weeks, remove the battery and store it separately.

To prolong the charge of a stored battery, place it in a cool, dry place.

Calibrate a battery before using it if it has been stored for one month or more.

Disposing of a used battery

⚠ **WARNING!** To reduce the risk of fire or burns, do not disassemble, crush, or puncture; do not short external contacts; do not dispose of in fire or water.

Refer to the *Regulatory, Safety and Environmental Notices* for proper battery disposal.

Replacing the battery

Computer battery life varies, depending on power management settings, programs running on the computer, display brightness, external devices connected to the computer, and other factors.

Battery Check notifies you to replace the battery when an internal cell is not charging properly, or when the battery storage capacity has reached a "weak" condition. A message refers you to the HP Web site for more information about ordering a replacement battery. If the battery is possibly covered by an HP warranty, instructions include a warranty ID.

📄 **NOTE:** To ensure that you always have battery power when you need it, HP recommends purchasing a new battery when the storage capacity indicator turns green-yellow.

Using external AC power

External AC power is supplied through an approved AC adapter.

⚠ **WARNING!** To reduce potential safety issues, use only the AC adapter provided with the computer, a replacement AC adapter provided by HP, or a compatible AC adapter purchased from HP.

Connect the computer to external AC power under any of the following conditions:

- When you are charging or calibrating a battery

⚠ **WARNING!** Do not charge the computer battery while you are onboard aircraft.

- When you are installing or modifying system software
- When you are writing information to an optional external CD or DVD

When you connect the computer to external AC power, the following events occur:

- The battery begins to charge.
- If the computer is turned on, the battery meter icon in the notification area changes appearance.

When you disconnect external AC power, the following events occur:

- The computer switches to battery power.
- The display brightness is automatically decreased to save battery life. To increase display brightness, press the [increase screen brightness](#) key or reconnect the AC adapter.

Connecting AC power

⚠ **WARNING!** To reduce the risk of electric shock or damage to the equipment:

Plug the power cord into an AC outlet that is easily accessible at all times.

Disconnect power from the computer by unplugging the power cord from the AC outlet (not by unplugging the power cord from the computer).

If provided with a 3-pin attachment plug on the power cord, plug the cord into a grounded (earthed) 3-pin outlet. Do not disable the power cord grounding pin, for example, by attaching a 2-pin adapter. The grounding pin is an important safety feature.

To connect the computer to external AC power:

1. Plug the adapter into the power connector (1) on the computer.
2. Plug the power cord into the adapter (2).
3. Plug the other end of the power cord into an AC outlet (3).



Testing an AC adapter

Test the AC adapter if the computer exhibits any of the following symptoms when it is connected to AC power:

- The computer will not turn on.
- The display does not turn on.
- The power light is off.

To test the AC adapter:

1. Remove the battery from the computer.
2. Connect the AC adapter to the computer, and then plug it into an AC outlet.
3. Turn on the computer.
 - If the power light turns **on**, the AC adapter is working properly.
 - If the power light remains **off**, the AC adapter is not functioning and should be replaced.

Contact technical support for information on obtaining a replacement AC power adapter.

Removing a digital card

△ **CAUTION:** To prevent loss of data or an unresponsive system, use the following procedure to safely remove the digital card.

1. Save your information and close all programs associated with the digital card.

📝 **NOTE:** To stop a data transfer, click **Cancel** in the operating system Copying window.

2. To remove a digital card:

a. Click the **Safely Remove Hardware and Eject Media** icon in the notification area, at the far right of the taskbar.

📝 **NOTE:** To display the Safely Remove Hardware and Eject Media icon, click the **Show hidden icons** icon (the arrow at the left of the notification area).

b. Click the name of the digital card in the list.

📝 **NOTE:** You are prompted that it is safe to remove the hardware device.

3. Pull the digital card from the slot.

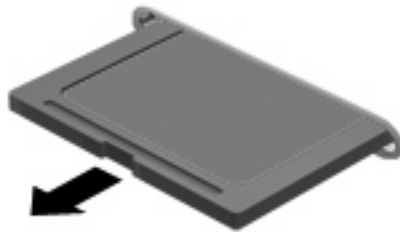

Using a USB device

A USB port connects an optional external device, such as a USB keyboard, mouse, drive, printer, scanner, or hub, to the computer.

Some USB devices may require additional support software, which is usually included with the device. For more information about device-specific software, refer to the manufacturer's instructions.

The computer has 3 USB ports, which support USB 1.0, USB 1.1, and USB 2.0 devices. To add more USB ports, connect an optional hub.

Connecting a USB device

△ **CAUTION:** To prevent damage to a USB connector, use minimal force to connect a USB device.

- To connect a USB device to the computer, connect the USB cable for the device to the USB port.



You will hear a sound when the device has been detected.

- 📄 **NOTE:** The first time you connect a USB device, the "Installing device driver software" message is displayed in the notification area, at the far right of the taskbar.

Removing a USB device

- △ **CAUTION:** To prevent loss of information or an unresponsive system, use the following procedure to safely remove the USB device.

CAUTION: To prevent damage to a USB connector, do not pull on the cable to remove the USB device.

To remove a USB device:

1. Click the **Safely Remove Hardware and Eject Media** icon in the notification area, at the far right of the taskbar.

- 📄 **NOTE:** To display the Safely Remove Hardware and Eject Media icon, click the **Show hidden icons** icon (the arrow at the left of the notification area).

2. Click the name of the device in the list.

- 📄 **NOTE:** You are prompted that it is safe to remove the hardware device.

3. Remove the device.

10 Drives

Handling drives

Drives are fragile computer components that must be handled with care. Refer to the following cautions before handling drives. Additional cautions are included with the procedures to which they apply.

- △ **CAUTION:** To reduce the risk of damage to the computer, damage to a drive, or loss of information, observe these precautions:

Before you move a computer that is connected to an external hard drive, initiate Sleep and allow the screen to clear, or properly disconnect the external hard drive.

Before handling a drive, discharge static electricity by touching the unpainted metal surface of the drive.

Do not touch the connector pins on a removable drive or on the computer.

Handle a drive carefully; do not drop a drive or place items on it.

Before removing or inserting a drive, shut down the computer. If you are unsure whether the computer is off, in the Sleep state, or in Hibernation, turn the computer on, and then shut it down through the operating system.

Do not use excessive force when inserting a drive into a drive bay.

Do not type on the keyboard or move the computer while the optical drive is writing to a disc. The write process is sensitive to vibration.

When the battery is the only source of power, be sure that the battery is sufficiently charged before writing to media.

Avoid exposing a drive to temperature or humidity extremes.

Avoid exposing a drive to liquids. Do not spray the drive with cleaning products.

Remove media from a drive before removing the drive from the drive bay, or traveling with, shipping, or storing a drive.

If a drive must be mailed, place the drive in a bubble-pack mailer or other suitable protective packaging and label the package "FRAGILE."

Avoid exposing a drive to magnetic fields. Security devices with magnetic fields include airport walk-through devices and security wands. The airport security devices that check carry-on luggage, such as conveyor belts, use x-rays instead of magnetism and will not damage a drive.

Improving hard drive performance

Using Disk Defragmenter

As you use the computer, files on the hard drive become fragmented. Disk Defragmenter consolidates the fragmented files and folders on the hard drive so that the system can run more efficiently.

- 📄 **NOTE:** It is not necessary to run Disk Defragmenter on solid-state drives.

To run Disk Defragmenter:

1. Select **Start > All Programs > Accessories > System Tools > Disk Defragmenter**.
2. Click **Defragment disk**.

 **NOTE:** Windows® includes the User Account Control feature to improve the security of your computer. You may be prompted for your permission or password for tasks such as installing applications, running utilities, or changing Windows settings. Refer to Help and Support for more information.

For additional information, access the Disk Defragmenter software Help.

Using Disk Cleanup

Disk Cleanup searches the hard drive for unnecessary files that you can safely delete to free up disk space and help the computer to run more efficiently.

To run Disk Cleanup:

1. Select **Start > All Programs > Accessories > System Tools > Disk Cleanup**.
2. Follow the on-screen instructions.

Using HP ProtectSmart Hard Drive Protection

HP ProtectSmart Hard Drive Protection protects a hard drive by parking the drive and halting data requests under either of the following conditions:

- You drop the computer.
- You move the computer with the display closed while the computer is running on battery power.

A short time after the end of one of these events, HP ProtectSmart Hard Drive Protection returns the hard drive to normal operation.

 **NOTE:** Because solid-state drives (SSD) lack moving parts, HP ProtectSmart Hard Drive Protection is unnecessary.

NOTE: Hard drives connected to USB ports are not covered by HP ProtectSmart Hard Drive Protection.

For more information, refer to the HP ProtectSmart Hard Drive Protection software Help.

Identifying HP ProtectSmart Hard Drive Protection status

The drive light on the computer turns amber to show that the drive is parked. To determine whether drives are currently protected or whether a drive is parked, select **Start > Control Panel > Hardware and Sound > Windows Mobility Center**:

- If the software is enabled, a green check mark is superimposed over the hard drive icon.
- If the software is disabled, a red X is superimposed over the hard drive icon.
- If the drives are parked, a yellow moon is superimposed over the hard drive icon.

The icon in the Mobility Center may not show the most up-to-date status for the drive. For immediate updates after a change in status, you need to enable the notification area icon.

To enable the notification area icon:

1. Select **Start > Control Panel > Hardware and Sound > HP ProtectSmart Hard Drive Protection**.

 **NOTE:** If prompted by User Account Control, click **Yes**.

2. On the **Icon in System Tray** row, click **Show**.
3. Click **OK**.

Managing power with a parked hard drive

If HP ProtectSmart Hard Drive Protection has parked the drive, the computer will behave in the following ways:

- The computer will not shut down.
- The computer will not initiate Sleep or Hibernation, except as described in the following Note.

 **NOTE:** If the computer is running on battery power and reaches a critical battery level, HP ProtectSmart Hard Drive Protection allows the computer to initiate Hibernation.

Before you move the computer, HP recommends that you either shut it down or initiate Sleep or Hibernation.

Using HP ProtectSmart Hard Drive Protection software

The HP ProtectSmart Hard Drive Protection software enables you to perform the following tasks:

- Enable and disable HP ProtectSmart Hard Drive Protection.

 **NOTE:** Depending on your user privileges, you may not be able to enable or disable HP ProtectSmart Hard Drive Protection. Additionally, members of an Administrator group can change the privileges for non-Administrator users.

- Determine whether a drive in the system is supported.

To open the software and change settings, follow these steps:

1. In Mobility Center, click the hard drive icon to open the HP ProtectSmart Hard Drive Protection window.

– or –

Select **Start > Control Panel > Hardware and Sound > HP ProtectSmart Hard Drive Protection**.

 **NOTE:** If prompted by User Account Control, click **Yes**.

2. Click the appropriate button to change settings.
3. Click **OK**.

Inserting and removing a hard drive

△ **CAUTION:** To prevent information loss or an unresponsive system:

Shut down the computer before removing the hard drive from the hard drive bay. Do not remove the hard drive while the computer is on, in the Sleep state, or in Hibernation.

If you are not sure whether the computer is off or in Hibernation, turn the computer on by sliding the power switch. Then shut down the computer through the operating system.

To remove the hard drive:

1. Save your work.
2. Shut down the computer and close the display.
3. Disconnect all external devices connected to the computer.
4. Unplug the power cord from the AC outlet.
5. Turn the computer upside down on a flat surface.
6. Remove the battery from the computer.
7. With the hard drive bay toward you, loosen the 2 hard drive cover screws (1).
8. Remove the hard drive cover (2).

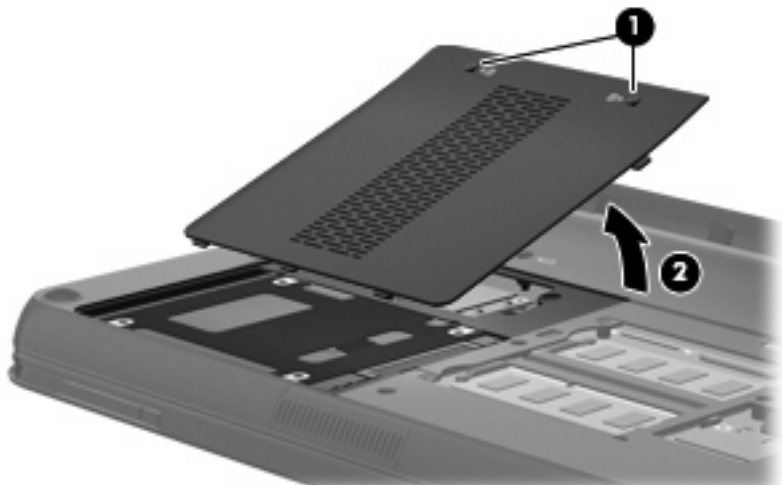

9. Pull the hard drive tab to the left (1) to disconnect the hard drive.

10. Lift the hard drive (2) out of the hard drive bay.

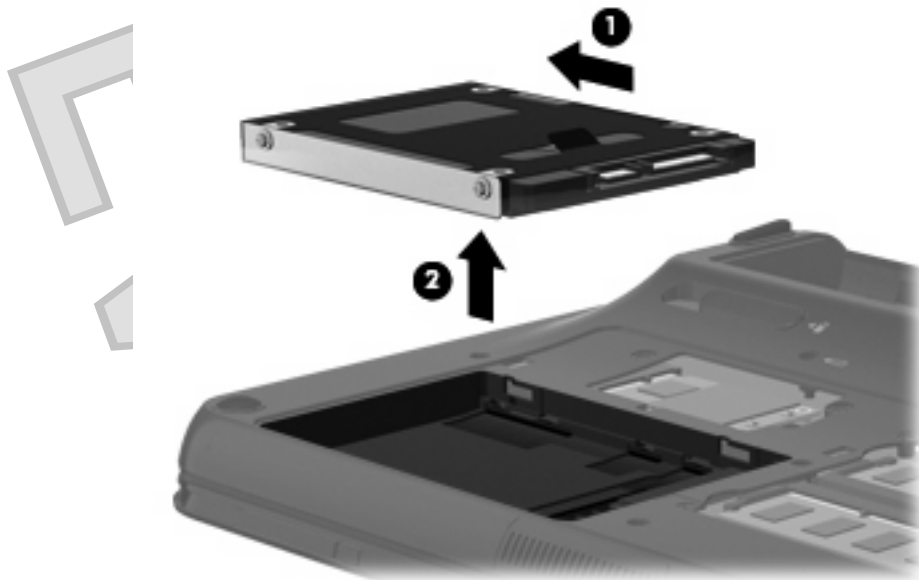

To install a hard drive:

1. Insert the hard drive into the hard drive bay (1).
2. Pull the hard drive tab (2) to the right until the hard drive snaps into place.

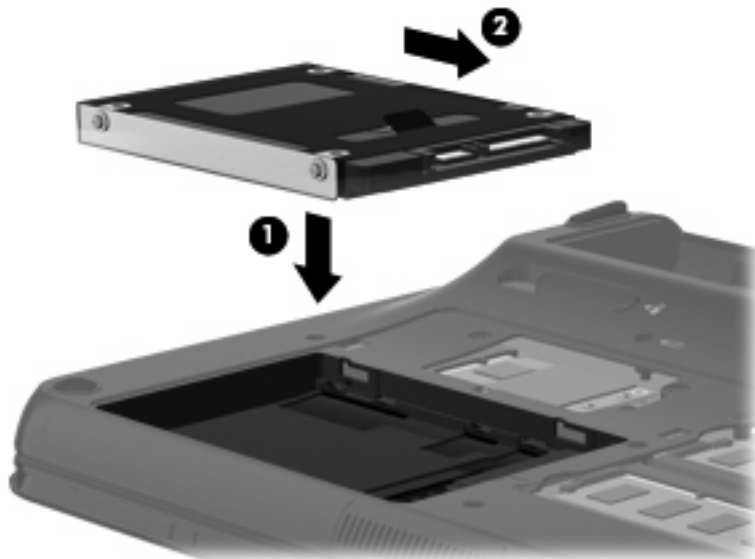

3. Align the tabs (1) on the hard drive cover with the notches on the computer.
4. Close the cover (2).

5. Tighten the hard drive cover screws (3).

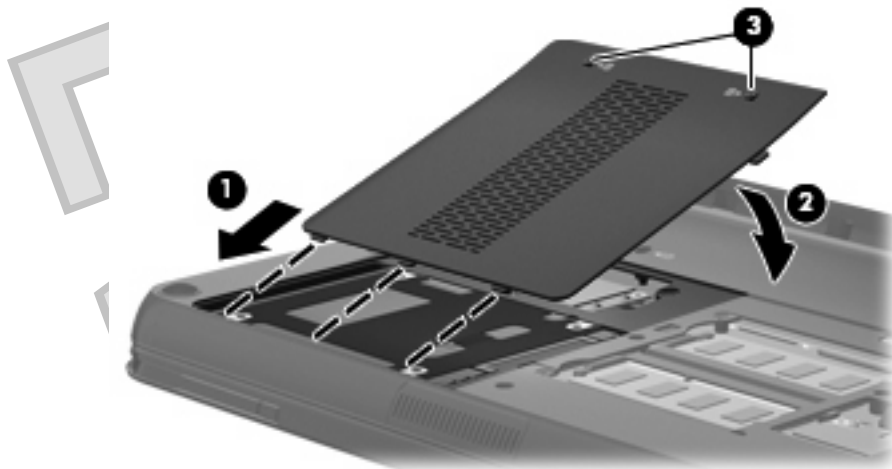

Using external drives

Removable external drives expand your options for storing and accessing information.

USB drives include the following types:

- 1.44-megabyte diskette drive
- Hard drive module (a hard drive with an adapter attached)
- DVD-ROM Drive
- DVD±RW SuperMulti Double-Layer (DL) Drive
- Blu-ray ROM DVD±R/RW SuperMulti Double-Layer (DL) Drive

Connecting optional external drives

 **NOTE:** For more information about required software and drivers, or to learn which computer port to use, refer to the manufacturer's instructions.

To connect an external drive to the computer:

 **CAUTION:** To reduce the risk of damage to the equipment when connecting a powered drive, be sure that the drive is turned off and the AC power cord is unplugged.

1. Connect the drive to the computer.
2. If you are connecting a powered drive, plug the device power cord into a grounded AC outlet.
3. Turn on the drive.

To disconnect an unpowered external drive, turn off the drive, and then disconnect it from the computer. To disconnect a powered external drive, turn off the drive, disconnect it from the computer, and then unplug the AC power cord.

Using an external optical drive

Select computer models ship with an external optical drive. An external optical drive connects to a USB port on the computer and enables you to read data discs, play music, and watch movies. If your external optical drive is a Blu-ray Disc (BD) drive, you can also watch high-definition video from discs.

You may have one of the following types of drives:

- DVD±RW SuperMulti Double-Layer (DL) Drive
- Blu-ray ROM DVD±R/RW SuperMulti Double-Layer (DL) Drive

Removing an optical disc when the disc tray will not open

If your optical drive is a tray load drive and the disc tray does not open, follow these steps:

1. Insert the end of a paper clip (1) into the release access in the front bezel of the drive.
2. Press in gently on the paper clip until the tray is released, and then pull out the tray (2) until it stops.
3. Remove the disc (3) from the tray by gently pressing down on the spindle while lifting the outer edges of the disc. Hold the disc by the edges and avoid touching the flat surfaces.

 **NOTE:** If the tray is not fully accessible, tilt the disc carefully as you remove it.

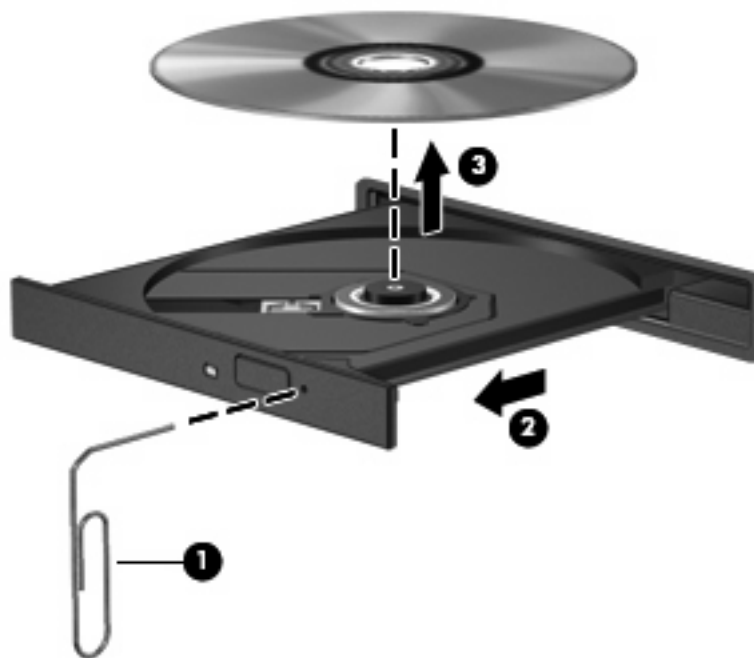

4. Close the disc tray and place the disc in a protective case.

Sharing an optical drive

Although your computer does not have an integrated optical drive, you can easily access software, install applications, and access data by sharing an optical drive connected to another computer in your network. Sharing drives is a feature of the Windows operating system that allows a drive on one computer to be accessible to other computers on the same network.

 **NOTE:** You must have a network set up in order to share an optical drive; refer to [Networking on page 15](#) for additional information on setting up a network.

NOTE: Some discs, such as DVD movies and game discs, may be copy-protected and therefore unusable through DVD or CD sharing.

To share an optical drive:

1. From the computer with the optical drive you are sharing, select **Start > Computer**.
2. Right-click the optical drive you want to share, and click **Properties**.
3. Select the **Sharing** tab > **Advanced Sharing**.
4. Select the **Share this folder** check box.
5. Type a name for the optical drive in the **Share name** text box.
6. Click **Apply**, and then click **OK**.
7. To view the shared optical drive on your computer, select **Start > Control Panel > Network and Internet > Network and Sharing Center**.

11 Memory modules

The computer has two memory module compartments, which are located on the bottom of the computer. The memory capacity of the computer can be upgraded by adding a memory module to the vacant expansion memory module slot or by upgrading the existing memory module in the primary memory module slot.

- △ **WARNING!** To reduce the risk of electric shock and damage to the equipment, unplug the power cord and remove all batteries before installing a memory module.
- △ **CAUTION:** Electrostatic discharge (ESD) can damage electronic components. Before beginning any procedure, ensure that you are discharged of static electricity by touching a grounded metal object.
- 📄 **NOTE:** To use a dual-channel configuration when adding a second memory module, be sure that both memory modules are the same size.

To add or replace a memory module:

1. Save your work.
2. Shut down the computer and close the display.
If you are not sure whether the computer is off or in Hibernation, turn the computer on by sliding the power switch. Then shut down the computer through the operating system.
3. Disconnect all external devices connected to the computer.
4. Unplug the power cord from the AC outlet.
5. Turn the computer upside down on a flat surface.
6. Remove the battery from the computer.
7. Loosen the 2 memory module compartment screws **(1)**.
8. Lift the memory module compartment cover **(2)** away from the computer.

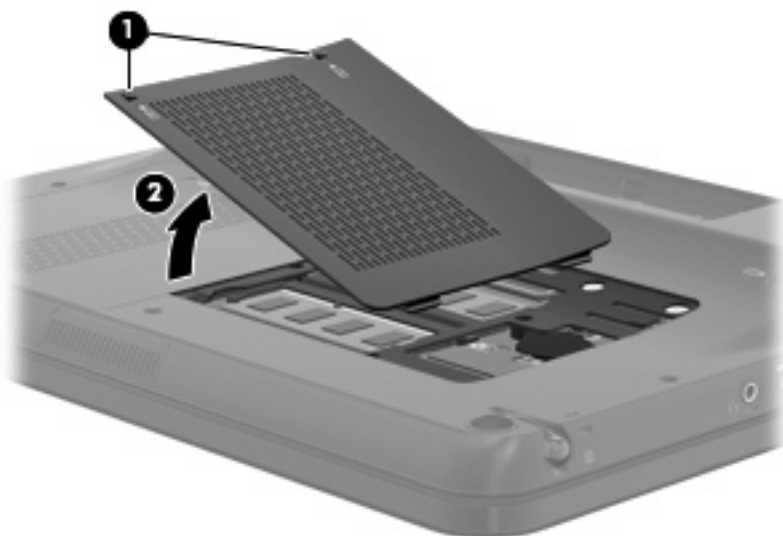

9. If you are replacing a memory module, remove the existing memory module:
 - a. Pull away the retention clips (1) on each side of the memory module.
The memory module tilts up.
 - b. Grasp the edge of the memory module (2), and gently pull the module out of the memory module slot.
- △ **CAUTION:** To prevent damage to the memory module, hold the memory module by the edges only. Do not touch the components on the memory module.

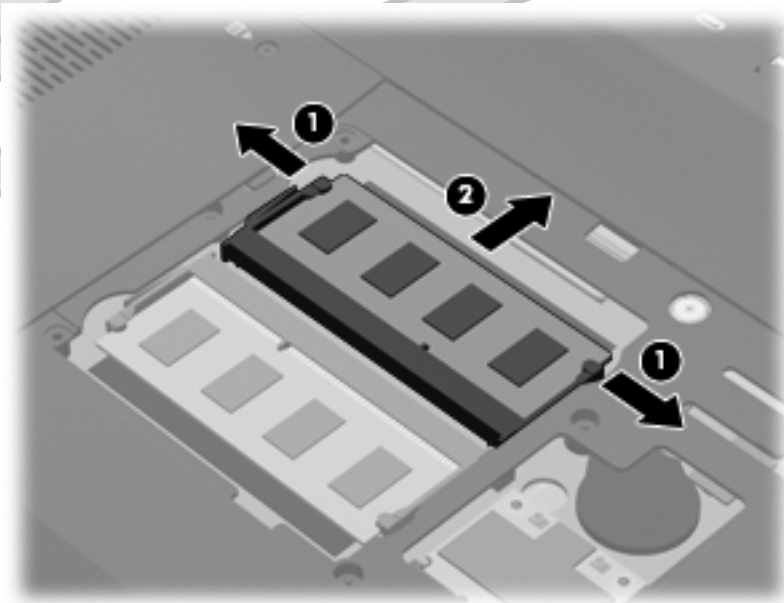

To protect a memory module after removal, place it in an electrostatic-safe container.

10. Insert a new memory module:
 - △ **CAUTION:** To prevent damage to the memory module, hold the memory module by the edges only. Do not touch the components on the memory module, and do not bend the memory module.
 - a. Align the notched edge (1) of the memory module with the tab in the memory module slot.
 - b. With the memory module at a 45-degree angle from the surface of the memory module compartment, press the module (2) into the memory module slot until it is seated.

- c. Gently press the memory module (3) down, applying pressure to both the left and right edges of the memory module, until the retention clips snap into place.

△ **CAUTION:** To prevent damage to the memory module, be sure that you do not bend the memory module.

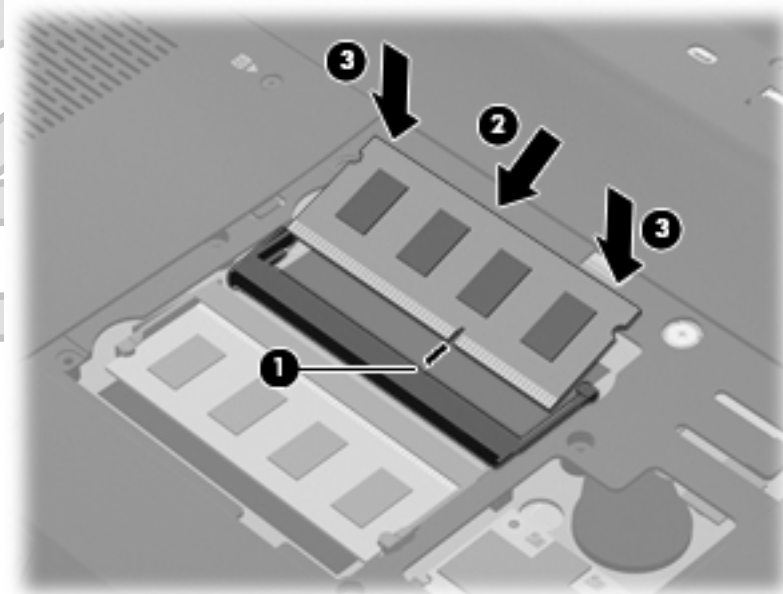

11. Align the tabs (1) on the memory module compartment cover with the notches on the computer.
12. Close the cover (2).
13. Tighten the 2 memory module compartment screws (3).

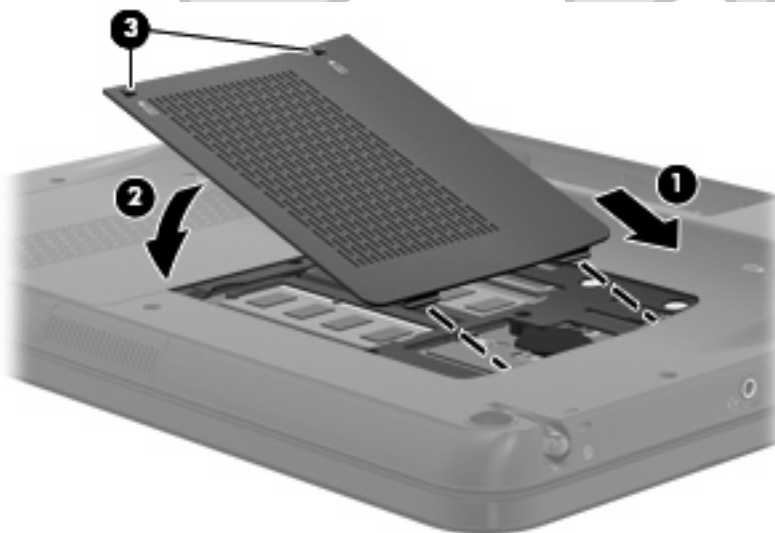

14. Replace the battery.
15. Turn the computer right-side up, and then reconnect external power and external devices.
16. Turn on the computer.

12 Security

Protecting the computer

Standard security features provided by the Windows® operating system and the non-Windows Setup Utility can protect your personal settings and data from a variety of risks.

Follow the procedures in this guide to use the following features:

- Passwords
- Antivirus software
- Firewall software
- Critical security updates
- Optional security cable
- Fingerprint reader

 **NOTE:** Security solutions are designed to act as deterrents, but they may not deter software attacks or prevent the computer from being mishandled or stolen.

NOTE: Before you send your computer for service, remove all password and fingerprint settings.

Computer risk	Security feature
Unauthorized use of the computer	Power-on password or fingerprint reader
Computer viruses	Norton Internet Security software
Unauthorized access to data	<ul style="list-style-type: none">• Firewall software• Windows updates
Unauthorized access to Setup Utility, BIOS settings, and other system identification information	Administrator password
Ongoing or future threats to the computer	Critical security updates from Microsoft
Unauthorized access to a Windows user account	User password
Unauthorized removal of the computer	Security cable slot (used with an optional security cable)

Using passwords

A password is a group of characters that you choose to secure your computer information. Several types of passwords can be set, depending on how you want to control access to your information. Passwords can be set in Windows or in the non-Windows Setup Utility preinstalled on the computer.

 **CAUTION:** To prevent being locked out of the computer, record each password you set. Because most passwords are not displayed as they are set, changed, or deleted, it is essential to record each password immediately and store it in a secure place.

You can use the same password for a Setup Utility feature and for a Windows security feature. You can also use the same password for more than one Setup Utility feature.

Use the following guidelines when setting a password in Setup Utility:

- A password can be any combination of up to 8 letters and numbers and is case sensitive.
- A password set in Setup Utility must be entered at a Setup Utility prompt. A password set in Windows must be entered at a Windows prompt.

Use the following tips for creating and saving passwords:

- When creating passwords, follow requirements set by the program.
- Write down your passwords and store them in a secure place away from the computer.
- Do not store passwords in a file on the computer.
- Do not use your name or other personal information that could be easily discovered by an outsider.

The following sections list Windows and Setup Utility passwords and describe their functions. For additional information about Windows passwords, such as screen-saver passwords, select **Start > Help and Support**.

Setting passwords in Windows

Password	
Administrator password	Protects administrator-level access to computer contents. NOTE: This password cannot be used to access Setup Utility contents.
User password	Protects access to a Windows user account. It also protects access to the computer contents and must be entered when you exit Sleep or Hibernation.

Setting passwords in Setup Utility

Password	
Administrator password*	<ul style="list-style-type: none">• Protects access to Setup Utility.• After this password is set, it must be entered each time you access Setup Utility. CAUTION: If you forget your administrator password, you cannot access Setup Utility.
Power-on password*	<ul style="list-style-type: none">• Protects access to the computer contents.• After this password is set, it must be entered each time you turn on or restart the computer, or exit Hibernation. CAUTION: If you forget your power-on password, you cannot turn on or restart the computer, or exit Hibernation. NOTE: The administrator password can be used in place of the power-on password.

*For details about each of these passwords, refer to the following topics.

Administrator password

Your administrator password protects the configuration settings and system identification information in Setup Utility. After this password is set, you must enter it each time you access Setup Utility.

Your administrator password is not interchangeable with an administrator password set in Windows, nor is it displayed as it is set, entered, changed, or deleted. Be sure that you record your password and store it in a safe place.

If you enter the administrator password at the first password check before the “Press the ESC key for Startup Menu” message is displayed, you do not have to enter it again to access Setup Utility.

If you enter the power-on password at the first password check before the “Press the ESC key for Startup Menu” message is displayed, you must enter the administrator password to access Setup Utility.

Managing an administrator password

To set, change, or delete this password, follow these steps:

1. Open Setup Utility by turning on or restarting the computer. While the “Press the ESC key for Startup Menu” message is displayed in the lower-left corner of the screen, press **f10**.

– or –

Open Setup Utility by turning on or restarting the computer. While the “Press the ESC key for Startup Menu” message is displayed in the lower-left corner of the screen, press **esc**. When the Startup Menu is displayed, press **f10**.

2. Use the arrow keys to select **Security > Set Administrator Password**, and then press **enter**.
 - To set an administrator password, type your password in the **Enter New Password** and **Confirm New Password** fields, and then press **enter**.
 - To change an administrator password, type your current password in the **Enter Current Password** field, type a new password in the **Enter New Password** and **Confirm New Password** fields, and then press **enter**.
 - To delete an administrator password, type your current password in the **Enter Password** field, and then press **enter** 4 times.
3. To save your changes and exit Setup Utility, use the arrow keys to select **Exit > Exit Saving Changes**.

Your changes go into effect when the computer restarts.

Entering an administrator password

At the **Enter Password** prompt, type your administrator password, and then press **enter**. After 3 unsuccessful attempts to enter the administrator password, you must restart the computer and try again.

Power-on password

Your power-on password prevents unauthorized use of the computer. After this password is set, it must be entered each time you turn on or restart the computer, or exit Hibernation. A power-on password is not displayed as it is set, entered, changed, or deleted.

Managing a power-on password

To set, change, or delete this password, follow these steps:

1. Open Setup Utility by turning on or restarting the computer. While the “Press the ESC key for Startup Menu” message is displayed in the lower-left corner of the screen, press **f10**.
– or –
Open Setup Utility by turning on or restarting the computer. While the “Press the ESC key for Startup Menu” message is displayed in the lower-left corner of the screen, press **esc**. When the Startup Menu is displayed, press **f10**.
2. Use the arrow keys to select **Security > Set Power-On Password**, and then press **enter**.
 - To set a power-on password, type your password in the **Enter New Password** and **Confirm New Password** fields, and then press **enter**.
 - To change a power-on password, type your current password in the **Enter Current Password** field, type a new password in the **Enter New Password** and **Confirm New Password** fields, and then press **enter**.
 - To delete a power-on password, type your current password in the **Enter Current Password** field, and then press **enter** 4 times.
3. To save your changes and exit Setup Utility, use the arrow keys to select **Exit > Exit Saving Changes**.

Your changes go into effect when the computer restarts.

Entering a power-on password

At the **Enter Password** prompt, type your password, and then press **enter**. After 3 unsuccessful attempts to enter the password, you must restart the computer and try again.

Using antivirus software

When you use the computer to access e-mail, a network, or the Internet, you expose it to computer viruses. Computer viruses can disable the operating system, programs, or utilities, or cause them to abnormally.

Antivirus software can detect most viruses, destroy them, and in most cases, repair any damage they have caused. To provide ongoing protection against newly discovered viruses, antivirus software must be kept up to date.

Norton Internet Security, an antivirus program, is preinstalled on the computer. The software includes 60 days of free updates. It is strongly recommended that you protect the computer against new viruses beyond 60 days by purchasing extended update service. Instructions for using and updating Norton Internet Security software and for purchasing extended update service are provided within the program. To view and access Norton Internet Security, select **Start > All Programs > Norton Internet Security**.

For more information about computer viruses, type `viruses` in the Search box in Help and Support.

Using firewall software

When you use the computer for e-mail, network, or Internet access, unauthorized persons may be able to gain access to the computer, your personal files, and information about you. Use the firewall software preinstalled on the computer to protect your privacy.

Firewall features include logging and reporting of network activity, and automatic monitoring of all incoming and outgoing traffic. Refer to the firewall user guide or contact your firewall manufacturer for more information.

NOTE: Under some circumstances a firewall can block access to Internet games, interfere with printer or file sharing on a network, or block authorized e-mail attachments. To temporarily resolve the problem, disable the firewall, perform the task that you want to perform, and then reenable the firewall. To permanently resolve the problem, reconfigure the firewall.

Installing critical security updates

CAUTION: Microsoft sends alerts regarding critical updates. To protect the computer from security breaches and computer viruses, install all critical updates from Microsoft as soon as you receive an alert.

Updates to the operating system and other software may have become available after the computer was shipped. To be sure that all available updates are installed on the computer, observe these guidelines:

- Run Windows Update as soon as possible after you set up your computer. Use the update link at **Start > All Programs > Windows Update**.
- Run Windows Update monthly thereafter.
- Obtain updates to Windows and other Microsoft® programs, as they are released, from the Microsoft Web site and through the updates link in Help and Support.

Installing an optional security cable

NOTE: A security cable is designed to act as a deterrent, but it may not prevent the computer from being mishandled or stolen.

1. Loop the security cable around a secured object.
2. Insert the key (1) into the cable lock (2).
3. Insert the cable lock into the security cable slot on the computer (3), and then lock the cable lock with the key.

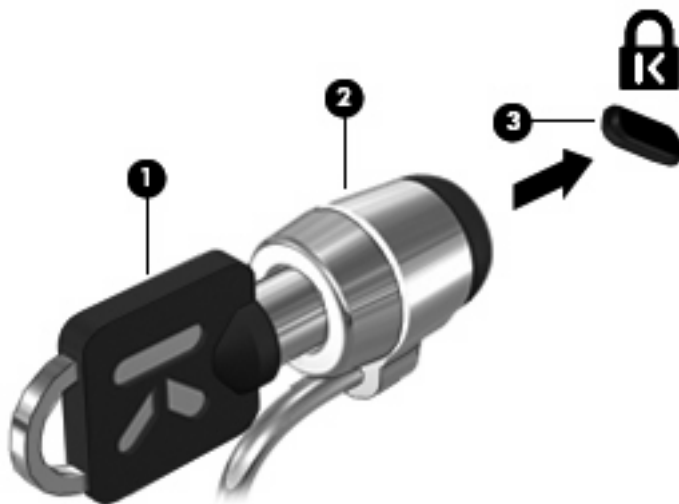

4. Remove the key and keep it in a safe place.

Using your registered fingerprint to log on to Windows

To log on to Windows using your fingerprint, follow these steps:

1. Immediately after you have registered your fingerprints, restart Windows.
2. Swipe any of your registered fingers to log on to Windows.

13 Backup and recovery

Recovery after a system failure is as complete as your most current backup. HP recommends that you create recovery discs immediately after software setup. As you add new software and data files, you should continue to back up your system on a regular basis to maintain a reasonably current backup.

Tools provided by the operating system and HP Recovery Manager software are designed to help you with the following tasks for safeguarding your information and restoring it in case of a system failure:

- Creating a set of recovery discs (Recovery Manager software feature). Recovery discs are used to start up (boot) your computer and restore the operating system and software programs to factory settings in case of system failure or instability.
- Backing up your information regularly to protect your important system files.
- Creating system restore points (operating system feature). System restore points allow you to reverse undesirable changes to your computer by restoring the computer to an earlier state.
- Recovering a program or driver (Recovery Manager software feature). This feature helps you reinstall a program or driver without performing a full system recovery.
- Performing a full system recovery (Recovery Manager software feature). With Recovery Manager, you can recover your full factory image if you experience system failure or instability. Recovery Manager works from a dedicated recovery partition (select models only) on the hard drive or from recovery discs you create.

 **NOTE:** Computers with a solid-state drive (SSD) may not have a recovery partition. Recovery discs have been included for computers that do not have a partition. Use these discs to recover your operating system and software. To check for the presence of a recovery partition, select **Start**, right-click **Computer**, click **Manage**, and then click **Disk Management**. If the partition is present, an HP Recovery drive is listed in the window.

Creating recovery discs

HP recommends that you create recovery discs to be sure that you can restore your system to its original factory state if you experience serious system failure or instability. Create these discs after setting up the computer for the first time.

Handle these discs carefully and keep them in a safe place. The software allows the creation of only one set of recovery discs.

 **NOTE:** If your computer does not include an integrated optical drive, you can use an optional external optical drive (purchased separately) to create recovery discs, or you can purchase recovery discs for your computer from the HP Web site.

Note the following guidelines before creating recovery discs:

- You will need high-quality DVD-R, DVD+R, BD-R (writable Blu-ray), or CD-R discs. All these discs are purchased separately. DVDs and BDs have a much higher capacity than CDs. If you use CDs, up to 20 discs may be required, whereas only a few DVDs or BDs are required.

 **NOTE:** Read-write discs, such as CD-RW, DVD±RW, double-layer DVD±RW, and BD-RE (rewritable Blu-ray) discs, are not compatible with the Recovery Manager software.

- The computer must be connected to AC power during this process.

- Only one set of recovery discs can be created per computer.
- Number each disc before inserting it into the optical drive.
- If necessary, you can exit the program before you have finished creating the recovery discs. The next time you open Recovery Manager, you will be prompted to continue the disc creation process.

To create a set of recovery discs:

1. Select **Start > All Programs > Recovery Manager > Recovery Disc Creation**.
2. Follow the on-screen instructions.

Backing up your information

As you add new software and data files, you should back up your system on a regular basis to maintain a reasonably current backup. Back up your system at the following times:

- At regularly scheduled times

 **NOTE:** Set reminders to back up your information periodically.

- Before the computer is repaired or restored
- Before you add or modify hardware or software

Note the following when backing up:

- Create system restore points using the Windows® System Restore feature, and periodically copy them to disc.
- Store personal files in the Documents library and back up this folder periodically.
- Back up templates stored in their associated programs.
- Save customized settings in a window, toolbar, or menu bar by taking a screen shot of your settings. The screen shot can be a time-saver if you have to reset your preferences.

To copy the screen and paste it into a word-processing document, follow these steps:

1. Display the screen.
2. Copy the screen:
 - To copy only the active window, press **alt+prt sc**.
 - To copy the entire screen, press **prt sc**.
3. Open a word-processing document, and then select **Edit > Paste**.
4. Save the document.

- You can back up your information to an optional external hard drive, a network drive, or discs.
- When backing up to discs, use any of the following types of discs (purchased separately): CD-R, CD-RW, DVD+R, DVD-R, or DVD±RW. The discs you use will depend on the type of optical drive installed in your computer.

 **NOTE:** DVDs store more information than CDs, so using them for backup reduces the number of recovery discs required.

- When backing up to discs, number each disc before inserting it into the optical drive of the computer.

Using Windows Backup and Restore

To create a backup using Windows Backup and Restore, follow these steps:

 **NOTE:** Be sure that the computer is connected to AC power before you start the backup process.

NOTE: The backup process may take over an hour, depending on file size and the speed of the computer.

1. Select **Start > All Programs > Maintenance > Backup and Restore**.
2. Follow the on-screen instructions to set up and create a backup.

 **NOTE:** Windows® includes the User Account Control feature to improve the security of your computer. You may be prompted for your permission or password for tasks such as installing software, running utilities, or changing Windows settings. Refer to Help and Support for more information.

Using system restore points

When you back up your system, you are creating a system restore point. A system restore point allows you to save and name a snapshot of your hard drive at a specific point in time. You can then recover back to that point if you want to reverse subsequent changes made to your system.

 **NOTE:** Recovering to an earlier restore point does not affect data files saved or e-mails created since the last restore point.

You also can create additional restore points to provide increased protection for your system files and settings.

When to create restore points

- Before you add or extensively modify software or hardware
- Periodically, whenever the system is performing optimally

 **NOTE:** If you revert to a restore point and then change your mind, you can reverse the restoration.

Create a system restore point

1. Select **Start > Control Panel > System and Security > System**.
2. In the left pane, click **System Protection**.
3. Click the **System Protection** tab.
4. Under **Protection Settings**, select the disk for which you want to create a restore point.
5. Click **Create**.
6. Follow the on-screen instructions.

Restore to a previous date and time

To revert to a restore point (created at a previous date and time), when the computer was functioning optimally, follow these steps:

1. Select **Start > Control Panel > System and Security > System**.
2. In the left pane, click **System protection**.
3. Click the **System Protection** tab.

4. Click **System Restore**.
5. Follow the on-screen instructions.

Performing a recovery

 **NOTE:** You can recover only files that you have previously backed up. HP recommends that you use HP Recovery Manager to create a set of recovery discs (entire drive backup) as soon as you set up your computer.

Recovery Manager software allows you to repair or restore the system if you experience system failure or instability. Recovery Manager works from recovery discs or from a dedicated recovery partition (select models only) on the hard drive. However, if your computer includes a solid-state drive (SSD), you may not have a recovery partition. If that is the case, recovery discs have been included with your computer. Use these discs to recover your operating system and software.

 **NOTE:** Windows has its own built-in repair features, such as System Restore. If you have not already tried these features, try them before using Recovery Manager.

NOTE: Recovery Manager recovers only software that was preinstalled at the factory. Software not provided with this computer must be downloaded from the manufacturer's Web site or reinstalled from the disc provided by the manufacturer.

Recovering from the recovery discs

To restore the system from the recovery discs:

1. Back up all personal files.
2. Insert the first recovery disc into an optional external optical drive and restart the computer.
3. Follow the on-screen instructions.

Recovering from the dedicated recovery partition (select models only)

 **NOTE:** Computers with an SSD may not have a recovery partition. If the computer does not have a recovery partition, you will not be able to recover using this procedure. Recovery discs have been included for computers that do not have a partition. Use these discs to recover your operating system and software.

On some models, you can perform a recovery from the partition on the hard drive, accessed by pressing either the Start button or **f11**. This restores the computer to its factory condition.

To restore the system from the partition, follow these steps:

1. Access Recovery Manager in either of the following ways:
 - Select **Start > All Programs > Recovery Manager > Recovery Manager**.
 - or –
 - Turn on or restart the computer, and then press **esc** while the “Press the ESC key for Startup Menu” message is displayed at the bottom of the screen. Then, press **f11** while the “Press <F11> for recovery” message is displayed on the screen.
2. Click **System Recovery** in the **Recovery Manager** window.
3. Follow the on-screen instructions.

14 Setup Utility (BIOS)

Starting Setup Utility

Setup Utility is a ROM-based information and customization utility that can be used even when your Windows® operating system is not working.

The utility reports information about the computer and provides settings for startup, security, and other preferences.

To start Setup Utility:

- Open Setup Utility by turning on or restarting the computer. While the “Press the ESC key for Startup Menu” message is displayed in the lower-left corner of the screen, press [f10](#).

– or –

1. Open Setup Utility by turning on or restarting the computer. While the “Press the ESC key for Startup Menu” message is displayed in the lower-left corner of the screen, press [esc](#).
2. When the Startup Menu is displayed, press [f10](#).

Using Setup Utility

Changing the language of Setup Utility

The following procedure explains how to change the language of Setup Utility. If Setup Utility is not already running, begin at step 1. If Setup Utility is already running, begin at step 2.

1. Open Setup Utility by turning on or restarting the computer. While the “Press the ESC key for Startup Menu” message is displayed in the lower-left corner of the screen, press [f10](#).

– or –

Open Setup Utility by turning on or restarting the computer. While the “Press the ESC key for Startup Menu” message is displayed in the lower-left corner of the screen, press [esc](#). When the Startup Menu is displayed, press [f10](#).

2. Use the arrow keys to select **System Configuration > Language**, and then press [enter](#).
3. Use the arrow keys to select a language, and then press [enter](#).
4. When a confirmation prompt with your language selected is displayed, press [enter](#).
5. To save your change and exit Setup Utility, use the arrow keys to select **Exit > Exit Saving Changes**, and then press [enter](#).

Your change goes into effect immediately.

Navigating and selecting in Setup Utility

Because Setup Utility is not Windows based, it does not support the TouchPad. Navigation and selection are by keystroke.

- To choose a menu or a menu item, use the arrow keys.
- To choose an item in a list or to toggle a field, for example an Enable/Disable field, use either the arrow keys or **f5** or **f6**.
- To select an item, press **enter**.
- To close a text box or return to the menu display, press **esc**.
- To display additional navigation and selection information while Setup Utility is open, press **f1**.

Displaying system information

The following procedure explains how to display system information in Setup Utility. If Setup Utility is not open, begin at step 1. If Setup Utility is open, begin at step 2.

1. Open Setup Utility by turning on or restarting the computer. While the “Press the ESC key for Startup Menu” message is displayed in the lower-left corner of the screen, press **f10**.
– or –
Open Setup Utility by turning on or restarting the computer. While the “Press the ESC key for Startup Menu” message is displayed in the lower-left corner of the screen, press **esc**. When the Startup Menu is displayed, press **f10**.
2. Select the **Main** menu. System information such as the system time and date, and identification information about the computer is displayed.
3. To exit Setup Utility without changing any settings, use the arrow keys to select **Exit > Exit Discarding Changes**, and then press **enter**.

Restoring default settings in Setup Utility

The following procedure explains how to restore the Setup Utility default settings. If Setup Utility is not already running, begin at step 1. If Setup Utility is already running, begin at step 2.

1. Open Setup Utility by turning on or restarting the computer. While the “Press the ESC key for Startup Menu” message is displayed in the lower-left corner of the screen, press **f10**.
– or –
Open Setup Utility by turning on or restarting the computer. While the “Press the ESC key for Startup Menu” message is displayed in the lower-left corner of the screen, press **esc**. When the Startup Menu is displayed, press **f10**.
2. Use the arrow keys to select **Exit > Load Setup Defaults**, and then press **enter**.
3. When the Setup Confirmation is displayed, press **enter**.
4. To save your change and exit Setup Utility, use the arrow keys to select **Exit > Exit Saving Changes**, and then press **enter**.

The Setup Utility default settings go into effect when the computer restarts.

 **NOTE:** Your password, security, and language settings are not changed when you restore the factory default settings.

Exiting Setup Utility

You can exit Setup Utility with or without saving changes.

- To exit Setup Utility and save your changes from the current session:
If the Setup Utility menus are not visible, press **esc** to return to the menu display. Then use the arrow keys to select **Exit > Exit Saving Changes**, and then press **enter**.
- To exit Setup Utility without saving your changes from the current session:
If the Setup Utility menus are not visible, press **esc** to return to the menu display. Then use the arrow keys to select **Exit > Exit Discarding Changes**, and then press **enter**.

After either choice, the computer restarts in Windows.

Setup Utility Menus

The menu tables in this section provide an overview of Setup Utility options.

 **NOTE:** Some of the Setup Utility menu items listed in this chapter may not be supported by your computer.

Main menu

Select	To do this
System information	<ul style="list-style-type: none">• View and change the system time and date.• View identification information about the computer.• View specification information, such as processor information, memory size, and system BIOS.

Security menu

Select	To do this
Administrator password	Enter, change, or delete an administrator password.
Power-On Password	Enter, change, or delete a power-on password.

System Configuration menu

Select	To do this
Language Support	Change the Setup Utility language.
Virtualization Technology (select models only)	Enable/disable the processor Virtualization Technology.
Fan Always On	Enabled/disable Fan Always On. When enabled, the computer fan will always be on.

Select	To do this
Action Keys Mode	Enable/disable the Action Keys.
Boot Options	<p>Set the following boot options:</p> <ul style="list-style-type: none"> • POST Hot Key Delay (sec.)—Set the delay for the user to press hot keys in intervals of 5 seconds each (0, 5, 10, 15, 20). • Floppy Boot—Enable/disable boot from diskette. • Network Adapter Boot—Enable/disable boot from external Network Adapter. • Boot Order—Set the boot order for: <ul style="list-style-type: none"> ◦ Notebook Hard Drive ◦ USB Diskette on Key/USB Hard Drive ◦ USB CD/DVD ROM Drive ◦ USB Floppy ◦ Network adapter

Diagnostics menu

Select	To do this
Primary Hard Disk Self Test	Run a comprehensive self-test on the hard drive.
Memory Test	Run a diagnostic test on the system memory.

Updating the BIOS

Updated versions of the BIOS may be available on the HP Web site.

Most BIOS updates on the HP Web site are packaged in compressed files called *SoftPaqs*.

Some download packages contain a file named *Readme.txt*, which contains information regarding installing and troubleshooting the file.

Updating the BIOS

Determining the BIOS version

To determine whether available BIOS updates contain later BIOS versions than those currently installed on the computer, you need to know the version of the system BIOS currently installed.

BIOS version information (also known as *ROM date* and *System BIOS*) can be displayed by pressing **fn+esc** (if you are already in Windows) or by opening Setup Utility.

To use Setup Utility for displaying BIOS information:

1. Open Setup Utility by turning on or restarting the computer. While the “Press the ESC key for Startup Menu” message is displayed in the lower-left corner of the screen, press **f10**.
2. If Setup Utility does not open with the system information displayed, use the arrow keys to select the **Main** menu.
When the Main menu is selected, BIOS and other system information is displayed.
3. To exit Setup Utility, use the arrow keys to select **Exit > Exit Discarding Changes**, and then press **enter**.

Downloading a BIOS update

- △ **CAUTION:** To prevent damage to the computer or an unsuccessful installation, download and install a BIOS update only when the computer is connected to reliable external power using the AC adapter. Do not download or install a BIOS update while the computer is running on battery power, docked in an optional docking device, or connected to an optional power source. During the download and installation, follow these instructions:

Do not disconnect power from the computer by unplugging the power cord from the AC outlet.

Do not shut down the computer or initiate Sleep or Hibernation.

Do not insert, remove, connect, or disconnect any device, cable, or cord.

To download a BIOS update:

1. Access the page on the HP Web site that provides software for your computer:
Select **Start > Help and Support > Maintain**.
2. Follow the instructions on the screen to identify your computer and access the BIOS update you want to download.
3. At the download area, follow these steps:
 - a. Identify the BIOS update that is later than the BIOS version currently installed on your computer. Make a note of the date, name, or other identifier. You may need this information to locate the update later, after it has been downloaded to your hard drive.
 - b. Follow the instructions on the screen to download your selection to the hard drive.
Make a note of the path to the location on your hard drive where the BIOS update will be downloaded. You will need to access this path when you are ready to install the update.

- 📄 **NOTE:** If you connect your computer to a network, consult the network administrator before installing any software updates, especially system BIOS updates.

BIOS installation procedures vary. Follow any instructions that are displayed on the screen after the download is complete. If no instructions are displayed, follow these steps:

1. Open Windows Explorer by selecting **Start > Computer**.
2. Double-click your hard drive designation. The hard drive designation is typically Local Disk (C:).
3. Using the hard drive path you recorded earlier, open the folder on your hard drive that contains the update.
4. Double-click the file that has an .exe extension (for example, *filename.exe*).

The BIOS installation begins.

5. Complete the installation by following the instructions on the screen.

 **NOTE:** After a message on the screen reports a successful installation, you can delete the downloaded file from your hard drive.

A Product information

Input power

The power information in this section may be helpful if you plan to travel internationally with the computer.

The computer operates on DC power, which can be supplied by an AC or a DC power source. Although the computer can be powered from a standalone DC power source, it should be powered only with an AC adapter or a DC power source supplied and approved by HP for use with this computer.

The computer can operate on DC power within the following specifications.

Input power	Rating
Operating voltage	18.5 V dc @ 3.5 A - 65W
Operating current	3.5 A

 **NOTE:** This product is designed for IT power systems in Norway with phase-to-phase voltage not exceeding 240 V rms.

NOTE: The computer operating voltage and current can be found on the system regulatory label on the bottom of the computer.

Operating environment

Factor	Metric	U.S.
Temperature		
Operating (writing to optical disc)	5°C to 35°C	41°F to 95°F
Nonoperating	-20°C to 60°C	-4°F to 140°F
Relative humidity (noncondensing)		
Operating	10% to 90%	10% to 90%
Nonoperating	5% to 95%	5% to 95%
Maximum altitude (unpressurized)		
Operating	-15 m to 3,048 m	-50 ft to 10,000 ft
Nonoperating	-15 m to 12,192 m	-50 ft to 40,000 ft

Traveling with the computer

For best results, follow these traveling and shipping tips:

- Prepare the computer for traveling or shipping:
 - Back up your information.
 - Remove all discs and all external media cards, such as digital cards.
- △ **CAUTION:** To reduce the risk of damage to the computer, damage to a drive, or loss of information, remove the media from a drive before removing the drive from a drive bay, and before shipping, storing, or traveling with a drive.
- Turn off and then disconnect all external devices.
- Shut down the computer.
- Take along a backup of your information. Keep the backup separate from the computer.
- When traveling by air, carry the computer as hand luggage, and do not check it in with the rest of your bags.
- △ **CAUTION:** Avoid exposing a drive to magnetic fields. Security devices with magnetic fields include airport walk-through devices and security wands. The airport security devices that check carry-on luggage, such as conveyor belts, use X-rays instead of magnetism and will not damage a drive.
- In-flight computer use is at the discretion of the airline. If you plan to use the computer during a flight, check with the airline in advance.
- If the computer will be unused and disconnected from external power for more than 2 weeks, remove the battery and store it separately.
- If you are shipping the computer or a drive, use suitable protective packaging and label the package "FRAGILE."
- If the computer has a wireless device or a cell phone device installed, such as an 802.11b/g device, a Global System for Mobile Communications (GSM) device, or a General Packet Radio Service (GPRS) device, the use of these devices may be restricted in some environments. Such restrictions may apply onboard aircraft, in hospitals, near explosives, and in hazardous locations. If you are uncertain of the policy that applies to the use of a particular device, ask for authorization to use it before you turn it on.
- If you are traveling internationally, follow these suggestions:
 - Check the computer-related customs regulations for each country or region on your itinerary.
 - Check the power cord and adapter requirements for each location in which you plan to use the computer. Voltage, frequency, and plug configurations vary.
- △ **WARNING!** To reduce the risk of electric shock, fire, or damage to the equipment, do not attempt to power the computer with a voltage converter kit sold for appliances.

Routine care

Cleaning the display

- △ **CAUTION:** To prevent permanent damage to the computer, never spray water, cleaning fluids, or chemicals on the display.

To remove smudges and lint, frequently clean the display with a soft, damp, lint-free cloth. If the screen requires additional cleaning, use premoistened antistatic wipes or an antistatic screen cleaner.

Cleaning the TouchPad and keyboard

Dirt and grease on the TouchPad can cause the pointer to jump around on the screen. To avoid this, clean the TouchPad with a damp cloth, and wash your hands frequently when using the computer.

⚠ WARNING! To reduce the risk of electric shock or damage to internal components, do not use a vacuum cleaner attachment to clean the keyboard. A vacuum cleaner can deposit household debris on the keyboard surface.

Clean the keyboard regularly to prevent keys from sticking and to remove dust, lint, and particles that can become trapped beneath the keys. A can of compressed air with a straw extension can be used to blow air around and under the keys to loosen and remove debris.

Labels

The labels affixed to the computer provide information you may need when you troubleshoot system problems or travel internationally with the computer:

- Service tag—Provides important information, including the following:

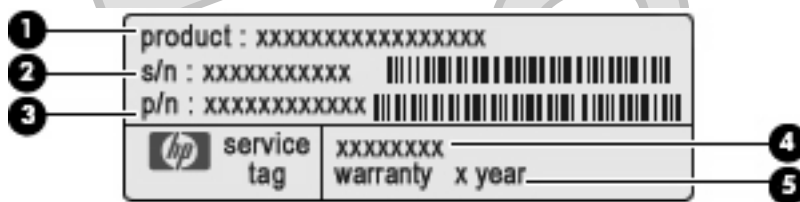

- Product name **(1)**. This is the product name affixed to the front of the computer.
- Serial number (s/n) **(2)**. This is an alphanumeric identifier that is unique to each product.
- Part number/Product number (p/n) **(3)**. This number provides specific information about the product's hardware components. The part number helps a service technician to determine what components and parts are needed.
- Model description **(4)**. This is an alphanumeric identifier used to locate documents, drivers, and support for the computer.
- Warranty period **(5)**. This number describes the duration of the warranty period for the computer.

Have this information available when you contact technical support. The service tag label is located inside the battery bay.

- Microsoft® Certificate of Authenticity—Contains the Windows Product Key. You may need the Product Key to update or troubleshoot the operating system. The Microsoft Certificate of Authenticity is located on the bottom of the computer.
- Regulatory label—Provides regulatory information about the computer. The regulatory label is located on the bottom of the computer.
- Wireless certification label(s)—Provide information about optional wireless devices and the approval markings of some of the countries or regions in which the devices have been approved for use. An optional device may be a wireless local area network (WLAN) device or an optional Bluetooth® device. If your computer model includes one or more wireless devices, one or more

certification labels are included with your computer. You may need this information when traveling internationally. Wireless certification labels are affixed to the bottom of the computer.

- SIM label (select models only)—Provides the ICCID (Integrated Circuit Card Identifier) of your SIM. This label is located inside the battery bay.
- HP Mobile Broadband Module serial number label (select models only)—Provides the serial number of your HP Mobile Broadband Module. This label is located inside the battery bay.

B Troubleshooting

If you experience computer problems, perform these troubleshooting steps in the sequence provided until the problem is resolved:

1. Refer to “Quick troubleshooting,” the next section in this appendix.
2. Access Web site links and additional information about the computer through Help and Support. Click **Start**, and then click **Help and Support**.
3. Contact customer support. Refer to “Contacting customer support,” later in this appendix.

Quick troubleshooting

The computer is unable to start up

If the computer does not turn on when you slide the power switch, the following suggestions may help you resolve the problem:

- If the computer is plugged into an AC outlet, unplug the computer, and then plug another electrical device into the outlet to be sure that the outlet is providing adequate power.
-
-  **NOTE:** Use only the AC adapter provided with the computer or one approved by HP for this computer.
-
- If the computer is running on battery power, or if it is plugged into an external power source other than an AC outlet, plug the computer into an AC outlet using the AC adapter. Be sure that the power cord and AC adapter connections are secure.

The TouchPad is behaving erratically

If the TouchPad is behaving erratically, follow these guidelines:

- Be sure that TouchPad is on. If the TouchPad light is amber, lightly press and hold the TouchPad on/off button for 2 seconds to turn on the TouchPad. If the TouchPad light is off, the TouchPad is on.
- Follow these guidelines when using the TouchPad:
 - Use one finger to navigate, click, or turn on/turn off the TouchPad.
 - Use 2 fingers to control TouchPad gestures, such as scrolling, pinching/zooming, and rotating.

 **NOTE:** To turn the TouchPad gestures off or explore other TouchPad features, click the **Synaptics** icon in the notification area at the far right of the taskbar, click the **Device Settings** tab, and then click **Settings**.

The computer screen is blank

If the screen is blank, but the computer is on and the power light is on, the computer may not be set to display the image on the computer screen. To transfer the image to the computer screen, press the [switch screen image](#) key.

Software is functioning abnormally

If the software is unresponsive or responds abnormally, follow these suggestions:

- Restart the computer by clicking **Start**, clicking the arrow next to **Shut down**, and then clicking **Restart**.

If you cannot restart the computer using this procedure, refer to the next section, “The computer is on but is not responding.”

- Run a virus scan. For information about using the antivirus resources on the computer, refer to the antivirus software Help for more details.

The computer is on but is not responding

If the computer is on but is not responding to software or keyboard commands, try the following emergency shutdown procedures, in the sequence provided, until shutdown occurs:

△ **CAUTION:** Emergency shutdown procedures will result in the loss of unsaved information.

- Slide and hold the power switch on the computer for at least 5 seconds.
- Disconnect the computer from external power and remove the battery.

The computer is unusually warm

It is normal for the computer to feel warm to the touch while it is in use. But if the computer feels *unusually* warm, it may be overheating because a vent is blocked.

If you suspect that the computer is overheating, turn off the computer to allow the computer to cool to room temperature. Then be sure to keep all vents free from obstructions while you are using the computer.

△ **WARNING!** To reduce the possibility of heat-related injuries or of overheating the computer, do not place the computer directly on your lap or obstruct the computer air vents. Use the computer only on a hard, flat surface. Do not allow another hard surface, such as an adjoining optional printer, or a soft surface, such as pillows or rugs or clothing, to block airflow. Also, do not allow the AC adapter to contact the skin or a soft surface, such as pillows or rugs or clothing, during operation. The computer and the AC adapter comply with the user-accessible surface temperature limits defined by the International Standard for Safety of Information Technology Equipment (IEC 60950).

📝 **NOTE:** The fan in the computer starts up automatically to cool internal components and prevent overheating. It is normal for the internal fan to cycle on and off during routine operation.

Checking your audio functions

To check the system sound on your computer, follow these steps:

1. Select **Start > Control Panel**.
2. Click **Hardware and Sound**.
3. Click **Sound**.
4. When the Sound window opens, click the **Sounds** tab. Under **Program Events**, select any sound event, such as a beep or alarm, and click the **Test** button.

You should hear sound through the speakers or through connected headphones.

To check the record functions of the computer, follow these steps:

1. Select **Start > All Programs > Accessories > Sound Recorder**.
2. Click **Start Recording** and speak into the microphone. Save the file to your desktop.
3. Open Windows Media Player or MediaSmart and play back the sound.

 **NOTE:** For best results when recording, speak directly into the microphone and record sound in a setting free of background noise.

To confirm or change the audio settings on your computer, select **Start > Control Panel > Hardware and Sound > Sound**.

An external device is not working

Follow these suggestions if an external device does not function as expected:

- Turn on the device according to the manufacturer's instructions.
- Be sure that all device connections are secure.
- Be sure that the device is receiving electrical power.
- Be sure that the device, especially if it is older, is compatible with the operating system.
- Be sure that the correct drivers are installed and updated.

The wireless network connection is not working

If a wireless network connection is not working as expected, follow these suggestions:

- Select **Start > Control Panel > Network and Internet > Network and Sharing**.
- Be sure that the wireless device is turned on (wireless light is off). If the light is amber, press the [wireless](#) key to turn on the wireless device.
- Be sure that the computer wireless antennas are free from obstructions.
- Be sure that the cable or DSL modem and its power cord are properly connected and that the lights are on.
- Be sure that the wireless router or access point is properly connected to its power adapter and the cable or DSL modem, and that the lights are on.
- Turn the wireless device off and then on again to resynchronize the device.
- Disconnect and then reconnect all cables, and turn the power off and then back on.

 **NOTE:** For more information on wireless technology, refer to the relevant help topics and Web site links in Help and Support.

NOTE: For information on activating mobile broadband service, refer to the mobile network operator information included with your computer.

Cannot connect to a preferred network

Windows can automatically repair a corrupted WLAN connection:

- If there is a network icon in the notification area, at the far right of the taskbar, right-click the icon, and then click **Diagnose and repair** from the menu.

Windows resets your network device and attempts to reconnect to one of the preferred networks.

- If there is no network icon in the notification area, follow these steps:
 1. Select **Start > Control Panel > Network and Internet > Network and Sharing Center**.
 2. Click **Troubleshoot problems** and select the network you wish to repair.

Network icon for WLAN is not displayed

If the network icon is not displayed in the notification area after you configure the WLAN, the software driver is either missing or corrupted. A Windows “Device not Found” error message may also be displayed. The driver must be reinstalled.

Get the latest version of the WLAN device software and drivers for your computer from the HP Web site at <http://www.hp.com>:

1. Open your Internet browser and go to <http://www.hp.com/support>.
2. Select your country or region.
3. Click the option for software and driver downloads, and then type your computer model number in the search box.
4. Press **enter**, and then follow the on-screen instructions.

Current WLAN network security codes are unavailable

If you are prompted for a network key or a name (SSID) when connecting to a WLAN, the network is protected by security. You must have the current codes to make a connection on a secure network. The SSID and network key are alphanumeric codes that you enter into your computer to identify your computer to the network.

- For a network connected to your personal wireless router, review the router user guide for instructions on setting up the same codes on both the router and the WLAN device.
- For a private network, such as a network in an office or at a public Internet chat room, contact the network administrator to obtain the codes, and then enter the codes when prompted to do so.

Some networks change the SSID or network keys used in their routers or access points on a regular basis to improve security. You must change the corresponding code in your computer accordingly.

If you are provided with new wireless network keys and SSID for a network, and if you have previously connected to that network, follow the steps below to connect to the network:

1. Select **Start > Control Panel > Network and Internet > Network and Sharing Center**.
2. Click **Manage wireless networks** in the left panel.

A list showing the available WLANs is displayed. If you are in a hotspot where several WLANs are active, several will be displayed.

3. Select the network in the list, right-click the network, and then click **Properties**.

 **NOTE:** If the network you want is not listed, check with the network administrator to be sure that the router or access point is operating.

4. Click the **Security** tab and enter the correct wireless encryption data into the **Network security key** box.
5. Click **OK** to save these settings.

WLAN connection is very weak

If the connection is very weak, or if your computer cannot make a connection to a WLAN, minimize interference from other devices, as follows:

- Move your computer closer to the wireless router or access point.
- Temporarily disconnect devices such as a microwave, cordless phone, or cellular phone to be sure that other wireless devices are not interfering.

If the connection does not improve, try forcing the device to reestablish all connection values:

1. Select **Start > Control Panel > Network and Internet > Network and Sharing Center**.
2. Click **Manage wireless networks** in the left pane.

A list showing the available WLANs is displayed. If you are in a hotspot where several WLANs are active, several will be displayed.

3. Click a network, and then click **Remove**.

Cannot connect to the wireless router

If you are trying to connect to the wireless router and are unsuccessful, reset the wireless router by removing power from the router for 10 to 15 seconds.

If the computer still cannot make a connection to a WLAN, restart the wireless router. For details, refer to the router manufacturer's instructions.

Contacting customer support

If the information provided in this guide or Help and Support does not address your questions, you can contact HP Customer Support at <http://www.hp.com/go/contactHP>.

Here you can:

- Chat online with an HP technician.

 **NOTE:** When technical support chat is not available in a particular language, it is available in English.

- E-mail HP Customer Support.
- Find HP Customer Support worldwide telephone numbers.
- Locate an HP service center.

Index

- A**
 - AC adapter
 - testing 51
 - AC power, connecting 50
 - action key mode 80
 - action keys
 - adjusting volume 33
 - audio CD, DVD, or BD
 - controls 33
 - decrease screen brightness 33
 - Help and Support 32
 - identifying 10
 - increase screen brightness 33
 - muting speaker sound 33
 - switching screen image 33
 - using 32
 - volume 37
 - wireless 17, 33
 - administrator password
 - creating 68
 - entering 68
 - managing 68
 - airport security devices 55
 - antivirus software, using 69
 - audio devices, connecting
 - external 38
 - audio functions, checking 88
 - audio-in (microphone) jack, identifying 12
 - audio-out (headphone) jack, identifying 12
- B**
 - backing up
 - customized window, toolbar, and menu bar settings 74
 - personal files 74
 - templates 74
 - battery
 - calibrating 49
 - charging 47
 - conserving power 44
 - discharging 48
 - disposing 50
 - inserting 46
 - low battery levels 48
 - removing 46
 - replacing 50
 - storing 49
 - battery bay 85
 - battery bay, identifying 14
 - Battery Check 46
 - battery light 12, 47
 - battery power 45
 - battery release latch 14, 46
 - battery temperature 49
 - bays
 - battery 85
 - BD drive 60
 - BIOS, updating 80
 - Bluetooth device 16
 - Bluetooth label 86
 - Bluetooth wireless devices 24
 - boot options 80
 - boot order 80
 - buttons
 - left TouchPad 8
 - right TouchPad 8
 - rotate 11
 - TouchPad on/off 8
 - wireless 11
- C**
 - cables
 - USB 54
 - calibrating battery 49
 - caps lock light, identifying 9
 - CD drive 60
 - Certificate of Authenticity label 85
 - charging batteries 47
 - checking audio functions 88
 - cleaning, TouchPad and keyboard 85
 - clicks
 - changing settings 32
 - testing 32
 - components
 - bottom 14
 - display 13
 - front 10
 - left-side 12
 - right-side 11
 - top 8
 - computer
 - traveling 84
 - configuring HDMI 41
 - Connect to the Internet Wizard 15, 16
 - connection, external power 51
 - connector, power 12
 - conservation, power 44
 - convertible hinge, identifying 13
 - critical battery level 42, 48
 - critical security updates, installing 70
 - customer support, contacting 91
- D**
 - default settings, restoring 78
 - Diagnostics menu 80
 - digital card
 - inserting 52
 - removing 53
 - supported formats 52
 - Digital Media Slot, identifying 12
 - Disk Cleanup software 56
 - Disk Defragmenter software 55
 - diskette drive 60
 - display
 - cleaning 84
 - display image, switching 33
 - drive light 56
 - drive light, identifying 9
 - drive media 43
 - drives
 - boot order 80
 - connecting external 60
 - diskette 60
 - external 60
 - handling 55

- hard 58, 59, 60
 - optical 60
- DVD drive 60

E

- encryption 21
- End hotkey 34
- entering a power-on password 69
- entering an administrator password 68
- esc key, identifying 10
- external audio devices, connecting 38
- external drive 60
- external monitor port 40
- external optical drive 37
- external WWAN antenna, identifying 10

F

- f11 76
- fan always on 79
- fingerprint reader
 - identifying 11
- fingerprints, registering 71
- firewall software 21, 69
- flicks
 - changing assignments 32
 - creating assignments 32
- fn key, identifying 10, 33
- full system recovery 73

H

- hard disk drive
 - external 60
 - installing 59
 - removing 58
- hard drive
 - external 60
 - HP ProtectSmart Hard Drive Protection 56
 - installing 59
 - removing 58
- hard drive bay, identifying 14
- HDMI
 - configuring 41
 - connecting 40
- HDMI port, identifying 12, 40
- headphone (audio-out) jack 12
- Help and Support key 32

Hibernation

- exiting 43
- initiated during critical battery level 48
- initiating 43
- high-definition devices, connecting 40
- hinge, identifying 13
- Home hotkey 34
- hotkeys
 - description 33
 - display system information 34
 - End 34
 - Home 34
 - page down 34
 - page up 34
 - using 34
- HP Mobile Broadband Module 22
- HP ProtectSmart Hard Drive Protection 56
- HP USB Ethernet Adapter
 - connecting 25
- hubs 53

I

- icons
 - network 16, 90
 - wireless 16
- input power 83
- Instant Web
 - disabling 7
 - enabling 7
 - starting 6
 - using 6
- instant Web
 - starting Windows 6
- integrated webcam light, identifying 13
- interference, minimizing 91
- internal microphones, identifying 13
- Internet
 - choosing an ISP 15
- Internet connection setup 19
- Internet Service & Offers 15
- Internet Service Provider (ISP) 15

J

- jacks
 - audio-in (microphone) 12
 - audio-out (headphone) 12

K

- keyboard hotkeys, identifying 33
- keyboard, cleaning 85
- keys
 - action 10
 - esc 10
 - fn 10
 - mute 37
 - Windows application 10
 - Windows logo 10

L

- labels
 - Bluetooth 86
 - Microsoft Certificate of Authenticity 85
 - regulatory 85
 - service tag 85
 - wireless certification 86
 - WLAN 86
- language support 79
- latch, battery release 14
- lights
 - battery 12
 - caps lock 9
 - drive 9, 56
 - mute 9
 - power 11
 - TouchPad 9
 - webcam 13
 - wireless 9, 11
- local area network (LAN)
 - cable required 25
 - connecting cable 25
- low battery level 48

M

- Main menu 79
- maintenance
 - Disk Cleanup 56
 - Disk Defragmenter 55
- managing a power-on password 69
- managing an administrator password 68
- media activity keys 35

- media controls, keys 33
 - MediaSmart
 - using 36
 - MediaSmart software 36
 - memory module
 - inserting 64
 - removing 64
 - memory module compartment
 - cover
 - removing 63
 - replacing 65
 - memory module compartment, identifying 14
 - memory test 80
 - microphone (audio-in) jack, identifying 12
 - Microsoft Certificate of Authenticity label 85
 - minimizing interference 91
 - monitor, connecting 40
 - mouse, external
 - setting preferences 26
 - multimedia software
 - installing 37
 - using 36
 - mute key
 - identifying 33
 - using 37
 - mute light, identifying 9
- N**
- network cable, connecting 25
 - network icon 16, 90
 - network key 90
 - network security codes
 - network key 90
 - SSID 90
- O**
- operating environment 83
 - operating system
 - Microsoft Certificate of Authenticity label 85
 - Product Key 85
 - optical drive
 - external 37
 - sharing 37, 61
 - optical drive, external 60
- P**
- page down hotkey 34
 - page up hotkey 34
 - passwords
 - administrator 68
 - power-on 68
 - set in Setup Utility 67
 - set in Windows 67
 - pen
 - identifying 28
 - storing 28
 - using 28
 - pen holder 28
 - pen holder, identifying 13
 - pen tether eyelet 28
 - pinching TouchPad gesture 27, 31
 - pointing devices
 - setting preferences 26
 - ports
 - external monitor 40
 - HDMI 12, 40
 - USB 12, 53
 - power
 - connecting 51
 - conserving 44
 - power connector, identifying 12
 - power light, identifying 11
 - power switch, identifying 11
 - power-on password
 - creating 69
 - entering 69
 - managing 69
 - primary hard disk self test 80
 - Product Key 85
 - product name and number, computer 85
 - programs, using 36
 - projector, connecting 40
- Q**
- quick troubleshooting 87
- R**
- readable media 43
 - recovering a program or driver 73
 - recovering from the dedicated recovery partition 76
 - recovering from the recovery discs 76
 - recovery discs 73
 - recovery discs, creating 4
 - Recovery Manager 73, 76
 - recovery partition 73
 - recovery, system 76
 - regulatory information
 - regulatory label 85
 - wireless certification labels 86
 - restore points 75
 - rotate button, identifying 11
 - rotating TouchPad gesture 27, 30
 - routine care 84
- S**
- screen brightness keys 33
 - screen image, switching 33
 - scrolling TouchPad gesture 26, 30
 - security cable slot, identifying 13
 - security cable, installing 70
 - Security menu 79
 - security, wireless 21
 - serial number, computer 85
 - service tag 85
 - setup of WLAN 19
 - Setup Utility
 - changing the language 77
 - displaying system information 78
 - exiting 79
 - menus 79
 - navigating 78
 - passwords set in 67
 - restoring default settings 78
 - selecting 78
 - starting 77
 - shared drives 61
 - shutdown 42
 - SIM
 - inserting 22
 - removing 23
 - Sleep
 - exiting 43
 - initiating 43
 - slots
 - Digital Media 12
 - memory 63
 - security cable 13
 - software
 - Disk Cleanup 56
 - Disk Defragmenter 55

- MediaSmart 36
- TouchSmart 36
- using 36
- Wireless Assistant 18
- solid-state drive (SSD) 73, 76
- speakers, identifying 13
- storing battery 49
- supported discs 73
- switch
 - power 11
- System Configuration menu 79
- system failure or instability 73
- system information hotkey 34
- system information,
 - displaying 78, 79
- system recovery 76
- system restore points 73, 75

T

- temperature 49
- touch screen
 - performing screen actions 29
 - preferences 32
 - using 29
- TouchPad
 - buttons 8
 - cleaning 85
 - gestures 26
 - identifying 8
 - using 26
- TouchPad gestures
 - pinching 27, 31
 - rotating 27, 30
 - scrolling 26, 30
 - zooming 27, 31
- TouchPad light, identifying 9
- TouchPad on/off button 8
- TouchSmart
 - starting 36
 - using 36
- TouchSmart software 36
- traveling with the computer 49, 84, 86
- troubleshooting
 - computer is unable to start up 87
 - computer screen is blank 87
 - TouchPad 87
- turning off the computer 42

U

- unresponsive system 42
- USB cable, connecting 54
- USB devices
 - connecting 53
 - description 53
 - removing 54
- USB hubs 53
- USB port, identifying 12
- USB ports, identifying 12, 53
- using system restore 75

V

- vents, identifying 10, 12, 14
- Virtualization Technology 79
- volume
 - adjust 37
 - keys 37
 - mute 37
- volume keys, identifying 33

W

- webcam
 - adjusting properties 39
 - identifying 13
- webcam light, identifying 13
- Windows application key,
 - identifying 10
- Windows Connect to the Internet Wizard 16
- Windows logo key, identifying 10
- Windows, passwords set in 67
- wireless
 - protecting 21
 - set up 19
- wireless antennas, identifying 13
- Wireless Assistant software 16, 18
- wireless button, identifying 11
- wireless certification label 86
- wireless controls
 - key 16
 - operating system 16
 - Wireless Assistant software 16
- wireless icon 16
- wireless key
 - identifying 33
 - using 16, 17
- wireless light 9, 11, 16

- wireless network (WLAN)
 - equipment needed 19
 - security 21
- WLAN antennas, identifying 13
- WLAN device 86
- WLAN label 86
- writable media 43
- WWAN antennas, identifying 13
- WWAN device 21

Z

- zooming TouchPad gesture 27, 31

Antenna House XSL Formatter