



# HCT CO., LTD.

Product Compliance Division

TEL : +82 31 639 8518 FAX : +82 31 639 8525

## CERTIFICATE OF COMPLIANCE FCC Part 24 & 22 Certification

**Applicant Name:**  
PANTECH&CURITEL COMMUNICATION, INC.

**Address:**  
PANTECH Building, I-2, DMC, Sangam-dong,  
Mapo-gu, Seoul, 121-792, Korea

**Date of Issue:**

April 2, 2009

**Test Site/Location:**

HCT.CO., LTD., San 136-1 Ami-ri, Bubal-eup, Icheon-si,  
Kyoungki-do, Korea

**Test Report No.:** HCT-RF09-0403

**HCT FRN:** 0005866421

**FCC ID : PP4ZEPHYR**

**APPLICANT : PANTECH&CURITEL COMMUNICATION, INC.**

**Application Type:** Certification

**FCC Classification:** Licensed Portable Transmitter Held to Ear (PCE)

**FCC Rule Part(s):** §22, §24, §2

**EUT Type:** Dual-Band Dual-Mode CDMA/GSM Phone with Bluetooth

**Model(s):** WP8990

**Tx Frequency:** 824.70 — 848.31 MHz (CDMA)  
1 851.25 — 1 908.75 MHz (PCS CDMA)  
824.20 - 848.80 MHz (GSM850)  
1 850.20 – 1 909.80 MHz (GSM1900)

**Rx Frequency:** 869.70 — 893.31 MHz (CDMA)  
1 931.25 — 1 988.75 MHz (PCS CDMA)  
869.20 - 893.80 MHz (GSM850)  
1 930.20 – 1 989.80 MHz (GSM1900)

**Max. RF Output Power:** 0.358 W ERP CDMA ( 25.54 dBm) / 0.760 W EIRP PCS CDMA ( 28.81 dBm)  
1.629 W ERP GSM850 (32.12 dBm) / 1.318 W EIRP GSM1900 (31.20 dBm)

**Emission Designator(s):** 1M28F9W (CDMA), 1M29F9W (PCS CDMA)  
247KGXW (GSM850) 249KGXW (GSM1900)

The measurements shown in this report were made in accordance with the procedures specified in §2.947. I assume full responsibility for the accuracy and completeness of these measurements, and for the qualifications of all persons taking them.

HCT.CO., LTD. Certifies that no party to this application has been denied FCC benefits pursuant to section 5301 of the Anti-Drug Abuse Act of 1998, 21 U.S.C. 853(a)

**Report prepared by**

**: Jong Seok Lee**

**Test engineer of RF Part**

**Approved by**

**: Sang Jun Lee**

**Manager of RF Part**

This report only responds to the tested sample and may not be reproduced, except in full, without written approval of the HCT Co., Ltd.

FCC CERTIFICATION REPORT			<a href="http://www.hct.co.kr">www.hct.co.kr</a>	
Test Report No. HCT-RF09-0403	Date of Issue: April 2, 2009	EUT Type: Dual-Band Dual-Mode CDMA/GSM Phone with Bluetooth	FCC ID: PP4ZEPHYR	Page 1 of 50



# Table of Contents

1. GENERAL INFORMATION .....	3
2. INTRODUCTION.....	4
2.1. EUT DESCRIPTION.....	4
2.2. MEASURING INSTRUMENT CALIBRATION .....	4
2.3. TEST FACILITY .....	4
3. DESCRIPTION OF TESTS.....	5
3.1 Effective Radiated Power/Equivalent Isotropic Radiated Power.....	5
3.2 Peak- to- Average Ratio .....	6
3.3 Occupied bandwidth.....	6
3.4 Spurious and Harmonic Emissions at Antenna Terminal.....	7
3.5 Radiated Spurious and Harmonic Emissions .....	8
3.6 Frequency stability / variation of ambient temperature.....	9
4. LIST OF TEST EQUIPMENT .....	10
5. SUMMARY OF TEST RESULTS .....	11
6. SAMPLE CALCULATION.....	12
7. TEST DATA .....	13
7.1 Conducted Output Power.....	13
7.2 Peak-to-Average Ratio .....	14
7.3 Effective Radiated Power Output (CDMA / GSM).....	15
7.4 Equivalent Isotropic Radiated Power (E.I.R.P.) (CDMA / GSM) .....	16
7.5 Radiated Spurious Emissions .....	17
7.5.1 Radiated Spurious Emissions (CDMA Mode).....	17
7.5.2 Radiated Spurious Emissions (PCS CDMA).....	18
7.5.3 Radiated Spurious Emissions (GSM850).....	19
7.5.4 Radiated Spurious Emissions (GSM1900) .....	20
7.6 Frequency stability / variation of ambient temperature.....	21
7.6.1 FREQUENCY STABILITY (CDMA).....	21
7.6.2 FREQUENCY STABILITY (PCS CDMA).....	22
7.6.3 FREQUENCY STABILITY (GSM850) .....	23
7.6.4 FREQUENCY STABILITY (GSM1900) .....	24
8. TEST PLOTS.....	25



# MEASUREMENT REPORT

## 1. GENERAL INFORMATION

**Applicant Name:** PANTECH&CURITEL COMMUNICATION, INC.  
**Address:** PANTECH Building, I-2, DMC, Sangam-dong, Mapo-gu, Seoul, 121-792, Korea

**FCC ID:** PP4ZEPHYR  
**Application Type:** Certification  
**FCC Classification:** Licensed Portable Transmitter Held to Ear (PCE)  
**FCC Rule Part(s):** §22, §24, §2  
**EUT Type:** Dual-Band Dual-Mode CDMA/GSM Phone with Bluetooth

**Model(s):** WP8990  
**Tx Frequency:** 824.70 — 848.31 MHz (CDMA)  
1 851.25 — 1 908.75 MHz (PCS CDMA)  
824.20 - 848.80 MHz (GSM850)  
1 850.20 – 1 909.80 MHz (GSM1900)

**Rx Frequency:** 869.70 — 893.31 MHz (CDMA)  
1 931.25 — 1 988.75 MHz (PCS CDMA)  
869.20 - 893.80 MHz (GSM850)  
1 930.20 – 1 989.80 MHz (GSM1900)

**Max. RF Output Power:** 0.358 W ERP CDMA ( 25.54 dBm) / 0.760 W EIRP PCS CDMA ( 28.81 dBm)  
1.629 W ERP GSM850 (32.12 dBm) / 1.318 W EIRP GSM1900 (31.20 dBm)

**Emission Designator(s):** 1M28F9W (CDMA), 1M29F9W (PCS CDMA)  
247KGXW (GSM850) 249KGXW (GSM1900)

**Antenna Specification** Manufacturer: Laird Technologies Korea  
Antenna type: Internal Antenna  
Peak Gain : 1.62 dBi

**Date(s) of Tests:** March 25, 2009 ~ March 30, 2009

**Place of Tests:** HCT.CO., LTD.  
San 136-1 Ami-ri, Bubal-eup, Icheon-si,

**Report Serial No** HCT-RF09-0403

FCC CERTIFICATION REPORT				<a href="http://www.hct.co.kr">www.hct.co.kr</a>
Test Report No. HCT-RF09-0403	Date of Issue: April 2, 2009	EUT Type: Dual-Band Dual-Mode CDMA/GSM Phone with Bluetooth	FCC ID: PP4ZEPHYR	Page 3 of 50



## 2. INTRODUCTION

### 2.1. EUT DESCRIPTION

The PANTECH&CURITEL COMMUNICATION, INC. WP8990 Dual-Band Dual-Mode CDMA/GSM Phone with Bluetooth consists of GSM850, GSM1900, GPRS Class10 and CDMA, PCS CDMA.

### 2.2. MEASURING INSTRUMENT CALIBRATION

The measuring equipment, which was utilized in performing the tests documented herein, has been calibrated in accordance with the manufacturer's recommendations for utilizing calibration equipment, which is traceable to recognized national standards.

### 2.3. TEST FACILITY

The open area test site and conducted measurement facility used to collect the radiated data are located at the 254-1, Maekok-Ri, Hobup-Myun, Ichon-Si, Kyoungki-Do, 467-701, KOREA. The site is constructed in conformance with the requirements of ANSI C63.4 and CISPR Publication 22. Detailed description of test facility was submitted to the Commission and accepted dated July 6, 2006(Registration Number: 90661)

FCC CERTIFICATION REPORT				<a href="http://www.hct.co.kr">www.hct.co.kr</a>
Test Report No. HCT-RF09-0403	Date of Issue: April 2, 2009	EUT Type: Dual-Band Dual-Mode CDMA/GSM Phone with Bluetooth	FCC ID: PP4ZEPHYR	Page 4 of 50

### 3. DESCRIPTION OF TESTS

#### 3.1 Effective Radiated Power/Equivalent Isotropic Radiated Power

##### Test Set-up

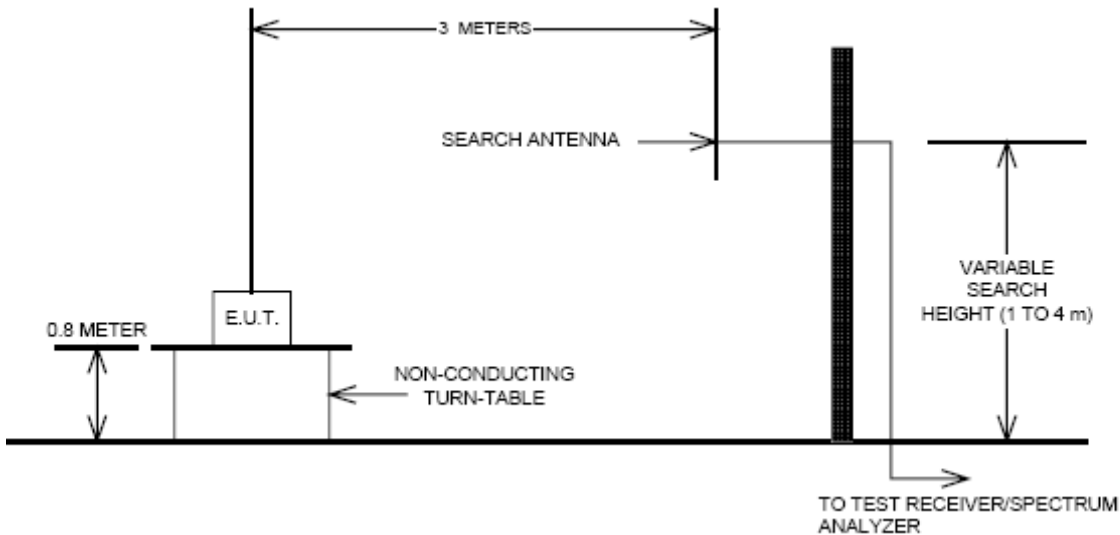

##### Test Procedure

Radiated emission measurements were performed at an open Site.

The equipment under test is placed on a wooden turntable 3-meters from the receive antenna.

A wooden turntable was rotated 360° and the receiving antenna scanned from 1-4m in order to capture the maximum emission. A half wave dipole was substituted in place of the EUT. This dipole antenna was driven by a signal generator and the previously recorded signal was duplicated.

The maximum EIRP was calculated by adding the forward power to the calibrated source plus its appropriate gain value. These steps were carried out with the receiving antenna in both vertical and horizontal polarization. For readings above 1GHz, the above procedure is repeated using horn antennas and the difference between the gain of the horn and an isotropic antenna are taken into consideration.

Note : This device was tested under all R.C.s and S.O.s and worst case is reported with RC3/SO55, with 'All Up' power control bits.

### 3.2 Peak- to- Average Ratio

A peak to average ratio measurement is performed at the conducted port of the EUT. For CDMA and WCDMA signals, the spectrum analyzers Complementary Cumulative Distribution Function ( CCDF ) measurement profile is used to determine the largest deviation between the average and the peak power of the EUT in a given bandwidth. The CCDF curve shows how much time the peak waveform spends at or above a given average power level. The percent of time the signal spends at or above the level defines the probability for that particular power level. For GSM signals, an average and a peak trace are used on a spectrum analyzer to determine the largest deviation between the average and the peak power of the EUT in a bandwidth greater than the emission bandwidth. Plots of the EUT’s Peak- to- Average Ratio are shown herein.

Note : This device was tested under all R.C.s and S.O.s and worst case is reported with RC3/SO55, with ‘All Up’ power control bits.

### 3.3 Occupied bandwidth.

#### Test set-up

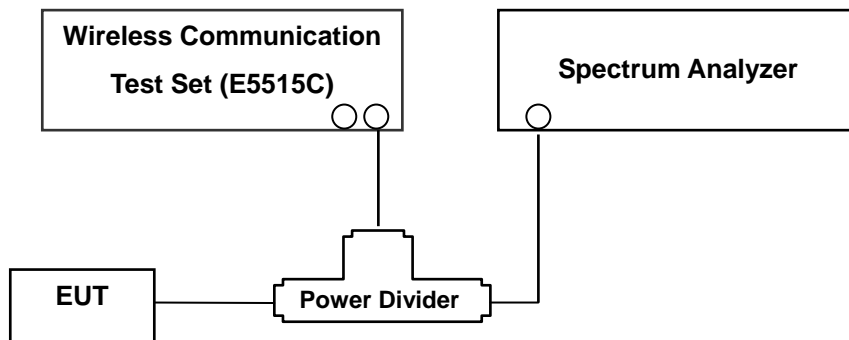

(Configuration of conducted Emission measurement)  
Test Procedure

The EUT was setup to maximum output power at its lowest channel. The occupied bandwidth was measured using a spectrum analyzer. The measurements are repeated for the highest and a middle channel. The EUT’s occupied bandwidth is measured as the width of the signal between two points, one below the carrier center frequency and one above the carrier frequency, outside of which all emissions are attenuated at least 26 dB below the transmitter power. Plots of the EUT’s occupied bandwidth are shown herein.

Note : This device was tested under all R.C.s and S.O.s and worst case is reported with RC3/SO55, with ‘All Up’ power control bits.



### 3.4 Spurious and Harmonic Emissions at Antenna Terminal.

#### Test Procedure

The level of the carrier and the various conducted spurious and harmonic frequencies is measured by means of a calibrated spectrum analyzer.

The EUT was setup to maximum output power at its lowest channel. The Resolution BW of the analyzer is set to 1 % of the emission bandwidth to show compliance with the – 13 dBm limit, in the 1 MHz bands immediately outside and adjacent to the edge of the frequency block. The 1 MHz RBW was used to scan from 10 MHz to 10 GHz. (GSM1900 Mode: 10 MHz to 20 GHz). A display line was placed at – 13 dBm to show compliance. The high, lowest and a middle channel were tested for out of band measurements.

- Band Edge Requirement : In the 1MHz bands immediately outside and adjacent to the frequency block, a resolution bandwidth of at least 1 percent of the emission bandwidth of the fundamental emission of the transmitter may be employed to measure the out of band Emissions. Limit, -13dBm.

Note : This device was tested under all R.C.s and S.O.s and worst case is reported with RC3/SO55, with 'All Up' power control bits.

FCC CERTIFICATION REPORT				<a href="http://www.hct.co.kr">www.hct.co.kr</a>
Test Report No. HCT-RF09-0403	Date of Issue: April 2 , 2009	EUT Type: Dual-Band Dual-Mode CDMA/GSM Phone with Bluetooth	FCC ID: PP4ZEPHYR	Page 7 of 50

### 3.5 Radiated Spurious and Harmonic Emissions

#### Test Set-up

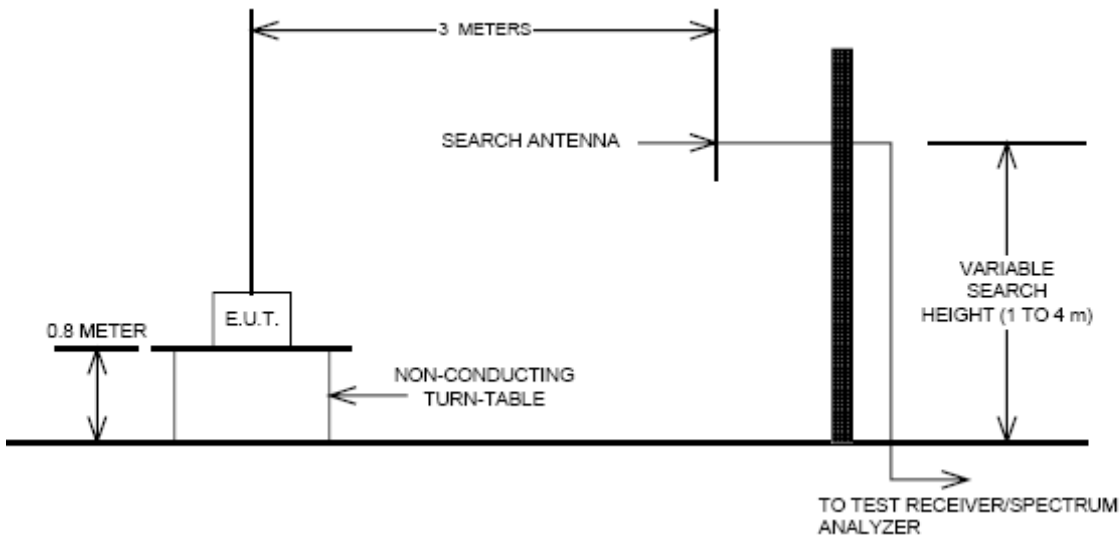

The measurement facilities used for this test have been documented in previous filings with the commission pursuant to section § 2.948. The open field test site is situated in open field with ground screen whose site attenuation characteristics meet ANSI C63.4 –2003. A mast capable of lifting the receiving antenna from a height of one to four meters is used together with a rotatable wooden platform mounted at three from the antenna mast.

- 1) The unit mounted on a wooden table 1.5 m × 1.0 m × 0.80 m is 0.8 meter above test site ground level.
- 2) During the emission test, the turntable is rotated and the EUT is manipulated to find the configuration resulting in maximum emission under normal condition of installation and operation.
- 3) The antenna height and polarization are also varied from 1 to 4 meters until the maximum signal is found.
- 4) The spectrum shall be scanned up to the 10<sup>th</sup> harmonic of the fundamental frequency.

#### Test Procedure

The equipment under test is placed on a wooden turntable 3-meters from the receive antenna. A wooden turntable was rotated 360° and the receiving antenna scanned from 1-4m in order to capture the maximum emission. A half wave dipole was substituted in place of the EUT. This dipole antenna was driven by a signal generator and the previously recorded signal was duplicated.

The maximum EIRP was calculated by adding the forward power to the calibrated source plus its appropriate gain value. These steps were carried out with the receiving antenna in both vertical and horizontal polarization. For readings above 1GHz, the above procedure is repeated using horn antennas and the difference between the gain of the horn and an isotropic antenna are taken into consideration.

Note : This device was tested under all R.C.s and S.O.s and worst case is reported with RC3/SO55, with 'All Up' power control bits.



### 3.6 Frequency stability / variation of ambient temperature

#### Test Set-up

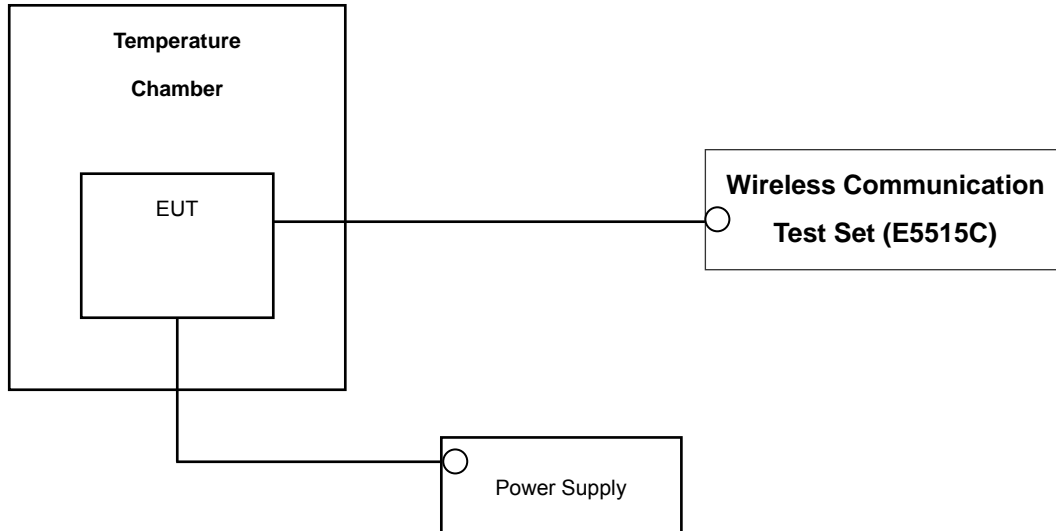

\* Nominal Operating Voltage

#### Test Procedure

The frequency stability of the transmitter is measured by:

- a.) **Temperature:** The temperature is varied from - 30 °C to + 50 °C using an environmental chamber.
- b.) **Primary Supply Voltage:** The primary supply voltage is varied from battery end point to 115 % of the voltage normally at the input to the device or at the power supply terminals if cables are not normally supplied.

Specification — the frequency stability shall be sufficient to ensure that the fundamental emission stays within the authorized frequency block. The frequency stability of the transmitter shall be maintained within  $\pm 0.00025\%$  ( $\pm 2.5$  ppm) of the center frequency.

#### Time Period and Procedure:

The carrier frequency of the transmitter is measured at room temperature (20°C to provide a reference).

1. The equipment is turned on in a “standby” condition for one minute before applying power to the transmitter. Measurement of the carrier frequency of the transmitter is made within one minute after applying power to the transmitter.
2. Frequency measurements are made at 10°C intervals ranging from -30°C to +50°C. A period of at least one half-hour is provided to allow stabilization of the equipment at each temperature level.

**NOTE: The EUT is tested down to the battery endpoint.**

Note : This device was tested under all R.C.s and S.O.s and worst case is reported with RC3/SO55, with ‘All Up’ power control bits.



## 4. LIST OF TEST EQUIPMENT

Manufacture	Model/ Equipment	Serial Number	Calibration Interval	Calibration Due
R&S	ESI40/ Spectrum Analyzer	831564/003	Annual	10/31/2009
Agilent	E4416A/ Power Meter	GB41291412	Annual	01/21/2010
Agilent	E9327A/ Power Sensor	MY4442009	Annual	07/28/2009
Agilent	8960 (E5515C)/ Base Station	GB44400269	Annual	02/10/2010
MITEQ	AMF-60-0010 1800-35-20P / AMP	1200937	Annual	05/20/2009
Wainwright	WHK1.2/15G-10EF/H.P.F	2	Annual	06/28/2009
Wainwright	WHK3.3/18G-10EF/H.P.F	1	Annual	06/28/2009
Agilent	775D/ Dual Directional Coupler	12922	Annual	12/24/2009
Agilent	11636B/ Power Divider	11377	Annual	12/24/2009
Digital	EP-3010/ Power Supply	3110117	Annual	01/07/2010
Schwarzbeck	UHAP/ Dipole Antenna	585	Annual	02/13/2011
Schwarzbeck	UHAP/ Dipole Antenna	558	Annual	02/13/2011
Korea Engineering	KR-1005L / Chamber	KRAB07063-2CH	Annual	12/31/2009
Schwarzbeck	VULB9160/ TRILOG Antenna	3150	Biennial	12/18/2010
Schwarzbeck	VULB9160/ TRILOG Antenna	3125	Biennial	05/16/2009
Schwarzbeck	BBHA 9120D/ Horn Antenna	147	Biennial	03/26/2010
Schwarzbeck	BBHA 9120D/ Horn Antenna	1201	Biennial	05/02/2009
Agilent	E4440A/Spectrum Analyzer	US45303008	Annual	12/23/2009



## 5. SUMMARY OF TEST RESULTS

FCC Part Section(s)	Test Description	Test Limit	Test Condition	Test Result
2.1049, 22.917(a), 24.238(a)	Occupied Bandwidth	N/A	CONDUCTED	PASS
2.1051, 22.917(a), 24.238(a)	Band Edge / Spurious and Harmonic Emissions at Antenna Terminal.	< $43 + \log_{10}(P[\text{Watts}])$ at Band Edge and for all out-of-band emissions		PASS
2.1046	Conducted Output Power	N/A		PASS
24.232(d)	Peak- to- Average Ratio	< 13 dB		PASS
2.1055, 22.355, 24.235	Frequency stability / variation of ambient temperature	< 2.5 ppm		PASS
22.913(a)(2) 24.232(c)	Effective Radiated Power	< 7 Watts max. ERP	RADIATED	PASS
	Equivalent Isotropic Radiated Power	< 2 Watts max. EIRP		PASS
2.1053, 22.917(a), 24.238(a)	Radiated Spurious and Harmonic Emissions	< $43 + \log_{10}(P[\text{Watts}])$ for all out-of band emissions		PASS



## 6. SAMPLE CALCULATION

### A. ERP Sample Calculation

Mode	Ch./ Freq.		Measured Level(dBm)	Substitute LEVEL(dBm)	Ant. Gain	C.L	Pol.	ERP	
	channel	Freq.(MHz)						W	dBm
GSM850	128	824.20	-11.56	34.28	-8.32	1.17	H	0.30	24.79

**ERP = SubstituteLEVEL(dBm) + Ant. Gain – CL(Cable Loss)**

- 1) The EUT mounted on a wooden tripod is 0.8 meter above test site ground level.
- 2) During the test , the turn table is rotated and the antenna height is also varied from 1 to 4 meters until the maximum signal is found.
- 3) Record the field strength meter's level.
- 4) Replace the EUT with dipole/Horn antenna that is connected to a calibrated signal generator.
- 5) Increase the signal generator output till the field strength meter's level is equal to the item (3).
- 6) The signal generator output level with Ant. Gain and cable loss are the rating of effective radiated power (ERP).

### B. Emission Designator

#### CDMA Emission Designator

**Emission Designator = 1M27F9W**

CDMA BW = 1.27 MHz (Measured at the 99% power bandwidth)

F = Frequency Modulation

9 = Composite Digital Info

W = Combination (Audio/Data)

#### GSM Emission Designator

**Emission Designator = 249KGXW**

GSM BW = 249 kHz

G = Phase Modulation

X = Cases not otherwise covered

W = Combination (Audio/Data)

FCC CERTIFICATION REPORT				<a href="http://www.hct.co.kr">www.hct.co.kr</a>
Test Report No. HCT-RF09-0403	Date of Issue: April 2, 2009	EUT Type: Dual-Band Dual-Mode CDMA/GSM Phone with Bluetooth	FCC ID: PP4ZEPHYR	Page 12 of 50



## 7. TEST DATA

### 7.1 Conducted Output Power

A base station simulator was used to establish communication with the EUT. The base station simulator parameters were set to produce the maximum power from the EUT. This device was tested under all configurations and the highest power is reported. Conducted Output Powers of EUT are reported below.

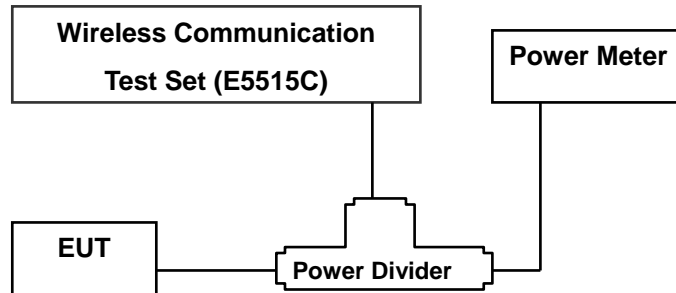

Test Result

Band	Channel	SO2	SO2	SO55	SO55	TDSO SO32
		RC1/1 (dBm)	RC3/3 (dBm)	RC1/1 (dBm)	RC3/3 (dBm)	RC3/3 (dBm)
CDMA	1013	24.65	24.62	24.60	24.70	24.54
	384	24.71	24.75	24.72	24.76	24.67
	777	24.50	24.51	24.52	24.56	24.46
PCS	25	24.70	24.66	24.65	24.68	24.63
	600	24.76	24.90	24.78	24.89	24.75
	1175	24.61	24.51	24.54	24.50	24.49

(CDMA Maximum Conducted Output Powers)



Band	Channel	Voice	GPRS Data	
		GSM (dBm)	GPRS 1 TX Slot (dBm)	GPRS 2 TX Slot (dBm)
GSM 850	128	32.80	32.81	32.18
	190	32.82	32.82	32.22
	251	32.75	32.75	32.16
GSM 1900	512	29.68	29.63	29.58
	661	29.67	29.60	29.55
	810	29.72	29.66	29.60

(GSM Maximum Conducted Output Powers)

## 7.2 Peak-to-Average Ratio

- Plots of the EUT's Peak- to- Average Ratio are shown Page 29, 32.



### 7.3 Effective Radiated Power Output (CDMA / GSM)

#### (CDMA Mode)

Ch./ Freq.		Measured Level(dBm)	Substitute LEVEL (dBm)	Ant. Gain (dBd)	C.L	Pol.	ERP	
channel	Freq.(MHz)						W	dBm
1013	824.70	-15.28	30.55	-8.31	1.17	H	0.13	21.07
384	836.52	-11.96	34.53	-8.22	1.19	H	0.33	25.12
777	848.31	-12.26	34.87	-8.13	1.20	H	0.36	25.54

#### (GSM850 Mode)

Ch./ Freq.		Measured Level(dBm)	Substitute LEVEL (dBm)	Ant. Gain (dBd)	C.L	Pol.	ERP	
channel	Freq.(MHz)						W	dBm
128	824.20	-8.39	37.45	-8.32	1.17	V	0.63	27.96
190	836.60	-6.43	40.06	-8.22	1.19	H	1.16	30.65
251	848.80	-5.68	41.44	-8.12	1.20	H	1.63	32.12

Note: Standard batteries are the only options for this phone

#### NOTES:

Effective Radiated Power Output Measurements by Substitution Method

according to ANSI/TIA/EIA-603-C-2004, Aug. 17, 2004:

The EUT was placed on a wooden turn table 3-meters from the receive antenna. The receive antenna height and turntable rotation was adjusted for the highest reading on the receive spectrum analyzer. For CDMA signals, a peak detector is used, with RBW = VBW = 3 MHz. For WCDMA signals, a peak detector is used, with RBW = VBW = 5MHz. For AMPS, GSM, and NADC TDMA signals, a peak detector is used, with RBW = VBW = 1 MHz. A half-wave dipole was substituted in place of the EUT. This dipole antenna was driven by a signal generator and the level of the signal generator was adjusted to obtain the same receive spectrum analyzer reading. The conducted power at the terminals of the dipole is measured. The ERP is recorded.

This device was tested under all configurations and the highest power is reported in CDMA mode and in GSM mode with using a Power Control Level of "0" in the PCS Band and "5" in the Cellular Band.

This unit was tested with its standard battery.



## 7.4 Equivalent Isotropic Radiated Power (E.I.R.P.) (CDMA / GSM)

### (PCS CDMA Mode)

Ch./ Freq.		Measured Level(dBm)	Substitute LEVEL (dBm)	Ant. Gain (dBi)	C.L	Pol.	EIRP	
channel	Freq.(MHz)						W	dBm
25	1,851.25	- 10.93	20.68	10.05	1.91	V	0.76	28.81
600	1,880.00	- 11.20	20.62	10.05	1.95	V	0.74	28.72
1175	1,908.75	- 11.90	20.00	10.06	1.97	V	0.64	28.09

### (GSM1900 Mode)

Ch./ Freq.		Measured Level(dBm)	Substitute LEVEL (dBm)	Ant. Gain (dBi)	C.L	Pol.	EIRP	
channel	Freq.(MHz)						W	dBm
512	1,850.20	- 10.90	20.71	10.05	1.91	V	0.77	28.84
661	1,880.00	- 9.75	22.07	10.05	1.95	V	1.04	30.17
810	1,909.80	- 8.79	23.11	10.06	1.97	V	1.32	31.20

Note: Standard batteries are the only options for this phone

#### NOTES:

Equivalent Isotropic Radiated Power Measurements by Substitution Method  
according to ANSI/TIA/EIA-603-C-2004, Aug. 17, 2004:

The EUT was placed on a wooden turn table 3-meters from the receive antenna. The receive antenna height and turntable rotation was adjusted for the highest reading on the receive spectrum analyzer. For CDMA signals, a peak detector is used, with RBW = VBW = 3 MHz. For WCDMA signals, a peak detector is used, with RBW = VBW = 5MHz. For AMPS, GSM, and NADC TDMA signals, a peak detector is used, with RBW = VBW = 1 MHz. A Horn antenna was substituted in place of the EUT. This Horn antenna was driven by a signal generator and the level of the signal generator was adjusted to obtain the same receive spectrum analyzer reading. The conducted power at the terminals of the Horn antenna is measured. The difference between the gain of the horn and an isotropic antenna is taken into consideration and the EIRP is recorded.

This device was tested under all configurations and the highest power is reported in CDMA mode and in GSM mode with using a Power Control Level of "0" in the PCS Band and "5" in the Cellular Band.

This unit was tested with its standard battery.

FCC CERTIFICATION REPORT				<a href="http://www.hct.co.kr">www.hct.co.kr</a>
Test Report No. HCT-RF09-0403	Date of Issue: April 2, 2009	EUT Type: Dual-Band Dual-Mode CDMA/GSM Phone with Bluetooth	FCC ID: PP4ZEPHYR	Page 16 of 50





## 7.5 Radiated Spurious Emissions

### 7.5.1 Radiated Spurious Emissions (CDMA Mode)

MEASURED OUTPUT POWER: 25.54 dBm = 0.358 W

MODULATION SIGNAL: CDMA

DISTANCE: 3 meters

LIMIT:  $-(43 + 10 \log_{10}(W)) =$  - 38.54 dBc

Ch.	Freq.(MHz)	Measured Level [dBm]	Ant. Gain (dBd)	Substitute Level [dBm]	C.L	Pol.	ERP (dBm)	dBc
1013	1,649.40	-35.34	7.09	-45.87	1.73	H	-40.51	-66.05
	2,474.10	-47.86	8.12	-54.97	2.28	H	-49.13	-74.67
	3,298.80	-43.69	9.72	-51.27	2.57	V	-44.12	-69.66
384	1,673.04	-42.62	7.23	-53.38	1.79	H	-47.94	-73.48
	2,509.56	-48.19	8.14	-55.32	2.33	H	-49.51	-75.05
	3,346.08	-42.57	9.99	-50.60	2.66	V	-43.27	-68.81
777	1,696.62	-38.86	7.41	-49.47	1.83	H	-43.89	-69.43
	2,544.93	-46.91	8.21	-54.19	2.34	H	-48.32	-73.86
	3,393.24	-45.00	9.91	-52.63	2.85	V	-45.57	-71.11

**NOTES:** Radiated Spurious Emission Measurements at 3 meters by Substitution Method  
according to ANSI/TIA/EIA-603-C-2004, Aug. 17, 2004:

FCC CERTIFICATION REPORT				<a href="http://www.hct.co.kr">www.hct.co.kr</a>
Test Report No. HCT-RF09-0403	Date of Issue: April 2, 2009	EUT Type: Dual-Band Dual-Mode CDMA/GSM Phone with Bluetooth	FCC ID: PP4ZEPHYR	Page 17 of 50



### 7.5.2 Radiated Spurious Emissions (PCS CDMA)

MEASURED OUTPUT POWER: 28.81 dBm = 0.760 W

MODULATION SIGNAL: PCS CDMA

DISTANCE: 3 meters

LIMIT: - (43 + 10 log<sub>10</sub> (W)) = - 41.81 dBc

Ch.	Freq.(MHz)	Measured Level [dBm]	Ant. Gain (dBi)	Substitute Level [dBm]	C.L	Pol.	EIRP (dBm)	dBc
25	3,702.50	-33.17	12.46	-39.44	2.73	H	-29.71	-58.52
	5,553.75	-34.08	12.70	-35.66	3.60	H	-26.56	-55.37
	7,405.00	-48.41	11.36	-39.53	3.88	H	-32.05	-60.86
600	3,760.00	-29.86	12.47	-35.83	2.73	H	-26.09	-54.90
	5,640.00	-35.81	12.75	-37.46	3.60	V	-28.31	-57.12
	7,520.00	-48.36	11.33	-39.26	3.88	H	-31.81	-60.62
1175	3,817.50	-32.26	12.49	-38.14	2.73	H	-28.38	-57.19
	5,726.25	-39.09	12.80	-40.40	3.60	V	-31.20	-60.01
	7,635.00	-46.90	11.30	-37.57	3.88	H	-30.15	-58.96

**NOTES:** Radiated Spurious Emission Measurements at 3 meters by Substitution Method  
according to ANSI/TIA/EIA-603-C-2004, Aug. 17, 2004:



### 7.5.3 Radiated Spurious Emissions (GSM850)

MEASURED OUTPUT POWER: 32.12 dBm = 1.629 W  
 MODULATION SIGNAL: GSM850  
 DISTANCE: 3 meters  
 LIMIT: - (43 + 10 log<sub>10</sub> (W)) = - 45.12 dBc

Ch.	Freq.(MHz)	Measured Level [dBm]	Ant. Gain (dBd)	Substitute Level [dBm]	C.L	Pol.	ERP (dBm)	dBc
128 (824.2)	1,648.40	-40.81	7.09	-51.34	1.73	V	-45.98	-78.10
	2,472.60	-40.98	8.12	-48.09	2.28	V	-42.25	-74.37
	3,296.80	-42.78	9.72	-50.36	2.57	V	-43.21	-75.33
190 (836.6)	1,673.20	-40.61	7.23	-51.37	1.79	V	-45.93	-78.05
	2,509.80	-38.81	8.14	-45.94	2.33	V	-40.13	-72.25
	3,346.40	-43.10	9.99	-51.13	2.66	V	-43.80	-75.92
251 (848.8)	1,697.60	-41.32	7.41	-51.93	1.83	V	-46.35	-78.47
	2,546.40	-38.94	8.21	-46.22	2.34	V	-40.35	-72.47
	3,395.20	-45.27	9.91	-52.90	2.85	V	-45.84	-77.96

**NOTES:** Radiated Spurious Emission Measurements at 3 meters by Substitution Method  
according to ANSI/TIA/EIA-603-C-2004, Aug. 17, 2004:



### 7.5.4 Radiated Spurious Emissions (GSM1900)

MEASURED OUTPUT POWER: 31.20 dBm = 1.318 W  
 MODULATION SIGNAL: GSM1900  
 DISTANCE: 3 meters  
 LIMIT: - (43 + 10 log<sub>10</sub> (W)) = - 44.20 dBc

Ch.	Freq.(MHz)	Measured Level [dBm]	Ant. Gain (dBi)	Substitute Level [dBm]	C.L	Pol.	EIRP (dBm)	dBc
512 (1850.2)	3,700.40	-44.16	12.46	-50.43	2.73	H	-40.70	-71.90
	5,550.60	-48.91	12.70	-50.49	3.60	H	-41.39	-72.59
	7,400.80	-52.07	11.36	-43.19	3.88	V	-35.71	-66.91
661 (1880.0)	3,760.00	-49.45	12.47	-55.42	2.73	H	-45.68	-76.88
	5,640.00	-47.74	10.60	-47.24	3.60	H	-40.24	-71.44
	7,520.00	-50.20	11.33	-41.10	3.88	V	-33.65	-64.85
810 (1909.8)	3,819.60	-49.63	12.49	-55.51	2.73	H	-45.75	-76.95
	5,729.40	-47.67	12.80	-48.98	3.60	H	-39.78	-70.98
	7,639.20	-50.03	11.30	-40.70	3.88	V	-33.28	-64.48

**NOTES:** Radiated Spurious Emission Measurements at 3 meters by Substitution Method  
according to ANSI/TIA/EIA-603-C-2004, Aug. 17, 2004:



## 7.6 Frequency stability / variation of ambient temperature

### 7.6.1 FREQUENCY STABILITY (CDMA)

OPERATING FREQUENCY: 836,520,000 Hz  
 CHANNEL: 384  
 REFERENCE VOLTAGE: 3.7 VDC  
 DEVIATION LIMIT: ± 0.000 25 % or 2.5 ppm

Voltage (%)	Power (VDC)	Temp. ( )	Frequency (Hz)	Frequency Error (Hz)	Deviation (%)	ppm
100%	3.700	+20(Ref)	836 519 988	-12.29	-0.000 001	-0.015
100%		-30	836 519 993	-6.81	-0.000 001	-0.008
100%		-20	836 519 992	-8.33	-0.000 001	-0.010
100%		-10	836 519 994	-5.66	-0.000 001	-0.007
100%		0	836 519 993	-7.47	-0.000 001	-0.009
100%		+10	836 519 995	-4.84	-0.000 001	-0.006
100%		+20	836 519 994	-6.29	-0.000 001	-0.008
100%		+30	836 519 997	-3.32	0.000 000	-0.004
100%		+40	836 519 993	-7.26	-0.000 001	-0.009
100%		+50	836 519 996	-4.08	0.000 000	-0.005
115%		4.255	+20	836 519 993	-6.75	-0.000 001
Batt. Endpoint	3.400	+20	836 519 996	-3.77	0.000 000	-0.005

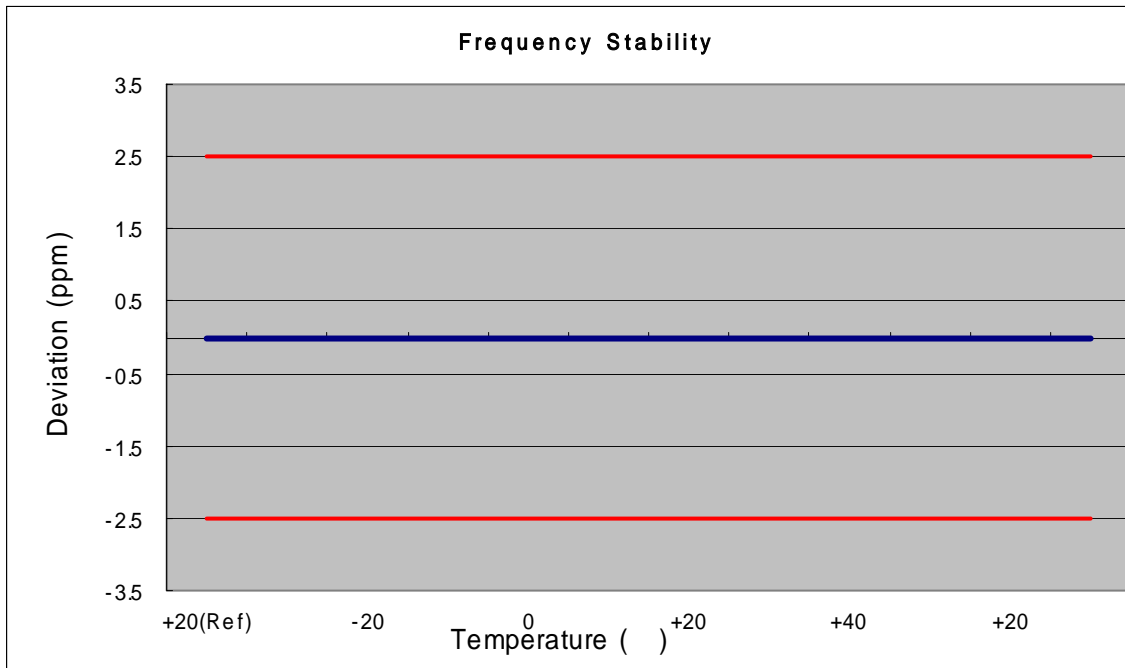



**7.6.2 FREQUENCY STABILITY (PCS CDMA)**

OPERATING FREQUENCY: 1880,000,000 Hz  
 CHANNEL: 600  
 REFERENCE VOLTAGE: 3.7 VDC  
 DEVIATION LIM IT: ± 0.000 25 % or 2.5 ppm

Voltage (%)	Power (VDC)	Temp. ( )	Frequency (Hz)	Frequency Error (Hz)	Deviation (%)	ppm
100%	3.700	+20(Ref)	1879 999 978	-21.97	-0.000 001	-0.012
100%		-30	1879 999 985	-15.02	-0.000 001	-0.008
100%		-20	1879 999 990	-9.65	-0.000 001	-0.005
100%		-10	1879 999 986	-14.45	-0.000 001	-0.008
100%		0	1879 999 992	-8.16	0.000 000	-0.004
100%		+10	1879 999 987	-12.70	-0.000 001	-0.007
100%		+20	1879 999 988	-11.83	-0.000 001	-0.006
100%		+30	1879 999 992	-8.00	0.000 000	-0.004
100%		+40	1879 999 990	-10.37	-0.000 001	-0.006
100%		+50	1879 999 994	-5.81	0.000 000	-0.003
115%	4.255	+20	1879 999 988	-12.05	-0.000 001	-0.006
Batt. Endpoint	3.400	+20	1879 999 991	-9.31	0.000 000	-0.005

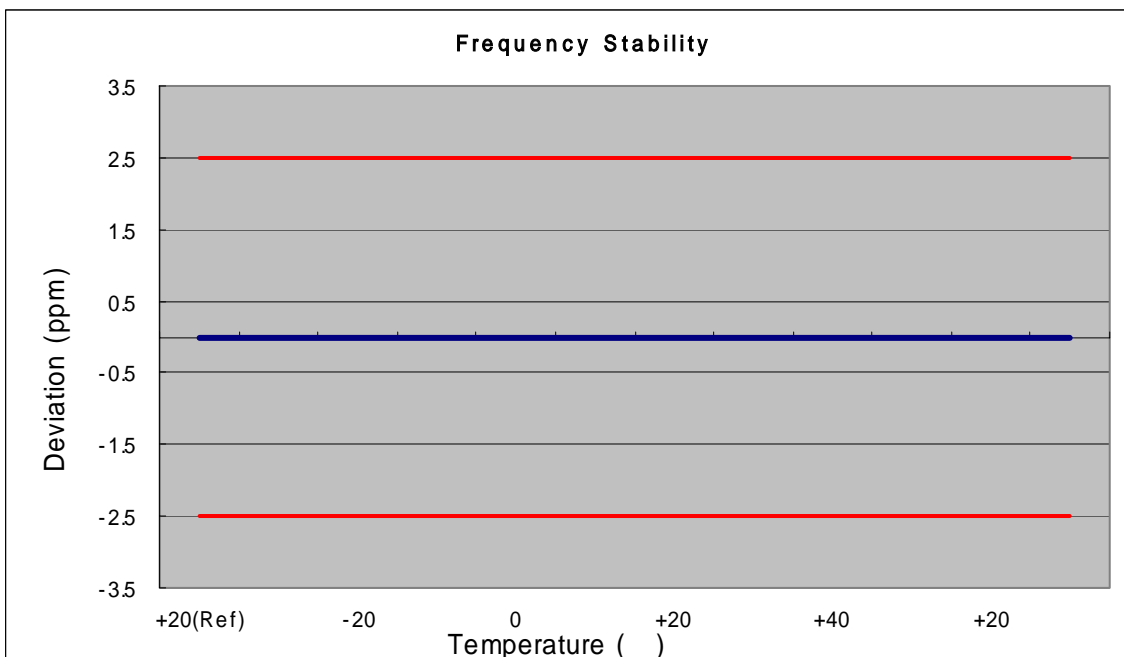



### 7.6.3 FREQUENCY STABILITY (GSM850)

OPERATING FREQUENCY: 836,600,000 Hz  
 CHANNEL: 190  
 REFERENCE VOLTAGE: 3.7 VDC  
 DEVIATION LIMIT: ± 0.000 25 % or 2.5 ppm

Voltage (%)	Power (VDC)	Temp. ( )	Frequency (Hz)	Frequency Error (Hz)	Deviation (%)	ppm
100%	3.700	+20(Ref)	836 599 984	-16.47	-0.000 002	-0.020
100%		-30	836 599 981	-19.13	-0.000 002	-0.023
100%		-20	836 599 986	-14.28	-0.000 002	-0.017
100%		-10	836 599 977	-22.58	-0.000 003	-0.027
100%		0	836 599 985	-15.44	-0.000 002	-0.018
100%		+10	836 599 978	-21.59	-0.000 003	-0.026
100%		+20	836 599 982	-17.57	-0.000 002	-0.021
100%		+30	836 599 970	-30.11	-0.000 004	-0.036
100%		+40	836 599 979	-20.99	-0.000 003	-0.025
100%		+50	836 599 968	-31.56	-0.000 004	-0.038
115%	4.255	+20	836 599 980	-20.27	-0.000 002	-0.024
Batt. Endpoint	3.400	+20	836 599 971	-29.39	-0.000 004	-0.035

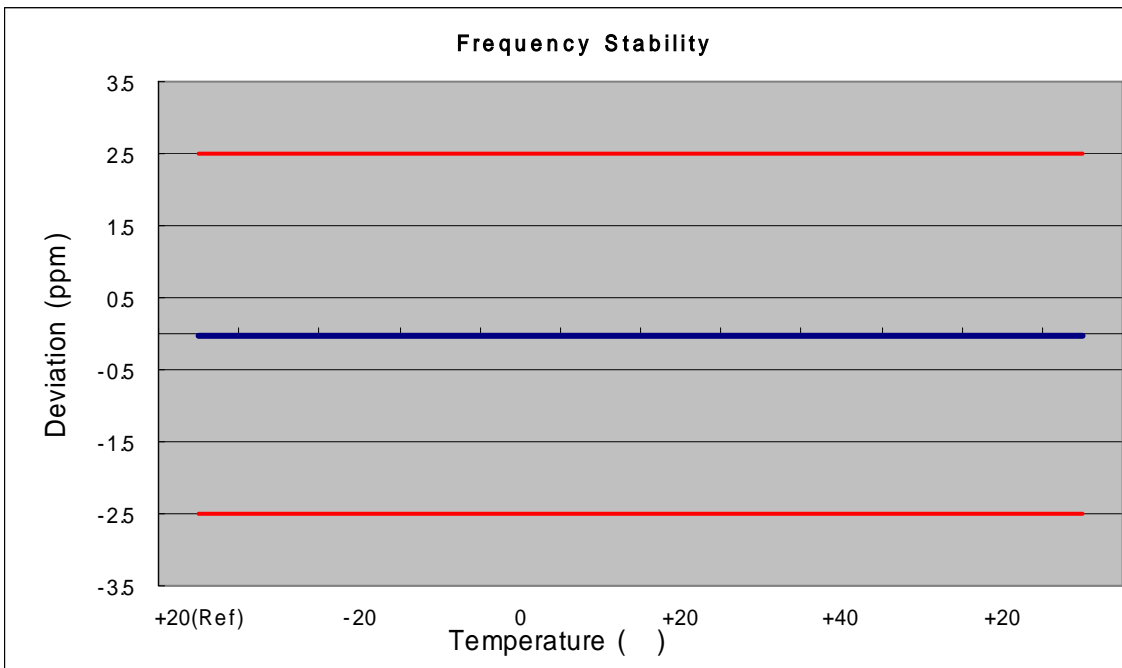



### 7.6.4 FREQUENCY STABILITY (GSM1900)

OPERATING FREQUENCY: 1880,000,000 Hz  
 CHANNEL: 661  
 REFERENCE VOLTAGE: 3.7 VDC  
 DEVIATION LIMIT: ± 0.000 25 % or 2.5 ppm

Voltage (%)	Power (VDC)	Temp. ( )	Frequency (Hz)	Frequency Error (Hz)	Deviation (%)	ppm
100%	3.700	+20(Ref)	1879 999 976	-23.81	-0.000 001	-0.013
100%		-30	1880 000 001	1.21	0.000 000	0.001
100%		-20	1879 999 973	-26.86	-0.000 001	-0.014
100%		-10	1879 999 995	-4.65	0.000 000	-0.002
100%		0	1879 999 972	-27.81	-0.000 001	-0.015
100%		+10	1879 999 992	-8.48	0.000 000	-0.005
100%		+20	1879 999 972	-28.05	-0.000 001	-0.015
100%		+30	1879 999 973	-26.51	-0.000 001	-0.014
100%		+40	1879 999 977	-23.20	-0.000 001	-0.012
100%		+50	1879 999 991	-9.24	0.000 000	-0.005
115%	4.255	+20	1879 999 970	-29.91	-0.000 002	-0.016
Batt. Endpoint	3.400	+20	1879 999 992	-8.36	0.000 000	-0.004

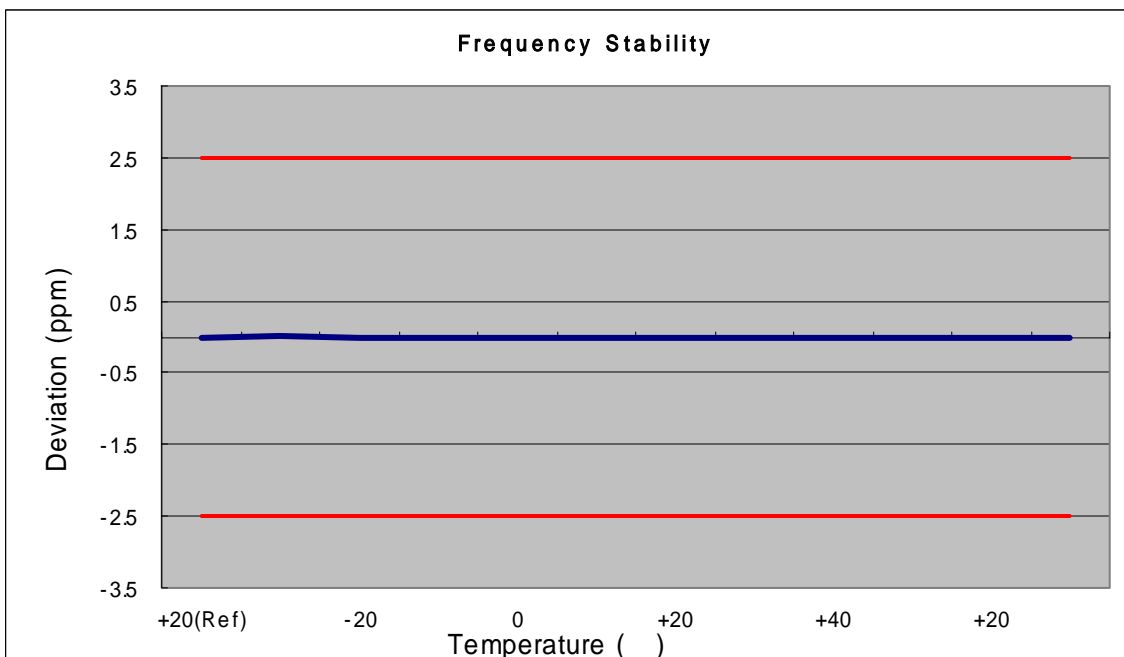





## 8. TEST PLOTS

FCC CERTIFICATION REPORT				<a href="http://www.hct.co.kr">www.hct.co.kr</a>
<b>Test Report No.</b> HCT-RF09-0403	<b>Date of Issue:</b> April 2, 2009	<b>EUT Type:</b> Dual-Band Dual-Mode CDMA/GSM Phone with Bluetooth	<b>FCC ID:</b> PP4ZEPHYR	Page 25 of 50

■ CDMA MODE (1013 CH.) Occupied Bandwidth

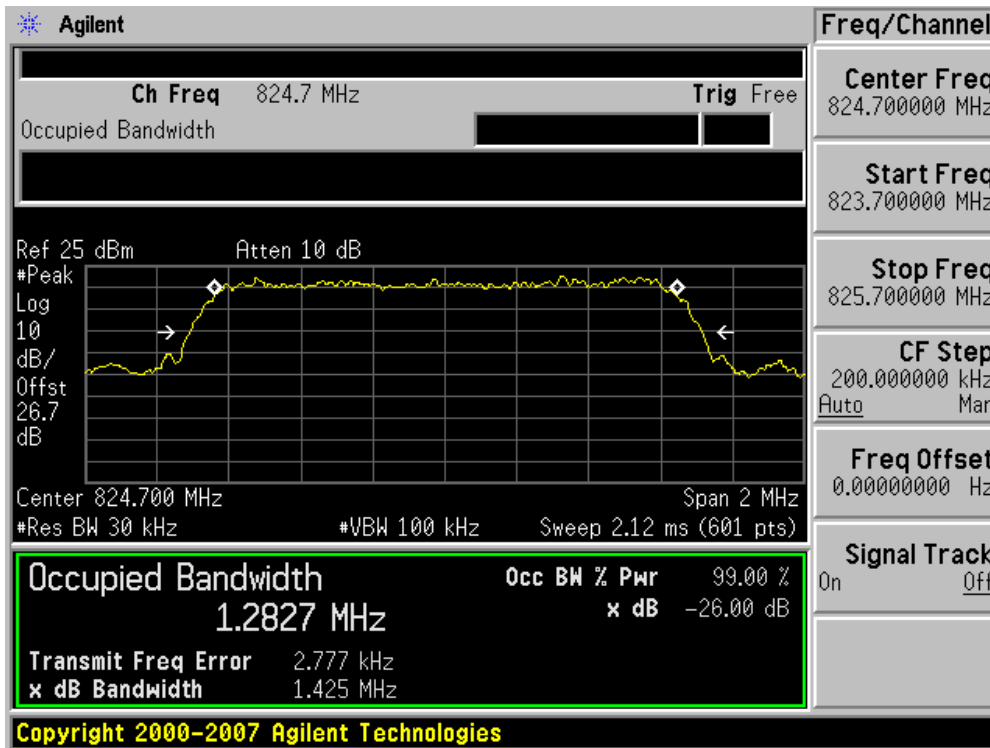

■ CDMA MODE (384 CH.) Occupied Bandwidth

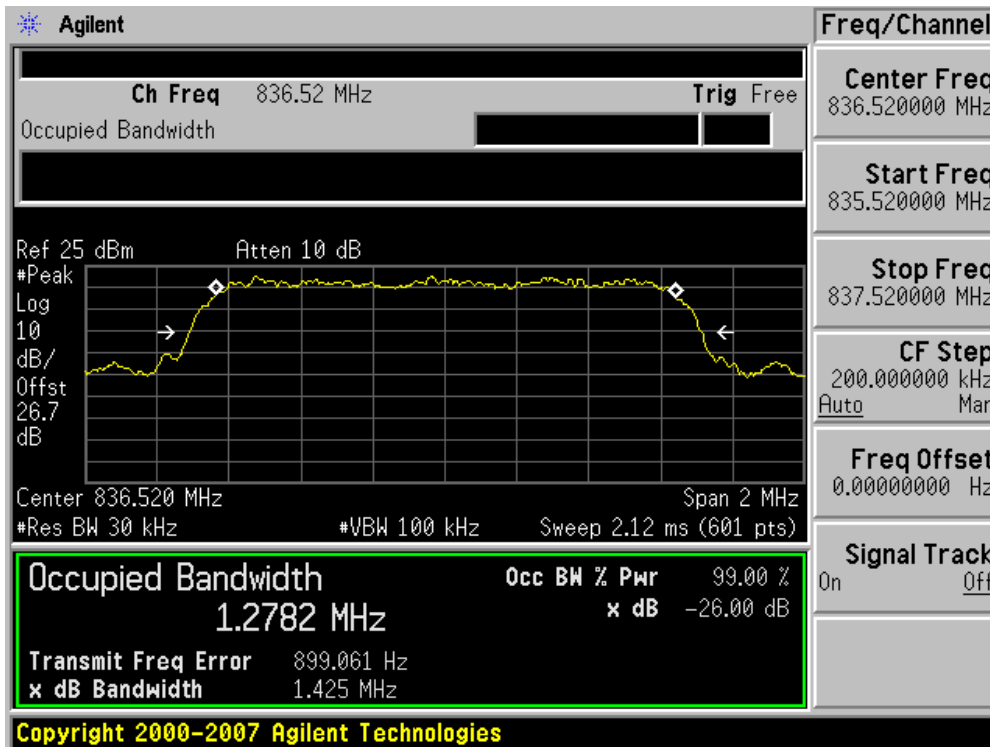

■ CDMA MODE (777 CH.) Occupied Bandwidth

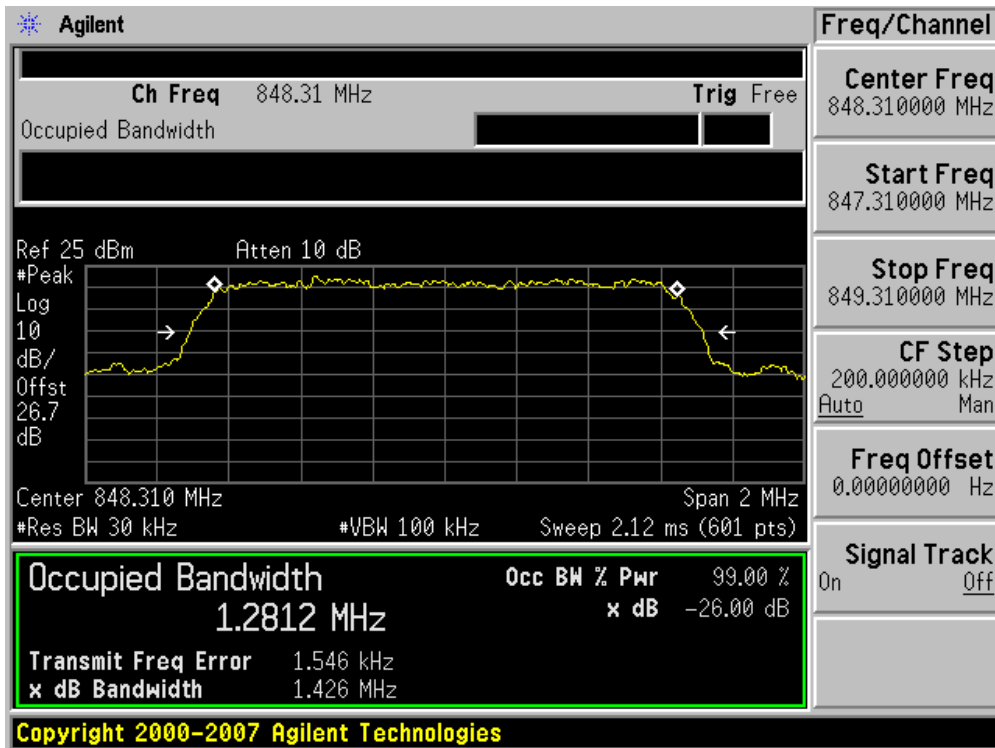

■ PCS CDMA MODE (25 CH.) Occupied Bandwidth

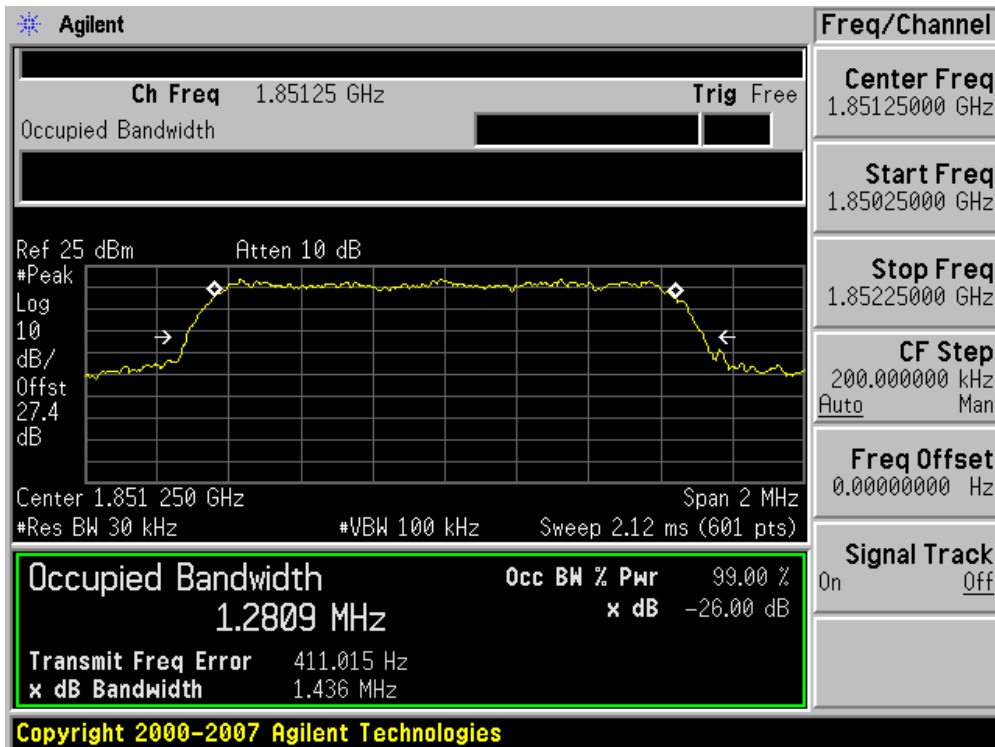

■ PCS CDMA MODE (600 CH.) Occupied Bandwidth

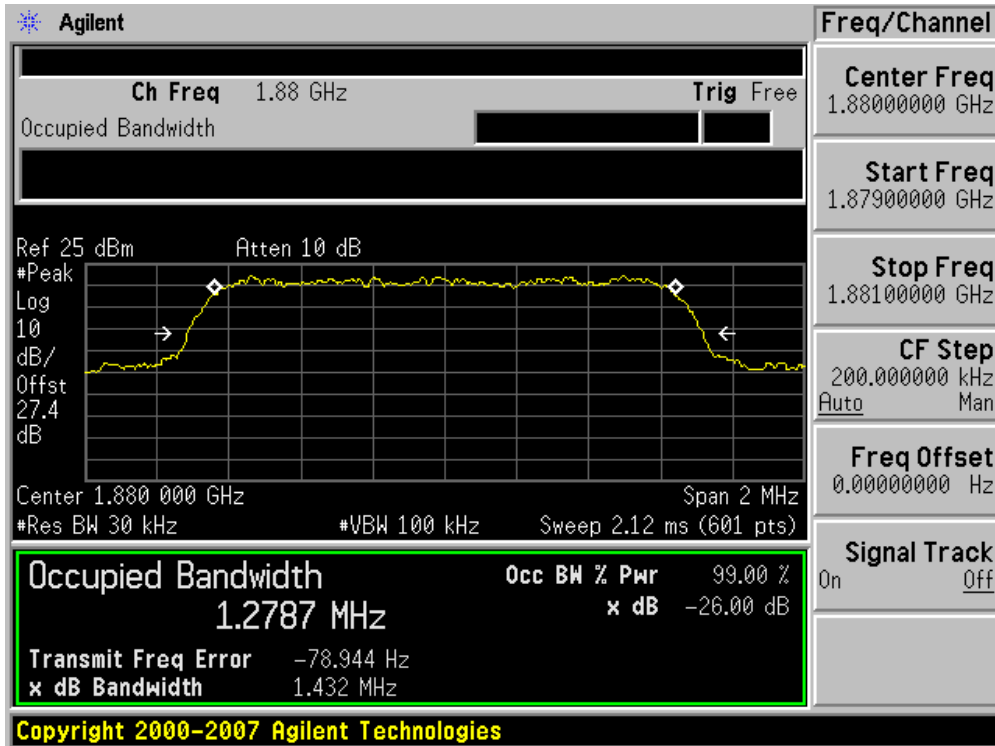

■ PCS CDMA MODE (1175 CH.) Occupied Bandwidth

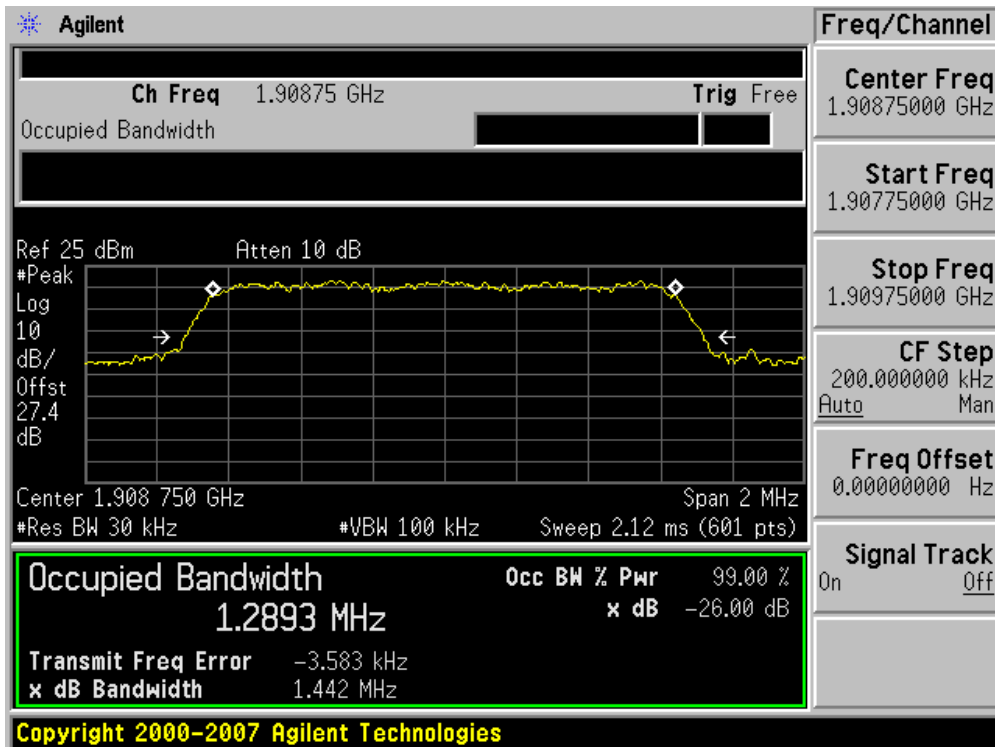

■ PCS CDMA MODE (600 CH.) Peak-to-Average Ratio

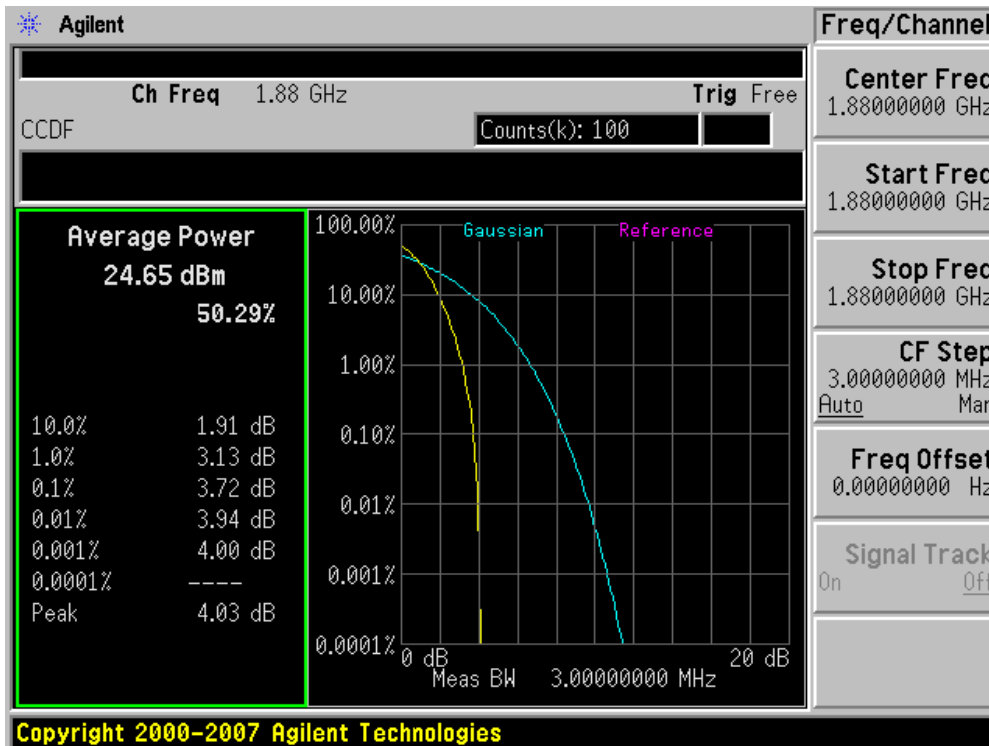

■ GSM850 MODE (128 CH.) Occupied Bandwidth

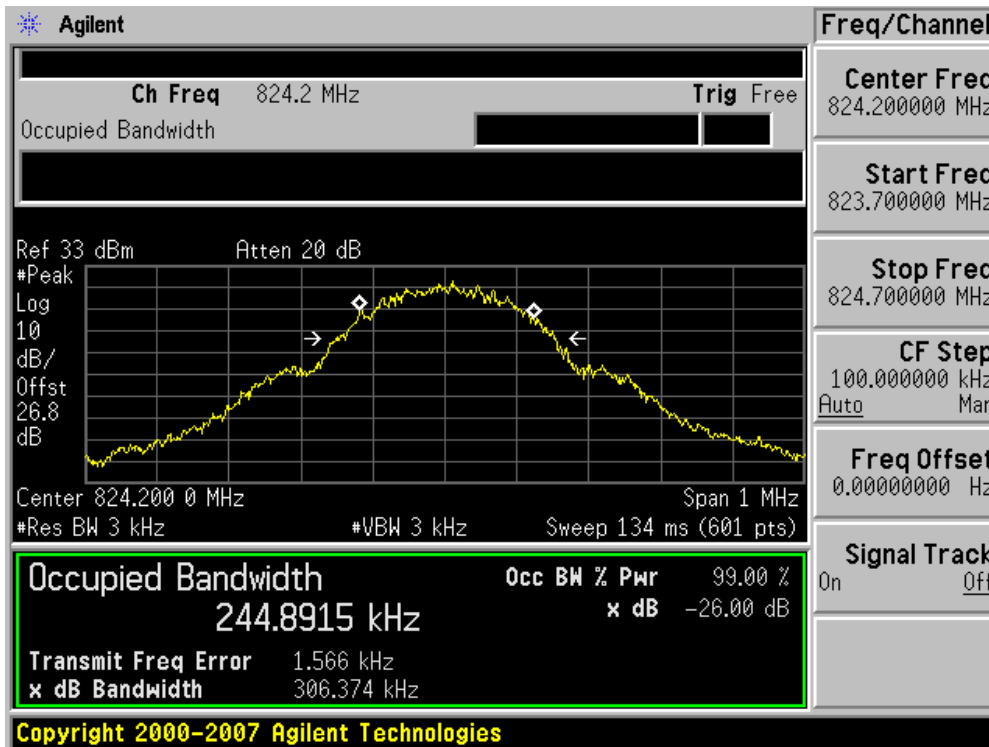

■ GSM850 MODE (190 CH.) Occupied Bandwidth

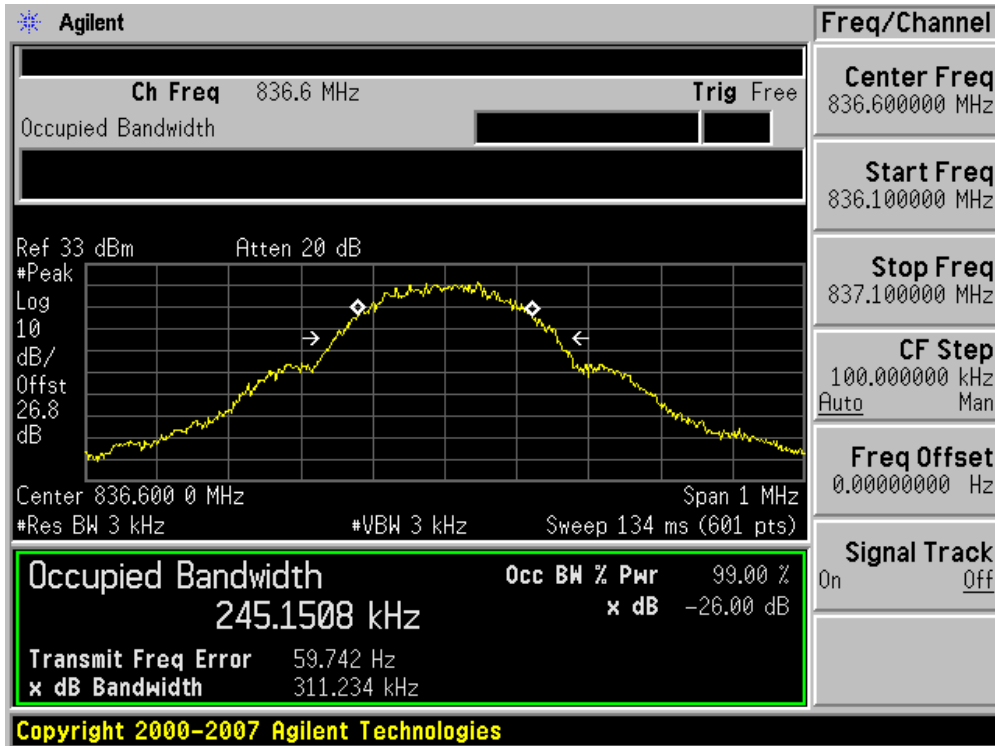

■ GSM850 MODE (251 CH.) Occupied Bandwidth

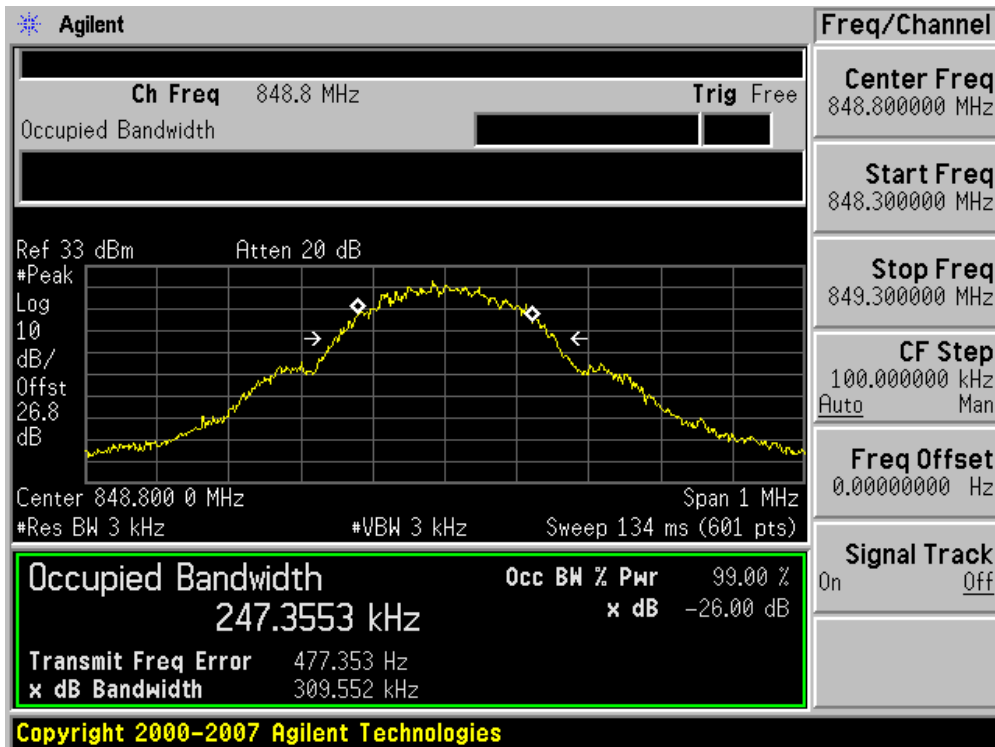



■ GSM1900 MODE (512 CH.) Occupied Bandwidth

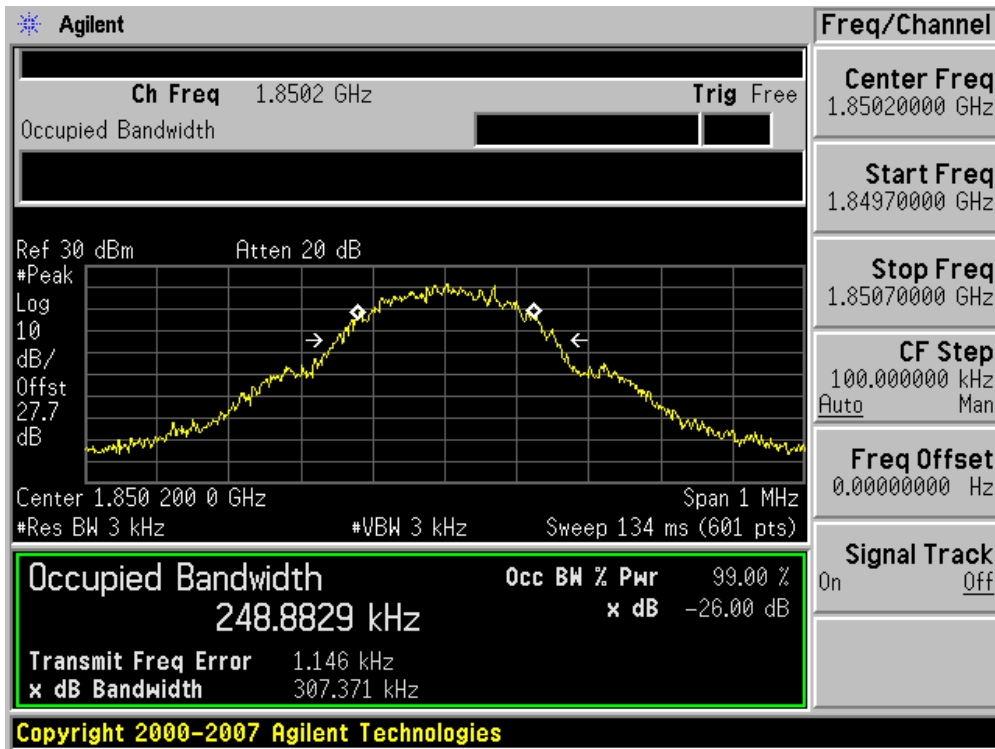

■ GSM1900 MODE (661 CH.) Occupied Bandwidth

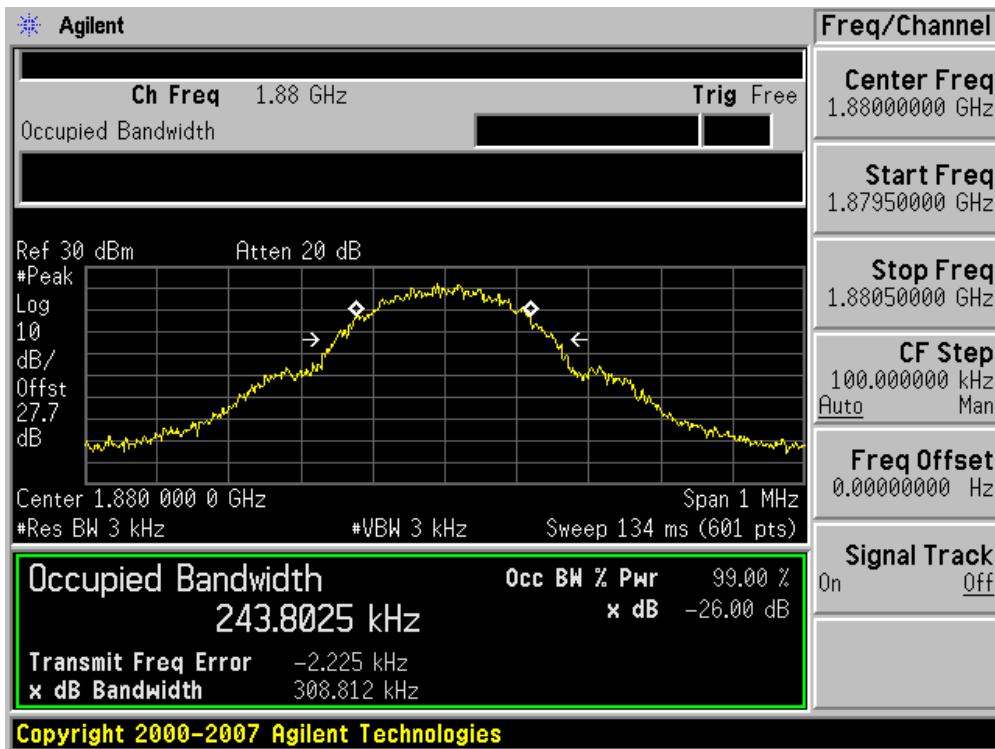

■ GSM1900 MODE (810 CH.) Occupied Bandwidth

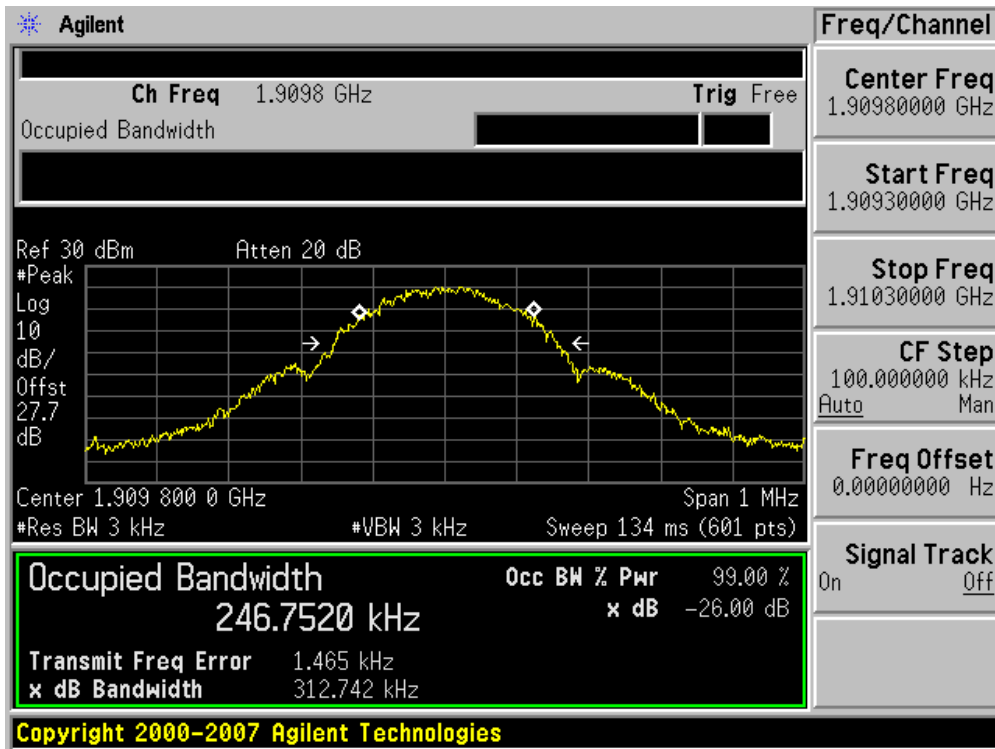

■ GSM1900 MODE (661 CH.) Peak-to-Average Ratio

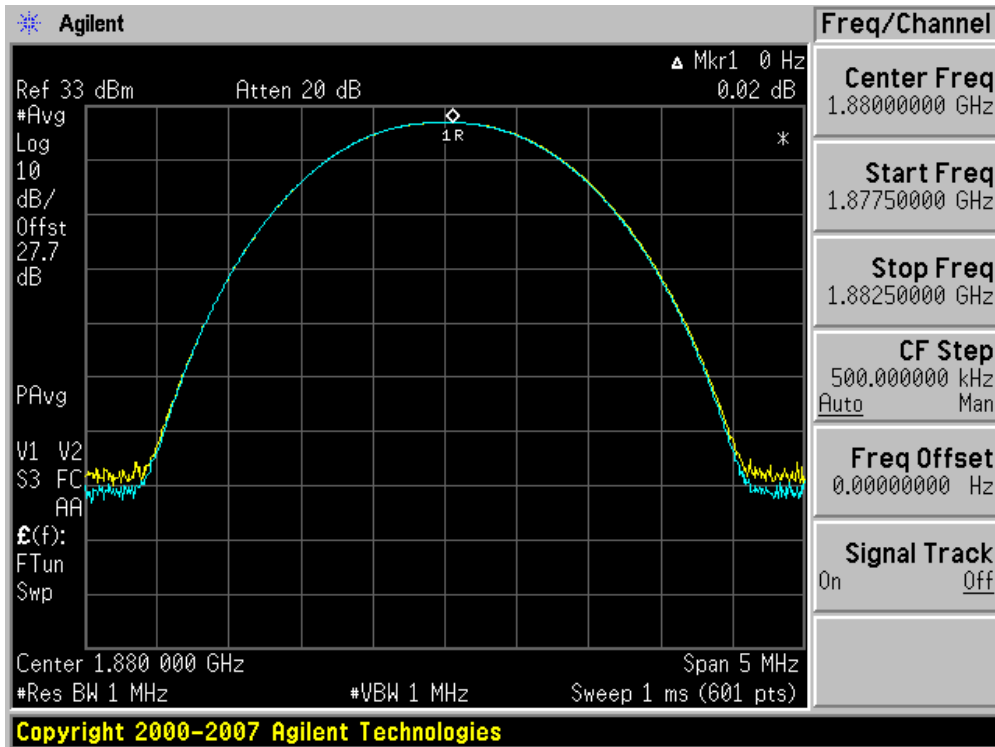



■ CDMA MODE (1013 CH.) Block Edge

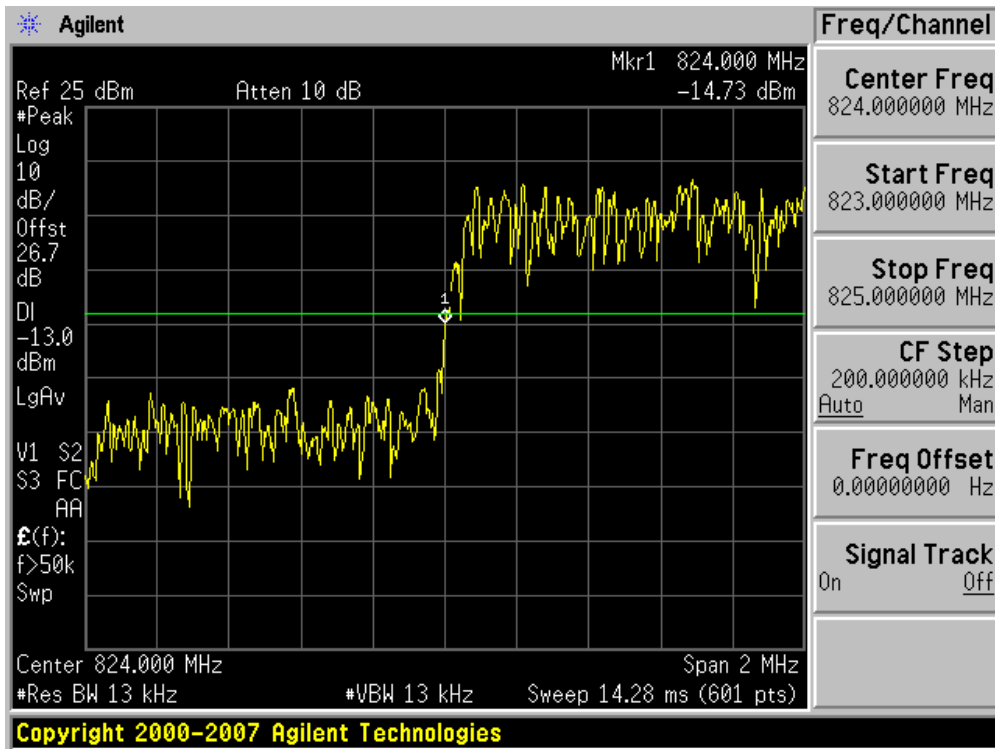

■ CDMA MODE (777 CH.) Block Edge

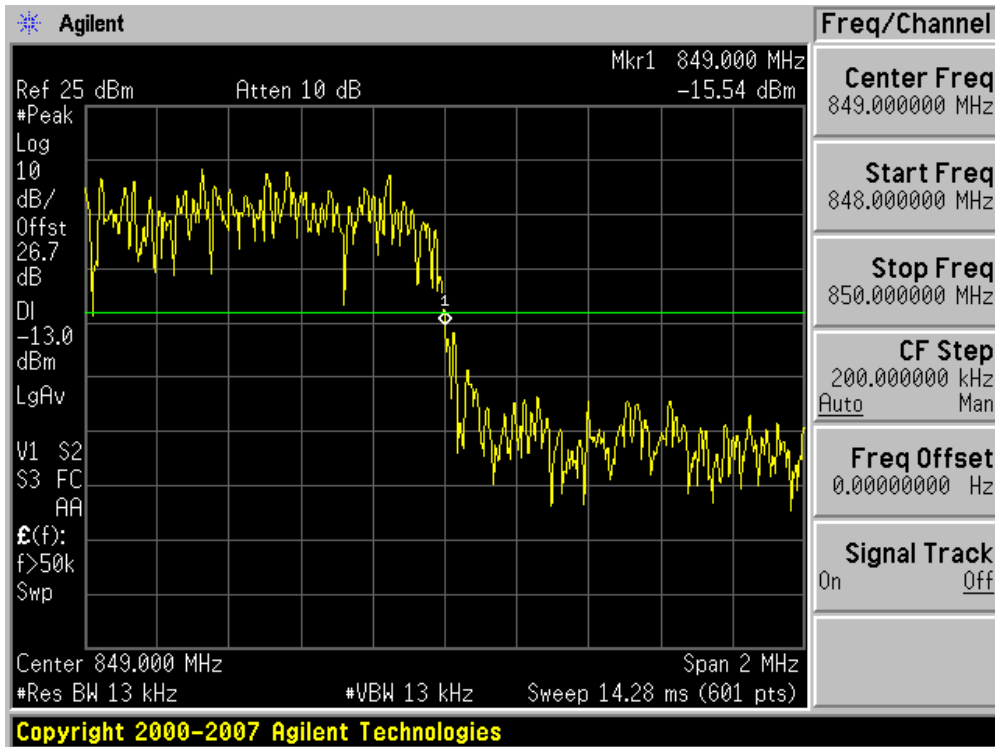

■ CDMA MODE (1013 CH.) 4 MHz Span - Block Edge

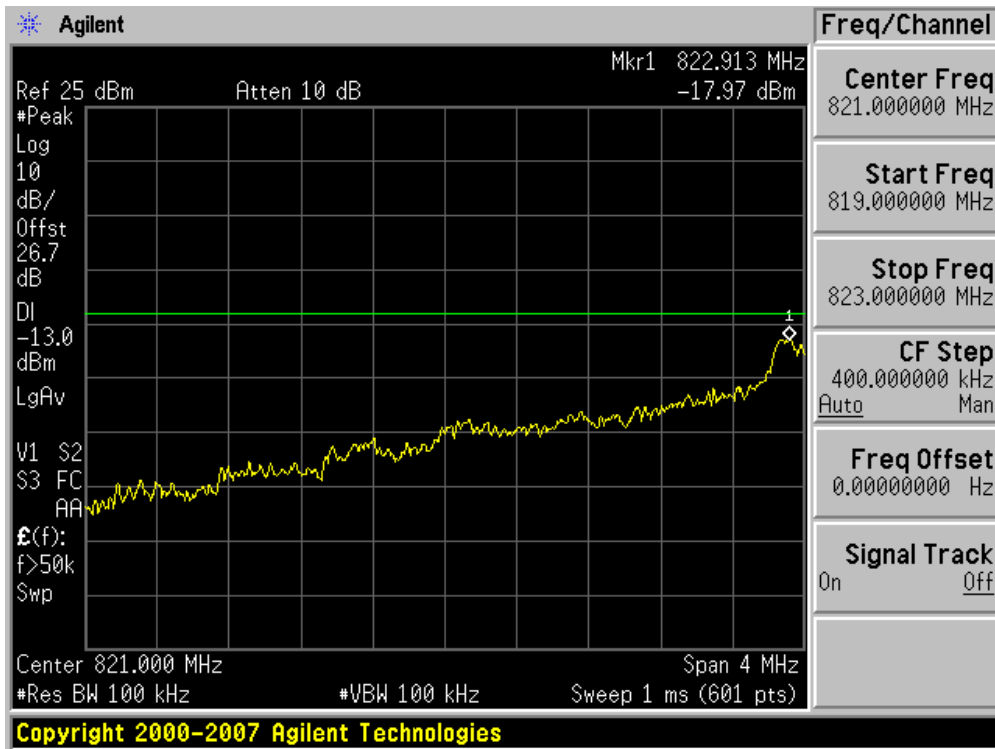

■ CDMA MODE (777 CH.) 4 MHz Span -Block Edge

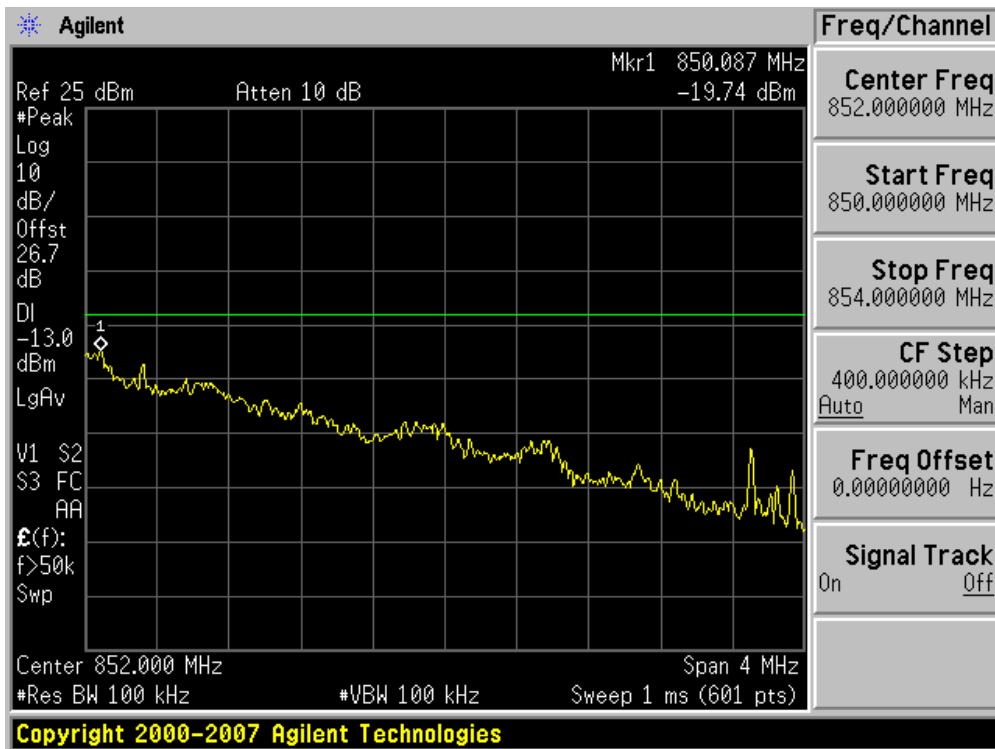

■ PCS CDMA MODE (25 CH.) Block Edge

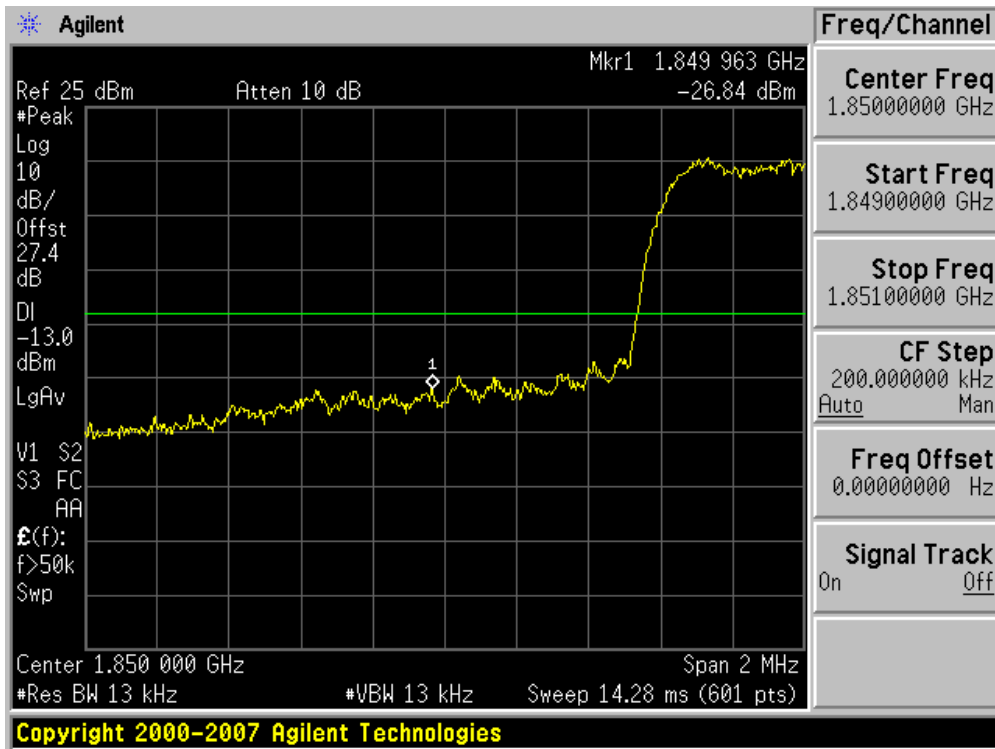

■ PCS CDMA MODE (1175 CH.) Block Edge

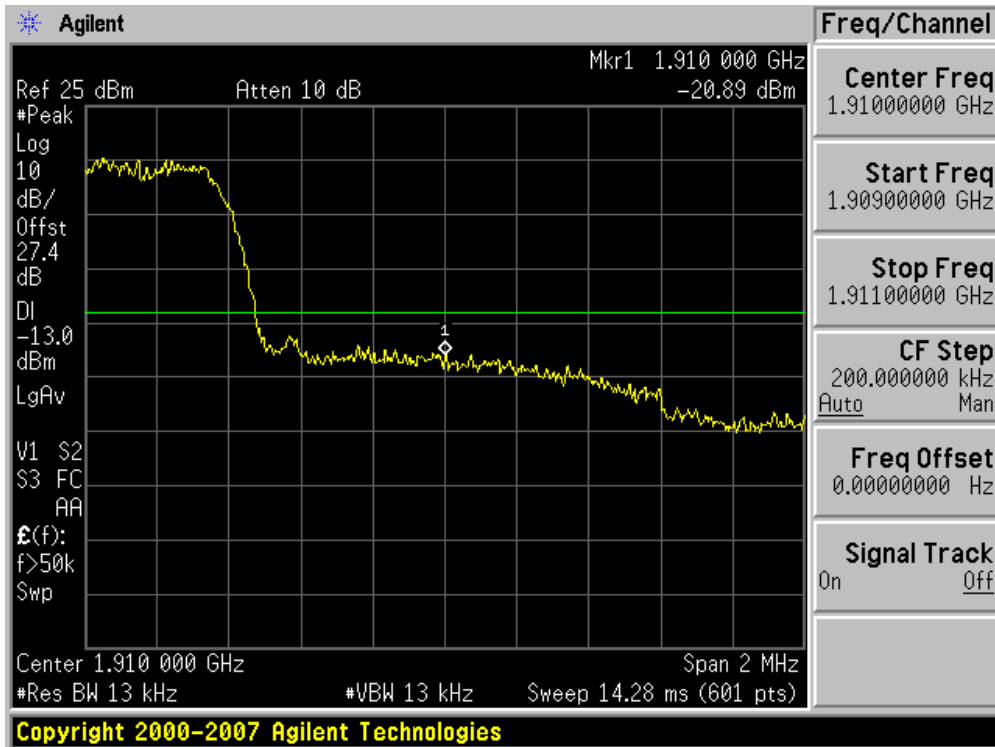



■ PCS CDMA MODE (25 CH.) 4 MHz Span -Block Edge

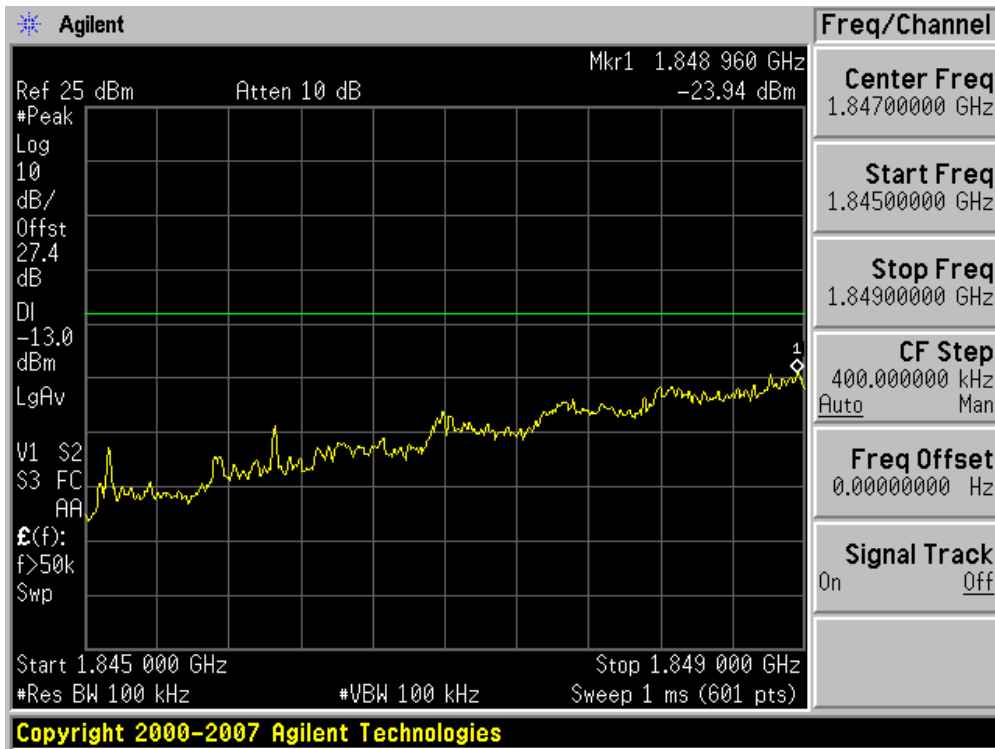

■ PCS CDMA MODE (1175 CH.) 4 MHz Span -Block Edge

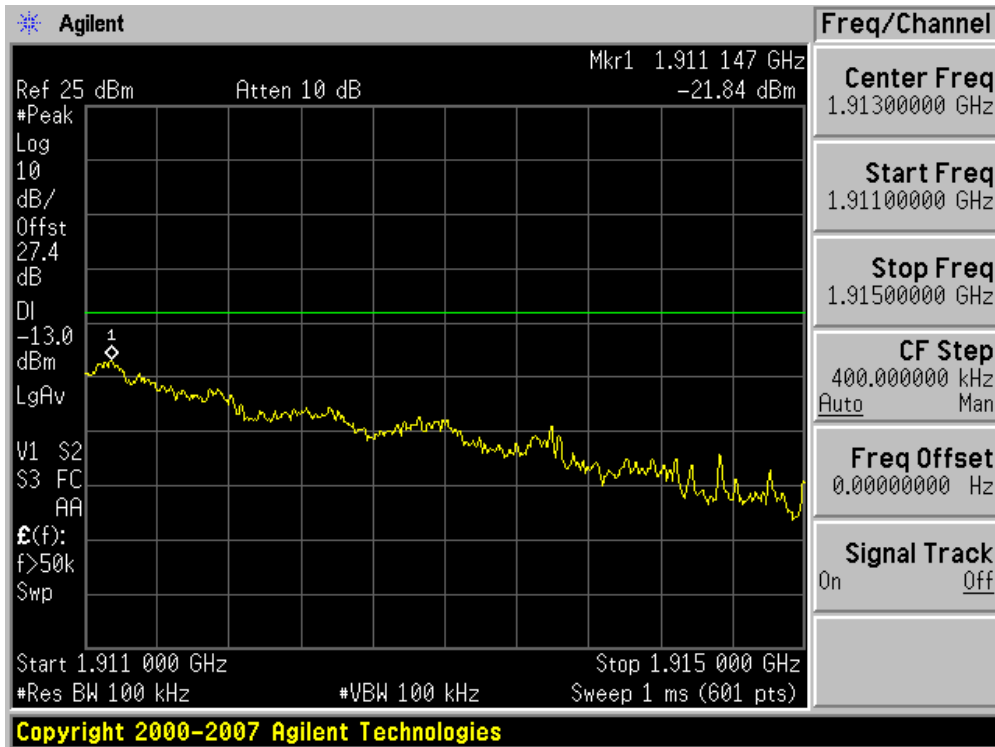

■ GSM850 MODE (128 CH.) Block Edge

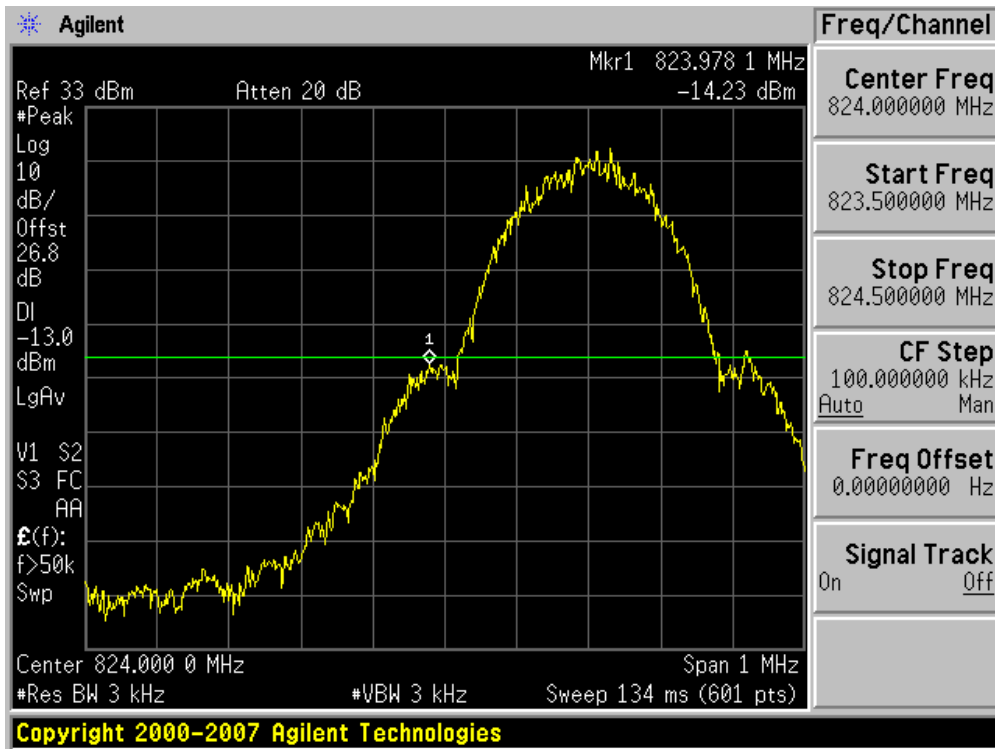

■ GSM850 MODE (251 CH.) Block Edge

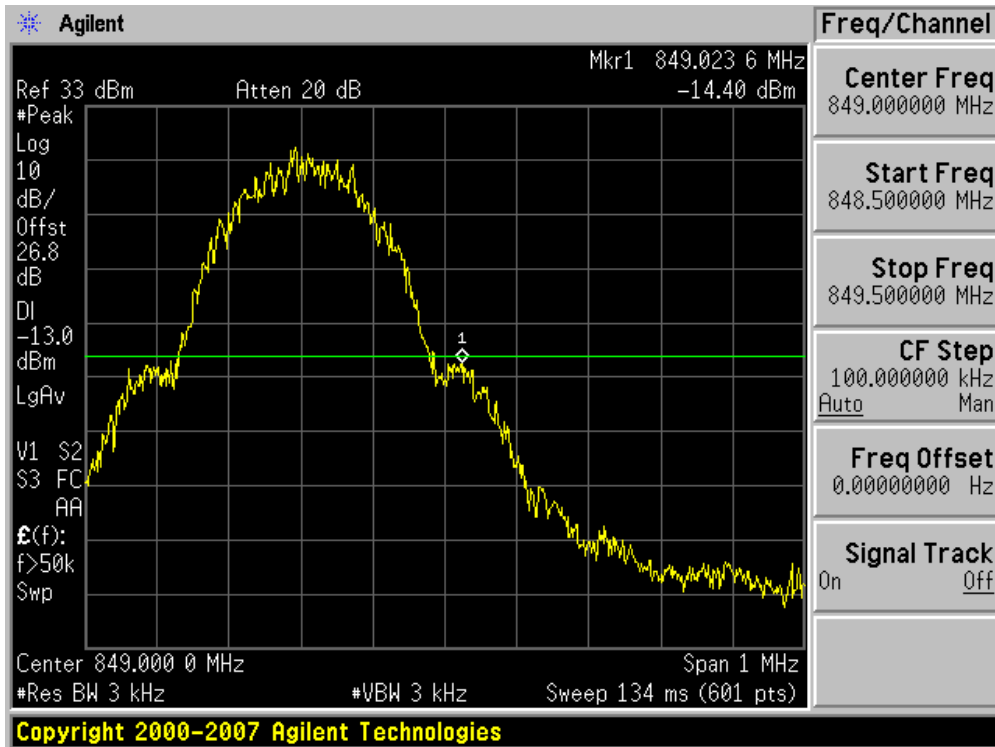

■ GSM1900 MODE (512 CH.) Block Edge

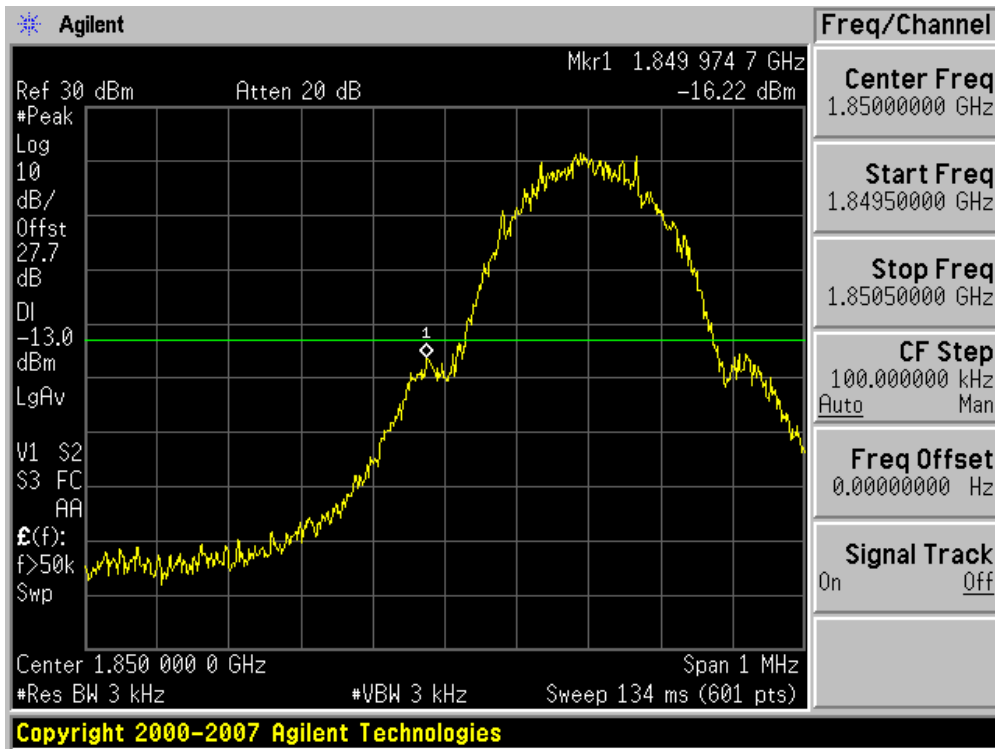

■ GSM1900 MODE (810 CH.) Block Edge

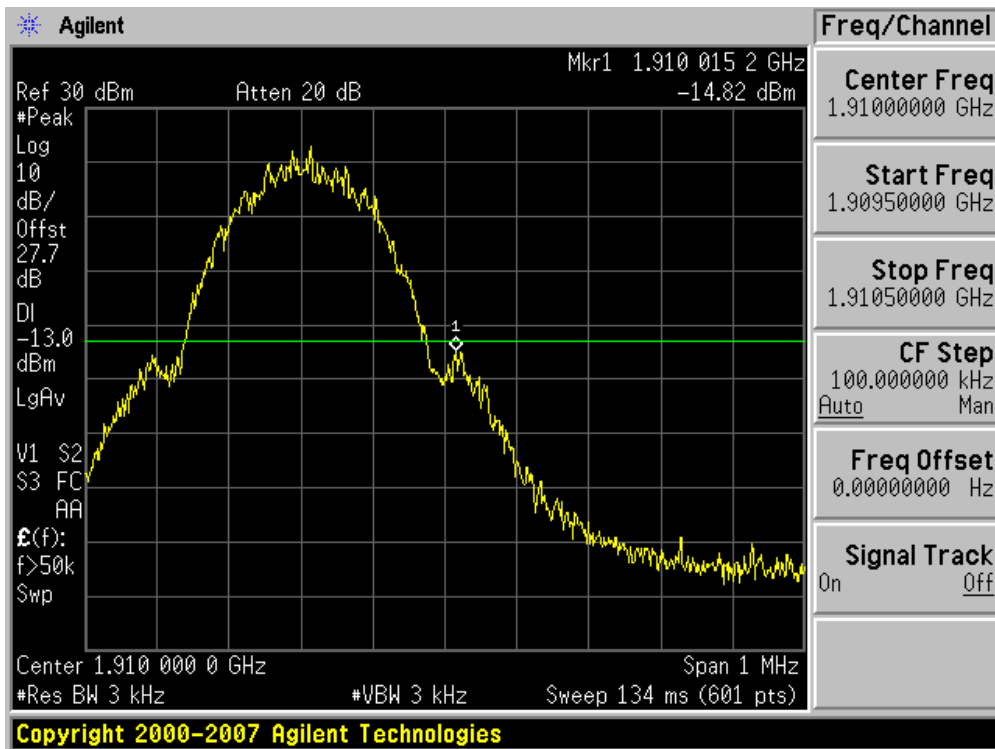

■ CDMA MODE (1013 CH.) Conducted Spurious Emissions 1

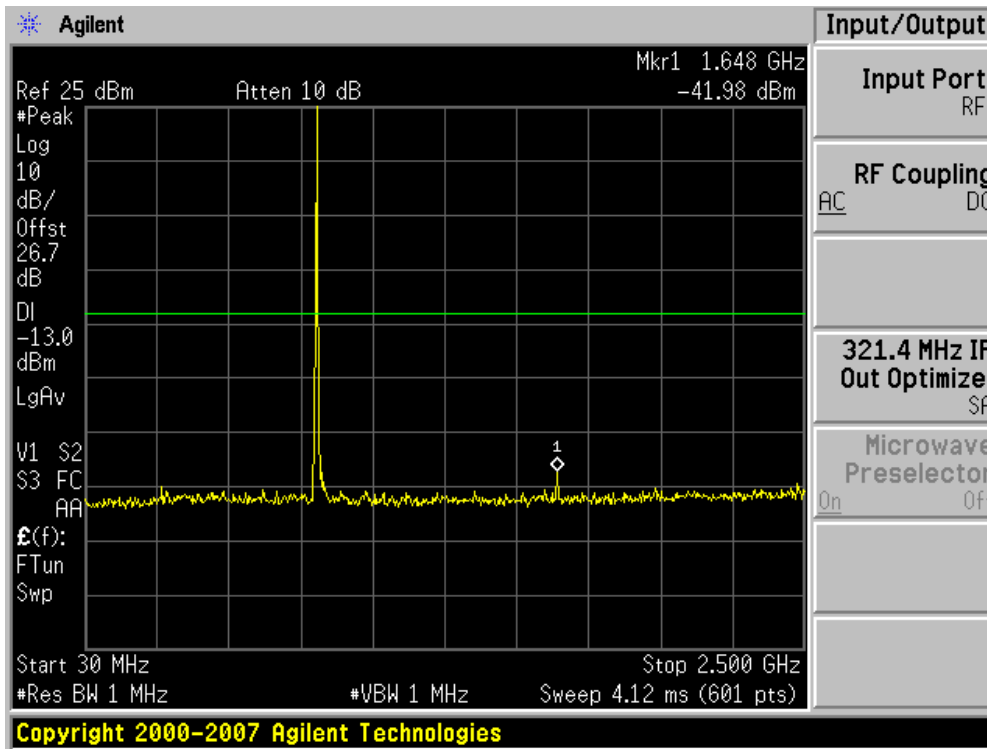

■ CDMA MODE (1013 CH.) Conducted Spurious Emissions 2

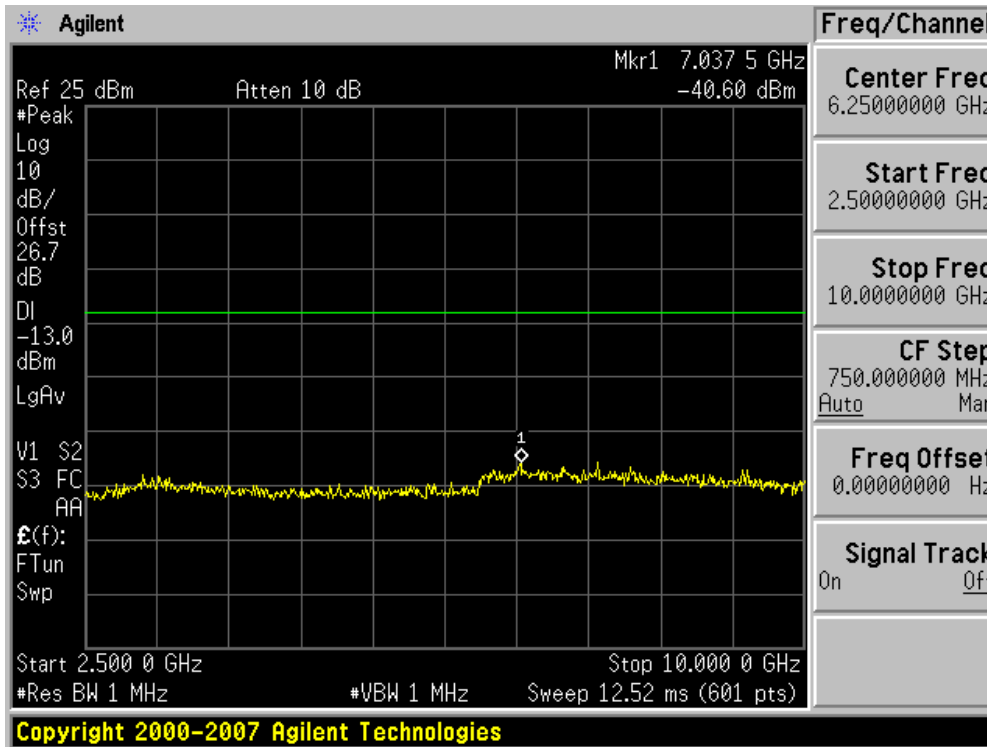

■ CDMA MODE (384 CH.) Conducted Spurious Emissions 1

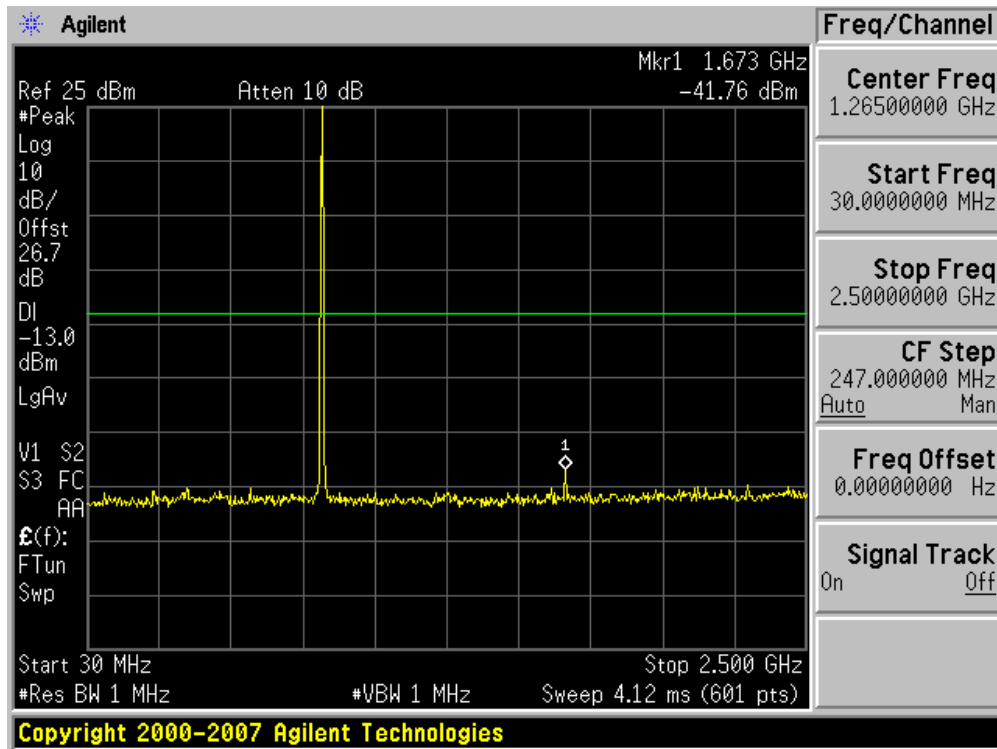

■ CDMA MODE (384 CH.) Conducted Spurious Emissions 2

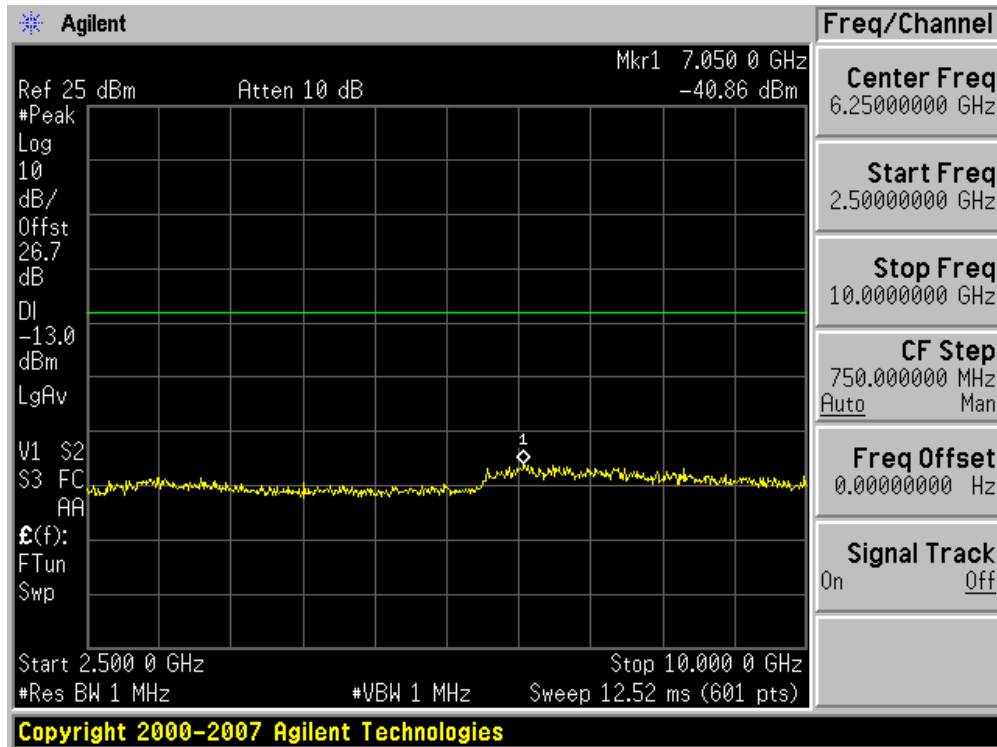



■ CDMA MODE (777 CH.) Conducted Spurious Emissions 1

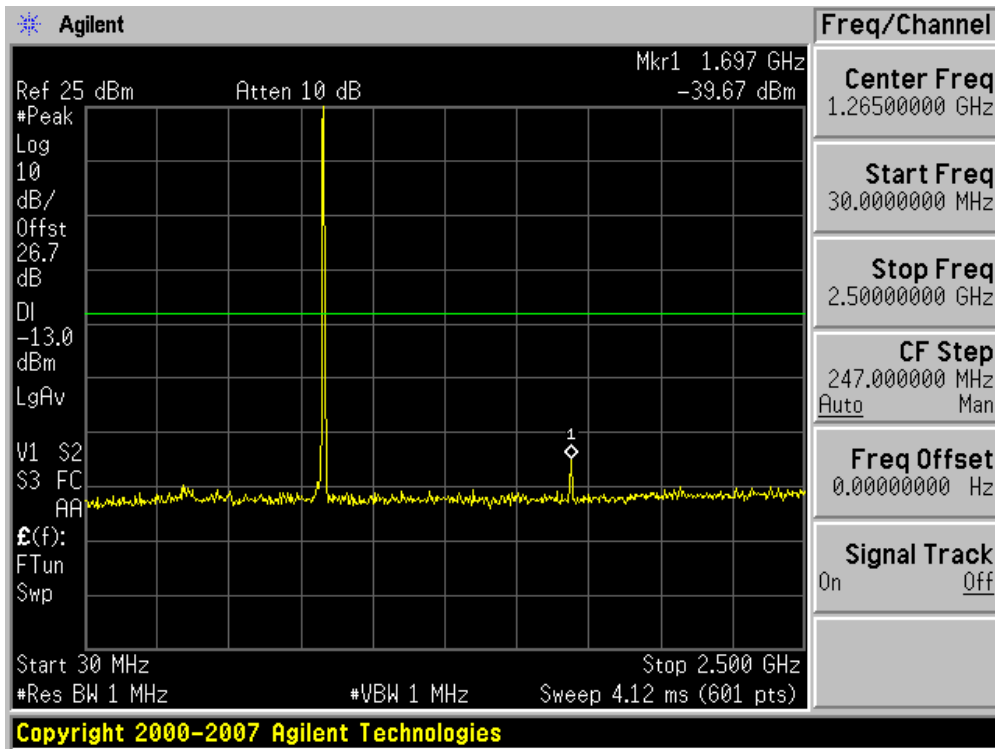

■ CDMA MODE (777 CH.) Conducted Spurious Emissions 2

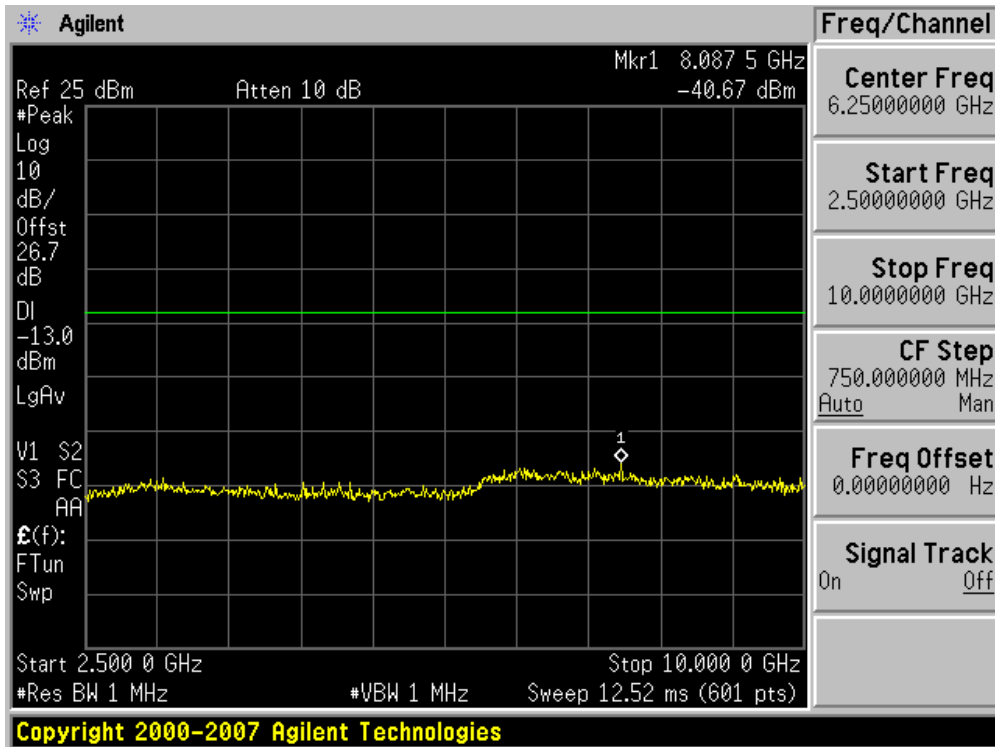

■ PCS CDMA MODE (25 CH.) Conducted Spurious Emissions 1

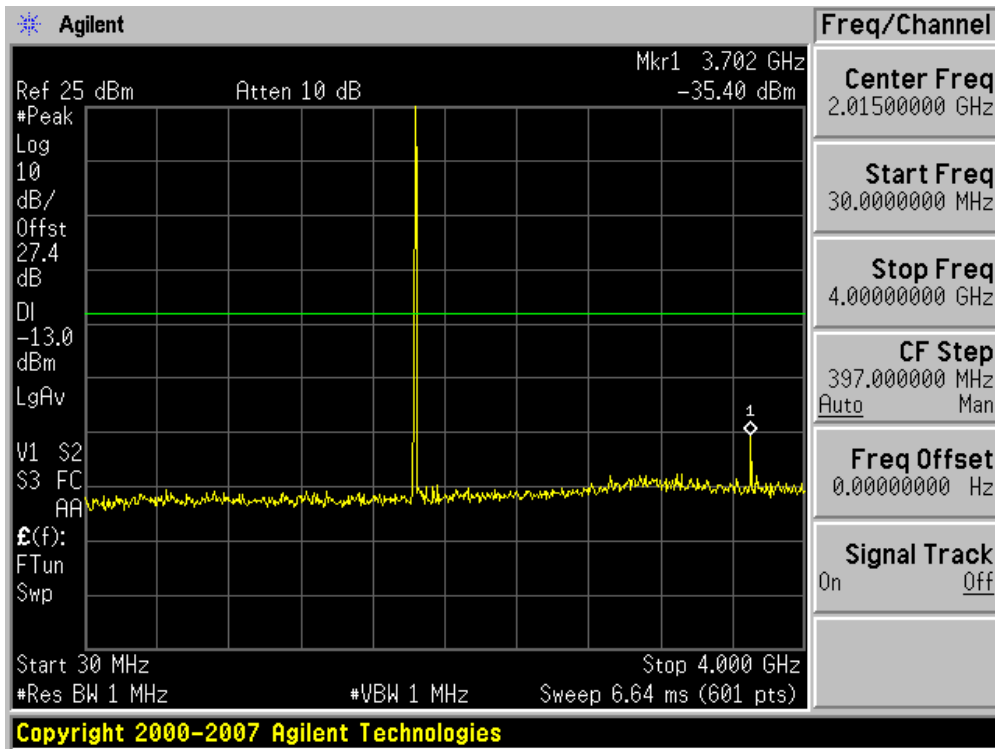

■ PCS CDMA MODE (25 CH.) Conducted Spurious Emissions 2

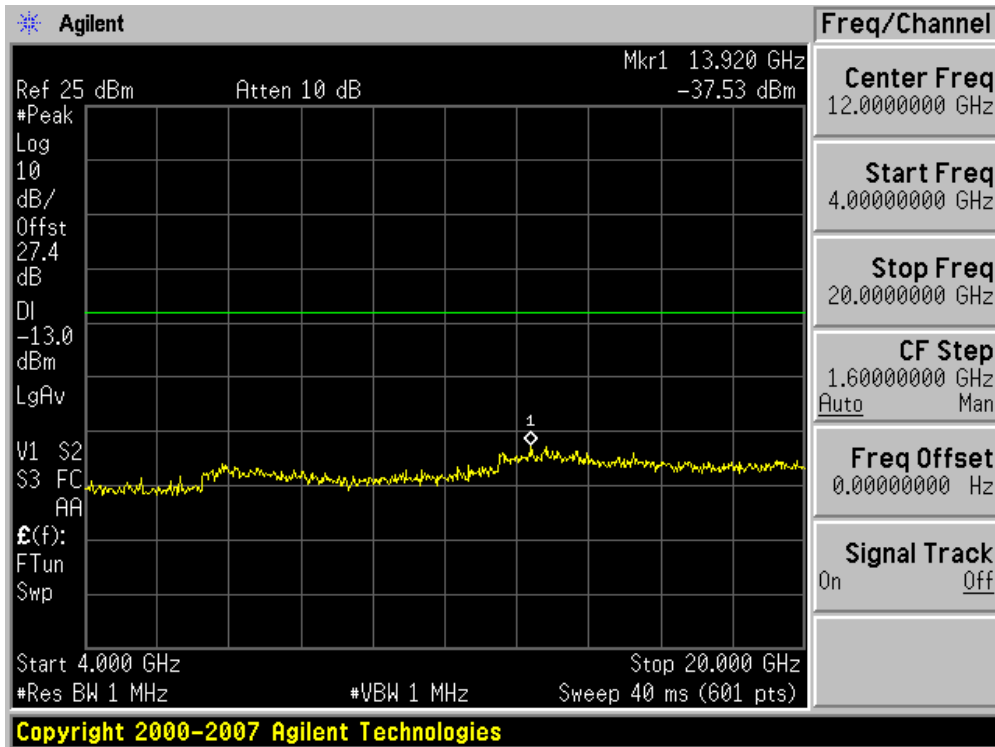

■ PCS CDMA MODE (600 CH.) Conducted Spurious Emissions 1

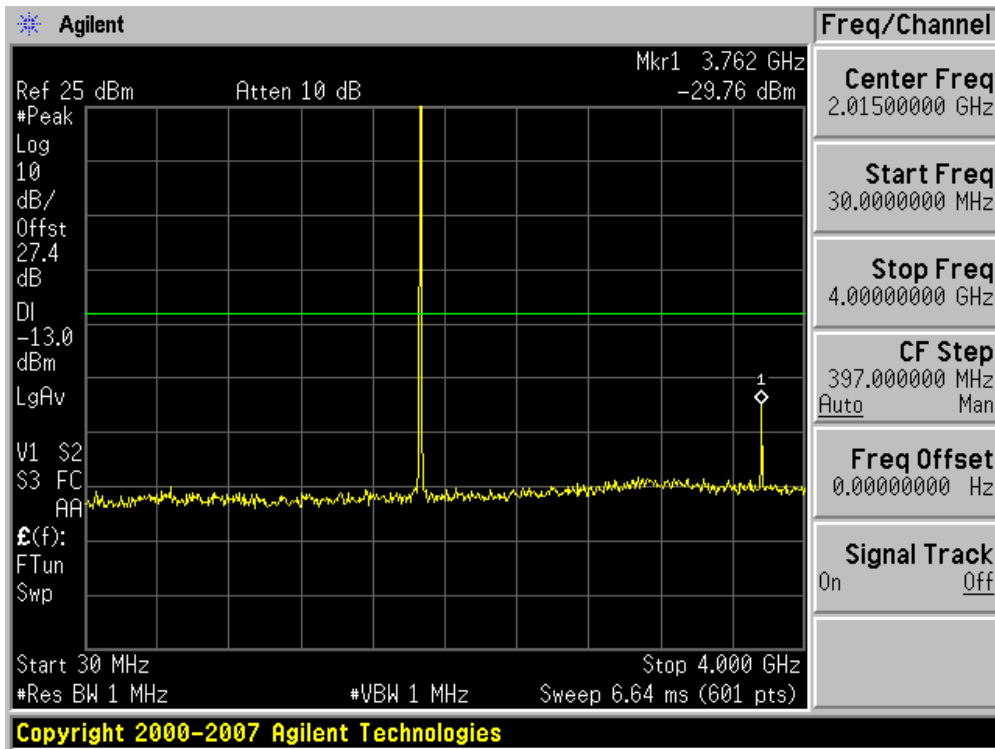

■ PCS CDMA MODE (600 CH.) Conducted Spurious Emissions 2

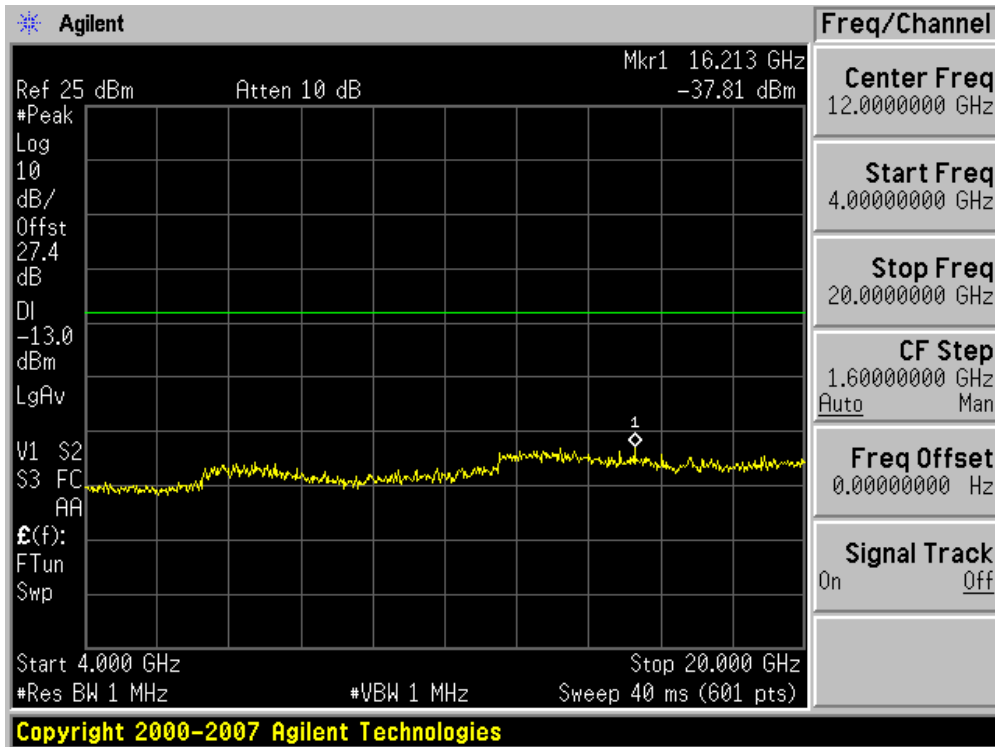

■ PCS CDMA MODE (1175 CH.) Conducted Spurious Emissions 1

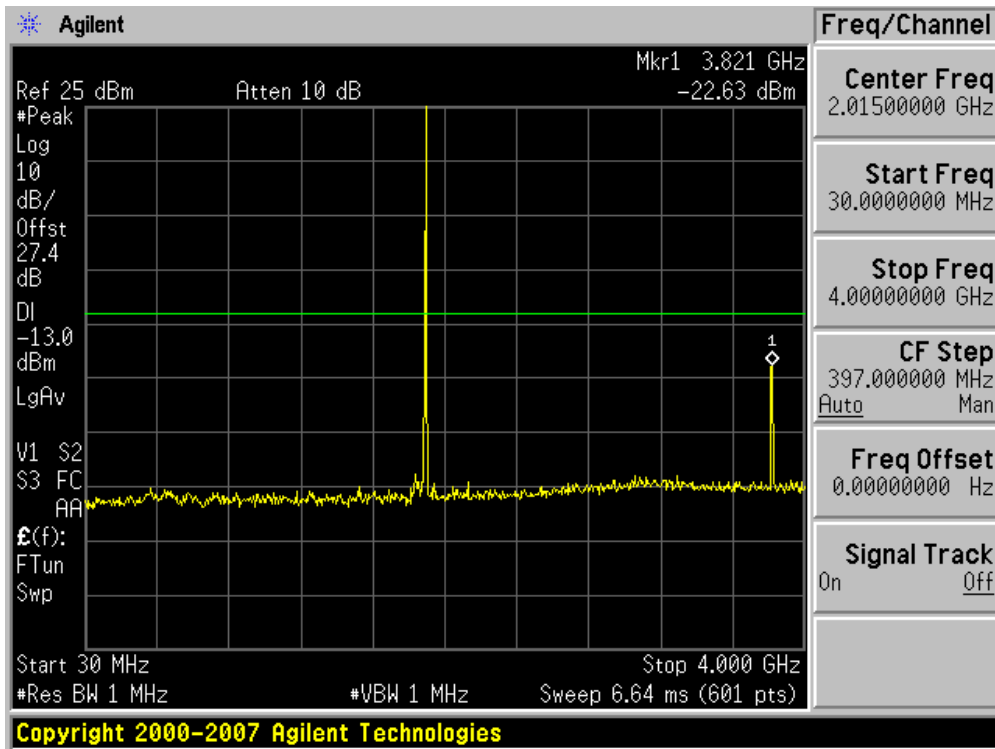

■ PCS CDMA MODE (1175 CH.) Conducted Spurious Emissions 2

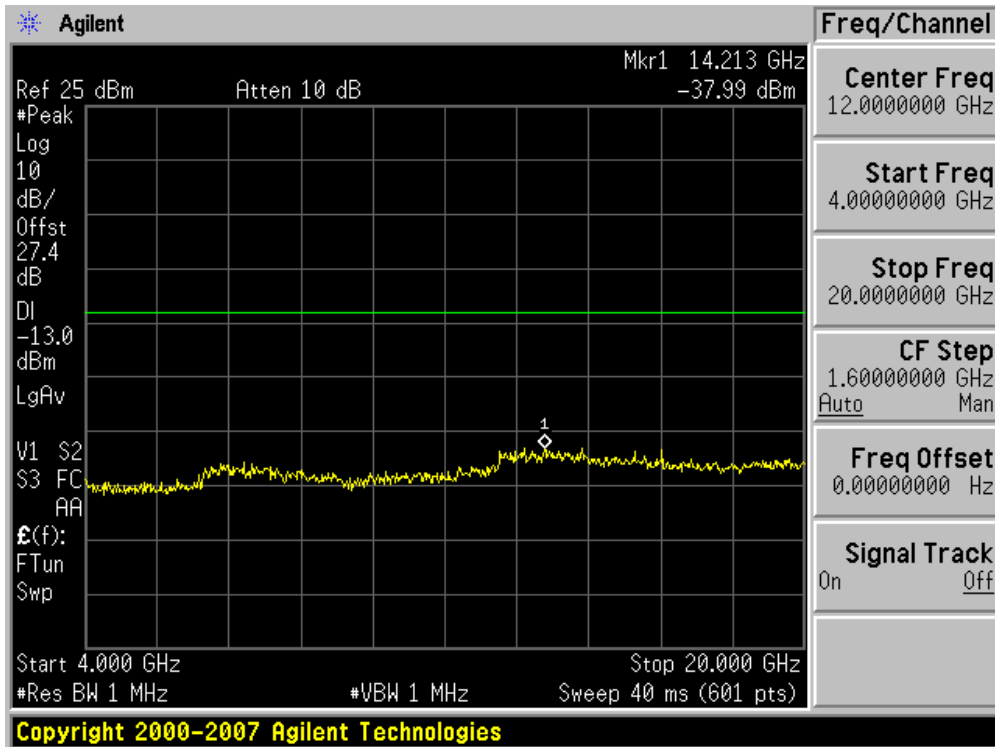

■ GSM850 MODE (128 CH.) Conducted Spurious Emissions1

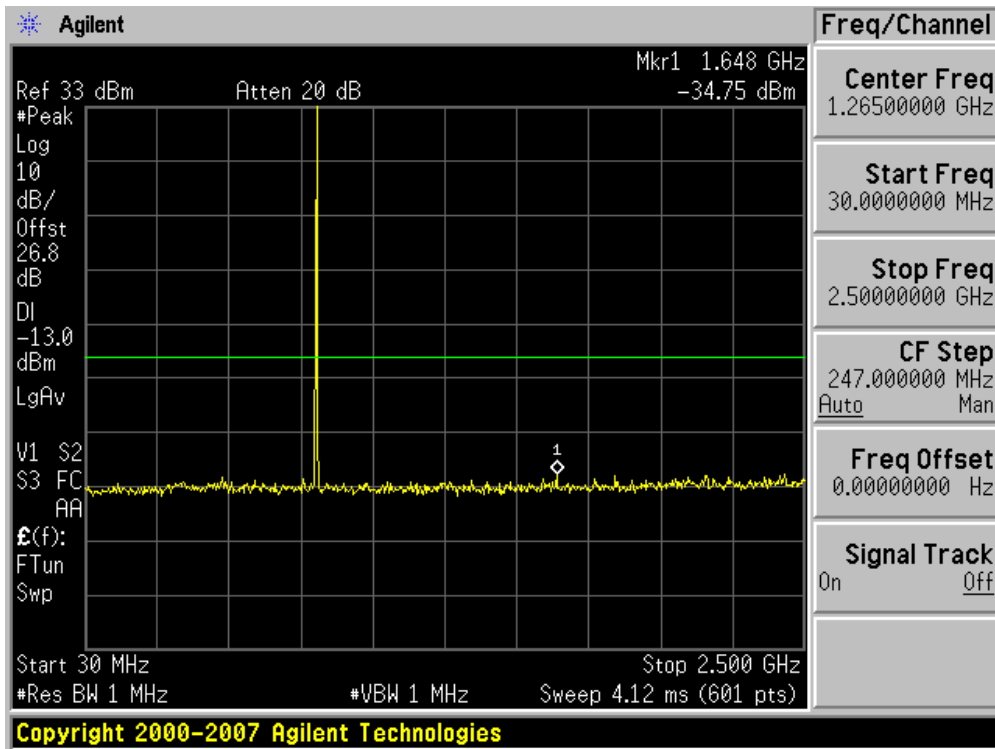

■ GSM850 MODE (128 CH.) Conducted Spurious Emissions2

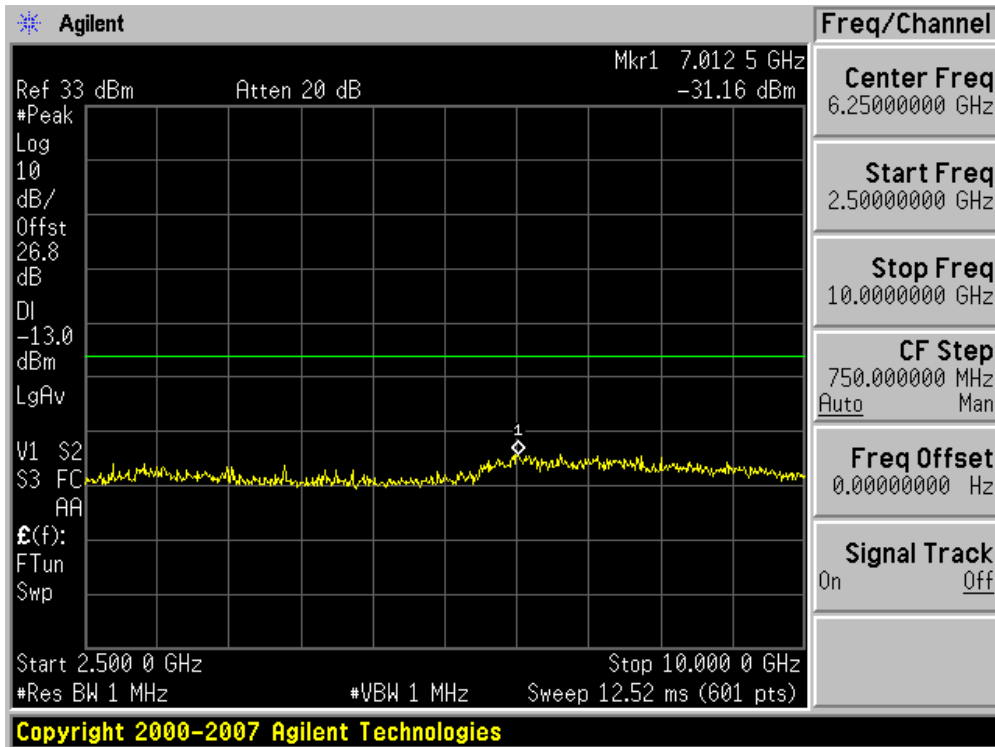

■ GSM850 MODE (190 CH.) Conducted Spurious Emissions1

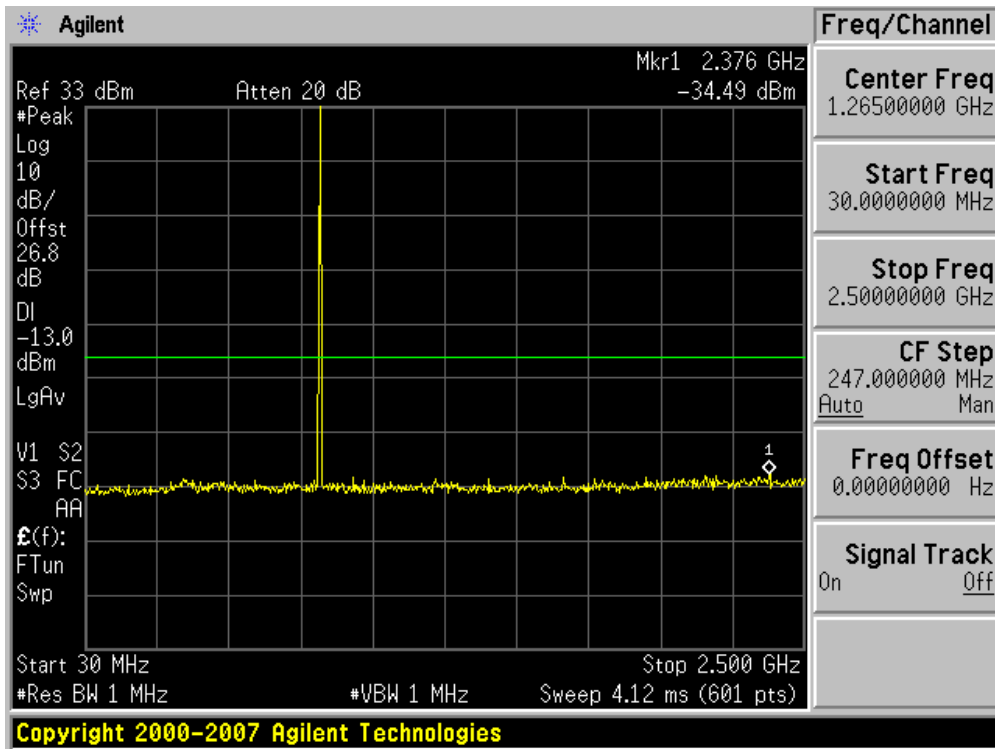

■ GSM850 MODE (190 CH.) Conducted Spurious Emissions2

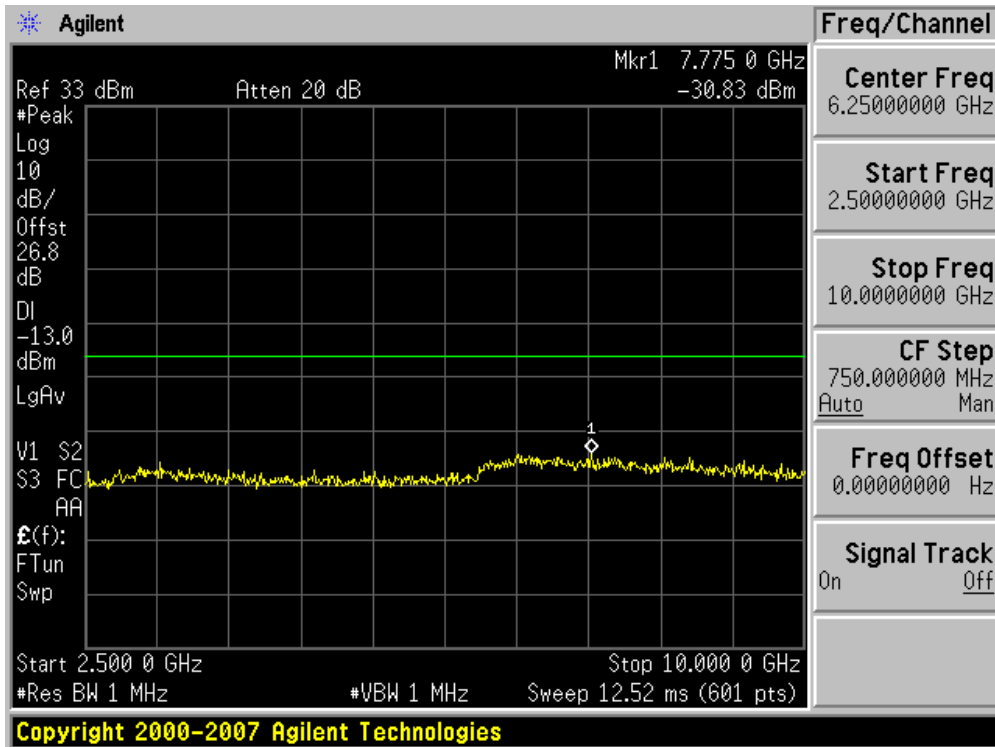

■ GSM850 MODE (251 CH.) Conducted Spurious Emissions1

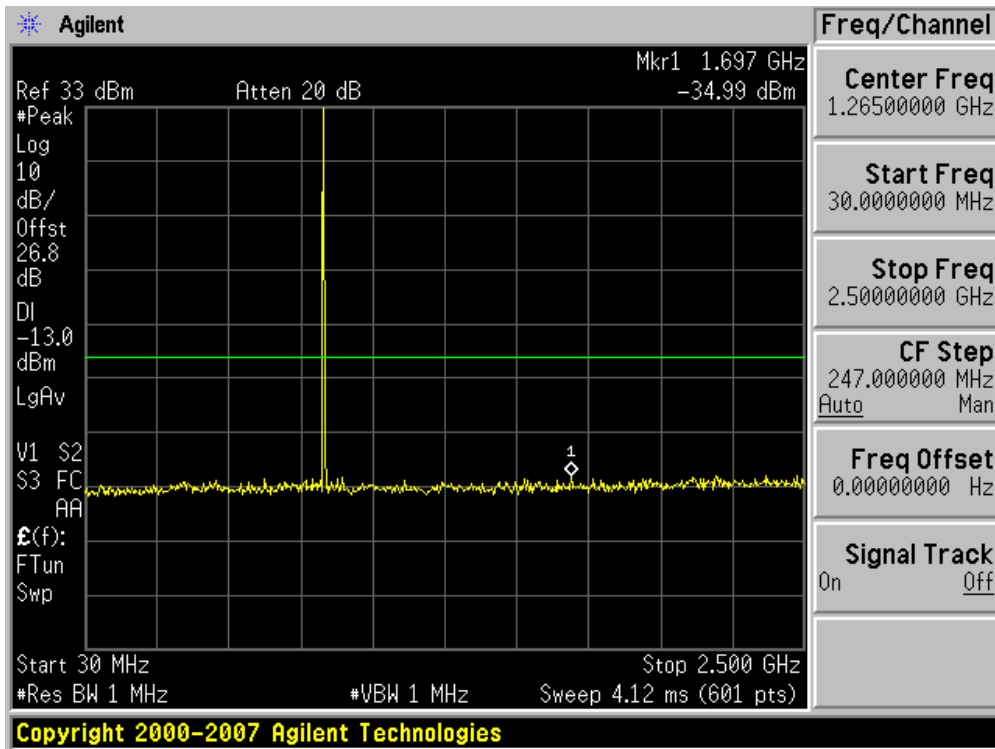

■ GSM850 MODE (251 CH.) Conducted Spurious Emissions2

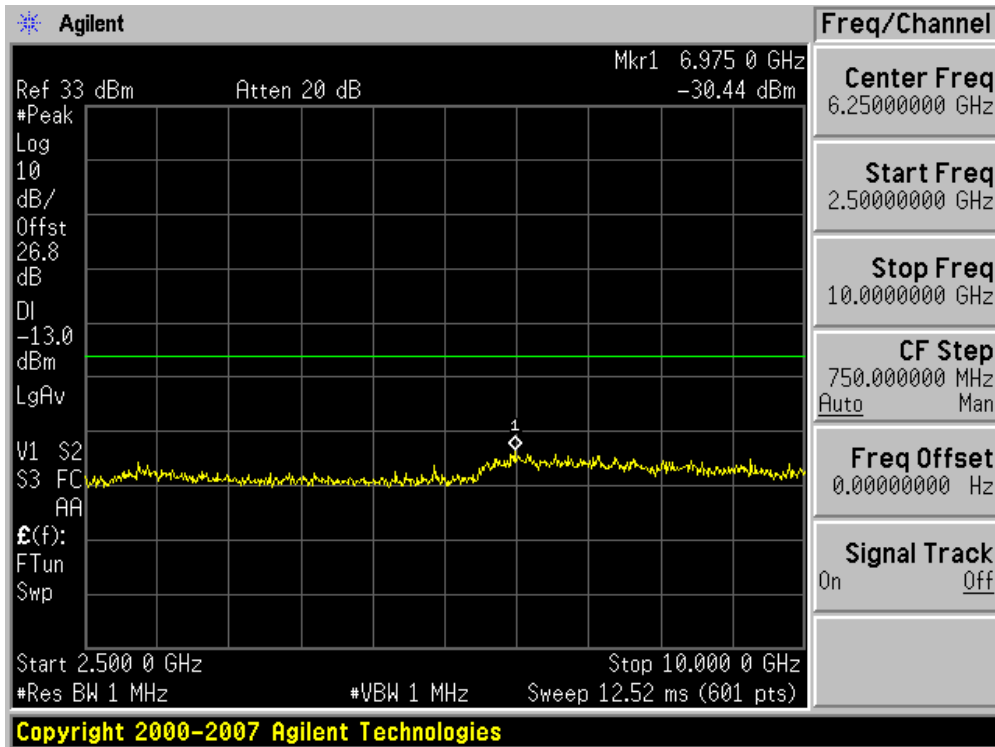

■ GSM1900 MODE (512 CH.) Conducted Spurious Emissions1

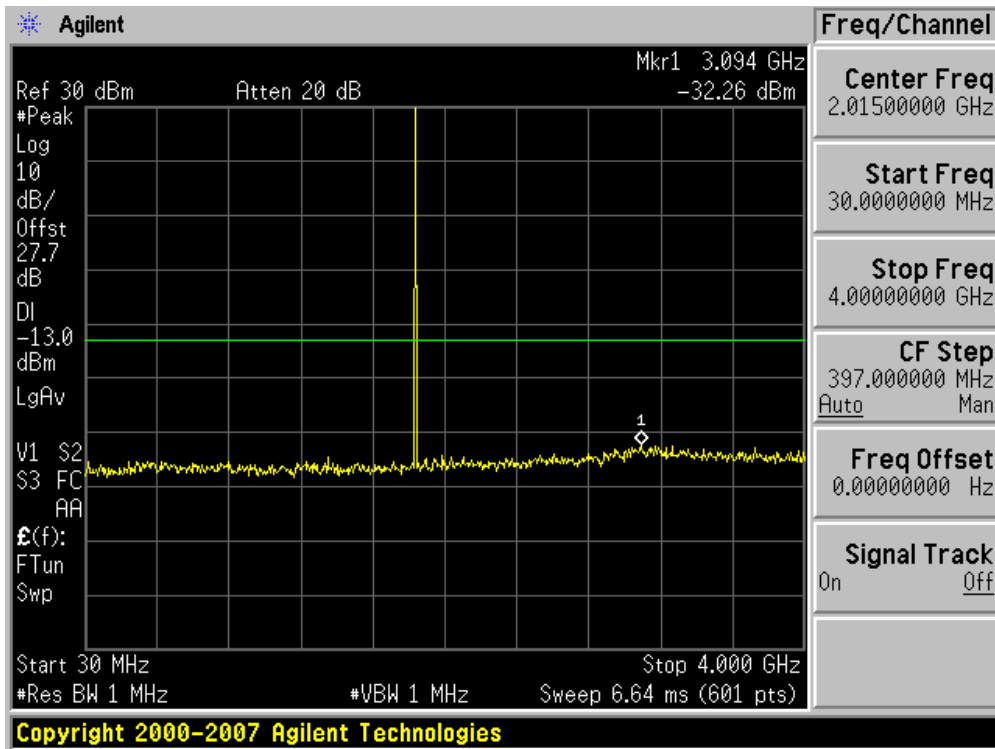

■ GSM1900 MODE (512 CH.) Conducted Spurious Emissions2

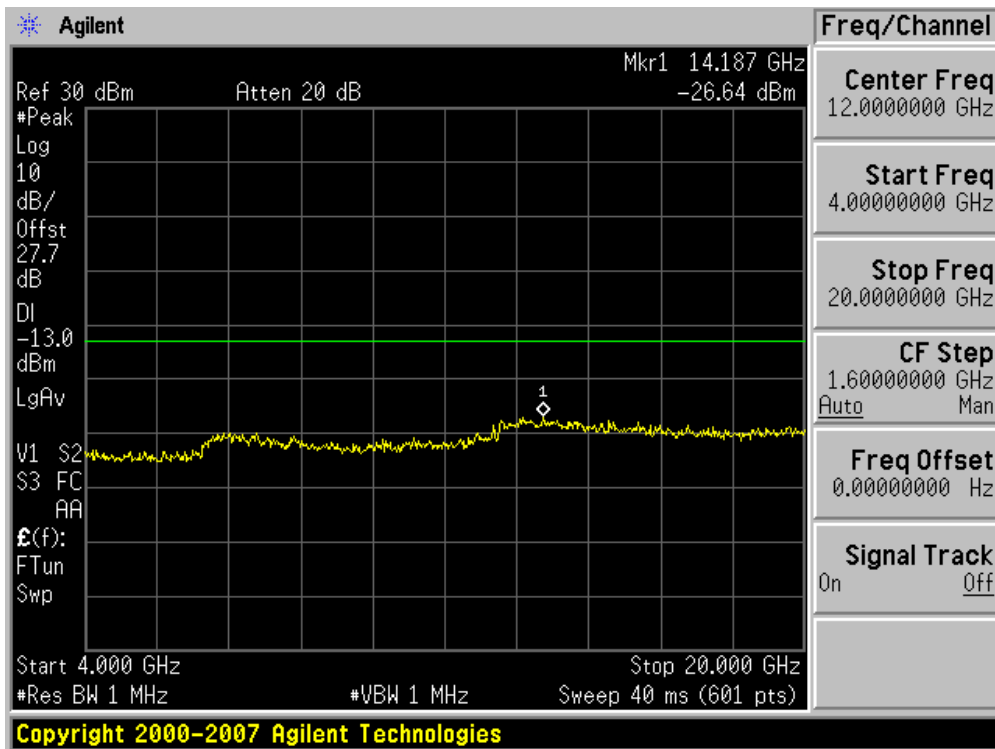



■ GSM1900 MODE (661 CH.) Conducted Spurious Emissions1

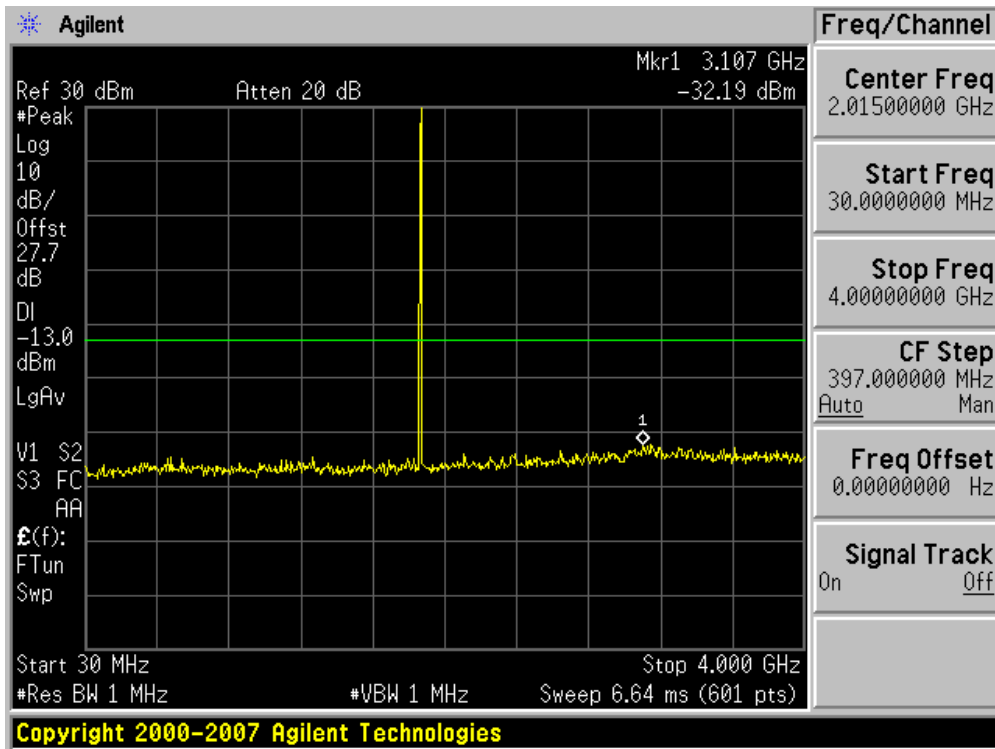

■ GSM1900 MODE (661 CH.) Conducted Spurious Emissions2

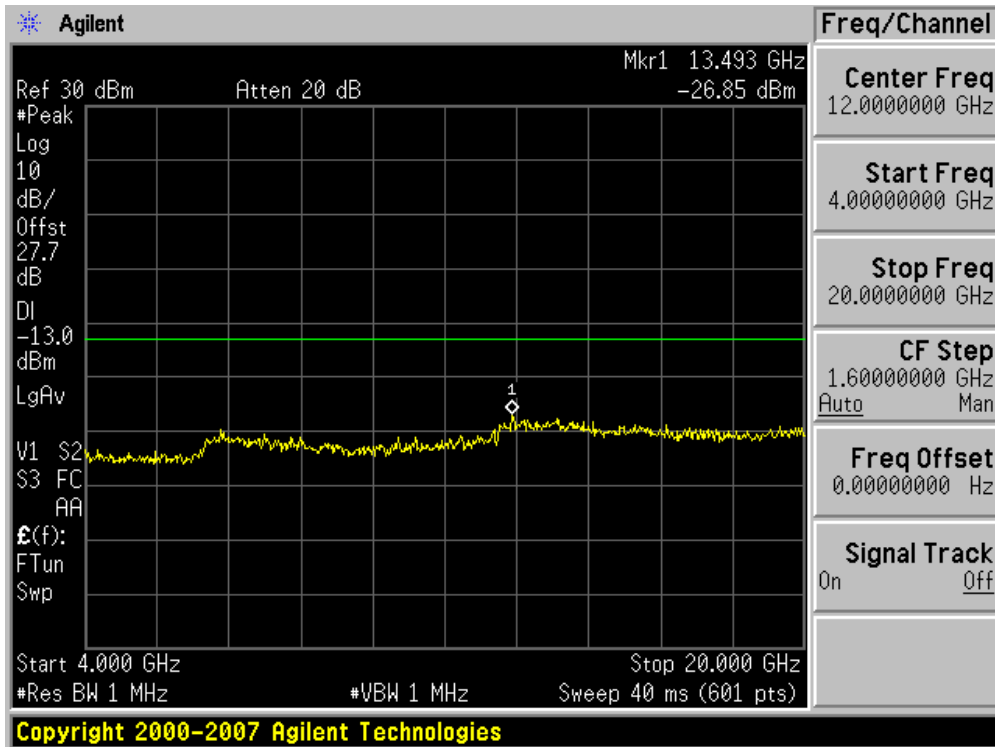

■ GSM1900 MODE (810 CH.) Conducted Spurious Emissions1

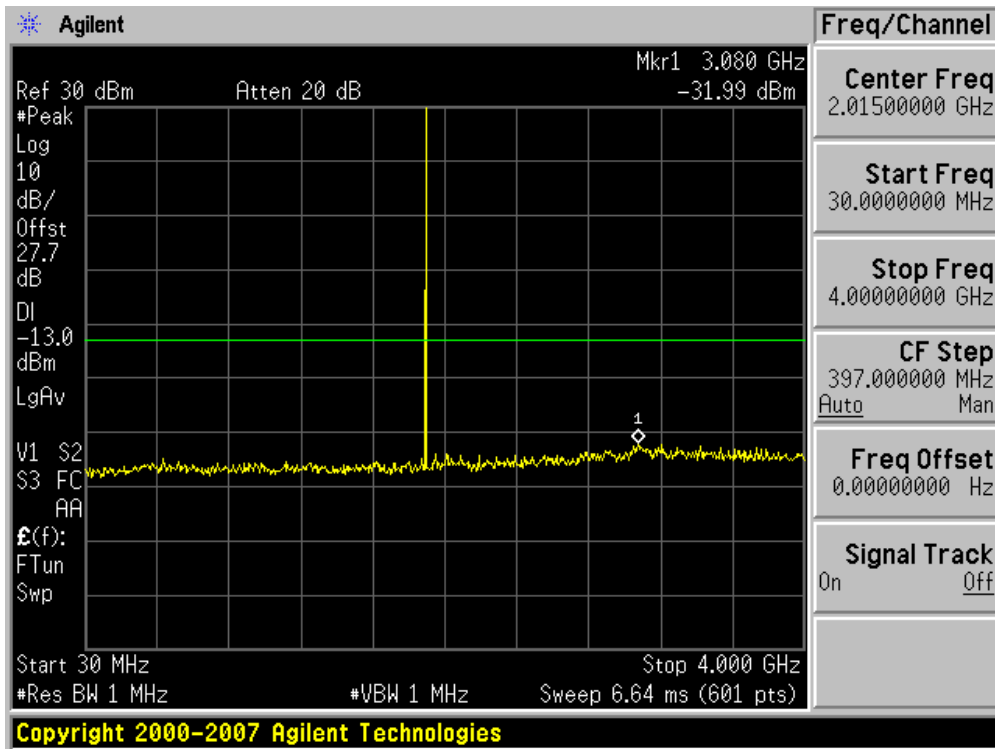

■ GSM1900 MODE (810 CH.) Conducted Spurious Emissions2

