

Specification No.	Description - Antenna Product Specification		
Customer CURITEL , KOREA	Date Nov. 18, 2004	Rev 1.0	Reference

Antenna Specifications

(TX-180)

F							
E							
D							
C							
B							
A	11-18-04	Initial Release	BH				
Rev.	Date	Changes	Initiator	RF approval	ME approval	Approval	Approval

Specification No.	Description - Antenna Product Specification		
Customer CURITEL , KOREA	Date Nov. 18, 2004	Rev 1.0	Reference

Contents

1	General	3
1.1	Product Description.....	3
1.2	Product Number.....	3
1.3	Print Acceptance.....	3
1.4	Units, Definitions, and Abbreviations.....	3
1.5	Interface.....	3
1.6	Conditions.....	3
1.7	Coordinate System	4
2	Electrical Properties	5
2.1	Samples Size	5
2.2	Frequency Bands	5
2.3	Impedance.....	5
2.4	The Radio (Phone / Handset).....	5
2.5	VSWR.....	6
2.6	Gain	16
2.7	Power Rating.....	20
3	Mechanical Properties	21
3.1	Samples Size	21
3.2	Appearance.....	21
3.3	Antenna Bending.....	21
3.4	Antenna Torque.....	21
3.5	Antenna Tensile strength.....	22
3.6	Whip Bending Endurance.....	Error! Bookmark not defined.
3.7	Whip Tensile Strength.....	23
3.8	Whip Retraction / Extension Forces	24
3.9	Drop	24
4	Environmental Resistance Properties	26
4.1	Samples Size	26
4.2	Storage Temperature	26
4.3	Electrical Operational Temperature	26
4.4	Temperature Cycling	26
4.5	Humidity	27
4.6	Sinusoidal Vibration	27
4.7	Corrosion (Salt spray test).....	28
5	Packaging	29
6	Specifications Drawing	30

Specification No.	Description - Antenna Product Specification		
Customer CURITEL , KOREA	Date Nov. 18, 2004	Rev 1.0	Reference

1 GENERAL

1.1 PRODUCT DESCRIPTION

A retractable antenna system.

1.2 PRODUCT NUMBER

Centurion Product Number	CAF94739
Customer Product Number	TX180/TX180A antenna

1.3 PRINT ACCEPTANCE

Samples and a Page one drawing was sent to customer. When they are approved, the approval form should be completed, signed, and sent back to Centurion before further mass production batches can be delivered.

1.4 UNITS, DEFINITIONS, AND ABBREVIATIONS

Unless otherwise stated, SI units are used.

Tx	Transmit Band
Rx	Receive Band
PCB	Printed Circuit Board
VSWR	Voltage Standing Wave Ratio
dBi	Antenna gain in dB (Isotropic)
CW	Continuous Wave
g	Acceleration of gravity (approx. 9.8 m/s ²)
RH	Relative Humidity

1.4.1 “Without mechanical damage”

Implies full mechanical functionality according to specification and compliance with visual requirements according to specification drawing.

1.4.2 “Without permanent mechanical damage”

As above but allows reversible misalignment or deformation and minor visual damage (no through-cuts or holes).

1.4.3 ”Unimpaired functionality”

Implies full mechanical functionality according to specification but allows visual damage (no through-cuts or holes).

1.5 INTERFACE

The antenna/handset interface is designed by Curitel.

1.6 CONDITIONS

Unless otherwise stated all temperature tolerances are $\pm 3^{\circ}\text{C}$ and all RH tolerances are ± 5 percentage units.

Specification No.	Description - Antenna Product Specification		
Customer CURITEL , KOREA	Date Nov. 18, 2004	Rev 1.0	Reference

Unless otherwise stated all values are valid at +20°C and 50% RH.

Unless otherwise stated all values are valid for the radio defined in 2.4

1.7 COORDINATE SYSTEM

The coordinate system for the phone is defined as follows:

- Origin in center of gravity.
- Positive X axis is perpendicular to, and directed from, front plane.
- Positive Y axis is perpendicular to, and directed from, right side plane (as seen from front).
- Positive Z axis is perpendicular to, and directed from, top plane.

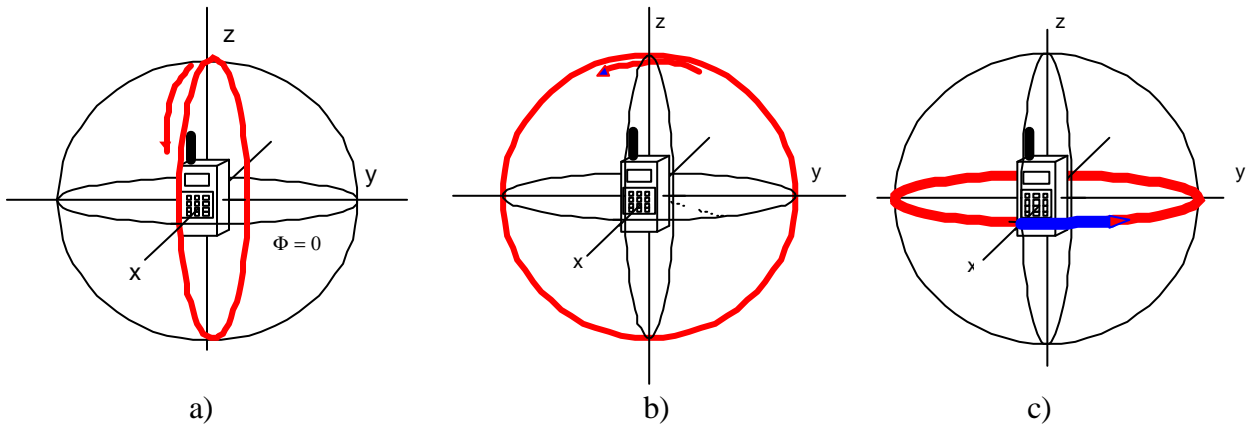

Figure 1-1: a) E0-plane b) E90-plane c) Az-plane

Specification No.	Description - Antenna Product Specification		
Customer CURITEL , KOREA	Date Nov. 18, 2004	Rev 1.0	Reference

2 ELECTRICAL PROPERTIES

2.1 SAMPLES SIZE

All the tests will be conducted as below:

- The VSWR will be measured for 30 samples and a Cpk analysis will be conducted,
- The radiation patterns will be measured on one sample,
- The Power rating test will be conducted on 5 samples.

2.2 FREQUENCY BANDS

CDMA:	Tx:	824 – 849 MHz
	Rx:	869 – 894 MHz
GPS:	Rx:	1575 MHz
PCS :	Tx:	1850 – 1910 MHz
	Rx:	1930 – 1990 MHz

2.3 IMPEDANCE

2.3.1 Nominal Value

50 Ω

2.3.2 Method

Centurion will supply engineering assistance to ensure that the impedance over the frequency bands is as close to 50Ω as possible after matching, both in flip open and flip close status and in extended and retracted modes.

2.4 THE RADIO (PHONE / HANDSET)

2.4.1 Radio Revision

Customer chassis I.D. number **CURITEL TX-180C**

Specification No.	Description - Antenna Product Specification		
Customer CURITEL , KOREA	Date Nov. 18, 2004	Rev 1.0	Reference

2.4.2 Matching

A matching circuit is used to provide best antenna response based on customer requirements for Transmit, Receive and Specific Absorption Rate (SAR). Customer is responsible for verifying operation and performance of matching circuit. Matching network TBD by Centurion Wireless Technologies per Centurion Product Development Request (PDR- 7-27-04)

2.5 VSWR

Typical value of VSWR tested with engineering samples.

2.5.1 VSWR Value (Free Space) - Specifications

See table

Mode	Band	Freq. f in MHz	CLOSE	OPEN	OPEN	CLOSE
			Retracted	Extended	Retracted	Extended
CDMA	Tx	824 < f < 849	3:1	3:1	2:1	2:1
	Rx	869 < f < 894	5:1	2:1	5:1	2:1
GPS	Rx	f = 1575	4:1	6:1	4:1	6:1
PCS	Tx	1850 < f < 1910	3:1	2:1	4:1	2:1
	Rx	1930 < f < 1990	4:1	3:1	4:1	3:1

Table 2.

2.5.2 Method of Measurement

The connection of the coaxial cable is done so as to introduce a minimum of impedance mismatch. A 50Ω semi-rigid coaxial cable is connected (soldered) to the 50Ω antenna feed point on the printed circuit board (PCB). The other end of the semi-rigid coaxial cable is terminated with an SMA type connector. The SMA connector allows the use of a network analyzer or other piece of test equipment with an SMA connection.

A network analyzer is set up and calibrated so the reference plane is at the 50Ω antenna feed point. Voltage Standing Wave Ratio (VSWR) data is gathered using the network analyzer. Data is gathered in a Free Space condition (no conductive surfaces are within at least 1λ of the antenna).

The radio, including the PCB must not in any significant way differ from the mass produced radio, e.g. the antenna feeding parts have to be equivalent to the parts in mass production.

Specification No.	Description - Antenna Product Specification		
Customer CURITEL , KOREA	Date Nov. 18, 2004	Rev 1.0	Reference

2.5.3 Electrical Performance Assurance

In order to guarantee the specified electrical performance in mass production the following procedure is used (example given for a single band antenna). During the pre-production phase, two antennas are selected; one defining the lowest allowable resonance frequency (when measured on the handset), marked "low freq.", and one defining the highest allowable resonance frequency, marked "high freq.", see Figure 2-1. These antennas are designated "Reference Antennas". Only the retracted mode is considered when finding the reference antennas, since the production variation of the extended mode is negligible. The reference antennas are measured on a ground plane or a fixture used in mass production. This measurement is done to define the highest and lowest allowable resonance frequencies on the production ground plane or a fixture. Each produced antenna is automatically tested in this way.

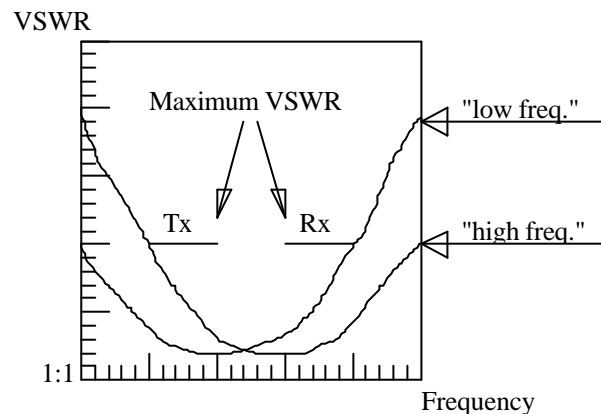
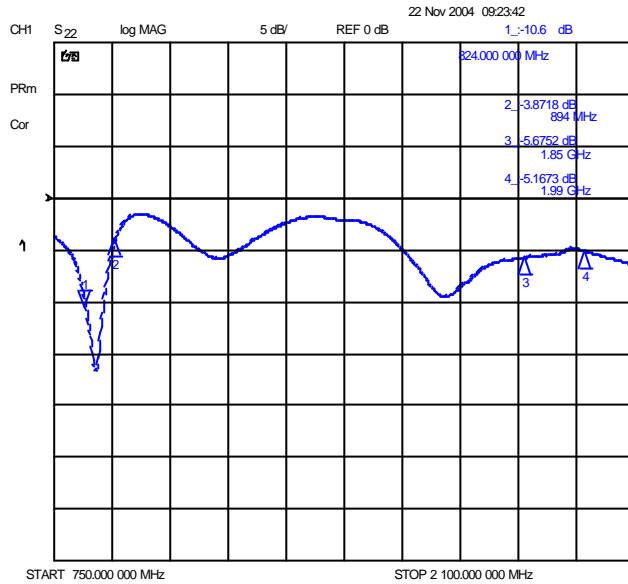

Figure 2-1: Reference antennas defining the lowest and highest allowable resonance frequencies for a single band antenna

Specification No.	Description - Antenna Product Specification		
Customer CURITEL , KOREA	Date Nov. 18, 2004	Rev 1.0	Reference

2.5.4 VSWR Plots (Free Space)



Return Loss
 Antenna Retracted Flip Open

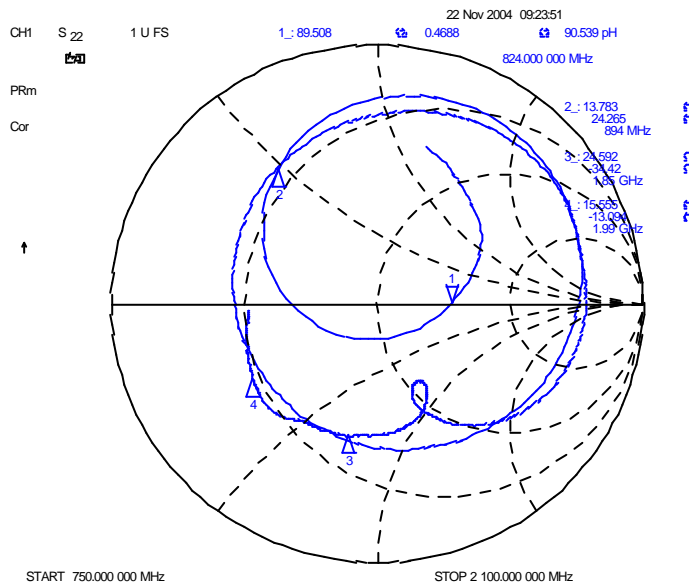

Impedance Smith Chart
 Antenna Retracted Flip Open

Specification No.	Description - Antenna Product Specification		
Customer CURITEL , KOREA	Date Nov. 18, 2004	Rev 1.0	Reference

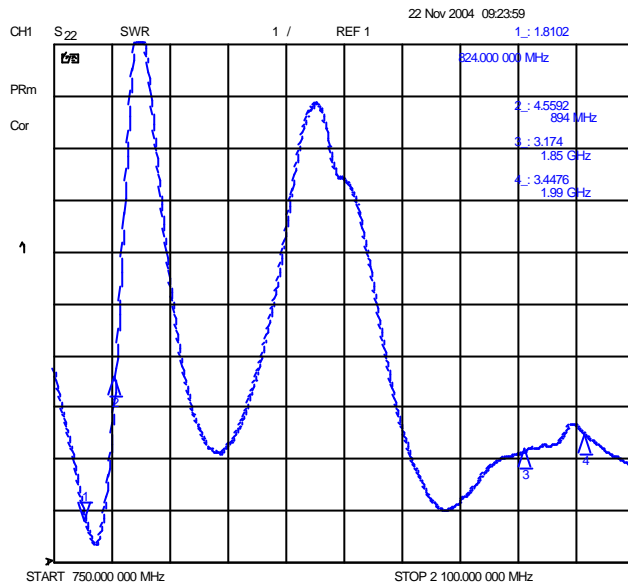

VSWR
Antenna Retracted Flip Open

Figure 2-2: VSWR Plot – Retracted Open

Specification No.	Description - Antenna Product Specification		
Customer CURITEL , KOREA	Date Nov. 18, 2004	Rev 1.0	Reference

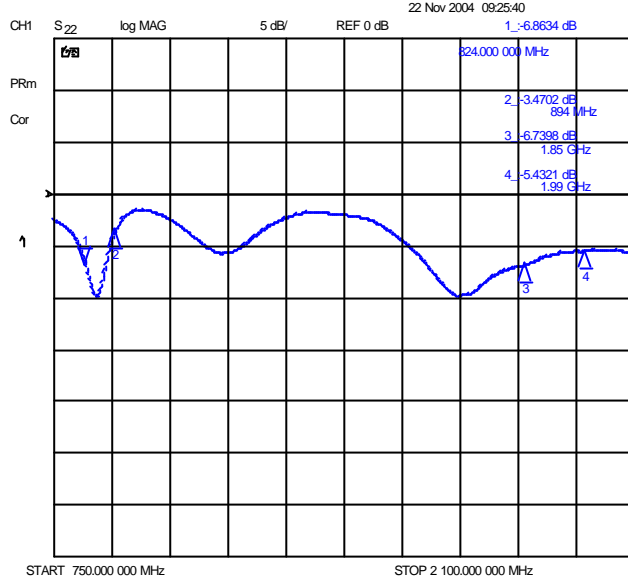

Return Loss
Antenna Retracted Flip Closed

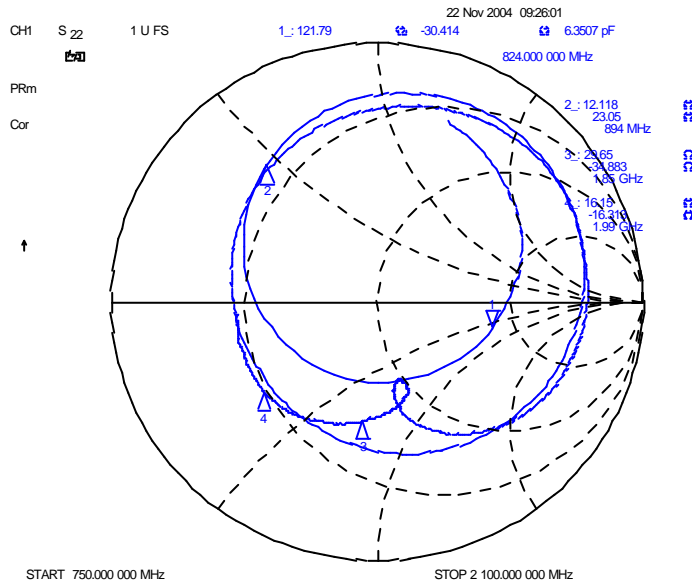

Impedance Smith Chart
Antenna Retracted Flip Closed

Specification No.	Description - Antenna Product Specification		
Customer CURITEL , KOREA	Date Nov. 18, 2004	Rev 1.0	Reference

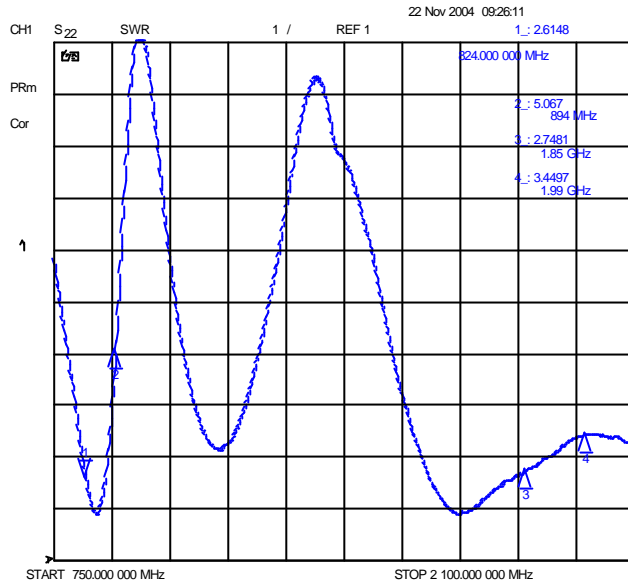

VSWR
 Antenna Retracted Flip Closed

Figure 2-3: VSWR Plot – Retracted Close

Specification No.	Description - Antenna Product Specification		
Customer CURITEL , KOREA	Date Nov. 18, 2004	Rev 1.0	Reference

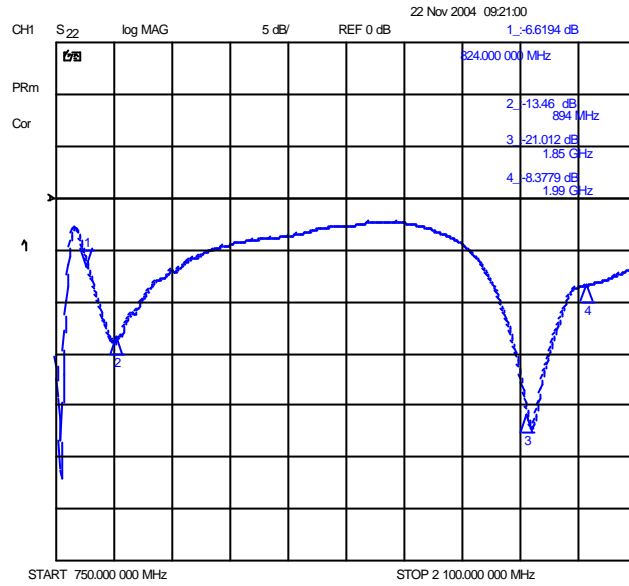

Return Loss
Antenna Extended Flip Open

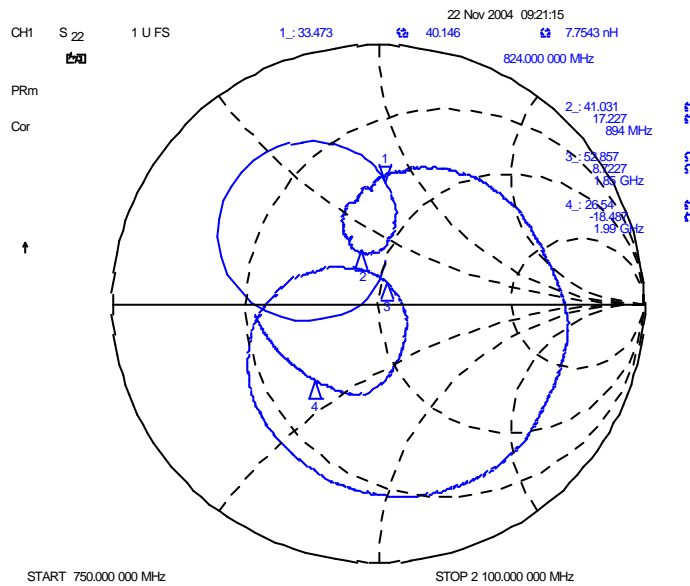

Impedance Smith Chart
Antenna Extended Flip Open

Specification No.	Description - Antenna Product Specification		
Customer CURITEL , KOREA	Date Nov. 18, 2004	Rev 1.0	Reference

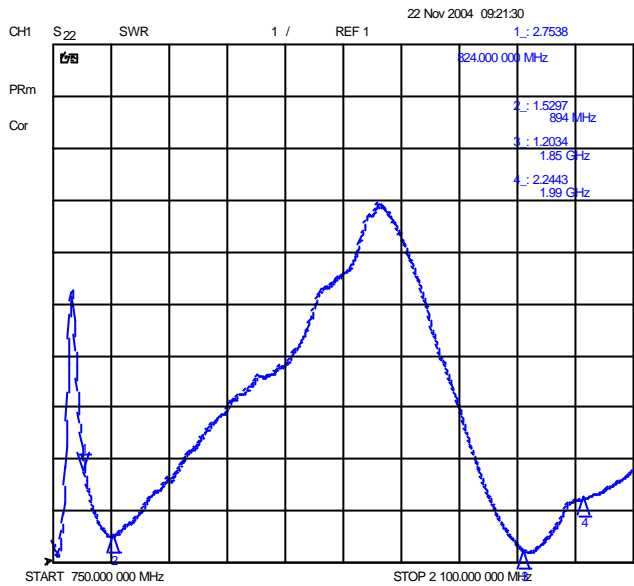

VSWR
 Antenna Extended Flip Open

Figure 2-4: VSWR Plot – Extended Open

Specification No.	Description - Antenna Product Specification		
Customer CURITEL , KOREA	Date Nov. 18, 2004	Rev 1.0	Reference

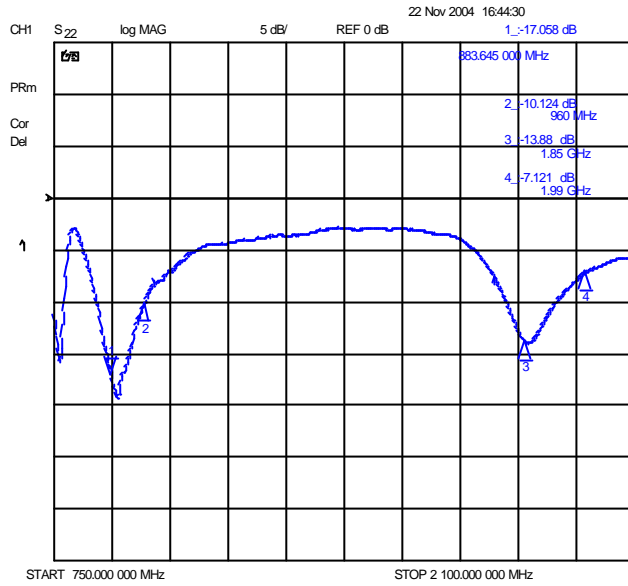

Return Loss
 Antenna Extended Flip Closed

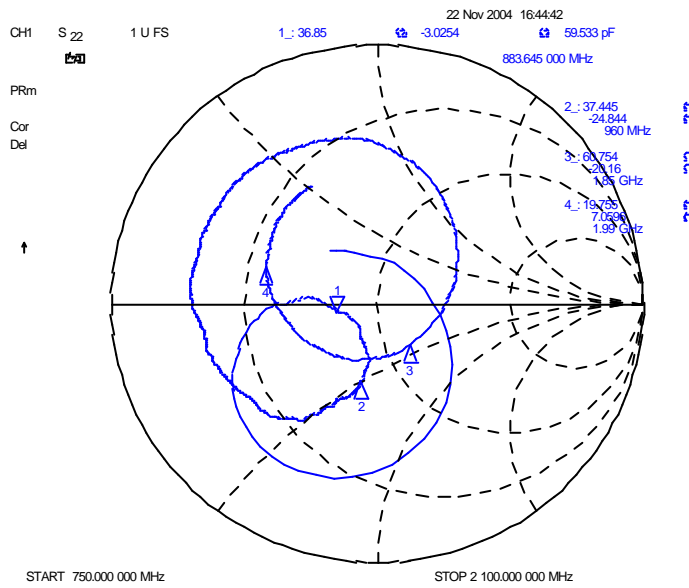

Impedance Smith Chart
 Antenna Extended Flip Closed

Specification No.	Description - Antenna Product Specification		
Customer CURITEL , KOREA	Date Nov. 18, 2004	Rev 1.0	Reference

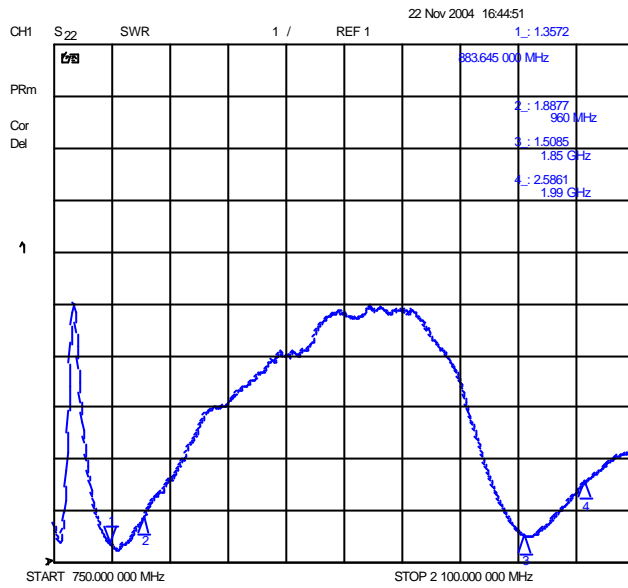

VSWR
 Antenna Extended Flip Closed

Figure 2-5: VSWR Plot – Extended Close

Specification No.	Description - Antenna Product Specification		
Customer CURITEL , KOREA	Date Nov. 18, 2004	Rev 1.0	Reference

2.6 GAIN

Below are typical peak gain and average gain values for flip close and open and for extracted and retracted positions.

2.6.1 Typical Peak Values (in dBi) – Az plan

		EXT / OP	RET / CL	RET / OP
CDMA	Tx	1.5	0.0	1.0
	Rx	1.5	-1.0	1.0
GPS	1575 MHz	0.0	0.0	0.0
PCS	Tx	0.0	0.0	0.0
	Rx	-1.0	0.0	0.0

2.6.2 Typical Average Values (in dBi) – Az plan

		EXT / OP	RET / CL	RET / OP
CDMA	Tx	0.0	-1.0	0.0
	Rx	0.0	-1.5	-1.0
GPS	1575 MHz	-3.0	-3.0	-1.0
PCS	Tx	-2.0	-1.0	-2.0
	Rx	-2.0	-1.0	-2.0

2.6.3 Method of Measurement and Radiation Patterns

The connection is done according to 2.5.2, Radiation patterns are measured at the Transmit and Receive band edges for each band defined in 2.2. The measurements are performed so as to minimize the influence of connecting cables. The total electric field is measured, i.e. the vector sum of two orthogonal polarizations.

Calibration for absolute measurements is done using a reference antenna. A certified calibration company calibrates the reference antenna for use in the Centurion anechoic chambers.

Specification No.	Description - Antenna Product Specification		
Customer CURITEL , KOREA	Date Nov. 18, 2004	Rev 1.0	Reference

2.6.4 Radiation Patterns

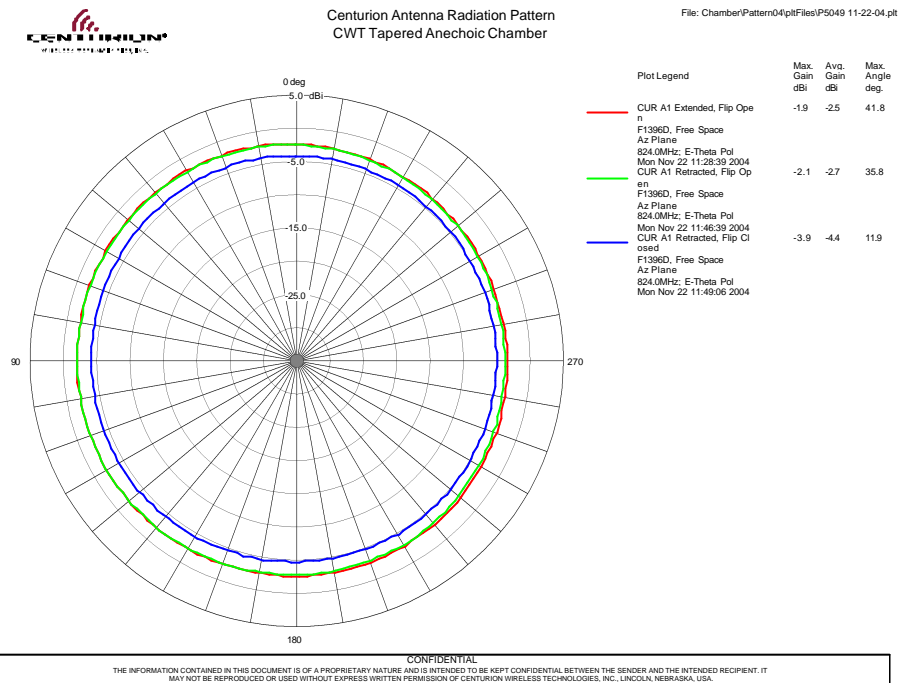

Figure 2-6: OPEN EXTENDED /OPEN & CLOSE RETRACTED CDMA (824 MHz) – Az

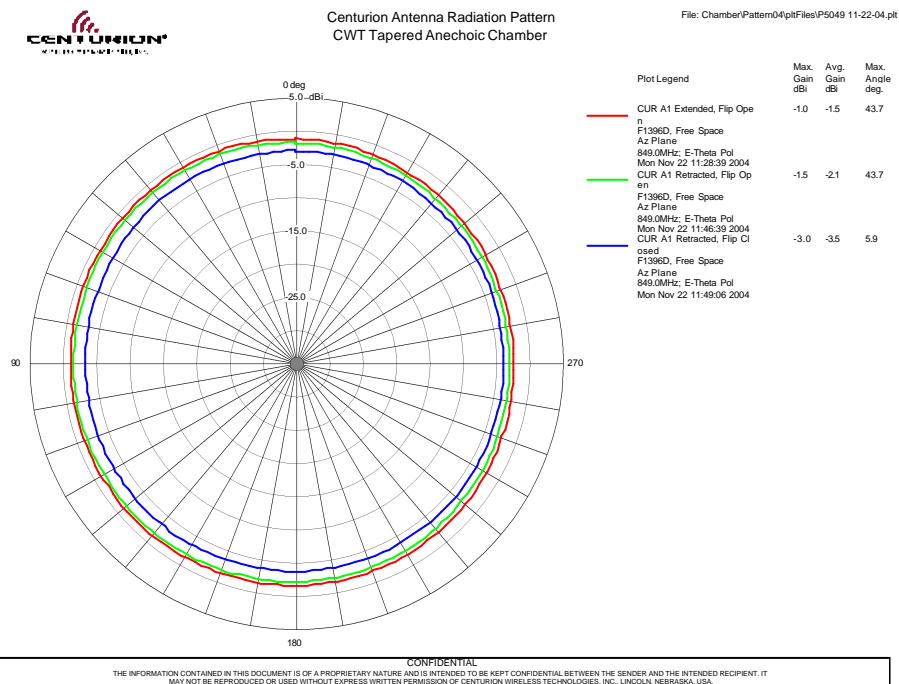

Figure 2-7: OPEN EXTENDED /OPEN & CLOSE RETRACTED CDMA (849 MHz) – Az

Specification No.	Description - Antenna Product Specification		
Customer CURITEL , KOREA	Date Nov. 18, 2004	Rev 1.0	Reference

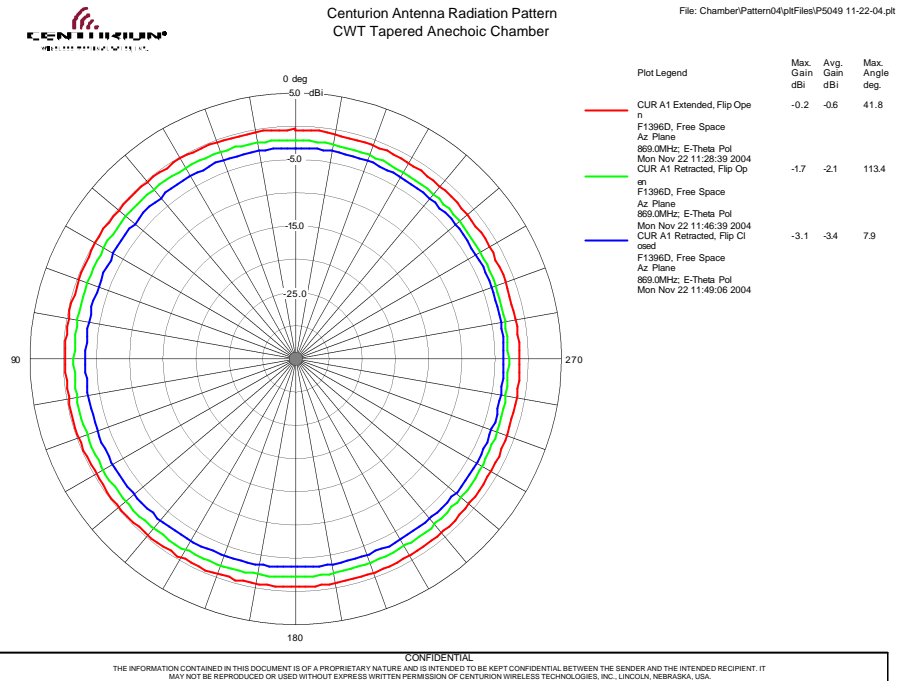

Figure 2-8: OPEN EXTENDED /OPEN & CLOSE RETRACTED CDMA (869 MHz) – Az

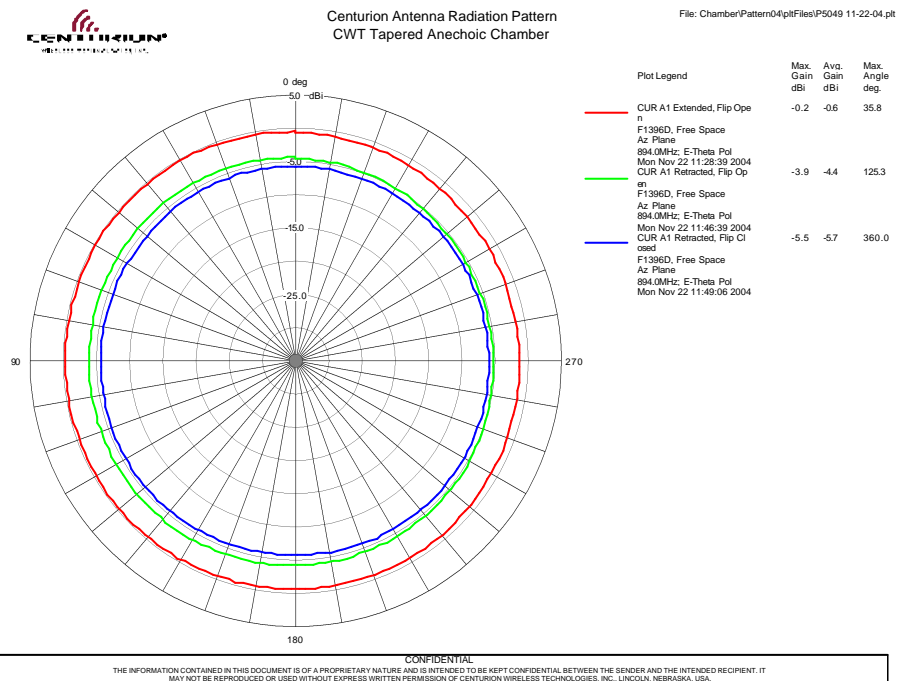
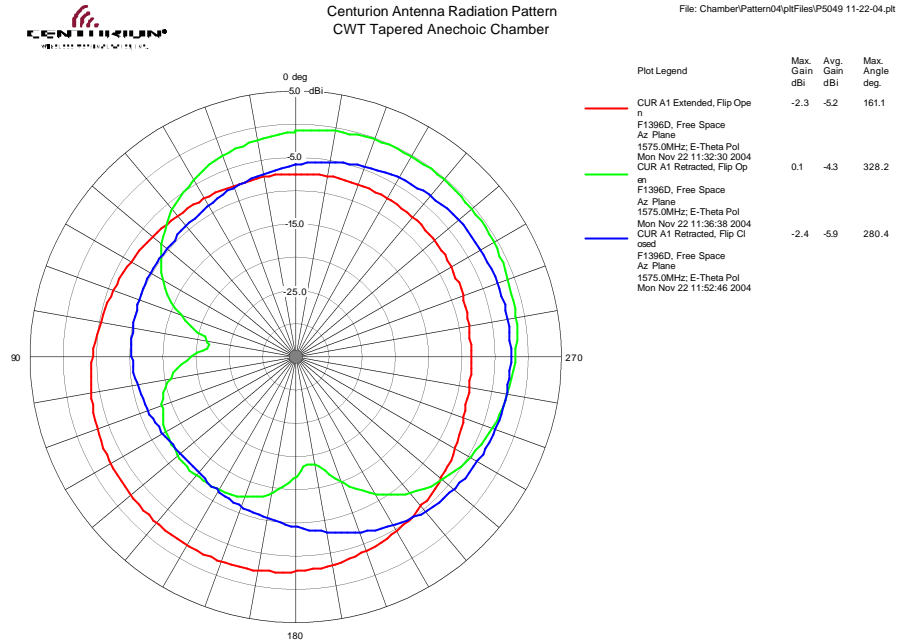

Figure 2-9: OPEN EXTENDED /OPEN & CLOSE RETRACTED CDMA (894 MHz) – Az

Specification No.	Description - Antenna Product Specification		
Customer CURITEL , KOREA	Date Nov. 18, 2004	Rev 1.0	Reference



CONFIDENTIAL
 THE INFORMATION CONTAINED IN THIS DOCUMENT IS OF A PROPRIETARY NATURE AND IS INTENDED TO BE KEPT CONFIDENTIAL BETWEEN THE SENDER AND THE INTENDED RECIPIENT. IT MAY NOT BE REPRODUCED OR USED WITHOUT EXPRESS WRITTEN PERMISSION OF CENTURION WIRELESS TECHNOLOGIES, INC., LINCOLN, NEBRASKA, USA.

Figure 2-10: OPEN EXTENDED /OPEN & CLOSE RETRACTED GPS (1575 MHz) – Az

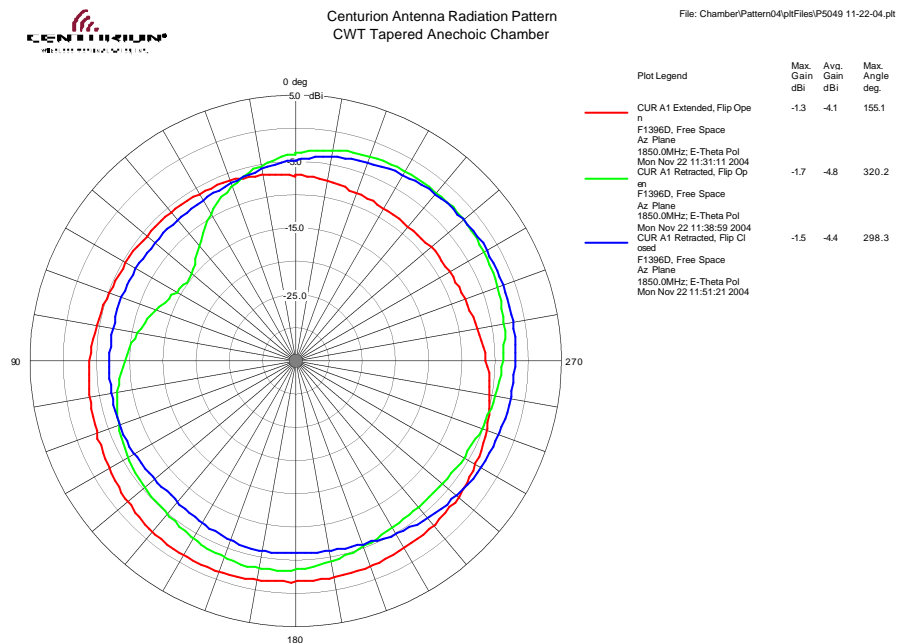

CONFIDENTIAL
 THE INFORMATION CONTAINED IN THIS DOCUMENT IS OF A PROPRIETARY NATURE AND IS INTENDED TO BE KEPT CONFIDENTIAL BETWEEN THE SENDER AND THE INTENDED RECIPIENT. IT MAY NOT BE REPRODUCED OR USED WITHOUT EXPRESS WRITTEN PERMISSION OF CENTURION WIRELESS TECHNOLOGIES, INC., LINCOLN, NEBRASKA, USA.

Figure 2-11: OPEN EXTENDED /OPEN & CLOSE RETRACTED PCS (1850 MHz) – Az

Specification No.	Description - Antenna Product Specification		
Customer CURITEL , KOREA	Date Nov. 18, 2004	Rev 1.0	Reference

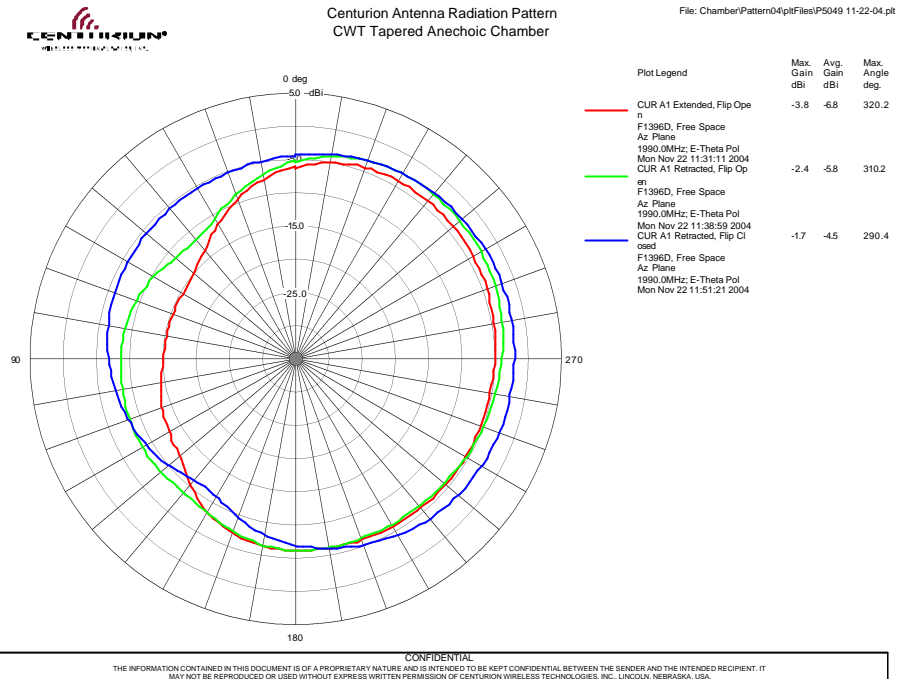

Figure 2-12: OPEN EXTENDED /OPEN & CLOSE RETRACTED PCS (1990 MHz) – Az

2.7 POWER RATING

2.7.1 Maximum Value

Maximum Power delivered to the antenna shall be less than or equal to 2 Watts.

2.7.2 Post Test Requirements

Neither mechanical damage (ref. 1.4.1) nor electrical performance reduction (ref. 2.5.1) should be observed after the test.

2.7.3 Method of Measurement

The connection is done according to 2.5.2. The specified power, P, is applied for 10 minutes at the middle frequency of each Tx band defined in 2.2. Immediately after the test the VSWR is measured.

Specification No.	Description - Antenna Product Specification		
Customer CURITEL , KOREA	Date Nov. 18, 2004	Rev 1.0	Reference

3 MECHANICAL PROPERTIES

3.1 SAMPLES SIZE

All the tests will be conducted on 5 samples.

3.2 APPEARANCE

The appearance shall be according to specification drawing (see 6).

3.3 ANTENNA BENDING

3.3.1 Bending Force:

$$F_b = 50 \text{ N}$$

3.3.2 Post Test Requirements:

The antenna satisfied the electrical data (ref. 2.5.1) without permanent mechanical damage (ref. 1.4.2).

3.3.3 Measuring Method

Antenna is assembled to the test equipment according to Figure 3-1. Force is applied to the antenna 10 mm above the handset/antenna interface till F_b is reached.

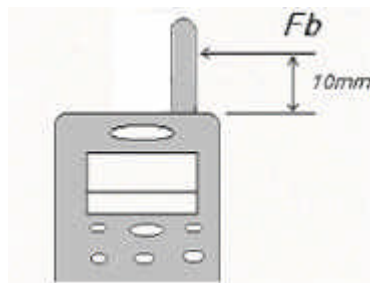

Figure 3-1: Bending

3.4 ANTENNA TORQUE

3.4.1 Minimum Value:

$$T = 30 \text{ N.cm}$$

3.4.2 Post Test Requirements:

The antenna satisfied the electrical data (ref. 2.5.1) without permanent mechanical damage (ref. 1.4.2).

3.4.3 Measuring Method

Antenna is assembled to the test equipment. A torque instrument is attached to the antenna cover without introduction of any radial forces. The specified torque, T, is applied in clockwise direction according to Figure 3-2.

Specification No.	Description - Antenna Product Specification		
Customer CURITEL , KOREA	Date Nov. 18, 2004	Rev 1.0	Reference

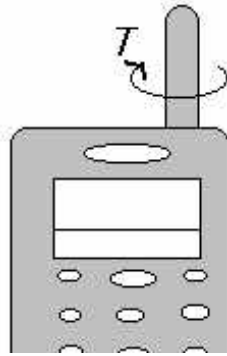

Figure 3-2: Torque

3.5 ANTENNA TENSILE STRENGTH

3.5.1 Minimum Value:

$$F = 50N$$

3.5.2 Post Test Requirements

The antenna satisfied the electrical data (ref. 2.5.1) without permanent mechanical damage (ref. 1.4.2).

3.5.3 Measuring Method

Antenna is assembled to the test equipment according to Figure 3-3. The specified force, F_h , is applied to the top of the antenna parallel to the antenna axis.

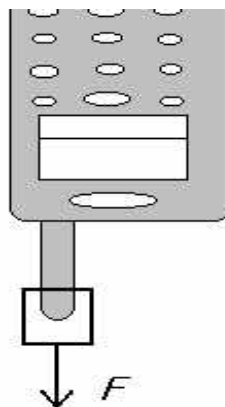

Figure 3-3: Antenna tensile strength test

Specification No.	Description - Antenna Product Specification		
Customer CURITEL , KOREA	Date Nov. 18, 2004	Rev 1.0	Reference

3.6 WHIP BENDING ENDURANCE

3.6.1 Number of Cycles

200 cycles, according to Figure 3-4.

3.6.2 Post Test Requirements

The antenna satisfied the electrical data (ref. 2.5.1) without permanent mechanical damage (ref. 1.4.2).

3.6.3 Measuring Method

The antenna is attached to the test equipment in extended mode according to Figure 3-4. The antenna is bent 90° left and 90° right (1 cycle) with 6 s cycle time.



Figure 3-4: Whip bending test

3.7 WHIP TENSILE STRENGTH

3.7.1 Force

$F_w = 50N$

3.7.2 Post Test Requirements

The antenna satisfied the electrical data (ref. 2.5.1) without permanent mechanical damage (ref. 1.4.2).

3.7.3 Measuring Method

The antenna is assembled to the test equipment according to Figure 3-5. The specified force, F_w , is applied during 30s to the top of the whip parallel to the antenna axis.

Specification No.	Description - Antenna Product Specification		
Customer CURITEL , KOREA	Date Nov. 18, 2004	Rev 1.0	Reference



Figure 3-5: Whip Tensile Strength

3.8 WHIP RETRACTION / EXTENSION FORCES

3.8.1 Forces.

	1 – 10 000 cycles
Extension from retracted position:	0.2 ~ 0.6 Kg
Locking in extended position:	0.2 ~ 0.6 Kg
Retraction from extended position:	0.2 ~ 0.6 Kg
Locking in retracted position:	0.2 ~ 0.6 Kg

3.8.2 Retraction/Extension Cycles

The antenna is fully extended/retracted (1 cycle). For 10 000 cycles.

3.8.3 Post Test Requirements

The mean value from 2 measurements of each force, made on each antenna, shall be within the specified limits for the duration of test. The antenna satisfied the electrical data (ref. 2.5.1) without mechanical damage (ref. 1.4.1).

3.8.4 Measuring Method

The antenna is fully extended and retracted. The maximum force is registered. The forces are measured after 1 and 10 000 completed cycles.

3.9 DROP

3.9.1 Post Test Requirements

The antenna satisfies the electrical data (ref. 2.5.1) without permanent mechanical damage (ref. 1.4.2).

Specification No.	Description - Antenna Product Specification		
Customer CURITEL , KOREA	Date Nov. 18, 2004	Rev 1.0	Reference

3.9.2 Measuring Method

The antenna is attached to handset and fully retracted (if available, otherwise to test fixture of equal weight), see Figure 3-6. The handset is dropped, with antenna pointing down, onto a steel surface.

Drop height: 1.5 m

Handset weight: XXXXX TBD by Curitel.

Cycles: 3 Cycles in retracted mode

Angle: handset is falling without any steering, antenna should hit the steel surface in any possible angle.

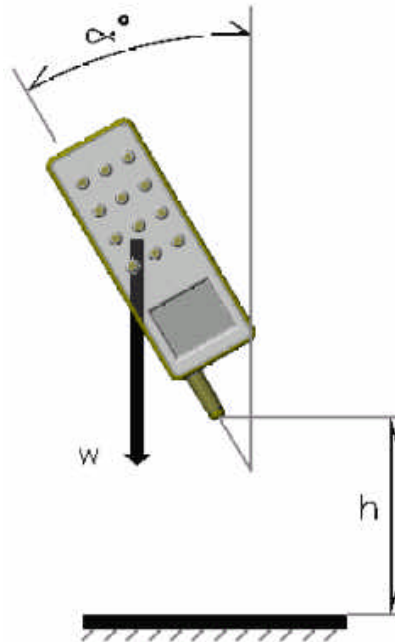

Figure 3-6: Drop test

Specification No.	Description - Antenna Product Specification		
Customer CURITEL , KOREA	Date Nov. 18, 2004	Rev 1.0	Reference

4 ENVIRONMENTAL RESISTANCE PROPERTIES

4.1 SAMPLES SIZE

All the tests will be conducted on 5 samples.

4.2 STORAGE TEMPERATURE

4.2.1 Temperature:

- 35? ~ + 85?

4.2.2 Time:

Each 96 hours

4.2.3 Post Test Requirements

No visual, fitting or mold changes have been observed after the test.
 The antenna satisfied the electrical data.

4.3 ELECTRICAL OPERATIONAL TEMPERATURE

4.3.1 Conditions

$T_{LO} = -30^{\circ}C$

$T_{HO} = +80^{\circ}C$ at 50% RH

4.3.2 Post Test Requirements

Electrical performance according to 2.5.1 after test.

4.3.3 Measuring Method

To measure the VSWR, the connection is done according to 2.5.1.

The antenna is kept at $+20^{\circ}C$ at 50% RH for at least 1 hour.

The antenna is placed at temperature T_{LO} and after 1 hour the free space VSWR is measured.

The antenna is kept at $+20^{\circ}C$ at 50% RH for at least 1 hour.

The antenna is placed at temperature T_{HO} and after 1 hour the free space VSWR is measured.

4.4 TEMPERATURE CYCLING

4.4.1 Conditions

$T_{LC} = -40^{\circ}C$

$T_{HC} = +80^{\circ}C$

4.4.2 Post Test Requirements

Without mechanical damage (ref. 1.4.1) after a 24 hour relaxing period at $+20^{\circ}C$ and 50% RH and electrical performance according to 2.5.1, after a 1 hour relaxing period at $+20^{\circ}C$ and 50% RH.

Specification No.	Description - Antenna Product Specification		
Customer CURITEL , KOREA	Date Nov. 18, 2004	Rev 1.0	Reference

4.4.3 Measuring Method

The antenna is placed in a climatic chamber. The temperature is cycled as follows: The temperature is kept constant at T_{LC} for 1 hour, increased to T_{HC} during 1 hour, kept constant at T_{HC} for 1 hour, and then decreased to T_{LC} during 1 hour. This procedure is repeated 10 times ending at $+20^{\circ}\text{C}$ and 50% RH, see Figure 4-1.

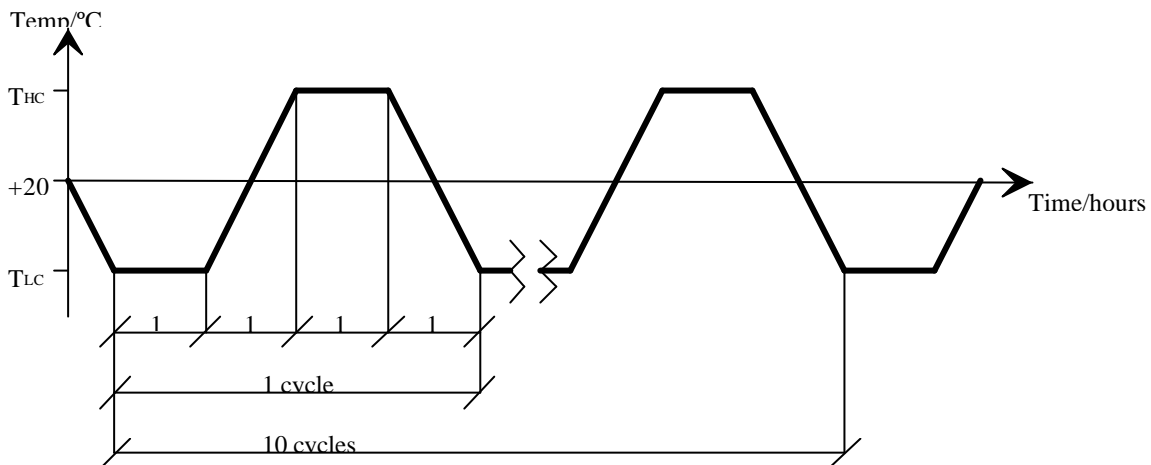

Figure 4-1: Temperature Cycling

4.5 HUMIDITY

4.5.1 Condition:

95% RH / $+ 55^{\circ}\text{C}$

4.5.2 Post Test Requirements

The antenna satisfies the electrical data (ref. 2.5.1) without permanent mechanical damage (ref. 1.4.2).

4.5.3 Measuring method

The antenna is placed in climatic chamber for 24 hours. The antenna is taken out from the chamber and measured after another 24 hours in room temperature ($+20^{\circ}\text{C}$ and 50% RH).

4.6 SINUSOIDAL VIBRATION

4.6.1 Vibration Frequencies:

10 - 55 - 10 Hz (1 cycle)

4.6.2 Sweep Rate:

0.5 octave/min (logarithmic)

4.6.3 Maximum Amplitude:

A - 1.5 mm

Specification No.	Description - Antenna Product Specification		
Customer CURITEL , KOREA	Date Nov. 18, 2004	Rev 1.0	Reference

4.6.4 *Maximum Acceleration:*

2 g

4.6.5 *Crossover Frequency*

18.2 Hz

The crossover frequency is the frequency where maximum acceleration first occurs when the frequency is increased. For higher frequencies the amplitude will decrease so that maximum acceleration is maintained.

4.6.6 *Post Test Requirements*

The antenna satisfies the electrical data (ref. 2.5.1) without permanent mechanical damage (ref. 1.4.2).

4.6.7 *Measuring method*

The antenna is assembled in the test equipment. The vibration is done both in x and z directions, according to Figure 4-2, with a duration of 1 hour in each direction.

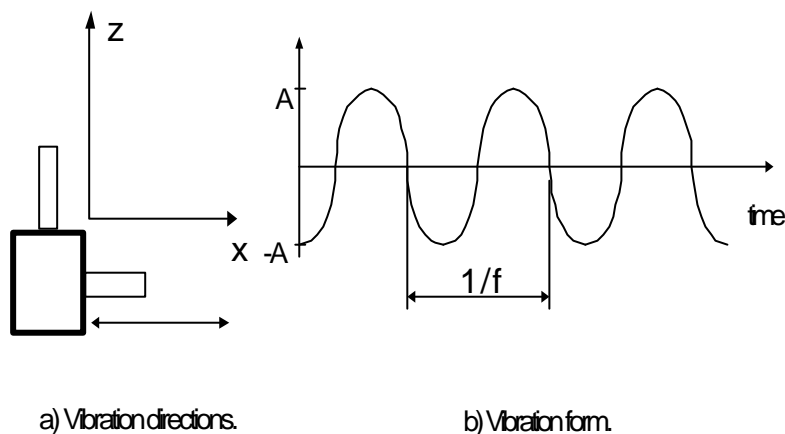

Figure 4-2: Sinusoidal Vibration

4.7 CORROSION (SALT SPRAY TEST)

4.7.1 *Measuring Method*

The antenna is placed in an atmosphere saturated by 5% (by weight) sodium chloride solution for 48 hours at +35°C.

4.7.2 *Post Test Requirements*

Check for the changes in continuity and for corrosion of all electrical contacts in the antenna assembly.

Specification No.	Description - Antenna Product Specification		
Customer CURITEL , KOREA	Date Nov. 18, 2004	Rev 1.0	Reference

5 PACKAGING

Antenna to be individually placed in compartmentalized plastic tray. **TBD** samples antenna packed per tray.

TBD trays packed per carton. Trays are vacuum formed plastic trays (**TBD** mm).

TBD samples antenna packed per carton.

Size of carton is **TBD**

Specification No.	Description - Antenna Product Specification		
Customer CURITEL , KOREA	Date Nov. 18, 2004	Rev 1.0	Reference

6 SPECIFICATIONS DRAWIN

