



# HCT CO., LTD.

Product Compliance Division

TEL : +82 31 639 8518 FAX : +82 31 639 8525

## CERTIFICATE OF COMPLIANCE

### FCC Part 24 & 22 Certification

**Applicant Name:**  
PANTECH&CURITEL COMMUNICATION, INC.  
**Address:**  
110-1, ONGJEONG-RI, TONGJIN-EUP, GIMPO-SI,  
GYOUNGGI-DO, 415-865, KOREA

**Date of Testing:**  
August 13, 2008  
**Test Site/Location:**  
HCT.CO., LTD., San 136-1 Ami-ri, Bubal-eup, Icheon-si,  
Kyungki-do, Korea  
**Test Report No.:** HCT-R08-119  
**HCT FRN:** 0005866421

**FCC ID : PP4RAP**

**APPLICANT : PANTECH&CURITEL COMMUNICATIONS, INC.**

**Application Type:** Certification  
**FCC Classification:** Licensed Portable Transmitter Held to Ear (PCE)  
**FCC Rule Part(s):** §22, §24, §2  
**EUT Type:** Dual-Band CDMA/PCS Phone with Bluetooth  
**Model(s):** CDM8975  
**Tx Frequency:** 824.70 — 848.31 MHz (CDMA)  
1 851.25 — 1 908.75 MHz (PCS CDMA)  
**Rx Frequency:** 869.70 — 893.31 MHz (CDMA)  
1 931.25 — 1 988.75 MHz (PCS CDMA)  
**Max. RF Output Power:** 0.537 W ERP CDMA ( 27.30 dBm) / 0.513 W EIRP PCS CDMA ( 27.10 dBm)  
0.738 W ERP CDMA EVDO ( 28.68 dBm) / 0.650 W EIRP PCS EVDO (28.13 dBm)  
**Emission Designator(s):** 1M27F9W (CDMA), 1M27F9W (PCS CDMA)  
1M26F9W (CDMA EVDO), 1M27F9W (PCS EVDO)

The measurements shown in this report were made in accordance with the procedures specified in §2.947. I assume full responsibility for the accuracy and completeness of these measurements, and for the qualifications of all persons taking them.

HCT.CO., LTD. Certifies that no party to this application has been denied FCC benefits pursuant to section 5301 of the Anti-Drug Abuse Act of 1998,21 U.S. C.853(a)

  
**Report prepared by**  
**: Youn Seok Jung**  
**Test engineer of RF Part**

  
**Approved by**  
**: Sang Jun Lee**  
**Manager of RF Part**

This report only responds to the tested sample and may not be reproduced, except in full, without written approval of the HCT Co., Ltd.

FCC CERTIFICATION REPORT				<a href="http://www.hct.co.kr">www.hct.co.kr</a>
<b>Test Report No.</b> HCT-R08-119	<b>Test Dates:</b> August 13, 2008	<b>EUT Type:</b> Dual-Band CDMA/PCS Phone with Bluetooth	<b>FCC ID:</b> PP4RAP	Page 1 of 30



# Table of Contents

1. GENERAL INFORMATION .....	3
2. INTRODUCTION .....	4
2.1. EUT DESCRIPTION.....	4
2.2. MEASURING INSTRUMENT CALIBRATION.....	4
2.3. TEST FACILITY .....	4
3. DESCRIPTION OF TESTS .....	5
3.1 Effective Radiated Power/Equivalent Isotropic Radiated Power.....	5
3.2 Occupied bandwidth.....	6
3.3 Spurious and Harmonic Emissions at Antenna Terminal.....	6
3.4 Radiated Spurious and Harmonic Emissions .....	7
3.5 Frequency stability / variation of ambient temperature .....	8
4. LIST OF TEST EQUIPMENT .....	9
5. SUMMARY OF TEST RESULTS .....	10
6. SAMPLE CALCULATION .....	11
7. TEST DATA .....	12
7.1 Conducted Output Power .....	12
7.2 Effective Radiated Power Output(CDMA) .....	13
7.3 Equivalent Isotropic Radiated Power (E.I.R.P.) (PCS CDMA) .....	14
7.4 Radiated Spurious Emissions(CDMA Mode).....	15
7.5 Radiated Spurious Emissions(PCS CDMA Mode) .....	16
7.8 Frequency stability / variation of ambient temperature .....	17
7.8.1 FREQUENCY STABILITY (CDMA).....	17
7.8.2 FREQUENCY STABILITY (PCS CDMA).....	18
8. TEST PLOTS.....	19



# MEASUREMENT REPORT

## 1. GENERAL INFORMATION

**Applicant Name:** PANTECH&CURITEL COMMUNICATION, INC.

**Address:** 110-1, ONGJEONG-RI, TONGJIN-EUP, GIMPO-SI,  
GYOUNGGI-DO, 415-865, KOREA

**Contact:** TEL : +82-2-2030-1220 / FAX : +82-2-2030-2520  
E-mail : kpson@pantech.com

**FCC ID:** PP4RAP

**Application Type:** Certification

**FCC Classification:** Licensed Portable Transmitter Held to Ear (PCE)

**FCC Rule Part(s):** §22, §24, §2

**EUT Type:** Dual-Band CDMA/PCS Phone with Bluetooth

**Model(s):** CDM8975

**Tx Frequency:** 824.70 — 848.31 MHz (CDMA)  
1 851.25 — 1 908.75 MHz (PCS CDMA)

**Rx Frequency:** 869.70 — 893.31 MHz (CDMA)  
1 931.25 — 1 988.75 MHz (PCS CDMA)

**Max. RF Output Power:** 0.537 W ERP CDMA ( 27.30 dBm) / 0.513 W EIRP PCS CDMA ( 27.10 dBm)  
0.738 W ERP CDMA EVDO ( 28.68 dBm)  
0.650 W EIRP PCS EVDO (28.13 dBm)

**Emission Designator(s):** 1M27F9W (CDMA), 1M27F9W (PCS CDMA)  
1M26F9W (CDMA EVDO), 1M27F9W (PCS EVDO)

**Antenna Specification** Manufacturer: ace antenna  
Antenna type: Built in  
Peak Gain: -2.0 dBi

**Date(s) of Tests:** August 13, 2008

**Place of Tests:** HCT.CO., LTD.  
San 136-1 Ami-ri, Bubal-eup, Icheon-si,

**Report Serial No** HCT-R08-119

FCC CERTIFICATION REPORT				<a href="http://www.hct.co.kr">www.hct.co.kr</a>
Test Report No. HCT-R08-119	Test Dates: August 13, 2008	EUT Type: Dual-Band CDMA/PCS Phone with Bluetooth	FCC ID: PP4RAP	Page 3 of 30



## 2. INTRODUCTION

### 2.1. EUT DESCRIPTION

The Pantech CDM8975 Dual-Band CDMA/PCS Phone with Bluetooth consists of Cellular CDMA, PCS CDMA and 1xEvDO Rev.A

### 2.2. MEASURING INSTRUMENT CALIBRATION

The measuring equipment, which was utilized in performing the tests documented herein, has been calibrated in accordance with the manufacturer's recommendations for utilizing calibration equipment, which is traceable to recognized national standards.

### 2.3. TEST FACILITY

The open area test site and conducted measurement facility used to collect the radiated data are located at the 254-1, Maekok-Ri, Hobup-Myun, Ichon-Si, Kyoungki-Do, 467-701, KOREA. The site is constructed in conformance with the requirements of ANSI C63.4 and CISPR Publication 22. Detailed description of test facility was submitted to the Commission and accepted dated July 6, 2006(Registration Number: 90661)

FCC CERTIFICATION REPORT				<a href="http://www.hct.co.kr">www.hct.co.kr</a>
Test Report No. HCT-R08-119	Test Dates: August 13, 2008	EUT Type: Dual-Band CDMA/PCS Phone with Bluetooth	FCC ID: PP4RAP	Page 4 of 30

### 3. DESCRIPTION OF TESTS

#### 3.1 Effective Radiated Power/Equivalent Isotropic Radiated Power

##### Test Set-up

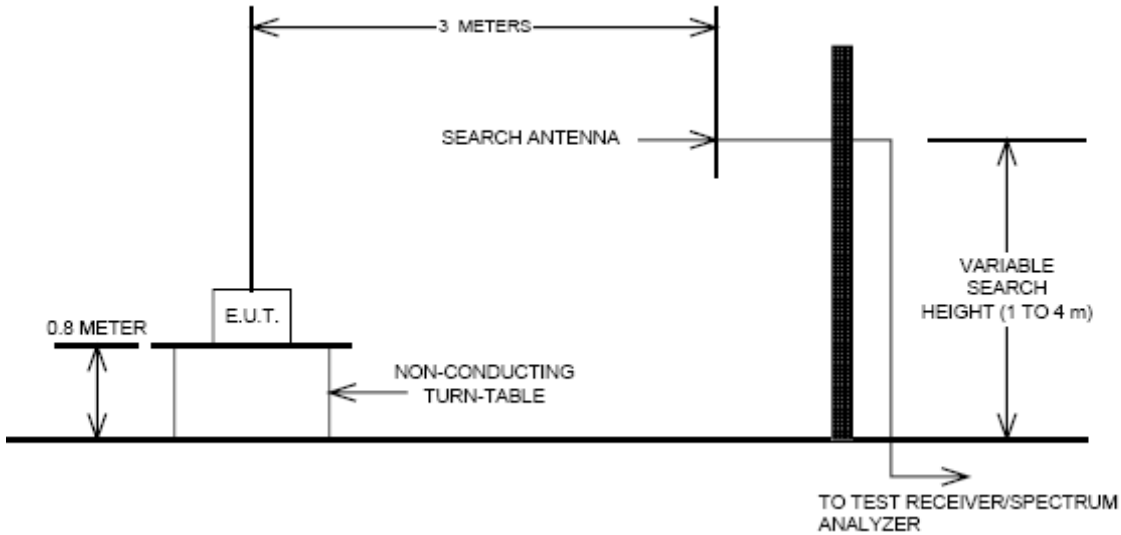

##### Test Procedure

Radiated emission measurements were performed at an open Site.

The equipment under test is placed on a wooden turntable 3-meters from the receive antenna.

A wooden turntable was rotated 360° and the receiving antenna scanned from 1-4m in order to capture the maximum emission. A half wave dipole was substituted in place of the EUT. This dipole antenna was driven by a signal generator and the previously recorded signal was duplicated.

The maximum EIRP was calculated by adding the forward power to the calibrated source plus its appropriate gain value. These steps were carried out with the receiving antenna in both vertical and horizontal polarization. For readings above 1GHz, the above procedure is repeated using horn antennas and the difference between the gain of the horn and an isotropic antenna are taken into consideration.

### 3.2 Occupied bandwidth.

#### Test set-up

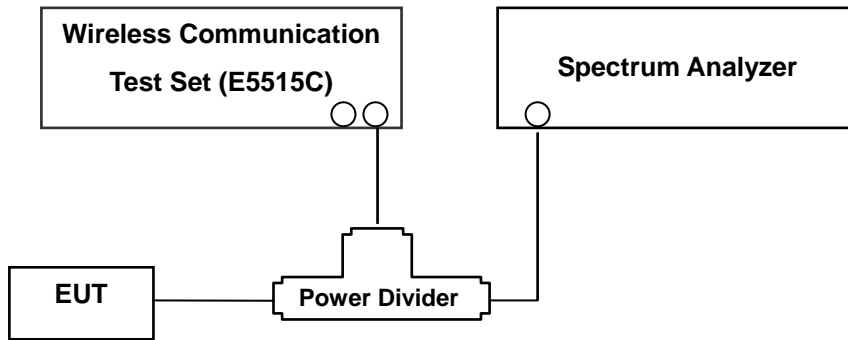

(Configuration of conducted Emission measurement)  
Test Procedure

The EUT was setup to maximum output power at its lowest channel. The occupied bandwidth was measured using a spectrum analyzer. The measurements are repeated for the highest and a middle channel. The EUT's occupied bandwidth is measured as the width of the signal between two points, one below the carrier center frequency and one above the carrier frequency, outside of which all emissions are attenuated at least 26 dB below the transmitter power. Plots of the EUT's occupied bandwidth are shown herein.

### 3.3 Spurious and Harmonic Emissions at Antenna Terminal.

#### Test Procedure

The level of the carrier and the various conducted spurious and harmonic frequencies is measured by means of a calibrated spectrum analyzer.

The EUT was setup to maximum output power at its lowest channel. The Resolution BW of the analyzer is set to 1 % of the emission bandwidth to show compliance with the – 13 dBm limit, in the 1 MHz bands immediately outside and adjacent to the edge of the frequency block. The 1 MHz RBW was used to scan from 30 MHz to 10 GHz. (PCS CDMA Mode: 30 MHz to 20 GHz). A display line was placed at – 13 dBm to show compliance. The high, lowest and a middle channel were tested for out of band measurements.

### 3.4 Radiated Spurious and Harmonic Emissions

#### Test Set-up

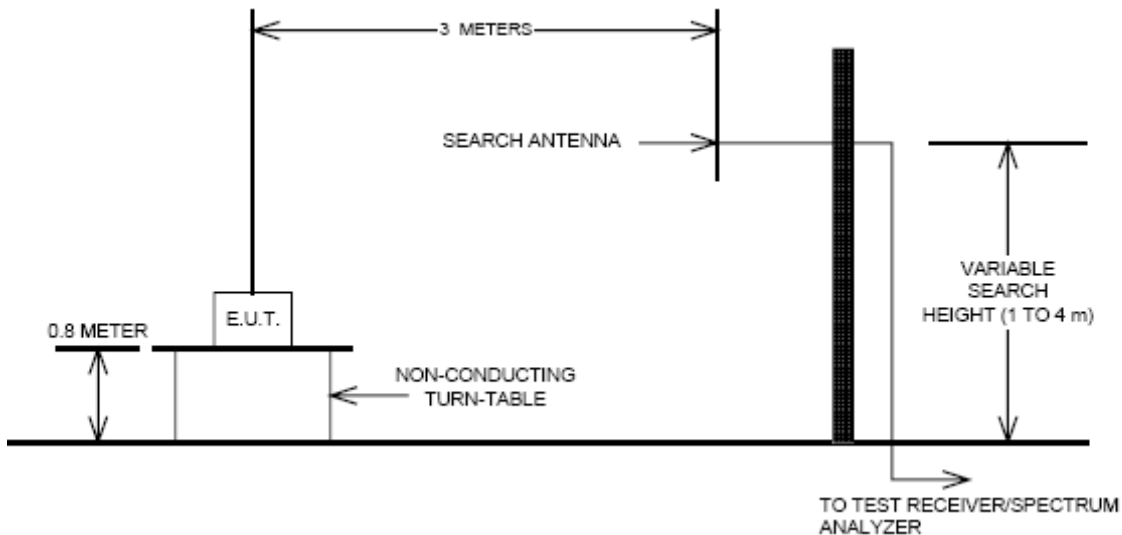

The measurement facilities used for this test have been documented in previous filings with the commission pursuant to section § 2.948. The open field test site is situated in open field with ground screen whose site attenuation characteristics meet ANSI C63.4 –2003. A mast capable of lifting the receiving antenna from a height of one to four meters is used together with a rotatable wooden platform mounted at three from the antenna mast.

- 1) The unit mounted on a wooden table 1.5 m × 1.0 m × 0.80 m is 0.8 meter above test site ground level.
- 2) During the emission test, the turntable is rotated and the EUT is manipulated to find the configuration resulting in maximum emission under normal condition of installation and operation.
- 3) The antenna height and polarization are also varied from 1 to 4 meters until the maximum signal is found.
- 4) The spectrum shall be scanned up to the 10<sup>th</sup> harmonic of the fundamental frequency.

#### Test Procedure

The equipment under test is placed on a wooden turntable 3-meters from the receive antenna.

A wooden turntable was rotated 360° and the receiving antenna scanned from 1-4m in order to capture the maximum emission. A half wave dipole was substituted in place of the EUT. This dipole antenna was driven by a signal generator and the previously recorded signal was duplicated.

The maximum EIRP was calculated by adding the forward power to the calibrated source plus its appropriate gain value. These steps were carried out with the receiving antenna in both vertical and horizontal polarization. For readings above 1GHz, the above procedure is repeated using horn antennas and the difference between the gain of the horn and an isotropic antenna are taken into consideration.

### 3.5 Frequency stability / variation of ambient temperature

#### Test Set-up

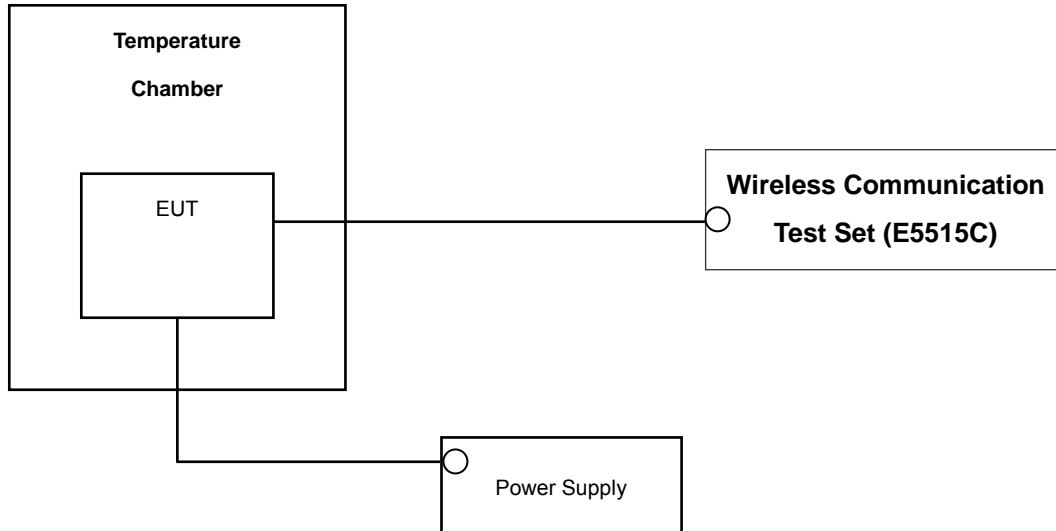

\* Nominal Operating Voltage

#### Test Procedure

The frequency stability of the transmitter is measured by:

- a.) **Temperature:** The temperature is varied from - 30 °C to + 50 °C using an environmental chamber.
- b.) **Primary Supply Voltage:** The primary supply voltage is varied from battery end point to 115 % of the voltage normally at the input to the device or at the power supply terminals if cables are not normally supplied.

Specification — the frequency stability shall be sufficient to ensure that the fundamental emission stays within the authorized frequency block. The frequency stability of the transmitter shall be maintained within  $\pm 0.00025\%$  ( $\pm 2.5$  ppm) of the center frequency.

#### Time Period and Procedure:

The carrier frequency of the transmitter is measured at room temperature (20°C to provide a reference).

1. The equipment is turned on in a “standby” condition for one minute before applying power to the transmitter. Measurement of the carrier frequency of the transmitter is made within one minute after applying power to the transmitter.
2. Frequency measurements are made at 10°C intervals ranging from -30°C to +50°C. A period of at least one half-hour is provided to allow stabilization of the equipment at each temperature level.

**NOTE: The EUT is tested down to the battery endpoint.**





## 4. LIST OF TEST EQUIPMENT

Manufacture	Model/ Equipment	Serial Number	Calibration Interval	Calibration Due
R&S	ESI40/ Spectrum Analyzer	831564/003	Annual	11/06/2008
Agilent	E4419B/ Power Meter	MY41291386	Annual	11/05/2008
Agilent	8481A/ Power Sensor	MY41090870	Annual	11/05/2008
Agilent	8960 (E5515C)/ Base Station	GB444400269	Annual	02/11/2009
Tescom	TC-3000/ Bluetooth Simulator	3000A4900112	Annual	01/11/2009
MITEQ	AMF-60-0010 1800-35-20P / AMP	1200937	Annual	01/15/2009
Wainwright	WHK1.2/15G-10EF/H.P.F	2	Annual	06/28/2009
Wainwright	WHK3.3/18G-10EF/H.P.F	1	Annual	06/28/2009
Agilent	778D/ Dual Directional Coupler	16072	Annual	11/09/2008
Agilent	1506A/ Power Divider	99441	Annual	11/10/2008
Digital	EP-3010/ Power Supply	3110117	Annual	12/29/2008
Schwarzbeck	UHAP/ Dipole Antenna	630	Annual	11/13/2008
Schwarzbeck	UHAP/ Dipole Antenna	605	Annual	11/13/2008
R&S	HFH2-Z2/ Loop Antenna	881056/070	Annual	12/11/2008
Korea Engineering	KR-1005L / Chamber	KRAB07063-2CH	Annual	01/05/2009
Schwarzbeck	VULB9160/ TRILOG Antenna	3150	Biennial	04/20/2009
Schwarzbeck	VULB9160/ TRILOG Antenna	3125	Biennial	05/16/2009
Schwarzbeck	BBHA 9120D/ Horn Antenna	147	Biennial	03/26/2010
Schwarzbeck	BBHA 9120D/ Horn Antenna	1201	Biennial	05/02/2009
Agilent	E4440A/Spectrum Analyzer	US45303008	Annual	01/08/2009



## 5. SUMMARY OF TEST RESULTS

FCC Part Section(s)	Test Description	Test Limit	Test Condition	Test Result
2.1049, 22.917(a), 24.238(a)	Occupied Bandwidth	N/A	CONDUCTED	PASS
2.1051, 22.917(a), 24.238(a)	Band Edge / Spurious and Harmonic Emissions at Antenna Terminal.	< 43 + log <sub>10</sub> (P[Watts]) at Band Edge and for all out-of-band emissions		PASS
2.1046	Conducted Output Power	N/A		PASS
2.1055, 22.355, 24.235	Frequency stability / variation of ambient temperature	< 2.5 ppm		PASS
22.913(a)(2) 24.232(c)	Effective Radiated Power	< 7 Watts max. ERP	RADIATED	PASS
	Equivalent Isotropic Radiated Power	< 2 Watts max. EIRP		PASS
2.1053, 22.917(a), 24.238(a)	Radiated Spurious and Harmonic Emissions	< 43 + log <sub>10</sub> (P[Watts]) for all out-of band emissions		PASS



## 6. SAMPLE CALCULATION

### A. ERP Sample Calculation

Mode	Ch./ Freq.		Measured Level(dBm)	Substitute LEVEL(dBm)	Ant. Gain	C.L	Pol.	ERP	
	channel	Freq.(MHz)						W	dBm
CDMA	384	836.52	-10.96	24.81	2.50	1.19	H	0.41	26.12

**ERP = SubstituteLEVEL(dBm) + Ant. Gain – CL(Cable Loss)**

- 1) The EUT mounted on a wooden tripod is 0.8 meter above test site ground level.
- 2) During the test , the turn table is rotated and the antenna height is also varied from 1 to 4 meters until the maximum signal is found.
- 3) Record the field strength meter's level.
- 4) Replace the EUT with dipole/Horn antenna that is connected to a calibrated signal generator.
- 5) Increase the signal generator output till the field strength meter's level is equal to the item (3).
- 6) The signal generator output level with Ant. Gain and cable loss are the rating of effective radiated power (ERP).

### B. Emission Designator

#### CDMA Emission Designator

**Emission Designator = 1M27F9W**

CDMA BW = 1.27 MHz (Measured at the 99% power bandwidth)

F = Frequency Modulation

9 = Composite Digital Info

W = Combination (Audio/Data)



## 7. TEST DATA

### 7.1 Conducted Output Power

A base station simulator was used to establish communication with The Dual-Band CDMA/PCS Phone with Bluetooth. The base station simulator parameters were set to produce the maximum power from the EUT. This device was tested under all configurations and the highest power is reported. Conducted Output Powers of EUT are reported below.

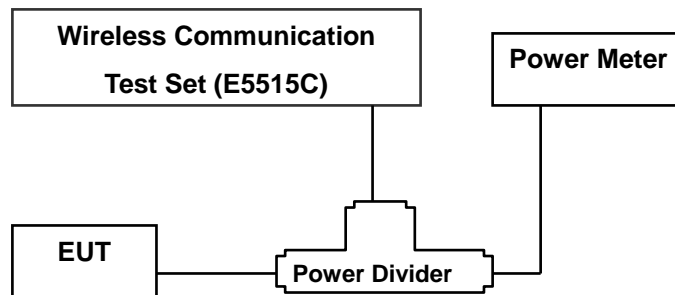

Band	Channel	SO2	SO2	SO55	SO55	TDSO	1xEvDO	1xEvDO	1xEvDO	1xEvDO
		RC1/1 (dBm)	RC3/3 (dBm)	RC1/1 (dBm)	RC3/3 (dBm)	SO32 (dBm)	Rev.0 (FTAP) (dBm)	Rev.0 (RTAP) (dBm)	Rev.A (FETAP) (dBm)	Rev.A (RETAP) (dBm)
CDMA	1013	25.03	24.96	25.03	24.95	24.98	25.06	25.15	25.21	25.15
	384	24.91	24.84	24.89	24.84	24.87	25.11	25.07	25.06	25.02
	777	24.75	24.70	24.75	24.70	24.72	24.99	24.93	24.87	24.83
PCS	25	24.73	24.60	24.64	24.56	24.59	24.67	24.59	24.65	24.55
	600	24.78	24.64	24.64	24.63	24.66	24.91	24.63	24.85	24.98
	1175	24.85	24.71	24.83	24.80	24.84	24.80	24.78	24.78	24.71

(Maximum Conducted Output Powers)



## 7.2 Effective Radiated Power Output(CDMA)

### (CDMA Mode)

Mode	Ch./ Freq.		Measured Level(dBm)	Substitute LEVEL (dBm)	Ant. Gain	C.L	Pol.	ERP	
	channel	Freq.(MHz)						W	dBm
CDMA	1013	824.70	-10.56	35.27	-8.31	1.17	V	0.38	25.79
	384	836.52	-9.78	36.71	-8.22	1.19	V	0.54	27.30
	777	848.31	-10.57	36.56	-8.13	1.20	V	0.53	27.23
EVDO	384	836.52	-8.40	38.09	-8.22	1.19	V	0.74	28.68

Note: Standard batteries are the only options for this phone

#### NOTES:

Effective Radiated Power Output Measurements by Substitution Method  
according to ANSI/TIA/EIA-603-C-2004, Aug. 17, 2004:

The EUT was placed on a wooden turn table 3-meters from the receive antenna. The receive antenna height and turntable rotation was adjusted for the highest reading on the receive spectrum analyzer. For CDMA signals, a peak detector is used, with RBW = VBW = 3 MHz. For WCDMA signals, a peak detector is used, with RBW = VBW = 5MHz. For AMPS, GSM, and NADC TDMA signals, a peak detector is used, with RBW = VBW = 1 MHz. A half-wave dipole was substituted in place of the EUT. This dipole antenna was driven by a signal generator and the level of the signal generator was adjusted to obtain the same receive spectrum analyzer reading. The conducted power at the terminals of the dipole is measured. The ERP is recorded.

This device was tested under all configurations and the highest power is reported.



### 7.3 Equivalent Isotropic Radiated Power (E.I.R.P.) (PCS CDMA)

**(PCS CDMA Mode)**

Mode	Ch./ Freq.		Measured	Substitute	Ant. Gain	C.L	Pol.	EIRP	
	channel	Freq.(MHz)	Level(dBm)	LEVEL (dBm)				W	dBm
PCS	25	1,851.25	-12.64	18.97	10.05	1.91	V	0.51	27.10
	600	1,880.00	-13.64	18.18	10.05	1.95	V	0.42	26.28
	1175	1,908.75	-13.11	18.79	10.06	1.97	V	0.49	26.88
EVDO	25	1,851.25	-11.61	20.00	10.05	1.91	V	0.65	28.13

Note: Standard batteries are the only options for this phone

**NOTES:**

Equivalent Isotropic Radiated Power Measurements by Substitution Method according to ANSI/TIA/EIA-603-C-2004, Aug. 17, 2004:

The EUT was placed on a wooden turn table 3-meters from the receive antenna. The receive antenna height and turntable rotation was adjusted for the highest reading on the receive spectrum analyzer. For CDMA signals, a peak detector is used, with RBW = VBW = 3 MHz. For WCDMA signals, a peak detector is used, with RBW = VBW = 5MHz. For AMPS, GSM, and NADC TDMA signals, a peak detector is used, with RBW = VBW = 1 MHz. A Horn antenna was substituted in place of the EUT. This Horn antenna was driven by a signal generator and the level of the signal generator was adjusted to obtain the same receive spectrum analyzer reading. The conducted power at the terminals of the Horn antenna is measured. The difference between the gain of the horn and an isotropic antenna is taken into consideration and the EIRP is recorded.

This device was tested under all configurations and the highest power is reported.



## 7.4 Radiated Spurious Emissions(CDMA Mode)

- MEASURED OUTPUT POWER: 27.30 dBm =0.537 W
- MODULATION SIGNAL: CDMA
- DISTANCE: 3 meters
- LIMIT: - (43 + 10 log<sub>10</sub> (W)) = -40.30 dBc

Ch.	Freq.(MHz)	Measured Level [dBm]	Ant. Gain	Substitute Level [dBm]	C.L	Pol.	ERP (dBm)	dBc
1013	1,649.40	-37.30	7.09	-47.83	1.73	H	-42.47	-69.77
	2,474.10	-44.80	8.12	-51.91	2.28	H	-46.07	-73.37
	3,298.80	-55.78	9.72	-63.36	2.57	H	-56.21	-83.51
384	1,673.04	-32.58	7.23	-43.34	1.79	H	-37.90	-65.20
	2,509.56	-46.81	8.14	-53.94	2.33	H	-48.13	-75.43
	3,346.08	-55.49	9.99	-63.52	2.66	H	-56.19	-83.49
777	1,696.62	-35.18	7.41	-45.79	1.83	H	-40.21	-67.51
	2,544.93	-47.86	8.21	-55.14	2.34	H	-49.27	-76.57
	3,393.24	-55.10	9.91	-62.73	2.85	H	-55.67	-82.97

**NOTES:** Radiated Spurious Emission Measurements at 3 meters by Substitution Method  
according to ANSI/TIA/EIA-603-C-2004, Aug. 17, 2004:



## 7.5 Radiated Spurious Emissions(PCS CDMA Mode)

- MEASURED OUTPUT POWER: 27.10 dBm = 0.513 W
- MODULATION SIGNAL: PCS CDMA
- DISTANCE: 3 meters
- LIMIT: - (43 + 10 log<sub>10</sub>(W)) = - 40.10 dBc

Ch.	Freq.(MHz)	Measured Level [dBm]	Ant. Gain	Substitute Level [dBm]	C.L	Pol.	ERP (dBm)	dBc
25	3,702.50	-40.49	10.31	-46.76	2.73	H	-39.18	-66.28
	5,553.75	-47.95	10.55	-49.53	3.60	H	-42.58	-69.68
	7,405.00	-45.02	9.21	-36.14	3.88	H	-30.81	-57.91
600	3,760.00	-36.60	10.32	-42.57	2.73	H	-34.98	-62.08
	5,640.00	-50.79	10.60	-52.44	3.60	H	-45.44	-72.54
	7,520.00	-44.82	9.18	-35.72	3.88	H	-30.42	-57.52
1175	3,817.50	-38.36	10.34	-44.24	2.73	H	-36.63	-63.73
	5,726.25	-50.13	10.65	-51.44	3.60	H	-44.39	-71.49
	7,635.00	-45.41	9.15	-36.08	3.88	H	-30.81	-57.91

**NOTES:** Radiated Spurious Emission Measurements at 3 meters by Substitution Method  
according to ANSI/TIA/EIA-603-C-2004, Aug. 17, 2004:





## 7.8 Frequency stability / variation of ambient temperature

### 7.8.1 FREQUENCY STABILITY (CDMA)

OPERATING FREQUENCY: 836,520,000 Hz  
 CHANNEL: 384  
 REFERENCE VOLTAGE: 3.7 VDC  
 DEVIATION LIM IT: ± 0.000 25 % or 2.5 ppm

Voltage (%)	Power (VDC)	Temp. (°C)	Frequency (Hz)	Frequency Error (Hz)	Deviation (%)	ppm
100%	3.700	+20(Ref)	836 520 002	2.20	0.000 000	0.003
100%		-30	836 520 003	3.19	0.000 000	0.004
100%		-20	836 520 004	3.55	0.000 000	0.004
100%		-10	836 520 003	3.47	0.000 000	0.004
100%		0	836 519 997	-3.11	0.000 000	-0.004
100%		+10	836 520 003	2.65	0.000 000	0.003
100%		+20	836 520 004	4.05	0.000 000	0.005
100%		+30	836 520 005	5.11	0.000 001	0.006
100%		+40	836 520 005	4.88	0.000 001	0.006
100%		+50	836 520 003	2.82	0.000 000	0.003
115%	4.255	+20	836 520 002	2.05	0.000 000	0.002
Batt. Endpoint	3.400	+20	836 520 003	3.45	0.000 000	0.004

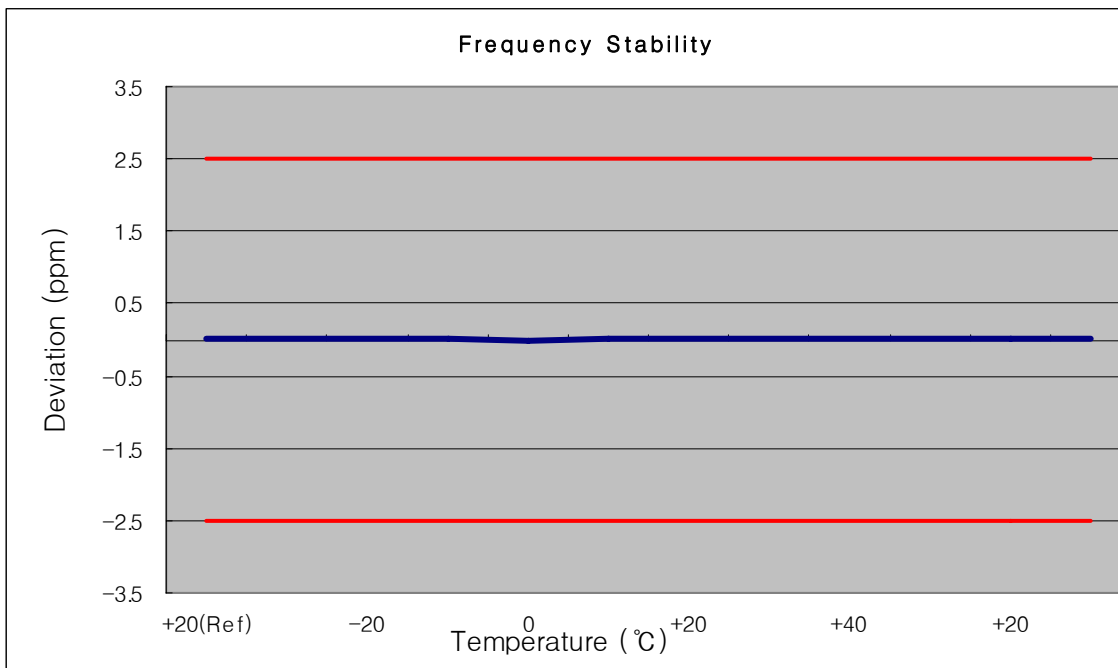



**7.8.2 FREQUENCY STABILITY (PCS CDMA)**

OPERATING FREQUENCY: 1880,000,000 Hz  
 CHANNEL: 600  
 REFERENCE VOLTAGE: 3.7 VDC  
 DEVIATION LIM IT: ± 0.000 25 % or 2.5 ppm

Voltage (%)	Power (VDC)	Temp. (°C)	Frequency (Hz)	Frequency Error (Hz)	Deviation (%)	ppm
100%	3.700	+20(Ref)	836 600 009	8.70	0.000 010	0.010
100%		-30	836 600 012	11.82	0.000 014	0.014
100%		-20	836 600 009	8.86	0.000 011	0.011
100%		-10	836 600 009	8.51	0.000 010	0.010
100%		0	836 600 006	6.25	0.000 007	0.007
100%		+10	836 600 006	5.94	0.000 007	0.007
100%		+20	836 600 007	7.49	0.000 009	0.009
100%		+30	836 600 003	3.44	0.000 004	0.004
100%		+40	836 600 004	3.65	0.000 004	0.004
100%		+50	836 600 005	4.86	0.000 006	0.006
115%	4.255	+20	836 600 009	9.31	0.000 011	0.011
Batt. Endpoint	3.400	+20	836 600 007	6.93	0.000 008	0.008

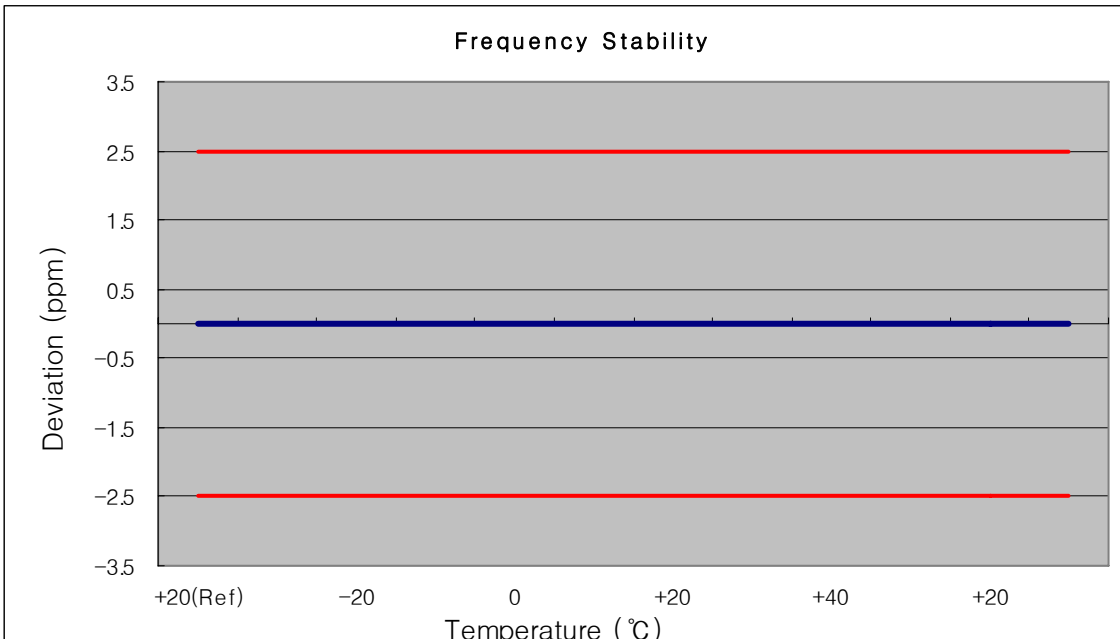



## 8. TEST PLOTS

FCC CERTIFICATION REPORT				<a href="http://www.hct.co.kr">www.hct.co.kr</a>
Test Report No. HCT-R08-119	Test Dates: August 13, 2008	EUT Type: Dual-Band CDMA/PCS Phone with Bluetooth	FCC ID: PP4RAP	Page 19 of 30

■ CDMA MODE (1013 CH.) Occupied Bandwidth

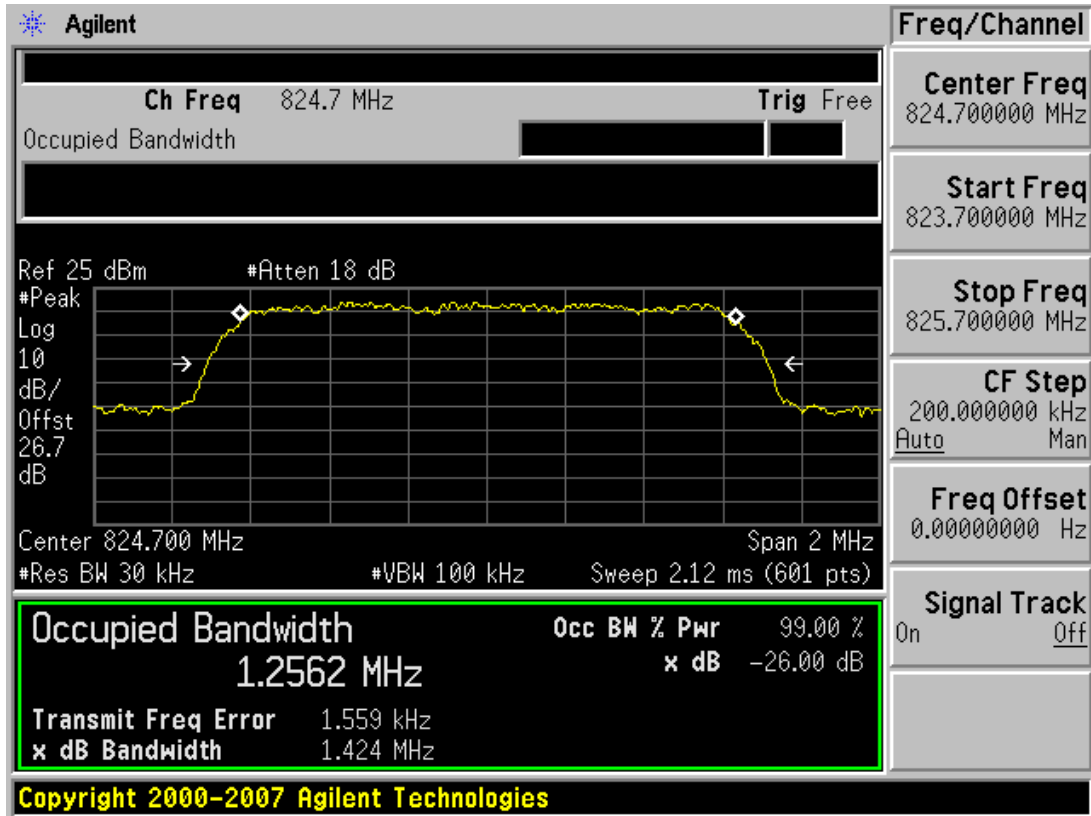

■ CDMA MODE (384 CH.) Occupied Bandwidth

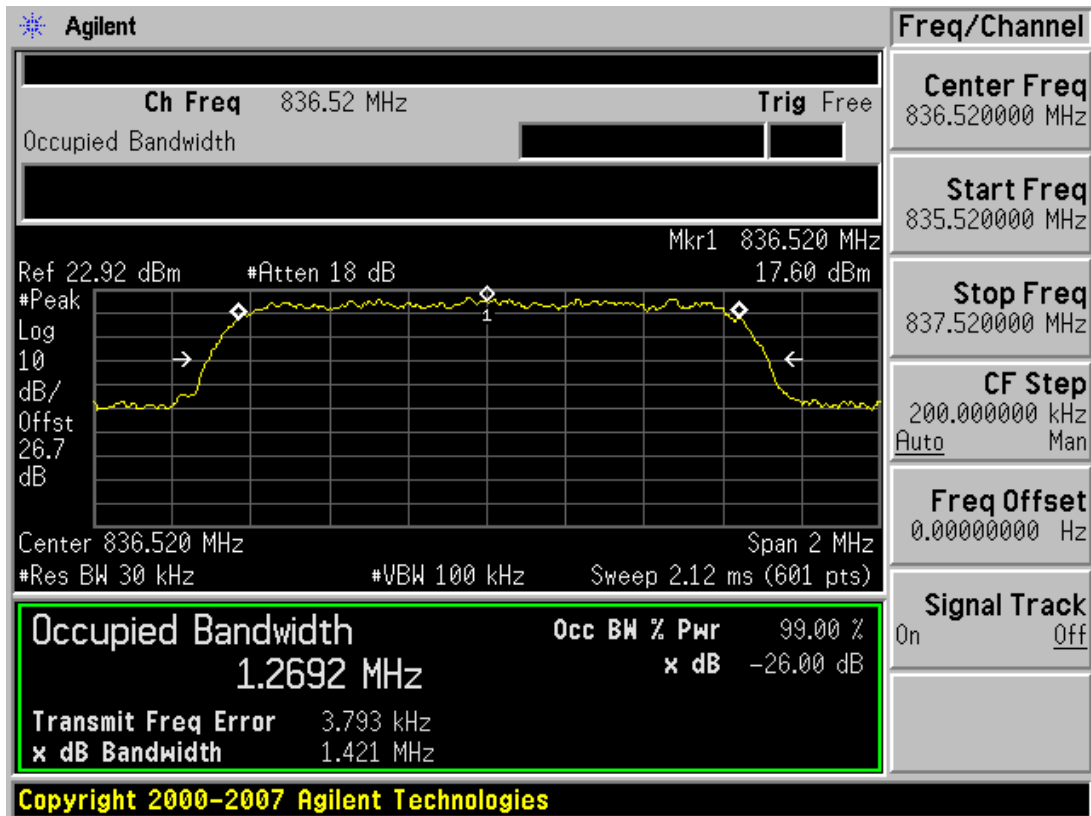



■ CDMA MODE (777 CH.) Occupied Bandwidth

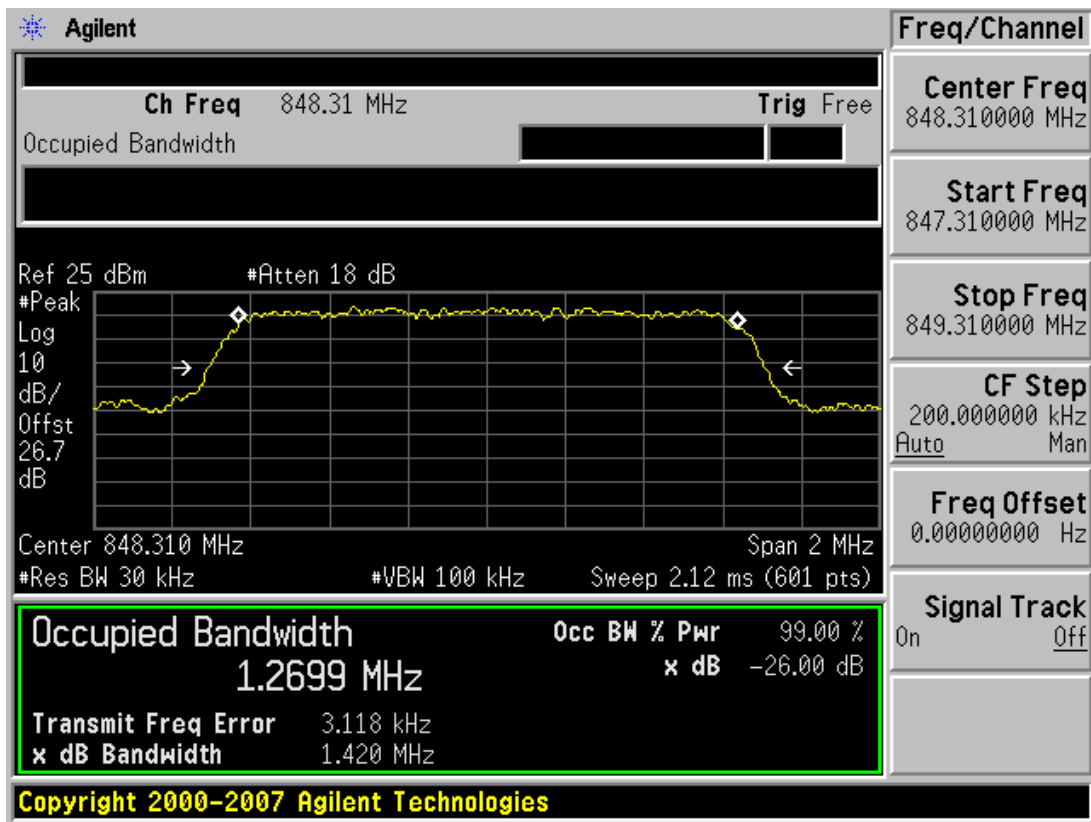

■ CDMA EVDO (777 CH.) Occupied Bandwidth

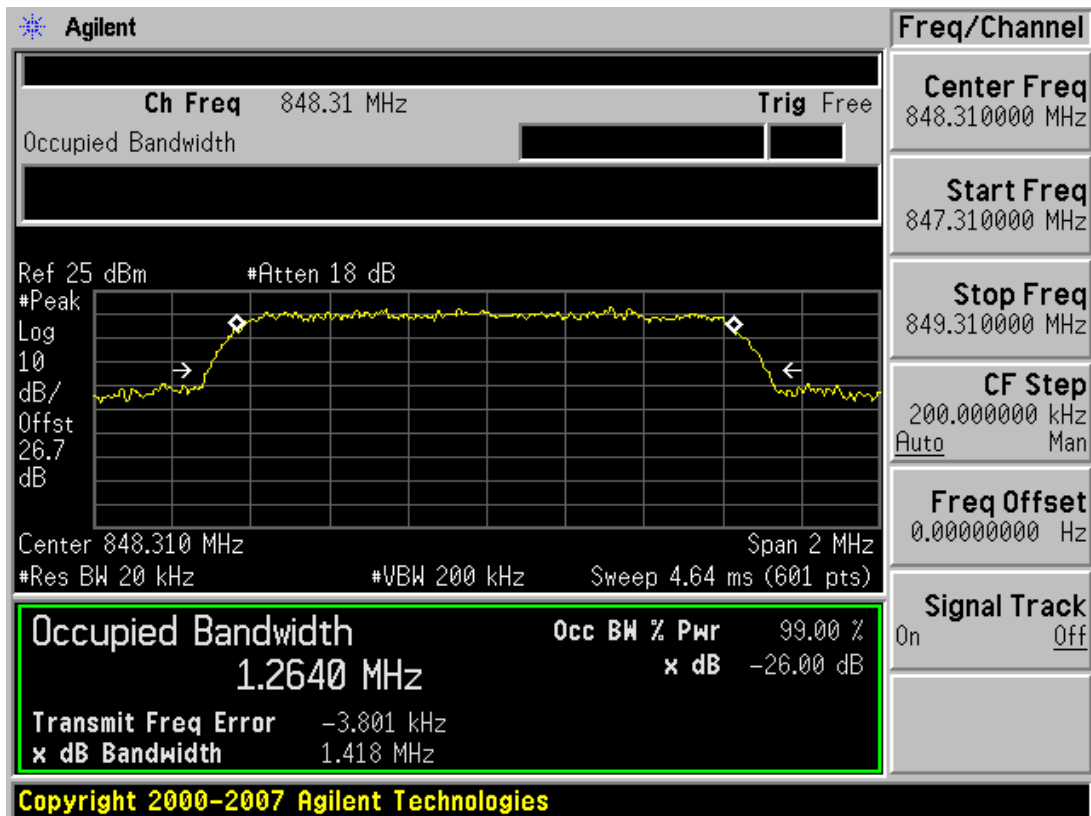

FCC CERTIFICATION REPORT

[www.hct.co.kr](http://www.hct.co.kr)

Test Report No. HCT-R08-119	Test Dates: August 13, 2008	EUT Type: Dual-Band CDMA/PCS Phone with Bluetooth	FCC ID: PP4RAP	Page 21 of 30
--------------------------------	--------------------------------	--	-------------------	---------------



■ PCS CDMA MODE (25 CH.) Occupied Bandwidth

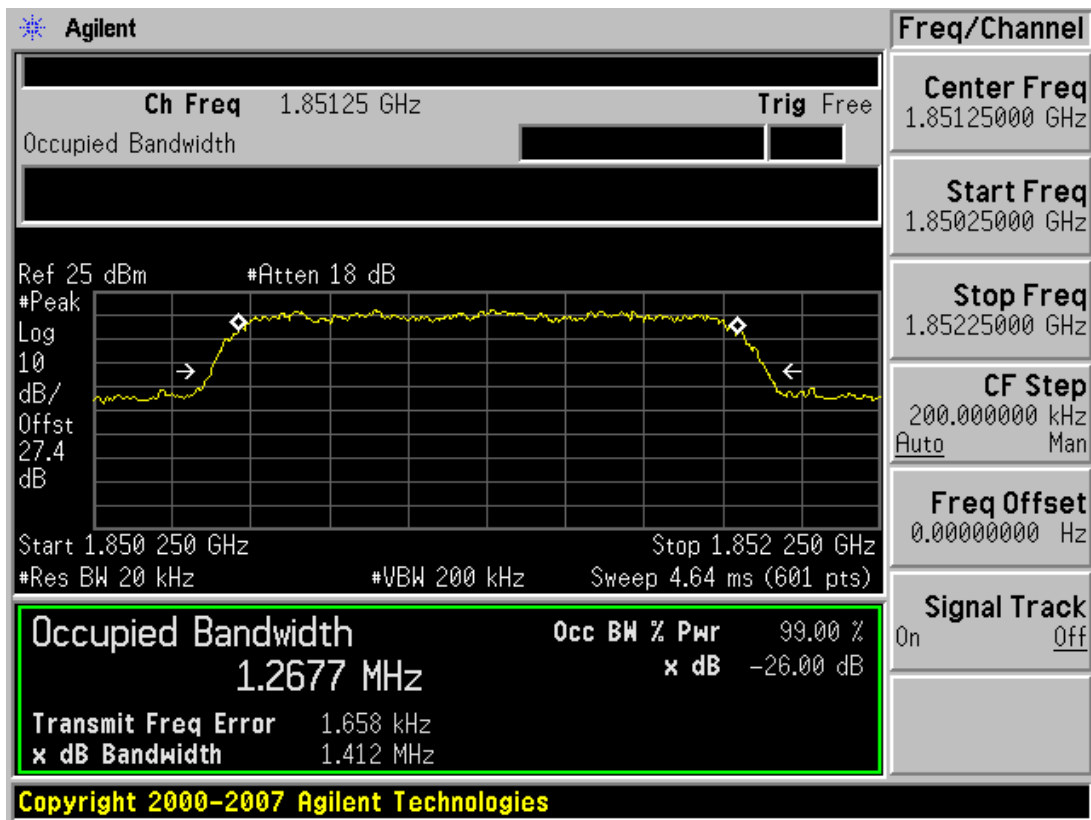

■ PCS CDMA MODE (600 CH.) Occupied Bandwidth

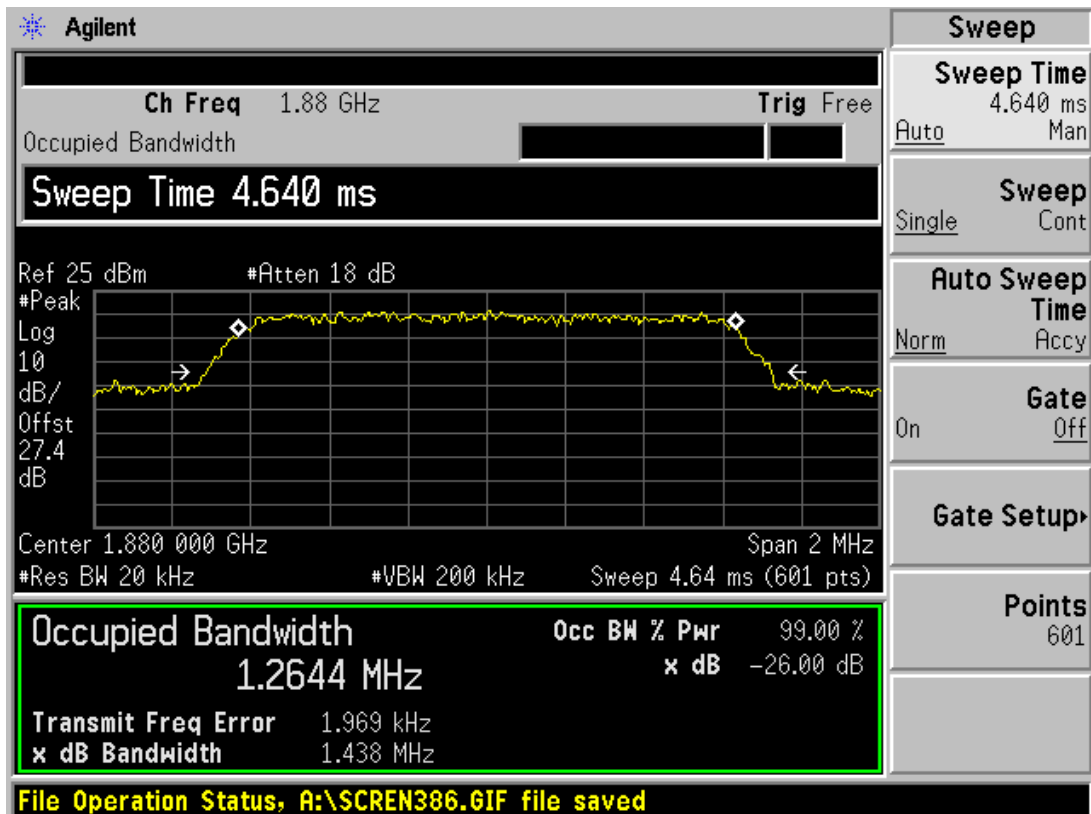

FCC CERTIFICATION REPORT				<a href="http://www.hct.co.kr">www.hct.co.kr</a>
Test Report No. HCT-R08-119	Test Dates: August 13, 2008	EUT Type: Dual-Band CDMA/PCS Phone with Bluetooth	FCC ID: PP4RAP	Page 2 2 of 30

■ PCS CDMA MODE (1175 CH.) Occupied Bandwidth

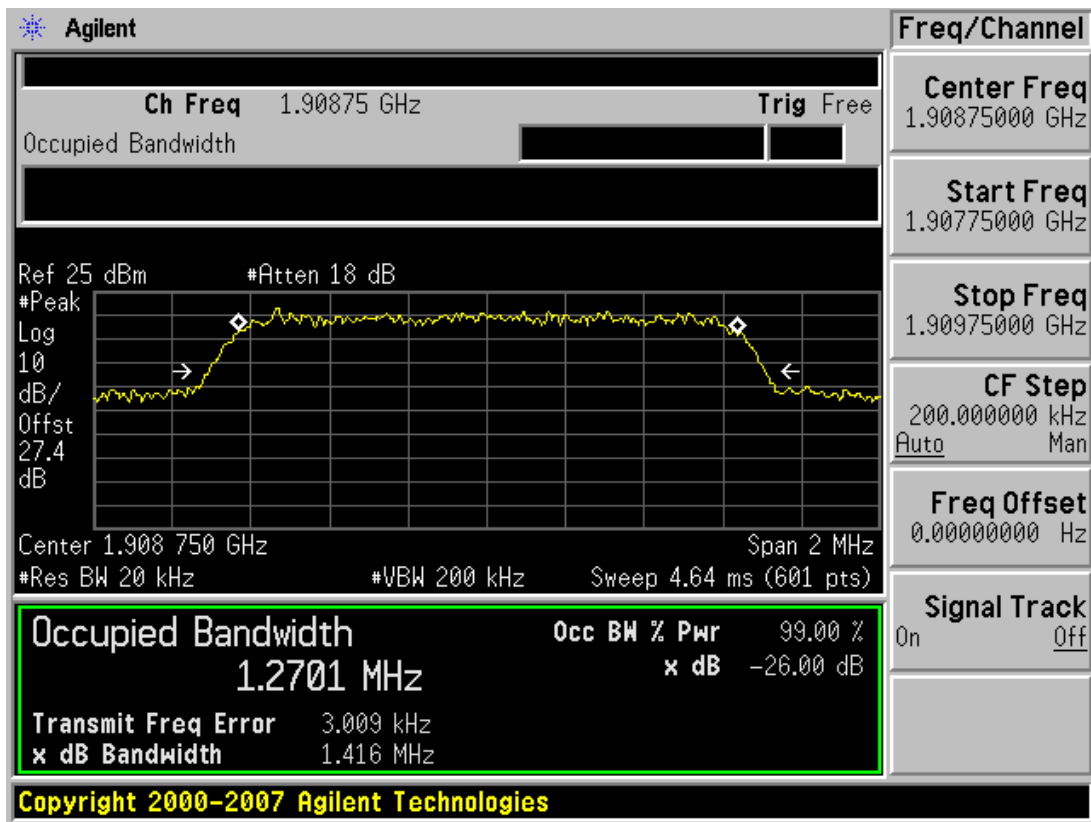

■ PCS EVDO MODE (1175 CH.) Occupied Bandwidth

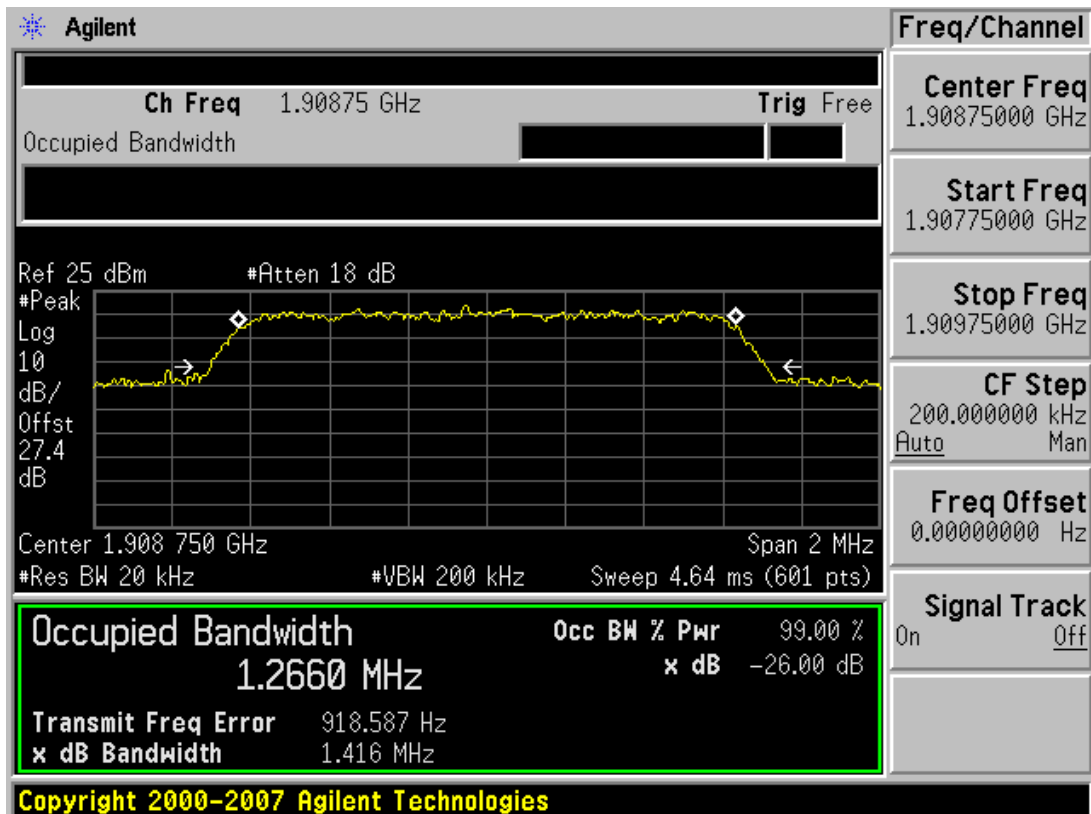

FCC CERTIFICATION REPORT

Test Report No. HCT-R08-119	Test Dates: August 13, 2008	EUT Type: Dual-Band CDMA/PCS Phone with Bluetooth	FCC ID: PP4RAP	Page 23 of 30
--------------------------------	--------------------------------	--	-------------------	---------------



■ CDMA MODE (1013 CH.) Block Edge

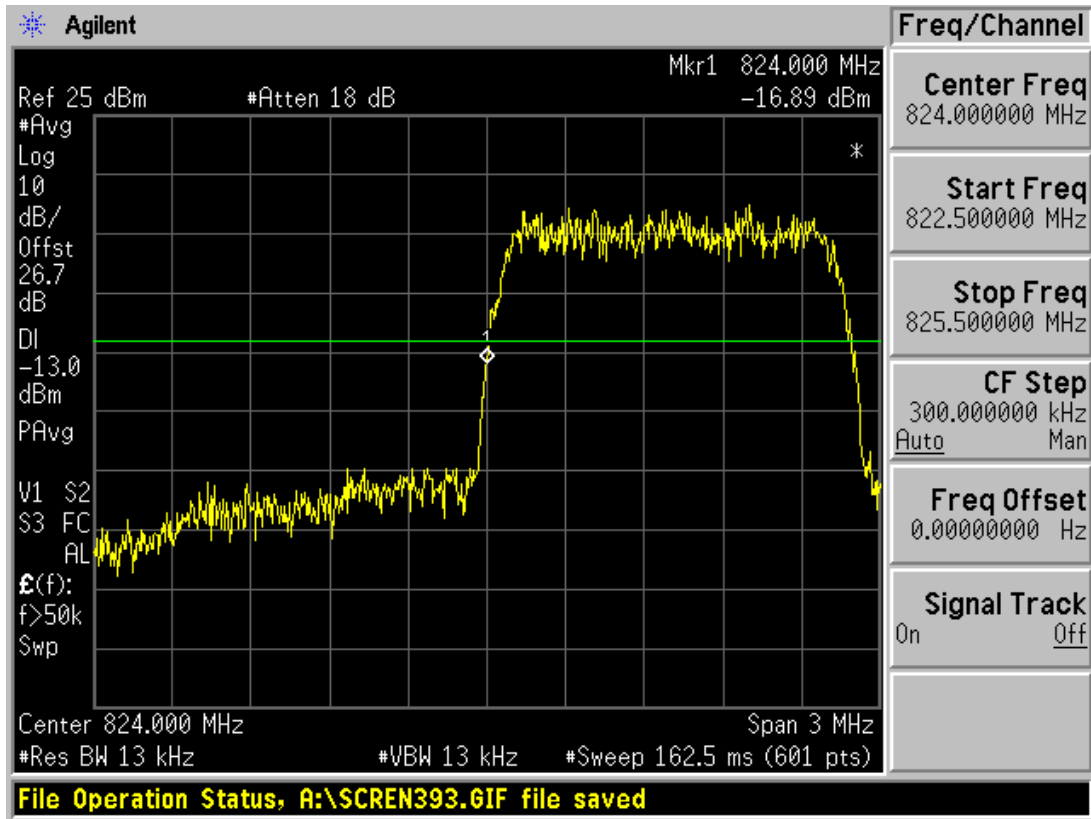

■ CDMA MODE (777 CH.) Block Edge

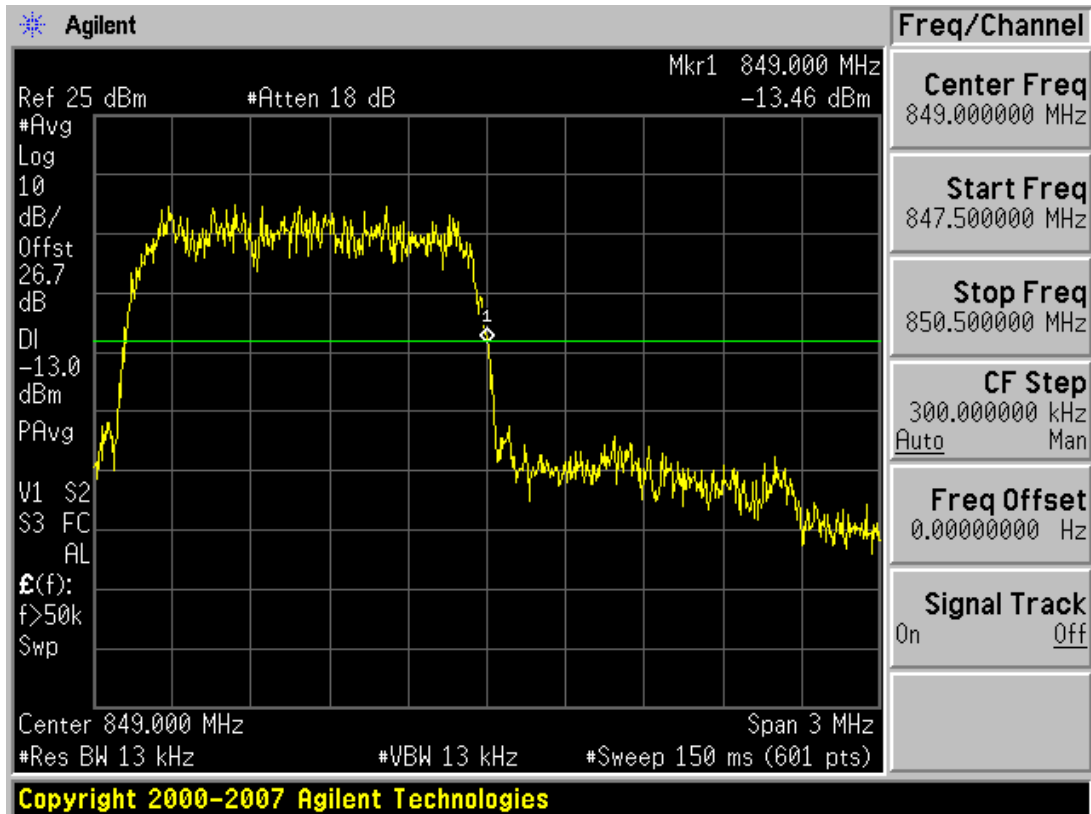





■ PCS CDMA MODE (25 CH.) Block Edge

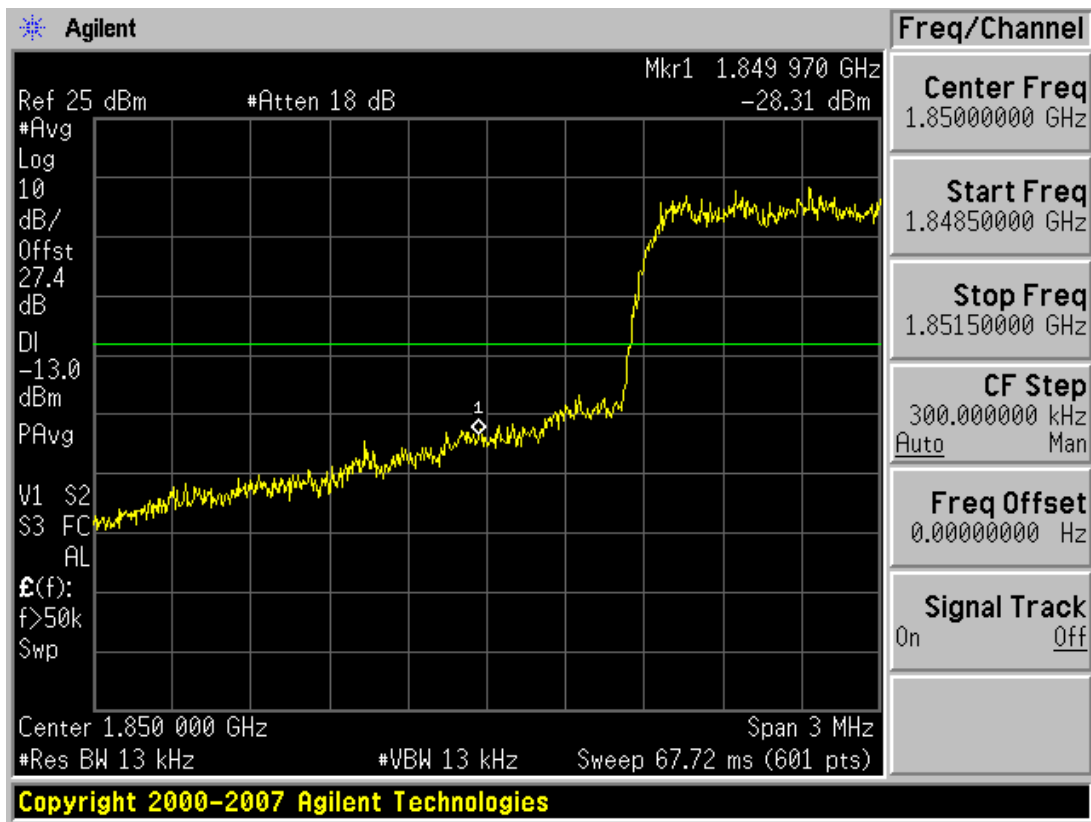

■ PCS CDMA MODE (1175 CH.) Block Edge

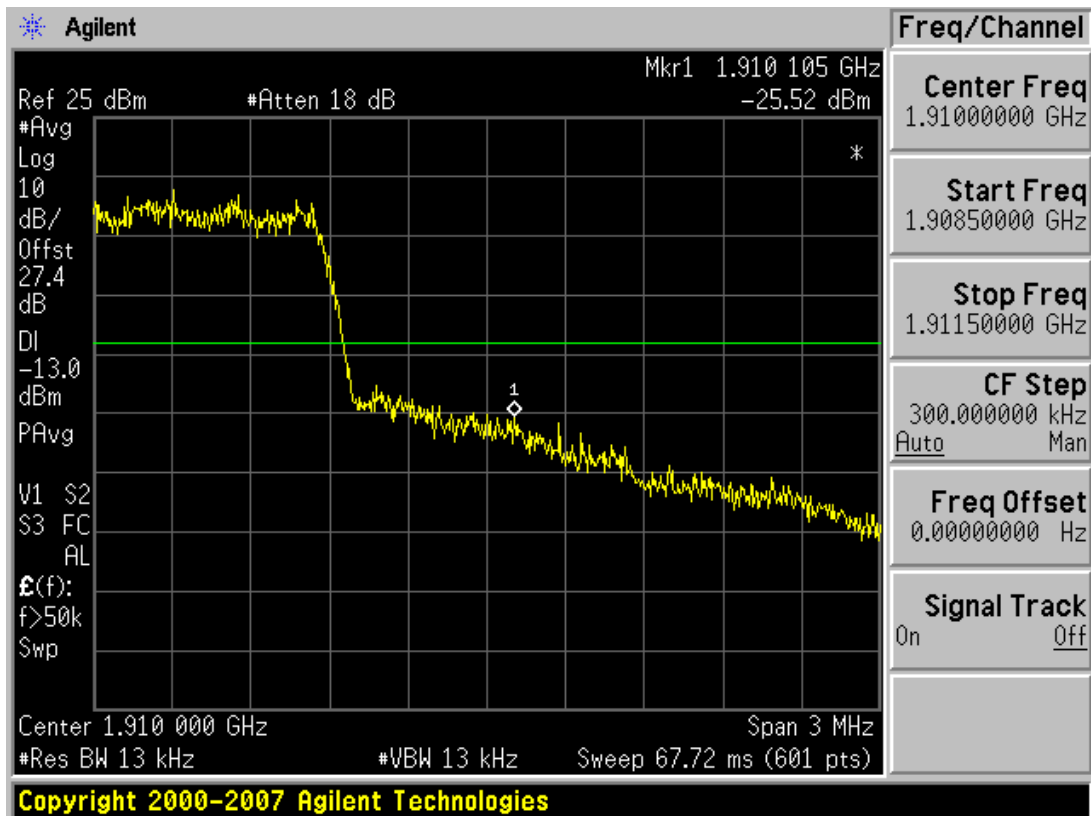

FCC CERTIFICATION REPORT				<a href="http://www.hct.co.kr">www.hct.co.kr</a>
Test Report No. HCT-R08-119	Test Dates: August 13, 2008	EUT Type: Dual-Band CDMA/PCS Phone with Bluetooth	FCC ID: PP4RAP	Page 2 5 of 30

■ CDMA EV-DO MODE (1013 CH.) Block Edge

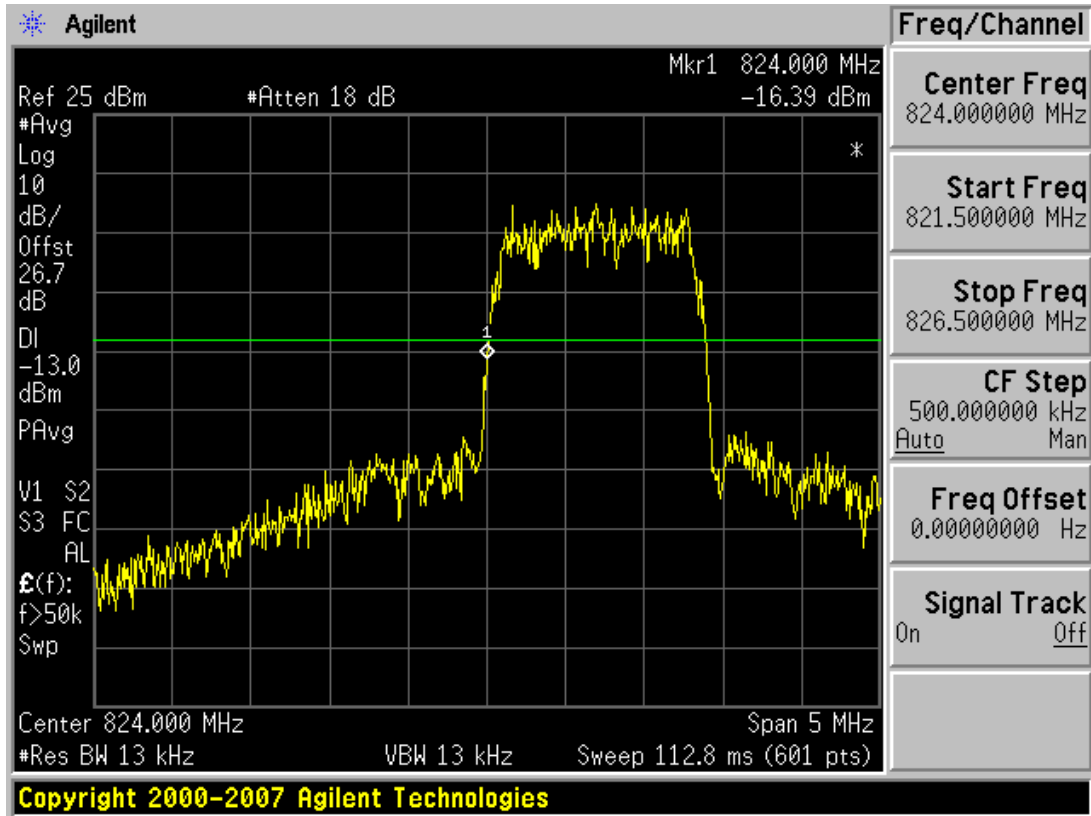

■ CDMA EV-DO MODE (777 CH.) Block Edge



■ PCS EV-DO MODE (25 CH.) Block Edge

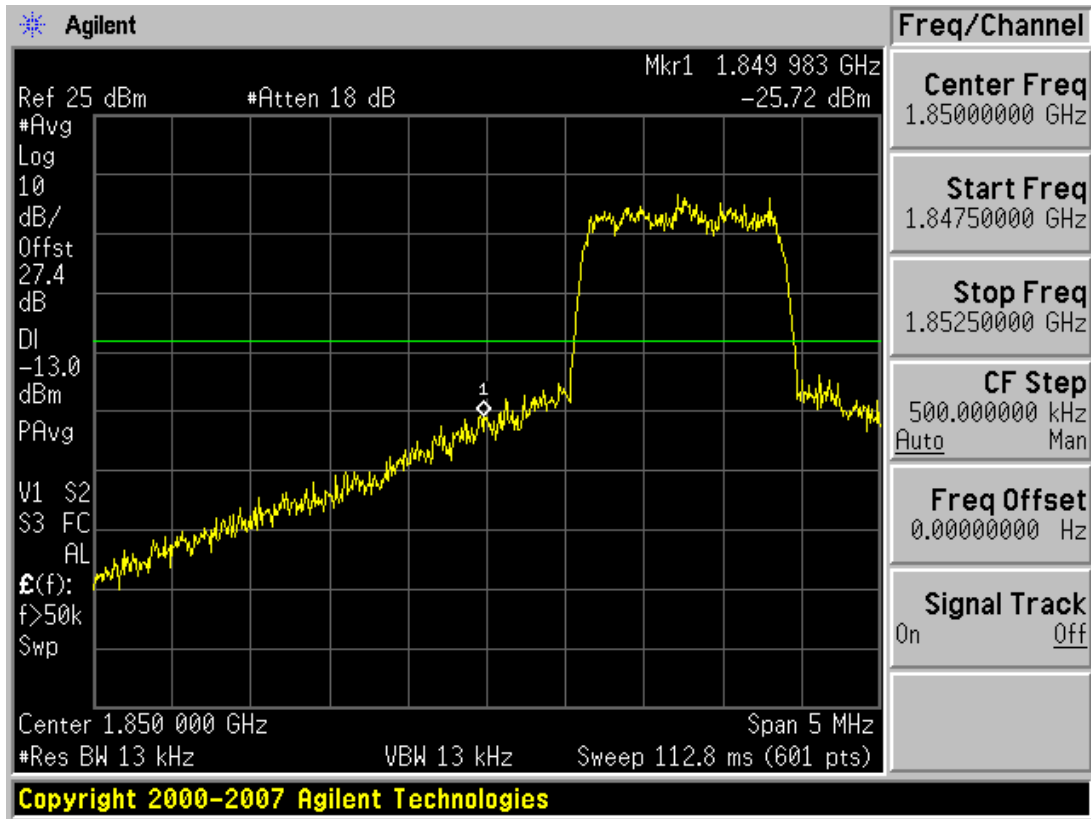

■ PCS EV-DO MODE (1175 CH.) Block Edge

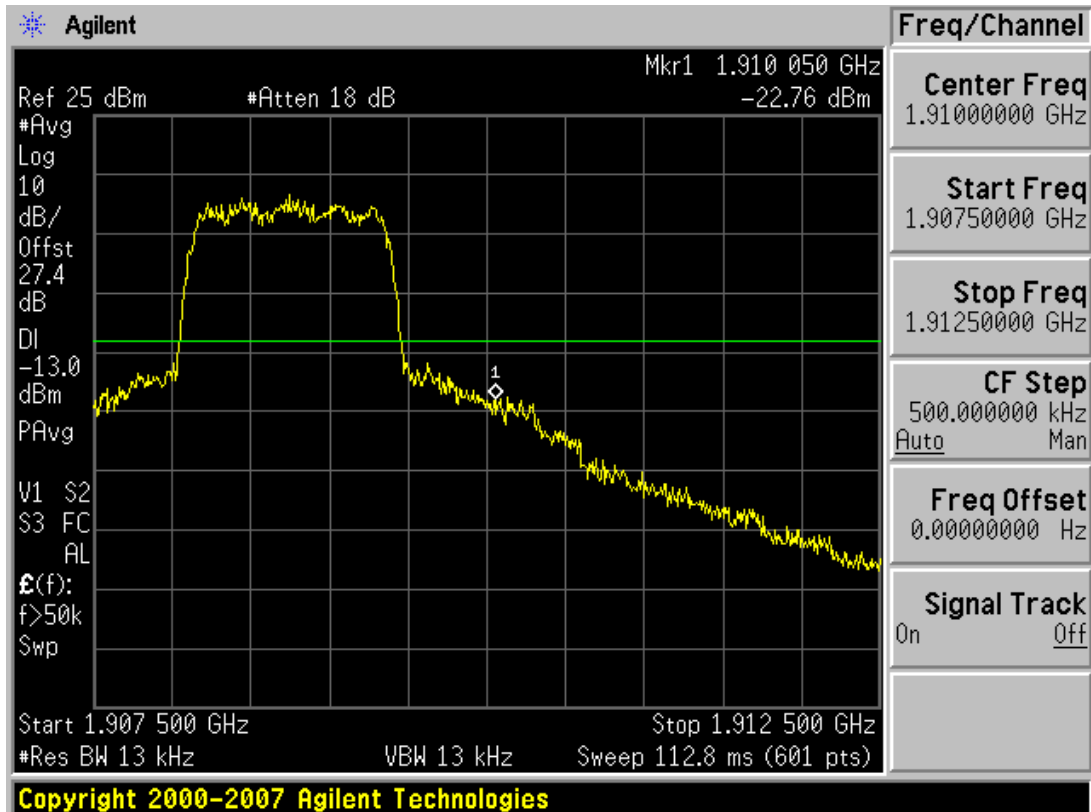

FCC CERTIFICATION REPORT

Test Report No. HCT-R08-119	Test Dates: August 13, 2008	EUT Type: Dual-Band CDMA/PCS Phone with Bluetooth	FCC ID: PP4RAP	Page 27 of 30
--------------------------------	--------------------------------	--	-------------------	---------------

■ CDMA MODE (1013 CH.) Conducted Spurious Emissions

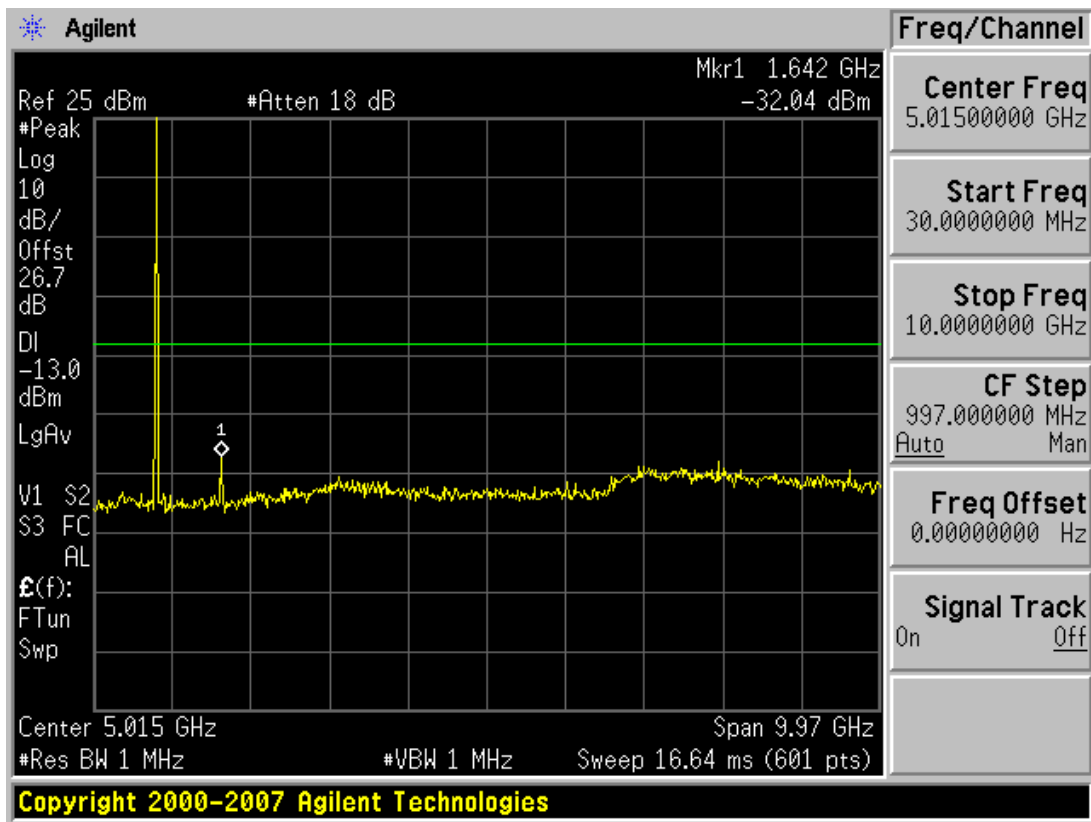

■ CDMA MODE (384 CH.) Conducted Spurious Emissions

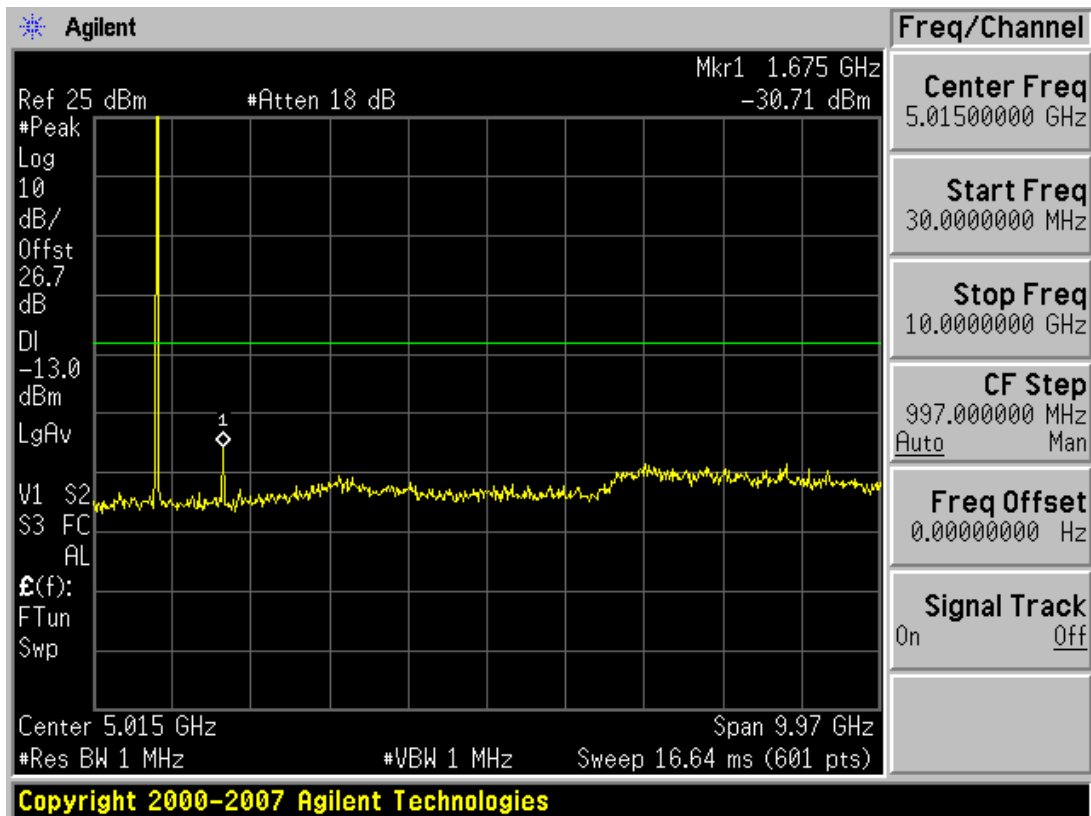

■ CDMA MODE (777 CH.) Conducted Spurious Emissions

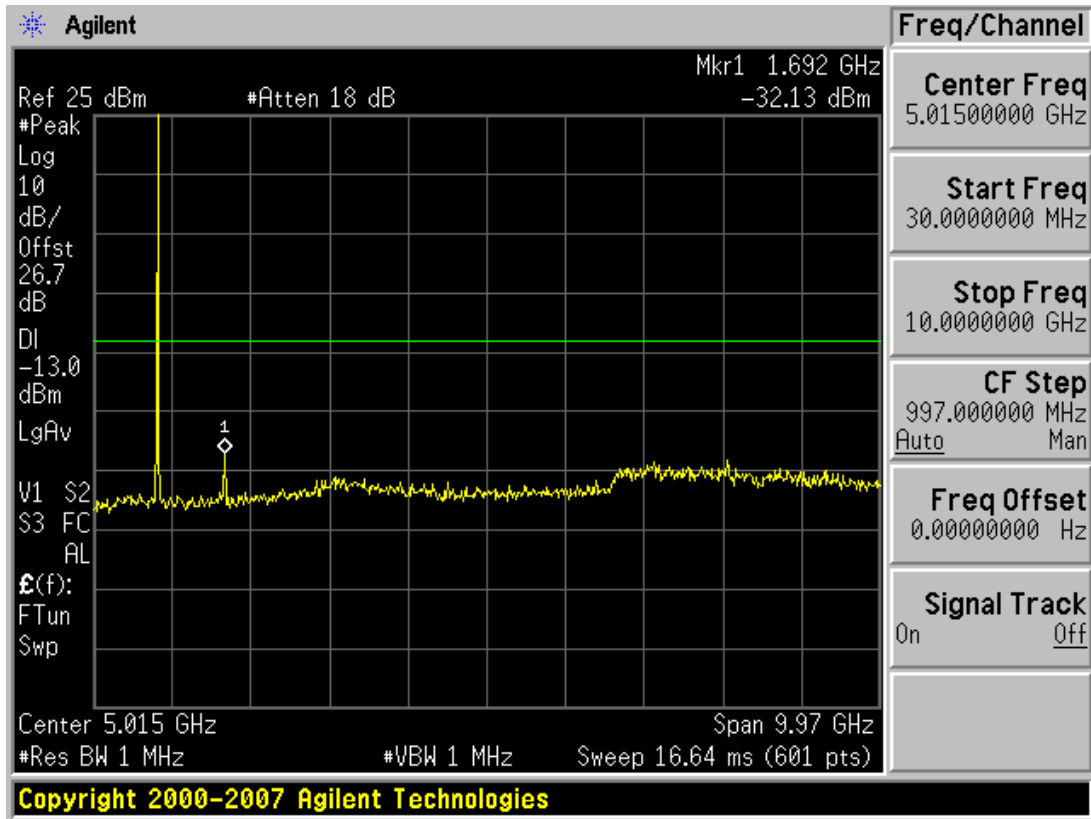

■ PCS CDMA MODE (25 CH.) Conducted Spurious Emissions

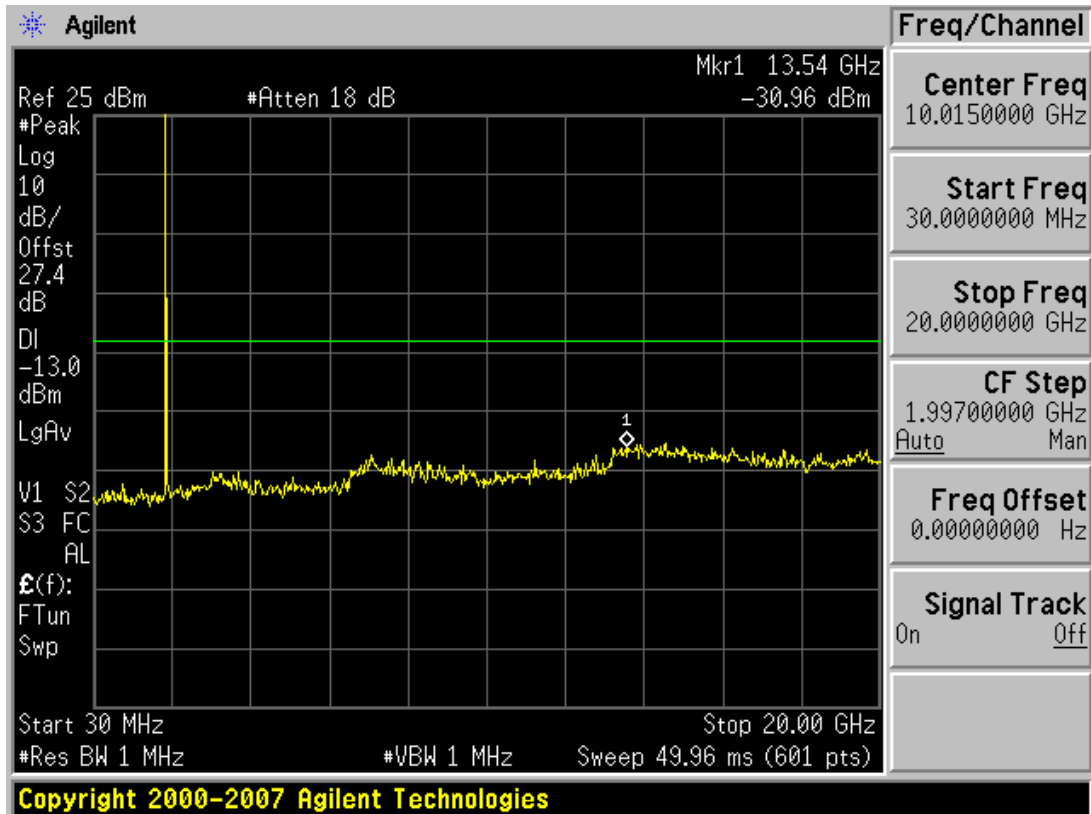

FCC CERTIFICATION REPORT

Test Report No. HCT-R08-119	Test Dates: August 13, 2008	EUT Type: Dual-Band CDMA/PCS Phone with Bluetooth	FCC ID: PP4RAP	Page 29 of 30
--------------------------------	--------------------------------	--	-------------------	---------------



■ PCS CDMA MODE (600 CH.) Conducted Spurious Emissions

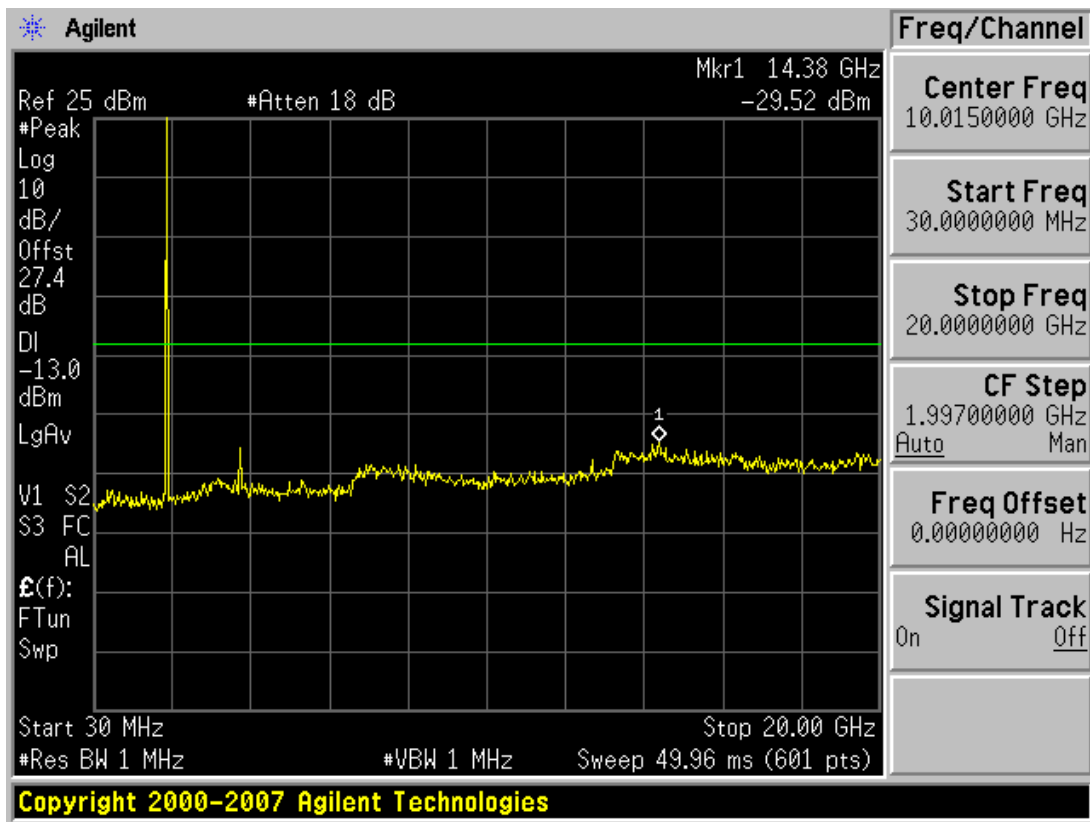

■ PCS CDMA MODE (1175 CH.) Conducted Spurious Emissions

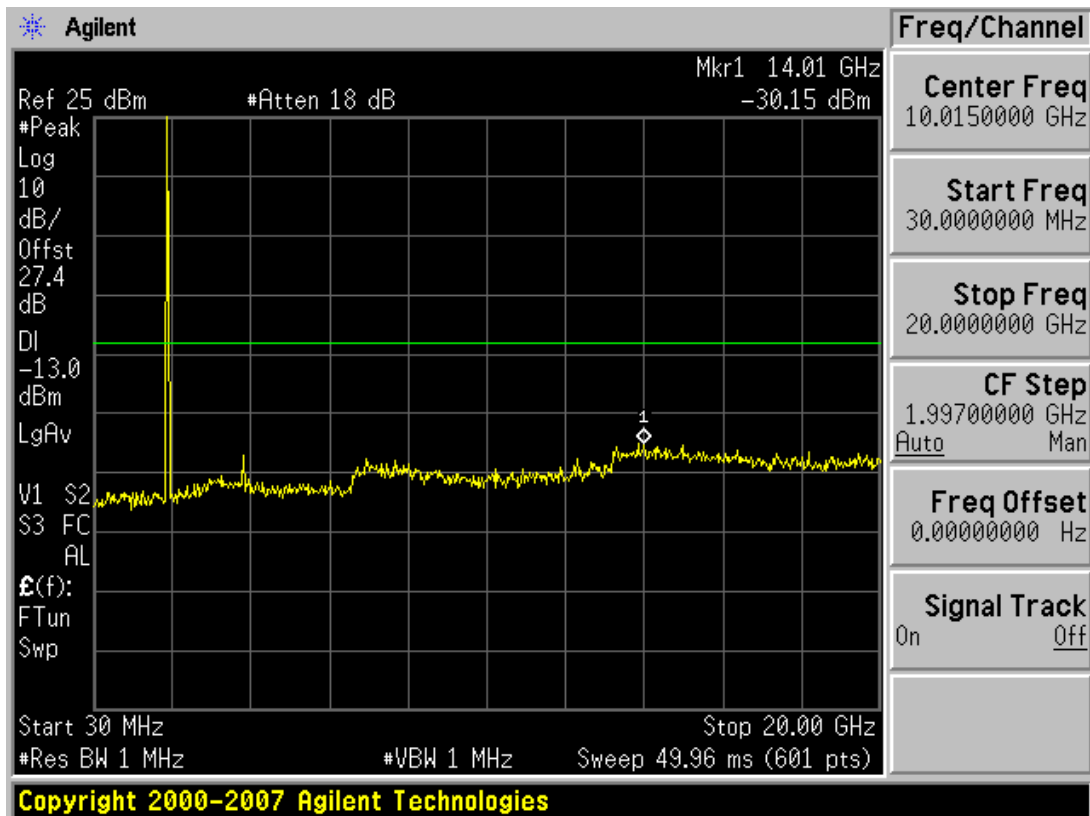

FCC CERTIFICATION REPORT

[www.hct.co.kr](http://www.hct.co.kr)

Test Report No. HCT-R08-119	Test Dates: August 13, 2008	EUT Type: Dual-Band CDMA/PCS Phone with Bluetooth	FCC ID: PP4RAP	Page 3 0 of 30
--------------------------------	--------------------------------	--	-------------------	----------------