



HCT CO., LTD.

Product Compliance Division

TEL : +82 31 639 8518 FAX : +82 31 639 8535

FCC Class II Permissive Change

| | |
|--|--|
| Applicant Name: PANTECH&CURITEL COMMUNICATION, INC. | Date of Issue: December 9, 2009 |
| Address: PANTECH Building, I-2, DMC, Sangam-dong, Mapo-gu, Seoul, 121-792, Korea | Location: HCT CO., LTD., San 136-1 Ami-ri, Bubal-eup, Icheon-si, Kyungki-do, Korea |
| | Test Report No.: HCTR0912FR03 |
| | HCT FRN: 0005866421 |
| | IC Recognition No.: IC 5944A-1 |

| | |
|------------------|--|
| FCC ID | : PP4PX-800 |
| APPLICANT | : PANTECH&CURITEL COMMUNICATION, INC. |

Model(s): UM185

EUT Type: Dual-band CDMA USB Modem

Tx Frequency: 824.70 — 848.31 MHz (CDMA)
1 851.25 — 1 908.75 MHz (PCS CDMA)

Rx Frequency: 869.70 — 893.31 MHz (CDMA)
1 931.25 — 1 988.75 MHz (PCS CDMA)

Max. RF Output Power: 0.340 W ERP CDMA (25.31 dBm) / 0.587 W EIRP PCS CDMA (27.69 dBm) /
0.415 W ERP CDMA EVDO (26.18 dBm) / 0.723 W EIRP PCS EVDO (28.59 dBm)

Emission Designator(s): 1M28F9W (CDMA) / 1M28F9W (PCS CDMA)
1M27F9W (CDMA EVDO), 1M27F9W (PCS CDMA EVDO)

FCC Classification: PCS Licensed Transmitter (PCB)

FCC Rule Part(s): §22, §24, §2

The measurements shown in this report were made in accordance with the procedures specified in §2.947. I assume full responsibility for the accuracy and completeness of these measurements, and for the qualifications of all persons taking them.

HCT CO., LTD. Certifies that no party to this application has been denied FCC benefits pursuant to section 5301 of the Anti-Drug Abuse Act of 1998, 21 U.S. C.853(a)

Report prepared by
: Jong Seok Lee
Test engineer of RF Team

Approved by
: Sang Jun Lee
Manager of RF Team

This report only responds to the tested sample and may not be reproduced, except in full, without written approval of the HCT Co., Ltd.

| | | | | |
|--|------------------------------------|---------------------------------------|--|--------------|
| FCC Class II Permissive Change Test Report | | | www.hct.co.kr | |
| Test Report No. HCTR0912FR03 | Date of Issue: December 9, 2009 | EUT Type: Dual-band CDMA USB Modem | FCC ID: PP4PX-800 | Page 1 of 41 |



Table of Contents

| | |
|---|----|
| 1. GENERAL INFORMATION..... | 3 |
| 2. INTRODUCTION | 4 |
| 2.1. EUT DESCRIPTION..... | 4 |
| 2.2. MEASURING INSTRUMENT CALIBRATION..... | 4 |
| 2.3. TEST FACILITY..... | 4 |
| 3. DESCRIPTION OF TESTS..... | 5 |
| 3.1 Effective Radiated Power/Equivalent Isotropic Radiated Power..... | 5 |
| 3.2 Peak- to- Average Ratio | 6 |
| 3.3 Occupied bandwidth..... | 7 |
| 3.4 Spurious and Harmonic Emissions at Antenna Terminal..... | 8 |
| 3.5 Radiated Spurious and Harmonic Emissions..... | 9 |
| 3.6 Frequency stability / variation of ambient temperature | 10 |
| 4. LIST OF TEST EQUIPMENT..... | 11 |
| 5. SUMMARY OF TEST RESULTS..... | 12 |
| 6. SAMPLE CALCULATION | 13 |
| 7. TEST DATA..... | 14 |
| 7.1 Conducted Output Power | 14 |
| 7.3 Occupied Bandwidth..... | 15 |
| 7.4 Conducted Spurious Emissions..... | 15 |
| 7.4.1 Band Edge | 15 |
| 7.5 Effective Radiated Power Output | 16 |
| 7.6 Equivalent Isotropic Radiated Power | 17 |
| 7.7 Radiated Spurious Emissions | 18 |
| 7.7.1 Radiated Spurious Emissions(CDMA Mode)..... | 18 |
| 7.7.2 Radiated Spurious Emissions(PCS CDMA Mode) | 19 |
| 7.8 Frequency stability / variation of ambient temperature | 20 |
| 7.8.1 FREQUENCY STABILITY (CDMA) | 20 |
| 7.8.2 FREQUENCY STABILITY (PCS CDMA)..... | 21 |
| 8. TEST PLOTS..... | 22 |



MEASUREMENT REPORT

1. GENERAL INFORMATION

Applicant Name: PANTECH&CURITEL COMMUNICATION, INC.

Address: PANTECH Building, I-2, DMC, Sangam-dong, Mapo-gu, Seoul, 121-792, Korea

Contact Person: Name: Sang Don Park
Phone #: TEL :+82-2-2030-1230 / FAX : +82-2-2030-2520

FCC ID: PP4PX-800

Application Type: FCC Class II Permissive Change

FCC Classification: PCS Licensed Transmitter (PCB)

FCC Rule Part(s): §22, §24, §2

EUT Type: Dual-band CDMA USB Modem

Model(s): UM185

Tx Frequency: 824.70 — 848.31 MHz (CDMA)
1 851.25 — 1 908.75 MHz (PCS CDMA)

Rx Frequency: 869.70 — 893.31 MHz (CDMA)
1 931.25 — 1 988.75 MHz (PCS CDMA)

Max. RF Output Power: 0.340 W ERP CDMA (25.31 dBm) / 0.587 W EIRP PCS CDMA (27.69 dBm) /
0.415 W ERP CDMA EVDO (26.18 dBm) / 0.723 W EIRP PCS EVDO (28.59 dBm)

Emission Designator(s): 1M28F9W (CDMA) / 1M28F9W (PCS CDMA)
1M27F9W (CDMA EVDO), 1M27F9W (PCS CDMA EVDO)

Antenna Specification Manufacturer: KARAM Solution
Antenna type: BUILT-IN Antenna
Peak Gain: -0.22 dBi

Date(s) of Tests: November 16, 2009 ~ December 03, 2009

| FCC Class II Permissive Change Test Report | | | | www.hct.co.kr |
|--|---------------------------------|---------------------------------------|----------------------|--|
| Test Report No. HCTR0912FR03 | Test Dates: December 9, 2009 | EUT Type: Dual-band CDMA USB Modem | FCC ID: PP4PX-800 | Page 3 of 41 |



2. INTRODUCTION

2.1. EUT DESCRIPTION

The UM185 Dual-band CDMA USB Modem consists of Cellular CDMA, PCS CDMA, EVDO Rev.0 and EVDO Rev.A.

2.2. MEASURING INSTRUMENT CALIBRATION

The measuring equipment, which was utilized in performing the tests documented herein, has been calibrated in accordance with the manufacturer's recommendations for utilizing calibration equipment, which is traceable to recognized national standards.

2.3. TEST FACILITY

The open area test site and conducted measurement facility used to collect the radiated data are located at the 254-1, Maekok-Ri, Hobup-Myun, Ichon-Si, Kyoungki-Do, 467-701, KOREA. The site is constructed in conformance with the requirements of ANSI C63.4 and CISPR Publication 22. Detailed description of test facility was submitted to the Commission and accepted dated June 10, 2009 (Registration Number: 90661)

| FCC Class II Permissive Change Test Report | | | | www.hct.co.kr |
|--|---------------------------------|---------------------------------------|----------------------|--|
| Test Report No. HCTR0912FR03 | Test Dates: December 9, 2009 | EUT Type: Dual-band CDMA USB Modem | FCC ID: PP4PX-800 | Page 4 of 41 |

3. DESCRIPTION OF TESTS

3.1 Effective Radiated Power/Equivalent Isotropic Radiated Power

Test Set-up

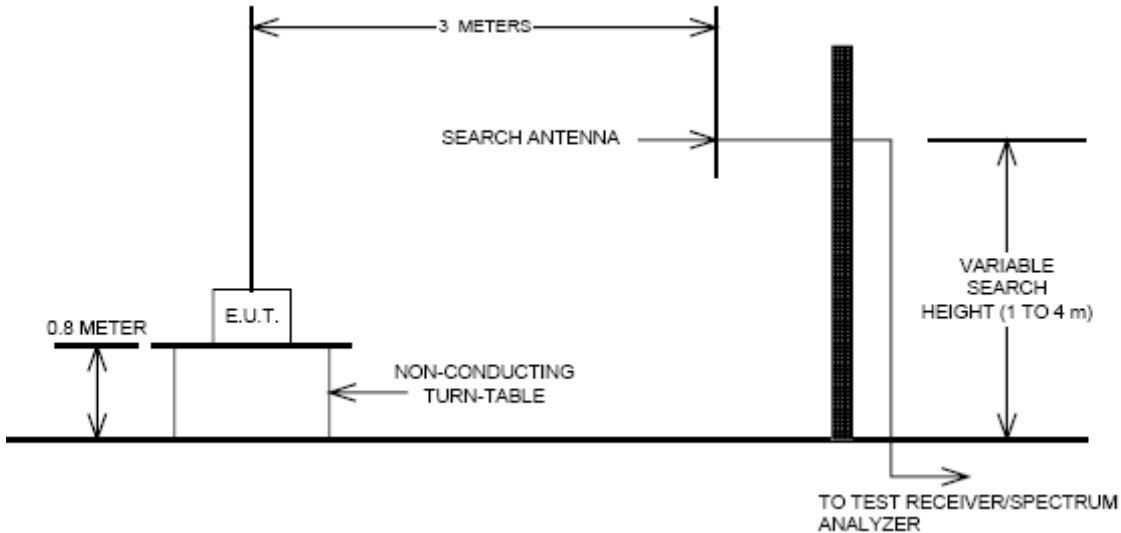

Test Procedure

Radiated emission measurements were performed at an open Site.

The equipment under test is placed on a wooden turntable 3-meters from the receive antenna.

A wooden turntable was rotated 360° and the receiving antenna scanned from 1-4m in order to capture the maximum emission. A half wave dipole was substituted in place of the EUT. This dipole antenna was driven by a signal generator and the previously recorded signal was duplicated.

The maximum EIRP was calculated by adding the forward power to the calibrated source plus its appropriate gain value. These steps were carried out with the receiving antenna in both vertical and horizontal polarization. For readings above 1GHz, the above procedure is repeated using horn antennas and the difference between the gain of the horn and an isotropic antenna are taken into consideration.

Note : This device was tested under all R.C.s and S.O.s and worst case is reported with RC1/SO02(CDMA) and RC1/SO55(PCS), with 'All Up' power control bits.



3.2 Peak- to- Average Ratio

A peak to average ratio measurement is performed at the conducted port of the EUT. For CDMA and WCDMA signals, the spectrum analyzers Complementary Cumulative Distribution Function (CCDF) measurement profile is used to determine the largest deviation between the average and the peak power of the EUT in a given bandwidth. The CCDF curve shows how much time the peak waveform spends at or above a given average power level. The percent of time the signal spends at or above the level defines the probability for that particular power level. For GSM signals, an average and a peak trace are used on a spectrum analyzer to determine the largest deviation between the average and the peak power of the EUT in a bandwidth greater than the emission bandwidth. Plots of the EUT's Peak- to- Average Ratio are shown herein.

Note : This device was tested under all R.C.s and S.O.s and worst case is reported with RC1/SO02(CDMA) and RC1/SO55(PCS), with 'All Up' power control bits.

| FCC Class II Permissive Change Test Report | | | | www.hct.co.kr |
|--|---------------------------------|---------------------------------------|----------------------|--|
| Test Report No. HCTR0912FR03 | Test Dates: December 9, 2009 | EUT Type: Dual-band CDMA USB Modem | FCC ID: PP4PX-800 | Page 6 of 41 |

3.3 Occupied bandwidth.

Test set-up

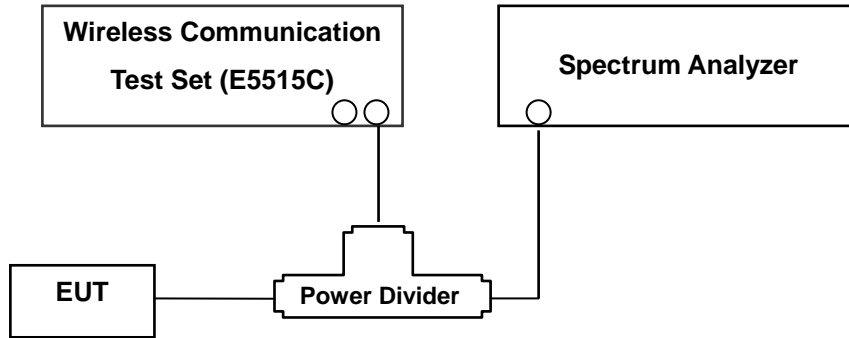

(Configuration of conducted Emission measurement)

Test Procedure

The EUT was setup to maximum output power at its lowest channel. The occupied bandwidth was measured using a spectrum analyzer. The measurements are repeated for the highest and a middle channel. The EUT's occupied bandwidth is measured as the width of the signal between two points, one below the carrier center frequency and one above the carrier frequency, outside of which all emissions are attenuated at least 26 dB below the transmitter power. Plots of the EUT's occupied bandwidth are shown herein.

Note : This device was tested under all R.C.s and S.O.s and worst case is reported with RC1/SO02(CDMA) and RC1/SO55(PCS), with 'All Up' power control bits.



3.4 Spurious and Harmonic Emissions at Antenna Terminal.

Test Procedure

The level of the carrier and the various conducted spurious and harmonic frequencies is measured by means of a calibrated spectrum analyzer.

The EUT was setup to maximum output power at its lowest channel. The Resolution BW of the analyzer is set to 1 % of the emission bandwidth to show compliance with the – 13 dBm limit, in the 1 MHz bands immediately outside and adjacent to the edge of the frequency block. The 1 MHz RBW was used to scan from 30 MHz to 10 GHz. (PCS CDMA Mode: 30 MHz to 20 GHz). A display line was placed at – 13 dBm to show compliance. The high, lowest and a middle channel were tested for out of band measurements.

- Band Edge Requirement : In the 1MHz bands immediately outside and adjacent to the frequency block, a resolution bandwidth of at least 1 percent of the emission bandwidth of the fundamental emission of the transmitter may be employed to measure the out of band Emissions. Limit, -13dBm.

Note : This device was tested under all R.C.s and S.O.s and worst case is reported with RC1/SO02(CDMA) and RC1/SO55(PCS), with 'All Up' power control bits.

| FCC Class II Permissive Change Test Report | | | | www.hct.co.kr |
|--|---------------------------------|---------------------------------------|----------------------|--|
| Test Report No. HCTR0912FR03 | Test Dates: December 9, 2009 | EUT Type: Dual-band CDMA USB Modem | FCC ID: PP4PX-800 | Page 8 of 41 |

3.5 Radiated Spurious and Harmonic Emissions

Test Set-up

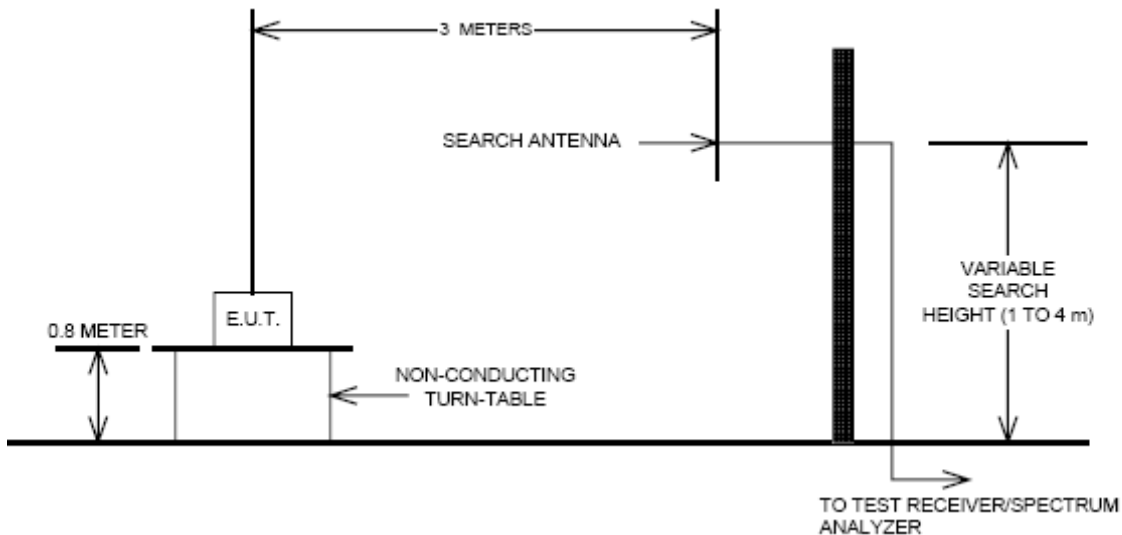

The measurement facilities used for this test have been documented in previous filings with the commission pursuant to section § 2.948. The open field test site is situated in open field with ground screen whose site attenuation characteristics meet ANSI C63.4 –2003. A mast capable of lifting the receiving antenna from a height of one to four meters is used together with a rotatable wooden platform mounted at three from the antenna mast.

- 1) The unit mounted on a wooden table 1.5 m × 1.0 m × 0.80 m is 0.8 meter above test site ground level.
- 2) During the emission test, the turntable is rotated and the EUT is manipulated to find the configuration resulting in maximum emission under normal condition of installation and operation.
- 3) The antenna height and polarization are also varied from 1 to 4 meters until the maximum signal is found.
- 4) The spectrum shall be scanned up to the 10th harmonic of the fundamental frequency.

Test Procedure

The equipment under test is placed on a wooden turntable 3-meters from the receive antenna.

A wooden turntable was rotated 360° and the receiving antenna scanned from 1-4m in order to capture the maximum emission. A half wave dipole was substituted in place of the EUT. This dipole antenna was driven by a signal generator and the previously recorded signal was duplicated.

The maximum EIRP was calculated by adding the forward power to the calibrated source plus its appropriate gain value. These steps were carried out with the receiving antenna in both vertical and horizontal polarization. For readings above 1GHz, the above procedure is repeated using horn antennas and the difference between the gain of the horn and an isotropic antenna are taken into consideration.

Note : This device was tested under all R.C.s and S.O.s and worst case is reported with RC1/SO02(CDMA) and RC1/SO55(PCS), with 'All Up' power control bits.

| FCC Class II Permissive Change Test Report | | | | www.hct.co.kr |
|--|---------------------------------|---------------------------------------|----------------------|--|
| Test Report No. HCTR0912FR03 | Test Dates: December 9, 2009 | EUT Type: Dual-band CDMA USB Modem | FCC ID: PP4PX-800 | Page 9 of 41 |

3.6 Frequency stability / variation of ambient temperature

Test Set-up

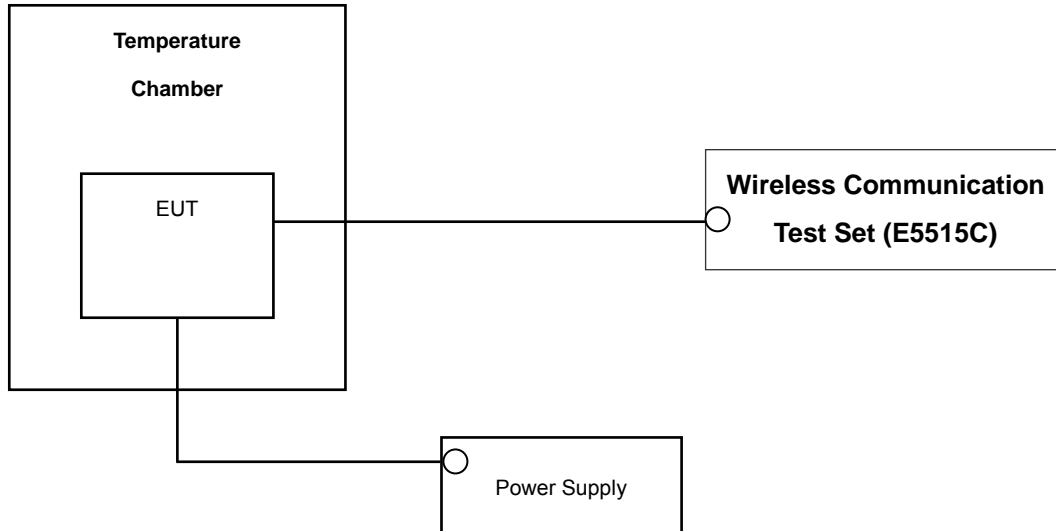

* Nominal Operating Voltage

Test Procedure

The frequency stability of the transmitter is measured by:

- a.) **Temperature:** The temperature is varied from - 30 °C to + 50 °C using an environmental chamber.
- b.) **Primary Supply Voltage:** The primary supply voltage is varied from battery end point to 115 % of the voltage normally at the input to the device or at the power supply terminals if cables are not normally supplied.

Specification — the frequency stability shall be sufficient to ensure that the fundamental emission stays within the authorized frequency block. The frequency stability of the transmitter shall be maintained within $\pm 0.00025\%$ (± 2.5 ppm) of the center frequency.

Time Period and Procedure:

The carrier frequency of the transmitter is measured at room temperature (20°C to provide a reference).

1. The equipment is turned on in a “standby” condition for one minute before applying power to the transmitter. Measurement of the carrier frequency of the transmitter is made within one minute after applying power to the transmitter.
2. Frequency measurements are made at 10°C intervals ranging from -30°C to +50°C. A period of at least one half-hour is provided to allow stabilization of the equipment at each temperature level.

NOTE: The EUT is tested down to the battery endpoint.

Note : This device was tested under all R.C.s and S.O.s and worst case is reported with RC1/SO02(CDMA) and RC1/SO55(PCS), with ‘All Up’ power control bits.



4. LIST OF TEST EQUIPMENT

| Manufacture | Model/ Equipment | Serial Number | Calibration Interval | Calibration Due |
|-------------------|--------------------------------|---------------|----------------------|-----------------|
| R&S | ESI40/ Spectrum Analyzer | 831564/003 | Annual | 10/30/2010 |
| Agilent | E4416A/ Power Meter | GB41291412 | Annual | 01/21/2010 |
| Agilent | E9327A/ Power Sensor | MY4442009 | Annual | 07/28/2010 |
| Agilent | 8960 (E5515C)/ Base Station | GB44400269 | Annual | 02/10/2010 |
| MITEQ | AMF-60-0010 1800-35-20P / AMP | 1200937 | Annual | 05/20/2010 |
| Wainwright | WHK1.2/15G-10EF/H.P.F | 2 | Annual | 06/29/2010 |
| Wainwright | WHK3.3/18G-10EF/H.P.F | 1 | Annual | 06/29/2010 |
| Agilent | 775D/ Dual Directional Coupler | 12922 | Annual | 12/24/2009 |
| Agilent | 11636B/ Power Divider | 11377 | Annual | 12/24/2009 |
| Digital | EP-3010/ Power Supply | 3110117 | Annual | 01/07/2010 |
| Schwarzbeck | UHAP/ Dipole Antenna | 585 | Biennial | 02/13/2011 |
| Schwarzbeck | UHAP/ Dipole Antenna | 558 | Biennial | 02/13/2011 |
| Korea Engineering | KR-1005L / Chamber | KRAB07063-2CH | Annual | 12/31/2009 |
| Schwarzbeck | BBHA 9120D/ Horn Antenna | 147 | Biennial | 03/26/2010 |
| Agilent | E4440A/Spectrum Analyzer | US45303008 | Annual | 12/23/2009 |



5. SUMMARY OF TEST RESULTS

| FCC Part Section(s) | Test Description | Test Limit | Test Condition | Test Result |
|---------------------------------|--|--|----------------|-------------|
| 2.1049, 22.917(a), 24.238(a) | Occupied Bandwidth | N/A | CONDUCTED | PASS |
| 2.1051, 22.917(a), 24.238(a) | Band Edge / Spurious and Harmonic Emissions at Antenna Terminal. | < 43 + 10log ₁₀ (P[Watts]) at Band Edge and for all out-of-band emissions | | PASS |
| 2.1046 | Conducted Output Power | N/A | | PASS |
| 24.232(d), | Peak- to- Average Ratio | < 13 dB | | PASS |
| 2.1055, 22.355, 24.235 | Frequency stability / variation of ambient temperature | < 2.5 ppm | | PASS |
| 22.913(a)(2) 24.232(c) | Effective Radiated Power | < 7 Watts max. ERP | RADIATED | PASS |
| | Equivalent Isotropic Radiated Power | < 2 Watts max. EIRP(PCS) | | PASS |
| 2.1053, 22.917(a), 24.238(a) | Radiated Spurious and Harmonic Emissions | < 43 + 10log ₁₀ (P[Watts]) for all out-of band emissions | | PASS |



6. SAMPLE CALCULATION

A. ERP Sample Calculation

| Mode | Ch./ Freq. | | Measured Level(dBm) | Substitute LEVEL(dBm) | Ant. Gain | C.L | Pol. | ERP | |
|------|------------|------------|---------------------|-----------------------|-----------|------|------|------|-------|
| | channel | Freq.(MHz) | | | | | | W | dBm |
| CDMA | 384 | 836.52 | -10.96 | 24.81 | 2.50 | 1.19 | H | 0.41 | 26.12 |

ERP = SubstituteLEVEL(dBm) + Ant. Gain – CL(Cable Loss)

- 1) The EUT mounted on a wooden tripod is 0.8 meter above test site ground level.
- 2) During the test , the turn table is rotated and the antenna height is also varied from 1 to 4 meters until the maximum signal is found.
- 3) Record the field strength meter's level.
- 4) Replace the EUT with dipole/Horn antenna that is connected to a calibrated signal generator.
- 5) Increase the signal generator output till the field strength meter's level is equal to the item (3).
- 6) The signal generator output level with Ant. Gain and cable loss are the rating of effective radiated power (ERP).

B. Emission Designator

CDMA Emission Designator

Emission Designator = 1M27F9W

CDMA BW = 1.27 MHz (Measured at the 99% power bandwidth)

F = Frequency Modulation

9 = Composite Digital Info

W = Combination (Audio/Data)

7. TEST DATA

This EUT is not supported a USB cable.

7.1 Conducted Output Power

A base station simulator was used to establish communication with The EUT. The base station simulator parameters were set to produce the maximum power from the EUT. This device was tested under all configurations and the highest power is reported. Conducted Output Powers of EUT are reported below.

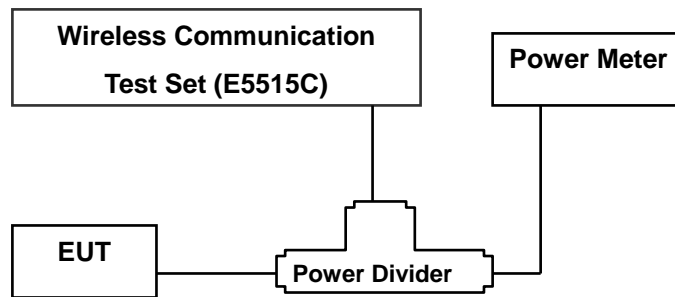

| Band | Channel | SO2 | SO2 | SO55 | SO55 | TDSO | 1xEvD | 1xEvD | 1xEvDO | 1xEvDO |
|------|---------|----------------|----------------|----------------|----------------|------------------------|-----------------|-----------------|------------------|------------------|
| | | RC1/1 (dBm) | RC3/3 (dBm) | RC1/1 (dBm) | RC3/3 (dBm) | SO32 RC3/3 (dBm) | Rev.O (FTAP) | Rev.O (RTAP) | Rev.1 (FETAP) | Rev.1 (RETAP) |
| CDMA | 1013 | 23.91 | 23.73 | 23.87 | 23.84 | 23.90 | 23.71 | 23.67 | 23.50 | 23.48 |
| | 384 | 23.74 | 23.56 | 23.69 | 23.61 | 23.59 | 23.53 | 23.50 | 23.51 | 23.41 |
| | 777 | 24.00 | 23.80 | 23.74 | 23.89 | 23.85 | 23.77 | 23.76 | 23.66 | 23.57 |
| PCS | 25 | 23.79 | 23.91 | 23.90 | 23.90 | 23.89 | 23.76 | 23.66 | 23.54 | 23.47 |
| | 600 | 23.79 | 23.82 | 23.82 | 23.83 | 23.89 | 23.70 | 23.68 | 23.49 | 23.50 |
| | 1175 | 23.63 | 23.74 | 23.82 | 23.82 | 23.87 | 23.83 | 23.82 | 23.71 | 23.72 |

(Maximum Conducted Output Powers)

Note : Detecting mode is average.

7.2 Peak-to-Average Ratio

- Plot of the EUT's Peak- to- Average Ratio is shown Page 27.



7.3 Occupied Bandwidth

| Band | Channel | Frequency(MHz) | Data (MHz) |
|-----------|---------|----------------|------------|
| CDMA | 1013 | 824.70 | 1.2812 |
| | 384 | 836.52 | 1.2785 |
| | 777 | 848.31 | 1.2743 |
| CDMA EVDO | 1013 | 824.70 | 1.2726 |
| PCS | 25 | 1851.25 | 1.2722 |
| | 600 | 1880.00 | 1.2770 |
| | 1175 | 1908.75 | 1.2808 |
| PCS EVDO | 1175 | 1908.75 | 1.2714 |

- Plots of the EUT's Occupied Bandwidth are shown Page 23 ~ 26.

7.4 Conducted Spurious Emissions

| Band | Channel | Frequency of Maximum Harmonic (GHz) | Maximum Data (dBm) |
|------|---------|-------------------------------------|--------------------|
| CDMA | 1013 | 7.6875 | -40.93 |
| | 384 | 7.1875 | -40.84 |
| | 777 | 7.0125 | -40.40 |
| PCS | 25 | 3.7020 | -31.34 |
| | 600 | 3.7620 | -34.44 |
| | 1175 | 3.8150 | -25.88 |

- Plots of the EUT's Conducted Spurious Emissions are shown Page 35 ~ 41.

7.4.1 Band Edge

- Plots of the EUT's Band Edge are shown Page 27 ~ 35.



7.5 Effective Radiated Power Output

(CDMA Mode)

| Mode | Ch./ Freq. | | Measured Level(dBm) | Substitute LEVEL (dBm) | Ant. Gain | C.L | Pol. | ERP | |
|------|------------|------------|---------------------|------------------------|-----------|------|------|------|-------|
| | channel | Freq.(MHz) | | | | | | W | dBm |
| CDMA | 1013 | 824.70 | -12.48 | 33.35 | -8.31 | 1.17 | H | 0.24 | 23.87 |
| | 384 | 836.52 | -13.02 | 33.47 | -8.22 | 1.19 | H | 0.25 | 24.06 |
| | 777 | 848.31 | -12.49 | 34.64 | -8.13 | 1.20 | H | 0.34 | 25.31 |
| EVDO | 1013 | 824.70 | -11.92 | 33.91 | -8.31 | 1.17 | H | 0.28 | 24.43 |
| | 384 | 836.52 | -13.00 | 33.49 | -8.22 | 1.19 | H | 0.26 | 24.08 |
| | 777 | 848.31 | -11.62 | 35.51 | -8.13 | 1.20 | H | 0.41 | 26.18 |

Note: This unit was tested with a notebook computer.

NOTES:

Effective Radiated Power Output Measurements by Substitution Method

according to ANSI/TIA/EIA-603-C-2004, Aug. 17, 2004:

The EUT was placed on a wooden turn table 3-meters from the receive antenna. The receive antenna height and turntable rotation was adjusted for the highest reading on the receive spectrum analyzer. For CDMA signals, a peak detector is used, with RBW = VBW = 3 MHz. For WCDMA signals, a peak detector is used, with RBW = VBW = 5MHz. For AMPS, GSM, and NADC TDMA signals, a peak detector is used, with RBW = VBW = 1 MHz. A half-wave dipole was substituted in place of the EUT. This dipole antenna was driven by a signal generator and the level of the signal generator was adjusted to obtain the same receive spectrum analyzer reading. The conducted power at the terminals of the dipole is measured. The ERP is recorded.

Also, we have done x, y, z planes in EUT and horizontal and vertical polarization in detecting antenna. The worst case of the EUT is in x plane in CDMA mode. Also worst case of detecting Antenna is in horizontal polarization in CDMA mode.

The EVDO mode testing were performed using FTAP on Rev.0 because FTAP on Rev.0 is highest power in EVDO mode.



7.6 Equivalent Isotropic Radiated Power

(PCS CDMA Mode)

| Mode | Ch./ Freq. | | Measured Level(dBm) | Substitute LEVEL (dBm) | Ant. Gain | C.L | Pol. | EIRP | |
|------|------------|------------|---------------------|------------------------|-----------|------|------|------|-------|
| | channel | Freq.(MHz) | | | | | | W | dBm |
| PCS | 25 | 1,851.25 | -12.63 | 18.98 | 10.05 | 1.91 | V | 0.51 | 27.11 |
| | 600 | 1,880.00 | -12.73 | 19.09 | 10.05 | 1.95 | V | 0.52 | 27.19 |
| | 1175 | 1,908.75 | -12.30 | 19.60 | 10.06 | 1.97 | V | 0.59 | 27.69 |
| EVDO | 25 | 1,851.25 | -11.86 | 19.75 | 10.05 | 1.91 | V | 0.61 | 27.88 |
| | 600 | 1,880.00 | -11.86 | 19.96 | 10.05 | 1.95 | V | 0.64 | 28.06 |
| | 1175 | 1,908.75 | -11.40 | 20.50 | 10.06 | 1.97 | V | 0.72 | 28.59 |

Note: This unit was tested with a notebook computer.

NOTES:

Equivalent Isotropic Radiated Power Measurements by Substitution Method

according to ANSI/TIA/EIA-603-C-2004, Aug. 17, 2004:

The EUT was placed on a wooden turn table 3-meters from the receive antenna. The receive antenna height and turntable rotation was adjusted for the highest reading on the receive spectrum analyzer. For CDMA signals, a peak detector is used, with RBW = VBW = 3 MHz. For WCDMA signals, a peak detector is used, with RBW = VBW = 5MHz. For AMPS, GSM, and NADC TDMA signals, a peak detector is used, with RBW = VBW = 1 MHz. A Horn antenna was substituted in place of the EUT. This Horn antenna was driven by a signal generator and the level of the signal generator was adjusted to obtain the same receive spectrum analyzer reading. The conducted power at the terminals of the Horn antenna is measured. The difference between the gain of the horn and an isotropic antenna is taken into consideration and the EIRP is recorded.

Also, we have done x, y, z planes in EUT and horizontal and vertical polarization in detecting antenna. The worst case of the EUT is in y plane in PCS mode. Also worst case of detecting Antenna is in vertical polarization in PCS mode.

The EVDO mode testing were performed using FTAP on Rev.0 because FTAP on Rev.0 is highest power in EVDO mode.



7.7 Radiated Spurious Emissions

7.7.1 Radiated Spurious Emissions(FTAP on CDMA EVDO Rev.0 Mode)

- MEASURED OUTPUT POWER: 26.18 dBm = 0.415 W
- MODULATION SIGNAL: CDMA EVDO
- DISTANCE: 3 meters
- LIMIT: - (43 + 10 log₁₀ (W)) = - 39.18 dBc

| Ch. | Freq.(MHz) | Measured Level [dBm] | Ant. Gain | Substitute Level [dBm] | C.L | Pol. | ERP (dBm) | dBc |
|------|------------|-------------------------|-----------|------------------------------|------|------|--------------|--------|
| 1013 | 1,649.40 | -48.99 | 7.09 | -59.52 | 1.73 | V | -54.16 | -79.47 |
| | 2,474.10 | -51.78 | 8.12 | -58.89 | 2.28 | V | -53.05 | -78.36 |
| | 3,298.80 | -57.79 | 9.72 | -65.37 | 2.57 | V | -58.22 | -83.53 |
| 384 | 1,673.04 | -48.41 | 7.23 | -59.17 | 1.79 | V | -53.73 | -79.04 |
| | 2,509.56 | -48.14 | 8.14 | -55.27 | 2.33 | V | -49.46 | -74.77 |
| | 3,346.08 | -57.11 | 9.99 | -65.14 | 2.66 | H | -57.81 | -83.12 |
| 777 | 1,696.62 | -50.67 | 7.41 | -61.28 | 1.83 | V | -55.70 | -81.01 |
| | 2,544.93 | -51.82 | 8.21 | -59.10 | 2.34 | V | -53.23 | -78.54 |
| | 3,393.24 | -57.65 | 9.91 | -65.28 | 2.85 | H | -58.22 | -83.53 |

- NOTES:**
1. Radiated Spurious Emission Measurements at 3 meters by Substitution Method according to ANSI/TIA/EIA-603-C-2004, Aug. 17, 2004:
 2. The magnitude of spurious emissions attenuated more than 20dB below the limit above 5th Harmonic for all channel.
 3. we have done x, y, z planes in EUT and horizontal and vertical polarization in detecting antenna.
 4. The testing were performed using FTAP on Rev.0 because FTAP on Rev.0 is highest power in CDMA EVDO and CDMA mode.



7.7.2 Radiated Spurious Emissions(FTAP on PCS EVDO Rev.0 Mode)

- MEASURED OUTPUT POWER: 28.59 dBm = 0.723 W
- MODULATION SIGNAL: PCS CDMA EVDO
- DISTANCE: 3 meters
- LIMIT: - (43 + 10 log₁₀(W)) = - 41.59 dBc

| Ch. | Freq.(MHz) | Measured Level [dBm] | Ant. Gain | Substitute Level [dBm] | C.L | Pol. | EIRP (dBm) | dBc |
|------|------------|-------------------------|-----------|------------------------------|------|------|---------------|--------|
| 25 | 3,702.50 | -34.28 | 12.46 | -40.55 | 2.73 | H | -30.82 | -58.51 |
| | 5,553.75 | -54.15 | 12.70 | -55.73 | 3.60 | H | -46.63 | -74.32 |
| | 7,405.00 | -56.11 | 11.36 | -47.23 | 3.88 | H | -39.75 | -67.44 |
| 600 | 3,760.00 | -38.13 | 12.47 | -44.10 | 2.73 | H | -34.36 | -62.05 |
| | 5,640.00 | -55.91 | 12.75 | -57.56 | 3.60 | H | -48.41 | -76.10 |
| | 7,520.00 | -56.77 | 11.33 | -47.67 | 3.88 | H | -40.22 | -67.91 |
| 1175 | 3,817.50 | -33.26 | 12.49 | -39.14 | 2.73 | H | -29.38 | -57.07 |
| | 5,726.25 | -56.98 | 12.80 | -58.29 | 3.60 | H | -49.09 | -76.78 |
| | 7,635.00 | -56.15 | 11.30 | -46.82 | 3.88 | H | -39.40 | -67.09 |

- NOTES:**
1. Radiated Spurious Emission Measurements at 3 meters by Substitution Method according to ANSI/TIA/EIA-603-C-2004, Aug. 17, 2004:
 2. The magnitude of spurious emissions attenuated more than 20dB below the limit above 5th Harmonic for all channel.
 3. we have done x, y, z planes in EUT and horizontal and vertical polarization in detecting antenna.
 4. The testing were performed using FTAP on Rev.0 because FTAP on Rev.0 is highest power in PCS EVDO and PCS mode.



7.8 Frequency stability / variation of ambient temperature

7.8.1 FREQUENCY STABILITY (CDMA)

OPERATING FREQUENCY: 836,520,000 Hz
 CHANNEL: 384
 REFERENCE VOLTAGE: 3.7 VDC
 DEVIATION LIM IT: ± 0.000 25 % or 2.5 ppm

| Voltage (%) | Power (VDC) | Temp. (°C) | Frequency (Hz) | Frequency Error (Hz) | Deviation (%) | ppm |
|----------------|-------------|------------|----------------|----------------------|---------------|--------|
| 100% | 3.700 | +20(Ref) | 836 520 005 | 4.64 | 0.000 001 | 0.006 |
| 100% | | -30 | 836 520 002 | 1.85 | 0.000 000 | 0.002 |
| 100% | | -20 | 836 520 000 | 0.26 | 0.000 000 | 0.000 |
| 100% | | -10 | 836 520 002 | 2.07 | 0.000 000 | 0.002 |
| 100% | | 0 | 836 520 004 | 3.87 | 0.000 000 | 0.005 |
| 100% | | +10 | 836 520 006 | 5.83 | 0.000 001 | 0.007 |
| 100% | | +20 | 836 520 002 | 1.72 | 0.000 000 | 0.002 |
| 100% | | +30 | 836 519 999 | -1.45 | 0.000 000 | -0.002 |
| 100% | | +40 | 836 520 002 | 2.26 | 0.000 000 | 0.003 |
| 100% | | +50 | 836 519 998 | -2.13 | 0.000 000 | -0.003 |
| 115% | 4.255 | +20 | 836 520 003 | 3.45 | 0.000 000 | 0.004 |
| Batt. Endpoint | 3.400 | +20 | 836 520 003 | 2.55 | 0.000 000 | 0.003 |

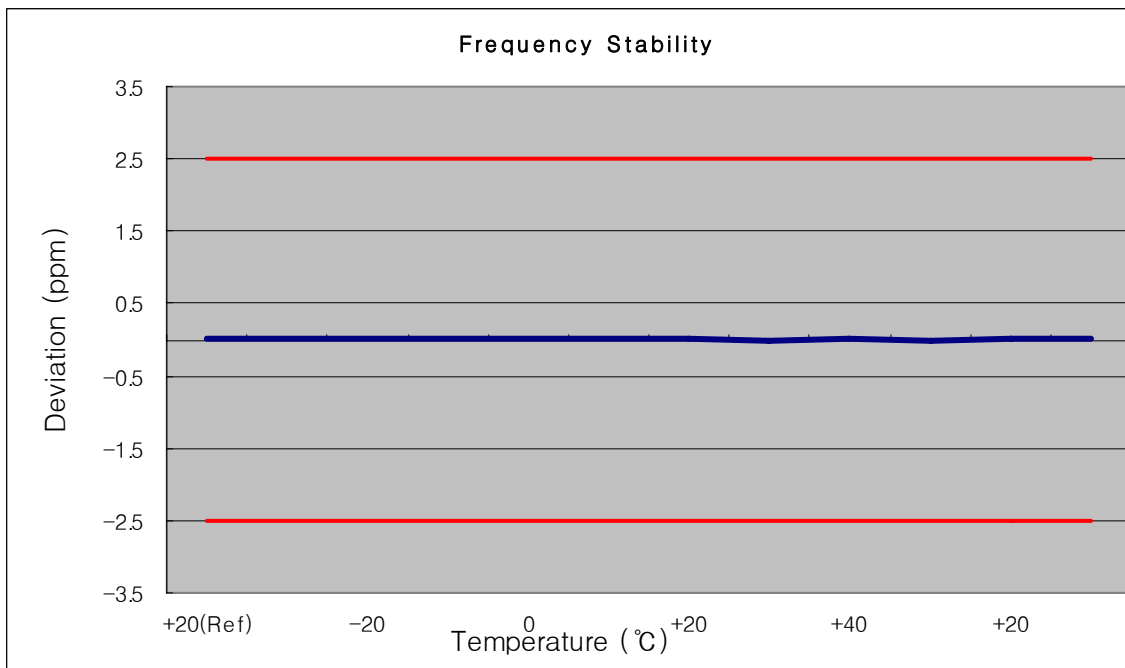



7.8.2 FREQUENCY STABILITY (PCS CDMA)

OPERATING FREQUENCY: 1880,000,000 Hz
 CHANNEL: 600
 REFERENCE VOLTAGE: 3.7 VDC
 DEVIATION LIM IT: ± 0.000 25 % or 2.5 ppm

| Voltage (%) | Power (VDC) | Temp. (°C) | Frequency (Hz) | Frequency Error (Hz) | Deviation (%) | ppm |
|----------------|-------------|------------|----------------|----------------------|---------------|--------|
| 100% | 3.700 | +20(Ref) | 1880 000 008 | 7.96 | 0.000 000 | 0.004 |
| 100% | | -30 | 1880 000 009 | 9.29 | 0.000 000 | 0.005 |
| 100% | | -20 | 1879 999 996 | -4.04 | 0.000 000 | -0.002 |
| 100% | | -10 | 1880 000 013 | 12.62 | 0.000 001 | 0.007 |
| 100% | | 0 | 1880 000 009 | 8.81 | 0.000 000 | 0.005 |
| 100% | | +10 | 1880 000 007 | 7.17 | 0.000 000 | 0.004 |
| 100% | | +20 | 1880 000 008 | 8.08 | 0.000 000 | 0.004 |
| 100% | | +30 | 1879 999 996 | -3.61 | 0.000 000 | -0.002 |
| 100% | | +40 | 1880 000 010 | 9.66 | 0.000 001 | 0.005 |
| 100% | | +50 | 1879 999 994 | -5.81 | 0.000 000 | -0.003 |
| 115% | 4.255 | +20 | 1880 000 007 | 7.02 | 0.000 000 | 0.004 |
| Batt. Endpoint | 3.400 | +20 | 1879 999 993 | -6.61 | 0.000 000 | -0.004 |

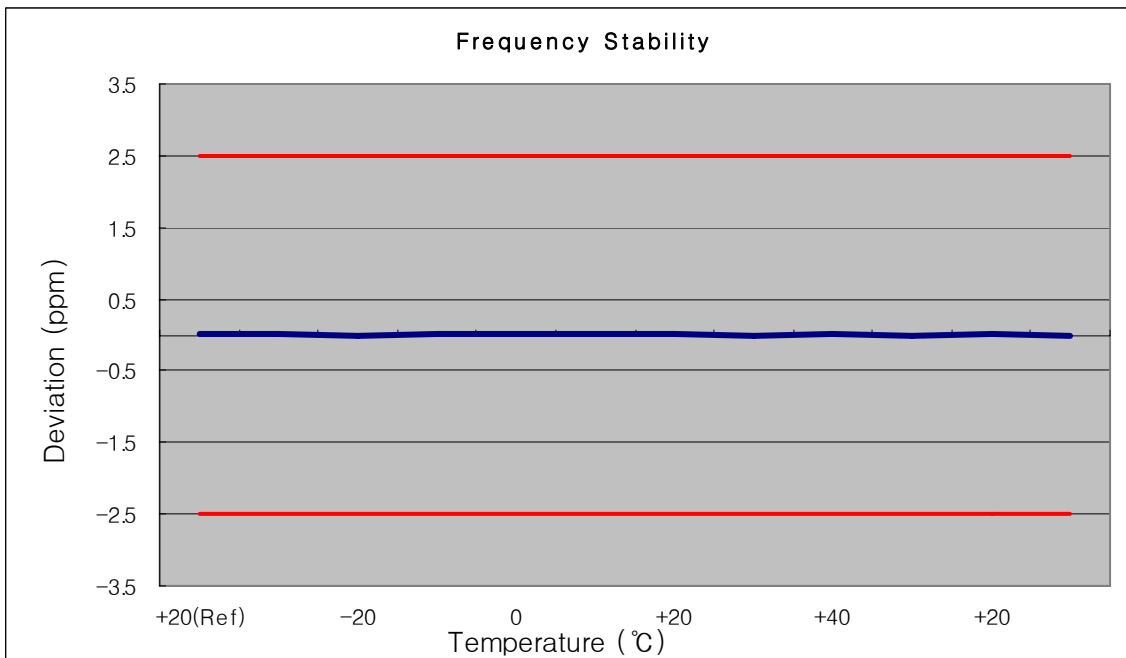



8. TEST PLOTS

| FCC Class II Permissive Change Test Report | | | | www.hct.co.kr |
|--|---------------------------------|---------------------------------------|----------------------|--|
| Test Report No. HCTR0912FR03 | Test Dates: December 9, 2009 | EUT Type: Dual-band CDMA USB Modem | FCC ID: PP4PX-800 | Page 22 of 41 |

■ CDMA MODE (1013 CH.) Occupied Bandwidth

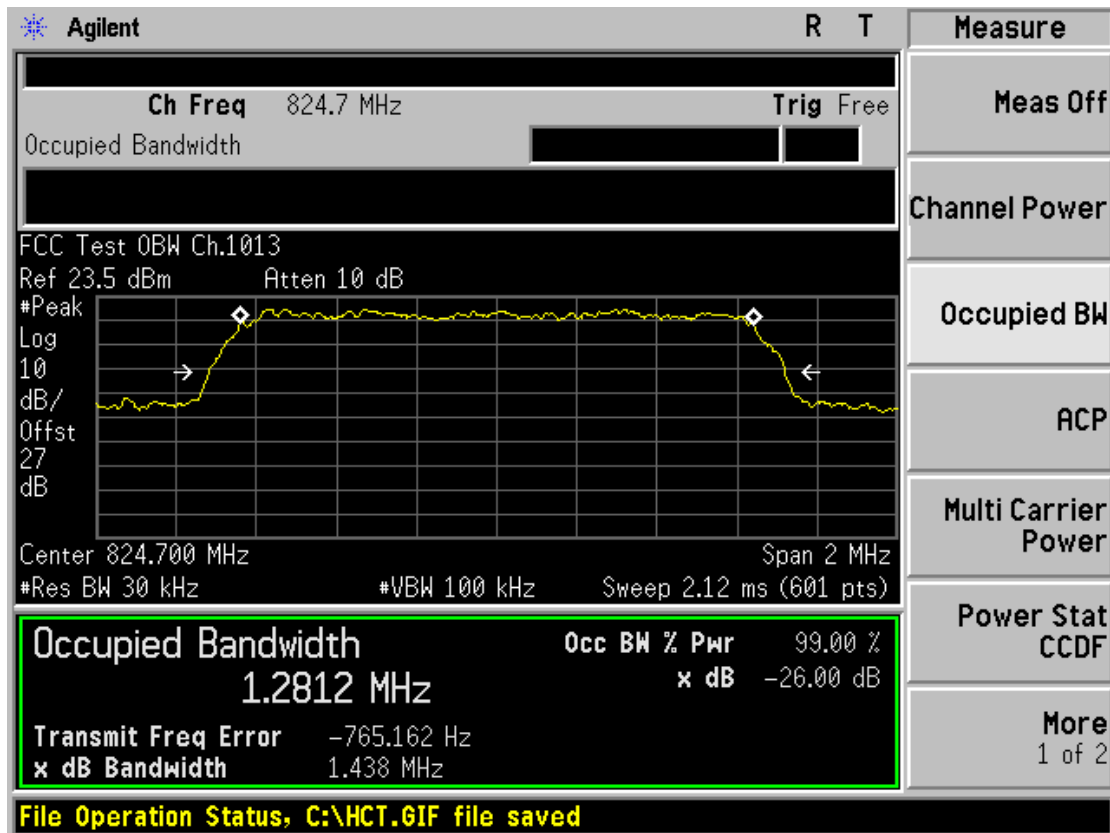

■ CDMA MODE (384 CH.) Occupied Bandwidth

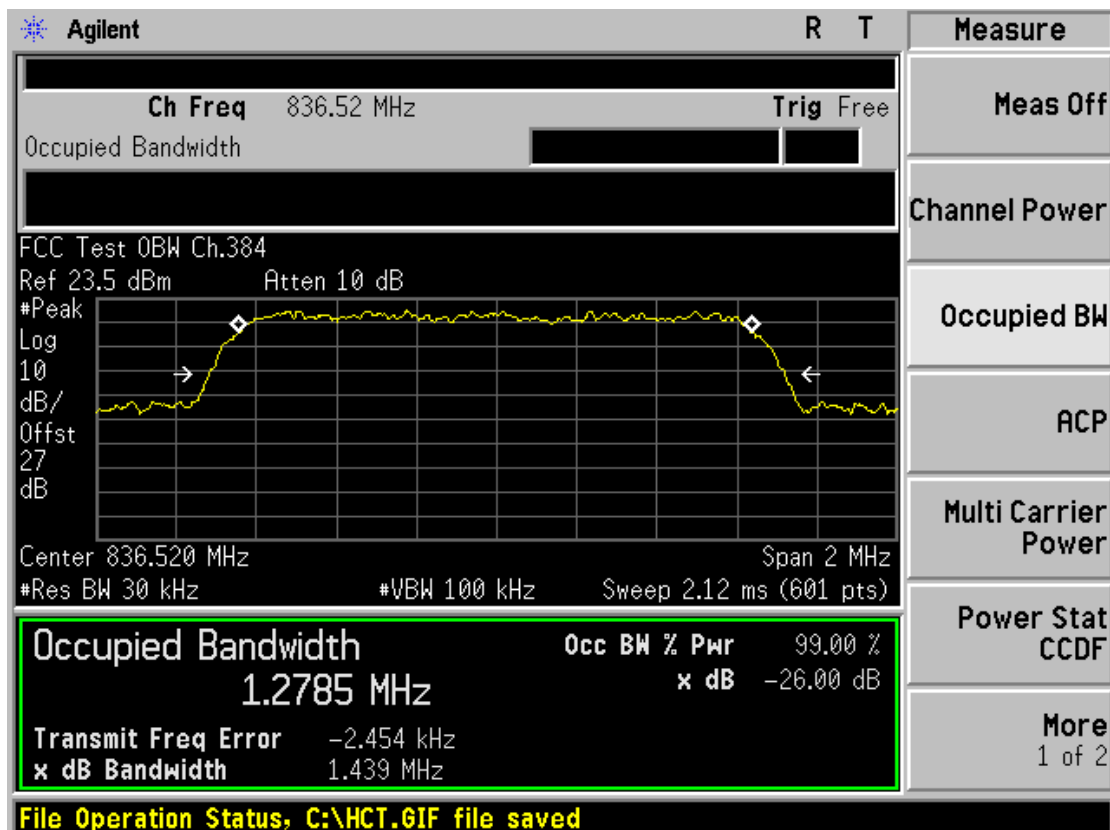

■ CDMA MODE (777 CH.) Occupied Bandwidth

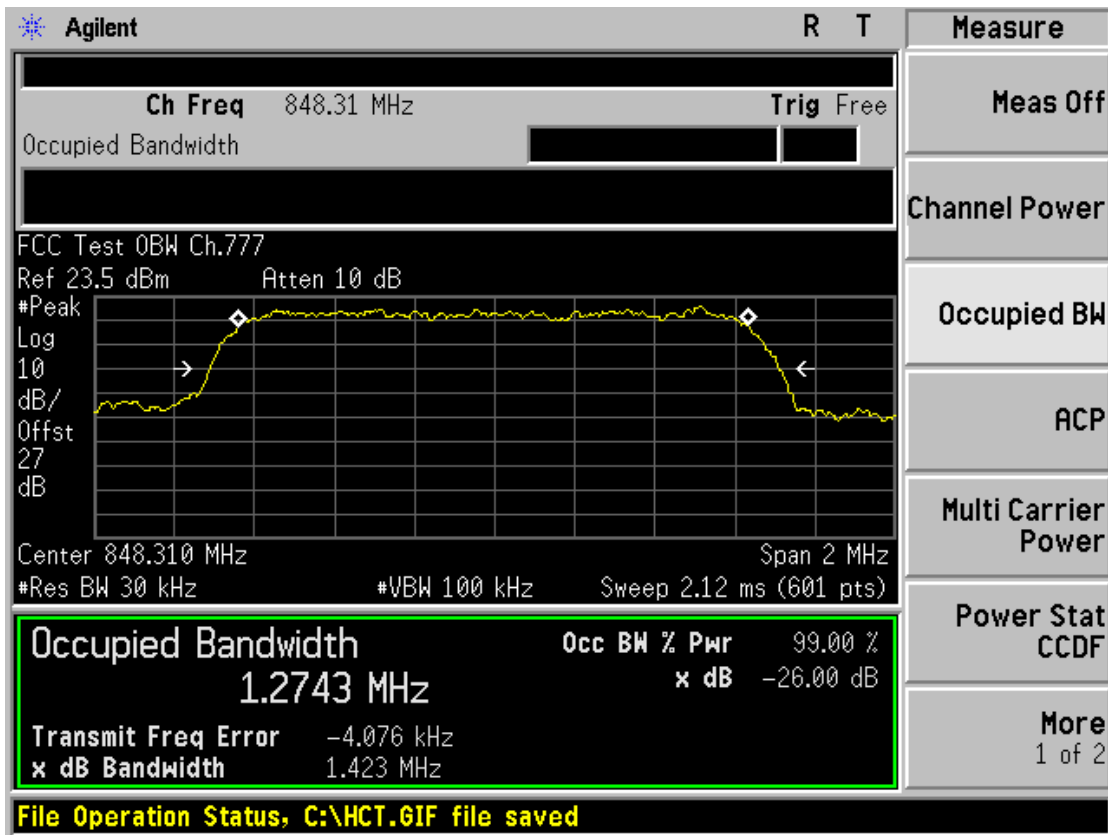

■ CDMA EVDO MODE (1013 CH.) Occupied Bandwidth

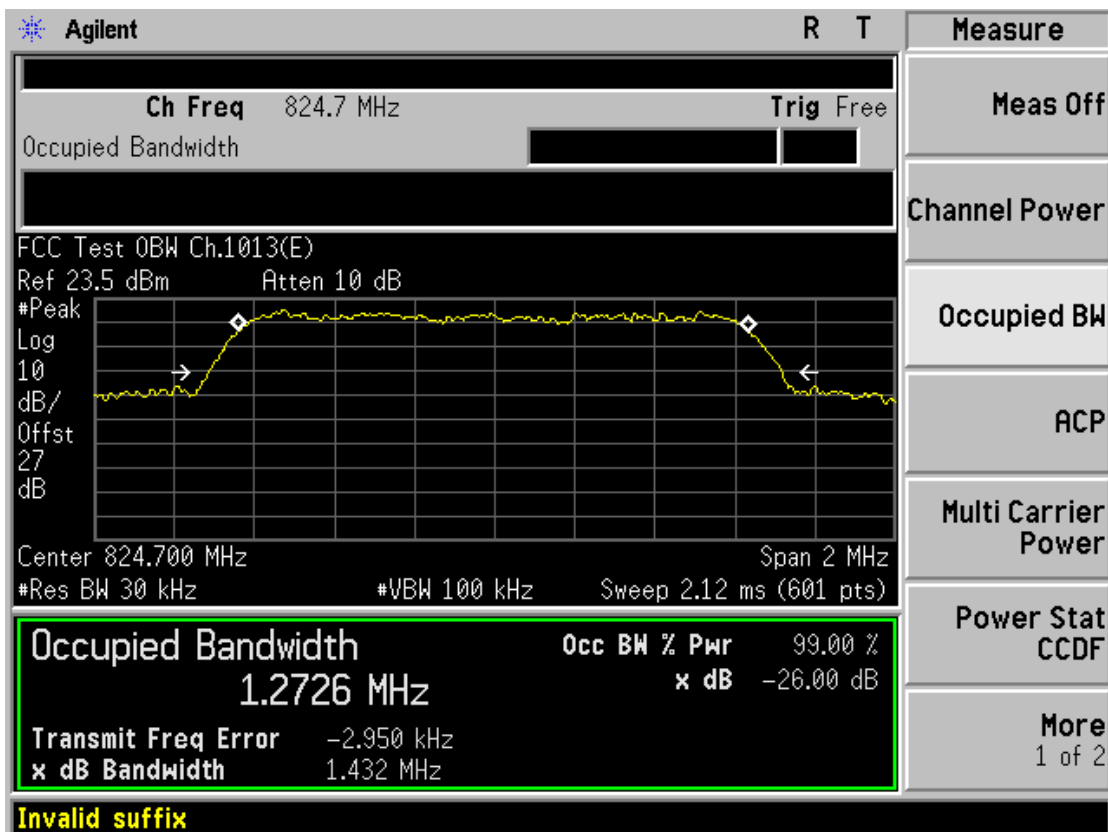



■ PCS CDMA MODE (25 CH.) Occupied Bandwidth

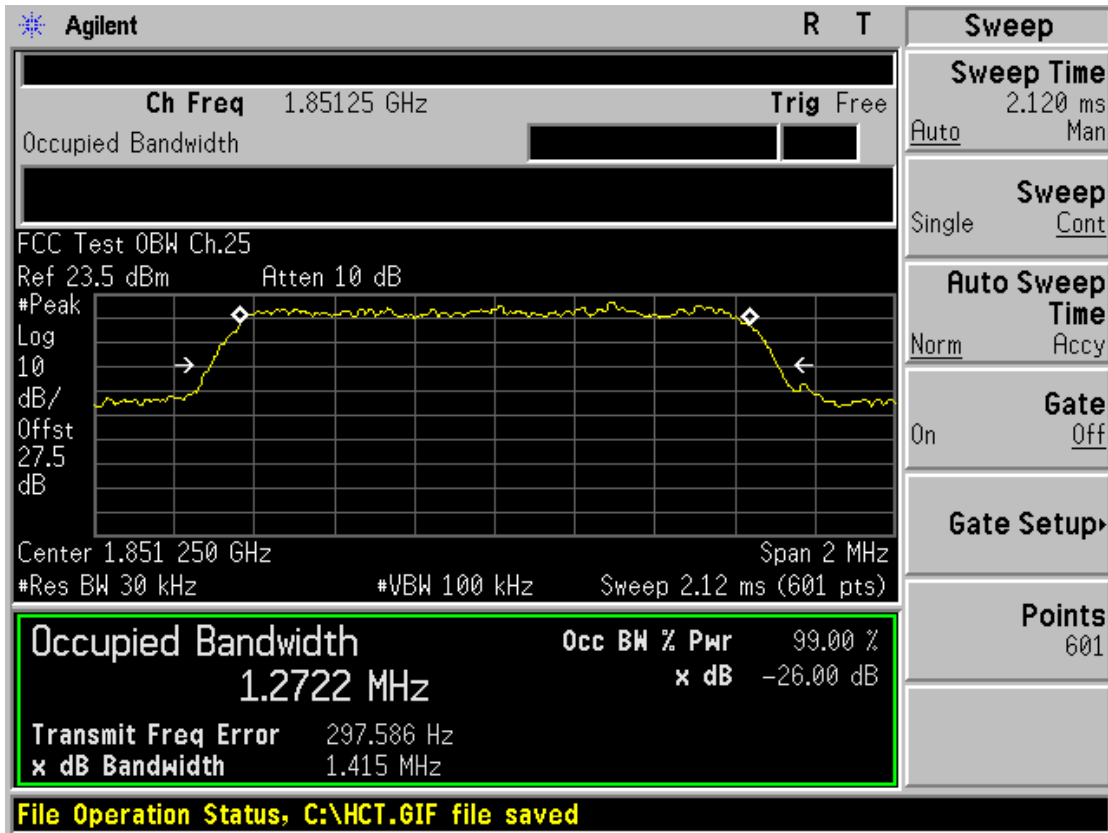

■ PCS CDMA MODE (600 CH.) Occupied Bandwidth

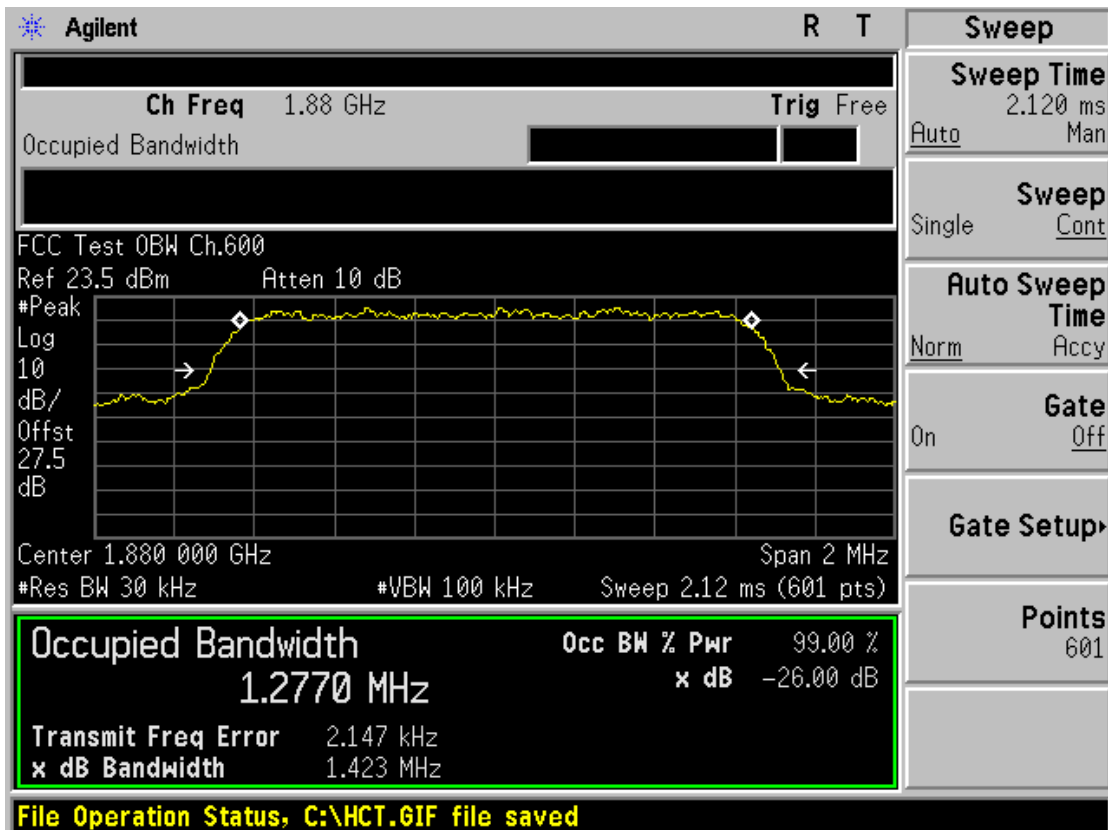



■ PCS CDMA MODE (1175 CH.) Occupied Bandwidth

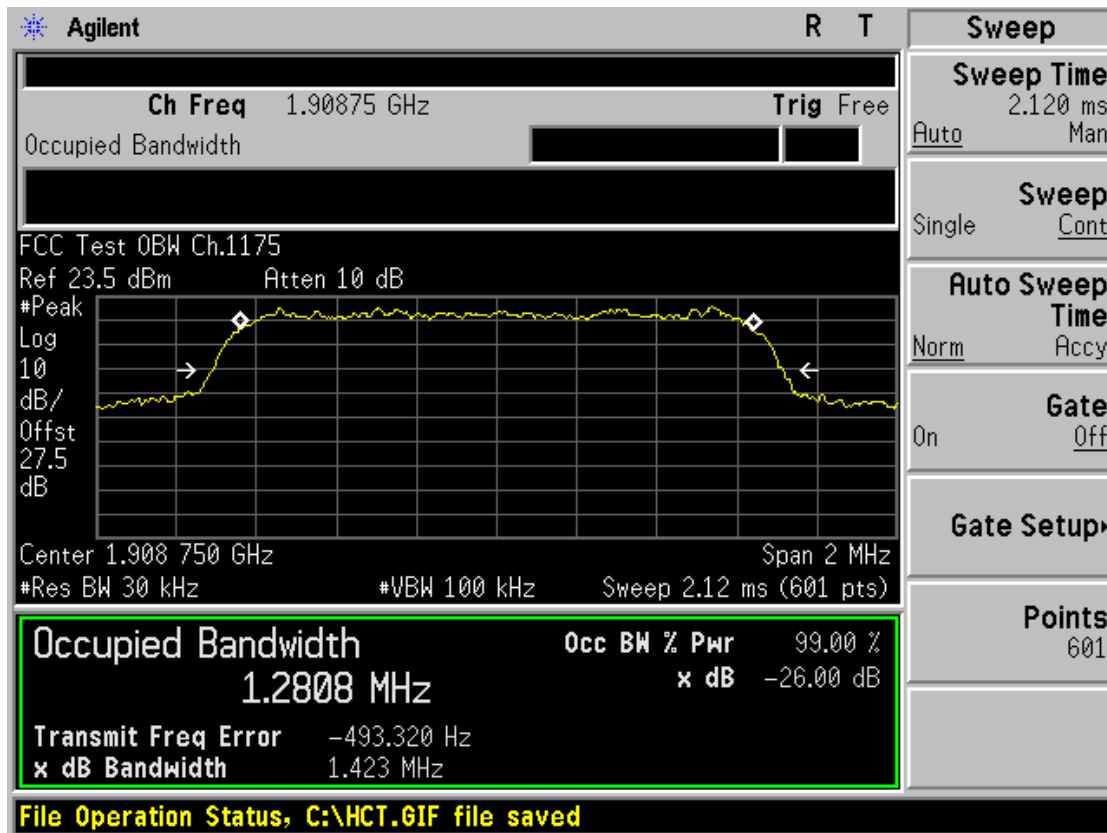

■ PCS CDMA EVDO MODE (1175 CH.) Occupied Bandwidth

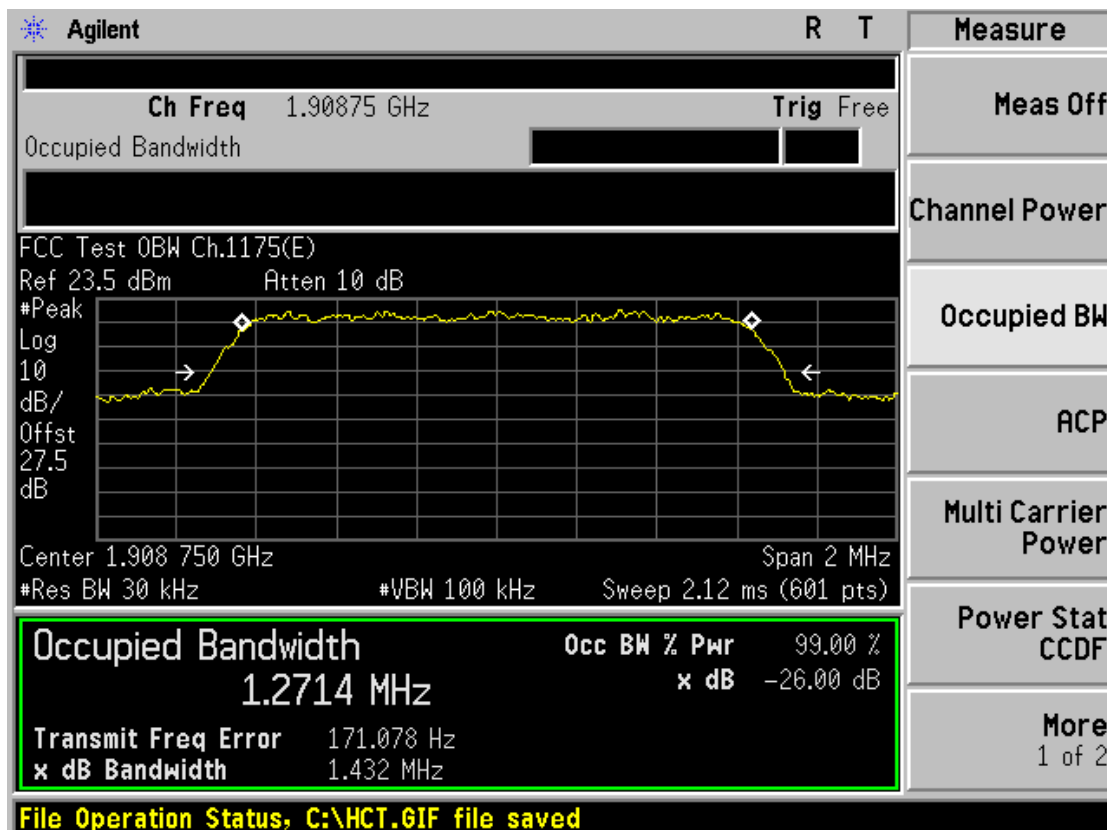

| FCC Class II Permissive Change Test Report | | | | www.hct.co.kr | |
|--|---------------------------------|---------------------------------------|----------------------|--|--|
| Test Report No. HCTR0912FR03 | Test Dates: December 9, 2009 | EUT Type: Dual-band CDMA USB Modem | FCC ID: PP4PX-800 | Page 2 6 of 41 | |

■ PCS CDMA MODE (600 CH.) Peak-to-Average Ratio

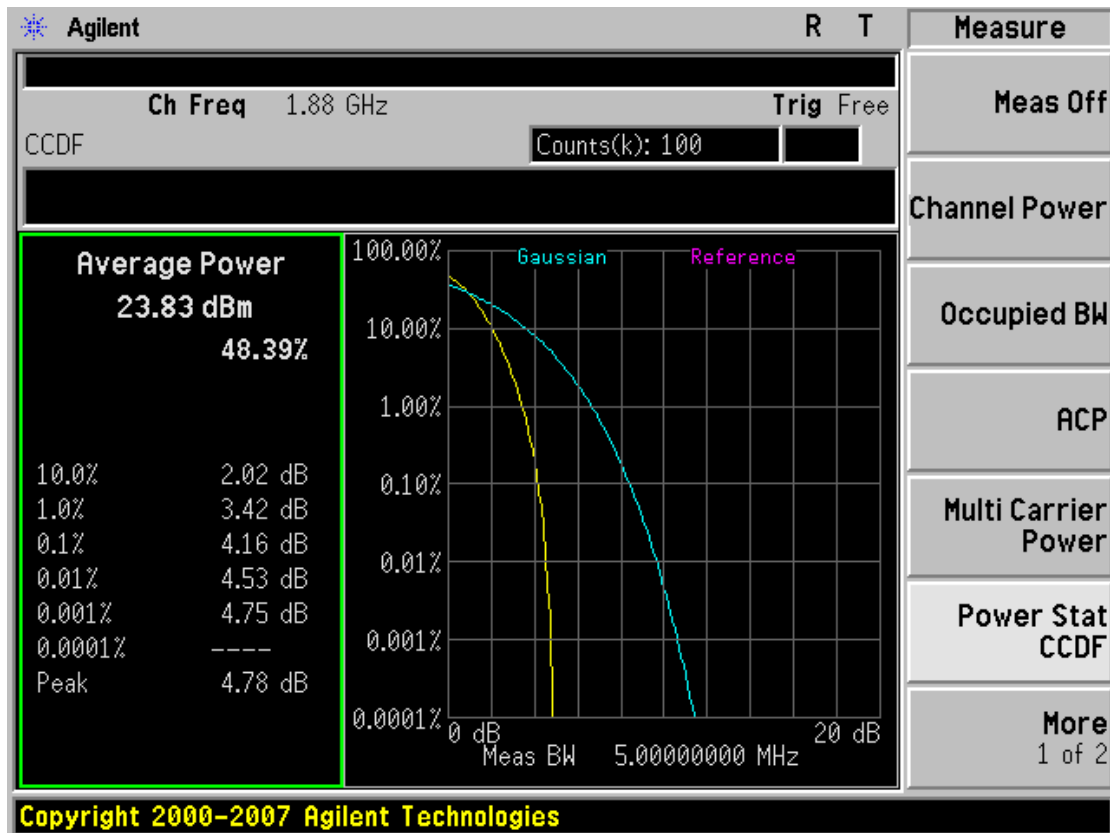

■ CDMA MODE (1013 CH.) Band Edge

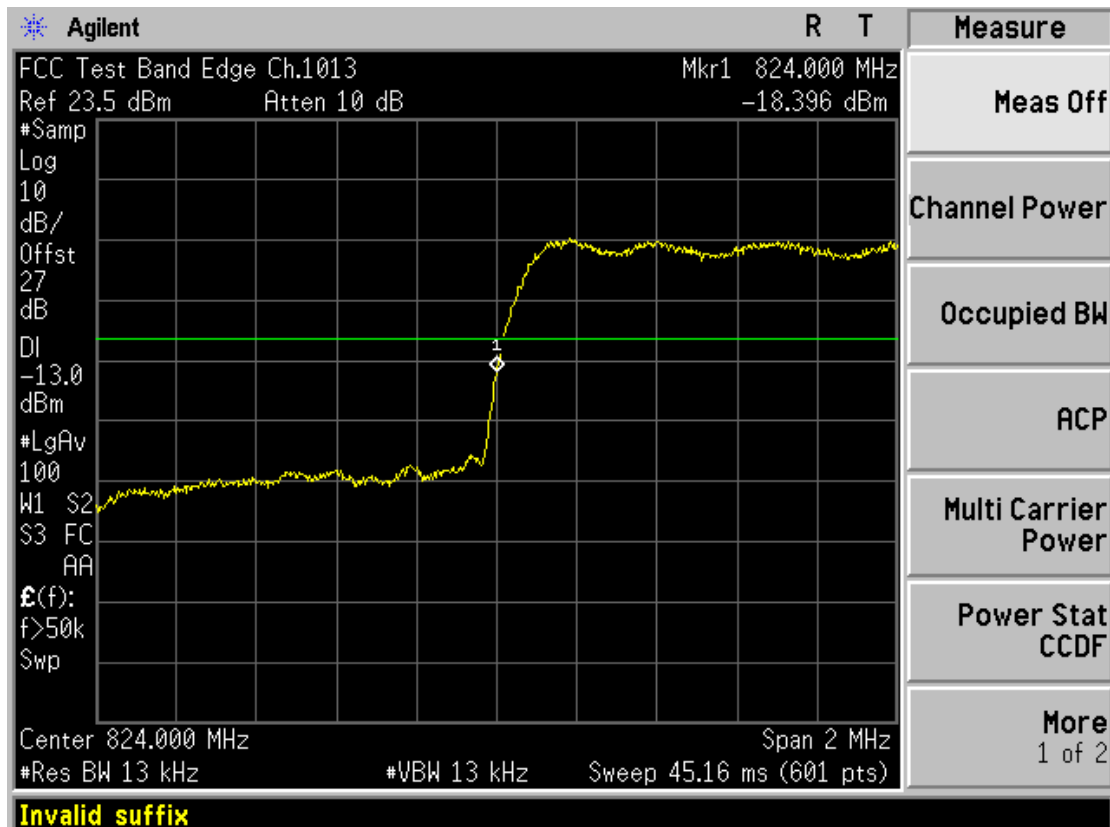

■ CDMA MODE (777 CH.) Band Edge

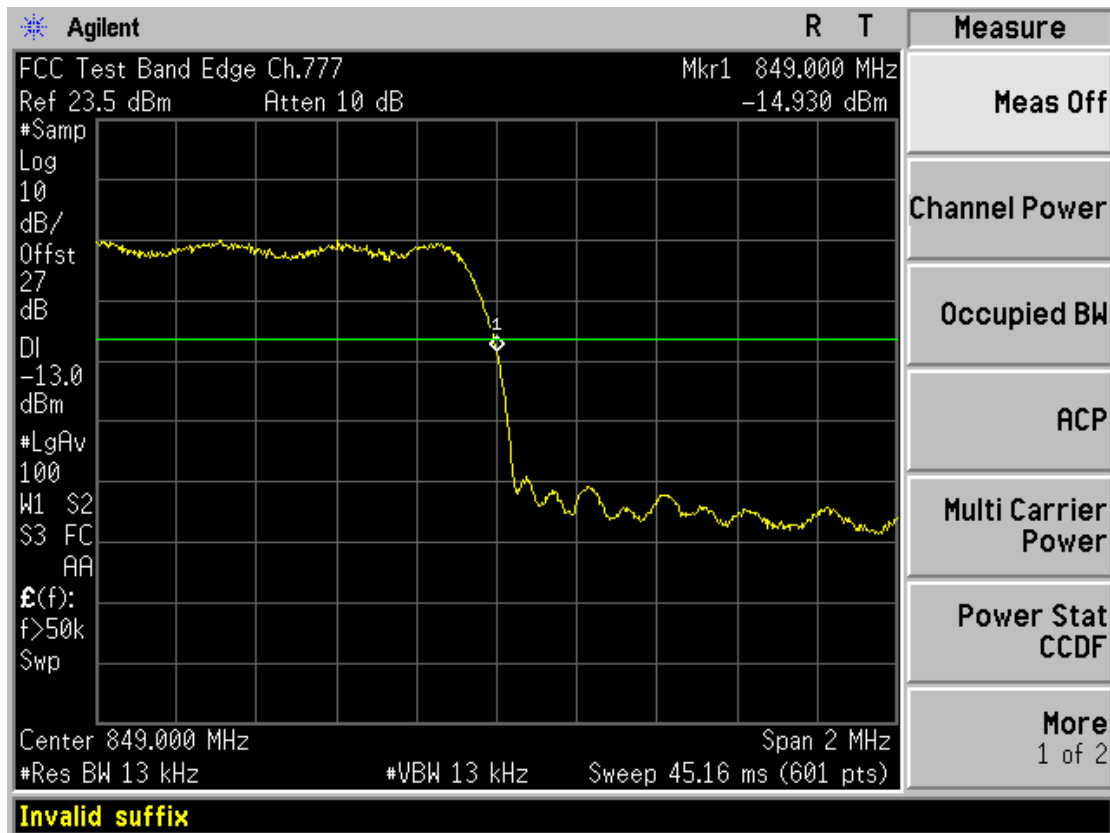

■ CDMA EVDO MODE (1013 CH.) Band Edge

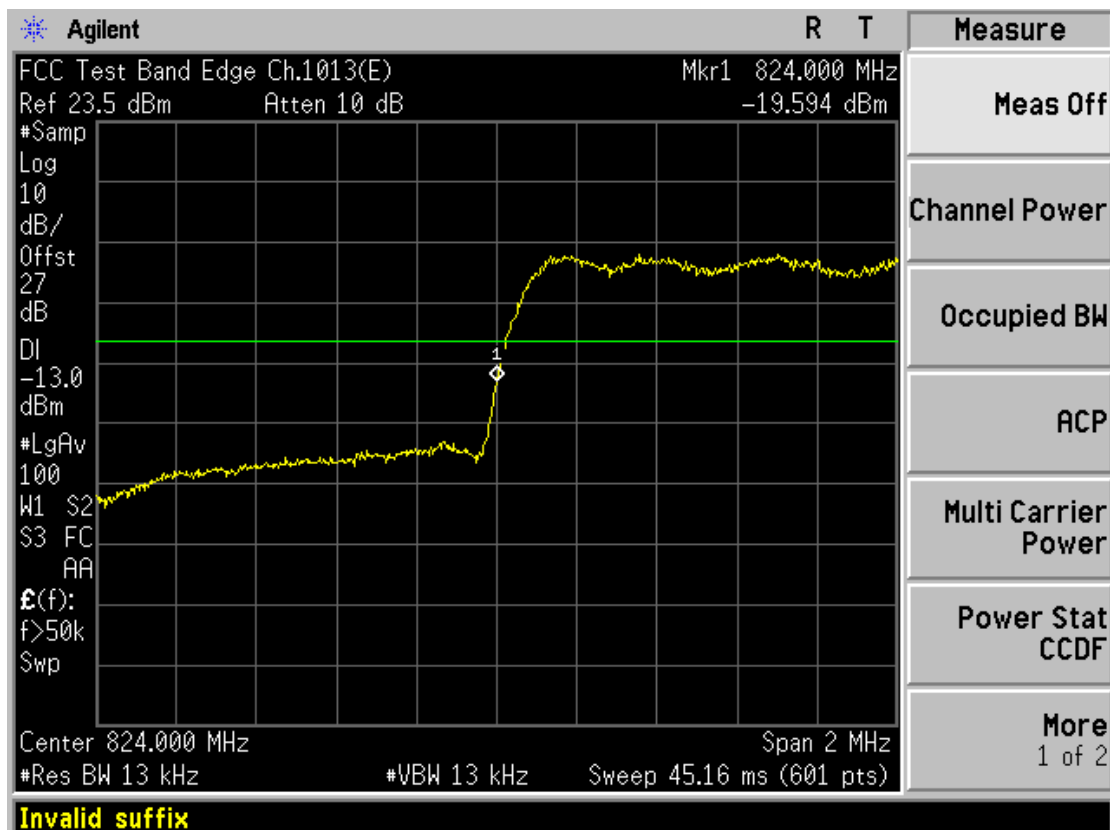

■ CDMA EVDO MODE (777 CH.) Band Edge

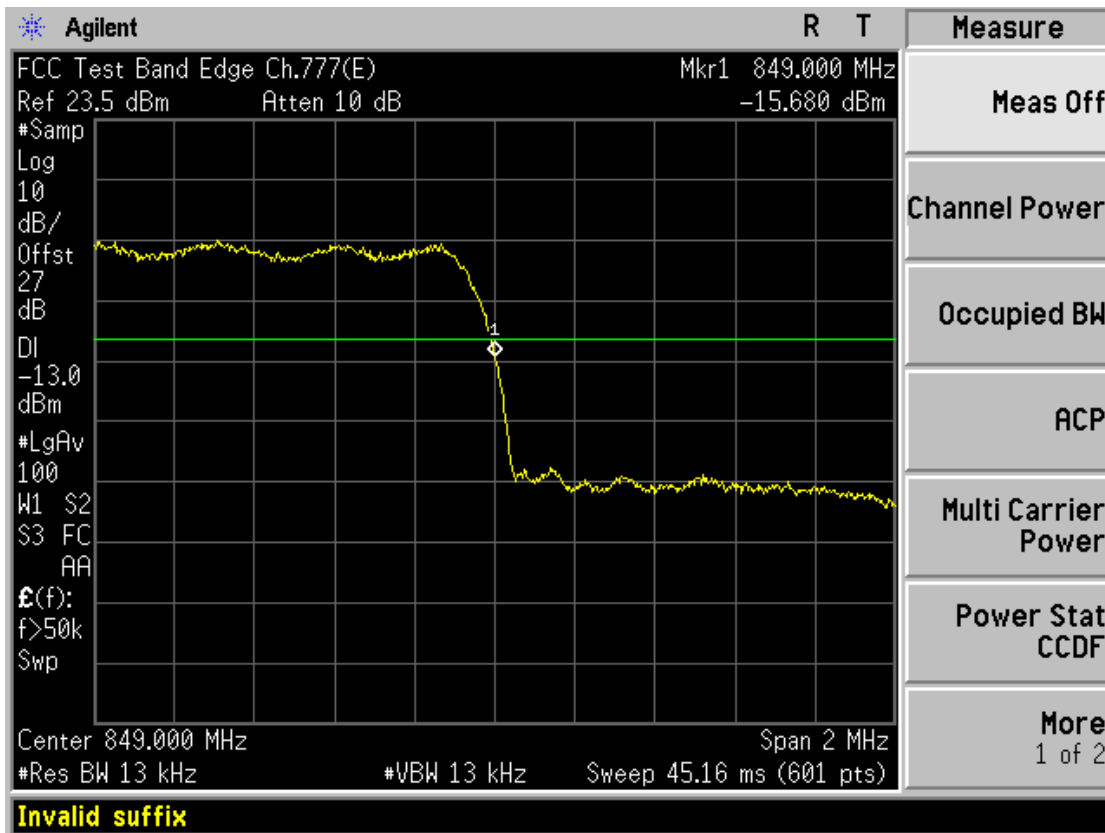

■ CDMA MODE (1013 CH.) 4 MHz Span

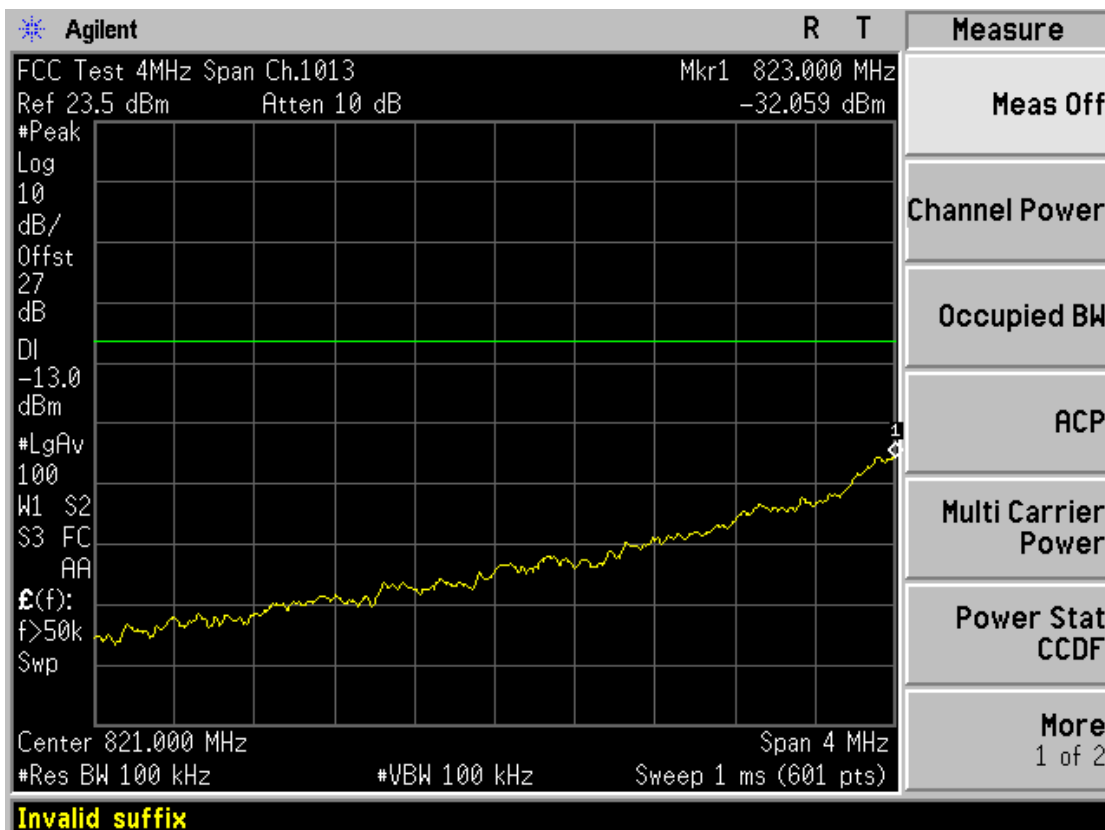



■ CDMA MODE (777 CH.) 4 MHz Span

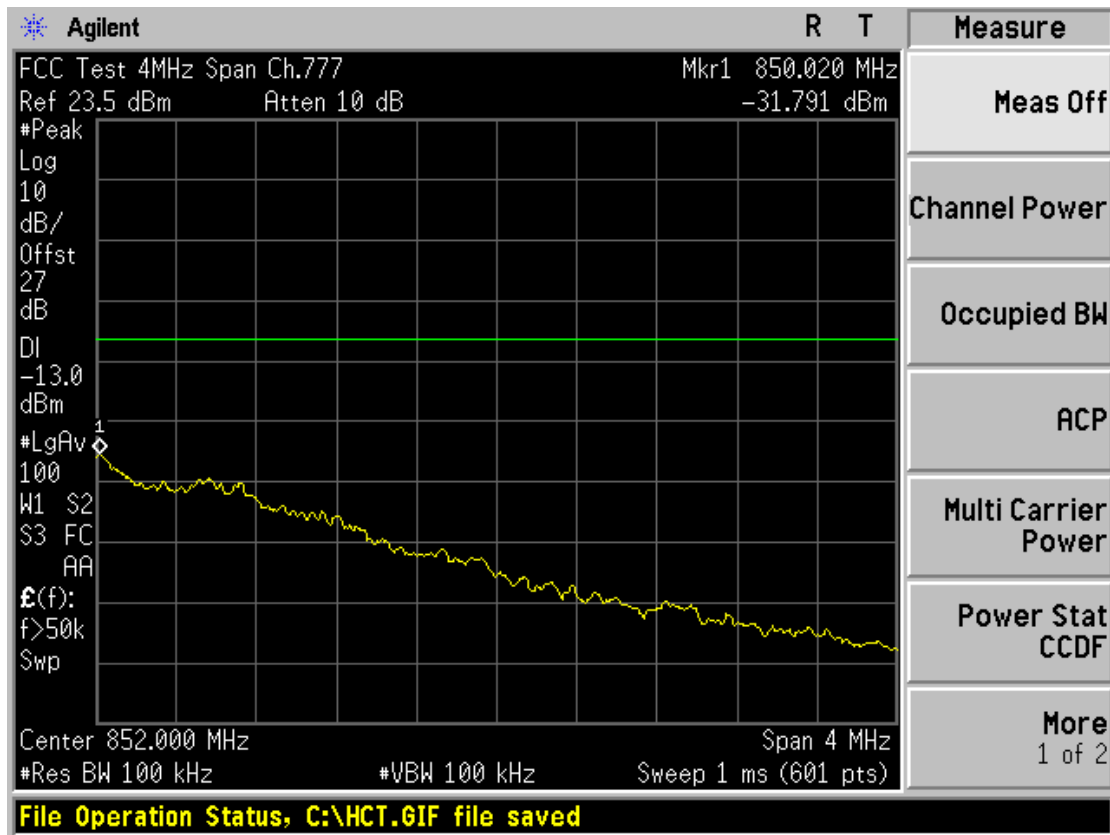

■ CDMA EVDO MODE (1013 CH.) 4 MHz Span

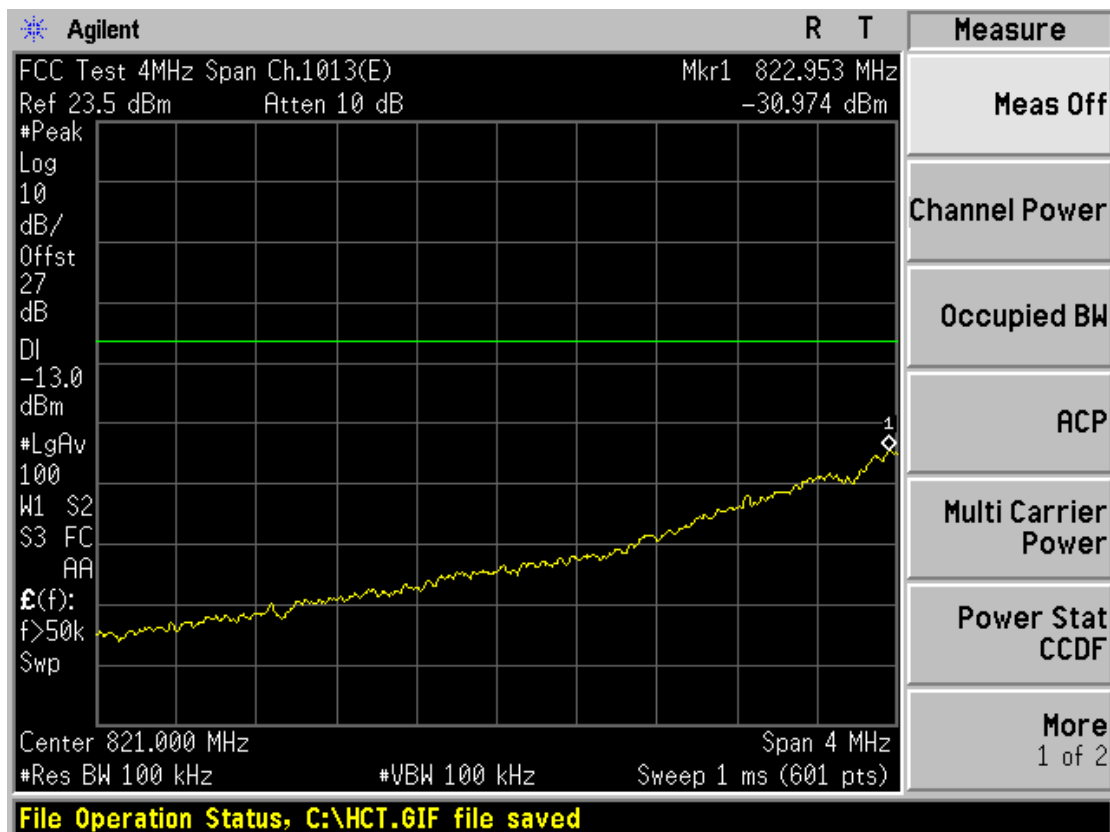



■ CDMA EVDO MODE (777 CH.) 4 MHz Span

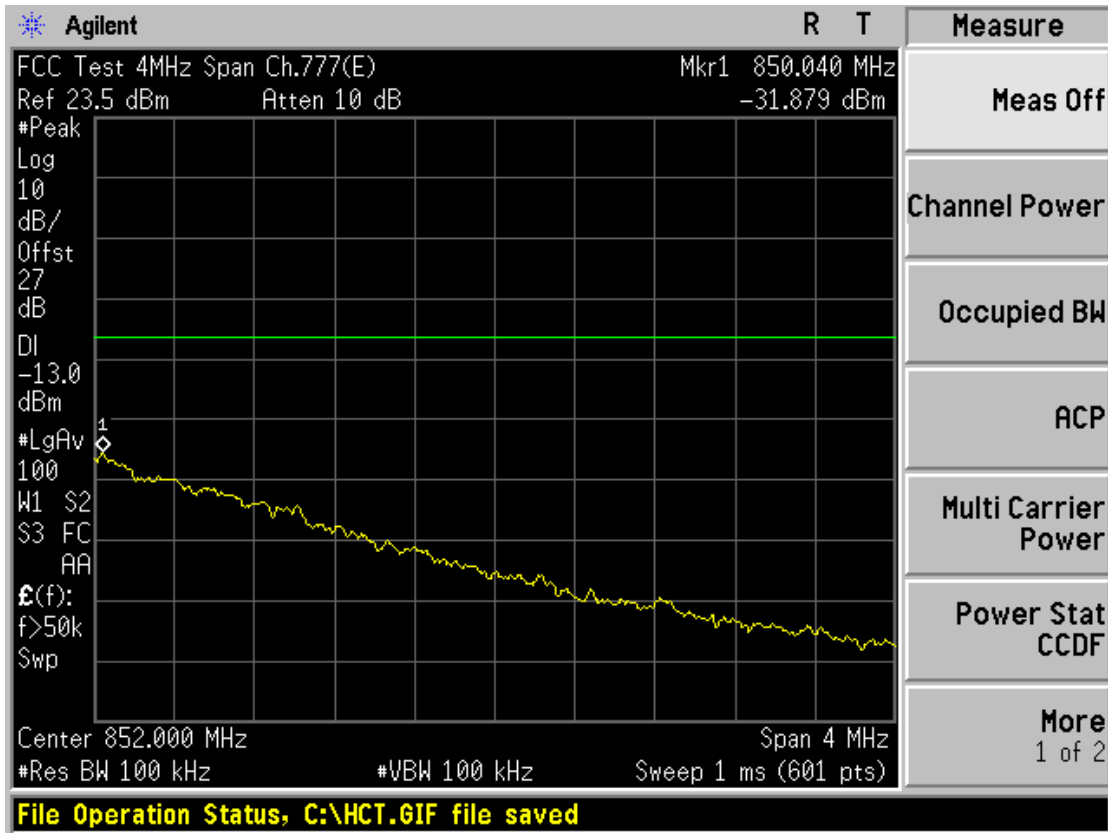

■ PCS CDMA MODE (25 CH.) Band Edge

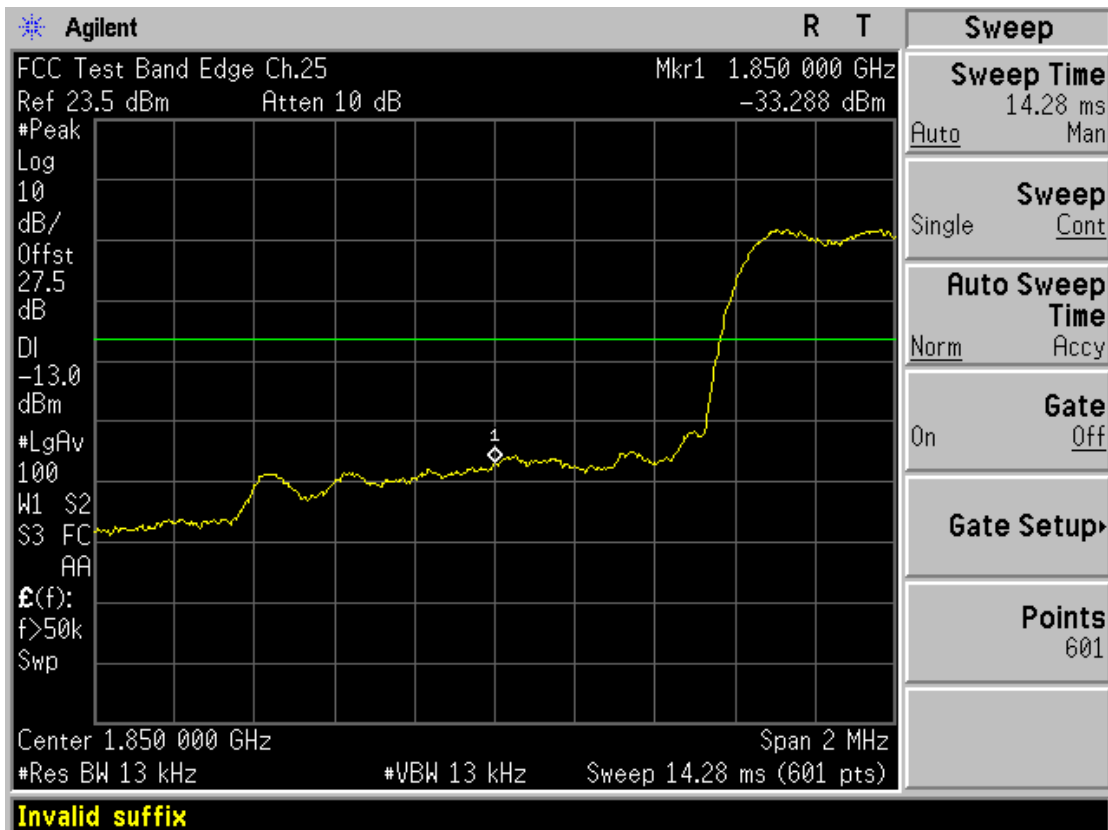

■ PCS CDMA MODE (1175 CH.) Band Edge

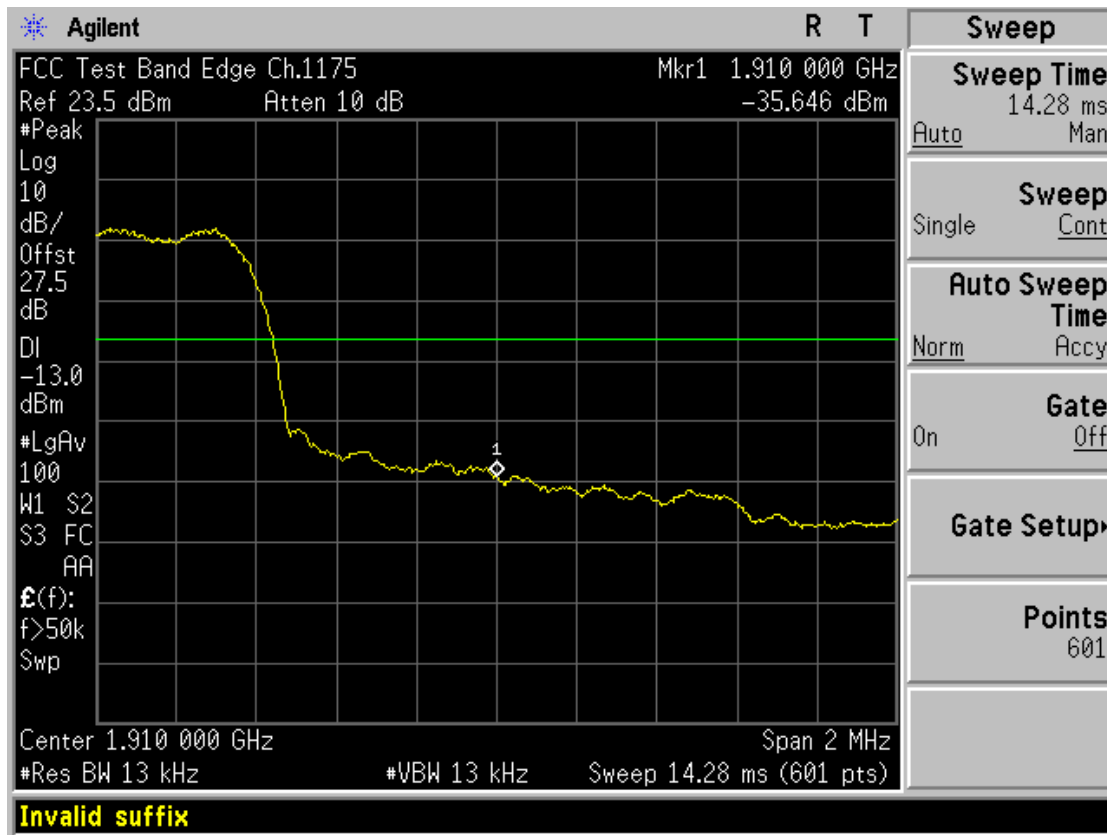

■ PCS CDMA EVDO MODE (25 CH.) Band Edge

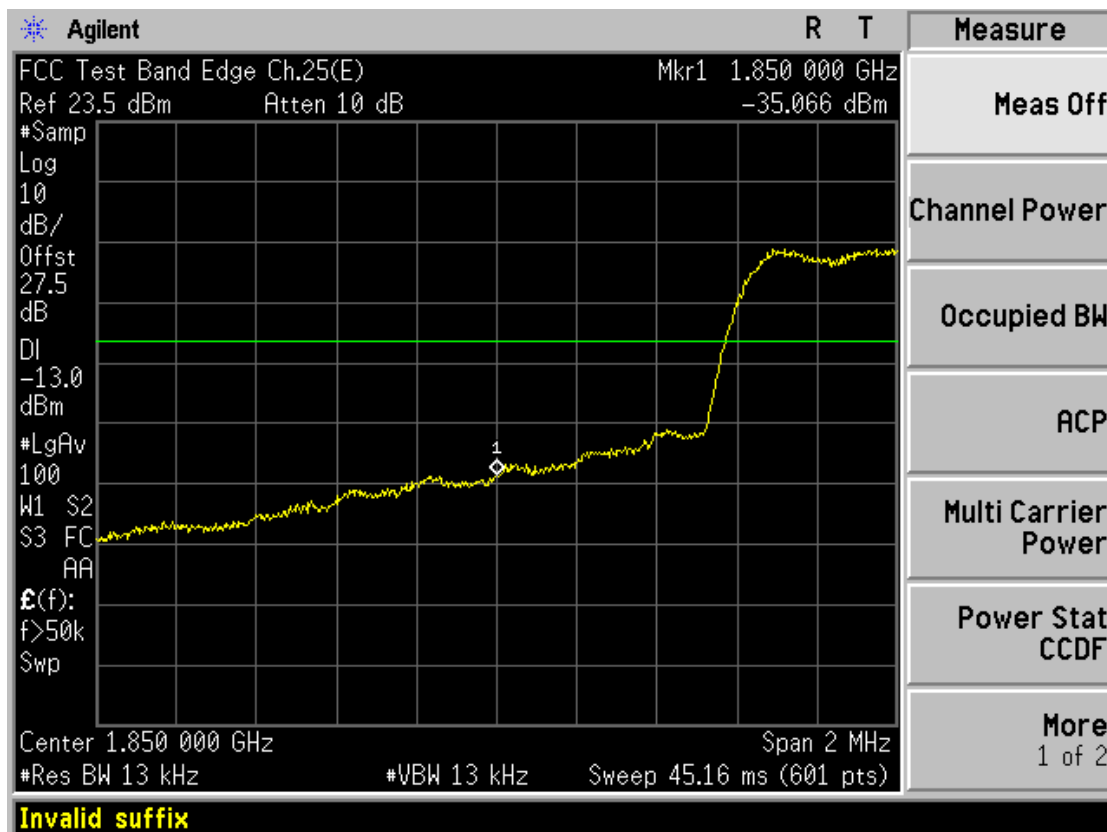

■ PCS CDMA EVDO MODE (1175 CH.) Band Edge

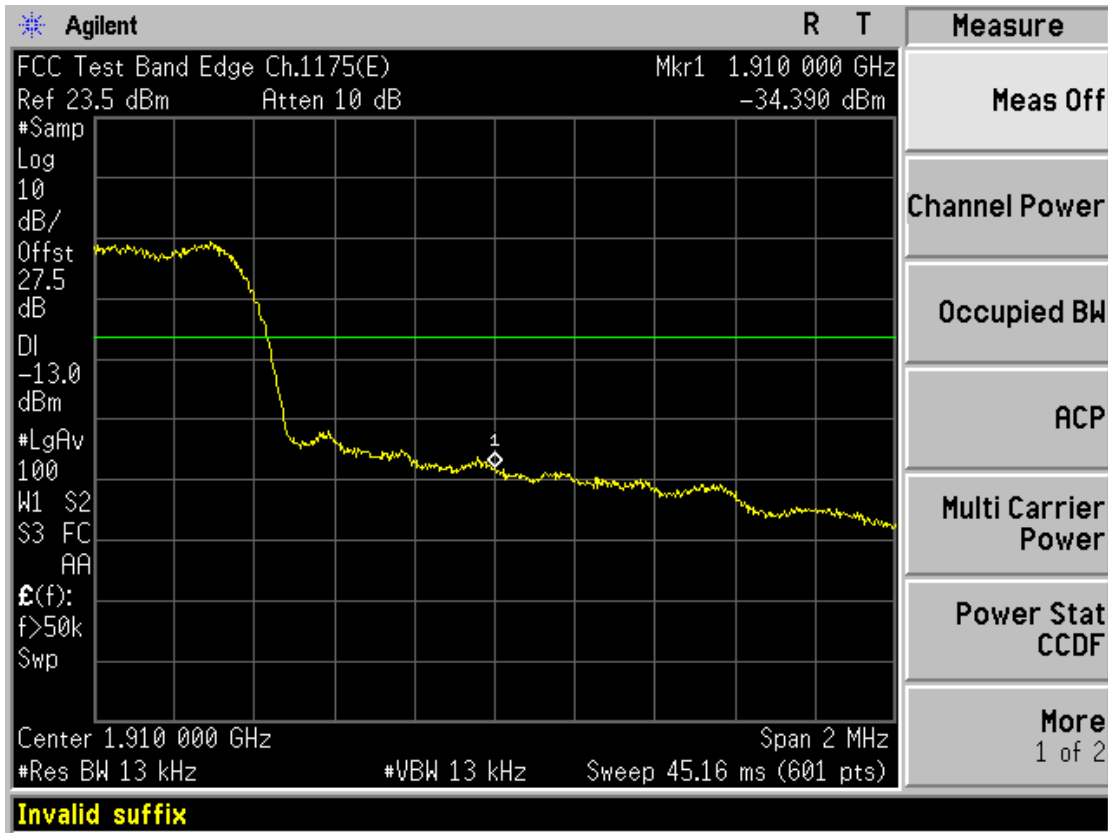

■ PCS CDMA MODE (25 CH.) 4 MHz Span

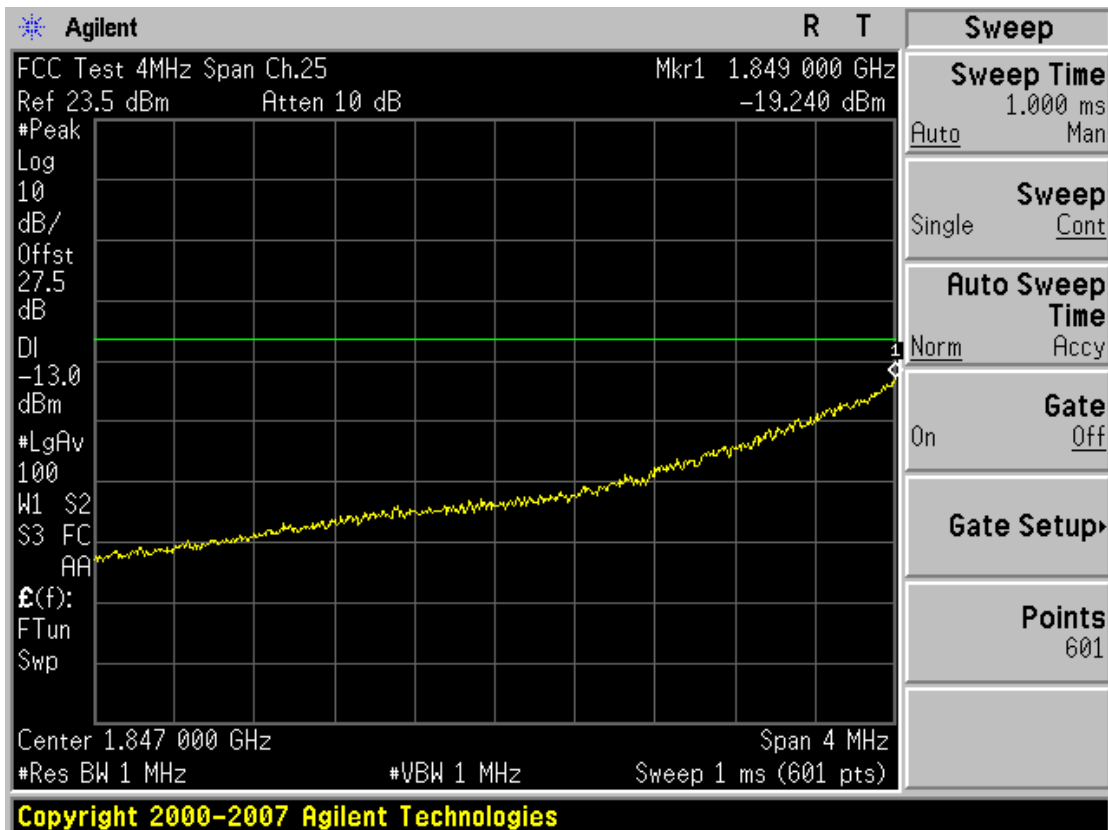



■ PCS CDMA MODE (1175 CH.) 4 MHz Span

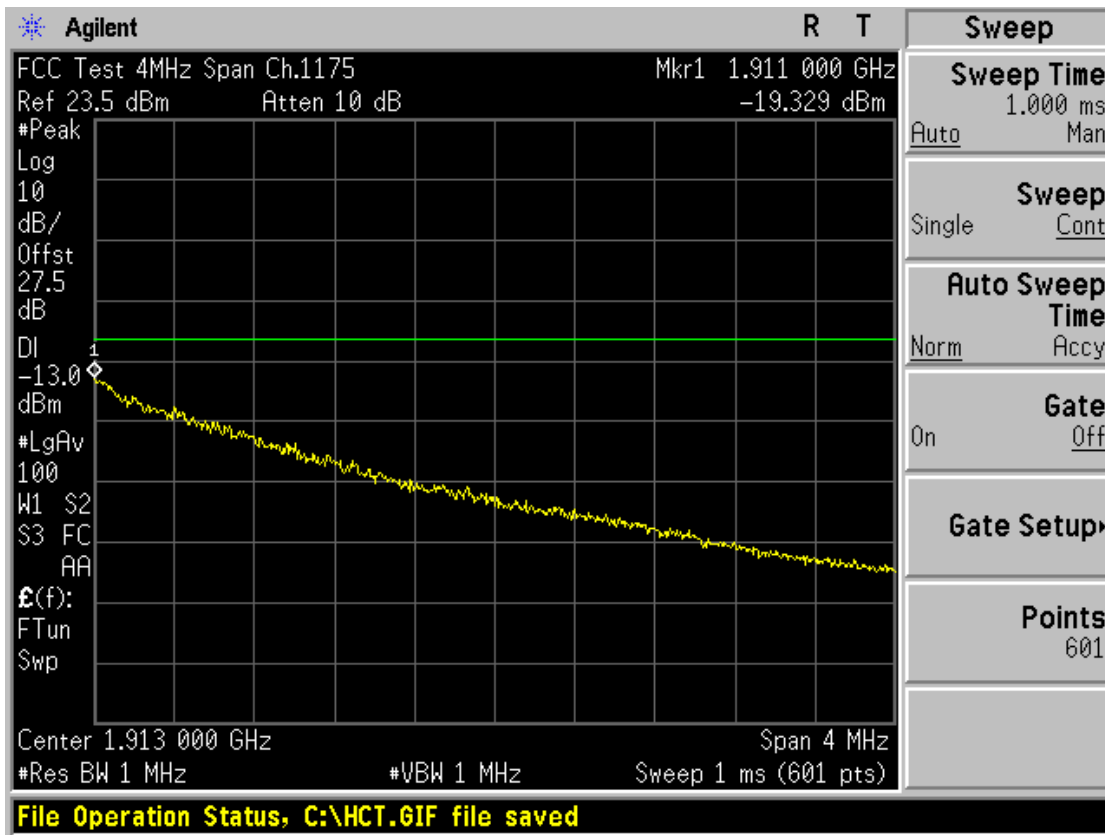

■ PCS CDMA EVDO MODE (25 CH.) 4 MHz Span

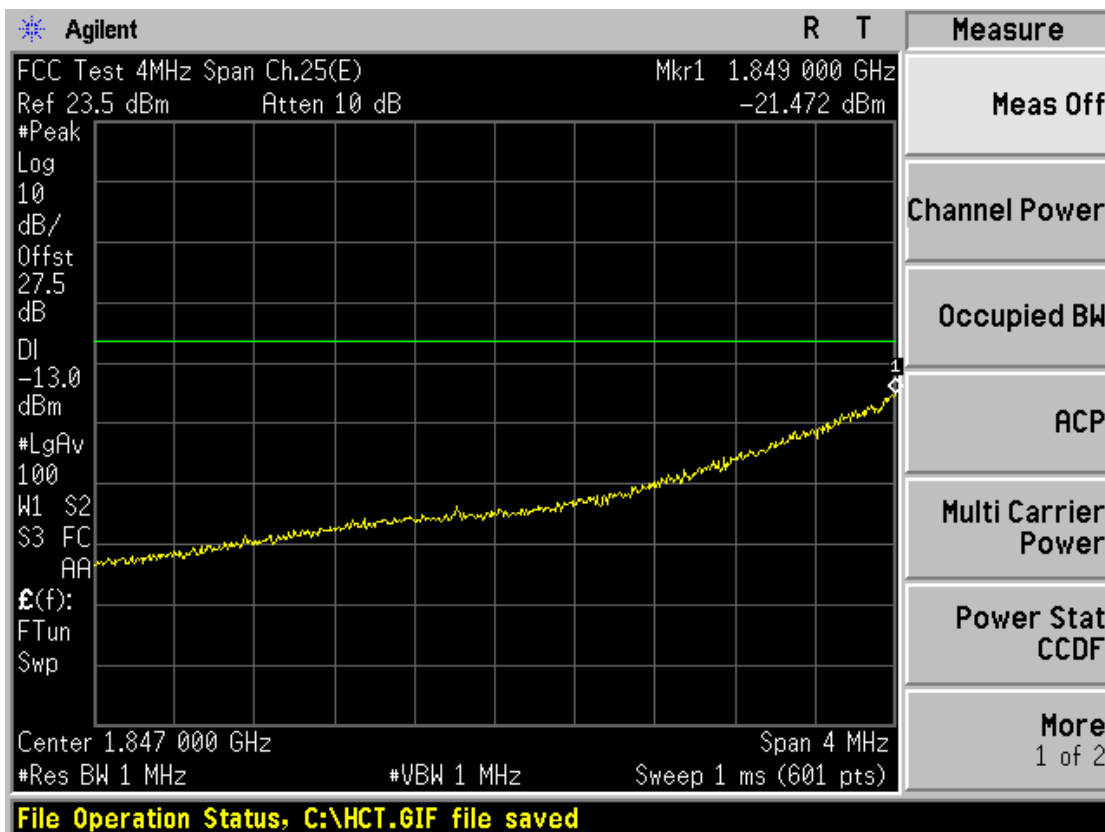



■ PCS CDMA EVDO MODE (1175 CH.) 4 MHz Span

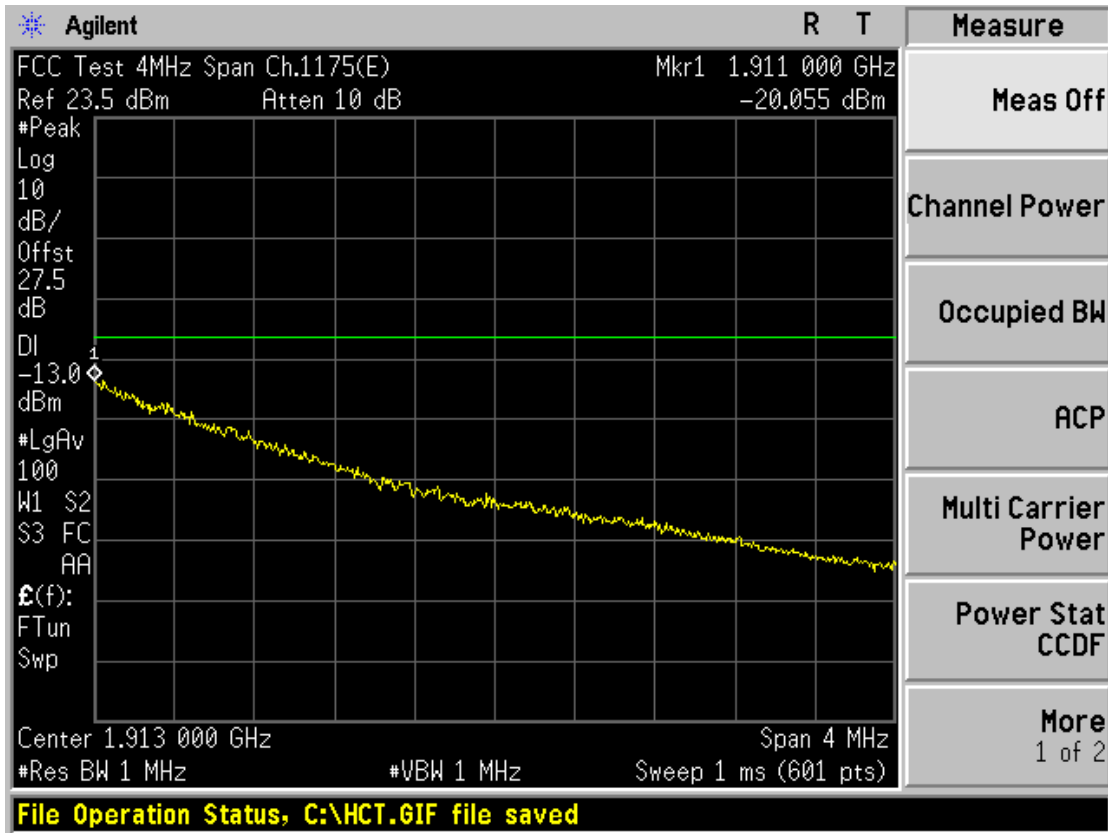

■ CDMA MODE (1013 CH.) Conducted Spurious Emissions - 1

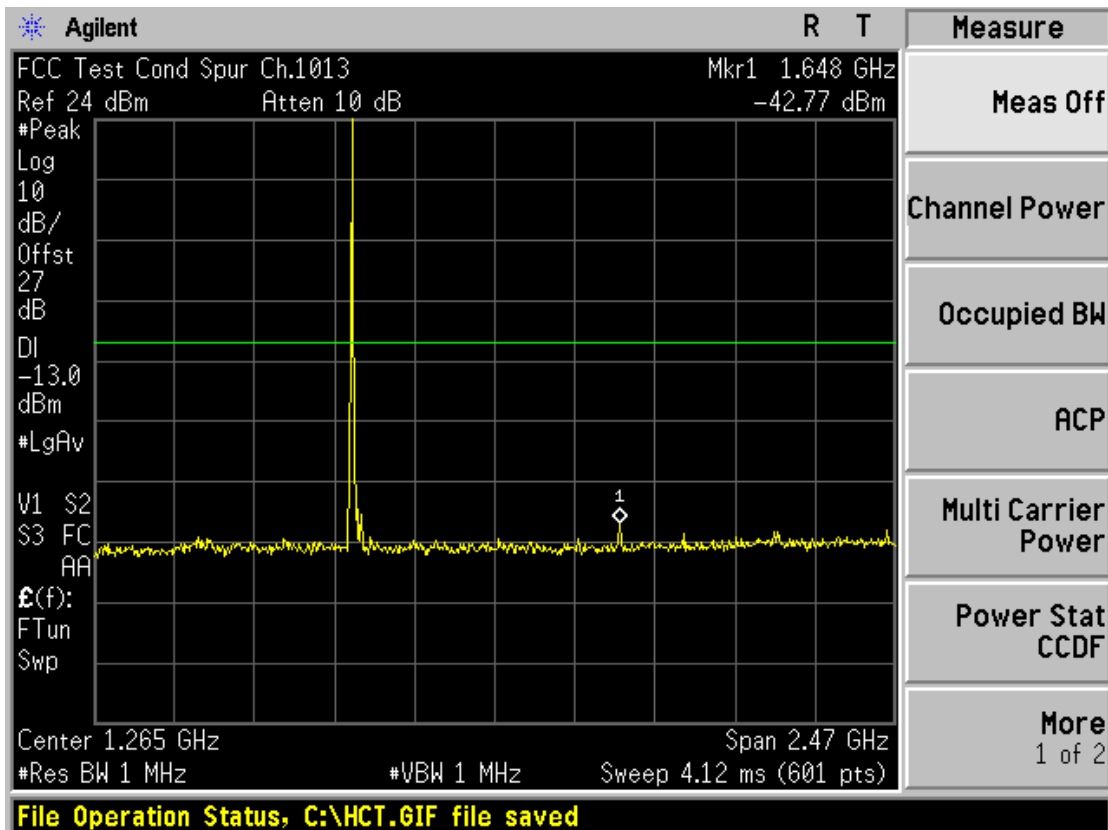



■ CDMA MODE (1013 CH.) Conducted Spurious Emissions - 2

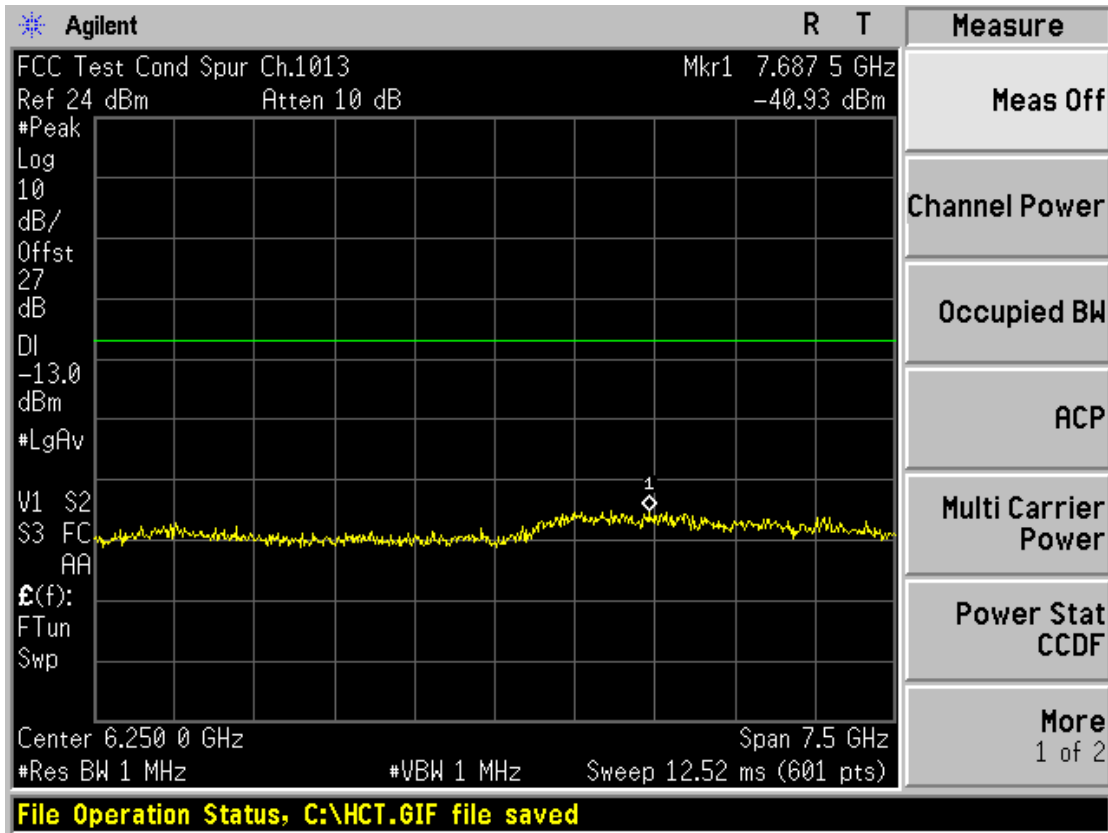

■ CDMA MODE (384 CH.) Conducted Spurious Emissions - 1

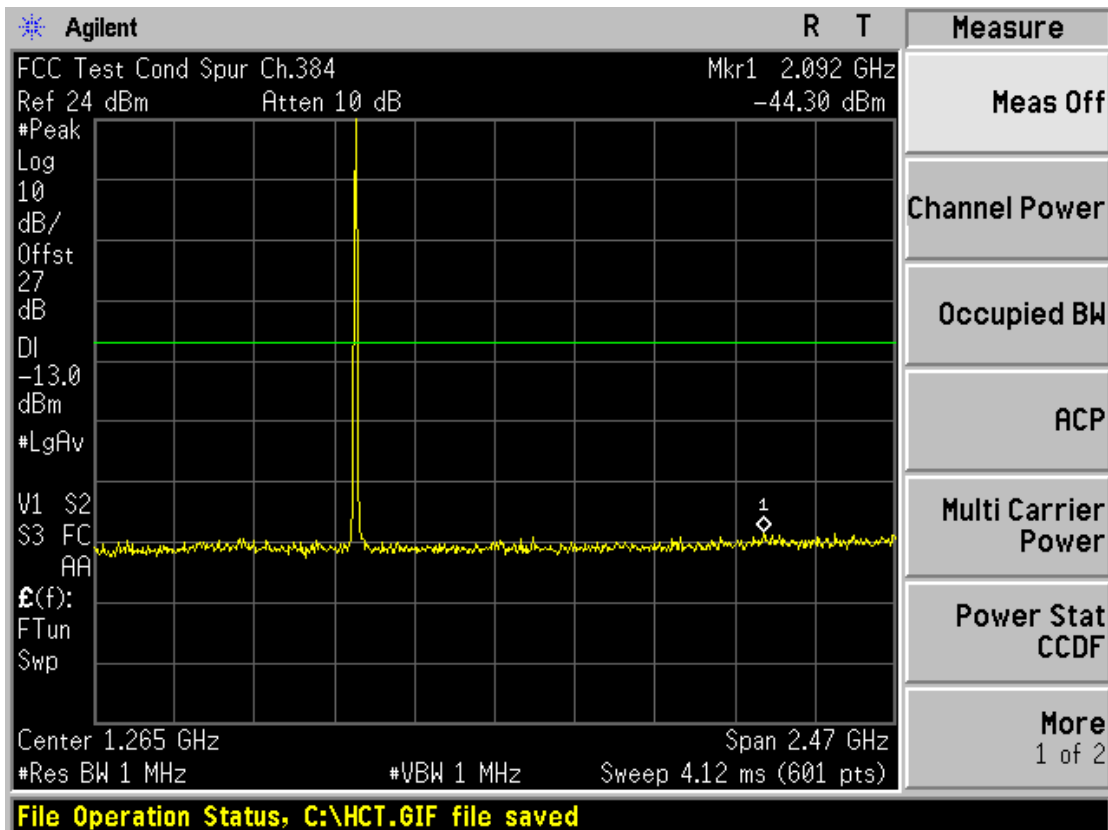



■ CDMA MODE (384 CH.) Conducted Spurious Emissions - 2

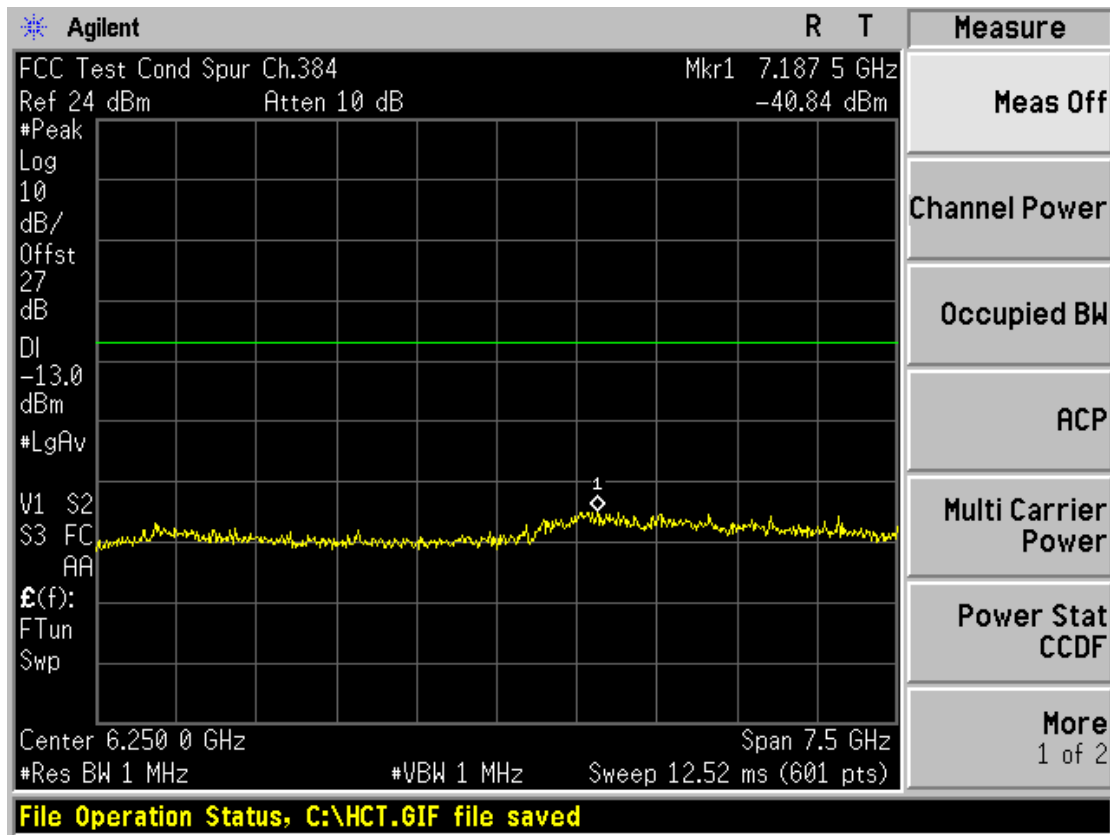

■ CDMA MODE (777 CH.) Conducted Spurious Emissions - 1

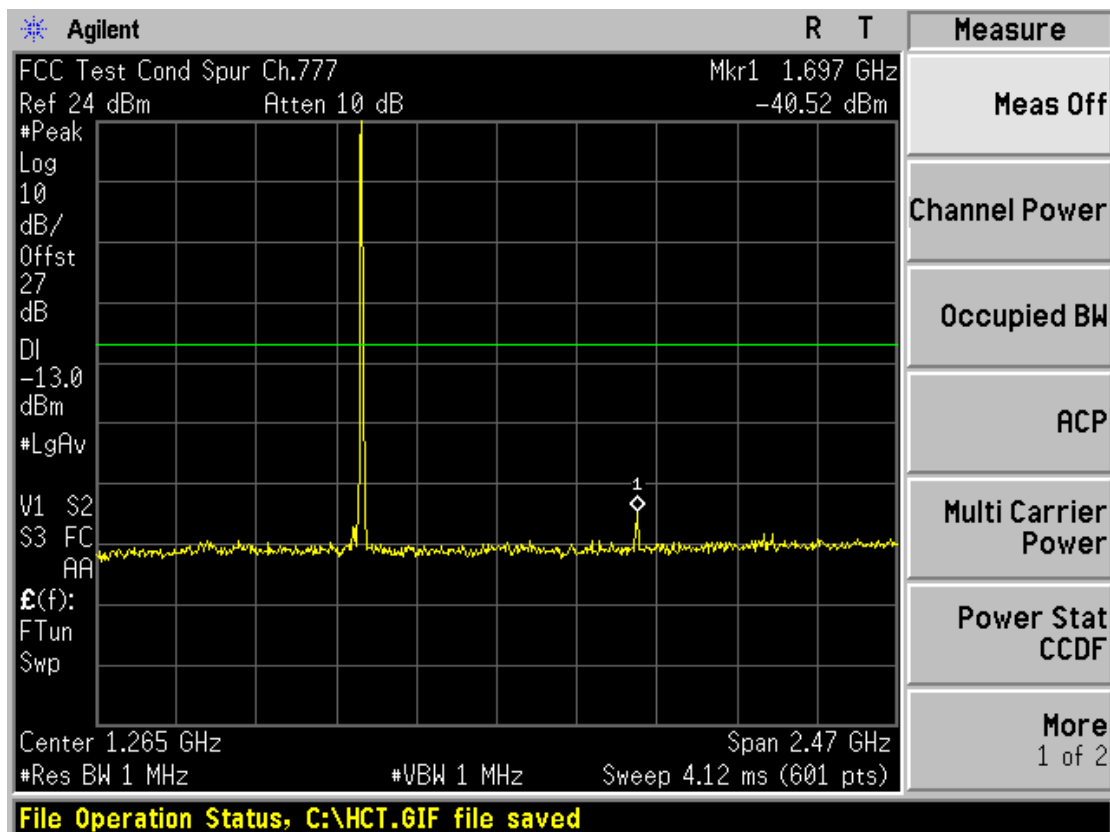

■ CDMA MODE (777 CH.) Conducted Spurious Emissions - 2

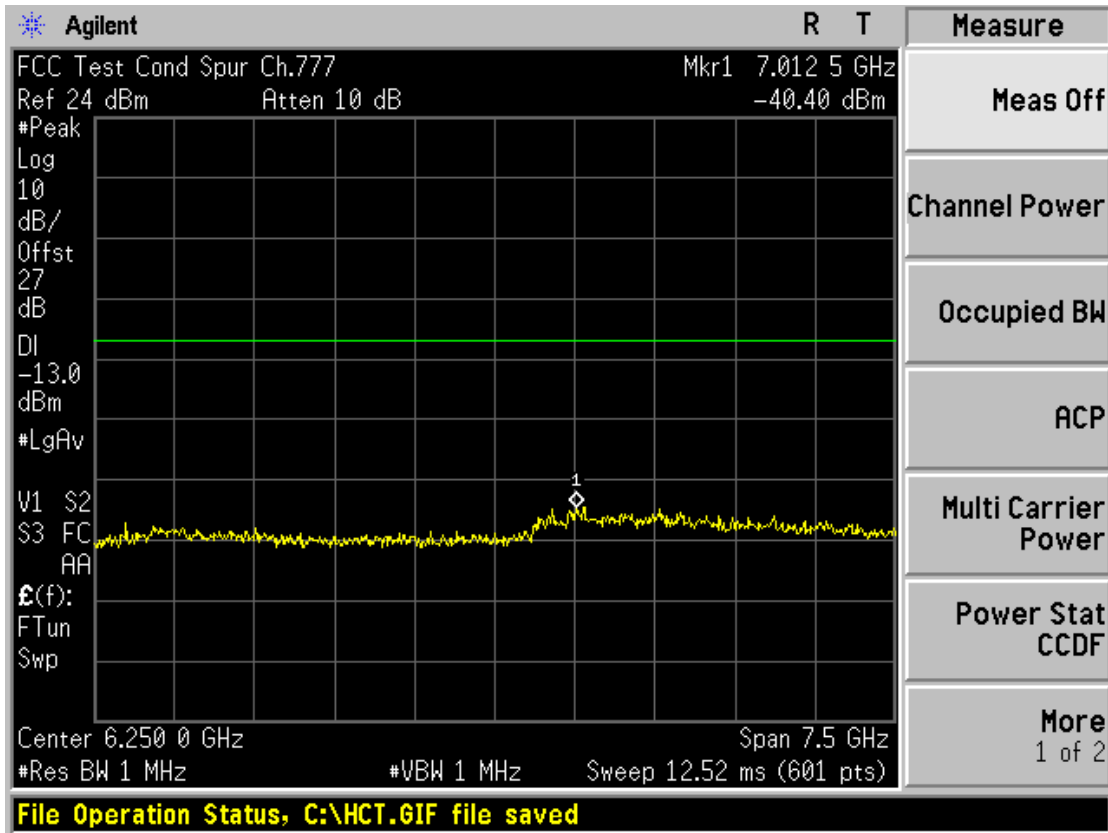

■ PCS CDMA MODE (25 CH.) Conducted Spurious Emissions - 1

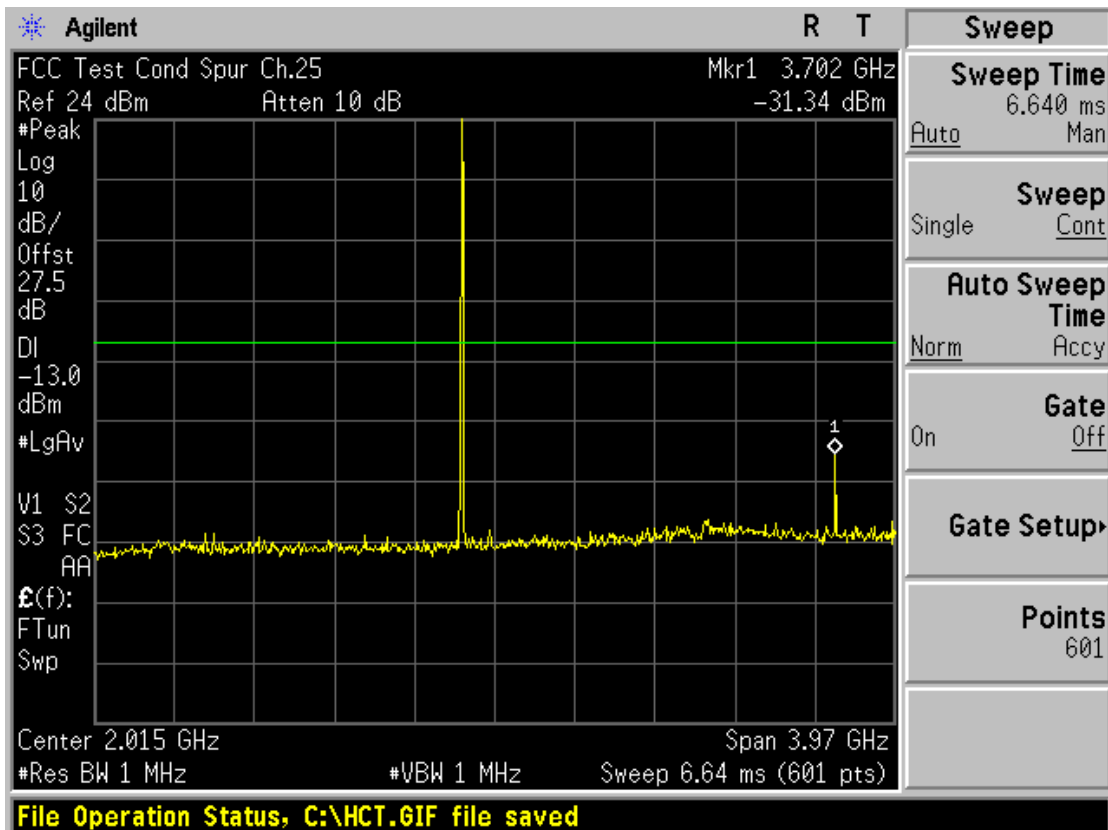

■ PCS CDMA MODE (25 CH.) Conducted Spurious Emissions - 2

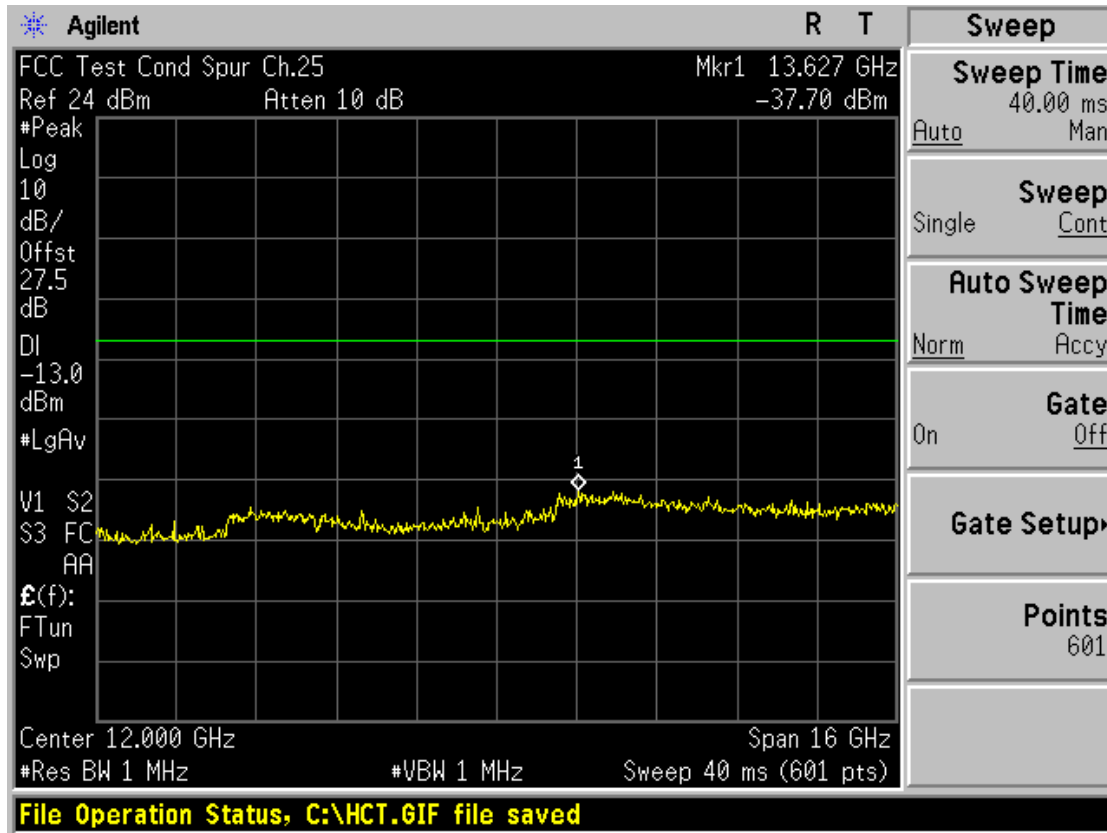

■ PCS CDMA MODE (600 CH.) Conducted Spurious Emissions - 1

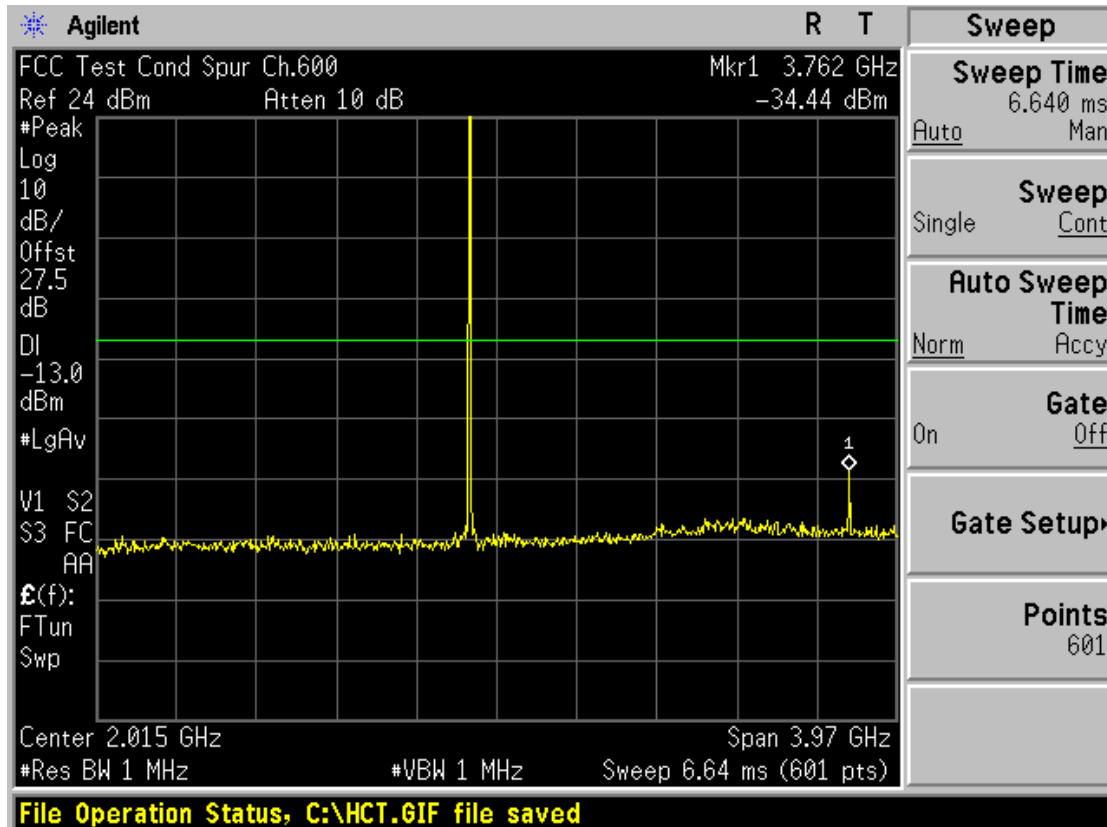



■ PCS CDMA MODE (600 CH.) Conducted Spurious Emissions - 2

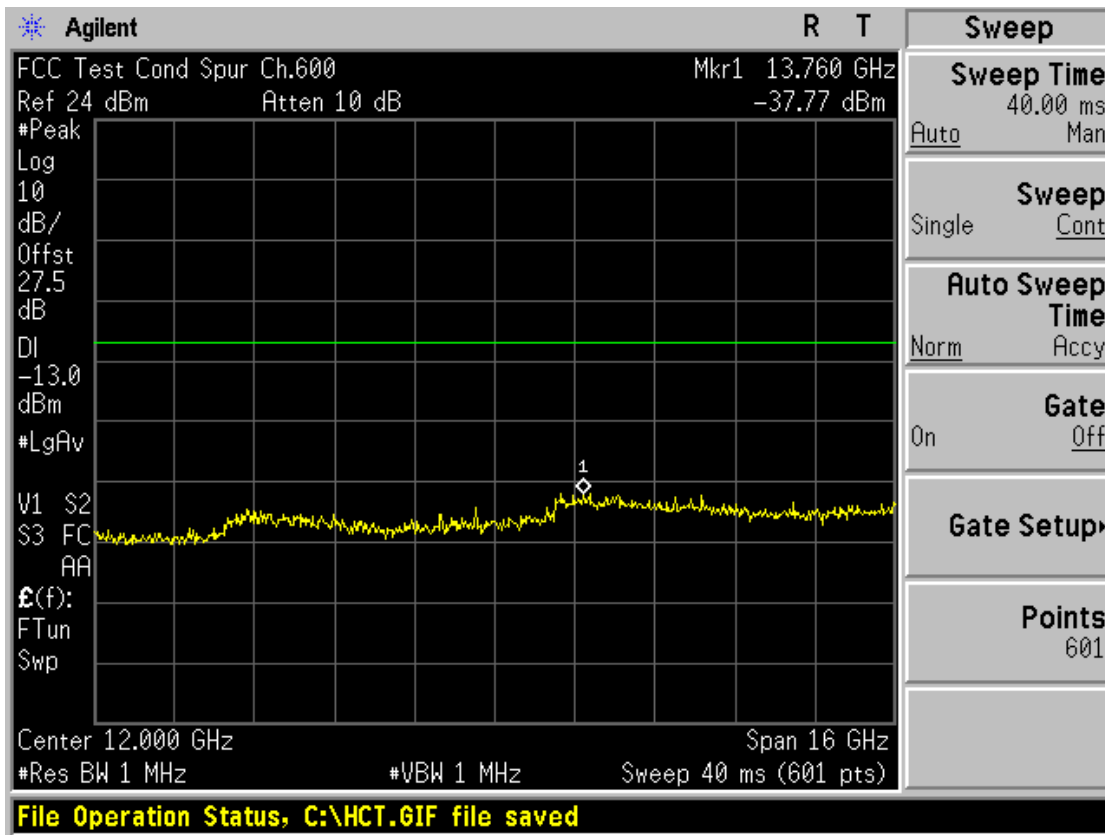

■ PCS CDMA MODE (1175 CH.) Conducted Spurious Emissions - 1

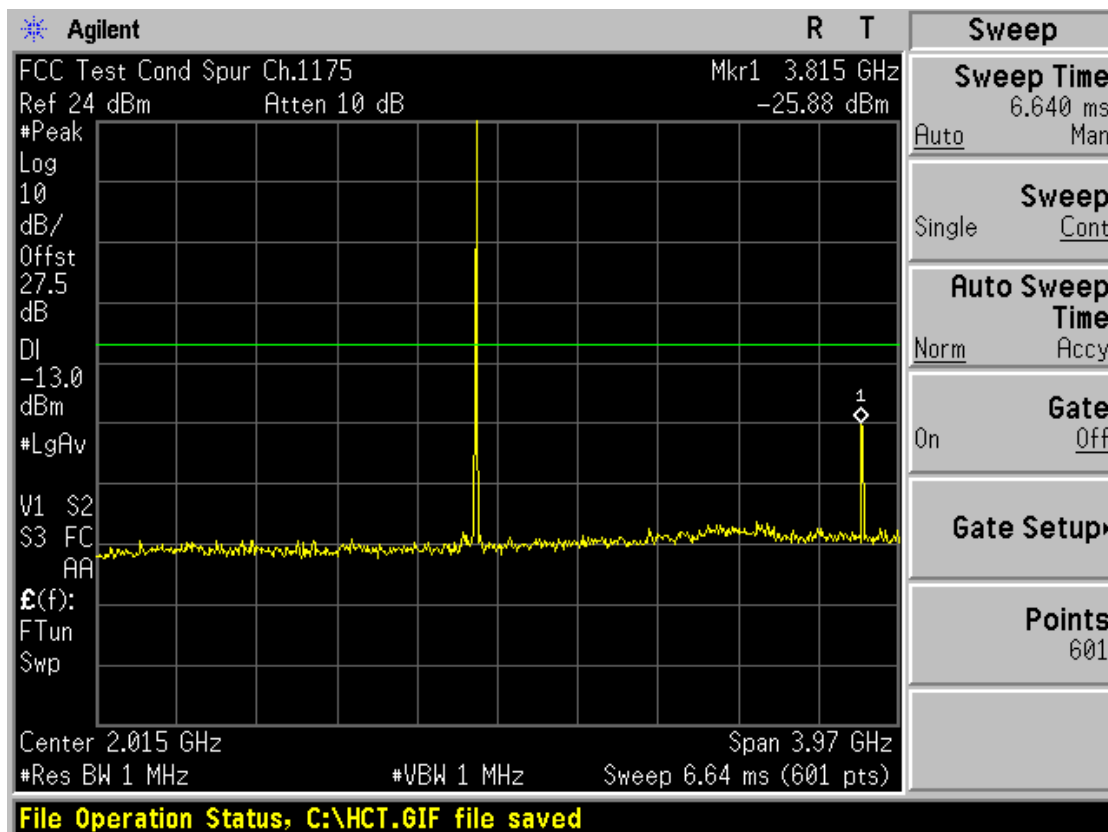



■ PCS CDMA MODE (1175 CH.) Conducted Spurious Emissions - 2

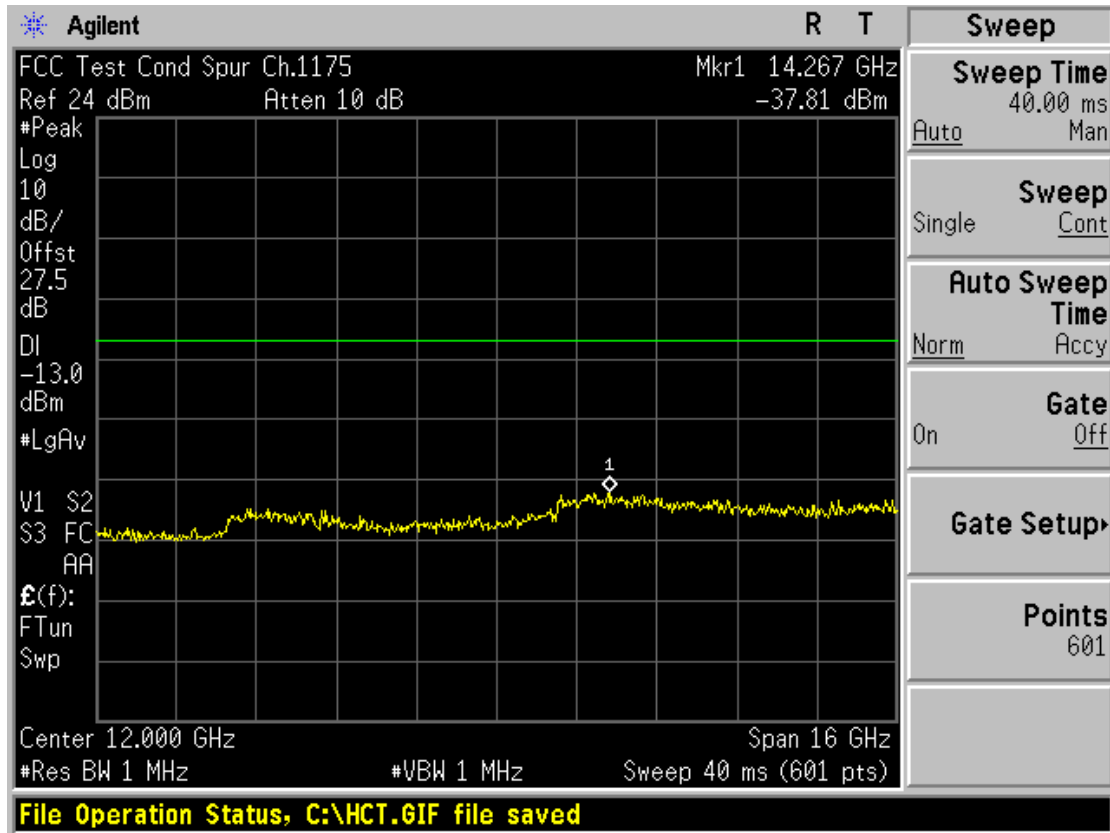

| FCC Class II Permissive Change Test Report | | | | www.hct.co.kr |
|--|---------------------------------|---------------------------------------|----------------------|--|
| Test Report No. HCTR0912FR03 | Test Dates: December 9, 2009 | EUT Type: Dual-band CDMA USB Modem | FCC ID: PP4PX-800 | Page 41 of 41 |