



SAR TEST REPORT

HCT CO., LTD



EUT Type:	Dual-Band CDMA Phone with Bluetooth (CDMA/PCS CDMA)		
FCC ID:	PP4IMD		
Model:	CDM8964	Trade Name	PANTECH&CURITEL
Date of Issue:	Apr.07, 2008		
Test report No.:	HCT-SAR08-0402		
Test Laboratory:	HCT CO., LTD. SAN 136-1, AMI-RI, BUBAL-EUP, ICHEON-SI, KYOUNGKI-DO, 467-701, KOREA TEL: +82 31 639 8565 FAX: +82 31 639 8525		
Applicant :	PANTECH&CURITEL COMMUNICATIONS, INC. 110-1, ONGJEONG-RI, TONGJIN-EUP, GIMPO-SI, GYOUNGGI-DO, 415-865, KOREA Tel: +82-31-999-8801 Fax: +82-31-984-9771 E-Mail: leekiyeoul@pantech.com		
Testing has been carried out in accordance with:	47CFR §2.1093 FCC OET Bulletin 65(Edition 97-01), Supplement C (Edition 01-01) ANSI/ IEEE C95.1 – 2005 IEEE 1528-2003		
Test result:	The tested device complies with the requirements in respect of all parameters subject to the test. The test results and statements relate only to the items tested. The test report shall not be reproduced except in full, without written approval of the laboratory.		
Signature	<div style="display: flex; justify-content: space-around; align-items: flex-end;"> <div style="text-align: center;">  <hr style="width: 100%;"/> Report prepared by : Sun-Hee Kim Test Engineer of SAR Part </div> <div style="text-align: center;">  <hr style="width: 100%;"/> Approved by : Nam-Wook Kang Manager of SAR Part </div> </div>		

Table of Contents

<u>1. INTRODUCTION</u>	3
<u>2. DESCRIPTION OF DEVICE</u>	4
<u>3. DESCRIPTION OF TEST EQUIPMENT</u>	5
<u>3.1 SAR MEASUREMENT SETUP</u>	5
<u>3.2 DASY E-FIELD PROBE SYSTEM</u>	6
<u>3.3 PROBE CALIBRATION PROCESS</u>	7
<u>3.4 SAM Phantom</u>	9
<u>3.5 Device Holder for Transmitters</u>	9
<u>3.6 Brain & Muscle Simulating Mixture Characterization</u>	10
<u>3.7 SAR TEST EQUIPMENT</u>	11
<u>4. SAR MEASUREMENT PROCEDURE</u>	12
<u>5. DESCRIPTION OF TEST POSITION</u>	13
<u>5.1 HEAD POSITION</u>	13
<u>5.2 Body Holster/Belt Clip Configurations</u>	14
<u>6. MEASUREMENT UNCERTAINTY</u>	15
<u>7. ANSI/ IEEE C95.1 - 2005 RF EXPOSURE LIMITS</u>	16
<u>8. SYSTEM VERIFICATION</u>	17
<u>8.1 Tissue Verification</u>	17
<u>8.2 System Validation</u>	17
<u>9. 3G MEASUREMENT PROCEDURES</u>	18
<u>10. SAR Evaluation Considerations for Handsets with Multiple Transmitters and Antennas</u>	20
<u>11. SAR TEST DATA SUMMARY</u>	21
<u>11.1 Measurement Results (CDMA835 Head SAR Touch Slide Up)</u>	21
<u>11.2 Measurement Results (CDMA835 Head SAR Touch Slide Down)</u>	22
<u>11.3 Measurement Results (CDMA835 Head SAR Tilt Slide Up)</u>	23
<u>11.4 Measurement Results (CDMA835 Head SAR Tilt Slide Down)</u>	24
<u>11.5 Measurement Results (PCS1900 Head SAR Touch Slide Up)</u>	25
<u>11.6 Measurement Results (PCS1900 Head SAR Touch Slide Down)</u>	26
<u>11.7 Measurement Results (PCS1900 Head SAR Tilt Slide Up)</u>	27
<u>11.8 Measurement Results (PCS1900 Head SAR Tilt Slide Down)</u>	28
<u>11.9 Measurement Results (CDMA835 Body SAR)</u>	29
<u>11.10 Measurement Results (PCS1900 Body SAR)</u>	30
<u>12. CONCLUSION</u>	31
<u>13. REFERENCES</u>	32
Attachment 1. – SAR Test Plots	33
Attachment 2. – Dipole Validation Plots	81
Attachment 3. – Probe Calibration Data	91
Attachment 4. – Dipole Calibration Data	102

1. INTRODUCTION

The FCC has adopted the guidelines for evaluating the environmental effects of radio frequency radiation in ET Docket 93-62 on Aug. 6, 1996 to protect the public and workers from the potential hazards of RF emissions due to FCC-regulated portable devices.

The safety limits used for the environmental evaluation measurements are based on the criteria published by the American National Standards Institute (ANSI) for localized specific absorption rate (SAR) in IEEE/ANSI C95.1-2005 Standard for Safety Levels with Respect to Human Exposure to Radio Frequency Electromagnetic Fields, 3 kHz to 300 GHz. 1992 by the Institute of Electrical and Electronics Engineers, Inc., New York, New York 10017. The measurement procedure described in IEEE/ANSI C95.3-1992 Recommended Practice for the Measurement of Potentially Hazardous Electromagnetic Fields - RF and Microwave is used for guidance in measuring SAR due to the RF radiation exposure from the Equipment Under Test (EUT). These criteria for SAR evaluation are similar to those recommended by the National Council on Radiation Protection and Measurements (NCRP) in Biological Effects and Exposure Criteria for Radio frequency Electromagnetic Fields," NCRP Report No. 86 NCRP, 1986, Bethesda, MD 20814. SAR is a measure of the rate of energy absorption due to exposure to an RF transmitting source. SAR values have been related to threshold levels for potential biological hazards.

SAR Definition

Specific Absorption Rate (SAR) is defined as the time derivative of the incremental electromagnetic energy (dW) absorbed by (dissipated in) an incremental mass (dm) contained in a volume element (dV) of a given density (r). It is also defined as the rate of RF energy absorption per unit mass at a point in an absorbing body.

$$SAR = \frac{d}{dt} \left(\frac{dU}{dm} \right) = \frac{d}{dt} \left(\frac{dU}{\rho dV} \right)$$

Figure 2. SAR Mathematical Equation

SAR is expressed in units of Watts per Kilogram (W/kg).

$$SAR = \sigma E^2 / \rho$$

where:

- σ = conductivity of the tissue-simulant material (S/m)
- ρ = mass density of the tissue-simulant material (kg/m³)
- E = Total RMS electric field strength (V/m)

NOTE: The primary factors that control rate of energy absorption were found to be the wavelength of the incident field in relations to the dimensions and geometry of the irradiated organism, the orientation of the organism in relation to the polarity of field vectors, the presence of reflecting surfaces, and whether conductive contact is made by the organism with a ground plane.

2. DESCRIPTION OF DEVICE

Environmental evaluation measurements of specific absorption rate (SAR) distributions in emulated human head and body tissues exposed to radio frequency (RF) radiation from wireless portable devices for compliance with the rules and regulations of the U.S. Federal Communications Commission (FCC).

EUT Type	Dual-Band CDMA Phone with Bluetooth (CDMA/PCS CDMA)
FCC ID	PP4IMD
Model(s)	CDM8964
Trade Name	PANTECH&CURITEL
Serial Number(s)	#1
Application Type	Certification
Modulation(s)	CDMA835/PCS1900
Tx Frequency	824.70 - 848.31 MHz (CDMA) 1 851.25 – 1 908.75 MHz (PCS CDMA)
Rx Frequency	869.70 - 893.31 MHz (CDMA) 1 931.25 – 1 988.75 MHz (PCS CDMA)
FCC Classification	Licensed Portable Transmitter Held to Ear (PCE)
Production Unit or Identical Prototype	Prototype
Max SAR	1.39 W/kg CDMA835 Head SAR / 0.826 W/kg CDMA835 Body SAR 1.39 W/kg PCS1900 Head SAR / 0.24 W/kg PCS1900 Body SAR
Date(s) of Tests	Apr. 5, 2008 ~ Apr. 6, 2008
Antenna Type	Intenna

3. DESCRIPTION OF TEST EQUIPMENT

3.1 SAR MEASUREMENT SETUP

These measurements are performed using the DASY4 automated dosimetric assessment system. It is made by Schmid & Partner Engineering AG (SPEAG) in Zurich, Switzerland. It consists of high precision robotics system (Staubli), robot controller, Pentium III computer, near-field probe, probe alignment sensor, and the generic twin phantom containing the brain equivalent material. The robot is a six-axis industrial robot performing precise movements to position the probe to the location (points) of maximum electromagnetic field (EMF) (see Figure.3.1).

A cell controller system contains the power supply, robot controller, teach pendant (Joystick), and remote control, is used to drive the robot motors. The PC consists of the HP Pentium IV 3.0 GHz computer with Windows XP system and SAR Measurement Software DASY4, A/D interface card, monitor, mouse, and keyboard. The Staubli Robot is connected to the cell controller to allow software manipulation of the robot. A data acquisition electronic (DAE) circuit performs the signal amplification, signal multiplexing, AD-conversion, offset measurements, mechanical surface detection, collision detection, etc. is connected to the Electro-optical coupler (EOC). The EOC performs the conversion from the optical into digital electric signal of the DAE and transfers data to the PC plug-in card.

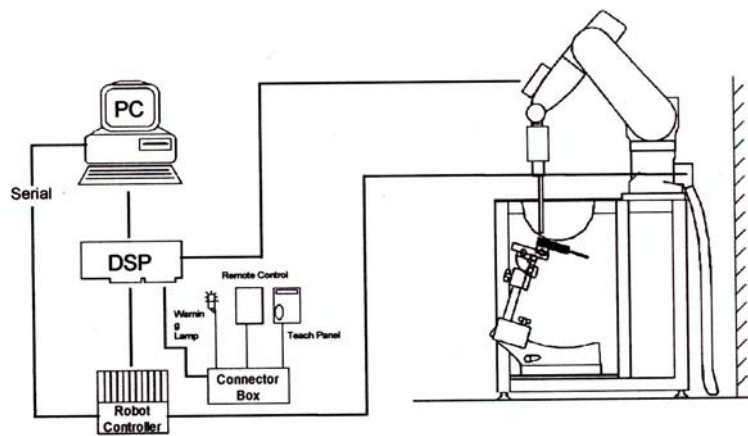

Figure 3.1 HCT SAR Lab. Test Measurement Set-up

The DAE4 consists of a highly sensitive electrometer-grade preamplifier with auto-zeroing, a channel and gain-switching multiplexer, a fast 16 bit AD-converter and a command decoder and control logic unit. Transmission to the PC-card is accomplished through an optical downlink for data and status information and an optical uplink for commands and clock lines. The mechanical probe mounting device includes two different sensor systems for frontal and sidewise probe contacts. They are also used for mechanical surface detection and probe collision detection. The robot uses its own controller with a built in VME-bus computer. The system is described in detail in.

3.2 DASY E-FIELD PROBE SYSTEM

3.2.1 ET3DV6 Probe Specification

Construction	Symmetrical design with triangular core Built-in optical fiber for surface detection System Built-in shielding against static charges
Calibration	In air from 10 MHz to 2.5 GHz In brain and muscle simulating tissue at Frequencies of 450 MHz, 900 MHz and 1.8 GHz (accuracy: 8 %)
Frequency	10 MHz to > 6 GHz; Linearity: ± 0.2 dB (30 MHz to 3 GHz)
Directivity	± 0.2 dB in brain tissue (rotation around probe axis) ± 0.4 dB in brain tissue (rotation normal probe axis)
Dynamic	5 μ W/g to > 100 mW/g;
Range Linearity:	± 0.2 dB
Surface Detection	± 0.2 mm repeatability in air and clear liquids over diffuse reflecting surfaces.
Dimensions	Overall length: 330 mm Tip length: 16 mm Body diameter: 12 mm Tip diameter: 6.8 mm Distance from probe tip to dipole centers: 2.7 mm
Application	General dissymmetry up to 3 GHz Compliance tests of mobile phones Fast automatic scanning in arbitrary phantoms

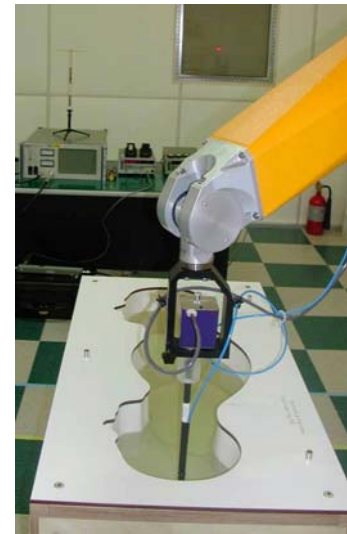

Figure 3.2 Photograph of the probe and the Phantom

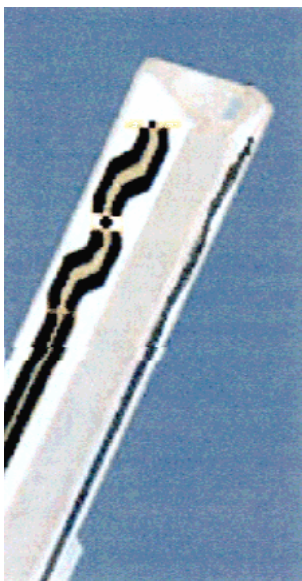

Figure 3.3 ET3DV6 E-field Probe

The SAR measurements were conducted with the dosimetric probe ET3DV6, designed in the classical triangular configuration and optimized for dosimetric evaluation. The probe is constructed using the thick film technique; with printed resistive lines on ceramic substrates. The probe is equipped with an optical multifiber line ending at the front of the probe tip. It is connected to the EOC box on the robot arm and provides an automatic detection of the phantom surface. Half of the fibers are connected to a pulsed infrared transmitter, the other half to a synchronized receiver. As the probe approaches the surface, the reflection from the surface produces a coupling from the transmitting to the receiving fibers. This reflection increases first during the approach, reaches a maximum and then decreases. If the probe is flatly touching the surface, the coupling is zero. The distance of the coupling maximum to the surface is independent of the surface reflectivity and largely independent of the surface to probe angle. The DASY4 software reads the reflection during a software approach and looks for the maximum using a 2nd order fitting. The approach is stopped at reaching the maximum.

3.3 PROBE CALIBRATION PROCESS

3.3.1 E-Probe Calibration

Each probe is calibrated according to a dosimetric assessment procedure with an accuracy better than ± 10 %. The spherical isotropy was evaluated with the proper procedure and found to be better than ± 0.25 dB. The sensitivity parameters (NormX, NormY, NormZ), the diode compression parameter (DCP) and the conversion factor (ConvF) of the probe is tested.

The free space E-field from amplified probe outputs is determined in a test chamber. This is performed in a TEM cell for frequencies below 1 GHz, and in a waveguide above 1 GHz for free space. For the free space calibration, the probe is placed in the volumetric center of the cavity and at the proper orientation with the field. The probe is then rotated 360 degrees.

E-field temperature correlation calibration is performed in a flat phantom filled with the appropriate simulated brain tissue. The measured free space E-field in the medium correlates to temperature rise in a dielectric medium. For temperature correlation calibration a RF transparent thermistor-based temperature probe is used in conjunction with the E-field probe.

$$SAR = C \frac{\Delta T}{\Delta t}$$

where:

- Δt = exposure time (30 seconds),
- C = heat capacity of tissue (brain or muscle),
- ΔT = temperature increase due to RF exposure.

SAR is proportional to $\Delta T / \Delta t$, the initial rate of tissue heating, before thermal diffusion takes place. Now it's possible to quantify the electric field in the simulated tissue by equating the thermally derived SAR to the E- field;

$$SAR = \frac{|E|^2 \cdot \sigma}{\rho}$$

where:

- σ = simulated tissue conductivity,
- ρ = Tissue density (1.25 g/cm³ for brain tissue)

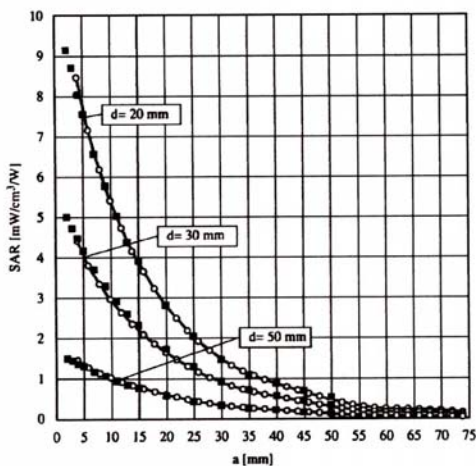

Figure 3.4 E-Field and Temperature measurements at 900 MHz

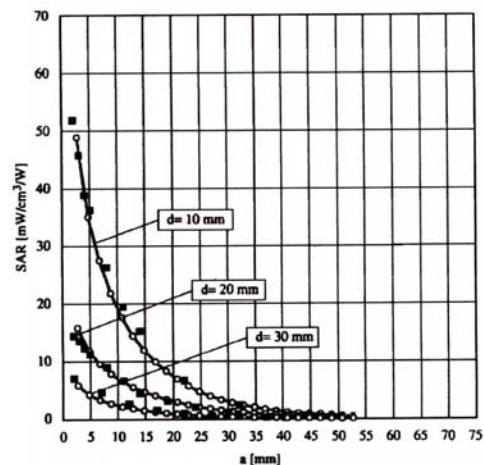

Figure 3.5 E-Field and temperature measurements at 1.8 GHz

3.3.2 Data Extrapolation

The DASY4 software automatically executes the following procedures to calculate the field units from the microvolt readings at the probe connector. The first step of the evaluation is a linearization of the filtered input signal to account for the compression characteristics of the detector diode. The compensation depends on the input signal, the diode type and the DC-transmission factor from the diode to the evaluation electronics. If the exciting field is pulsed, the crest factor of the signal must be known to correctly compensate for peak power. The formula for each channel can be given like below;

$$V_i = U_i + U_i^2 \cdot \frac{cf}{dcp_i}$$

with V_i = compensated signal of channel i (i=x,y,z)
 U_i = input signal of channel i (i=x,y,z)
 cf = crest factor of exciting field (DASY parameter)
 dcp_i = diode compression point (DASY parameter)

From the compensated input signals the primary field data for each channel can be evaluated:

E-field probes:

$$E_i = \sqrt{\frac{V_i}{Norm_i \cdot ConvF}}$$

with V_i = compensated signal of channel i (i = x,y,z)
 $Norm_i$ = sensor sensitivity of channel i (i = x,y,z)
 $\mu V/(V/m)^2$ for E-field probes
 $ConvF$ = sensitivity of enhancement in solution
 E_i = electric field strength of channel i in V/m

The RSS value of the field components gives the total field strength (Hermetian magnitude):

$$E_{tot} = \sqrt{E_x^2 + E_y^2 + E_z^2}$$

The primary field data are used to calculate the derived field units.

$$SAR = E_{tot}^2 \cdot \frac{\sigma}{\rho \cdot 1000}$$

with SAR = local specific absorption rate in W/g
 E_{tot} = total field strength in V/m
 σ = conductivity in [mho/m] or [Siemens/m]
 ρ = equivalent tissue density in g/cm³

The power flow density is calculated assuming the excitation field to be a free space field.

$$P_{pwe} = \frac{E_{tot}^2}{3770}$$

with P_{pwe} = equivalent power density of a plane wave in W/cm²
 E_{tot} = total electric field strength in V/m

3.4 SAM Phantom

The SAM Phantom is constructed of a fiberglass shell integrated in a wooden table. The shape of the shell is based on data from an anatomical study designed to determine the maximum exposure in at least 90 % of all users. It enables the dosimetric evaluation of left and right hand phone usage as well as body mounted usage at the flat phantom region. A cover prevents the evaporation of the liquid. Reference markings on the Phantom allow the complete setup of all predefined phantom positions and measurement grids by manually teaching three points in the robot.

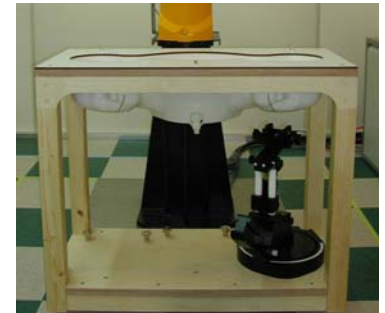

Figure 3.6 SAM Phantom

Shell Thickness	2.0 mm
Filling Volume	about 30 L
Dimensions	810 mm x 1 000 mm x 500 mm (H x L x W)

3.5 Device Holder for Transmitters

In combination with the SAM Phantom V 4.0, the Mounting Device (POM) enables the rotation of the mounted transmitter in spherical coordinates whereby the rotation points is the ear opening. The devices can be easily, accurately, and repeatably positioned according to the FCC and CENELEC specifications. The device holder can be locked at different phantom locations (left head, right head, flat phantom).

Note: A simulating human hand is not used due to the complex anatomical and geometrical structure of the hand that may produce an infinite number of configurations. To produce the Worst-case condition (the hand absorbs antenna output power), the hand is omitted during the tests.



Figure 3.7 Device Holder

3.6 Brain & Muscle Simulating Mixture Characterization

The brain and muscle mixtures consist of a viscous gel using hydrox-ethyl cellulose (HEC) gelling agent and saline solution (see Table 3.1). Preservation with a bactericide is added and visual inspection is made to make sure air bubbles are not trapped during the mixing process. The mixture is calibrated to obtain proper dielectric constant (permittivity) and conductivity of the desired tissue. The mixture characterizations used for the brain and muscle tissue simulating liquids are according to the data by C. Gabriel and G. Hartsgrove.

Ingredients (% by weight)	Frequency (MHz)									
	450		835		915		1 900		2 450	
Tissue Type	Head	Body	Head	Body	Head	Body	Head	Body	Head	Body
Water	38.56	51.16	41.45	52.4	41.05	56.0	54.9	40.4	62.7	73.2
Salt (NaCl)	3.95	1.49	1.45	1.4	1.35	0.76	0.18	0.5	0.5	0.04
Sugar	56.32	46.78	56.0	45.0	56.5	41.76	0.0	58.0	0.0	0.0
HEC	0.98	0.52	1.0	1.0	1.0	1.21	0.0	1.0	0.0	0.0
Bactericide	0.19	0.05	0.1	0.1	0.1	0.27	0.0	0.1	0.0	0.0
Triton X-100	0.0	0.0	0.0	0.0	0.0	0.0	0.0	0.0	36.8	0.0
DGBE	0.0	0.0	0.0	0.0	0.0	0.0	44.92	0.0	0.0	26.7

Salt:	99 % Pure Sodium Chloride	Sugar:	98 % Pure Sucrose
Water:	De-ionized, 16M resistivity	HEC:	Hydroxyethyl Cellulose
DGBE:	99 % Di(ethylene glycol) butyl ether,[2-(2-butoxyethoxy) ethanol]		
Triton X-100(ultra pure):	Polyethylene glycol mono[4-(1,1,3,3-tetramethylbutyl)phenyl] ether		

Table 3.1 Composition of the Tissue Equivalent Matter

3.7 SAR TEST EQUIPMENT

Manufacturer	Type / Model	S/N	Calib. Date	Calib.Interval	Calib.Due
SPEAG	SAM Phantom	-	N/A	N/A	N/A
Staubli	Robot RX90L	F01/5K09A1/A/01	N/A	N/A	N/A
Staubli	Robot ControllerCS7MB	F99/5A82A1/C/01	N/A	N/A	N/A
HP	Pavilion t000_puffer	KRJ51201TV	N/A	N/A	N/A
SPEAG	Light Alignment Sensor	265	N/A	N/A	N/A
Staubli	Teach Pendant (Joystick)	D221340.01	N/A	N/A	N/A
SPEAG	DAE4V1	447	Sep.13, 2007	Annual	Sep.13, 2008
SPEAG	E-Field Probe ET3DV6	1609	Aug.30, 2007	Annual	Aug.30, 2008
SPEAG	Validation Dipole D835V2	481	May 24, 2007	Annual	May 24, 2008
SPEAG	Validation Dipole D1800V2	2d066	May 23, 2007	Annual	May 23, 2008
SPEAG	Validation Dipole D1900V2	5d038	Nov.20, 2007	Annual	Nov.20, 2008
SPEAG	Validation Dipole D2450V2	734	Aug.20.2007	Annual	Aug.20.2008
Agilent	Power Meter(F) E4419B	MY40330223	Nov.05, 2007	Annual	Nov.05, 2008
Agilent	Power Sensor(G) 8481	MY41090870	Nov.05, 2007	Annual	Nov.05, 2008
HP	Dielectric Probe Kit 85070C	00721521	N/A	N/A	N/A
HP	Dual Directional Coupler	16072	Nov. 05, 2007	Annual	Nov. 05, 2008
R&S	Base Station CMU200	838207/050	Nov. 05, 2007	Annual	Nov. 05, 2008
Agilent	Base Station E5515C	GB44400269	Feb.10, 2008	Annual	Feb.10, 2009
HP	Signal Generator E4438C	MY42082646	Dec.24, 2007	Annual	Dec.24, 2008
HP	Network Analyzer 8753ES	JP39240221	Apr.11, 2007	Annual	Apr.11, 2008
EM POWER	Power Amp BBS3Q7ELU	1013-D/C-0127	Apr.17, 2007	Annual	Apr.17, 2008
Tescom	TC-3000/ Bluetooth	3000A4900112	Jan.11,2008	Annual	Jan.11,2009

NOTE:

The E-field probe was calibrated by SPEAG, by the waveguide technique procedure. Dipole Validation measurement is performed by HCT Lab. before each test. The brain simulating material is calibrated by HCT using the dielectric probe system and network analyzer to determine the conductivity and permittivity (dielectric constant) of the brain-equivalent material.

4. SAR MEASUREMENT PROCEDURE

The evaluation was performed with the following procedure:

1. The SAR value at a fixed location above the ear point was measured and was used as a reference value for assessing the power drop.
2. The SAR distribution at the exposed side of the head was measured at a distance of 3.9 mm from the inner surface of the shell. The area covered the entire dimension of the head and the horizontal grid spacing was 20 mm x 20 mm. Based on this data, the area of the maximum absorption was determined by spline interpolation.
3. Around this point, a volume of 32 mm x 32 mm x 34 mm was assessed by measuring 5 x 5 x 7 points. On this basis of this data set, the spatial peak SAR value was evaluated with the following procedure:
 - a. The data at the surface were extrapolated, since the center of the dipoles is 2.7 mm away from the tip of the probe and the distance between the surface and the lowest measuring point is 1.2 mm. The extrapolation was based on a least square algorithm. A polynomial of the fourth order was calculated through the points in z-axes. This polynomial was then used to evaluate the points between the surface and the probe tip.
 - b. The maximum interpolated value was searched with a straight-forward algorithm. Around this maximum the SAR values averaged over the spatial volumes (1 g or 10 g) were computed using the 3D-Spline interpolation algorithm. The 3D-spline is composed of three one-dimensional splines with the "Not a knot" condition (in x, y, and z directions. The volume was integrated with the trapezoidal algorithm. One thousand points (10 x 10 x 10) were interpolated to calculate the average.
 - c. All neighboring volumes were evaluated until no neighboring volume with a higher average value was found.
4. The SAR value, at the same location as procedure #1, was re-measured. If the value changed by more than 5 %, the evaluation is repeated.

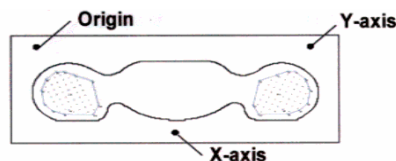

Figure 4.1 SAR Measurement Point in Area Scan

5. DESCRIPTION OF TEST POSITION

5.1 HEAD POSITION

The device was placed in a normal operating position with the Point A on the device, as illustrated in following drawing, aligned with the location of the RE(ERP) on the phantom. With the ear-piece pressed against the head, the vertical center line of the body of the handset was aligned with an imaginary plane consisting of the RE, LE and M. While maintaining these alignments, the body of the handset was gradually moved towards the cheek until any point on the mouth-piece or keypad contacted the cheek. This is a cheek/touch position. For ear/tilt position, while maintain the device aligned with the BM and FN lines, the device was pivot against ERP back for 15° or until the device antenna touch the phantom. Please refer to IEEE 1528-2003 illustration below.

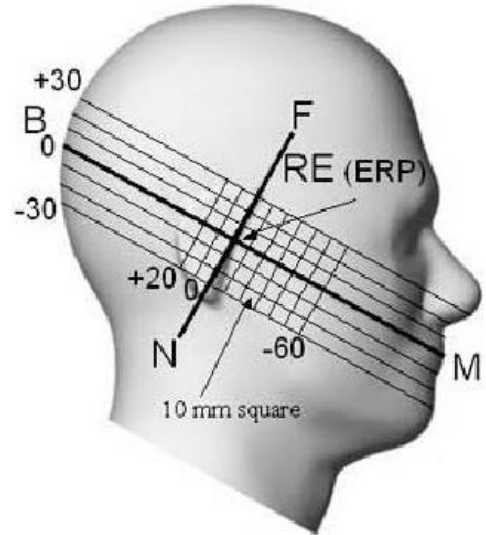

Figure 5.1 Side view of the phantom

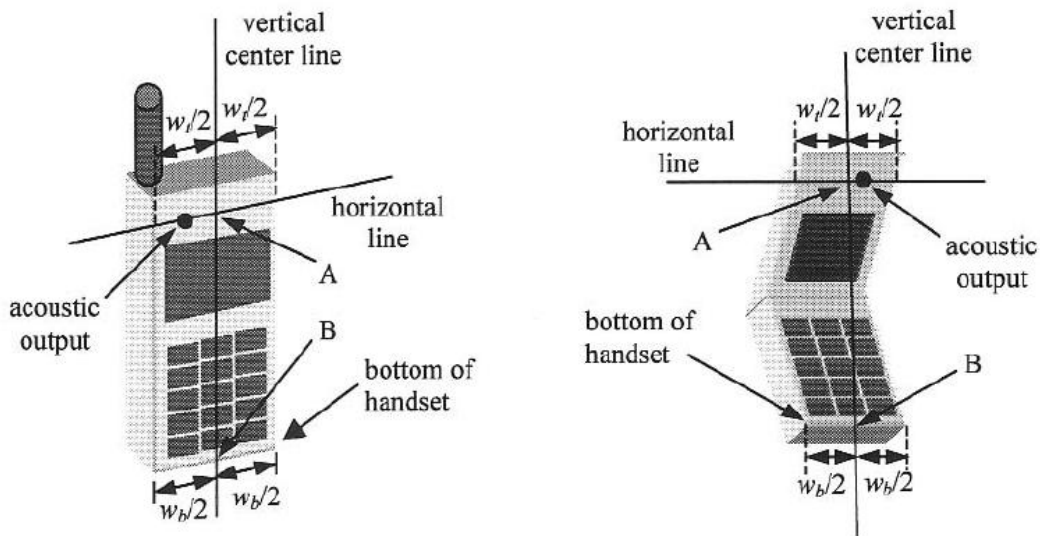

Figure 5.2 Handset vertical and horizontal reference lines

5.2 Body Holster/Belt Clip Configurations

Body-worn operating configurations are tested with the belt-clips and holsters attached to the device and positioned against a flat phantom in a normal use configuration. A device with a headset output is tested with a headset connected to the device. Body dielectric parameters are used.

Accessories for Body-worn operation configurations are divided into two categories: those that do not contain metallic components and those that contain metallic components. When multiple accessories that do not contain metallic components are supplied with the device, the device is tested with only the accessory that dictates the closest spacing to the body. Then multiple accessories that contain metallic components are tested with each accessory. If multiple accessory share an identical metallic component (i.e. the same metallic belt-clip used with different holsters with no other metallic components) only the accessory that dictates the closest spacing to the body is tested.

Body-worn accessories may not always be supplied or available as options for some Devices intended to be authorized for body-worn use. In this case, a test configuration with a separation distance between the back of the device and the flat phantom is used.

For this test the EUT is placed into the Body worn accessory and the accessory is positioned against the surface of the phantom in a normal operating position. (2 mm separation phantom thickness)

"See the Test SET-UP Photo"

Transmitters that are designed to operate in front of a person's face, as in push-to-talk configurations, are tested for SAR compliance with the front of the device positioned to face the flat phantom. For devices that are carried next to the body such as a shoulder, waist or chest-worn transmitters, SAR compliance is tested with the accessory(ies), including headsets and microphones, attached to the device and positioned against a flat phantom in a normal use configuration.

In all cases SAR measurements are performed to investigate the worst-case positioning. Worstcase positioning is then documented and used to perform Body SAR testing.

6. MEASUREMENT UNCERTAINTY

Measurement uncertainties in SAR measurements are difficult to quantify due to several variables including biological, physiological, and environmental. However, we estimate the measurement uncertainties in SAR to be less than 15 % - 25 %.

According to ANSI/IEEE C95.3, the overall uncertainties are difficult to assess and will vary with the type of meter and usage situation. However, accuracy's of 1 dB to ± 3 dB can be expected in practice, with greater uncertainties in near-field situations and at higher frequencies (shorter wavelengths), or areas where large reflecting objects are present. Under optimum measurement conditions, SAR measurement uncertainties of at least ± 2 dB can be expected.

According to CENELEC, typical worst-case uncertainty of field measurements is 5 dB. For well-defined modulation characteristics the uncertainty can be reduced to ± 3 dB.

Error Description	Uncertainty value [%]	Probability Distribution	Divisor	ci	ci ²	Standard Uncertainty [%]	Stand Uncert ²	(Stand Uncert ²) X (ci ²)	Vi & Ve//
1. Measurement System									
Probe Calibration	5.5	Normal	1.00	1	1	5.50	30.25	30.25	∞
Axial Isotropy	4.7	Rectangular	1.73	0.7	0.49	2.71	7.36	3.61	∞
Hemispherical Isotropy	9.6	Rectangular	1.73	0.7	0.49	5.54	30.72	15.05	∞
Linearity	4.7	Rectangular	1.73	1	1	2.71	7.36	7.36	∞
System Detection limits	1.0	Rectangular	1.73	1	1	0.58	0.33	0.33	∞
Boundary effect	1.0	Rectangular	1.73	1	1	0.58	0.33	0.33	∞
Response time	0.8	Rectangular	1.73	1	1	0.46	0.21	0.21	∞
RF Ambient conditions	3.0	Rectangular	1.73	1	1	1.73	3.00	3.00	∞
Readout Electronics	0.3	Normal	1.00	1	1	0.30	0.09	0.09	∞
Integration time	2.6	Rectangular	1.73	1	1	1.50	2.25	2.25	∞
Probe positioner	0.4	Rectangular	1.73	1	1	0.23	0.05	0.05	∞
Probe positioning	2.9	Rectangular	1.73	1	1	1.67	2.80	2.80	∞
Maximum SAR evaluation	1.0	Rectangular	1.73	1	1	0.58	0.33	0.33	∞
Sub Total								65.69	
2. Test Sample Related									
Device Positioning	1.8	Normal	1.00	1	1	1.81	3.28	3.28	9
Device Holder	3.6	Normal	1.00	1	1	3.60	12.96	12.96	∞
Power Drift	5.0	Rectangular	1.73	1	1	2.89	8.33	8.33	∞
Sub Total								24.57	
3. Phantom and Setup									
Phantom Uncertainty	4.0	Rectangular	1.73	1	1	2.31	5.33	5.33	∞
Liquid conductivity (target)	5.0	Rectangular	1.73	0.5	0.25	2.89	8.33	2.08	∞
Liquid conductivity (measurement error)	2.5	Normal	1.00	0.5	0.25	2.50	6.25	1.56	∞
Liquid permittivity (target)	5.0	Rectangular	1.73	0.5	0.25	2.89	8.33	2.08	∞
Liquid permittivity (measurement error)	2.5	Normal	1.00	0.5	0.25	2.50	6.25	1.56	∞
Sub Total								12.63	
Combined standard SAR uncertainty [%]						10.14		102.88	-
Expanded uncertainty [k=2, approximately confidence level 95 %]						± 20.28 %			

Table 6.1 Breakdown of Errors

7. ANSI/ IEEE C95.1 - 2005 RF EXPOSURE LIMITS

HUMAN EXPOSURE	UNCONTROLLED ENVIRONMENT General Population (W/kg) or (mW/g)	CONTROLLED ENVIRONMENT Occupational (W/kg) or (mW/g)
SPATIAL PEAK SAR * (Brain)	1.60	8.00
SPATIAL AVERAGE SAR ** (Whole Body)	0.08	0.40
SPATIAL PEAK SAR *** (Hands / Feet / Ankle / Wrist)	4.00	20.00

Table 7.1 Safety Limits for Partial Body Exposure

NOTES:

* The Spatial Peak value of the SAR averaged over any 1 g of tissue (defined as a tissue volume in the shape of a cube) and over the appropriate averaging time.

** The Spatial Average value of the SAR averaged over the whole-body.

*** The Spatial Peak value of the SAR averaged over any 10 g of tissue (defined as a tissue volume in the shape of a cube) and over the appropriate averaging time.

Uncontrolled Environments are defined as locations where there is the exposure of individuals who have no knowledge or control of their exposure.

Controlled Environments are defined as locations where there is exposure that may be incurred by persons who are aware of the potential for exposure, (i.e.as a result of employment or occupation).

8. SYSTEM VERIFICATION

8.1 Tissue Verification

Freq. [MHz]	Date	Liquid	Liquid Temp.[°C]	Parameters	Target Value	Measured Value	Deviation [%]	Limit [%]
835	Apr.05, 2008	Head	21.4	ϵr	41.5	41.9	+ 0.96	± 5
				σ	0.90	0.881	- 2.11	± 5
835	Apr.05, 2008	Body	21.4	ϵr	55.2	54.7	- 0.91	± 5
				σ	0.97	0.98	+ 1.03	± 5
1 900	Apr.06, 2008	Head	21.3	ϵr	40.0	38.7	- 3.25	± 5
				σ	1.40	1.46	+ 4.29	± 5
1 900	Apr.06, 2008	Body	21.3	ϵr	53.3	51.8	- 2.81	± 5
				σ	1.52	1.50	- 1.32	± 5
2 450	Apr.06, 2008	Head	21.3	ϵr	39.2	38.9	- 0.77	± 5
				σ	1.80	1.81	+ 0.56	± 5
2 450	Apr.06, 2008	Body	21.3	ϵr	52.7	51.25	- 2.75	± 5
				σ	1.95	2.00	+ 2.56	± 5

8.2 System Validation

Prior to assessment, the system is verified to the $\pm 10\%$ of the specifications at 835 MHz/ 1 900 MHz / 2 450 MHz by using the system validation kit. (Graphic Plots Attached)

* Input Power: 1 W

Freq. [MHz]	Date	Liquid	Liquid Temp. [°C]	SAR Average	Target Value (SPEAG) (mW/g)	Measured Value (mW/g)	Deviation [%]	Limit [%]
835	Apr.05, 2008	Head	21.4	1 g	9.21	9.51	+ 3.26	± 10
1 900	Apr.06, 2008	Head	21.3	1 g	38.0	39.40	+ 3.68	± 10
2 450	Apr.06, 2008	Head	21.3	1 g	52.8	53.0	+ 0.38	± 10

9. 3G MEASUREMENT PROCEDURES

9.1 Procedures Used To Establish Test Signal

The handset was placed into a simulated call using a base station simulator in a shielded chamber. Such test signals offer a consistent means for testing SAR and are recommended for evaluating SAR. SAR measurements were taken with a fully charged battery. In order to verify that the device was tested and maintained at full power, this was configured with the base station simulator. The SAR measurement software calculates a reference point at the start and end of the test to check for power drifts. If conducted power deviations of more than 5% occurred, the tests were repeated.

9.2 SAR Measurement Conditions for CDMA2000 1x

These procedures were followed according to FCC "SAR Measurement Procedures for 3G Devices", May 2006.

9.2.1 Output Power Verification

See 3GPP2 C.S0011/TIA-98-E as recommended by "SAR Measurement Procedures for 3G Devices", May 2006. Maximum output power is verified on the High, Middle and Low channels according to procedures defined in section 4.4.5.2 of 3GPP2 C.S0011/TIA-98-E. SO55 tests were measured with power control bits in "All Up" condition.

1. If the mobile station supports Reverse TCH RC 1 and Forward TCH RC 1, set up a call using Fundamental Channel Test Mode 1 (RC=1/1) with 9 600 bps data rate only.
2. Under RC1, C.S0011 Table 4.4.5.2-1 (Table 9.1) parameters were applied.
3. If the MS supports the RC 3 Reverse FCH, RC3 Reverse SCH0 and demodulation of RC 3, 4, or 5, set up a call using Supplemental Channel Test Mode 3 (RC 3/3) with 9 600 bps Fundamental Channel and 9 600 bps SCH0 data rate Channel and 9 600 bps SCH0 data rate.
4. Under RC3, C.S0011 Table 4.4.5.2-2(Table 9.2) was applied.
5. FCHs were configured at full rate for maximum SAR with "All Up" power control bits.

Parameters for Max. Power for RC1

Parameter	Units	Value
$\overline{I_{or}}$	dBm/1.23 MHz	-104
$\frac{Pilot E_c}{I_{or}}$	dB	-7
$\frac{Traffic E_c}{I_{or}}$	dB	-7.4

Table. 9.1

Parameters for Max. Power for RC3

Parameter	Units	Value
$\overline{I_{or}}$	dBm/1.23 MHz	-86
$\frac{Pilot E_c}{I_{or}}$	dB	-7
$\frac{Traffic E_c}{I_{or}}$	dB	-7.4

Table. 9.2

9.2.2 Head SAR Measurement

SAR for head exposure configurations is measured in RC3 with the DUT configured to transmit at full rate using Loopback Service Option SO55. SAR for RC1 is not required when the maximum average output of each channel is less than ¼ dB higher than that measured in RC3. Otherwise, SAR is measured on the maximum output channel in RC1 using the exposure configuration that results in the highest SAR for that channel in RC3.

9.2.3 Body SAR Measurement

SAR for body exposure configurations is measured in RC3 with the DUT configured to transmit at full rate on FCH with all other code channels disabled using TDSO / SO32. SAR for multiple code channels (FCH + SCHn) is not required when the maximum average output of each RF channel is less than ¼ dB higher than that measured with FCH only. Otherwise, SAR is measured on the maximum output channel (FCH + SCHn) with FCH at full rate and SCH0 enabled at 9 600 bps using the exposure configuration that results in the highest SAR for that channel with FCH only. When multiple code channels are enabled, the DUT output may shift by more than 0.5 dB and lead to higher SAR drifts and SCH dropouts.

Body SAR in RC1 is not required when the maximum average output of each channel is less than ¼ dB higher than that measured in RC3. Otherwise, SAR is measured on the maximum output channel in RC1; with Loopback Service Option SO55, at full rate, using the body exposure configuration that results in the highest SAR for that channel in RC3.

9.2.4 Handsets with EV-DO

For handsets with Ev-Do capabilities, when the maximum average output of each channel in Rev. 0 is less than ¼ dB higher than that measured in RC3 (1x RTT), body SAR for Ev-Do is not required. Otherwise, SAR for Rev. 0 is measured on the maximum output channel at 153.6 kbps using the body exposure configuration that results in the highest SAR for that channel in RC3. SAR for Rev. A is not required when the maximum average output of each channel is less than that measured in Rev. 0 or less than ¼ dB higher than that measured in RC3. Otherwise, SAR is measured on the maximum output channel for Rev. A using a Reverse Data Channel payload size of 4 096 bits and a Termination Target of 16 slots defined for Subtype 2 Physical Layer configurations. A Forward Traffic Channel data rate corresponding to the 2-slot version of 307.2 kbps with the ACK Channel transmitting in all slots should be configured in the downlink for both Rev. 0 and Rev. A.

Average Output Power Measurement for FCC ID: PP4IMD

Band	Channel	SO2	SO2	SO55	SO55	TDSO	1xEvDO	1xEvDO
		RC1/1	RC3/3	RC1/1	RC3/3	RC3/3	(FTAP)	(RTAP)
CDMA	1013	24.98	24.95	24.96	24.99	24.98	24.90	24.93
	384	24.93	24.90	24.92	24.95	24.97	24.95	24.98
	777	24.92	24.90	24.90	24.94	24.98	24.92	24.92
PCS	25	25.00	24.95	24.97	25.01	25.00	25.04	25.03
	600	24.83	24.87	24.85	24.83	24.86	24.89	24.87
	1175	24.91	24.95	24.91	24.93	24.95	25.01	24.98

10. SAR Evaluation Considerations for Handsets with Multiple Transmitters and Antennas

10.1 SAR Evaluation Considerations

These procedures were followed according to FCC "SAR Evaluation Considerations for Handsets with Multiple Transmitters and Antennas", February 2008. The procedures are applicable to phones with built-in unlicensed transmitters, such as 802.11 a/b/g and Bluetooth devices.

	2.45	5.15 - 5.35	5.47 - 5.85	GHz
P_{Ref}	12	6	5	mW
Device output power should be rounded to the nearest mW to compare with values				

Table. 9.1 Output Power Thresholds for Unlicensed Transmitters

	Individual Transmitter	Simultaneous Transmission
Licensed Transmitters	<u>Routine evaluation required</u>	SAR not required: <u>Unlicensed only</u>
Unlicensed Transmitters	<p>When there is no simultaneous transmission –</p> <ul style="list-style-type: none"> o output < 60/f: SAR not required o output ≥ 60/f: stand-alone SAR required <p>When there is simultaneous transmission –</p> <p><u>Stand-alone SAR not required when</u></p> <ul style="list-style-type: none"> o output ≤ 2·P_{Ref} and antenna is > 5.0 cm from other antennas o output ≤ P_{Ref} and antenna is > 2.5 cm from other antennas <p><u>Otherwise stand-alone SAR is required</u></p> <p>When stand-alone SAR is required</p> <ul style="list-style-type: none"> o test SAR on highest output channel for each wireless mode and exposure condition o if SAR for highest output channel is > 50% of SAR limit, evaluate all channels according to normal procedures 	<p><u>Licensed & Unlicensed</u></p> <ul style="list-style-type: none"> o when the sum of the 1-g SAR is < 1.6 W/kg for all simultaneous transmitting antennas o when SAR to antenna separation ratio of simultaneous transmitting antenna pair is < 0.3 <p>SAR required: <u>Licensed & Unlicensed</u></p> <p>antenna pairs with SAR to antenna separation ratio ≥ 0.3; test is only required for the configuration that results in the highest SAR in stand-alone configuration for each wireless mode and exposure condition</p> <p>Note: simultaneous transmission exposure conditions for head and body can be different for different style phones; therefore, different test requirements may apply</p>

Table. 9.2 SAR Evaluation Requirements for Cellphones with Multiple Transmitters

FCC ID: PP4IMD

BT Max. RF output power: 0.68 dBm (1.16 mW)

Antenna separation distance: 1.3 cm

The conducted output power level of the BT transmitter is less than P_{ref}, and the BT antenna is less than 2.5 cm from the GSM antenna. Therefore stand-alone BT SAR test is required for the EUT. The summation of BT SAR and Licensed Transmitter SAR are 1.390157 for Head and 0.826258 for Body, which are less than 1.6 mW/g, therefore, a simultaneous SAR evaluation is not required. Please see the section 11 data summary.

11. SAR TEST DATA SUMMARY

11.1 Measurement Results (CDMA835 Head SAR Touch Slide Up)

Frequency		Modulation	Conducted Power (dBm)		Battery	Phantom Position	Antenna Type	SAR(mW/g)
MHz	Channel		Begin	End				
824.70	1013 (Low)	CDMA835	24.99	24.84	Standard	Left Ear	Intenna	1.13
836.52	384 (Mid)	CDMA835	24.95	25.12	Standard	Left Ear	Intenna	0.978
848.31	777 (High)	CDMA835	24.94	24.93	Standard	Left Ear	Intenna	1.06
824.70	1013 (Low)	CDMA835	24.99	25.09	Standard	Right Ear	Intenna	1.23
836.52	384 (Mid)	CDMA835	24.95	25.02	Standard	Right Ear	Intenna	1.08
848.31	777 (High)	CDMA835	24.94	24.73	Standard	Right Ear	Intenna	1.29
ANSI/ IEEE C95.1 2005 – Safety Limit Spatial Peak Uncontrolled Exposure/ General Population						Head 1.6 W/kg (mW/g) <small>Averaged over 1 gram</small>		

NOTES:

- 1 The test data reported are the worst-case SAR value with the antenna-head position set in a typical configuration. Test procedures used are according to FCC/OET Bulletin 65, Supplement C [July 2001].
- 2 All modes of operation were investigated and the worst-case are reported.
- 3 Measured Depth of Simulating Tissue is 15.0 cm ± 0.2 cm.
- 4 Tissue parameters and temperatures are listed on the SAR plot.
- 5 Battery Type Standard Extended Slim
 Batteries are fully charged for all readings.
- 6 Test Signal Call Mode Manual Test cord Base Station Simulator
- 7 Head SAR was tested under RC3/SO55.

11.2 Measurement Results (CDMA835 Head SAR Touch Slide Down)

Frequency		Modulation	Conducted Power (dBm)		Battery	Phantom Position	Antenna Type	SAR(mW/g)
MHz	Channel		Begin	End				
824.70	1013 (Low)	CDMA835	24.99	25.00	Standard	Left Ear	Intenna	1.26
836.52	384 (Mid)	CDMA835	24.95	24.94	Standard	Left Ear	Intenna	1.20
848.31	777 (High)	CDMA835	24.94	25.14	Standard	Left Ear	Intenna	1.15
824.70	1013 (Low)	CDMA835	24.99	24.91	Standard	Right Ear	Intenna	1.39
836.52	384 (Mid)	CDMA835	24.95	25.03	Standard	Right Ear	Intenna	1.32
848.31	777 (High)	CDMA835	24.94	24.98	Standard	Right Ear	Intenna	1.26
2 402	0 (Low)	Bluetooth	0.68	0.795	Standard	Right Ear	Intenna	0.000157
ANSI/ IEEE C95.1 2005 – Safety Limit						Head		
Spatial Peak						1.6 W/kg (mW/g)		
Uncontrolled Exposure/ General Population						<small>Averaged over 1 gram</small>		

NOTES:

- 1 The test data reported are the worst-case SAR value with the antenna-head position set in a typical configuration. Test procedures used are according to FCC/OET Bulletin 65, Supplement C [July 2001].
- 2 All modes of operation were investigated and the worst-case are reported.
- 3 Measured Depth of Simulating Tissue is 15.0 cm ± 0.2 cm.
- 4 Tissue parameters and temperatures are listed on the SAR plot.
- 5 Battery Type Standard Extended Slim
 Batteries are fully charged for all readings.
- 6 Test Signal Call Mode Manual Test cord Base Station Simulator
- 7 Head SAR was tested under RC3/SO55.

11.3 Measurement Results (CDMA835 Head SAR Tilt Slide Up)

Frequency		Modulation	Conducted Power (dBm)		Battery	Phantom Position	Antenna Type	SAR(mW/g)
MHz	Channel		Begin	End				
836.52	384 (Mid)	CDMA835	24.95	25.00	Standard	Left Tilt 15°	Intenna	0.486
836.52	384 (Mid)	CDMA835	24.95	24.91	Standard	Right Tilt 15°	Intenna	0.510
ANSI/ IEEE C95.1 2005 – Safety Limit						Head		
Spatial Peak						1.6 W/kg (mW/g)		
Uncontrolled Exposure/ General Population						<small>Averaged over 1 gram</small>		

NOTES:

- The test data reported are the worst-case SAR value with the antenna-head position set in a typical configuration. Test procedures used are according to FCC/OET Bulletin 65, Supplement C [July 2001].
- All modes of operation were investigated and the worst-case are reported.
- Measured Depth of Simulating Tissue is 15.0 cm ± 0.2 cm.
- Tissue parameters and temperatures are listed on the SAR plot.
- Battery Type Standard Extended Slim
Batteries are fully charged for all readings.
- Test Signal Call Mode Manual Test cord Base Station Simulator
- Head SAR was tested under RC3/SO55.
- Justification for reduced test configurations: per FCC/OET Supplement C (July, 2001), if the SAR measured at the middle channel for each test configuration (Left, right, cheek/touch, tilt/ear, extended and retracted) is at least 3.0 dB lower than the SAR limit, testing at the high and low channels is optional for such test configuration(s).

11.4 Measurement Results (CDMA835 Head SAR Tilt Slide Down)

Frequency		Modulation	Conducted Power (dBm)		Battery	Phantom Position	Antenna Type	SAR(mW/g)
MHz	Channel		Begin	End				
836.52	384 (Mid)	CDMA835	24.95	24.90	Standard	Left Tilt 15°	Intenna	0.505
836.52	384 (Mid)	CDMA835	24.95	24.90	Standard	Right Tilt 15°	Intenna	0.562
ANSI/ IEEE C95.1 2005 – Safety Limit						Head		
Spatial Peak						1.6 W/kg (mW/g)		
Uncontrolled Exposure/ General Population						<small>Averaged over 1 gram</small>		

NOTES:

- The test data reported are the worst-case SAR value with the antenna-head position set in a typical configuration. Test procedures used are according to FCC/OET Bulletin 65, Supplement C [July 2001].
- All modes of operation were investigated and the worst-case are reported.
- Measured Depth of Simulating Tissue is 15.0 cm ± 0.2 cm.
- Tissue parameters and temperatures are listed on the SAR plot.
- Battery Type Standard Extended Slim
Batteries are fully charged for all readings.
- Test Signal Call Mode Manual Test cord Base Station Simulator
- Head SAR was tested under RC3/SO55.
- Justification for reduced test configurations: per FCC/OET Supplement C (July, 2001), if the SAR measured at the middle channel for each test configuration (Left, right, cheek/touch, tilt/ear, extended and retracted) is at least 3.0 dB lower than the SAR limit, testing at the high and low channels is optional for such test configuration(s).

11.5 Measurement Results (PCS1900 Head SAR Touch Slide Up)

Frequency		Modulation	Conducted Power (dBm)		Battery	Phantom Position	Antenna Type	SAR(mW/g)
MHz	Channel		Begin	End				
1 851.25	25 (Low)	PCS1900	25.01	25.19	Standard	Left Ear	Intenna	0.764
1 880.00	600 (Mid)	PCS1900	24.83	24.80	Standard	Left Ear	Intenna	1.00
1 908.75	1175 (High)	PCS1900	24.93	24.94	Standard	Left Ear	Intenna	0.804
1 851.25	25 (Low)	PCS1900	25.01	24.86	Standard	Right Ear	Intenna	0.956
1 880.00	600 (Mid)	PCS1900	24.83	24.91	Standard	Right Ear	Intenna	1.39
1 908.75	1175 (High)	PCS1900	24.93	24.84	Standard	Right Ear	Intenna	0.955
ANSI/ IEEE C95.1 2005 – Safety Limit						Head		
Spatial Peak						1.6 W/kg (mW/g)		
Uncontrolled Exposure/ General Population						<small>Averaged over 1 gram</small>		

NOTES:

- 1 The test data reported are the worst-case SAR value with the antenna-head position set in a typical configuration. Test procedures used are according to FCC/OET Bulletin 65, Supplement C [July 2001].
- 2 All modes of operation were investigated and the worst-case are reported.
- 3 Measured Depth of Simulating Tissue is 15.0 cm ± 0.2 cm.
- 4 Tissue parameters and temperatures are listed on the SAR plot.
- 5 Battery Type Standard Extended Slim
 Batteries are fully charged for all readings.
- 6 Test Signal Call Mode Manual Test cord Base Station Simulator
- 7 Head SAR was tested under RC3/SO55.

11.6 Measurement Results (PCS1900 Head SAR Touch Slide Down)

Frequency		Modulation	Conducted Power (dBm)		Battery	Phantom Position	Antenna Type	SAR(mW/g)
MHz	Channel		Begin	End				
1 851.25	25 (Low)	PCS1900	25.01	24.87	Standard	Left Ear	Intenna	1.07
1 880.00	600 (Mid)	PCS1900	24.83	24.80	Standard	Left Ear	Intenna	1.24
1 908.75	1175 (High)	PCS1900	24.93	24.89	Standard	Left Ear	Intenna	1.12
1 851.25	25 (Low)	PCS1900	25.01	24.97	Standard	Right Ear	Intenna	0.856
1 880.00	600 (Mid)	PCS1900	24.83	24.85	Standard	Right Ear	Intenna	0.971
1 908.75	1175 (High)	PCS1900	24.93	24.98	Standard	Right Ear	Intenna	0.956
ANSI/ IEEE C95.1 2005 – Safety Limit						Head		
Spatial Peak						1.6 W/kg (mW/g)		
Uncontrolled Exposure/ General Population						<small>Averaged over 1 gram</small>		

NOTES:

- 1 The test data reported are the worst-case SAR value with the antenna-head position set in a typical configuration. Test procedures used are according to FCC/OET Bulletin 65, Supplement C [July 2001].
- 2 All modes of operation were investigated and the worst-case are reported.
- 3 Measured Depth of Simulating Tissue is 15.0 cm ± 0.2 cm.
- 4 Tissue parameters and temperatures are listed on the SAR plot.
- 5 Battery Type Standard Extended Slim
Batteries are fully charged for all readings.
- 6 Test Signal Call Mode Manual Test cord Base Station Simulator
- 7 Head SAR was tested under RC3/SO55.

11.7 Measurement Results (PCS1900 Head SAR Tilt Slide Up)

Frequency		Modulation	Conducted Power (dBm)		Battery	Phantom Position	Antenna Type	SAR(mW/g)
MHz	Channel		Begin	End				
1 880.00	600 (Mid)	PCS1900	24.83	24.74	Standard	Left Tilt 15°	Intenna	0.959
1 880.00	600 (Mid)	PCS1900	24.83	24.83	Standard	Right Tilt 15°	Intenna	0.756
ANSI/ IEEE C95.1 2005 – Safety Limit						Head		
Spatial Peak						1.6 W/kg (mW/g)		
Uncontrolled Exposure/ General Population						<small>Averaged over 1 gram</small>		

NOTES:

- 1 The test data reported are the worst-case SAR value with the antenna-head position set in a typical configuration. Test procedures used are according to FCC/OET Bulletin 65, Supplement C [July 2001].
- 2 All modes of operation were investigated and the worst-case are reported.
- 3 Measured Depth of Simulating Tissue is 15.0 cm ± 0.2 cm.
- 4 Tissue parameters and temperatures are listed on the SAR plot.
- 5 Battery Type Standard Extended Slim
Batteries are fully charged for all readings.
- 6 Test Signal Call Mode Manual Test cord Base Station Simulator
- 7 Head SAR was tested under RC3/SO55.
- 8 Justification for reduced test configurations: per FCC/OET Supplement C (July, 2001), if the SAR measured at the middle channel for each test configuration (Left, right, cheek/touch, tilt/ear, extended and retracted) is at least 3.0 dB lower than the SAR limit, testing at the high and low channels is optional for such test configuration(s).

11.8 Measurement Results (PCS1900 Head SAR Tilt Slide Down)

Frequency		Modulation	Conducted Power (dBm)		Battery	Phantom Position	Antenna Type	SAR(mW/g)
MHz	Channel		Begin	End				
1 880.00	600 (Mid)	PCS1900	24.83	24.83	Standard	Left Tilt 15°	Intenna	0.331
1 880.00	600 (Mid)	PCS1900	24.83	24.84	Standard	Right Tilt 15°	Intenna	0.256
ANSI/ IEEE C95.1 2005 – Safety Limit						Head		
Spatial Peak						1.6 W/kg (mW/g)		
Uncontrolled Exposure/ General Population						<small>Averaged over 1 gram</small>		

NOTES:

- 1 The test data reported are the worst-case SAR value with the antenna-head position set in a typical configuration. Test procedures used are according to FCC/OET Bulletin 65, Supplement C [July 2001].
- 2 All modes of operation were investigated and the worst-case are reported.
- 3 Measured Depth of Simulating Tissue is 15.0 cm ± 0.2 cm.
- 4 Tissue parameters and temperatures are listed on the SAR plot.
- 5 Battery Type Standard Extended Slim
Batteries are fully charged for all readings.
- 6 Test Signal Call Mode Manual Test cord Base Station Simulator
- 7 Head SAR was tested under RC3/SO55.
- 8 Justification for reduced test configurations: per FCC/OET Supplement C (July, 2001), if the SAR measured at the middle channel for each test configuration (Left, right, cheek/touch, tilt/ear, extended and retracted) is at least 3.0 dB lower than the SAR limit, testing at the high and low channels is optional for such test configuration(s).

11.9 Measurement Results (CDMA835 Body SAR)

Frequency		Modulation	Conducted Power (dBm)		Configuration	Phantom Position	Antenna Type	SAR(mW/g)
MHz	Channel		Begin	End				
824.70	1013 (Low)	EVDO	24.93	24.86	Rear	with Holster	Intenna	0.666
836.52	384 (Mid)	EVDO	24.98	24.94	Rear	with Holster	Intenna	0.826
848.31	777 (High)	EVDO	24.92	24.77	Rear	with Holster	Intenna	0.754
836.52	384 (Mid)	EVDO	24.98	24.99	Front	with Holster	Intenna	0.382
836.52	384 (Mid)	CDMA835	24.97	24.93	Rear	with Holster	Intenna	0.749
2 402	0 (Low)	Bluetooth	0.68	0.49	Rear	with Holster	Intenna	0.000258
ANSI/ IEEE C95.1 2005 – Safety Limit Spatial Peak Uncontrolled Exposure/ General Population						Body 1.6 W/kg (mW/g) <small>Averaged over 1 gram</small>		

NOTES:

- 1 The test data reported are the worst-case SAR value with the antenna-head position set in a typical configuration. Test procedures used are according to FCC/OET Bulletin 65, Supplement C [July 2001].
- 2 All modes of operation were investigated and the worst-case are reported.
- 3 Measured Depth of Simulating Tissue is 15.0 cm ± 0.2 cm.
- 4 Tissue parameters and temperatures are listed on the SAR plot.
- 5 Battery Type Standard Extended Slim
 Batteries are fully charged for all readings.
- 6 Test Signal Call Mode Manual Test cord Base Station Simulator
- 7 Both side of the phone were tested and the worst-case side is reported.
- 8 HEADSET was connected.
- 9 Test Configuration With Holster Without Holster
- 10 Body SAR was tested under RC3/SO32.

11.10 Measurement Results (PCS1900 Body SAR)

Frequency		Modulation	Conducted Power (dBm)		Configuration	Phantom Position	Antenna Type	SAR(mW/g)
MHz	Channel		Begin	End				
1 880.00	600 (Mid)	PCS1900	24.86	24.82	Rear	with Holster	Intenna	0.228
1 880.00	600 (Mid)	EVDO	24.87	24.79	Rear	with Holster	Intenna	0.240
1 880.00	600 (Mid)	EVDO	24.87	25.00	Front	with Holster	Intenna	0.165
ANSI/ IEEE C95.1 2005 – Safety Limit						Body		
Spatial Peak						1.6 W/kg (mW/g)		
Uncontrolled Exposure/ General Population						<small>Averaged over 1 gram</small>		

NOTES:

- 1 The test data reported are the worst-case SAR value with the antenna-head position set in a typical configuration. Test procedures used are according to FCC/OET Bulletin 65, Supplement C [July 2001].
- 2 All modes of operation were investigated and the worst-case are reported.
- 3 Measured Depth of Simulating Tissue is 15.0 cm ± 0.2 cm.
- 4 Tissue parameters and temperatures are listed on the SAR plot.
- 5 Battery Type Standard Extended Slim
Batteries are fully charged for all readings.
- 6 Test Signal Call Mode Manual Test cord Base Station Simulator
- 7 Both side of the phone were tested and the worst-case side is reported.
- 8 HEADSET was connected.
- 9 Test Configuration With Holster Without Holster
- 10 Body SAR was tested under RC3/SO32.

12. CONCLUSION

The SAR measurement indicates that the EUT complies with the RF radiation exposure limits of the ANSI/IEEE C95.1 2005.

These measurements are taken to simulate the RF effects exposure under worst-case conditions. Precise laboratory measures were taken to assure repeatability of the tests.

13. REFERENCES

- [1] Federal Communications Commission, OET Bulletin 65 (Edition 97-01), Supplement C (Edition 01-01), Evaluating Compliance with FCC Guidelines for Human Exposure to Radio frequency Electromagnetic Fields, July 2001.
- [2] IEEE Standards Coordinating Committee 34 – IEEE Std. 1528-2003, IEEE Recommended Practice for Determining the Peak Spatial-Average Specific Absorption Rate (SAR) in the Human Body from Wireless Communications Devices.
- [3] Federal Communications Commission, ET Docket 93-62, Guidelines for Evaluating the Environmental Effects of Radio frequency Radiation, Aug. 1996.
- [4] ANSI/IEEE C95.1 - 1991, American National Standard safety levels with respect to human exposure to radio frequency electromagnetic fields, 300 kHz to 100 GHz, New York: IEEE, Aug. 1992
- [5] ANSI/IEEE C95.3 - 1991, IEEE Recommended Practice for the Measurement of Potentially Hazardous Electromagnetic Fields - RF and Microwave, New York: IEEE, 1992.
- [6] NCRP, National Council on Radiation Protection and Measurements, Biological Effects and Exposure Criteria for Radio Frequency Electromagnetic Fields, NCRP Report No. 86, 1986. Reprinted Feb. 1995.
- [7] T. Schmid, O. Egger, N. Kuster, Automated E-field scanning system for dosimetric assessments, IEEE Transaction on Microwave Theory and Techniques, vol. 44, Jan. 1996, pp. 105-113.
- [8] K. Pokovic, T. Schmid, N. Kuster, Robust setup for precise calibration of E-field probes in tissue simulating liquids at mobile communications frequencies, ICECOM97, Oct. 1997, pp. 120-124.
- [9] K. Pokovic, T. Schmid, and N. Kuster, E-field Probe with improved isotropy in brain simulating liquids, Proceedings of the ELMAR, Zadar, Croatia, June 23-25, 1996, pp. 172-175.
- [10] Schmid & Partner Engineering AG, Application Note: Data Storage and Evaluation, June 1998, p2.
- [11] V. Hombach, K. Meier, M. Burkhardt, E. Kuhn, N. Kuster, The Dependence of EM Energy Absorption upon Human Head Modeling at 900 MHz, IEEE Transaction on Microwave Theory and Techniques, vol. 44 no. 10, Oct. 1996, pp. 1865-1873.
- [12] N. Kuster and Q. Balzano, Energy absorption mechanism by biological bodies in the near field of dipole antennas above 300 MHz, IEEE Transaction on Vehicular Technology, vol. 41, no. 1, Feb. 1992, pp. 17-23.
- [13] G. Hartsgrrove, A. Kraszewski, A. Surowiec, Simulated Biological Materials for Electromagnetic Radiation Absorption Studies, University of Ottawa, Bioelectromagnetics, Canada: 1987, pp. 29-36.
- [14] Q. Balzano, O. Garay, T. Manning Jr., Electromagnetic Energy Exposure of Simulated Users of Portable Cellular Telephones, IEEE Transactions on Vehicular Technology, vol. 44, no.3, Aug. 1995.
- [15] W. Gander, Computer mathematick, Birkhaeuser, Basel, 1992.
- [16] W.H. Press, S.A. Teukolsky, W.T. Vetterling, and B.P. Flannery, Numerical Recipes in C, The Art of Scientific Computing, Second edition, Cambridge University Press, 1992.
- [17] Federal Communications Commission, OET Bulletin 65, Evaluating Compliance with FCC Guidelines for Human Exposure to Radiofrequency Electromagnetic Fields. Supplement C, Dec. 1997.
- [18] N. Kuster, R. Kastle, T. Schmid, Dosimetric evaluation of mobile communications equipment with known precision, IEEE Transaction on Communications, vol. E80-B, no. 5, May 1997, pp. 645-652.
- [19] CENELEC CLC/SC111B, European Prestandard (prENV 50166-2), Human Exposure to Electromagnetic Fields High-frequency: 10 kHz-300 GHz, Jan. 1995.
- [20] Prof. Dr. Niels Kuster, ETH, Eidgenössische Technische Hochschule Zürich, Dosimetric Evaluation of the Cellular Phone.
- [21] FCC SAR Considerations for Cell Phones with Multiple Transmitters #648474, February 2008.

Attachment 1. – SAR Test Plots

Test Laboratory: HCT CO., LTD
EUT Type: Dual-Band CDMA Phone with Bluetooth (CDMA/PCS CDMA)
Liquid Temperature: 21.4 °C
Ambient Temperature: 21.6 °C
Test Date: Apr.05, 2008

DUT: CDM8964; Type: Silde up; Serial: #1

Communication System: CDMA 835MHz FCC; Frequency: 824.7 MHz;Duty Cycle: 1:1
Medium parameters used: $f = 825$ MHz; $\sigma = 0.87$ mho/m; $\epsilon_r = 42.1$; $\rho = 1000$ kg/m³
Phantom section: Left Section ; Measurement SW: DASY4, V4.6 Build 23; Postprocessing SW: SEMCAD, V1.8 Build 176

DASY4 Configuration:

- Probe: ET3DV6 - SN1609; ConvF(6.81, 6.81, 6.81); Calibrated: 2007-08-30
- Sensor-Surface: 4mm (Mechanical Surface Detection)
- Electronics: DAE4 Sn447; Calibrated: 2007-09-13
- Phantom: 835/900 Phamtom ; Type: SAM

Left touch 1013/Area Scan (51x111x1): Measurement grid: dx=15mm, dy=15mm
Maximum value of SAR (interpolated) = 1.20 mW/g

Left touch 1013/Zoom Scan (5x5x7)/Cube 0: Measurement grid: dx=8mm, dy=8mm, dz=5mm
Reference Value = 37.4 V/m; Power Drift = -0.148 dB
Peak SAR (extrapolated) = 1.48 W/kg
SAR(1 g) = 1.13 mW/g; SAR(10 g) = 0.808 mW/g
Maximum value of SAR (measured) = 1.20 mW/g

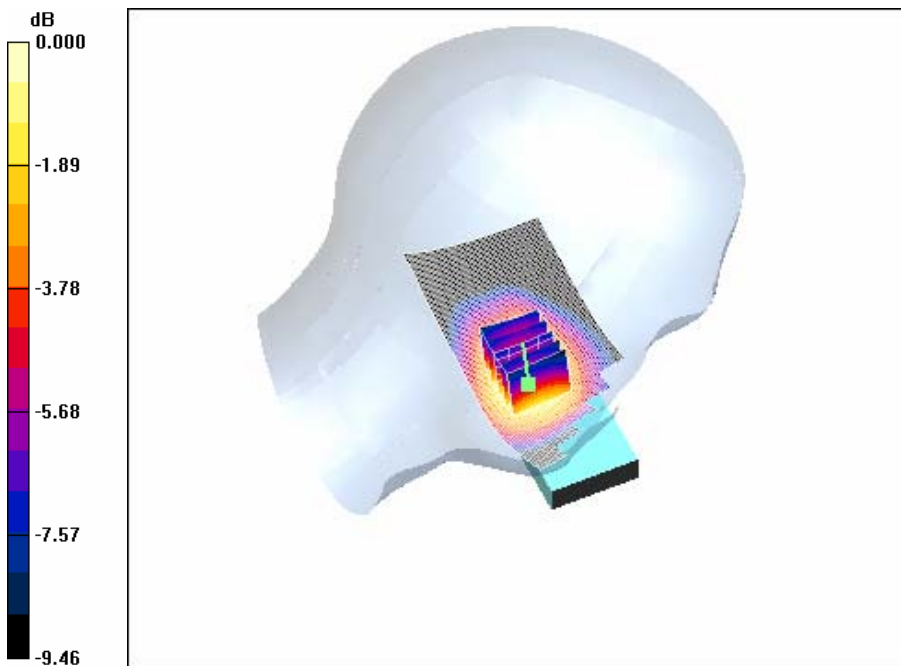

Test Laboratory: HCT CO., LTD
EUT Type: Dual-Band CDMA Phone with Bluetooth (CDMA/PCS CDMA)
Liquid Temperature: 21.4 °C
Ambient Temperature: 21.6 °C
Test Date: Apr.05, 2008

DUT: CDM8964; Type: Silde up; Serial: #1

Communication System: CDMA 835MHz FCC; Frequency: 836.52 MHz;Duty Cycle: 1:1
Medium parameters used (interpolated): $f = 836.52$ MHz; $\sigma = 0.882$ mho/m; $\epsilon_r = 41.9$; $\rho = 1000$ kg/m³
Phantom section: Left Section ; Measurement SW: DASY4, V4.6 Build 23; Postprocessing SW: SEMCAD, V1.8 Build 176

DASY4 Configuration:

- Probe: ET3DV6 - SN1609; ConvF(6.81, 6.81, 6.81); Calibrated: 2007-08-30
- Sensor-Surface: 4mm (Mechanical Surface Detection)
- Electronics: DAE4 Sn447; Calibrated: 2007-09-13
- Phantom: 835/900 Phamtom ; Type: SAM

Left touch 384/Area Scan (51x111x1): Measurement grid: dx=15mm, dy=15mm

[Info: Interpolated medium parameters used for SAR evaluation.](#)

Maximum value of SAR (interpolated) = 1.05 mW/g

Left touch 384/Zoom Scan (5x5x7)/Cube 0: Measurement grid: dx=8mm, dy=8mm, dz=5mm

Reference Value = 34.2 V/m; Power Drift = 0.168 dB

Peak SAR (extrapolated) = 1.27 W/kg

SAR(1 g) = 0.978 mW/g; SAR(10 g) = 0.704 mW/g

[Info: Interpolated medium parameters used for SAR evaluation.](#)

Maximum value of SAR (measured) = 1.04 mW/g

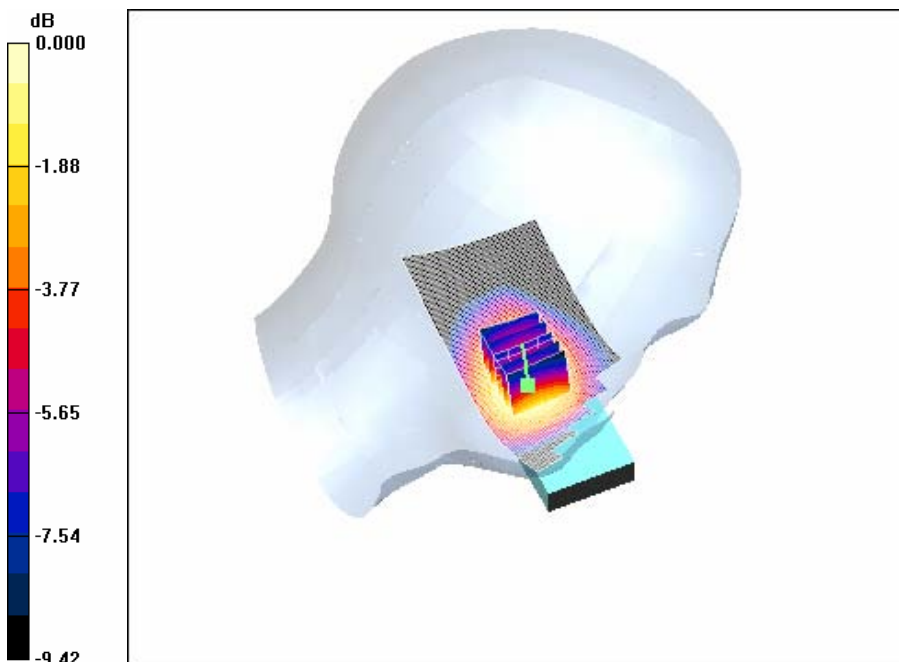

0 dB = 1.04mW/g

Test Laboratory: HCT CO., LTD
EUT Type: Dual-Band CDMA Phone with Bluetooth (CDMA/PCS CDMA)
Liquid Temperature: 21.4 °C
Ambient Temperature: 21.6 °C
Test Date: Apr.05, 2008

DUT: CDM8964; Type: Silde up; Serial: #1

Communication System: CDMA 835MHz FCC; Frequency: 848.31 MHz; Duty Cycle: 1:1
Medium parameters used (interpolated): $f = 848.31$ MHz; $\sigma = 0.891$ mho/m; $\epsilon_r = 41.7$; $\rho = 1000$ kg/m³
Phantom section: Left Section ; Measurement SW: DASY4, V4.6 Build 23; Postprocessing SW: SEMCAD, V1.8 Build 176

DASY4 Configuration:

- Probe: ET3DV6 - SN1609; ConvF(6.81, 6.81, 6.81); Calibrated: 2007-08-30
- Sensor-Surface: 4mm (Mechanical Surface Detection)
- Electronics: DAE4 Sn447; Calibrated: 2007-09-13
- Phantom: 835/900 Phamtom ; Type: SAM

Left touch 777/Area Scan (51x111x1): Measurement grid: dx=15mm, dy=15mm

[Info: Interpolated medium parameters used for SAR evaluation.](#)

Maximum value of SAR (interpolated) = 1.15 mW/g

Left touch 777/Zoom Scan (5x5x7)/Cube 0: Measurement grid: dx=8mm, dy=8mm, dz=5mm

Reference Value = 35.6 V/m; Power Drift = -0.013 dB

Peak SAR (extrapolated) = 1.38 W/kg

SAR(1 g) = 1.06 mW/g; SAR(10 g) = 0.755 mW/g

[Info: Interpolated medium parameters used for SAR evaluation.](#)

Maximum value of SAR (measured) = 1.12 mW/g

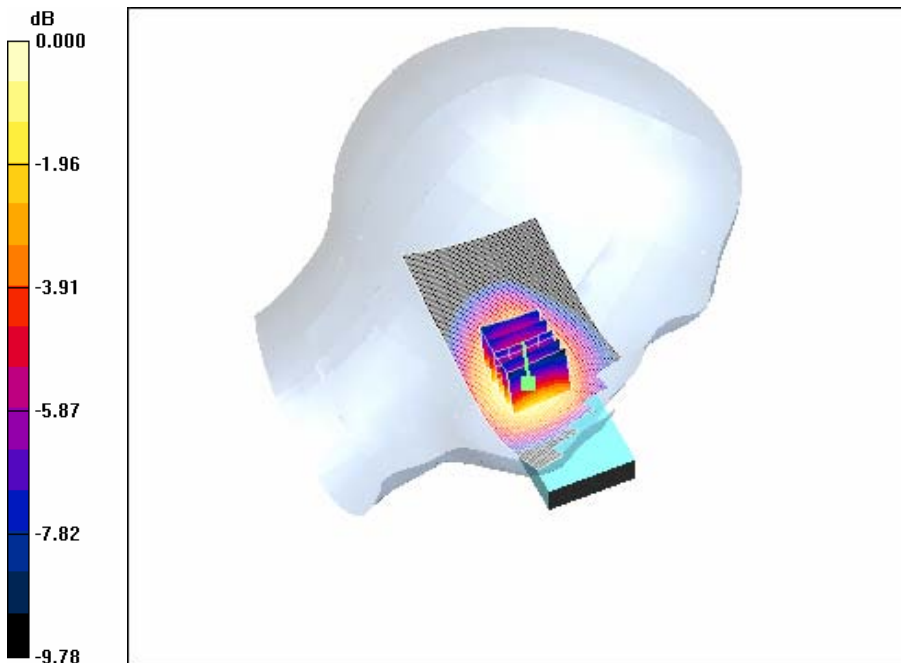

Test Laboratory: HCT CO., LTD
EUT Type: Dual-Band CDMA Phone with Bluetooth (CDMA/PCS CDMA)
Liquid Temperature: 21.4 °C
Ambient Temperature: 21.6 °C
Test Date: Apr.05, 2008

DUT: CDM8964; Type: Silde up; Serial: #1

Communication System: CDMA 835MHz FCC; Frequency: 824.7 MHz;Duty Cycle: 1:1
Medium parameters used: $f = 825$ MHz; $\sigma = 0.87$ mho/m; $\epsilon_r = 42.1$; $\rho = 1000$ kg/m³
Phantom section: Right Section ; Measurement SW: DASY4, V4.6 Build 23; Postprocessing SW: SEMCAD, V1.8 Build 176

DASY4 Configuration:

- Probe: ET3DV6 - SN1609; ConvF(6.81, 6.81, 6.81); Calibrated: 2007-08-30
- Sensor-Surface: 4mm (Mechanical Surface Detection)
- Electronics: DAE4 Sn447; Calibrated: 2007-09-13
- Phantom: 835/900 Phamtom ; Type: SAM

Right touch 1013/Area Scan (51x111x1): Measurement grid: dx=15mm, dy=15mm
Maximum value of SAR (interpolated) = 1.28 mW/g

Right touch 1013/Zoom Scan (5x5x7)/Cube 0: Measurement grid: dx=8mm, dy=8mm, dz=5mm
Reference Value = 38.8 V/m; Power Drift = 0.100 dB
Peak SAR (extrapolated) = 1.58 W/kg
SAR(1 g) = 1.23 mW/g; SAR(10 g) = 0.897 mW/g
Maximum value of SAR (measured) = 1.31 mW/g

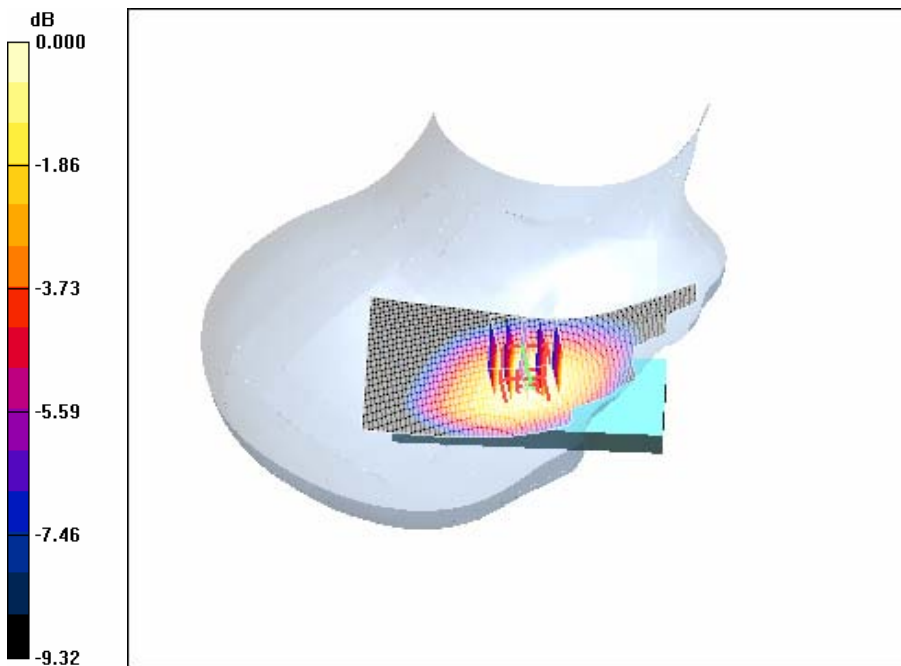

0 dB = 1.31mW/g

Test Laboratory: HCT CO., LTD
EUT Type: Dual-Band CDMA Phone with Bluetooth (CDMA/PCS CDMA)
Liquid Temperature: 21.4 °C
Ambient Temperature: 21.6 °C
Test Date: Apr.05, 2008

DUT: CDM8964; Type: Silde up; Serial: #1

Communication System: CDMA 835MHz FCC; Frequency: 836.52 MHz;Duty Cycle: 1:1
Medium parameters used (interpolated): $f = 836.52$ MHz; $\sigma = 0.882$ mho/m; $\epsilon_r = 41.9$; $\rho = 1000$ kg/m³
Phantom section: Right Section ; Measurement SW: DASY4, V4.6 Build 23; Postprocessing SW: SEMCAD, V1.8 Build 176

DASY4 Configuration:

- Probe: ET3DV6 - SN1609; ConvF(6.81, 6.81, 6.81); Calibrated: 2007-08-30
- Sensor-Surface: 4mm (Mechanical Surface Detection)
- Electronics: DAE4 Sn447; Calibrated: 2007-09-13
- Phantom: 835/900 Phamtom ; Type: SAM

Right touch 384/Area Scan (51x111x1): Measurement grid: dx=15mm, dy=15mm

[Info: Interpolated medium parameters used for SAR evaluation.](#)

Maximum value of SAR (interpolated) = 1.14 mW/g

Right touch 384/Zoom Scan (5x5x7)/Cube 0: Measurement grid: dx=8mm, dy=8mm, dz=5mm

Reference Value = 36.7 V/m; Power Drift = 0.067 dB

Peak SAR (extrapolated) = 1.39 W/kg

SAR(1 g) = 1.08 mW/g; SAR(10 g) = 0.791 mW/g

[Info: Interpolated medium parameters used for SAR evaluation.](#)

Maximum value of SAR (measured) = 1.15 mW/g

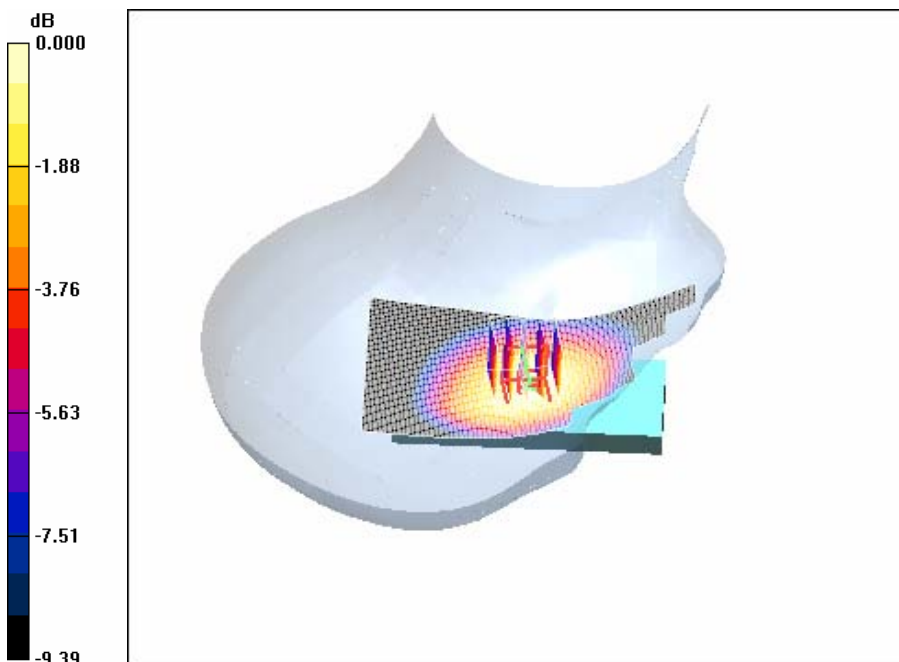

Test Laboratory: HCT CO., LTD
EUT Type: Dual-Band CDMA Phone with Bluetooth (CDMA/PCS CDMA)
Liquid Temperature: 21.4 °C
Ambient Temperature: 21.6 °C
Test Date: Apr.05, 2008

DUT: CDM8964; Type: Silde up; Serial: #1

Communication System: CDMA 835MHz FCC; Frequency: 848.31 MHz; Duty Cycle: 1:1
Medium parameters used (interpolated): $f = 848.31$ MHz; $\sigma = 0.891$ mho/m; $\epsilon_r = 41.7$; $\rho = 1000$ kg/m³
Phantom section: Right Section ; Measurement SW: DASY4, V4.6 Build 23; Postprocessing SW: SEMCAD, V1.8 Build 176

DASY4 Configuration:

- Probe: ET3DV6 - SN1609; ConvF(6.81, 6.81, 6.81); Calibrated: 2007-08-30
- Sensor-Surface: 4mm (Mechanical Surface Detection)
- Electronics: DAE4 Sn447; Calibrated: 2007-09-13
- Phantom: 835/900 Phamtom ; Type: SAM

Right touch 777/Area Scan (51x111x1): Measurement grid: dx=15mm, dy=15mm

[Info: Interpolated medium parameters used for SAR evaluation.](#)

Maximum value of SAR (interpolated) = 1.38 mW/g

Right touch 777/Zoom Scan (5x5x7)/Cube 0: Measurement grid: dx=8mm, dy=8mm, dz=5mm

Reference Value = 39.9 V/m; Power Drift = -0.207 dB

Peak SAR (extrapolated) = 1.66 W/kg

SAR(1 g) = 1.29 mW/g; SAR(10 g) = 0.928 mW/g

[Info: Interpolated medium parameters used for SAR evaluation.](#)

Maximum value of SAR (measured) = 1.39 mW/g

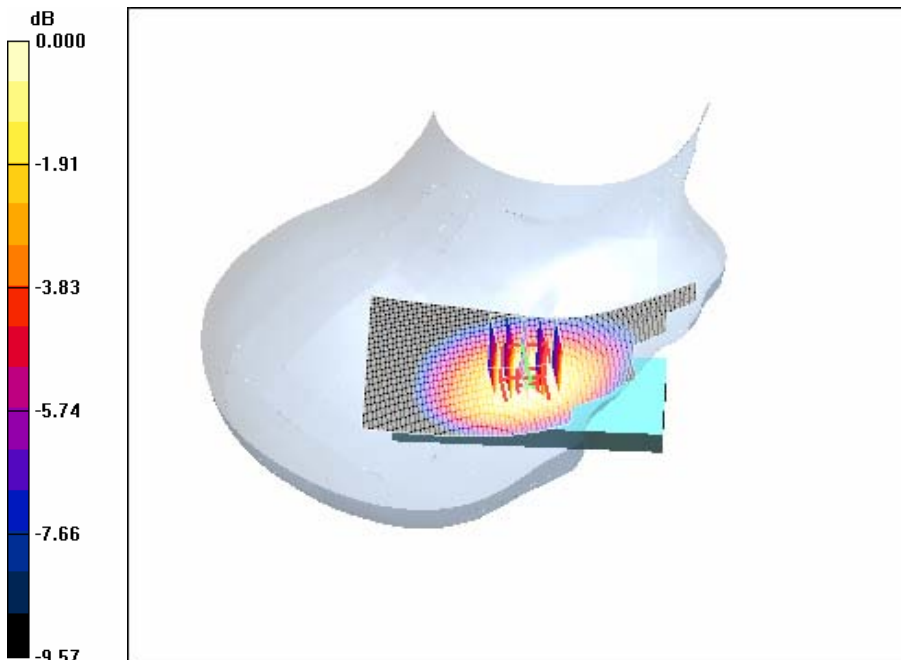

0 dB = 1.39mW/g

Test Laboratory: HCT CO., LTD
EUT Type: Dual-Band CDMA Phone with Bluetooth (CDMA/PCS CDMA)
Liquid Temperature: 21.4 °C
Ambient Temperature: 21.6 °C
Test Date: Apr.05, 2008

DUT: CDM8964; Type: Silde down; Serial: #1

Communication System: CDMA 835MHz FCC; Frequency: 824.7 MHz;Duty Cycle: 1:1
Medium parameters used: $f = 825 \text{ MHz}$; $\sigma = 0.87 \text{ mho/m}$; $\epsilon_r = 42.1$; $\rho = 1000 \text{ kg/m}^3$
Phantom section: Left Section ; Measurement SW: DASY4, V4.6 Build 23; Postprocessing SW: SEMCAD, V1.8 Build 176

DASY4 Configuration:

- Probe: ET3DV6 - SN1609; ConvF(6.81, 6.81, 6.81); Calibrated: 2007-08-30
- Sensor-Surface: 4mm (Mechanical Surface Detection)
- Electronics: DAE4 Sn447; Calibrated: 2007-09-13
- Phantom: 835/900 Phamtom ; Type: SAM

Left touch 1013/Area Scan (51x91x1): Measurement grid: $dx=15\text{mm}$, $dy=15\text{mm}$
Maximum value of SAR (interpolated) = 1.33 mW/g

Left touch 1013/Zoom Scan (5x5x7)/Cube 0: Measurement grid: $dx=8\text{mm}$, $dy=8\text{mm}$, $dz=5\text{mm}$
Reference Value = 37.1 V/m; Power Drift = 0.014 dB
Peak SAR (extrapolated) = 1.71 W/kg
SAR(1 g) = 1.26 mW/g; SAR(10 g) = 0.875 mW/g
Maximum value of SAR (measured) = 1.34 mW/g

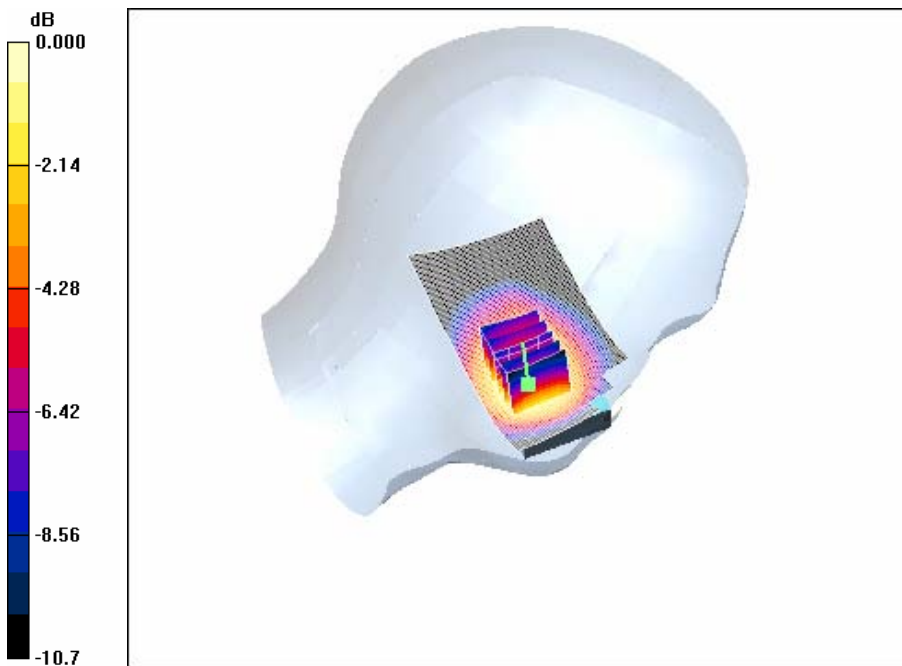

Test Laboratory: HCT CO., LTD
EUT Type: Dual-Band CDMA Phone with Bluetooth (CDMA/PCS CDMA)
Liquid Temperature: 21.4 °C
Ambient Temperature: 21.6 °C
Test Date: Apr.05, 2008

DUT: CDM8964; Type: Silde down; Serial: #1

Communication System: CDMA 835MHz FCC; Frequency: 836.52 MHz;Duty Cycle: 1:1
Medium parameters used (interpolated): $f = 836.52$ MHz; $\sigma = 0.882$ mho/m; $\epsilon_r = 41.9$; $\rho = 1000$ kg/m³
Phantom section: Left Section ; Measurement SW: DASY4, V4.6 Build 23; Postprocessing SW: SEMCAD, V1.8 Build 176

DASY4 Configuration:

- Probe: ET3DV6 - SN1609; ConvF(6.81, 6.81, 6.81); Calibrated: 2007-08-30
- Sensor-Surface: 4mm (Mechanical Surface Detection)
- Electronics: DAE4 Sn447; Calibrated: 2007-09-13
- Phantom: 835/900 Phamtom ; Type: SAM

Left touch 384/Area Scan (51x91x1): Measurement grid: dx=15mm, dy=15mm

[Info: Interpolated medium parameters used for SAR evaluation.](#)

Maximum value of SAR (interpolated) = 1.28 mW/g

Left touch 384/Zoom Scan (5x5x7)/Cube 0: Measurement grid: dx=8mm, dy=8mm, dz=5mm

Reference Value = 37.7 V/m; Power Drift = -0.010 dB

Peak SAR (extrapolated) = 1.63 W/kg

SAR(1 g) = 1.2 mW/g; SAR(10 g) = 0.842 mW/g

[Info: Interpolated medium parameters used for SAR evaluation.](#)

Maximum value of SAR (measured) = 1.27 mW/g

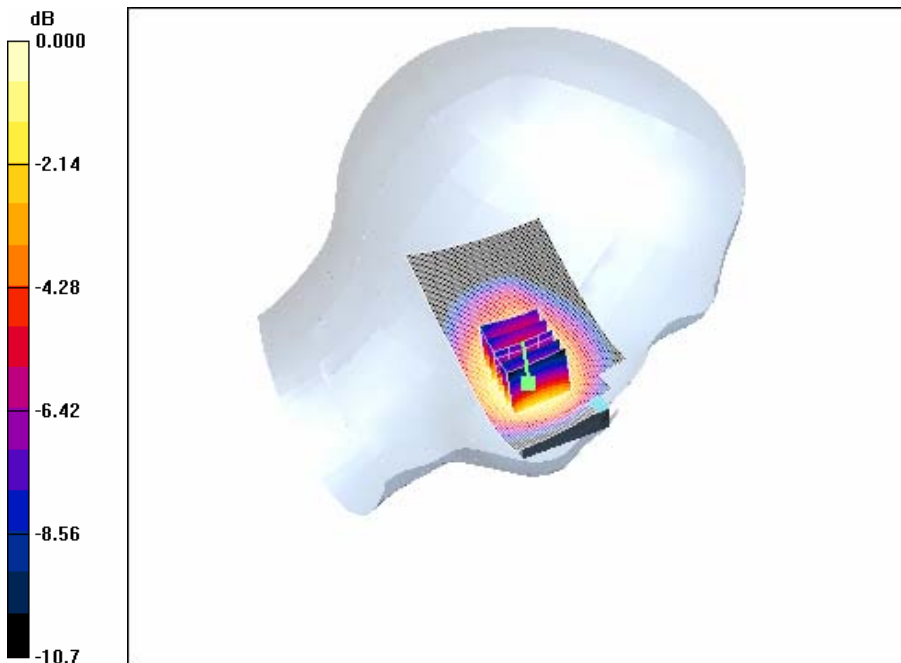

0 dB = 1.27mW/g

Test Laboratory: HCT CO., LTD
EUT Type: Dual-Band CDMA Phone with Bluetooth (CDMA/PCS CDMA)
Liquid Temperature: 21.4 °C
Ambient Temperature: 21.6 °C
Test Date: Apr.05, 2008

DUT: CDM8964; Type: Silde down; Serial: #1

Communication System: CDMA 835MHz FCC; Frequency: 848.31 MHz;Duty Cycle: 1:1
Medium parameters used (interpolated): $f = 848.31$ MHz; $\sigma = 0.891$ mho/m; $\epsilon_r = 41.7$; $\rho = 1000$ kg/m³
Phantom section: Left Section ; Measurement SW: DASY4, V4.6 Build 23; Postprocessing SW: SEMCAD, V1.8 Build 176

DASY4 Configuration:

- Probe: ET3DV6 - SN1609; ConvF(6.81, 6.81, 6.81); Calibrated: 2007-08-30
- Sensor-Surface: 4mm (Mechanical Surface Detection)
- Electronics: DAE4 Sn447; Calibrated: 2007-09-13
- Phantom: 835/900 Phamtom ; Type: SAM

Left touch 777/Area Scan (51x91x1): Measurement grid: dx=15mm, dy=15mm

[Info: Interpolated medium parameters used for SAR evaluation.](#)

Maximum value of SAR (interpolated) = 1.22 mW/g

Left touch 777/Zoom Scan (5x5x7)/Cube 0: Measurement grid: dx=8mm, dy=8mm, dz=5mm

Reference Value = 35.1 V/m; Power Drift = 0.198 dB

Peak SAR (extrapolated) = 1.61 W/kg

SAR(1 g) = 1.15 mW/g; SAR(10 g) = 0.798 mW/g

[Info: Interpolated medium parameters used for SAR evaluation.](#)

Maximum value of SAR (measured) = 1.22 mW/g

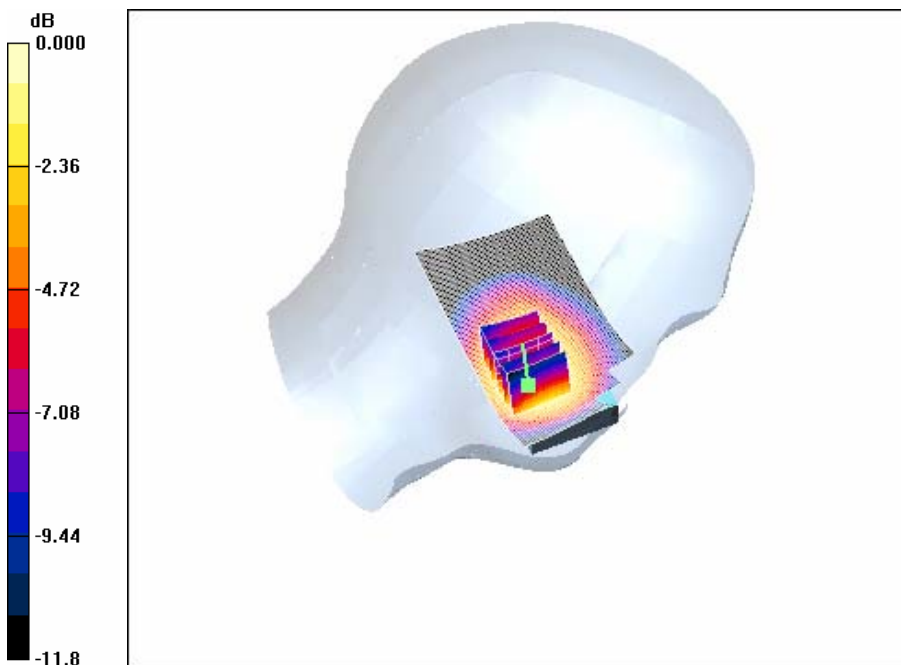

Test Laboratory: HCT CO., LTD
EUT Type: Dual-Band CDMA Phone with Bluetooth (CDMA/PCS CDMA)
Liquid Temperature: 21.4 °C
Ambient Temperature: 21.6 °C
Test Date: Apr.05, 2008

DUT: CDM8964; Type: Silde down; Serial: #1

Communication System: CDMA 835MHz FCC; Frequency: 824.7 MHz;Duty Cycle: 1:1
Medium parameters used: $f = 825 \text{ MHz}$; $\sigma = 0.87 \text{ mho/m}$; $\epsilon_r = 42.1$; $\rho = 1000 \text{ kg/m}^3$
Phantom section: Right Section ; Measurement SW: DASY4, V4.6 Build 23; Postprocessing SW: SEMCAD, V1.8 Build 176

DASY4 Configuration:

- Probe: ET3DV6 - SN1609; ConvF(6.81, 6.81, 6.81); Calibrated: 2007-08-30
- Sensor-Surface: 4mm (Mechanical Surface Detection)
- Electronics: DAE4 Sn447; Calibrated: 2007-09-13
- Phantom: 835/900 Phamtom ; Type: SAM

Right touch 1013/Area Scan (51x91x1): Measurement grid: $dx=15\text{mm}$, $dy=15\text{mm}$
Maximum value of SAR (interpolated) = 1.50 mW/g

Right touch 1013/Zoom Scan (5x5x7)/Cube 0: Measurement grid: $dx=8\text{mm}$, $dy=8\text{mm}$, $dz=5\text{mm}$
Reference Value = 41.7 V/m; Power Drift = -0.082 dB
Peak SAR (extrapolated) = 1.78 W/kg
SAR(1 g) = 1.39 mW/g; SAR(10 g) = 1.01 mW/g
Maximum value of SAR (measured) = 1.48 mW/g

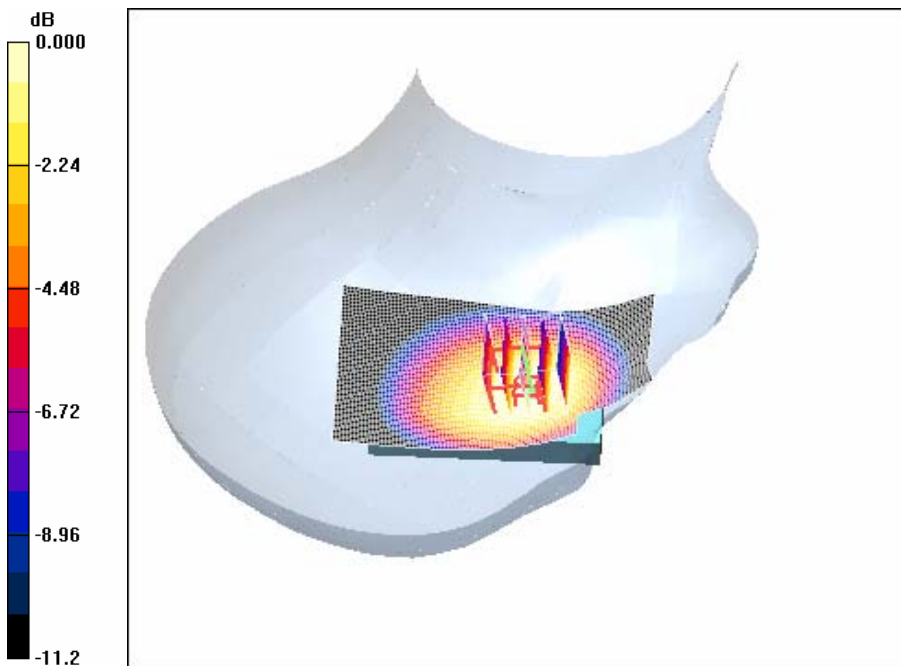

0 dB = 1.48mW/g

Test Laboratory: HCT CO., LTD
EUT Type: Dual-Band CDMA Phone with Bluetooth (CDMA/PCS CDMA)
Liquid Temperature: 21.4 °C
Ambient Temperature: 21.6 °C
Test Date: Apr.05, 2008

DUT: CDM8964; Type: Silde down; Serial: #1

Communication System: CDMA 835MHz FCC; Frequency: 836.52 MHz; Duty Cycle: 1:1
Medium parameters used (interpolated): $f = 836.52$ MHz; $\sigma = 0.882$ mho/m; $\epsilon_r = 41.9$; $\rho = 1000$ kg/m³
Phantom section: Right Section ; Measurement SW: DASY4, V4.6 Build 23; Postprocessing SW: SEMCAD, V1.8 Build 176

DASY4 Configuration:

- Probe: ET3DV6 - SN1609; ConvF(6.81, 6.81, 6.81); Calibrated: 2007-08-30
- Sensor-Surface: 4mm (Mechanical Surface Detection)
- Electronics: DAE4 Sn447; Calibrated: 2007-09-13
- Phantom: 835/900 Phamtom ; Type: SAM

Right touch 384/Area Scan (51x91x1): Measurement grid: dx=15mm, dy=15mm

[Info: Interpolated medium parameters used for SAR evaluation.](#)

Maximum value of SAR (interpolated) = 1.40 mW/g

Right touch 384/Zoom Scan (5x5x7)/Cube 0: Measurement grid: dx=8mm, dy=8mm, dz=5mm

Reference Value = 38.7 V/m; Power Drift = 0.079 dB

Peak SAR (extrapolated) = 1.69 W/kg

SAR(1 g) = 1.32 mW/g; SAR(10 g) = 0.953 mW/g

[Info: Interpolated medium parameters used for SAR evaluation.](#)

Maximum value of SAR (measured) = 1.41 mW/g

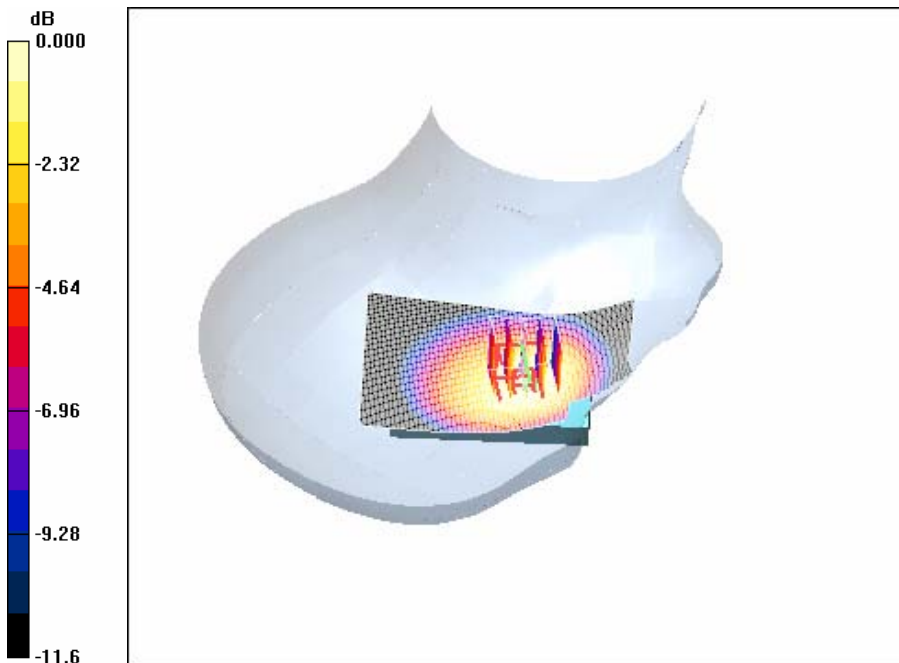

0 dB = 1.41mW/g

Test Laboratory: HCT CO., LTD
EUT Type: Dual-Band CDMA Phone with Bluetooth (CDMA/PCS CDMA)
Liquid Temperature: 21.4 °C
Ambient Temperature: 21.6 °C
Test Date: Apr.05, 2008

DUT: CDM8964; Type: Silde down; Serial: #1

Communication System: CDMA 835MHz FCC; Frequency: 848.31 MHz; Duty Cycle: 1:1
Medium parameters used (interpolated): $f = 848.31$ MHz; $\sigma = 0.891$ mho/m; $\epsilon_r = 41.7$; $\rho = 1000$ kg/m³
Phantom section: Right Section ; Measurement SW: DASY4, V4.6 Build 23; Postprocessing SW: SEMCAD, V1.8 Build 176

DASY4 Configuration:

- Probe: ET3DV6 - SN1609; ConvF(6.81, 6.81, 6.81); Calibrated: 2007-08-30
- Sensor-Surface: 4mm (Mechanical Surface Detection)
- Electronics: DAE4 Sn447; Calibrated: 2007-09-13
- Phantom: 835/900 Phamtom ; Type: SAM

Right touch 777/Area Scan (51x91x1): Measurement grid: dx=15mm, dy=15mm

[Info: Interpolated medium parameters used for SAR evaluation.](#)

Maximum value of SAR (interpolated) = 1.32 mW/g

Right touch 777/Zoom Scan (5x5x7)/Cube 0: Measurement grid: dx=8mm, dy=8mm, dz=5mm

Reference Value = 37.9 V/m; Power Drift = 0.038 dB

Peak SAR (extrapolated) = 1.64 W/kg

SAR(1 g) = 1.26 mW/g; SAR(10 g) = 0.901 mW/g

[Info: Interpolated medium parameters used for SAR evaluation.](#)

Maximum value of SAR (measured) = 1.32 mW/g

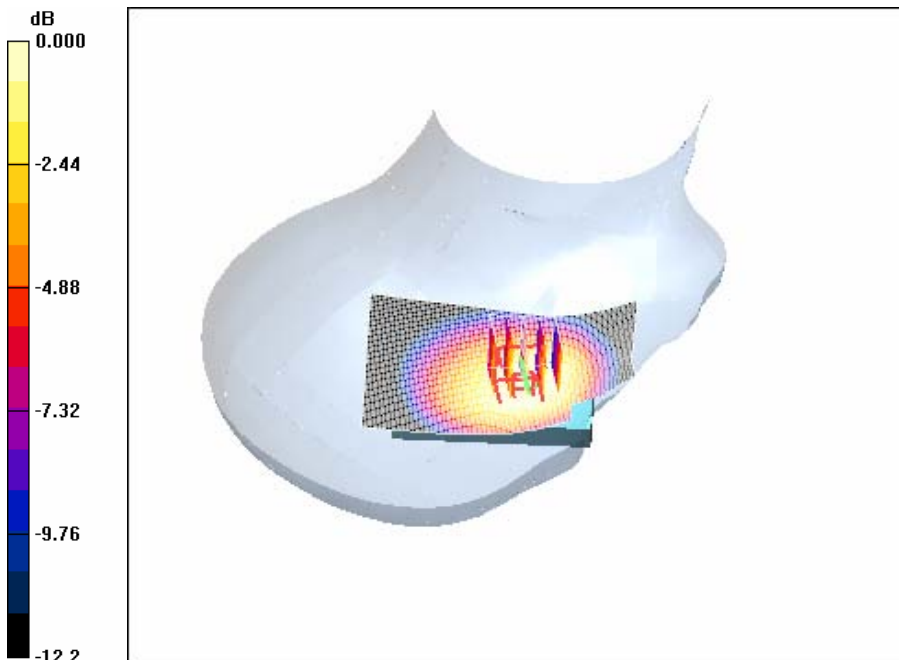

0 dB = 1.32mW/g

Test Laboratory: HCT CO., LTD
EUT Type: Dual-Band CDMA Phone with Bluetooth (CDMA/PCS CDMA)
Liquid Temperature: 21.3 °C
Ambient Temperature: 21.5 °C
Test Date: Apr.06, 2008

DUT: CDM8964; Type: Slide up; Serial: #1

Communication System: 2450MHz FCC(BT); Frequency: 2402 MHz; Duty Cycle: 1:1
Medium parameters used (interpolated): $f = 2402$ MHz; $\sigma = 1.76$ mho/m; $\epsilon_r = 39.1$; $\rho = 1000$ kg/m³
Phantom section: Right Section ; Measurement SW: DASY4, V4.6 Build 23; Postprocessing SW: SEMCAD, V1.8 Build 176

DASY4 Configuration:

- Probe: ET3DV6 - SN1609; ConvF(4.78, 4.78, 4.78); Calibrated: 2007-08-30
- Sensor-Surface: 4mm (Mechanical Surface Detection)
- Electronics: DAE4 Sn447; Calibrated: 2007-09-13
- Phantom: 1800/1900 Phantom; Type: SAM

Right touch 0/Area Scan (61x101x1): Measurement grid: dx=15mm, dy=15mm

[Info: Interpolated medium parameters used for SAR evaluation.](#)

Maximum value of SAR (interpolated) = 0.000 mW/g

Right touch 0/Zoom Scan (5x5x7)/Cube 0: Measurement grid: dx=8mm, dy=8mm, dz=5mm

Reference Value = 0.381 V/m; Power Drift = 0.115 dB

Peak SAR (extrapolated) = 0.001 W/kg

SAR(1 g) = 0.000157 mW/g; SAR(10 g) = 5.7e-005 mW/g

[Info: Interpolated medium parameters used for SAR evaluation.](#)

Maximum value of SAR (measured) = 0.001 mW/g

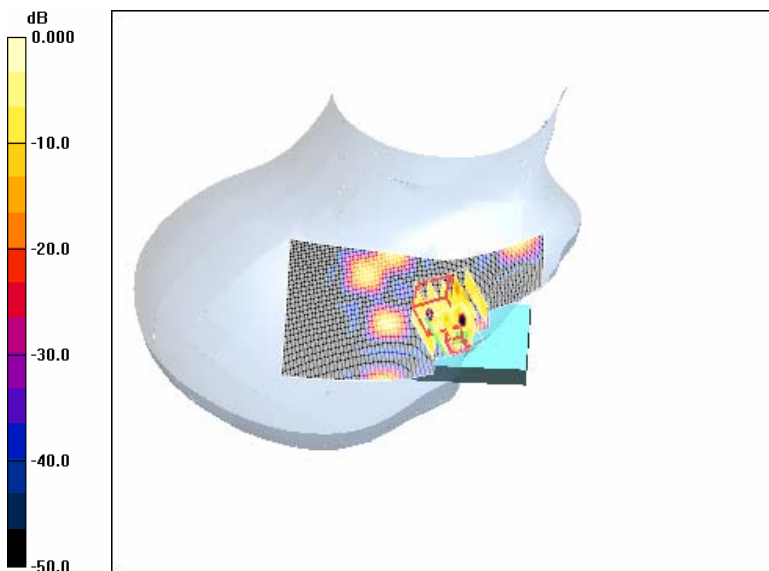

0 dB = 0.001mW/g

Test Laboratory: HCT CO., LTD
EUT Type: Dual-Band CDMA Phone with Bluetooth (CDMA/PCS CDMA)
Liquid Temperature: 21.4 °C
Ambient Temperature: 21.6 °C
Test Date: Apr.05, 2008

DUT: CDM8964; Type: Silde up; Serial: #1

Communication System: CDMA 835MHz FCC; Frequency: 836.52 MHz; Duty Cycle: 1:1
Medium parameters used (interpolated): $f = 836.52$ MHz; $\sigma = 0.882$ mho/m; $\epsilon_r = 41.9$; $\rho = 1000$ kg/m³
Phantom section: Left Section ; Measurement SW: DASY4, V4.6 Build 23; Postprocessing SW: SEMCAD, V1.8 Build 176

DASY4 Configuration:

- Probe: ET3DV6 - SN1609; ConvF(6.81, 6.81, 6.81); Calibrated: 2007-08-30
- Sensor-Surface: 4mm (Mechanical Surface Detection)
- Electronics: DAE4 Sn447; Calibrated: 2007-09-13
- Phantom: 835/900 Phamtom ; Type: SAM

Left touch tilt/Area Scan (51x111x1): Measurement grid: dx=15mm, dy=15mm

[Info: Interpolated medium parameters used for SAR evaluation.](#)

Maximum value of SAR (interpolated) = 0.502 mW/g

Left touch tilt/Zoom Scan (5x5x7)/Cube 0: Measurement grid: dx=8mm, dy=8mm, dz=5mm

Reference Value = 21.5 V/m; Power Drift = 0.046 dB

Peak SAR (extrapolated) = 0.610 W/kg

SAR(1 g) = 0.486 mW/g; SAR(10 g) = 0.361 mW/g

[Info: Interpolated medium parameters used for SAR evaluation.](#)

Maximum value of SAR (measured) = 0.516 mW/g

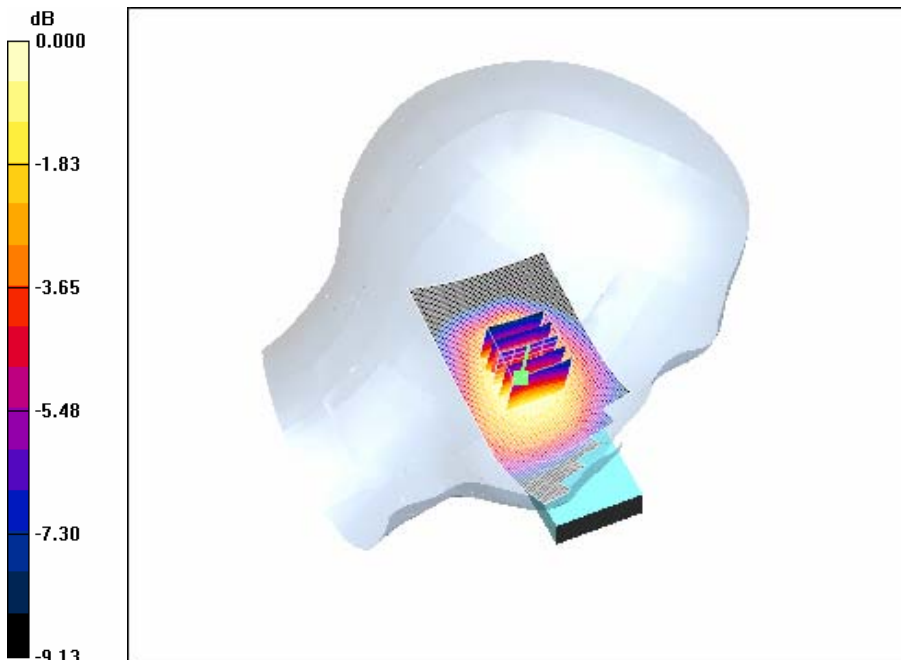

Test Laboratory: HCT CO., LTD
EUT Type: Dual-Band CDMA Phone with Bluetooth (CDMA/PCS CDMA)
Liquid Temperature: 21.4 °C
Ambient Temperature: 21.6 °C
Test Date: Apr.05, 2008

DUT: CDM8964; Type: Silde up; Serial: #1

Communication System: CDMA 835MHz FCC; Frequency: 836.52 MHz; Duty Cycle: 1:1
Medium parameters used (interpolated): $f = 836.52$ MHz; $\sigma = 0.882$ mho/m; $\epsilon_r = 41.9$; $\rho = 1000$ kg/m³
Phantom section: Right Section ; Measurement SW: DASY4, V4.6 Build 23; Postprocessing SW: SEMCAD, V1.8 Build 176

DASY4 Configuration:

- Probe: ET3DV6 - SN1609; ConvF(6.81, 6.81, 6.81); Calibrated: 2007-08-30
- Sensor-Surface: 4mm (Mechanical Surface Detection)
- Electronics: DAE4 Sn447; Calibrated: 2007-09-13
- Phantom: 835/900 Phamtom ; Type: SAM

Right tilt 384/Area Scan (51x111x1): Measurement grid: dx=15mm, dy=15mm

[Info: Interpolated medium parameters used for SAR evaluation.](#)

Maximum value of SAR (interpolated) = 0.532 mW/g

Right tilt 384/Zoom Scan (5x5x7)/Cube 0: Measurement grid: dx=8mm, dy=8mm, dz=5mm

Reference Value = 21.1 V/m; Power Drift = -0.041 dB

Peak SAR (extrapolated) = 0.638 W/kg

SAR(1 g) = 0.510 mW/g; SAR(10 g) = 0.378 mW/g

[Info: Interpolated medium parameters used for SAR evaluation.](#)

Maximum value of SAR (measured) = 0.533 mW/g

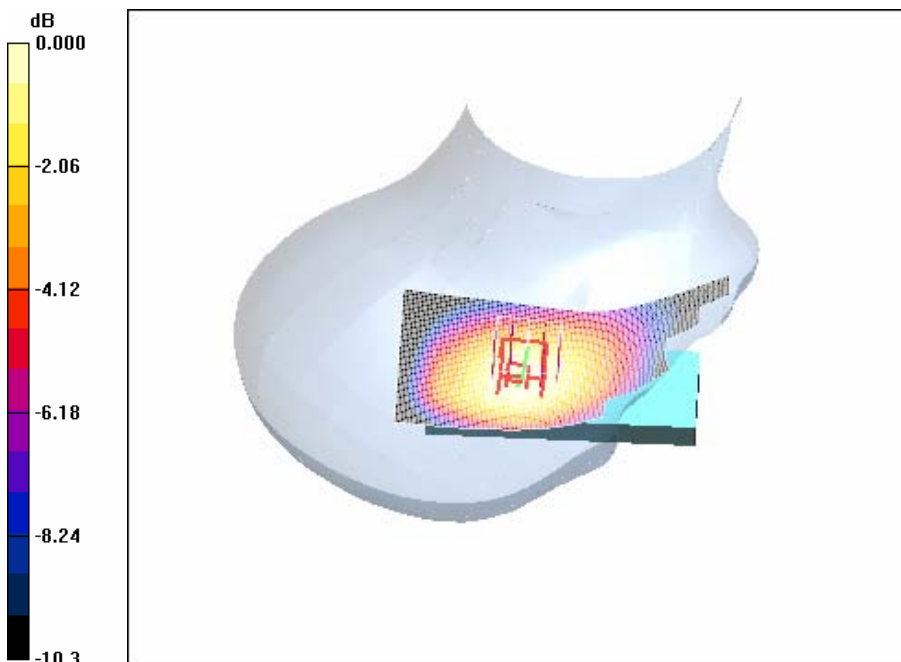

0 dB = 0.533mW/g

Test Laboratory: HCT CO., LTD
EUT Type: Dual-Band CDMA Phone with Bluetooth (CDMA/PCS CDMA)
Liquid Temperature: 21.4 °C
Ambient Temperature: 21.6 °C
Test Date: Apr.05, 2008

DUT: CDM8964; Type: Silde down; Serial: #1

Communication System: CDMA 835MHz FCC; Frequency: 836.52 MHz; Duty Cycle: 1:1
Medium parameters used (interpolated): $f = 836.52$ MHz; $\sigma = 0.882$ mho/m; $\epsilon_r = 41.9$; $\rho = 1000$ kg/m³
Phantom section: Left Section ; Measurement SW: DASY4, V4.6 Build 23; Postprocessing SW: SEMCAD, V1.8 Build 176

DASY4 Configuration:

- Probe: ET3DV6 - SN1609; ConvF(6.81, 6.81, 6.81); Calibrated: 2007-08-30
- Sensor-Surface: 4mm (Mechanical Surface Detection)
- Electronics: DAE4 Sn447; Calibrated: 2007-09-13
- Phantom: 835/900 Phamtom ; Type: SAM

Left tilt 384/Area Scan (51x91x1): Measurement grid: dx=15mm, dy=15mm

[Info: Interpolated medium parameters used for SAR evaluation.](#)

Maximum value of SAR (interpolated) = 0.533 mW/g

Left tilt 384/Zoom Scan (5x5x7)/Cube 0: Measurement grid: dx=8mm, dy=8mm, dz=5mm

Reference Value = 13.3 V/m; Power Drift = -0.054 dB

Peak SAR (extrapolated) = 0.638 W/kg

SAR(1 g) = 0.505 mW/g; SAR(10 g) = 0.369 mW/g

[Info: Interpolated medium parameters used for SAR evaluation.](#)

Maximum value of SAR (measured) = 0.537 mW/g

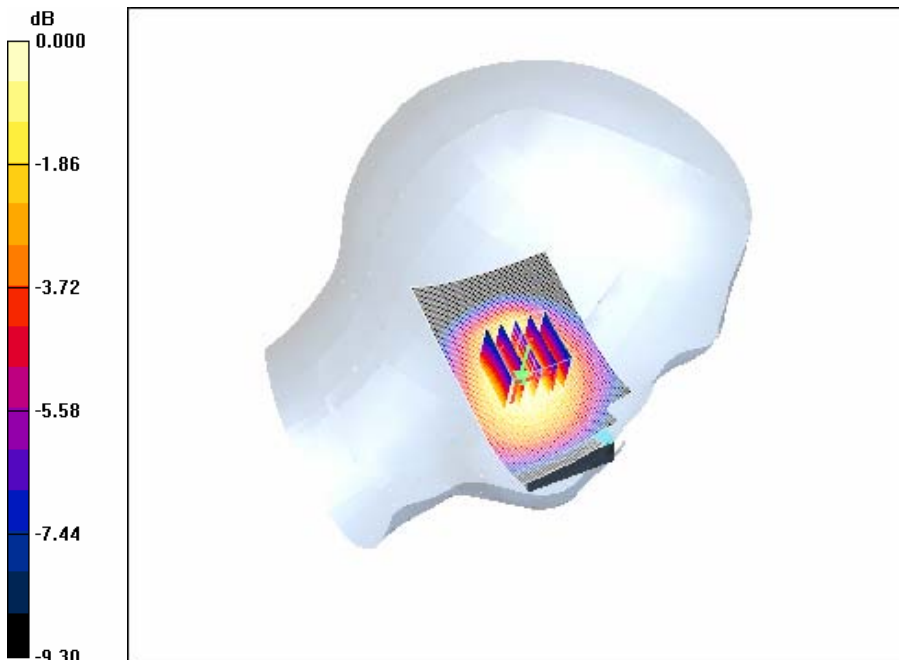

0 dB = 0.537mW/g

Test Laboratory: HCT CO., LTD
EUT Type: Dual-Band CDMA Phone with Bluetooth (CDMA/PCS CDMA)
Liquid Temperature: 21.4 °C
Ambient Temperature: 21.6 °C
Test Date: Apr.05, 2008

DUT: CDM8964; Type: Silde down; Serial: #1

Communication System: CDMA 835MHz FCC; Frequency: 836.52 MHz;Duty Cycle: 1:1
Medium parameters used (interpolated): $f = 836.52$ MHz; $\sigma = 0.882$ mho/m; $\epsilon_r = 41.9$; $\rho = 1000$ kg/m³
Phantom section: Right Section ; Measurement SW: DASY4, V4.6 Build 23; Postprocessing SW: SEMCAD, V1.8 Build 176

DASY4 Configuration:

- Probe: ET3DV6 - SN1609; ConvF(6.81, 6.81, 6.81); Calibrated: 2007-08-30
- Sensor-Surface: 4mm (Mechanical Surface Detection)
- Electronics: DAE4 Sn447; Calibrated: 2007-09-13
- Phantom: 835/900 Phamtom ; Type: SAM

Right tilt 384/Area Scan (51x91x1): Measurement grid: dx=15mm, dy=15mm

[Info: Interpolated medium parameters used for SAR evaluation.](#)

Maximum value of SAR (interpolated) = 0.589 mW/g

Right tilt 384/Zoom Scan (5x5x7)/Cube 0: Measurement grid: dx=8mm, dy=8mm, dz=5mm

Reference Value = 21.3 V/m; Power Drift = -0.045 dB

Peak SAR (extrapolated) = 0.698 W/kg

SAR(1 g) = 0.562 mW/g; SAR(10 g) = 0.419 mW/g

[Info: Interpolated medium parameters used for SAR evaluation.](#)

Maximum value of SAR (measured) = 0.593 mW/g

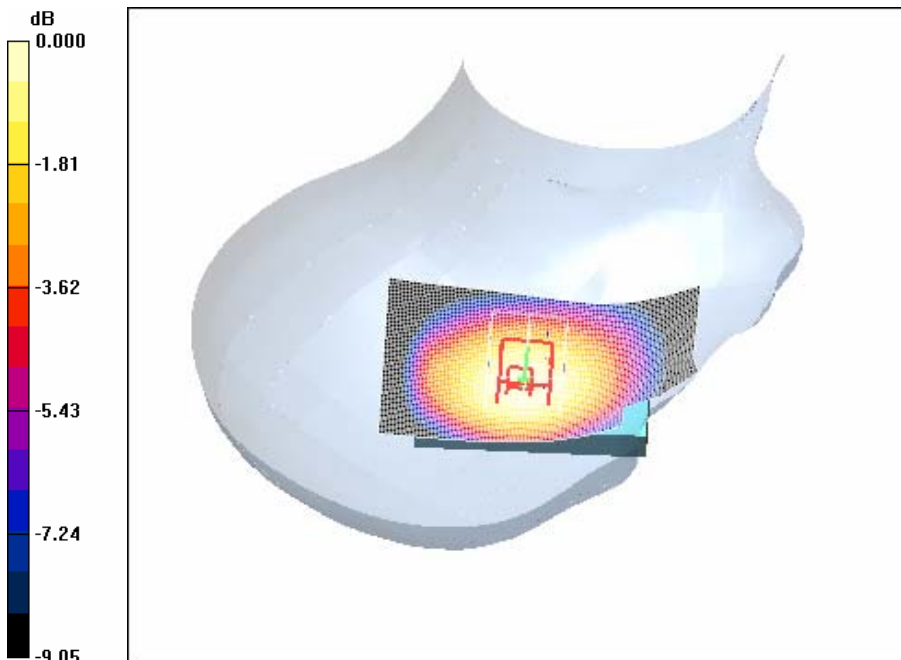

0 dB = 0.593mW/g

Test Laboratory: HCT CO., LTD
EUT Type: Dual-Band CDMA Phone with Bluetooth (CDMA/PCS CDMA)
Liquid Temperature: 21.3 °C
Ambient Temperature: 21.5 °C
Test Date: Apr.06, 2008

DUT: CDM8964; Type: Silde up; Serial: #1

Communication System: PCS 1900; Frequency: 1851.25 MHz; Duty Cycle: 1:1
Medium parameters used (interpolated): $f = 1851.25$ MHz; $\sigma = 1.42$ mho/m; $\epsilon_r = 38.9$; $\rho = 1000$ kg/m³
Phantom section: Left Section ; Measurement SW: DASY4, V4.6 Build 23; Postprocessing SW: SEMCAD, V1.8 Build 176

DASY4 Configuration:

- Probe: ET3DV6 - SN1609; ConvF(5.36, 5.36, 5.36); Calibrated: 2007-08-30
- Sensor-Surface: 4mm (Mechanical Surface Detection)
- Electronics: DAE4 Sn447; Calibrated: 2007-09-13
- Phantom: 1800/1900 Phantom; Type: SAM

Left touch 25/Area Scan (51x111x1): Measurement grid: dx=15mm, dy=15mm

[Info: Interpolated medium parameters used for SAR evaluation.](#)

Maximum value of SAR (interpolated) = 0.799 mW/g

Left touch 25/Zoom Scan (5x5x7)/Cube 0: Measurement grid: dx=8mm, dy=8mm, dz=5mm

Reference Value = 23.4 V/m; Power Drift = 0.179 dB

Peak SAR (extrapolated) = 1.10 W/kg

SAR(1 g) = 0.764 mW/g; SAR(10 g) = 0.490 mW/g

[Info: Interpolated medium parameters used for SAR evaluation.](#)

Maximum value of SAR (measured) = 0.808 mW/g

Left touch 25/Zoom Scan (5x5x7)/Cube 1: Measurement grid: dx=8mm, dy=8mm, dz=5mm

Reference Value = 23.4 V/m; Power Drift = 0.179 dB

Peak SAR (extrapolated) = 0.683 W/kg

SAR(1 g) = 0.465 mW/g; SAR(10 g) = 0.284 mW/g

[Info: Interpolated medium parameters used for SAR evaluation.](#)

Maximum value of SAR (measured) = 0.516 mW/g

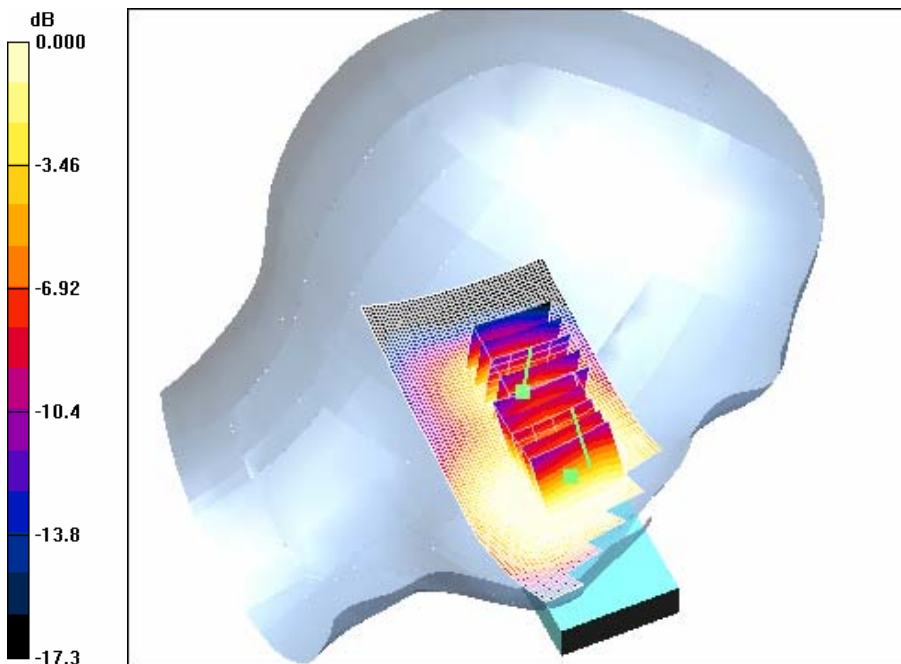

0 dB = 0.516mW/g

Test Laboratory: HCT CO., LTD
EUT Type: Dual-Band CDMA Phone with Bluetooth (CDMA/PCS CDMA)
Liquid Temperature: 21.3 °C
Ambient Temperature: 21.5 °C
Test Date: Apr.06, 2008

DUT: CDM8964; Type: Silde up; Serial: #1

Communication System: PCS 1900; Frequency: 1880 MHz;Duty Cycle: 1:1
Medium parameters used: $f = 1880$ MHz; $\sigma = 1.45$ mho/m; $\epsilon_r = 38.8$; $\rho = 1000$ kg/m³
Phantom section: Left Section ; Measurement SW: DASY4, V4.6 Build 23; Postprocessing SW: SEMCAD, V1.8 Build 176

DASY4 Configuration:

- Probe: ET3DV6 - SN1609; ConvF(5.36, 5.36, 5.36); Calibrated: 2007-08-30
- Sensor-Surface: 4mm (Mechanical Surface Detection)
- Electronics: DAE4 Sn447; Calibrated: 2007-09-13
- Phantom: 1800/1900 Phantom; Type: SAM

Left touch 600/Area Scan (51x111x1): Measurement grid: dx=15mm, dy=15mm
Maximum value of SAR (interpolated) = 1.07 mW/g

Left touch 600/Zoom Scan (5x5x7)/Cube 0: Measurement grid: dx=8mm, dy=8mm, dz=5mm
Reference Value = 27.2 V/m; Power Drift = -0.027 dB
Peak SAR (extrapolated) = 1.46 W/kg
SAR(1 g) = 1.00 mW/g; SAR(10 g) = 0.631 mW/g
Maximum value of SAR (measured) = 1.05 mW/g

Left touch 600/Zoom Scan (5x5x7)/Cube 1: Measurement grid: dx=8mm, dy=8mm, dz=5mm
Reference Value = 27.2 V/m; Power Drift = -0.027 dB
Peak SAR (extrapolated) = 0.891 W/kg
SAR(1 g) = 0.584 mW/g; SAR(10 g) = 0.346 mW/g
Maximum value of SAR (measured) = 0.650 mW/g

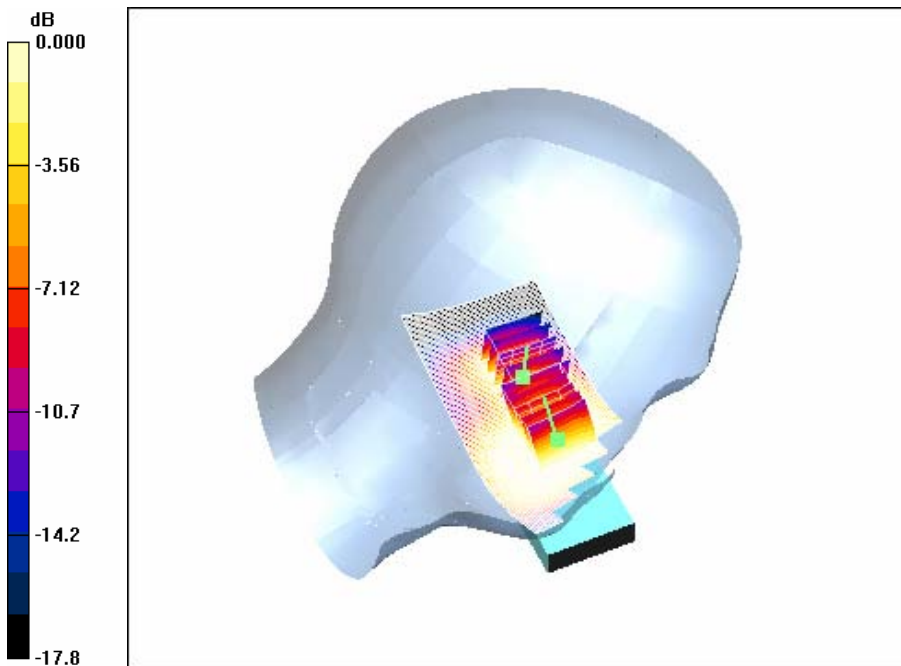

0 dB = 0.650mW/g

Test Laboratory: HCT CO., LTD
EUT Type: Dual-Band CDMA Phone with Bluetooth (CDMA/PCS CDMA)
Liquid Temperature: 21.3 °C
Ambient Temperature: 21.5 °C
Test Date: Apr.06, 2008

DUT: CDM8964; Type: Silde up; Serial: #1

Communication System: PCS 1900; Frequency: 1908.75 MHz; Duty Cycle: 1:1
Medium parameters used (interpolated): $f = 1908.75$ MHz; $\sigma = 1.46$ mho/m; $\epsilon_r = 38.6$; $\rho = 1000$ kg/m³
Phantom section: Left Section ; Measurement SW: DASY4, V4.6 Build 23; Postprocessing SW: SEMCAD, V1.8 Build 176

DASY4 Configuration:

- Probe: ET3DV6 - SN1609; ConvF(5.36, 5.36, 5.36); Calibrated: 2007-08-30
- Sensor-Surface: 4mm (Mechanical Surface Detection)
- Electronics: DAE4 Sn447; Calibrated: 2007-09-13
- Phantom: 1800/1900 Phantom; Type: SAM

Left touch 1175/Area Scan (51x111x1): Measurement grid: dx=15mm, dy=15mm

[Info: Interpolated medium parameters used for SAR evaluation.](#)

Maximum value of SAR (interpolated) = 0.800 mW/g

Left touch 1175/Zoom Scan (5x5x7)/Cube 0: Measurement grid: dx=8mm, dy=8mm, dz=5mm

Reference Value = 23.2 V/m; Power Drift = 0.015 dB

Peak SAR (extrapolated) = 1.22 W/kg

SAR(1 g) = 0.804 mW/g; SAR(10 g) = 0.496 mW/g

[Info: Interpolated medium parameters used for SAR evaluation.](#)

Maximum value of SAR (measured) = 0.848 mW/g

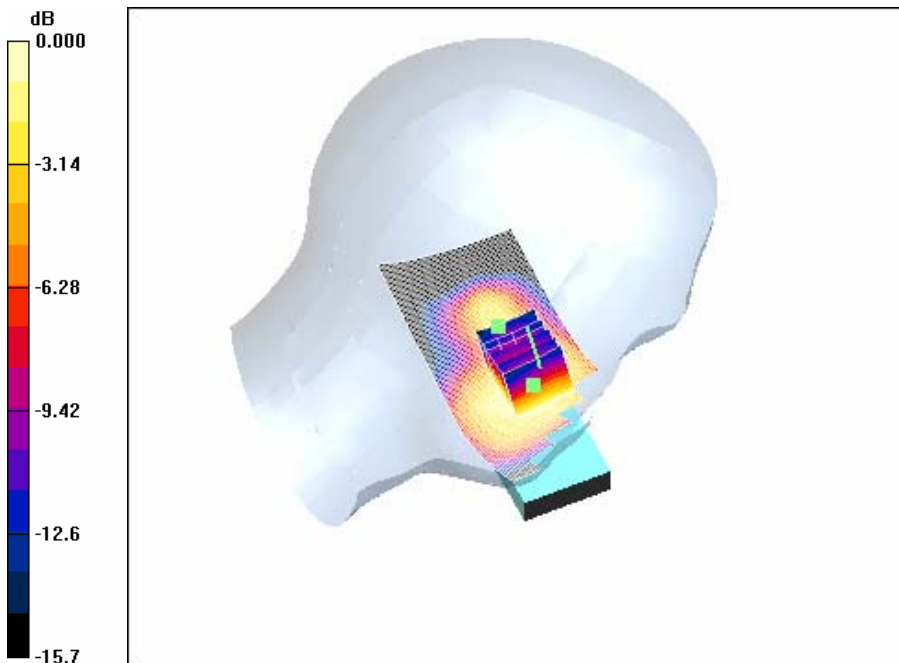

0 dB = 0.848mW/g

Test Laboratory: HCT CO., LTD
EUT Type: Dual-Band CDMA Phone with Bluetooth (CDMA/PCS CDMA)
Liquid Temperature: 21.3 °C
Ambient Temperature: 21.5 °C
Test Date: Apr.06, 2008

DUT: CDM8964; Type: Silde up; Serial: #1

Communication System: PCS 1900; Frequency: 1851.25 MHz; Duty Cycle: 1:1
Medium parameters used (interpolated): $f = 1851.25$ MHz; $\sigma = 1.42$ mho/m; $\epsilon_r = 38.9$; $\rho = 1000$ kg/m³
Phantom section: Right Section ; Measurement SW: DASY4, V4.6 Build 23; Postprocessing SW: SEMCAD, V1.8 Build 176

DASY4 Configuration:

- Probe: ET3DV6 - SN1609; ConvF(5.36, 5.36, 5.36); Calibrated: 2007-08-30
- Sensor-Surface: 4mm (Mechanical Surface Detection)
- Electronics: DAE4 Sn447; Calibrated: 2007-09-13
- Phantom: 1800/1900 Phantom; Type: SAM

Right touch 25/Area Scan (51x111x1): Measurement grid: dx=15mm, dy=15mm

[Info: Interpolated medium parameters used for SAR evaluation.](#)

Maximum value of SAR (interpolated) = 1.05 mW/g

Right touch 25/Zoom Scan (5x5x7)/Cube 0: Measurement grid: dx=8mm, dy=8mm, dz=5mm

Reference Value = 27.4 V/m; Power Drift = -0.146 dB

Peak SAR (extrapolated) = 1.32 W/kg

SAR(1 g) = 0.956 mW/g; SAR(10 g) = 0.606 mW/g

[Info: Interpolated medium parameters used for SAR evaluation.](#)

Maximum value of SAR (measured) = 1.05 mW/g

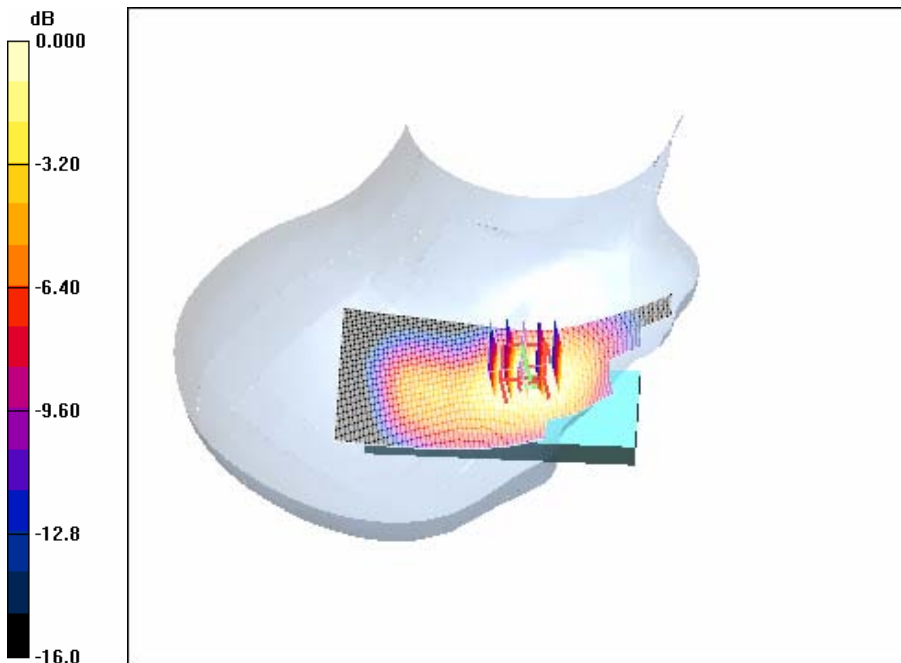

0 dB = 1.05mW/g

Test Laboratory: HCT CO., LTD
EUT Type: Dual-Band CDMA Phone with Bluetooth (CDMA/PCS CDMA)
Liquid Temperature: 21.3 °C
Ambient Temperature: 21.5 °C
Test Date: Apr.06, 2008

DUT: CDM8964; Type: Silde up; Serial: #1

Communication System: PCS 1900; Frequency: 1880 MHz; Duty Cycle: 1:1
Medium parameters used: $f = 1880$ MHz; $\sigma = 1.45$ mho/m; $\epsilon_r = 38.8$; $\rho = 1000$ kg/m³
Phantom section: Right Section ; Measurement SW: DASY4, V4.6 Build 23; Postprocessing SW: SEMCAD, V1.8 Build 176

DASY4 Configuration:

- Probe: ET3DV6 - SN1609; ConvF(5.36, 5.36, 5.36); Calibrated: 2007-08-30
- Sensor-Surface: 4mm (Mechanical Surface Detection)
- Electronics: DAE4 Sn447; Calibrated: 2007-09-13
- Phantom: 1800/1900 Phantom; Type: SAM

Right touch 600/Area Scan (51x111x1): Measurement grid: dx=15mm, dy=15mm
Maximum value of SAR (interpolated) = 1.51 mW/g

Right touch 600/Zoom Scan (5x5x7)/Cube 0: Measurement grid: dx=8mm, dy=8mm, dz=5mm
Reference Value = 30.4 V/m; Power Drift = 0.077 dB
Peak SAR (extrapolated) = 2.01 W/kg
SAR(1 g) = 1.39 mW/g; SAR(10 g) = 0.845 mW/g
Maximum value of SAR (measured) = 1.54 mW/g

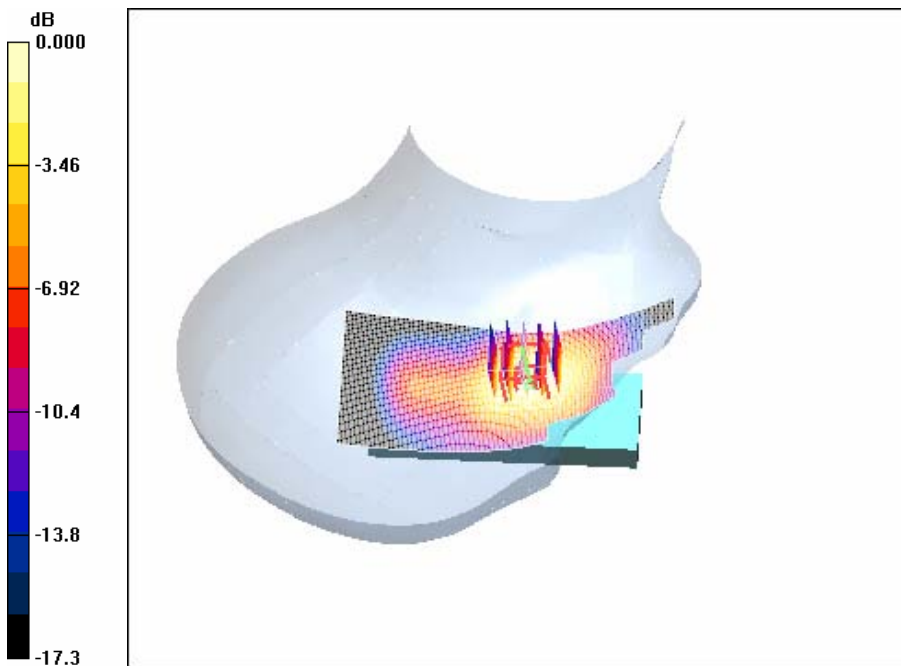

0 dB = 1.54mW/g

Test Laboratory: HCT CO., LTD
EUT Type: Dual-Band CDMA Phone with Bluetooth (CDMA/PCS CDMA)
Liquid Temperature: 21.3 °C
Ambient Temperature: 21.5 °C
Test Date: Apr.06, 2008

DUT: CDM8964; Type: Silde up; Serial: #1

Communication System: PCS 1900; Frequency: 1908.75 MHz; Duty Cycle: 1:1
Medium parameters used (interpolated): $f = 1908.75$ MHz; $\sigma = 1.46$ mho/m; $\epsilon_r = 38.6$; $\rho = 1000$ kg/m³
Phantom section: Right Section ; Measurement SW: DASY4, V4.6 Build 23; Postprocessing SW: SEMCAD, V1.8 Build 176

DASY4 Configuration:

- Probe: ET3DV6 - SN1609; ConvF(5.36, 5.36, 5.36); Calibrated: 2007-08-30
- Sensor-Surface: 4mm (Mechanical Surface Detection)
- Electronics: DAE4 Sn447; Calibrated: 2007-09-13
- Phantom: 1800/1900 Phantom; Type: SAM

Right touch 1175/Area Scan (51x111x1): Measurement grid: dx=15mm, dy=15mm

[Info: Interpolated medium parameters used for SAR evaluation.](#)

Maximum value of SAR (interpolated) = 1.07 mW/g

Right touch 1175/Zoom Scan (5x5x7)/Cube 0: Measurement grid: dx=8mm, dy=8mm, dz=5mm

Reference Value = 26.3 V/m; Power Drift = -0.086 dB

Peak SAR (extrapolated) = 1.34 W/kg

SAR(1 g) = 0.955 mW/g; SAR(10 g) = 0.596 mW/g

[Info: Interpolated medium parameters used for SAR evaluation.](#)

Maximum value of SAR (measured) = 1.05 mW/g

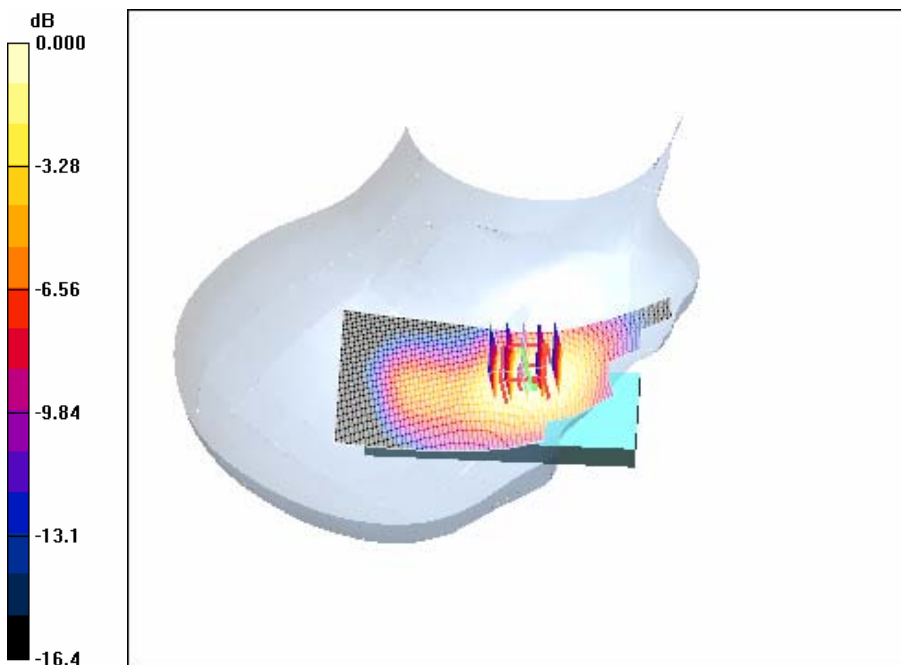

0 dB = 1.05mW/g

Test Laboratory: HCT CO., LTD
EUT Type: Dual-Band CDMA Phone with Bluetooth (CDMA/PCS CDMA)
Liquid Temperature: 21.3 °C
Ambient Temperature: 21.5 °C
Test Date: Apr.06, 2008

DUT: CDM8964; Type: Silde down; Serial: #1

Communication System: PCS 1900; Frequency: 1851.25 MHz; Duty Cycle: 1:1
Medium parameters used (interpolated): $f = 1851.25$ MHz; $\sigma = 1.42$ mho/m; $\epsilon_r = 38.9$; $\rho = 1000$ kg/m³
Phantom section: Left Section ; Measurement SW: DASY4, V4.6 Build 23; Postprocessing SW: SEMCAD, V1.8 Build 176

DASY4 Configuration:

- Probe: ET3DV6 - SN1609; ConvF(5.36, 5.36, 5.36); Calibrated: 2007-08-30
- Sensor-Surface: 4mm (Mechanical Surface Detection)
- Electronics: DAE4 Sn447; Calibrated: 2007-09-13
- Phantom: 1800/1900 Phantom; Type: SAM

Left touch 25/Area Scan (51x91x1): Measurement grid: dx=15mm, dy=15mm

[Info: Interpolated medium parameters used for SAR evaluation.](#)

Maximum value of SAR (interpolated) = 1.24 mW/g

Left touch 25/Zoom Scan (5x5x7)/Cube 0: Measurement grid: dx=8mm, dy=8mm, dz=5mm

Reference Value = 23.9 V/m; Power Drift = -0.143 dB

Peak SAR (extrapolated) = 1.74 W/kg

SAR(1 g) = 1.07 mW/g; SAR(10 g) = 0.583 mW/g

[Info: Interpolated medium parameters used for SAR evaluation.](#)

Maximum value of SAR (measured) = 1.21 mW/g

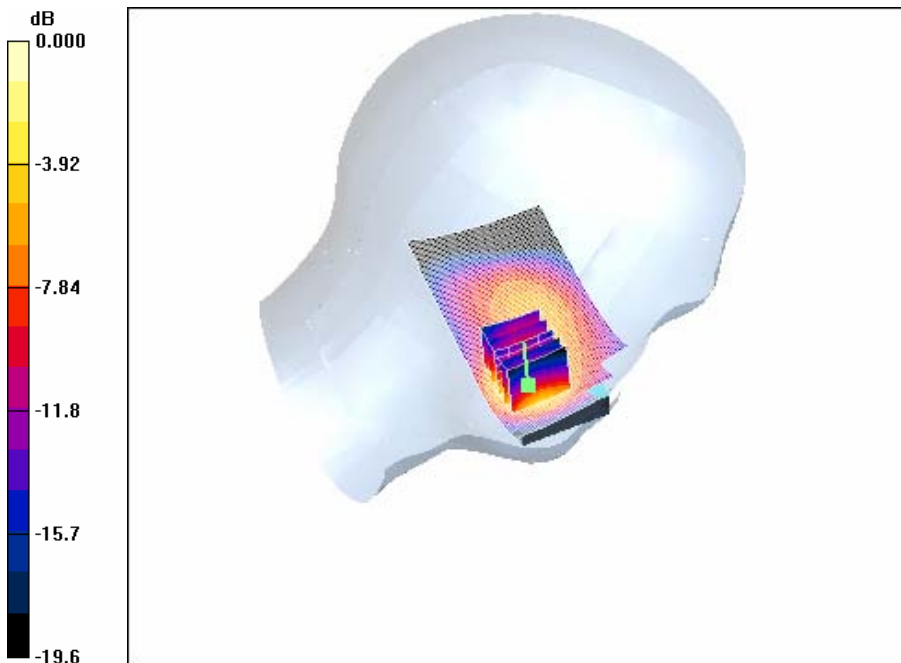

0 dB = 1.21mW/g

Test Laboratory: HCT CO., LTD
EUT Type: Dual-Band CDMA Phone with Bluetooth (CDMA/PCS CDMA)
Liquid Temperature: 21.3 °C
Ambient Temperature: 21.5 °C
Test Date: Apr.06, 2008

DUT: CDM8964; Type: Silde down; Serial: #1

Communication System: PCS 1900; Frequency: 1880 MHz;Duty Cycle: 1:1
Medium parameters used: $f = 1880$ MHz; $\sigma = 1.45$ mho/m; $\epsilon_r = 38.8$; $\rho = 1000$ kg/m³
Phantom section: Left Section ; Measurement SW: DASY4, V4.6 Build 23; Postprocessing SW: SEMCAD, V1.8 Build 176

DASY4 Configuration:

- Probe: ET3DV6 - SN1609; ConvF(5.36, 5.36, 5.36); Calibrated: 2007-08-30
- Sensor-Surface: 4mm (Mechanical Surface Detection)
- Electronics: DAE4 Sn447; Calibrated: 2007-09-13
- Phantom: 1800/1900 Phantom; Type: SAM

Left touch 600/Area Scan (51x91x1): Measurement grid: dx=15mm, dy=15mm
Maximum value of SAR (interpolated) = 1.47 mW/g

Left touch 600/Zoom Scan (5x5x7)/Cube 0: Measurement grid: dx=8mm, dy=8mm, dz=5mm
Reference Value = 25.6 V/m; Power Drift = -0.034 dB
Peak SAR (extrapolated) = 2.03 W/kg
SAR(1 g) = 1.24 mW/g; SAR(10 g) = 0.679 mW/g
Maximum value of SAR (measured) = 1.42 mW/g

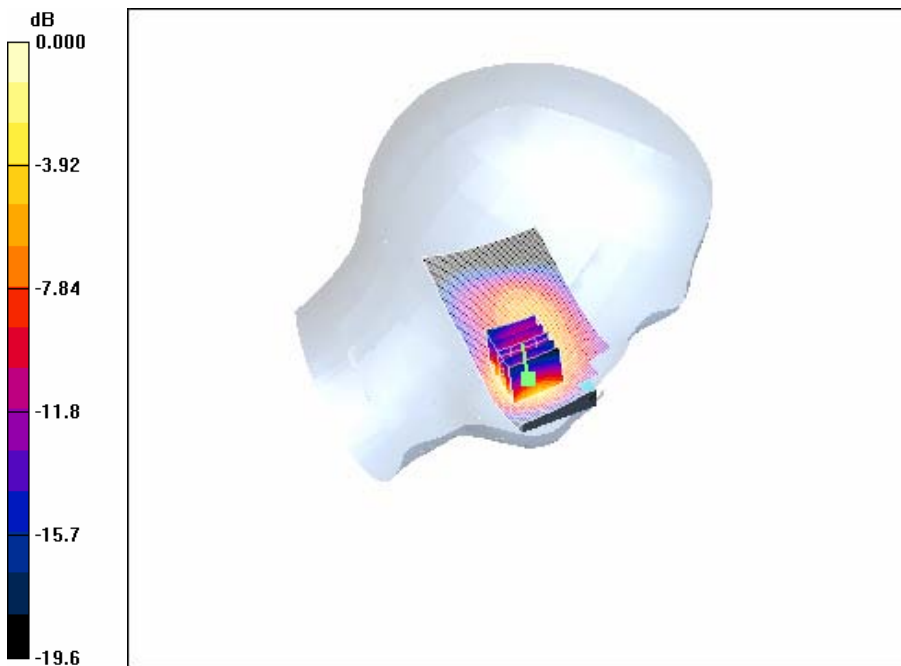

Test Laboratory: HCT CO., LTD
EUT Type: Dual-Band CDMA Phone with Bluetooth (CDMA/PCS CDMA)
Liquid Temperature: 21.3 °C
Ambient Temperature: 21.5 °C
Test Date: Apr.06, 2008

DUT: CDM8964; Type: Silde down; Serial: #1

Communication System: PCS 1900; Frequency: 1908.75 MHz; Duty Cycle: 1:1
Medium parameters used (interpolated): $f = 1908.75$ MHz; $\sigma = 1.46$ mho/m; $\epsilon_r = 38.6$; $\rho = 1000$ kg/m³
Phantom section: Left Section ; Measurement SW: DASY4, V4.6 Build 23; Postprocessing SW: SEMCAD, V1.8 Build 176

DASY4 Configuration:

- Probe: ET3DV6 - SN1609; ConvF(5.36, 5.36, 5.36); Calibrated: 2007-08-30
- Sensor-Surface: 4mm (Mechanical Surface Detection)
- Electronics: DAE4 Sn447; Calibrated: 2007-09-13
- Phantom: 1800/1900 Phantom; Type: SAM

Left touch 1175/Area Scan (51x91x1): Measurement grid: dx=15mm, dy=15mm

[Info: Interpolated medium parameters used for SAR evaluation.](#)

Maximum value of SAR (interpolated) = 1.32 mW/g

Left touch 1175/Zoom Scan (5x5x7)/Cube 0: Measurement grid: dx=8mm, dy=8mm, dz=5mm

Reference Value = 23.7 V/m; Power Drift = -0.044 dB

Peak SAR (extrapolated) = 1.84 W/kg

SAR(1 g) = 1.12 mW/g; SAR(10 g) = 0.609 mW/g

[Info: Interpolated medium parameters used for SAR evaluation.](#)

Maximum value of SAR (measured) = 1.27 mW/g

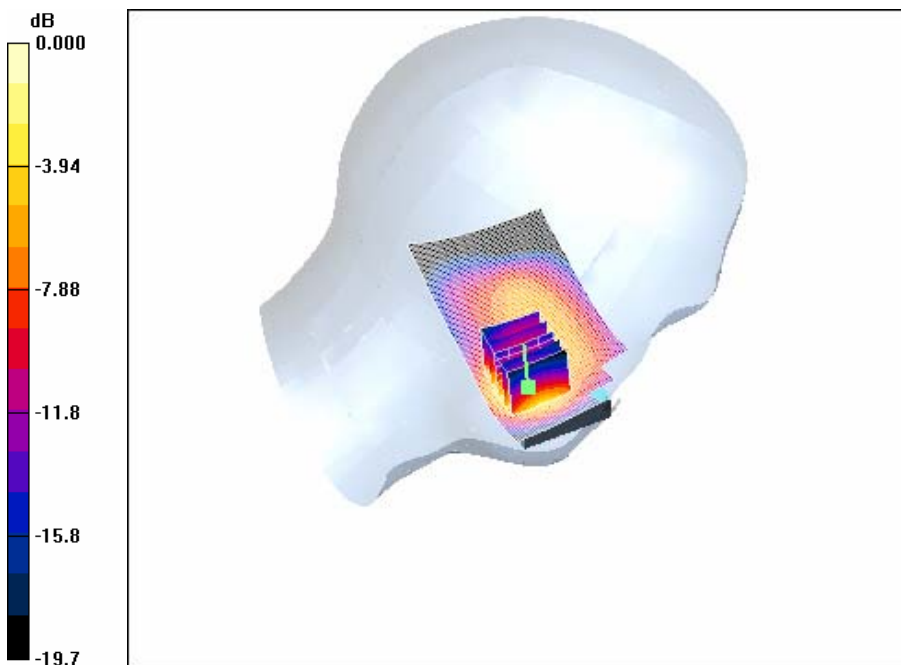

0 dB = 1.27mW/g

Test Laboratory: HCT CO., LTD
EUT Type: Dual-Band CDMA Phone with Bluetooth (CDMA/PCS CDMA)
Liquid Temperature: 21.3 °C
Ambient Temperature: 21.5 °C
Test Date: Apr.06, 2008

DUT: CDM8964; Type: Silde down; Serial: #1

Communication System: PCS 1900; Frequency: 1851.25 MHz; Duty Cycle: 1:1
Medium parameters used (interpolated): $f = 1851.25$ MHz; $\sigma = 1.42$ mho/m; $\epsilon_r = 38.9$; $\rho = 1000$ kg/m³
Phantom section: Right Section ; Measurement SW: DASY4, V4.6 Build 23; Postprocessing SW: SEMCAD, V1.8 Build 176

DASY4 Configuration:

- Probe: ET3DV6 - SN1609; ConvF(5.36, 5.36, 5.36); Calibrated: 2007-08-30
- Sensor-Surface: 4mm (Mechanical Surface Detection)
- Electronics: DAE4 Sn447; Calibrated: 2007-09-13
- Phantom: 1800/1900 Phantom; Type: SAM

Right touch 25/Area Scan (51x91x1): Measurement grid: dx=15mm, dy=15mm[Info: Interpolated medium parameters used for SAR evaluation.](#)

Maximum value of SAR (interpolated) = 0.962 mW/g

Right touch 25/Zoom Scan (5x5x7)/Cube 0: Measurement grid: dx=8mm, dy=8mm, dz=5mm

Reference Value = 24.0 V/m; Power Drift = -0.044 dB

Peak SAR (extrapolated) = 1.35 W/kg

SAR(1 g) = 0.856 mW/g; SAR(10 g) = 0.500 mW/g[Info: Interpolated medium parameters used for SAR evaluation.](#)

Maximum value of SAR (measured) = 0.933 mW/g

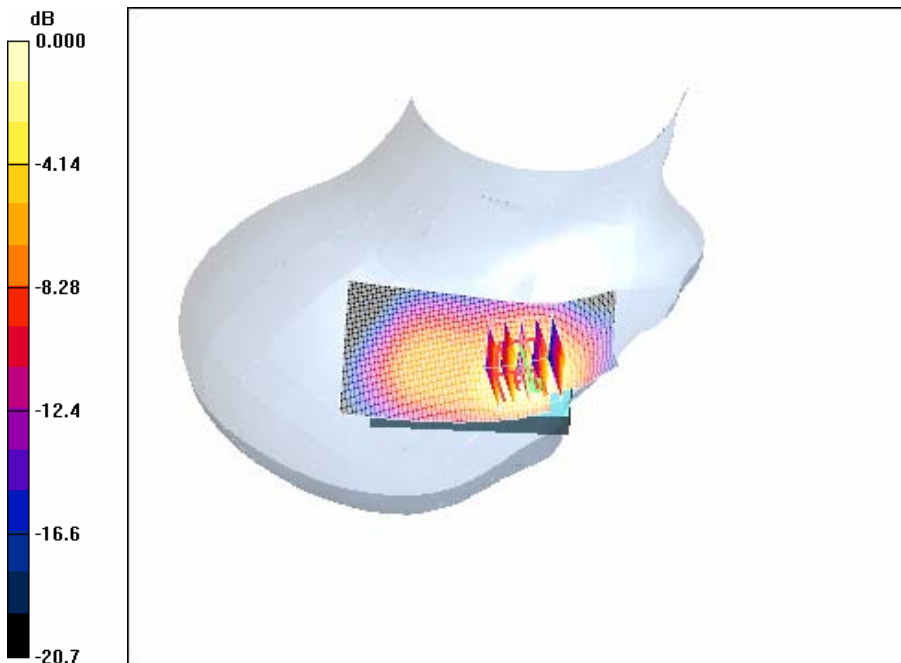

0 dB = 0.933mW/g

Test Laboratory: HCT CO., LTD
EUT Type: Dual-Band CDMA Phone with Bluetooth (CDMA/PCS CDMA)
Liquid Temperature: 21.3 °C
Ambient Temperature: 21.5 °C
Test Date: Apr.06, 2008

DUT: CDM8964; Type: Silde down; Serial: #1

Communication System: PCS 1900; Frequency: 1880 MHz;Duty Cycle: 1:1
Medium parameters used: $f = 1880$ MHz; $\sigma = 1.45$ mho/m; $\epsilon_r = 38.8$; $\rho = 1000$ kg/m³
Phantom section: Right Section ; Measurement SW: DASY4, V4.6 Build 23; Postprocessing SW: SEMCAD, V1.8 Build 176

DASY4 Configuration:

- Probe: ET3DV6 - SN1609; ConvF(5.36, 5.36, 5.36); Calibrated: 2007-08-30
- Sensor-Surface: 4mm (Mechanical Surface Detection)
- Electronics: DAE4 Sn447; Calibrated: 2007-09-13
- Phantom: 1800/1900 Phantom; Type: SAM

Right touch 600/Area Scan (51x91x1): Measurement grid: dx=15mm, dy=15mm
Maximum value of SAR (interpolated) = 1.09 mW/g

Right touch 600/Zoom Scan (5x5x7)/Cube 0: Measurement grid: dx=8mm, dy=8mm, dz=5mm
Reference Value = 25.1 V/m; Power Drift = 0.016 dB
Peak SAR (extrapolated) = 1.54 W/kg
SAR(1 g) = 0.971 mW/g; SAR(10 g) = 0.565 mW/g
Maximum value of SAR (measured) = 1.07 mW/g

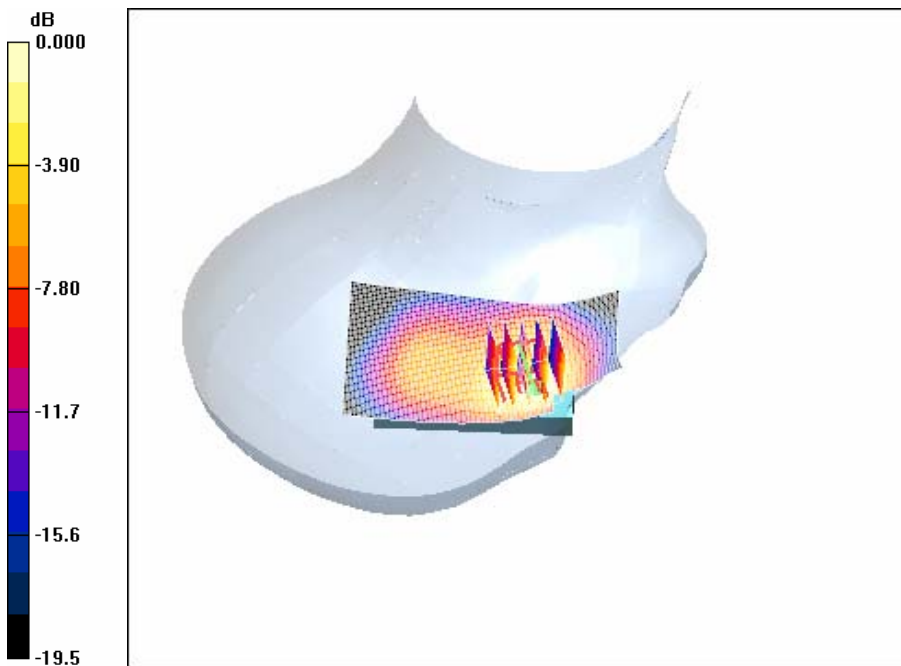

Test Laboratory: HCT CO., LTD
EUT Type: Dual-Band CDMA Phone with Bluetooth (CDMA/PCS CDMA)
Liquid Temperature: 21.3 °C
Ambient Temperature: 21.5 °C
Test Date: Apr.06, 2008

DUT: CDM8964; Type: Silde down; Serial: #1

Communication System: PCS 1900; Frequency: 1908.75 MHz; Duty Cycle: 1:1
Medium parameters used (interpolated): $f = 1908.75$ MHz; $\sigma = 1.46$ mho/m; $\epsilon_r = 38.6$; $\rho = 1000$ kg/m³
Phantom section: Right Section ; Measurement SW: DASY4, V4.6 Build 23; Postprocessing SW: SEMCAD, V1.8 Build 176

DASY4 Configuration:

- Probe: ET3DV6 - SN1609; ConvF(5.36, 5.36, 5.36); Calibrated: 2007-08-30
- Sensor-Surface: 4mm (Mechanical Surface Detection)
- Electronics: DAE4 Sn447; Calibrated: 2007-09-13
- Phantom: 1800/1900 Phantom; Type: SAM

Right touch 1175/Area Scan (51x91x1): Measurement grid: dx=15mm, dy=15mm

[Info: Interpolated medium parameters used for SAR evaluation.](#)

Maximum value of SAR (interpolated) = 1.08 mW/g

Right touch 1175/Zoom Scan (5x5x7)/Cube 0: Measurement grid: dx=8mm, dy=8mm, dz=5mm

Reference Value = 24.8 V/m; Power Drift = 0.052 dB

Peak SAR (extrapolated) = 1.54 W/kg

SAR(1 g) = 0.956 mW/g; SAR(10 g) = 0.555 mW/g

[Info: Interpolated medium parameters used for SAR evaluation.](#)

Maximum value of SAR (measured) = 1.06 mW/g

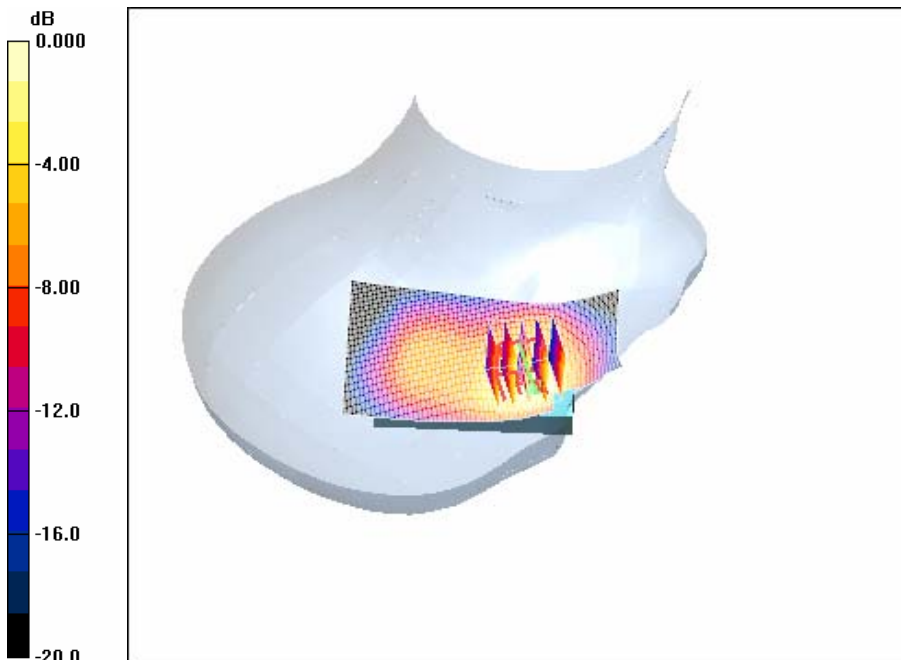

Test Laboratory: HCT CO., LTD
EUT Type: Dual-Band CDMA Phone with Bluetooth (CDMA/PCS CDMA)
Liquid Temperature: 21.3 °C
Ambient Temperature: 21.5 °C
Test Date: Apr.06, 2008

DUT: CDM8964; Type: Silde up; Serial: #1

Communication System: PCS 1900; Frequency: 1880 MHz; Duty Cycle: 1:1
Medium parameters used: $f = 1880$ MHz; $\sigma = 1.45$ mho/m; $\epsilon_r = 38.8$; $\rho = 1000$ kg/m³
Phantom section: Left Section ; Measurement SW: DASY4, V4.6 Build 23; Postprocessing SW: SEMCAD, V1.8 Build 176

DASY4 Configuration:

- Probe: ET3DV6 - SN1609; ConvF(5.36, 5.36, 5.36); Calibrated: 2007-08-30
- Sensor-Surface: 4mm (Mechanical Surface Detection)
- Electronics: DAE4 Sn447; Calibrated: 2007-09-13
- Phantom: 1800/1900 Phantom; Type: SAM

Left tilt 600/Area Scan (51x111x1): Measurement grid: dx=15mm, dy=15mm
Maximum value of SAR (interpolated) = 1.29 mW/g

Left tilt 600/Zoom Scan (5x5x7)/Cube 0: Measurement grid: dx=8mm, dy=8mm, dz=5mm
Reference Value = 12.4 V/m; Power Drift = 0.000 dB
Peak SAR (extrapolated) = 1.68 W/kg
SAR(1 g) = 0.959 mW/g; SAR(10 g) = 0.532 mW/g
Maximum value of SAR (measured) = 1.04 mW/g

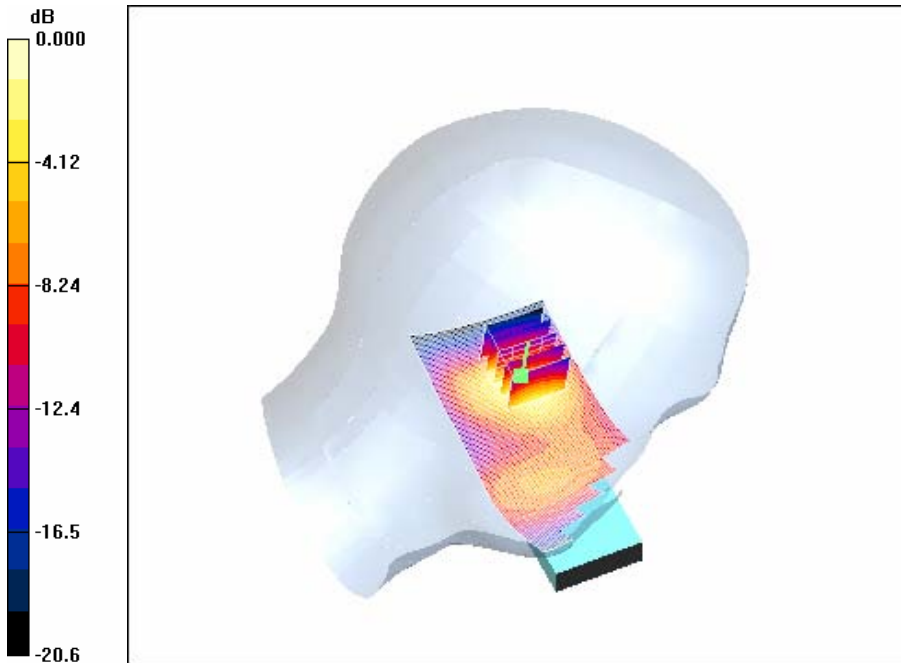

0 dB = 1.04mW/g

Test Laboratory: HCT CO., LTD
EUT Type: Dual-Band CDMA Phone with Bluetooth (CDMA/PCS CDMA)
Liquid Temperature: 21.3 °C
Ambient Temperature: 21.5 °C
Test Date: Apr.06, 2008

DUT: CDM8964; Type: Silde up; Serial: #1

Communication System: PCS 1900; Frequency: 1880 MHz;Duty Cycle: 1:1
Medium parameters used: $f = 1880$ MHz; $\sigma = 1.45$ mho/m; $\epsilon_r = 38.8$; $\rho = 1000$ kg/m³
Phantom section: Right Section ; Measurement SW: DASY4, V4.6 Build 23; Postprocessing SW: SEMCAD, V1.8
Build 176

DASY4 Configuration:

- Probe: ET3DV6 - SN1609; ConvF(5.36, 5.36, 5.36); Calibrated: 2007-08-30
- Sensor-Surface: 4mm (Mechanical Surface Detection)
- Electronics: DAE4 Sn447; Calibrated: 2007-09-13
- Phantom: 1800/1900 Phantom; Type: SAM

Right tilt 600/Area Scan (51x111x1): Measurement grid: dx=15mm, dy=15mm
Maximum value of SAR (interpolated) = 0.987 mW/g

Right tilt 600/Zoom Scan (5x5x7)/Cube 0: Measurement grid: dx=8mm, dy=8mm, dz=5mm
Reference Value = 12.7 V/m; Power Drift = 0.058 dB
Peak SAR (extrapolated) = 1.18 W/kg
SAR(1 g) = 0.756 mW/g; SAR(10 g) = 0.446 mW/g
Maximum value of SAR (measured) = 0.823 mW/g

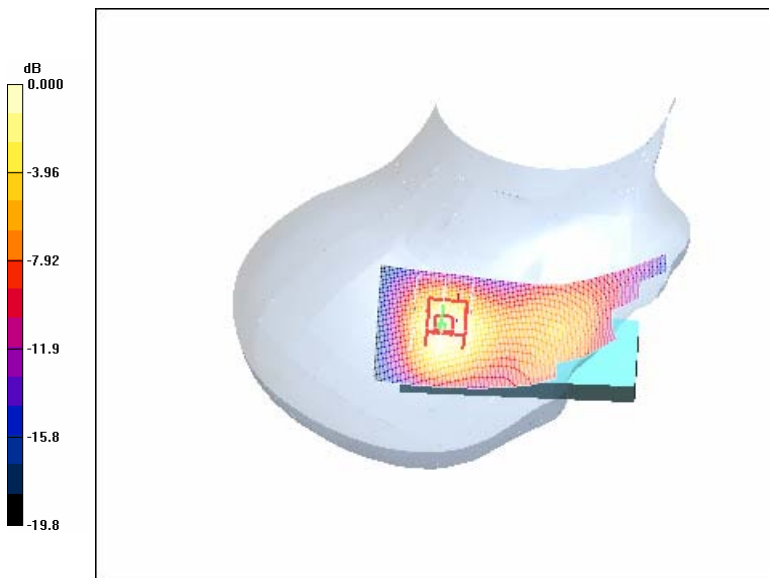

0 dB = 0.823mW/g

Test Laboratory: HCT CO., LTD
EUT Type: Dual-Band CDMA Phone with Bluetooth (CDMA/PCS CDMA)
Liquid Temperature: 21.3 °C
Ambient Temperature: 21.5 °C
Test Date: Apr.06, 2008

DUT: CDM8964; Type: Silde down; Serial: #1

Communication System: PCS 1900; Frequency: 1880 MHz;Duty Cycle: 1:1
Medium parameters used: $f = 1880$ MHz; $\sigma = 1.45$ mho/m; $\epsilon_r = 38.8$; $\rho = 1000$ kg/m³
Phantom section: Left Section ; Measurement SW: DASY4, V4.6 Build 23; Postprocessing SW: SEMCAD, V1.8 Build 176

DASY4 Configuration:

- Probe: ET3DV6 - SN1609; ConvF(5.36, 5.36, 5.36); Calibrated: 2007-08-30
- Sensor-Surface: 4mm (Mechanical Surface Detection)
- Electronics: DAE4 Sn447; Calibrated: 2007-09-13
- Phantom: 1800/1900 Phantom; Type: SAM

Left tilt 600/Area Scan (51x91x1): Measurement grid: dx=15mm, dy=15mm
Maximum value of SAR (interpolated) = 0.380 mW/g

Left tilt 600/Zoom Scan (5x5x7)/Cube 0: Measurement grid: dx=8mm, dy=8mm, dz=5mm
Reference Value = 9.97 V/m; Power Drift = -0.001 dB
Peak SAR (extrapolated) = 0.514 W/kg
SAR(1 g) = 0.331 mW/g; SAR(10 g) = 0.196 mW/g
Maximum value of SAR (measured) = 0.355 mW/g

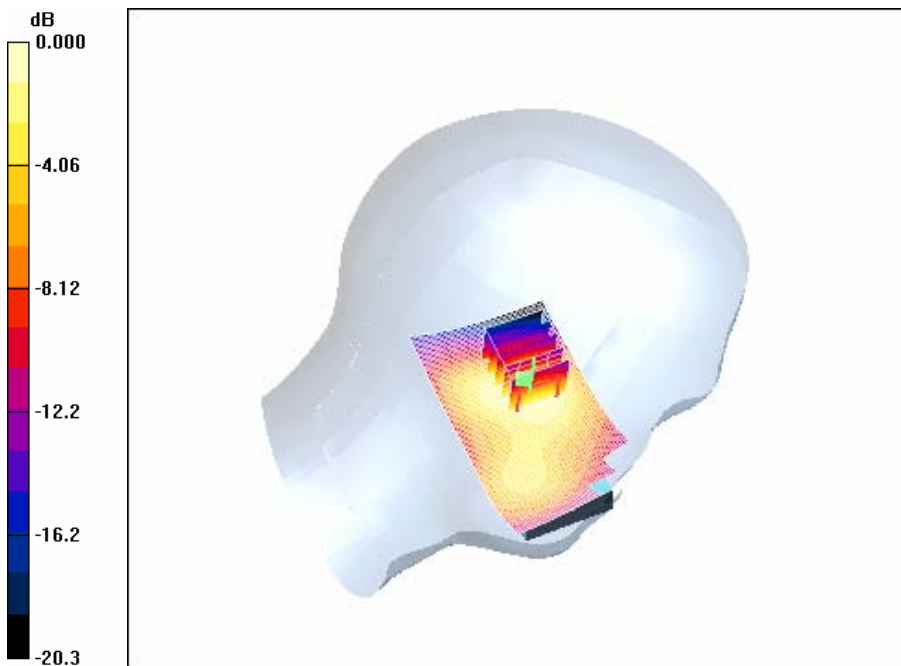

Test Laboratory: HCT CO., LTD
EUT Type: Dual-Band CDMA Phone with Bluetooth (CDMA/PCS CDMA)
Liquid Temperature: 21.3 °C
Ambient Temperature: 21.5 °C
Test Date: Apr.06, 2008

DUT: CDM8964; Type: Silde down; Serial: #1

Communication System: PCS 1900; Frequency: 1880 MHz; Duty Cycle: 1:1
Medium parameters used: $f = 1880$ MHz; $\sigma = 1.45$ mho/m; $\epsilon_r = 38.8$; $\rho = 1000$ kg/m³
Phantom section: Right Section ; Measurement SW: DASY4, V4.6 Build 23; Postprocessing SW: SEMCAD, V1.8 Build 176

DASY4 Configuration:

- Probe: ET3DV6 - SN1609; ConvF(5.36, 5.36, 5.36); Calibrated: 2007-08-30
- Sensor-Surface: 4mm (Mechanical Surface Detection)
- Electronics: DAE4 Sn447; Calibrated: 2007-09-13
- Phantom: 1800/1900 Phantom; Type: SAM

Right tilt 600/Area Scan (51x91x1): Measurement grid: dx=15mm, dy=15mm
Maximum value of SAR (interpolated) = 0.309 mW/g

Right tilt 600/Zoom Scan (5x5x7)/Cube 0: Measurement grid: dx=8mm, dy=8mm, dz=5mm
Reference Value = 9.05 V/m; Power Drift = 0.008 dB
Peak SAR (extrapolated) = 0.371 W/kg
SAR(1 g) = 0.256 mW/g; SAR(10 g) = 0.163 mW/g
Maximum value of SAR (measured) = 0.274 mW/g

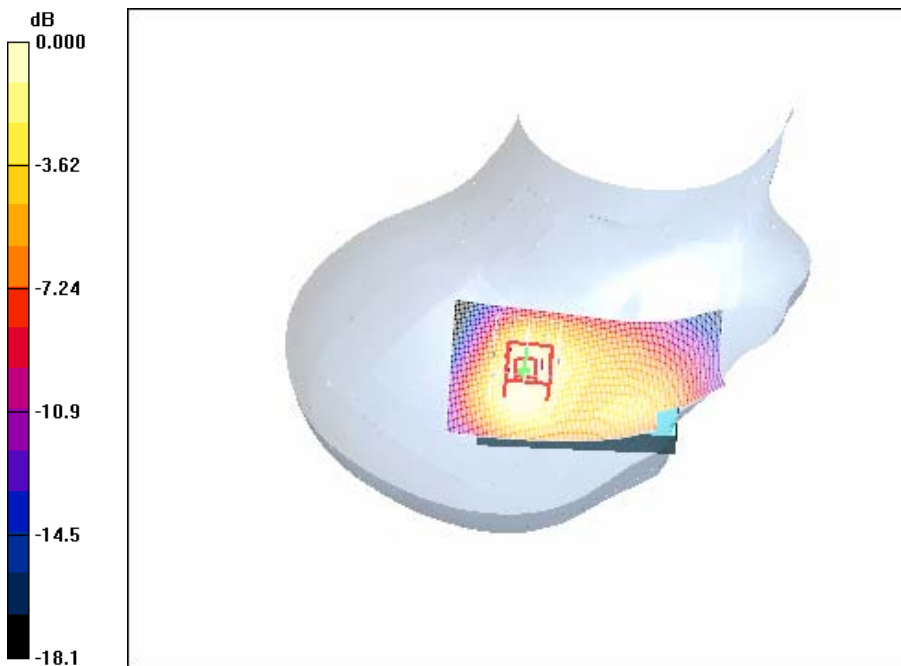

Test Laboratory: HCT CO., LTD
EUT Type: Dual-Band CDMA Phone with Bluetooth (CDMA/PCS CDMA)
Liquid Temperature: 21.4 °C
Ambient Temperature: 21.6 °C
Test Date: Apr.05, 2008

DUT: CDM8964; Type: Silde down; Serial: #1

Communication System: CDMA 835MHz FCC; Frequency: 824.7 MHz;Duty Cycle: 1:1
Medium parameters used: $f = 825$ MHz; $\sigma = 0.971$ mho/m; $\epsilon_r = 54.8$; $\rho = 1000$ kg/m³
Phantom section: Flat Section ; Measurement SW: DASY4, V4.6 Build 23; Postprocessing SW: SEMCAD, V1.8 Build 176

DASY4 Configuration:

- Probe: ET3DV6 - SN1609; ConvF(6.49, 6.49, 6.49); Calibrated: 2007-08-30
- Sensor-Surface: 4mm (Mechanical Surface Detection)
- Electronics: DAE4 Sn447; Calibrated: 2007-09-13
- Phantom: 835/900 Phamtom ; Type: SAM

CDMA Body 1013/Area Scan (51x91x1): Measurement grid: dx=15mm, dy=15mm
Maximum value of SAR (interpolated) = 0.717 mW/g

CDMA Body 1013/Zoom Scan (5x5x7)/Cube 0: Measurement grid: dx=8mm, dy=8mm, dz=5mm
Reference Value = 13.9 V/m; Power Drift = -0.071 dB
Peak SAR (extrapolated) = 0.868 W/kg
SAR(1 g) = 0.666 mW/g; SAR(10 g) = 0.465 mW/g
Maximum value of SAR (measured) = 0.705 mW/g

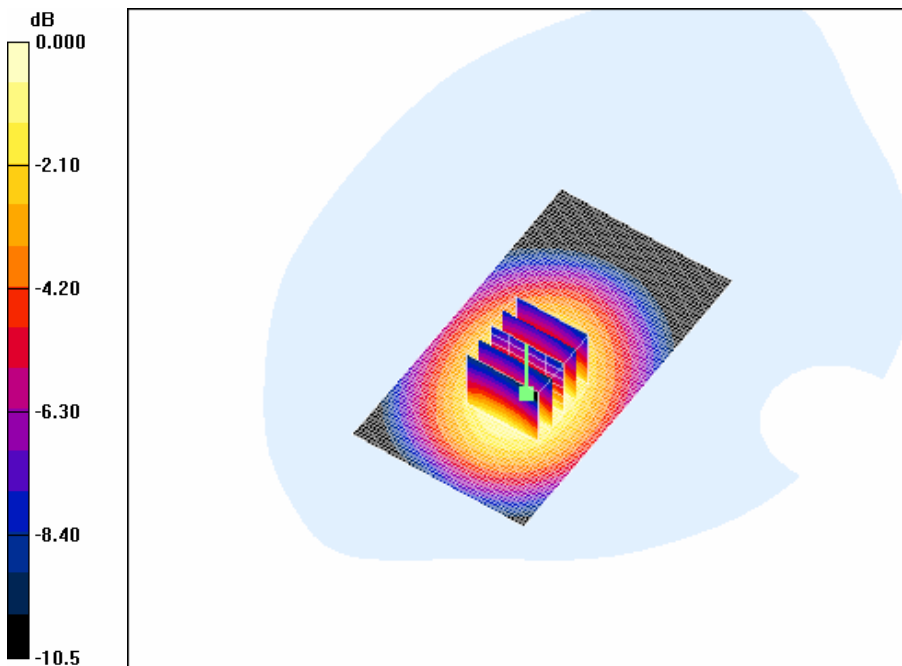

0 dB = 0.705mW/g

Test Laboratory: HCT CO., LTD
EUT Type: Dual-Band CDMA Phone with Bluetooth (CDMA/PCS CDMA)
Liquid Temperature: 21.4 °C
Ambient Temperature: 21.6 °C
Test Date: Apr.05, 2008

DUT: CDM8964; Type: Silde down; Serial: #1

Communication System: CDMA 835MHz FCC; Frequency: 836.52 MHz;Duty Cycle: 1:1
Medium parameters used (interpolated): $f = 836.52$ MHz; $\sigma = 0.987$ mho/m; $\epsilon_r = 54.7$; $\rho = 1000$ kg/m³
Phantom section: Flat Section ; Measurement SW: DASY4, V4.6 Build 23; Postprocessing SW: SEMCAD, V1.8 Build 176

DASY4 Configuration:

- Probe: ET3DV6 - SN1609; ConvF(6.49, 6.49, 6.49); Calibrated: 2007-08-30
- Sensor-Surface: 4mm (Mechanical Surface Detection)
- Electronics: DAE4 Sn447; Calibrated: 2007-09-13
- Phantom: 835/900 Phamtom ; Type: SAM

CDMA Body 384/Area Scan (51x91x1): Measurement grid: dx=15mm, dy=15mm

[Info: Interpolated medium parameters used for SAR evaluation.](#)

Maximum value of SAR (interpolated) = 0.821 mW/g

CDMA Body 384/Zoom Scan (5x5x7)/Cube 0: Measurement grid: dx=8mm, dy=8mm, dz=5mm

Reference Value = 15.1 V/m; Power Drift = -0.040 dB

Peak SAR (extrapolated) = 1.42 W/kg

SAR(1 g) = 0.826 mW/g; SAR(10 g) = 0.570 mW/g

[Info: Interpolated medium parameters used for SAR evaluation.](#)

Maximum value of SAR (measured) = 0.863 mW/g

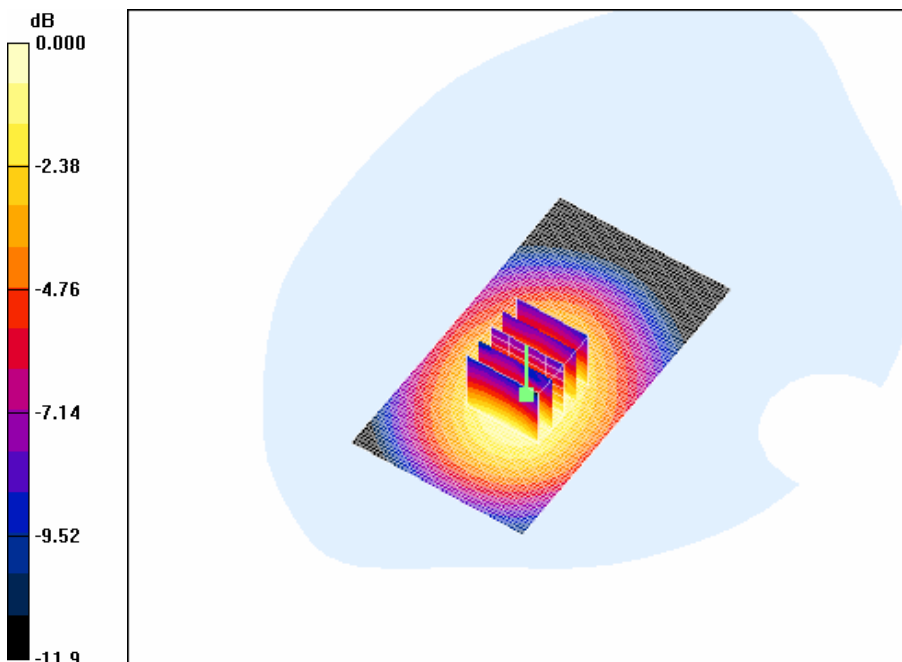

0 dB = 0.863mW/g

Test Laboratory: HCT CO., LTD
EUT Type: Dual-Band CDMA Phone with Bluetooth (CDMA/PCS CDMA)
Liquid Temperature: 21.4 °C
Ambient Temperature: 21.6 °C
Test Date: Apr.05, 2008

DUT: CDM8964; Type: Silde down; Serial: #1

Communication System: CDMA 835MHz FCC; Frequency: 848.31 MHz;Duty Cycle: 1:1
Medium parameters used (interpolated): $f = 848.31$ MHz; $\sigma = 1.01$ mho/m; $\epsilon_r = 54.6$; $\rho = 1000$ kg/m³
Phantom section: Flat Section ; Measurement SW: DASY4, V4.6 Build 23; Postprocessing SW: SEMCAD, V1.8 Build 176

DASY4 Configuration:

- Probe: ET3DV6 - SN1609; ConvF(6.49, 6.49, 6.49); Calibrated: 2007-08-30
- Sensor-Surface: 4mm (Mechanical Surface Detection)
- Electronics: DAE4 Sn447; Calibrated: 2007-09-13
- Phantom: 835/900 Phamtom ; Type: SAM

CDMA Body 777/Area Scan (51x91x1): Measurement grid: dx=15mm, dy=15mm

[Info: Interpolated medium parameters used for SAR evaluation.](#)

Maximum value of SAR (interpolated) = 0.811 mW/g

CDMA Body 777/Zoom Scan (5x5x7)/Cube 0: Measurement grid: dx=8mm, dy=8mm, dz=5mm

Reference Value = 14.9 V/m; Power Drift = -0.149 dB

Peak SAR (extrapolated) = 1.09 W/kg

SAR(1 g) = 0.754 mW/g; SAR(10 g) = 0.527 mW/g

[Info: Interpolated medium parameters used for SAR evaluation.](#)

Maximum value of SAR (measured) = 0.797 mW/g

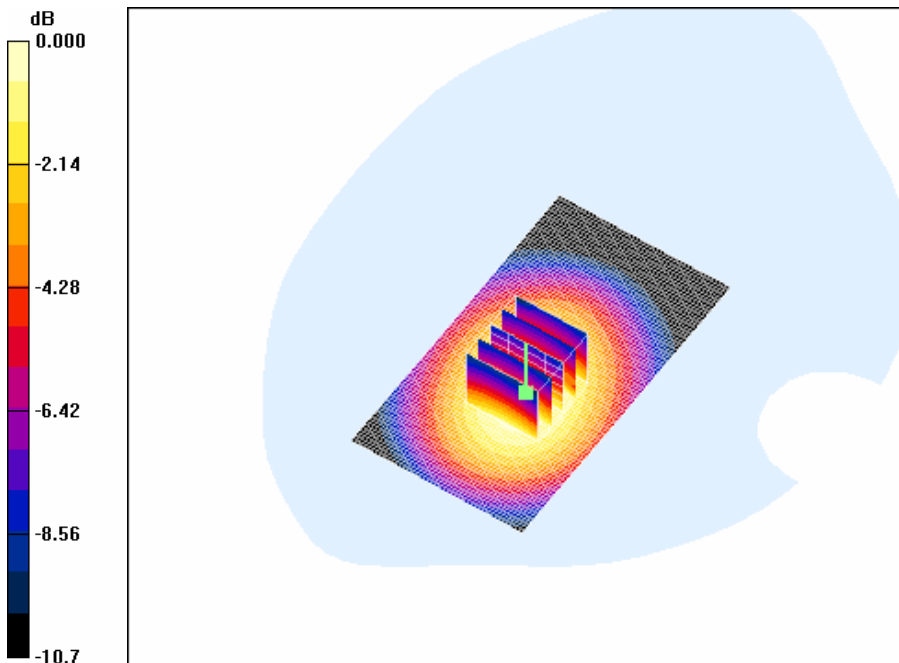

0 dB = 0.797mW/g

Test Laboratory: HCT CO., LTD
EUT Type: Dual-Band CDMA Phone with Bluetooth (CDMA/PCS CDMA)
Liquid Temperature: 21.4 °C
Ambient Temperature: 21.6 °C
Test Date: Apr.05, 2008

DUT: CDM8964; Type: Silde down; Serial: #1

Communication System: CDMA 835MHz FCC; Frequency: 836.52 MHz;Duty Cycle: 1:1
Medium parameters used (interpolated): $f = 836.52$ MHz; $\sigma = 0.987$ mho/m; $\epsilon_r = 54.7$; $\rho = 1000$ kg/m³
Phantom section: Flat Section ; Measurement SW: DASY4, V4.6 Build 23; Postprocessing SW: SEMCAD, V1.8 Build 176

DASY4 Configuration:

- Probe: ET3DV6 - SN1609; ConvF(6.49, 6.49, 6.49); Calibrated: 2007-08-30
- Sensor-Surface: 4mm (Mechanical Surface Detection)
- Electronics: DAE4 Sn447; Calibrated: 2007-09-13
- Phantom: 835/900 Phamtom ; Type: SAM

CDMA Body 384/Area Scan (51x91x1): Measurement grid: dx=15mm, dy=15mm

[Info: Interpolated medium parameters used for SAR evaluation.](#)

Maximum value of SAR (interpolated) = 0.395 mW/g

CDMA Body 384/Zoom Scan (5x5x7)/Cube 0: Measurement grid: dx=8mm, dy=8mm, dz=5mm

Reference Value = 10.3 V/m; Power Drift = 0.011 dB

Peak SAR (extrapolated) = 0.536 W/kg

SAR(1 g) = 0.382 mW/g; SAR(10 g) = 0.278 mW/g

[Info: Interpolated medium parameters used for SAR evaluation.](#)

Maximum value of SAR (measured) = 0.405 mW/g

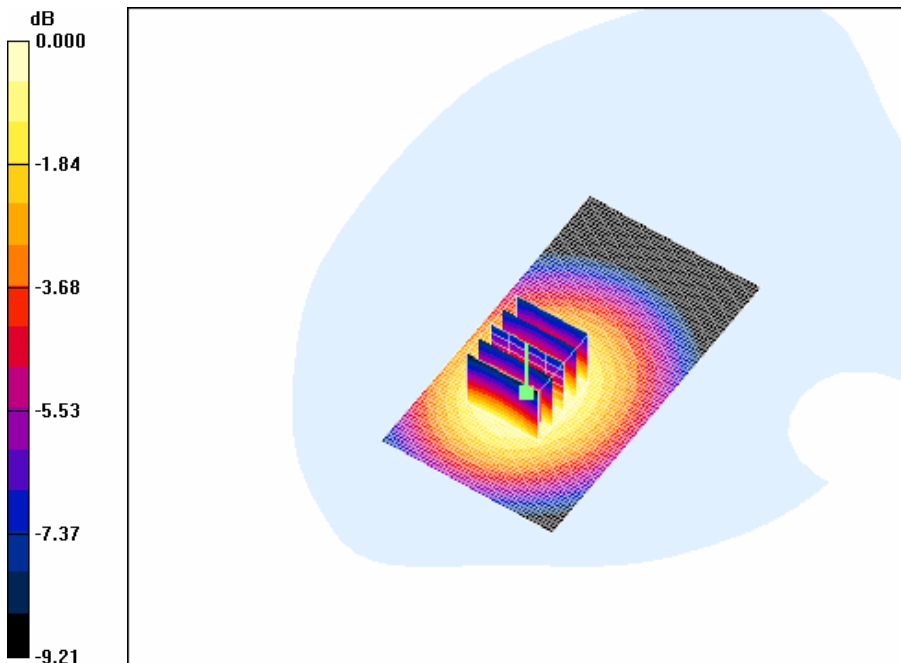

0 dB = 0.405mW/g