

TIMCO ENGINEERING INC.

849 NW State Road 45
Newberry, Florida 32669
<http://www.timcoengr.com>
888.472.2424 F 352.472.2030 email: sid@timcoengr.com

FCC Test Report

Product Name: DUAL-BAND HANDHELD

FCC ID: PP4GA-400B

Applicant:

HYUNDAI CURITEL INC.
SAN 136-1, AMI-RI, BUBAL-EUB,
ICHON-SI, KYOUNGKI-DO
SOUTH KOREA 467-701

Date Receipt: MAY 18, 2004

Date Tested: MAY 26, 2004

APPLICANT: HYUNDAI CURITEL INC.
FCC ID: PP4GA-400B
REPORT #: C\CURITEL_R3G\703AUT4\703AUT4TestReport.doc

COVER SHEET

TIMCO ENGINEERING INC.

849 NW State Road 45
Newberry, Florida 32669
<http://www.timcoengr.com>
888.472.2424 F 352.472.2030 email: sid@timcoengr.com

TABLE OF CONTENTS

APPLICANT: HYUNDAI CURITEL INC.

FCC ID: PP4GA-400B

TEST REPORT:

1.....	GENERAL DESCRIPTION & TECHNICAL DESCRIPTION
2.....	TECHNICAL DESCRIPTION CONTINUED
	RF OUTPUT POWER
3.....	CDMA MODULE INPUT POWER
4.....	POWER OUTPUT - EFFECTIVE RADIATED POWER - ERP
5-7.....	VOICE MODULATION CHARACTERISTICS
	AUDIO LOW PASS FILTER
	OUT OF BAND EMISSIONS
	BANDEDGE COMPLIANCE
8.....	MOBILE EMISSIONS IN BASE FREQUENCY RANGE
9-10.....	FIELD STRENGTH OF SPURIOUS EMISSIONS
11.....	METHOD OF MEASURING RADIATED SPURIOUS EMISISONS
12-13.....	FREQUENCY STABILITY
14-16.....	OCCUPIED BANDWIDTH
17-20.....	TEST EQUIPMENT LIST

EXHIBITS INCLUDING:

BLOCK DIAGRAM
SCHEMATIC
PARTS LIST
USERS MANUAL
LABEL SAMPLE
LABEL LOCATION
EXTERNAL PHOTOGRAPHS
INTERNAL PHOTOGRAPHS
ALIGNMENT PROCEDURE
OPERATIONAL DESCRIPTION
TEST SET UP PHOTOGRAPHS

APPLICANT: HYUNDAI CURITEL INC.

FCC ID: PP4GA-400B

REPORT #: C\CURITEL_R3G\703AUT4\703AUT4TestReport.doc

TABLE OF CONTENTS

TIMCO ENGINEERING INC.

849 NW State Road 45
Newberry, Florida 32669
<http://www.timcoengr.com>
888.472.2424 F 352.472.2030 email: sid@timcoengr.com

GENERAL INFORMATION

2.1033(c)(1)(2) HYUNDAI CURITEL INC. will sell the FCC ID:
PP4GA-400B, Fixed WLL cellular phone for use under
FCC RULES PART 22H and 24E.

2.1033(c) TECHNICAL DESCRIPTION

2.1033 (3) The User Manual is included in the exhibits.

2.1033 (4) Type of Emission: 300KGXW (GSM 850)

99 % Power bandwidth = 300 kHz
Bn = 300 kHz
G = Phase modulation
X = Cases not otherwise covered
W = Combination audio and data

2.1033 (4) Type of Emission: 300KG7W (GSM 1900)

99 % Power bandwidth = 300 kHz
Bn = 300 kHz
G = Phase modulation
7 = 2 or more channels containing quantized or
digital information
W = Combination audio and data

2.1033 (5) Frequency Range: 824-849 MHz (GSM850)
1850-1910 MHz (GSM 1900)

(6) Power Range and Controls: There are NO user Power
controls.

(7) Maximum Output Power Rating:
See next page

(8) DC Voltages and Current into Final Amplifier:
See next page

(9) Tune-up procedure. The tune-up procedure is given in
the exhibits

(10) Complete Circuit Diagrams: Description of all
circuitry and devices provided for determining and
stabilizing frequency is included in the circuit
description in the instruction manual. The circuit
diagram and block diagram are included in the
exhibits.

APPLICANT: HYUNDAI CURITEL INC.
FCC ID: PP4GA-400B
REPORT #: C\CURITEL_R3G\703AUT4\703AUT4TestReport.doc

TIMCO ENGINEERING INC.

849 NW State Road 45
Newberry, Florida 32669
<http://www.timcoengr.com>
888.472.2424 F 352.472.2030 email: sid@timcoengr.com

- 2.1033(c)(11) A photograph or drawing of the equipment identification label is shown in the Exhibits.
- 2.1033(c)(12) Photographs of the equipment of sufficient clarity to reveal equipment construction and layout and label location, are shown in the Exhibits.
- 2.1033(c)(13) For equipment employing digital modulation, a detail description of the modulation technique.
This unit uses GMSK and $3\pi/8$ 8PSK modulation
- 2.1033(c)(14) Data required for 2.1046 to 2.1057 See Below
- 2.1046(a) **RF power output:**
RF power is measured by connecting a 50 ohm, resistive wattmeter to the RF output connector. With a nominal voltage applied using a fully charged battery supply specified with this device, and the transmitter properly adjusted the RF output measures:

METHOD OF MEASURING RF POWER OUTPUT

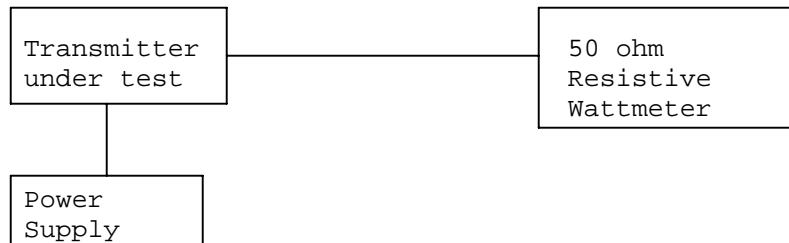

TIMCO ENGINEERING INC.

849 NW State Road 45

Newberry, Florida 32669

<http://www.timcoengr.com>

888.472.2424 F 352.472.2030 email: sid@timcoengr.com

GSM Module Input power (RF module)

INPUT POWER (GSM850): (4.0VDC)(1.6A) = 6.4 Watts
INPUT POWER (GSM 1900): (4.0Vdc) (2.0A) = 8.0 Watts
OUTPUT POWER: (GSM850) see below
OUTPUT POWER: (GSM 1900) see below

Conducted output power was also measured using a Spectrum Analyzer
with a 50 Ohm input port:

Low Channel #128 33 dBm
Mid Channel #190 33 dBm
High Channel #251 33 dBm

Low Channel #512 30 dBm
Mid Channel #661 30 dBm
High Channel #810 30 dBm

APPLICANT: HYUNDAI CURITEL INC.

FCC ID: PP4GA-400B

REPORT #: C\CURITEL_R3G\703AUT4\703AUT4TestReport.doc

TIMCO ENGINEERING INC.

849 NW State Road 45
Newberry, Florida 32669
<http://www.timcoengr.com>
888.472.2424 F 352.472.2030 email: sid@timcoengr.com

22.913

Power Output - Effective Radiated Power - ERP

Method of measurement:

This test was conducted per TIA/EIA STANDARD 603 using the substitution method.

Tuned Frequency (MHz)	Polarization (H/V)	ERP (dBm)	ERP (W)
824.2	V	32.05	1.6
836.6	V	30.74	1.2
848.8	V	31.54	1.4

Power Output - Effective Isotropic Radiated Power - EIRP

Tuned Frequency (MHz)	Polarization (H/V)	EIRP (dBm)	EIRP (W)
1850.2	V	29.8	.95
1880	V	29.1	.81
1909.8	V	27.6	.58

TIMCO ENGINEERING INC.

849 NW State Road 45
 Newberry, Florida 32669
<http://www.timcoengr.com>
 888.472.2424 F 352.472.2030 email: sid@timcoengr.com

2.1047(a) **Voice Modulation characteristics:**
 NOT APPLICABLE, F9 or G9 type of emission.

2.1047 **Audio Low Pass Filter**
 This UUT does not have a low pass filter.

2.1049 **Occupied bandwidth: 99% power bandwidth:**

22.917 (e) **Out of band emissions:** The mean power of emissions must be attenuated below the mean power of the un-modulated carrier (P) on any frequency twice or more than twice the fundamental frequency by:
 At least $43 + 10\log(P_o) = \text{dB}$.

Band-edges compliance: Measurement were performed in accordance with Part 22.917 (h)

Conducted output power: 33 dBm

Channel (MHz)	Band-edge Frequency (MHz)	Amplitude level at the band-edge(dBm)	Limit (dBm)	Margin (dB)
824.2	824.0	-14.0	-13.0	1.0
849.8	849.0	-13.1	-13.0	0.1

Conducted output power: 30 dBm

Channel (MHz)	Band-edge Frequency (MHz)	Amplitude level at the band-edge(dBm)	Limit (dBm)	Margin (dB)
1850.2	1850	-13.0	-13.0	0.0
1909.8	1910	-13.0	-13.0	0.0

The following plot shows the composite power measured with a RBW = 3MHz = VBW and the modulated envelope measured with a RBW = 3 kHz = VBW

TIMCO ENGINEERING INC.

849 NW State Road 45

Newberry, Florida 32669

<http://www.timcoengr.com>

888.472.2424 F 352.472.2030 email: sid@timcoengr.com

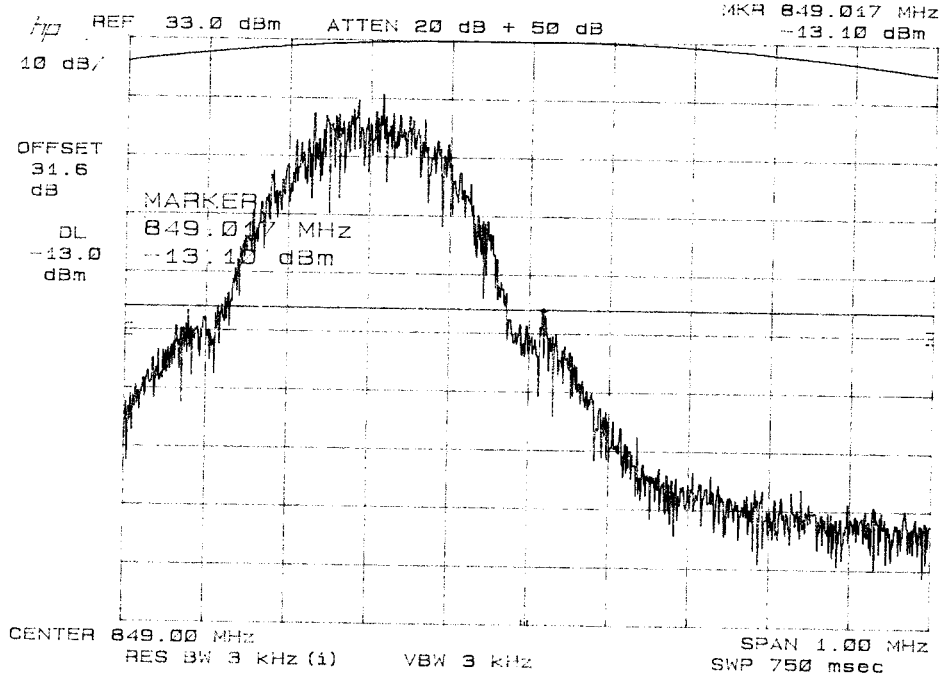
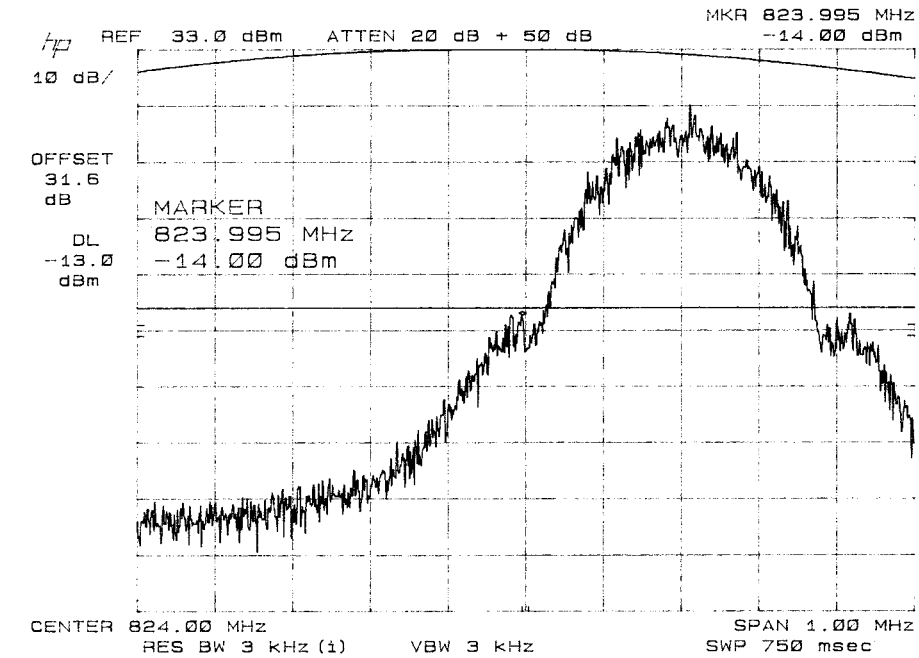

APPLICANT: HYUNDAI CURITEL INC.

FCC ID: PP4GA-400B

REPORT #: C\CURITEL_R3G\703AUT4\703AUT4TestReport.doc

TIMCO ENGINEERING INC.

849 NW State Road 45

Newberry, Florida 32669

<http://www.timcoengr.com>

888.472.2424 F 352.472.2030 email: sid@timcoengr.com

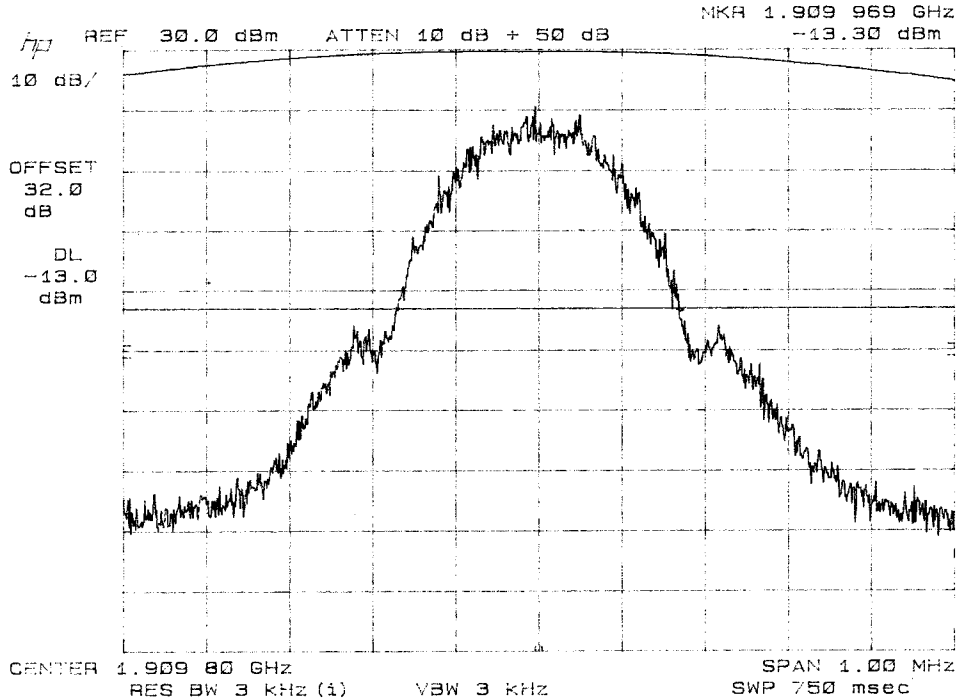
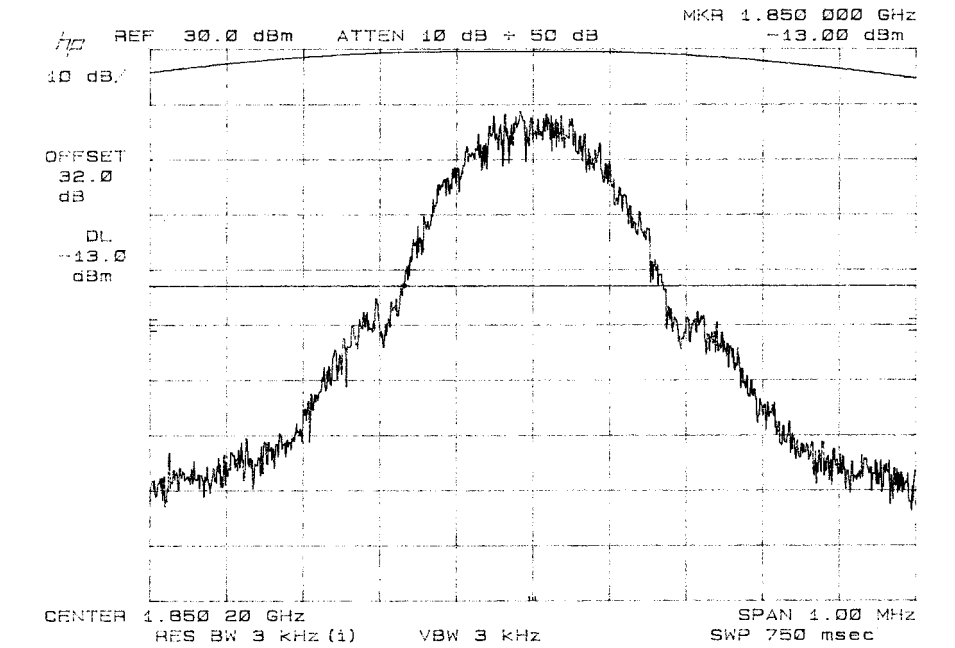

APPLICANT: HYUNDAI CURITEL INC.

FCC ID: PP4GA-400B

REPORT #: C\CURITEL_R3G\703AUT4\703AUT4TestReport.doc

TIMCO ENGINEERING INC.

849 NW State Road 45

Newberry, Florida 32669

<http://www.timcoengr.com>

888.472.2424 F 352.472.2030 email: sid@timcoengr.com

22.917 (f)

Mobile emissions in base frequency range:

The mean power of any emissions appearing in the base station frequency range from cellular mobile transmitters operated must be attenuated to a level not to exceed - 80 dBm at the transmit antenna connector.

The Low, Mid, and High channels were tested. The worst-case emissions is reported:

No significant emissions found

APPLICANT: HYUNDAI CURITEL INC.

FCC ID: PP4GA-400B

REPORT #: C\CURITEL_R3G\703AUT4\703AUT4TestReport.doc

TIMCO ENGINEERING INC.

849 NW State Road 45
Newberry, Florida 32669
http://www.timcoengr.com
888.472.2424 F 352.472.2030 email: sid@timcoengr.com

2.1053

Field strength of spurious emissions:

NAME OF TEST: RADIATED SPURIOUS EMISSIONS

REQUIREMENTS: Emissions must be $43 + 10\log(P_o)$ dB below the mean power output of the transmitter.

$$43 + 10\log(2) = 46 \text{ dB}$$

TEST DATA:

Emission Frequency MHz	Ant. Polarity	Corrected EUT Signal Reading	Coax Loss (dB)	Substitution Antenna (dBd)	dB Below Carrier (dBc)
824.20	V	32.20	0.5	0.35	0
1648.40	V	-40.70	1.13	5.07	68.81
2472.60	V	-51.30	1.29	6.67	77.97
5769.40	V	-43.40	1.81	8.73	68.53
6593.60	V	-48.40	1.96	8.59	73.82
836.60	V	32.3	0.5	-1.06	0.00
1673.20	V	-45.2	1.13	5.09	71.98
2509.80	V	-46.4	1.3	6.76	71.68
4183.00	V	-48.5	1.47	7.87	72.84
5856.20	V	-49.1	1.84	8.85	72.83
6692.80	V	-45.9	1.97	8.31	70.30
848.80	V	33.00	0.5	-0.96	0
1697.60	V	-51.20	1.14	5.11	78.77
2546.40	V	-48.30	1.3	6.79	74.35
4244.00	V	-46.50	1.47	7.94	71.57
5941.60	V	-49.00	1.88	8.97	73.45

APPLICANT: HYUNDAI CURITEL INC.

FCC ID: PP4GA-400B

REPORT #: C\CURITEL_R3G\703AUT4\703AUT4TestReport.doc

TIMCO ENGINEERING INC.

849 NW State Road 45
Newberry, Florida 32669
<http://www.timcoengr.com>
888.472.2424 F 352.472.2030 email: sid@timcoengr.com

2.1053

Field strength of spurious emissions:

NAME OF TEST: RADIATED SPURIOUS EMISSIONS

REQUIREMENTS: Emissions must be $43 + 10\log(P_o)$ dB below the mean power output of the transmitter.

$$43 + 10\log(1) = 43 \text{ dB}$$

TEST DATA:

Emission Frequency MHz	Ant. Polarity	Corrected EUT Signal Reading	Coax Loss (dB)	Substitution Antenna (dBi)	dB Below Carrier (dBc)
1850.20	V	25.80	1.17	5.16	0
3700.40	V	-44.50	1.42	9.74	65.97
9251.00	V	-39.20	2.35	11.45	59.89

1880.00	V	25.10	1.18	5.18	0
3760.00	V	-42.50	1.43	9.75	63.28
11280.00	V	-38.00	2.58	10.36	59.32

1909.80	V	23.60	1.18	5.2	0
3819.60	V	-44.60	1.43	9.76	63.89
5729.40	V	-46.40	1.79	10.82	64.99
7639.20	V	-41.70	2.03	10.47	60.88
9549.00	V	-41.50	2.41	11.83	59.7
11458.80	V	-38.30	2.6	9.82	58.7

APPLICANT: HYUNDAI CURITEL INC.

FCC ID: PP4GA-400B

REPORT #: C\CURITEL_R3G\703AUT4\703AUT4TestReport.doc

TIMCO ENGINEERING INC.

849 NW State Road 45
Newberry, Florida 32669
<http://www.timcoengr.com>
888.472.2424 F 352.472.2030 email: sid@timcoengr.com

Method of Measuring Radiated Spurious Emissions

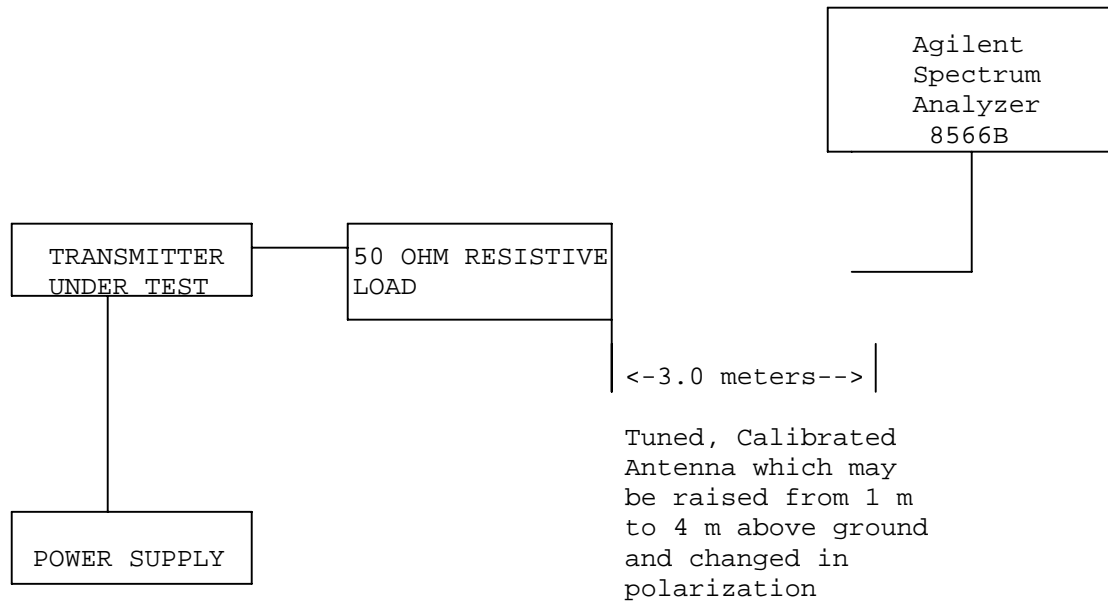

Equipment placed 80 cm above ground
on a rotating table platform.

METHOD OF MEASUREMENTS: The tabulated data shows the results of the radiated field strength emissions test. The spectrum was scanned from 30 MHz to at least the tenth harmonic of the fundamental. This test was conducted per TIA/EIA STANDARD 603 using the substitution method. Measurements were made at the open field test site of TIMCO ENGINEERING, INC. located at 849 NW State Road 45, Newberry, FL 32669.

APPLICANT: HYUNDAI CURITEL INC.
FCC ID: PP4GA-400B
REPORT #: C\CURITEL_R3G\703AUT4\703AUT4TestReport.doc

TIMCO ENGINEERING INC.

849 NW State Road 45
Newberry, Florida 32669
<http://www.timcoengr.com>
888.472.2424 F 352.472.2030 email: sid@timcoengr.com

2.1055 Frequency stability:

Measurement techniques have been in accordance with TIA/EIA STD 603-1992.

22.355:

Frequency stability

Temperature and voltage tests were performed to verify that the frequency remains within the .00025%, 2.5 ppm specification limit for Base fixed unit. The test was conducted as follows: The transmitter was placed in the temperature chamber at 25° C and allowed to stabilize for one hour. The transmitter was keyed ON for one minute during which four frequency readings were recorded at 15-second intervals. The worse case number was taken for temperature plotting. The assigned channel frequency was considered to be the reference frequency. The temperature was then reduced to -30° C after which the transmitter was again allowed to stabilize for one hour. The transmitter was keyed ON for one minute, and again frequency readings were noted at 15-second intervals. The worst case number was recorded for temperature plotting. This procedure was repeated in 10 degree increments up to + 50 degrees C.

MEASUREMENT DATA:

Assigned Frequency (Ref. Frequency): 836.600000 MHz

Assigned channel	190		
Assigned Frequency	836.6	Frequency	
Temperature		deviation	ppm
Centigrade		Hertz	
-20	836.600035	35	0.04
-10	836.60004	40	0.05
0	836.600045	45	0.05
10	836.600045	45	0.05
20	836.60005	50	0.06
30	836.60004	40	0.05
40	836.60003	30	0.04
50	836.60002	20	0.02

RESULTS OF MEASUREMENTS: The maximum frequency variation over the temperature range was +0.06 ppm.

Measurements were also made at the battery end point of 3.4 Volts. The maximum frequency variation over voltage was: +0.03 ppm.

APPLICANT: HYUNDAI CURITEL INC.

FCC ID: PP4GA-400B

REPORT #: C\CURITEL_R3G\703AUT4\703AUT4TestReport.doc

TIMCO ENGINEERING INC.

849 NW State Road 45
Newberry, Florida 32669
<http://www.timcoengr.com>
888.472.2424 F 352.472.2030 email: sid@timcoengr.com

2.1055 Frequency stability:

Measurement techniques have been in accordance with TIA/EIA STD 603-1992.

22.355:

Frequency stability

Temperature and voltage tests were performed to verify that the frequency remains within the .00025%, 2.5 ppm specification limit for Base fixed unit. The test was conducted as follows: The transmitter was placed in the temperature chamber at 25° C and allowed to stabilize for one hour. The transmitter was keyed ON for one minute during which four frequency readings were recorded at 15-second intervals. The worse case number was taken for temperature plotting. The assigned channel frequency was considered to be the reference frequency. The temperature was then reduced to -30° C after which the transmitter was again allowed to stabilize for one hour. The transmitter was keyed ON for one minute, and again frequency readings were noted at 15-second intervals. The worst case number was recorded for temperature plotting. This procedure was repeated in 10 degree increments up to + 50 degrees C.

MEASUREMENT DATA:

Assigned Frequency (Ref. Frequency): 1880.000000 MHz

Assigned channel	661		
Assigned Frequency	1880	Frequency	
Temperature		deviation	ppm
Centigrade		Hertz	
-20	1880.000063	63	0.03
-10	1880.000055	55	0.03
0	1880.000043	43	0.02
10	1880.000033	33	0.02
20	1880.000043	43	0.02
30	1880.000015	15	0.01
40	1880.000025	25	0.01
50	1880.000055	55	0.03

RESULTS OF MEASUREMENTS: The maximum frequency variation over the temperature range was +0.03 ppm.

Measurements were also made at the battery end point of 3.4 Volts. The maximum frequency variation over voltage was: +0.03 ppm.

APPLICANT: HYUNDAI CURITEL INC.

FCC ID: PP4GA-400B

REPORT #: C\CURITEL_R3G\703AUT4\703AUT4TestReport.doc

TIMCO ENGINEERING INC.

849 NW State Road 45

Newberry, Florida 32669

<http://www.timcoengr.com>

888.472.2424 F 352.472.2030 email: sid@timcoengr.com

2.1049 Occupied Bandwidth

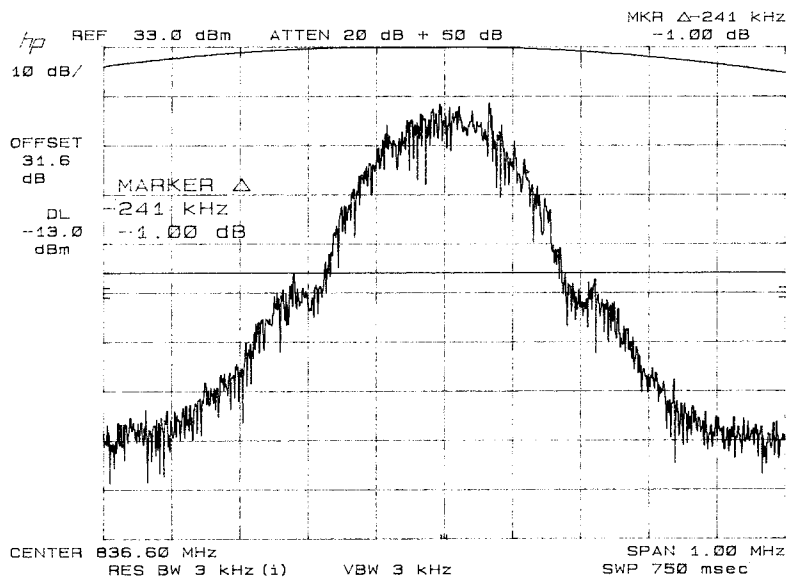
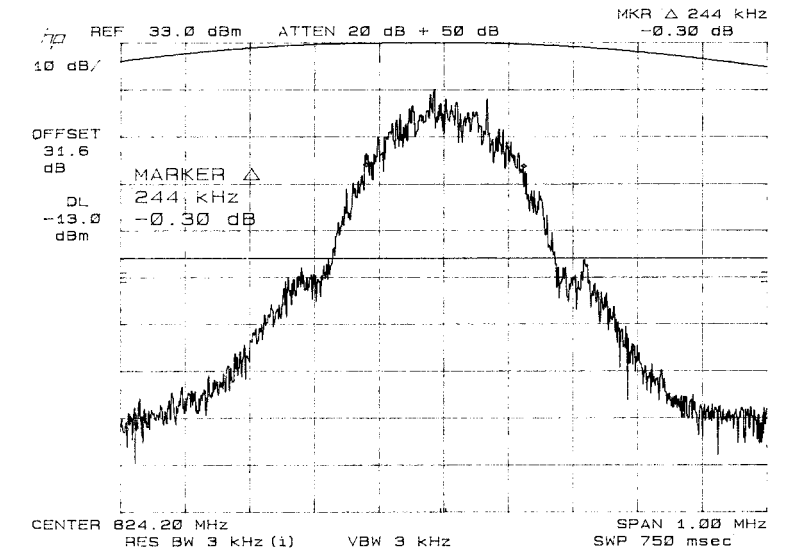

APPLICANT: HYUNDAI CURITEL INC.

FCC ID: PP4GA-400B

REPORT #: C\CURITEL_R3G\703AUT4\703AUT4TestReport.doc

TIMCO ENGINEERING INC.

849 NW State Road 45

Newberry, Florida 32669

<http://www.timcoengr.com>

888.472.2424 F 352.472.2030 email: sid@timcoengr.com

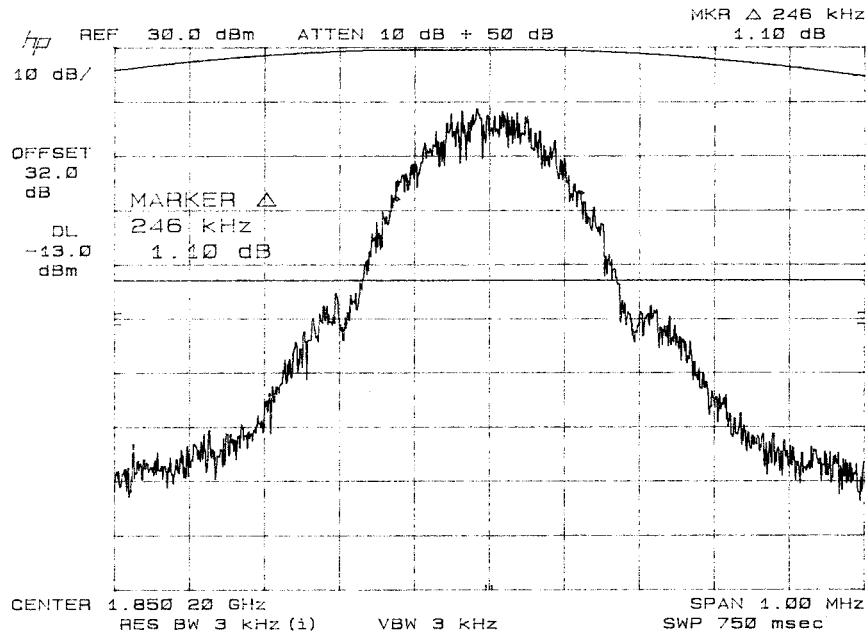
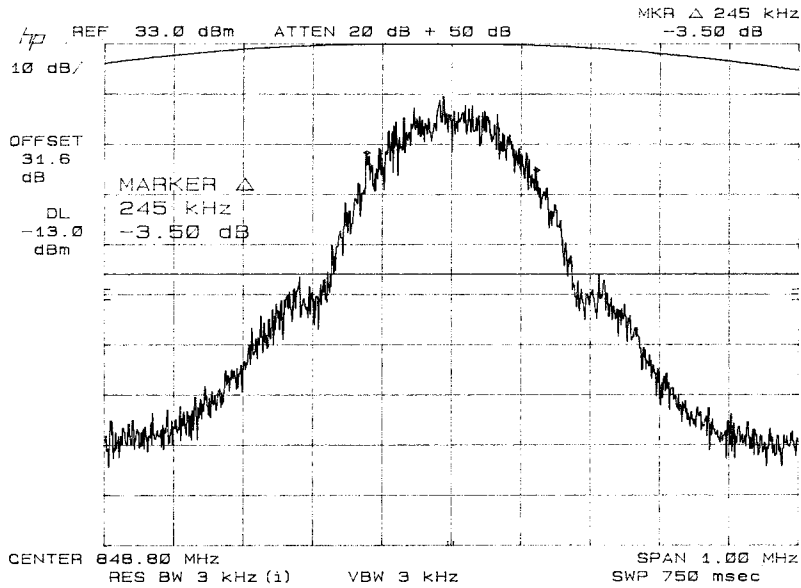

APPLICANT: HYUNDAI CURITEL INC.

FCC ID: PP4GA-400B

REPORT #: C\CURITEL_R3G\703AUT4\703AUT4TestReport.doc

TIMCO ENGINEERING INC.

849 NW State Road 45

Newberry, Florida 32669

<http://www.timcoengr.com>

888.472.2424 F 352.472.2030 email: sid@timcoengr.com

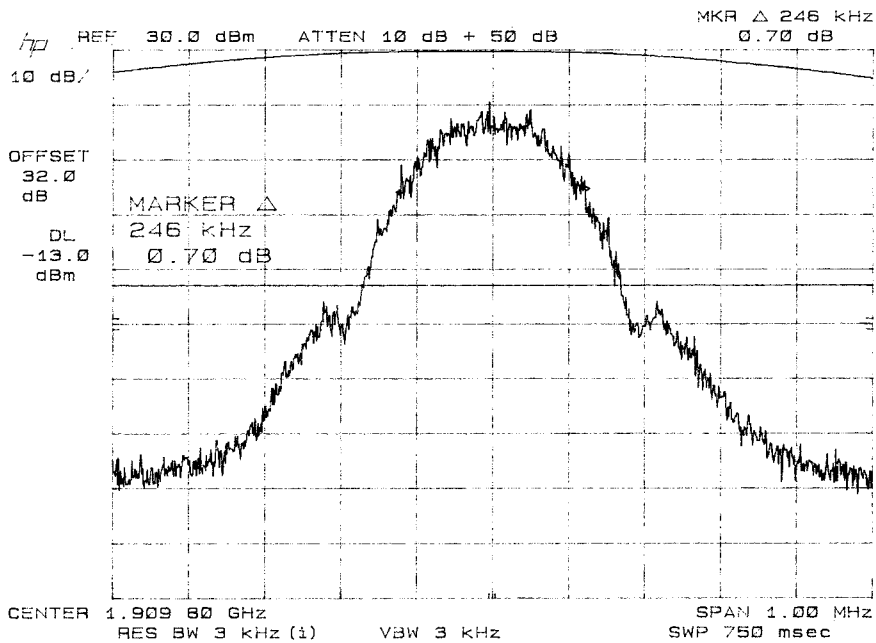
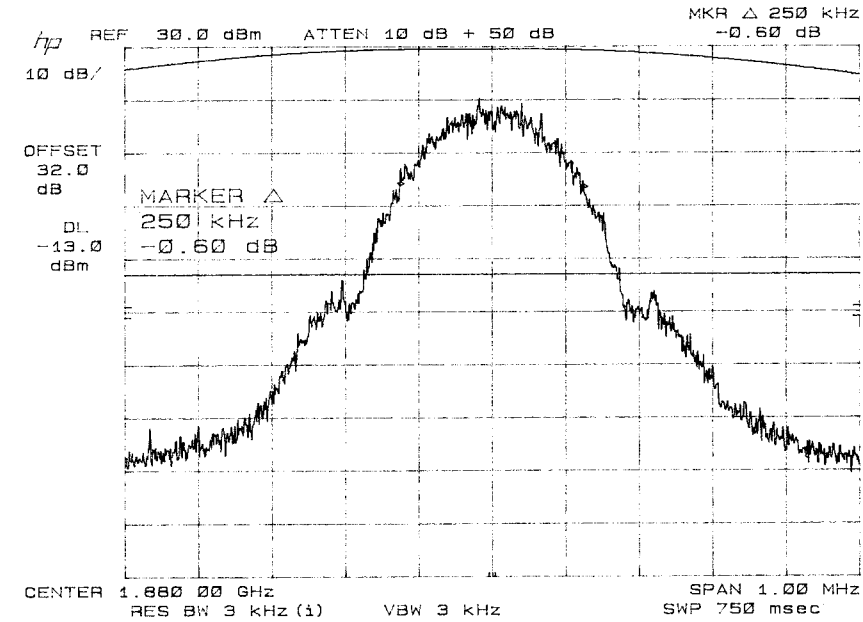

APPLICANT: HYUNDAI CURITEL INC.

FCC ID: PP4GA-400B

REPORT #: C\CURITEL_R3G\703AUT4\703AUT4TestReport.doc

TIMCO ENGINEERING INC.

849 NW State Road 45
 Newberry, Florida 32669
<http://www.timcoengr.com>
 888.472.2424 F 352.472.2030 email: sid@timcoengr.com

EMC Equipment List

	DEVICE	MFGR	MODEL	SERNO	CAL/CHAR DATE	DUE DATE or STATUS
X	3-Meter OATS	TEI	N/A	N/A	Listed 1/13/03	1/13/06
	3/10-Meter OATS	TEI	N/A	N/A	Listed 3/26/01	3/26/04
	Receiver, Beige Tower Spectrum Analyzer	HP	8566B Opt 462	3138A07786 3144A20661	CAL 8/31/01	8/31/03
	RF Preselector	HP	85685A	3221A01400	CAL 8/31/01	8/31/03
	Quasi-Peak Adapter	HP	85650A	3303A01690	CAL 8/31/01	8/31/03
	Receiver, Blue Tower Spectrum Analyzer	HP	8568B	2928A04729 2848A18049	CAL 4/15/03	4/15/05
	RF Preselector	HP	85685A	2926A00983	CAL 4/15/03	4/15/05
	Quasi-Peak Adapter	HP	85650A	2811A01279	CAL 4/15/03	4/15/05
X	Receiver, Silver/Grey Tower Spectrum Analyzer	HP	8566B Opt 462	3552A22064 3638A08608	CAL 10/14/02	10/14/04
X	RF Preselector	HP	85685A	2620A00294	CAL 10/14/02	10/14/04
X	Quasi-Peak Adapter	HP	85650A	3303A01844	CAL 10/14/02	10/14/04
X	Preamplifier	HP	8449B	3008A01075	CHAR 1/28/02	1/28/04
X	Biconnical Antenna	Electro-Metrics	BIA-25	1171	CAL 4/26/01	4/26/03
	Biconnical Antenna	Eaton	94455-1	1096	CAL 10/1/01	10/1/03
	Biconnical Antenna	Eaton	94455-1	1057	CAL 3/18/03	3/18/05
	BiconiLog Antenna	EMCO	3143	9409-1043		
X	Log-Periodic Antenna	Electro-Metrics	LPA-25	1122	CAL 10/2/01	10/2/03
	Log-Periodic Antenna	Electro-Metrics	EM-6950	632	CHAR 10/15/01	10/15/03
	Log-Periodic Antenna	Electro-Metrics	LPA-30	409	CAL 3/4/03	3/4/05

TIMCO ENGINEERING INC.

849 NW State Road 45

Newberry, Florida 32669

http://www.timcoengr.com

888.472.2424 F 352.472.2030 email: sid@timcoengr.com

	DEVICE	MFGR	MODEL	SERNO	CAL/CHAR DATE	DUE DATE or STATUS
	Dipole Antenna Kit	Electro-Metrics	TDA-30/1-4	152	CAL 3/21/01	3/21/04
	Dipole Antenna Kit	Electro-Metrics	TDA-30/1-4	153	CAL 9/26/02	9/26/05
X	Double-Ridged Horn Antenna	Electro-Metrics	RGA-180	2319	CAL 2/17/03	2/17/05
	Horn Antenna	Electro-Metrics	EM-6961	6246	CAL 3/31/03	3/31/05
	Horn Antenna	ATM	19-443-6R	None	No Cal Required	
	Passive Loop Antenna	EMC Test Systems	EMCO 6512	9706-1211	CHAR 7/10/01	7/10/03
X	Line Impedance Stabilization . . .	Electro-Metrics	ANS-25/2	2604	CAL 10/9/01	10/9/03
	Line Impedance Stabilization . . .	Electro-Metrics	EM-7820	2682	CAL 3/12/03	3/12/05
	Termaline Wattmeter	Bird Electronic Corporation	611	16405	CAL 5/25/99	5/25/01
	Termaline Wattmeter	Bird Electronic Corporation	6104	1926	CHAR 12/12/01	12/12/03
	Oscilloscope	Tektronix	2230	300572	CHAR 2/1/01	2/1/03
	System One	Audio Precision	System One	SYS1-45868	CHAR 4/25/02	4/25/04
X	Temperature Chamber	Tenney Engineering	TTRC	11717-7	CHAR 1/22/02	1/22/04
	AC Voltmeter	HP	400FL	2213A14499	CAL 10/9/01	10/9/03
	AC Voltmeter	HP	400FL	2213A14261	CHAR 10/15/01	10/15/03
	AC Voltmeter	HP	400FL	2213A14728	CHAR 10/15/01	10/15/03
X	Digital Multimeter	Fluke	77	35053830	CHAR 1/8/02	1/8/04
	Digital Multimeter	Fluke	77	43850817	CHAR 1/8/02	1/8/04
	Digital Multimeter	HP	E2377A	2927J05849	CHAR 1/8/02	1/8/04
	Multimeter	Fluke	FLUKE-77-3	79510405	CHAR 9/26/01	9/26/03
X	Peak Power Meter	HP	8900C	2131A00545	CHAR 1/26/01	1/26/03
X	Power Meter	HP	432A	1141A07655	CAL 4/15/03	4/15/05

APPLICANT: HYUNDAI CURITEL INC.

FCC ID: PP4GA-400B

REPORT #: C\CURITEL_R3G\703AUT4\703AUT4TestReport.doc

TIMCO ENGINEERING INC.

849 NW State Road 45
 Newberry, Florida 32669
<http://www.timcoengr.com>
 888.472.2424 F 352.472.2030 email: sid@timcoengr.com

	DEVICE	MFGR	MODEL	SERNO	CAL/CHAR DATE	DUE DATE or STATUS
	Power Meter And Sensor	Bird	4421-107 4022	0166 0218	CAL 4/16/03	4/16/05
	Power Sensor	HP	478A	72129	CAL 4/15/03	4/15/05
	Digital Thermometer	Fluke	2166A	42032	CAL 1/16/02	1/16/04
	Thermometer	Traulsen	SK-128		CHAR 1/22/02	1/22/04
	Thermometer	Extech	4028	14871-2	CAL 3/7/03	3/7/05
X	Hygro-Thermometer	Extech	445703	0602	CAL 10/4/02	10/4/04
	Frequency Counter	HP	5352B	2632A00165	CAL 11/28/01	11/28/03
	Frequency Counter	HP	5385A	2730A03025	CAL 3/7/03	3/7/05
	Power Sensor	Agilent Technologies	84811A	2551A02705	CHAR 1/26/01	1/26/03
	Service Monitor	IFR	FM/AM 500A	5182	CAL 11/22/00	11/22/02
	Comm. Serv. Monitor	IFR	FM/AM 1200S	6593	CAL 5/12/02	5/12/04
	Signal Generator	HP	8640B	2308A21464	CAL 2/15/02	2/15/04
	Sweep Generator	Wiltron	6648	101009	CAL 4/15/03	4/15/05
	Sweep Generator	Wiltron	6669M	007005	CAL 3/3/03	3/3/05
	Modulation Analyzer	HP	8901A	3435A06868	CAL 9/5/01	9/5/03
	Modulation Meter	Boonton	8220	10901AB	CAL 4/15/03	4/15/05
	Near Field Probe	HP	HP11940A	2650A02748	CHAR 2/1/01	2/1/03
	BandReject Filter	Lorch Microwave	5BR4-2400/ 60-N	Z1	CHAR 3/2/01	3/2/03
	BandReject Filter	Lorch Microwave	6BR6-2442/ 300-N	Z1	CHAR 3/2/01	3/2/03
	BandReject Filter	Lorch Microwave	5BR4-10525/ 900-S	Z1	CHAR 3/2/01	3/2/03
	High Pass Filter	Microlab	HA-10N		CHAR 10/4/01	10/4/03
	High Pass Filter	Microlab	HA-20N		CHAR 2/7/03	2/7/05

APPLICANT: HYUNDAI CURITEL INC.

FCC ID: PP4GA-400B

REPORT #: C:\CURITEL_R3G\703AUT4\703AUT4TestReport.doc

TIMCO ENGINEERING INC.

849 NW State Road 45

Newberry, Florida 32669

<http://www.timcoengr.com>

888.472.2424 F 352.472.2030 email: sid@timcoengr.com

DEVICE	MFGR	MODEL	SERNO	CAL/CHAR DATE	DUE DATE or STATUS
Audio Oscillator	HP	653A	832-00260	CHAR 3/1/01	3/1/03
Frequency Counter	HP	5382A	1620A03535	CHAR 3/2/01	3/2/03
Frequency Counter	HP	5385A	3242A07460	CAL 3/7/03	3/7/05
Preamplifier	HP	8449B-H02	3008A00372	CHAR 3/4/01	3/4/03
Amplifier	HP	11975A	2738A01969	CHAR 3/1/01	3/1/03
Egg Timer	Unk			CHAR 8/31/01	8/31/03
Measuring Tape, 20M	Kraftixx	0631-20		CHAR 2/1/02	2/1/04
Measuring Tape, 7.5M	Kraftixx	7.5M PROFI		2/1/02	2/1/04
Coaxial Cable #51	Insulated Wire Inc.	NPS 2251-2880	Timco #51	CHAR 1/23/02	1/23/04
Coaxial Cable #64	Semflex Inc.	60637	Timco #64	CHAR 1/24/02	1/24/04
Coaxial Cable #65	General Cable Co.	E9917 RG233/U	Timco #65	CHAR 1/23/02	1/23/04
Coaxial Cable #106	Unknown	Unknown	Timco #106	CHAR 1/23/02	1/23/04

APPLICANT: HYUNDAI CURITEL INC.

FCC ID: PP4GA-400B

REPORT #: C\CURITEL_R3G\703AUT4\703AUT4TestReport.doc