

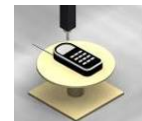

PCTEST ENGINEERING LABORATORY, INC.

6660-B Dobbin Road, Columbia, MD 21045 USA
Tel. 410.290.6652 / Fax 410.290.6554
http://www.pctestlab.com



HEARING AID COMPATIBILITY CERTIFICATE

Applicant Name:
Pantech & Curitel Communications, Inc.
110-1, Ongjeong-Ri, Tongjin-EUP, Gimpo-SI
Gyounggi-Do, 415-865
Korea

Date of Testing:
June 6 - 8, 2007
Test Site/Location:
PCTEST Lab, Columbia, MD, USA
Test Report Serial No.:
0705310542.PP4

FCC ID: PP4EZ2

APPLICANT: PANTECH & CURITEL COMMUNICATIONS, INC.

Application Type: Certification
FCC Rule Part(s): § 20.19(b), §6.3(v), §7.3(v)
HAC Standard: ANSI C63.19-2006 v3.12;
FCC Classification: Licensed Transmitter Held to Ear (PCE)
EUT Type: Cellular/PCS CDMA Phone
Model(s): EZ2
Tx Frequency: 824.70 - 848.31 MHz (Cellular CDMA)
1851.25 - 1908.75 MHz (PCS CDMA)

Test Device Serial No.: Pre-Production Sample [S/N: #1]

C63.19-2006 HAC Category: M4 (RF EMISSIONS CATEGORY)

This wireless portable device has been shown to be hearing-aid compatible under the above rated category, specified in ANSI/IEEE Std. C63.19-2006 and had been tested in accordance with the specified measurement procedures. Hearing-Aid Compatibility is based on the assumption that all production units will be designed electrically identical to the device tested in this report.

I attest to the accuracy of data. All measurements reported herein were performed by me or were made under my supervision and are correct to the best of my knowledge and belief. I assume full responsibility for the completeness of these measurements and vouch for the qualifications of all persons taking them.

PCTEST certifies that no party to this application has been denied the FCC benefits pursuant to Section 5301 of the Anti-Drug Abuse Act of 1988, 21 U.S.C. 862.

Randy Ortanez
President







FCC ID: PP4EZ2		HAC (RF EMISSIONS) TEST REPORT		Reviewed by: Quality Manager
HAC Filename: 0705310542.PP4	Test Dates: June 6 - 8, 2007	EUT Type: Cellular/PCS CDMA Phone		Page 1 of 70

TABLE OF CONTENTS

1.	INTRODUCTION	3
2.	TEST SITE LOCATION	4
3.	EUT DESCRIPTION	5
4.	ANSI/IEEE C63.19 PERFORMANCE CATEGORIES	6
5.	SYSTEM SPECIFICATIONS.....	7
6.	TEST PROCEDURE	13
7.	SYSTEM CHECK	15
8.	MODULATION FACTOR.....	18
9.	FCC 3G MEASUREMENTS – MAY/JUNE 2006.....	20
10.	OVERALL MEASUREMENT SUMMARY	21
11.	EQUIPMENT LIST.....	24
12.	MEASUREMENT UNCERTAINTY	25
13.	TEST DATA.....	26
14.	CALIBRATION CERTIFICATES.....	35
15.	CONCLUSION.....	65
16.	REFERENCES	66
17.	TEST PHOTOGRAPHS	68

FCC ID: PP4EZ2	 PCTEST <small>Engineering Laboratory, Inc.</small>	HAC (RF EMISSIONS) TEST REPORT	 PANTECH & CURITEL	Reviewed by: Quality Manager
HAC Filename: 0705310542.PP4	Test Dates: June 6 - 8, 2007	EUT Type: Cellular/PCS CDMA Phone	Page 2 of 70	

1. INTRODUCTION

On July 10, 2003, the Federal Communications Commission (FCC) adopted new rules requiring wireless manufacturers and service providers to provide digital wireless phones that are compatible with hearing aids. The FCC has modified the exemption for wireless phones under the Hearing Aid Compatibility Act of 1998 (HAC Act) in WT Docket 01-309 RM-8658¹ to extend the benefits of wireless telecommunications to individuals with hearing disabilities. These benefits encompass business, social and emergency communications, which increase the value of the wireless network for everyone. An estimated more than 10% of the population in the United States show signs of hearing impairment and of that fraction, almost 80% use hearing aids. Approximately 500 million people worldwide suffer from hearing loss.

Compatibility Tests Involved:

The standard calls for wireless communications devices to be measured for:

- RF Electric-field emissions
- RF Magnetic-field emissions
- T-coil mode, magnetic-signal strength in the audio band
- T-coil mode, magnetic-signal frequency response through the audio band
- T-coil mode, magnetic-signal and noise articulation index

The hearing aid must be measured for:

- RF immunity in microphone mode
- RF immunity in T-coil mode

In the following tests and results, this report includes the evaluation for a wireless communications device.

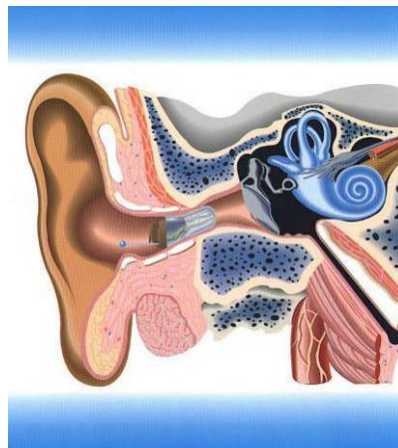



Figure 1-1 Hearing Aid *in-vitu*

¹ FCC Rule & Order, WT Docket 01-309 RM-8658

FCC ID: PP4EZ2	 PCTEST Engineering Laboratory, Inc.	HAC (RF EMISSIONS) TEST REPORT	 PANTECH & CURTEL	Reviewed by: Quality Manager
HAC Filename: 0705310542.PP4	Test Dates: June 6 - 8, 2007	EUT Type: Cellular/PCS CDMA Phone		Page 3 of 70



3. EUT DESCRIPTION



FCC ID: PP4EZ2
Manufacturer: Pantech & Curitel Communications, Inc.
110-1, Ongjeong-Ri, Tongjin-EUP, Gimpo-SI
Gyeonggi-Do, 415-865
Korea
Trade Name: Pantech & Curitel
Model(s): EZ2
Serial Number: #1
Tx Frequencies: 824.70 - 848.31 MHz (Cellular CDMA)
1851.25 - 1908.75 MHz (PCS CDMA)

Antenna Configurations: Internal Antenna
Maximum Conducted Power (EMC/SAR): 25 dBm (CDMA), 25 dBm (PCS)
Maximum Conducted Power (HAC): 25 dBm (CDMA), 25 dBm (PCS)
HAC Test Configurations: CDMA, 1013, 384, 777
PCS, 25, 600, 1175

FCC Classification: Licensed Transmitter Held to Ear (PCE)
EUT Type: Cellular/PCS CDMA Phone

FCC ID: PP4EZ2	 PCTEST wireless	HAC (RF EMISSIONS) TEST REPORT		Reviewed by: Quality Manager
HAC Filename: 0705310542.PP4	Test Dates: June 6 - 8, 2007	EUT Type: Cellular/PCS CDMA Phone		Page 5 of 70

4. ANSI/IEEE C63.19 PERFORMANCE CATEGORIES



I. RF EMISSIONS

The ANSI Standard presents performance requirements for acceptable interoperability of hearing aids with wireless communications devices. When these parameters are met, a hearing aid operates acceptably in close proximity to a wireless communications device.

Category	Telephone RF Parameters	
Near field Category	E-field emissions CW dB(V/m)	H-field emissions CW dB(A/m)
f < 960 MHz		
M1	56 to 61 + 0.5 x AWF	5.6 to 10.6 +0.5 x AWF
M2	51 to 56 + 0.5 x AWF	0.6 to 5.6 +0.5 x AWF
M3	46 to 51 + 0.5 x AWF	-4.4 to 0.6 +0.5 x AWF
M4	< 46 + 0.5 x AWF	< -4.4 + 0.5 x AWF
f > 960 MHz		
M1	46 to 51 + 0.5 x AWF	-4.4 to 0.6 +0.5 x AWF
M2	41 to 46 + 0.5 x AWF	-9.4 to -4.4 +0.5 x AWF
M3	36 to 41 + 0.5 x AWF	-14.4 to -9.4 +0.5 x AWF
M4	< 36 + 0.5 x AWF	< -14.4 + 0.5 x AWF
Table 4-1 Hearing aid and WD near-field categories as defined in ANSI C63.19-2006 v3.12 [2]		

II. ARTICULATION WEIGHTING FACTOR (AWF)

Standard	Technology	Articulation Weighing Factor (AWF)
T1/T1P1/3GPP	UMTS (WCDMA)	0
IS-95	CDMA	0
iDEN™	TDMA (22 and 11 Hz)	0
J-STD-007	GSM (217 Hz)	-5
Table 4-2 Articulation Weighing Factors		

FCC ID: PP4EZ2	 PCTEST	HAC (RF EMISSIONS) TEST REPORT	 PANTECH & CURITEL	Reviewed by: Quality Manager
HAC Filename: 0705310542.PP4	Test Dates: June 6 - 8, 2007	EUT Type: Cellular/PCS CDMA Phone	Page 6 of 70	

5. SYSTEM SPECIFICATIONS

ER3DV6 E-Field Probe Description

Construction:	One dipole parallel, two dipoles normal to probe axis Built-in shielding against static charges
Calibration:	In air from 100 MHz to 3.0 GHz (absolute accuracy $\pm 6.0\%$, $k=2$)
Frequency:	100 MHz to > 6 GHz; Linearity: ± 0.2 dB (100 MHz to 3 GHz)
Directivity	± 0.2 dB in air (rotation around probe axis) ± 0.4 dB in air (rotation normal to probe axis)
Dynamic Range	2 V/m to > 1000 V/m (M3 or better device readings fall well below diode compression point)
Linearity:	± 0.2 dB
Dimensions	Overall length: 330 mm (Tip: 16 mm) Tip diameter: 8 mm (Body: 12 mm) Distance from probe tip to dipole centers: 2.5 mm

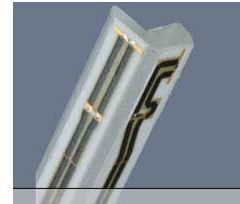

Figure 5-1
E-field Free-space Probe

H3DV6 H-Field Probe Description

Construction:	Three concentric loop sensors with 3.8 mm loop diameters Resistively loaded detector diodes for linear response Built-in shielding against static charges
Frequency:	200 MHz to 3 GHz (absolute accuracy $\pm 6.0\%$, $k=2$); Output linearized
Directivity:	± 0.25 dB (spherical isotropy error)
Dynamic Range:	10 mA/m to 2 A/m at 1 GHz (M3 or better device readings fall well below diode compression point)
Dimensions:	Overall length: 330 mm (Tip: 40 mm) Tip diameter: 6 mm (Body: 12 mm) Distance from probe tip to dipole centers: 3 mm
E-Field Interference:	< 10% at 3 GHz (for plane wave)





Figure 5-2
H-Field Free-space Probe

Probe Tip Description

HAC field measurements take place in the close near field with high gradients. Increasing the measuring distance from the source will generally decrease the measured field values (in case of the validation dipole approx. 10% per mm).

Magnetic field sensors are measuring the integral of the H-field across their sensor area surrounded by the loop. They are calibrated in a precise, homogeneous field. When measuring a gradient field, the result will be very close to the field in the center of the loop which is equivalent to the value of a homogeneous field equivalent to the center value. But it will be different from the field at the border of the loop.

FCC ID: PP4EZ2	 PCTEST Engineering Laboratory, Inc.	HAC (RF EMISSIONS) TEST REPORT	 PANTECH & CURITEL	Reviewed by: Quality Manager
HAC Filename: 0705310542.PP4	Test Dates: June 6 - 8, 2007	EUT Type: Cellular/PCS CDMA Phone		Page 7 of 70

Consequently, two sensors with different loop diameters - both calibrated ideally - would give different results when measuring from the edge of the probe sensor elements. The behavior for electrically small E-field sensors is equivalent.

The magnetic field loops of the H3D probes are concentric, with the center 3mm from the tip for H3DV6. Their radius is 1.9mm.

The electric field probes have a more irregular internal geometry because it is physically not possible to have the 3 orthogonal sensors situated with the same center. The effect of the different sensor centers is accounted for in the HAC uncertainty budget ("sensor displacement"). Their geometric center is at 2.5mm from the tip, and the element ends are 1.1mm closer to the tip.

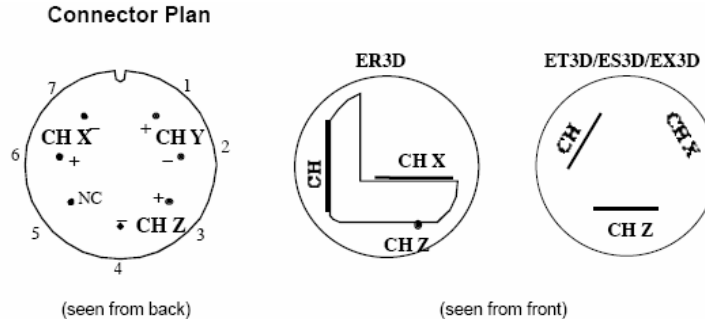

The antistatic shielding inside the probe is connected to the probe connector case.

Instrumentation Chain

Equation 1

Conversion of Connector Voltage u_i to E-Field E_i

$$E_i = \sqrt{\frac{u_i + (u_i^2 \cdot CF) / (DCP)}{Norm_i \cdot ConvF}}$$

whereby

- E_i : electric field in V/m
- u_i : voltage of channel i at the connector in μV
- $Norm_i$: sensitivity of channel i in $\mu V / (V/m)^2$
- $ConvF$: enhancement factor in liquid (ConvF=1 for Air)
- DCP : diode compression point in μV
- CF : signal crest factor (peak power/average power)

Conditions of Calibration

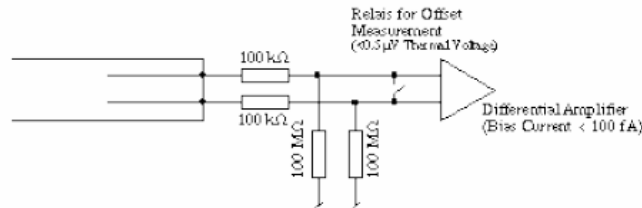

- Please note:
- a lower input impedance of the amplifier will result in different sensitivity factors $Norm_i$ and DCP
 - larger bias currents will cause higher offset

FCC ID: PP4EZ2	PCTEST	HAC (RF EMISSIONS) TEST REPORT	PANTECH & CURITEL	Reviewed by: Quality Manager
HAC Filename: 0705310542.PP4	Test Dates: June 6 - 8, 2007	EUT Type: Cellular/PCS CDMA Phone		Page 8 of 70

Probe Response to Frequency

The E-field sensors have inherently a very flat frequency response. They are calibrated with a number of frequencies resulting in a common calibration factor, with the frequency behavior documented in the calibration certificate (See also below).

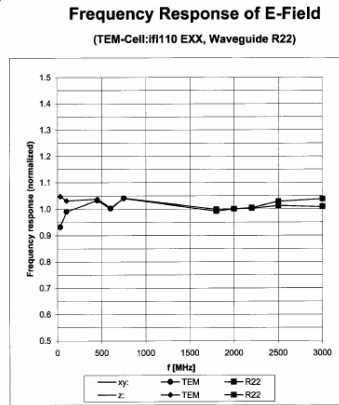

Uncertainty of Frequency Response of E-field: $\pm 6.3\%$ ($k=2$)

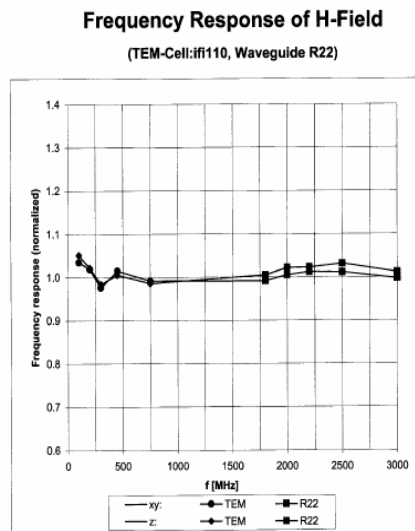

Figure 5-3 E-Field Probe Frequency Response

H-field sensors have a frequency dependent sensitivity which is evaluated for a series of frequencies also visible in the probe calibration certificate. The calibration factors result from a fitting algorithm. The proper conversion is calculated by the DASY4 software depending on the frequency setting in the procedure. See below for H-field frequency response:



Uncertainty of Frequency Response of E-field: $\pm 6.3\%$ ($k=2$)

Figure 5-4 H-Field Probe Frequency Response

FCC ID: PP4EZ2	 PCTEST microtest	HAC (RF EMISSIONS) TEST REPORT	 PANTECH & CURITEL	Reviewed by: Quality Manager
HAC Filename: 0705310542.PP4	Test Dates: June 6 - 8, 2007	EUT Type: Cellular/PCS CDMA Phone		Page 9 of 70

Conversion to Peak

Peak is defined as Peak Envelope Power. All raw measurements from the HAC measurement system are RMS values. The DASY4 system incorporates the crest factor of the signal in the computation of the RMS values (See Equation 1). Although the software also has capability to estimate the peak field by applying a square root of crest factor value to the readings, the probe modulation factor was applied manually instead per C63.19 in the measurement tables in this report. The equation to convert the raw measurements in the data tables are:

$$\text{Peak Field} = 20 \cdot \log(\text{Raw} \cdot \text{PMF})$$

Where:

Peak Field = Peak field (in dBV/m or dBA/m)

Raw = Raw field measurement from the measurement system (in V/m or A/m).

PMF = Probe Modulation Factor (in linear units).

SPEAG Robotic System



E-field and H-field measurements are performed using the DASY4 automated dosimetric assessment system. The DASY4 is made by Schmid & Partner Engineering AG (SPEAG) in Zurich, Switzerland and consists of high precision robotics system (Staubli), robot controller, Pentium 4 computer, near-field probe, probe alignment sensor, and the HAC phantom. The robot is a six-axis industrial robot performing precise movements to position the probe to the location (points) of maximum electromagnetic field (EMF).



Figure 5-5
SPEAG Robotic System

System Hardware

A cell controller system contains the power supply, robot controller, teach pendant (Joystick), and a remote control used to drive the robot motors. The PC consists of the Gateway Pentium 4 2.53 GHz computer with Windows XP system and RF Measurement Software DASY4 v4.5 (with HAC Extension), A/D interface card, monitor, mouse, and keyboard. The Staubli Robot is connected to the cell controller to allow software manipulation of the robot. A data acquisition electronic (DAE) circuit that performs the signal amplification, signal multiplexing, AD-conversion, offset measurements, mechanical surface detection, collision detection, etc. is connected to the Electro-optical coupler (EOC). The EOC performs the conversion from the optical into digital electric signal of the DAE and transfers data to the PC plug-in card.

FCC ID: PP4EZ2	 PCTEST microtest	HAC (RF EMISSIONS) TEST REPORT	 PANTECH & CURITEL	Reviewed by: Quality Manager
HAC Filename: 0705310542.PP4	Test Dates: June 6 - 8, 2007	EUT Type: Cellular/PCS CDMA Phone	Page 10 of 70	

System Electronics

The DAE consists of a highly sensitive electrometer-grade preamplifier with auto-zeroing, a channel and gain-switching multiplexer, a fast 16 bit AD-converter and a command decoder and control logic unit. Transmission to the PC-card is accomplished through an optical downlink for data and status information and an optical uplink for commands and clock lines. The mechanical probe mounting device includes two different sensor systems for frontal and sidewise probe contacts. They are also used for mechanical surface detection and probe collision detection. The robot uses its own controller with a built in VME-bus computer.

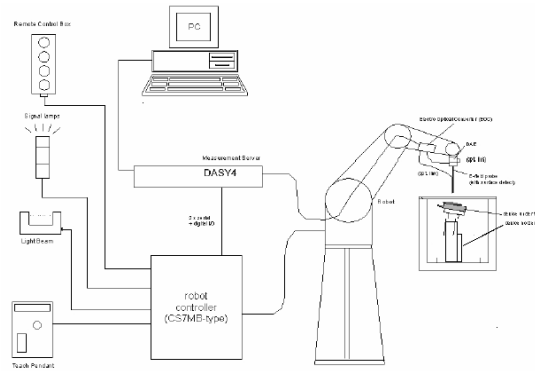



Figure 5-6
SPEAG Robotic System Diagram

DASY4 Instrumentation Chain

The first step of the evaluation is a linearization of the filtered input signal to account for the compression characteristics of the detector diode. The compensation depends on the input signal, the diode type and the DC-transmission factor from the diode to the evaluation electronics. If the exciting field is pulsed, the crest factor of the signal must be known to correctly compensate for peak power. The formula for each channel can be given as:

$$V_i = U_i + U_i^2 \cdot \frac{cf}{dcp_i}$$

with V_i	= compensated signal of channel i	(i = x, y, z)
U_i	= input signal of channel i	(i = x, y, z)
cf	= crest factor of exciting field	(DASY parameter)
dcp_i	= diode compression point	(DASY parameter)

FCC ID: PP4EZ2	 PCTEST	HAC (RF EMISSIONS) TEST REPORT	 PANTECH & CURITEL	Reviewed by: Quality Manager
HAC Filename: 0705310542.PP4	Test Dates: June 6 - 8, 2007	EUT Type: Cellular/PCS CDMA Phone		Page 11 of 70

From the compensated input signals the primary field data for each channel can be evaluated:

$$\text{E - fieldprobes : } E_i = \sqrt{\frac{V_i}{Norm_i \cdot ConvF}}$$

$$\text{H - fieldprobes : } H_i = \sqrt{V_i} \cdot \frac{a_{i0} + a_{i1}f + a_{i2}f^2}{f}$$

with V_i = compensated signal of channel i (i = x, y, z)
 $Norm_i$ = sensor sensitivity of channel i (i = x, y, z)
 $\mu\text{V}/(\text{V/m})^2$ for E-field Probes
 $ConvF$ = sensitivity enhancement in solution
 a_{ij} = sensor sensitivity factors for H-field probes
 f = carrier frequency [GHz]
 E_i = electric field strength of channel i in V/m
 H_i = magnetic field strength of channel i in A/m

The RSS value of the field components gives the total field strength (Hermitian magnitude):



$$E_{tot} = \sqrt{E_x^2 + E_y^2 + E_z^2}$$

The primary field data are used to calculate the derived field units.

The measurement/integration time per point, as specified by the system manufacturer is >500 ms.

The signal response time is evaluated as the time required by the system to reach 90% of the expected final value after an on/off switch of the power source with an integration time of 500 ms and a probe response time of <5 ms. In the current implementation, DASY4 waits longer than 100 ms after having reached the grid point before starting a measurement, i.e., the response time uncertainty is negligible.



If the device under test does not emit a CW signal, the integration time applied to measure the electric field at a specific point may introduce additional uncertainties due to the discretization. The tolerances for the different systems had the worst-case of 2.6%.

FCC ID: PP4EZ2	 PCTEST microtest	HAC (RF EMISSIONS) TEST REPORT	 PANTECH & CURITEL	Reviewed by: Quality Manager
HAC Filename: 0705310542.PP4	Test Dates: June 6 - 8, 2007	EUT Type: Cellular/PCS CDMA Phone	Page 12 of 70	

6. TEST PROCEDURE

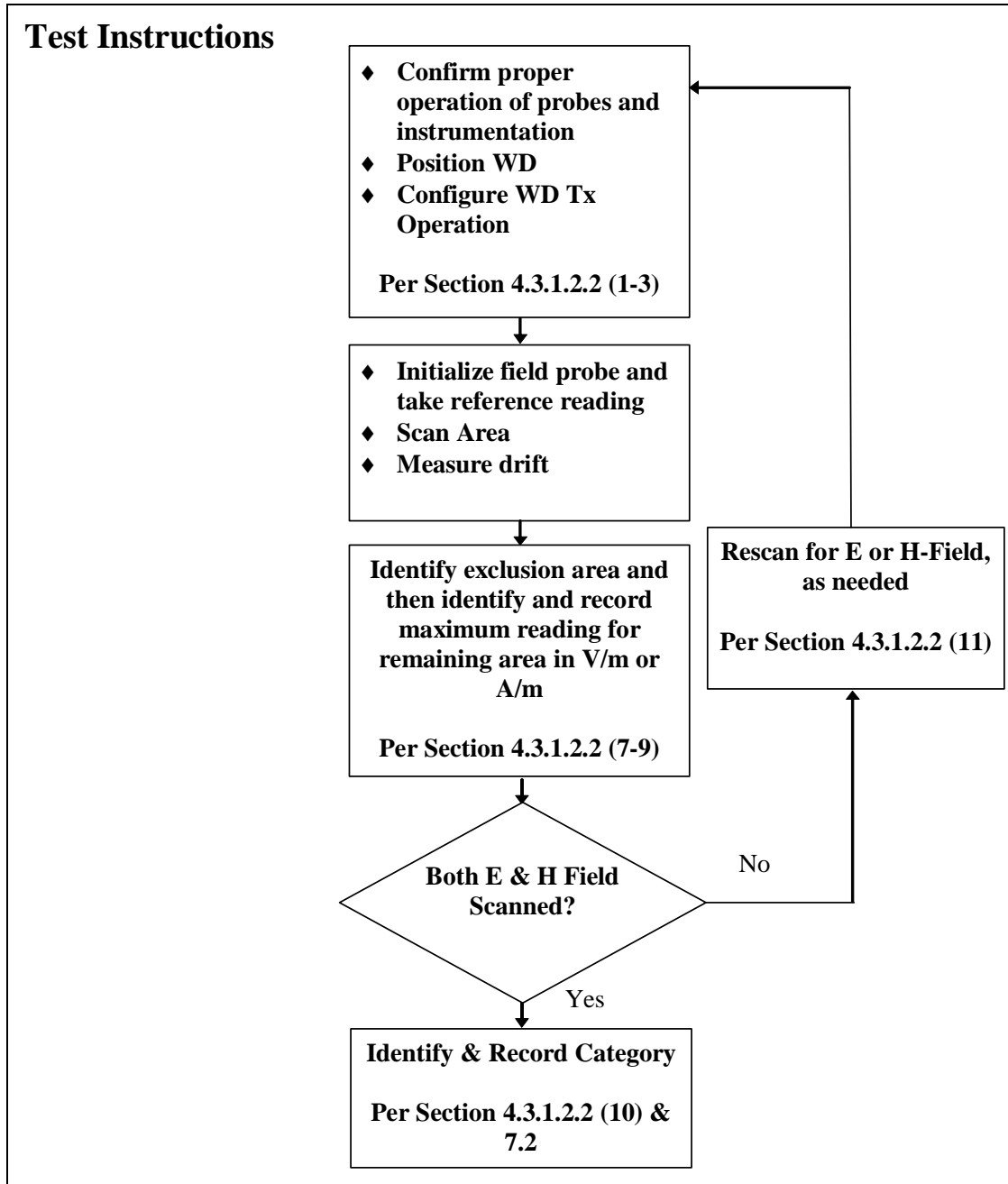
I. RF EMISSIONS



FCC ID: PP4EZ2	 PCTEST	HAC (RF EMISSIONS) TEST REPORT	 PANTECH & CURITEL	Reviewed by: Quality Manager
HAC Filename: 0705310542.PP4	Test Dates: June 6 - 8, 2007	EUT Type: Cellular/PCS CDMA Phone		Page 13 of 70

Test Setup

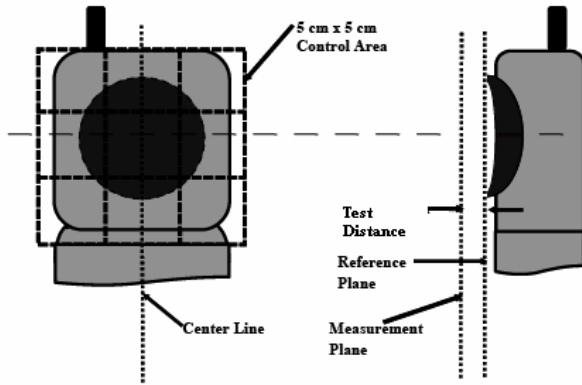

Figure 6-1

E/H-Field Emissions Test Setup Diagram (See Test Photographs for actual WD scan grid overlay)

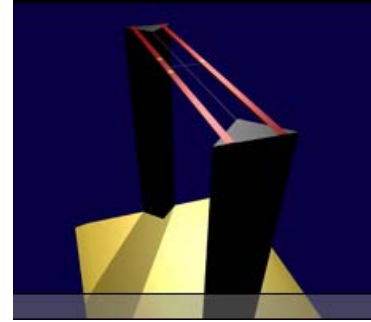



Figure 6-2
HAC Phantom

RF Emissions Test Procedure:

The following illustrate a typical RF emissions test scan over a wireless communications device:

1. Proper operation of the field probe, probe measurement system, other instrumentation, and the positioning system was confirmed.
2. WD is positioned in its intended test position, acoustic output point of the device perpendicular to the field probe.
3. The WD operation for maximum rated RF output power was configured and confirmed with the base station simulator, at the test channel and other normal operating parameters as intended for the test. The battery was ensured to be fully charged before each test.
4. The center sub-grid was centered over the center of the acoustic output (also audio band magnetic output, if applicable). The WD audio output was positioned tangent (as physically possible) to the measurement plane.
5. A surface calibration was performed before each setup change to ensure repeatable spacing and proper maintenance of the measurement plane using the HAC Phantom.
6. The measurement system measured the field strength at the reference location.
7. Measurements at 2mm increments in the 5 x 5 cm region were performed at a distance 1 cm from the probe elements to the WD. A 360° rotation about the azimuth axis at the maximum interpolated position was measured. For the worst-case condition, the peak reading from this rotation was used in re-evaluating the HAC category.
8. The system performed a drift evaluation by measuring the field at the reference location.
9. Steps 1-8 were done for both the E and H-Field measurements.

FCC ID: PP4EZ2	 PCTEST Engineering Laboratory, Inc.	HAC (RF EMISSIONS) TEST REPORT		Reviewed by: Quality Manager
HAC Filename: 0705310542.PP4	Test Dates: June 6 - 8, 2007	EUT Type: Cellular/PCS CDMA Phone		Page 14 of 70

7. SYSTEM CHECK

I. System Check Parameters

The input signal was an un-modulated continuous wave. The following points were taken into consideration in performing this check:

- Average Input Power $P = 100\text{mW RMS}$ (20dBm RMS) after adjustment for return loss
- The test fixture must meet the 2 wavelength separation criterion
- The proper measurement of the 1 cm probe to dipole separation, which is measured from top surface of the dipole to the calibration reference point of the sensor, defined by the probe manufacturer is shown in the following diagram:

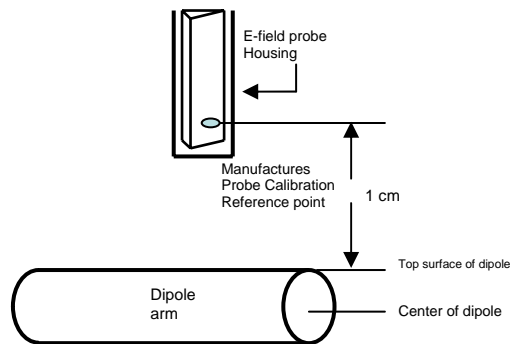

Figure 7-1
Separation Distance from Dipole to Field Probe

RF power was recorded using both an average reading meter and a peak reading meter. Readings of the probe are provided by the measurement system.

To assure proper operation of the near-field measurement probe the input power to the dipole shall be commensurate with the full rated output power of the wireless device (e.g. - for a cellular phone wireless device the average peak antenna input power will be on the order of 100mW (i.e. - 20dBm) RMS after adjustment for any mismatch.



II. Validation Procedure

A dipole antenna meeting the requirements given in C63.19 was placed in the position normally occupied by the WD.

The length of the dipole was scanned with both E-field and H-field probes and the maximum values for each were recorded.

Measurement of CW

Using the near-field measurement system, scan the antenna over the radiating dipole and record the greatest field reading observed. Due to the nature of E-fields about free-space dipoles, the two E-field peaks measured over the dipole are averaged to compensate for non-parallelity of the setup (

FCC ID: PP4EZ2	 PCTEST Engineering Laboratory, Inc.	HAC (RF EMISSIONS) TEST REPORT	 PANTECH & CURITEL	Reviewed by: Quality Manager
HAC Filename: 0705310542.PP4	Test Dates: June 6 - 8, 2007	EUT Type: Cellular/PCS CDMA Phone		Page 15 of 70

see manufacturer method on dipole calibration certificates, page 2). Field strength measurements shall be made only when the probe is stationary.

RF power was recorded using both an average and a peak power reading meter.

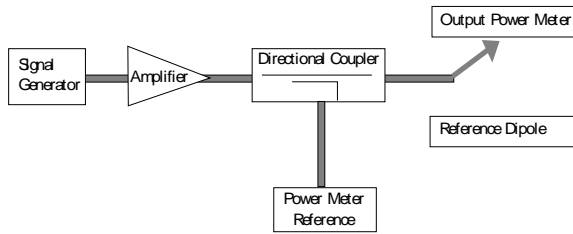

Figure 7-2

Setup for Desired Output Power to Dipole

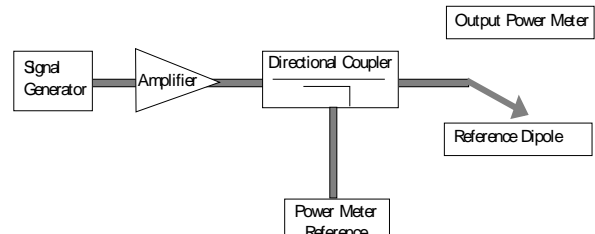

Figure 7-3

Setup to Dipole

Using this setup configuration, the signal generator was adjusted for the desired output power (100mW) at a specified frequency. The reference power from the coupled port of the directional coupler is recorded. Next, the output cable is connected to the reference dipole, as shown in Figure 7-3.

The input signal level was adjusted until the reference power from the coupled port of the directional coupler was the same as previously recorded, to compensate for the impedance mismatch between the output cable and the reference dipole. To assure proper operation of the near-field measurement probe the input power to the reference dipole was verified to the full rated output power of the wireless device. The dipole was secured in a holder in a manner to meet the 20 dB reflection. The near-field measurement probe was positioned over the dipole. The antenna was scanned over the appropriate sized area to cover the dipole from end to end. SPEAG uses 2D interpolation algorithms between the measured points. Please see below two dimensional plots showing that the interpolated values interpolate smoothly between 5mm steps for a free-space RF dipole:

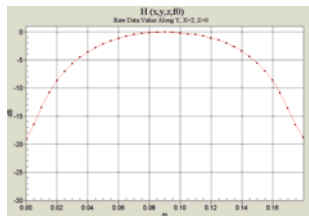

Figure 7-4

2-D Raw Data from scan along dipole axis

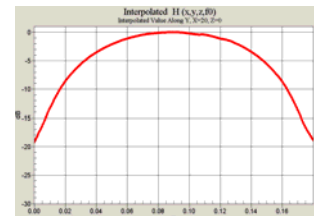

Figure 7-5

2-D Interpolated points from scan along dipole axis

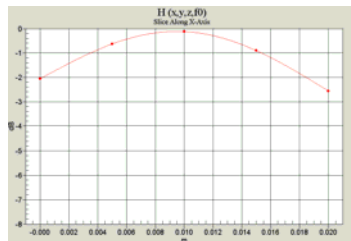

Figure 7-6

2-D Raw Data from scan along transverse axis

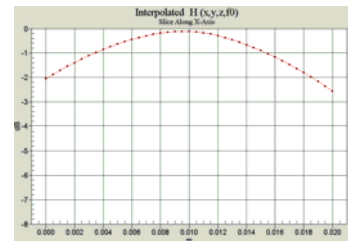

Figure 7-7

2-D Interpolated points from scan along transverse axis

FCC ID: PP4EZ2	PCTEST	HAC (RF EMISSIONS) TEST REPORT	PANTECH & CURITEL	Reviewed by: Quality Manager
HAC Filename: 0705310542.PP4	Test Dates: June 6 - 8, 2007	EUT Type: Cellular/PCS CDMA Phone		Page 16 of 70

III. System Check Results

Validation Results

Frequency (MHz)	Input Power (dBm)	E-field Result (V/m)	Target Field (V/m)	% Deviation
835	20.0	177.7	167.3	6.2%
1880	20.0	139.8	134.6	3.8%
Frequency (MHz)	Input Power (dBm)	H-field Result (A/m)	Target Field (A/m)	% Deviation
835	20.0	0.463	0.454	2.1%
1880	20.0	0.408	0.451	-9.6%

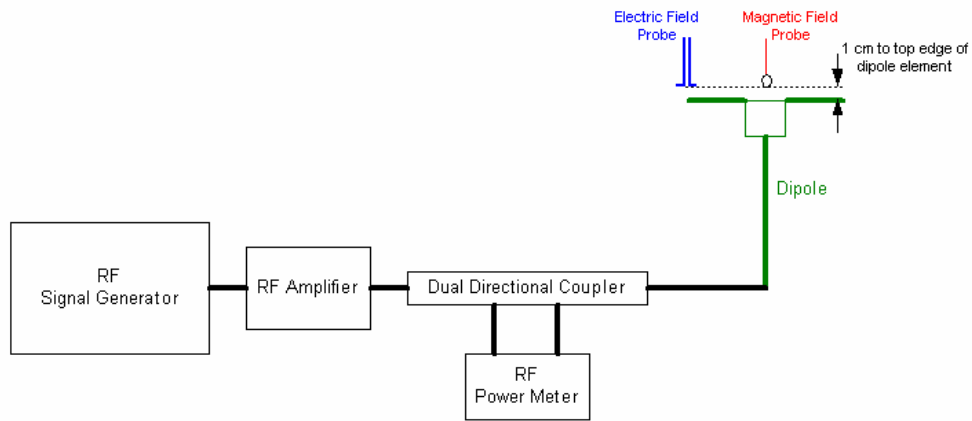



Figure 7-8
System Check Setup

FCC ID: PP4EZ2	 PCTEST	HAC (RF EMISSIONS) TEST REPORT	 PANTECH & CURITEL	Reviewed by: Quality Manager
HAC Filename: 0705310542.PP4	Test Dates: June 6 - 8, 2007	EUT Type: Cellular/PCS CDMA Phone		Page 17 of 70

8. MODULATION FACTOR

A calibration was made of the modulation response of the probe and its instrumentation chain. This calibration was performed with the field probe, attached to its instrumentation. The response of the probe system to a CW field at the frequency of interest is compared to its response to a modulated signal with equal peak amplitude to that of a CW signal. The field level of the test signals are ensured to be more than 10 dB above the ambient level and the noise floor of the instrumentation being used. The ratio of the CW reading to that taken with a modulated reading was applied to the DUT measurements.

All voice modes for this device have been investigated in this section of the report. According to the FCC 3G Measurement Procedures, May 2006 for RF Emissions, variations in peak field and power readings.

This was done using the following procedure:

1. The probe was illuminated with a CW signal at the intended measurement frequency and wireless device power.
2. The probe was positioned at the field maxima over the dipole antenna (determined after an area scan over the dipole) illuminated with the CW signal.
3. The reading of the probe measurement system of the CW signal at the maximum point was recorded.
4. Using a Spectrum Analyzer, the modulated signal adjusted with the same peak level of the CW signal was determined.
5. The probe measurement system reading was recorded with the modulated signal. The appropriate system crest factors for the modulation type were configured in the software to the system measurements.
6. The ratio of the CW reading to modulated signal reading is the probe modulation factor (PMF) for the modulation and field probe combination. This was repeated for 80% AM.
7. Steps 1-6 were repeated at all frequency bands and for both E and H field probes.

The modulation factors obtained were applied to readings taken of the actual wireless device, in order to obtain an accurate peak field reading using the formula:

$$\text{Peak} = 20 \cdot \log (\text{Raw} \cdot \text{PMF})$$

This method correlates well with the modulation using the DUT in the alternative substitution method. See below for correlation of signal:

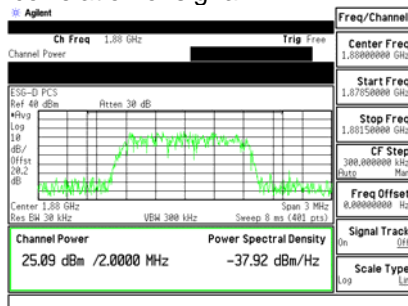

Figure 8-1
Signal Generator Modulated Signal

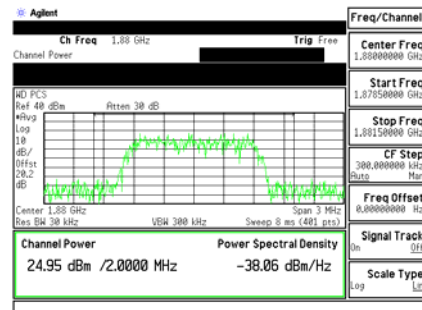

Figure 8-2
Wireless Device Modulated Signal

FCC ID: PP4E22	PCTEST Engineering Laboratory, Inc.	HAC (RF EMISSIONS) TEST REPORT	PANTECH & CURITEL	Reviewed by: Quality Manager
HAC Filename: 0705310542.PP4	Test Dates: June 6 - 8, 2007	EUT Type: Cellular/PCS CDMA Phone		Page 18 of 70

Modulation Factors:

f (MHz)	Protocol	E-Field (V/m)	H-Field (A/m)	E-Field Modulation Factor	H-Field Modulation Factor
835	AM	226.80	0.6312	1.388	1.258
835	CDMA	335.30	1.0040	0.939	0.791
835	CW	314.90	0.7941		
1880	AM	207.90	0.6922	1.373	1.086
1880	CDMA	294.80	1.1200	0.968	0.671
1880	CW	285.50	0.7515		
f (MHz)	Protocol	E-Field (V/m)	E-Field Modulation Factor		
1880	CDMA / SO3	28.76	2.872		
1800	CW	82.60			

Figure 8-3
Modulation Factors

FCC 3G Note: "CDMA*" represents worst-case mode, while "CDMA/SO3" represents RC1/SO3 mode.

CW and Modulated Signal Zero-Span plots:

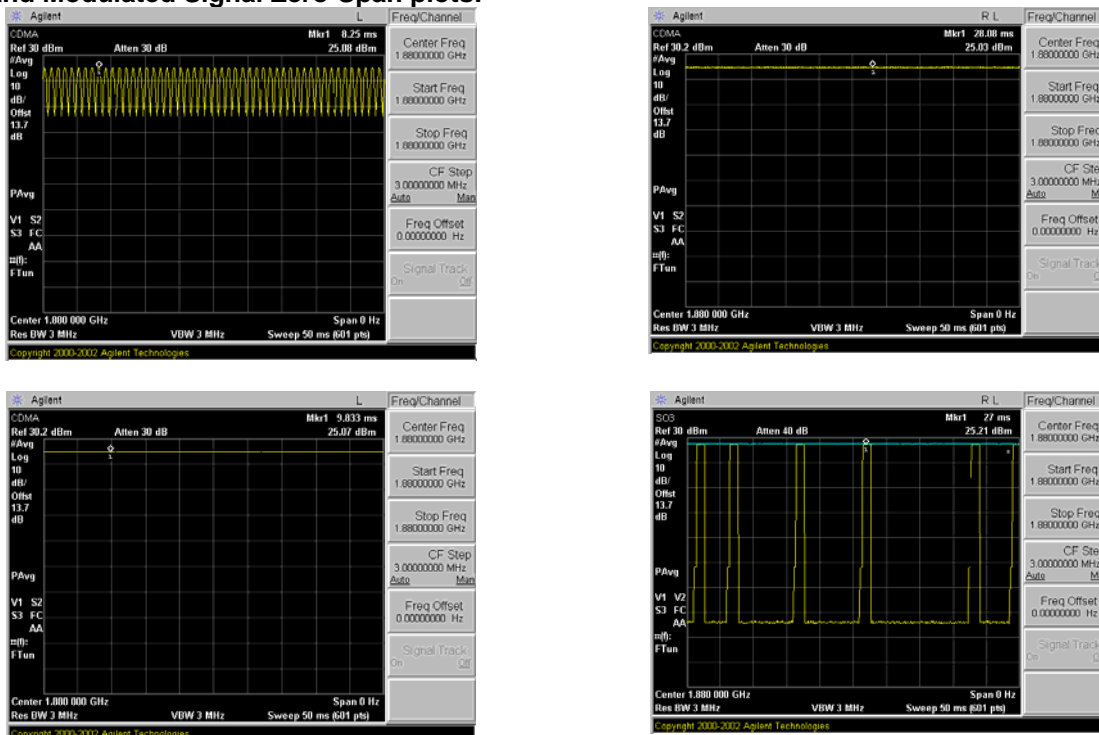

Figure 8-4 Zero-Span Plots

FCC ID: PP4E22	PCTEST	HAC (RF EMISSIONS) TEST REPORT	PANTECH & CURITEL	Reviewed by: Quality Manager
HAC Filename: 0705310542.PP4	Test Dates: June 6 - 8, 2007	EUT Type: Cellular/PCS CDMA Phone		Page 19 of 70

9. FCC 3G MEASUREMENTS – MAY/JUNE 2006

Sample pre-testing of the various modes were performed at the worst case probe location as part of subset testing justification. See below for measured conducted power for applicable device modes:

I. Handset Capabilities*:

*See Device Capabilities attachment for applicable device modes and powers.

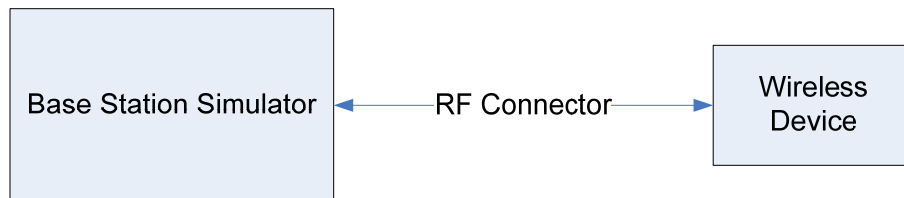



Figure 9-1
Power Measurement Setup

II. Worst-Case Probe Location Measurements

Below are RC/SO mode investigation results of the device at the worst-case (maximum) field point location. The worst-case RC/SO was used for HAC testing.

Table 9-1
Handset 3G mode variation on RF Emissions

Mode	Channel	Backlight	RC/SO	Scan Center	Battery	Antenna	Conducted Power at BS (dBm)	Time Avg. Field (V/m)	Peak Field (dBV/m)	FCC Limit (dBV/m)	FCC MARGIN (dB)	RESULT
PCS	600	on	SO3/RC1	Acoustic	Extended	Fixed	25.43	9.74	28.9	41.0	-12.07	M4
PCS	600	on	SO3/RC3	Acoustic	Extended	Fixed	25.43	25.65	27.9	41.0	-13.10	M4
PCS	600	on	SO3/RC4	Acoustic	Extended	Fixed	25.43	25.37	27.8	41.0	-13.19	M4
PCS	600	on	SO55/RC3	Acoustic	Extended	Fixed	25.43	26.05	28.0	41.0	-12.96	M4
PCS	600	on	SO55/RC1	Acoustic	Extended	Fixed	25.43	25.78	27.9	41.0	-13.05	M4
PCS	600	on	SO2/RC1	Acoustic	Extended	Fixed	25.43	25.02	27.7	41.0	-13.31	M4
PCS	600	on	SO2/RC3	Acoustic	Extended	Fixed	25.43	24.70	27.6	41.0	-13.42	M4
PCS	600	on	SO9/RC2	Acoustic	Extended	Fixed	25.43	25.43	27.8	41.0	-13.17	M4
PCS	600	on	SO9/RC5	Acoustic	Extended	Fixed	25.43	25.72	27.9	41.0	-13.07	M4

FCC ID: PP4E22	 PCTEST Engineering Laboratory, Inc.	HAC (RF EMISSIONS) TEST REPORT	 PANTECH & CURITEL	Reviewed by: Quality Manager
HAC Filename: 0705310542.FP4	Test Dates: June 6 - 8, 2007	EUT Type: Cellular/PCS CDMA Phone		Page 20 of 70

10. OVERALL MEASUREMENT SUMMARY

FCC ID:	PP4EZ2
Model:	EZ2
S/N:	#1

I. E-FIELD EMISSIONS:

**Table 10-1
HAC Data Summary for E-field**

Mode	Channel	Backlight	RC/SO	Scan Center	Battery	Antenna	Conducted Power at BS (dBm)	Time Avg. Field (V/m)	Peak Field (dBV/m)	FCC Limit (dBV/m)	FCC MARGIN (dB)	RESULT	Excl Blocks per 4.3.1.2.2
E-field Emissions													
CDMA	1013	on	RC3/SO55	Acoustic	Extended	Fixed	25.04	41.20	31.8	51.0	-19.25	M4	none
CDMA	384	on	RC3/SO55	Acoustic	Extended	Fixed	24.95	60.77	35.1	51.0	-15.87	M4	none
CDMA	777	on	RC3/SO55	Acoustic	Extended	Fixed	24.97	63.27	35.5	51.0	-15.52	M4	none
PCS	25	on	RC3/SO55	Acoustic	Extended	Fixed	24.89	23.76	27.2	41.0	-13.76	M4	none
PCS	600	on	RC3/SO55	Acoustic	Extended	Fixed	25.43	26.22	28.1	41.0	-12.91	M4	none
PCS	1175	on	RC3/SO55	Acoustic	Extended	Fixed	24.97	26.05	28.0	41.0	-12.96	M4	none
PCS	600	on	RC3/SO55	T-coil	Extended	Fixed	25.43	24.26	27.4	41.0	-13.58	M4	none
PCS	600	on	RC3/SO55	Acoustic	Standard	Fixed	25.43	25.99	28.0	41.0	-12.98	M4	none

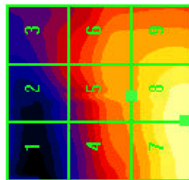



Figure 10-1
Sample E-field Scan Overlay
(See Test Setup Photographs for actual WD overlay)

Note: Worst-case measurement evaluated for worst-case 1/8 rate gating condition in RC1/SO3; Mute=Yes

FCC ID: PP4EZ2	 PCTEST <small>Engineering Laboratory, Inc.</small>	HAC (RF EMISSIONS) TEST REPORT		Reviewed by: Quality Manager
HAC Filename: 0705310542.PP4	Test Dates: June 6 - 8, 2007	EUT Type: Cellular/PCS CDMA Phone	Page 21 of 70	

FCC ID:	PP4EZ2
Model:	EZ2
S/N:	#1

II. H-FIELD EMISSIONS:

**Table 10-2
HAC Data Summary for H-field**

Mode	Channel	Backlight	RC/SO	Scan Center	Battery	Antenna	Conducted Power at BS (dBm)	Time Avg. Field (A/m)	Peak Field (dBA/m)	FCC Limit (dBA/m)	FCC MARGIN (dB)	RESULT	Excl Blocks per 4.3.1.2.2
H-field Emissions													
CDMA	1013	on	RC3/SO55	Acoustic	Extended	Fixed	25.04	0.0832	-23.6	0.6	-24.24	M4	none
CDMA	384	on	RC3/SO55	Acoustic	Extended	Fixed	24.95	0.0605	-26.4	0.6	-27.00	M4	none
CDMA	777	on	RC3/SO55	Acoustic	Extended	Fixed	24.97	0.1071	-21.4	0.6	-22.04	M4	none
PCS	25	on	RC3/SO55	Acoustic	Extended	Fixed	24.89	0.0507	-29.4	-9.4	-19.96	M4	none
PCS	600	on	RC3/SO55	Acoustic	Extended	Fixed	25.43	0.0573	-28.3	-9.4	-18.90	M4	none
PCS	1175	on	RC3/SO55	Acoustic	Extended	Fixed	24.97	0.0634	-27.4	-9.4	-18.03	M4	none

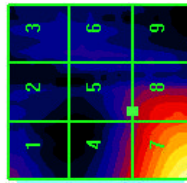



Figure 10-2
Sample H-field Scan Overlay
(See Test Setup Photographs for actual WD overlay)

FCC ID: PP4EZ2	 PCTEST <small>Engineering Laboratory, Inc.</small>	HAC (RF EMISSIONS) TEST REPORT		Reviewed by: Quality Manager
HAC Filename: 0705310542.FP4	Test Dates: June 6 - 8, 2007	EUT Type: Cellular/PCS CDMA Phone		Page 22 of 70

FCC ID:	PP4EZ2
Model:	EZ2
S/N:	#1

III. Worst-case Configuration Evaluation

Table 10-3
Peak Reading 360° Probe Rotation at Azimuth axis

Mode	Channel	Backlight	RC/SO	Scan Center	Battery	Antenna	Conducted Power at BS (dBm)	Time Avg. Field (V/m)	Peak Field (dBV/m)	FCC Limit (dBV/m)	FCC MARGIN (dB)	RESULT
Probe Rotation at Worst-case												
PCS	600	on	RC3/SO55	Acoustic	Extended	Fixed	25.43	27.00	28.3	41.0	-12.65	M4

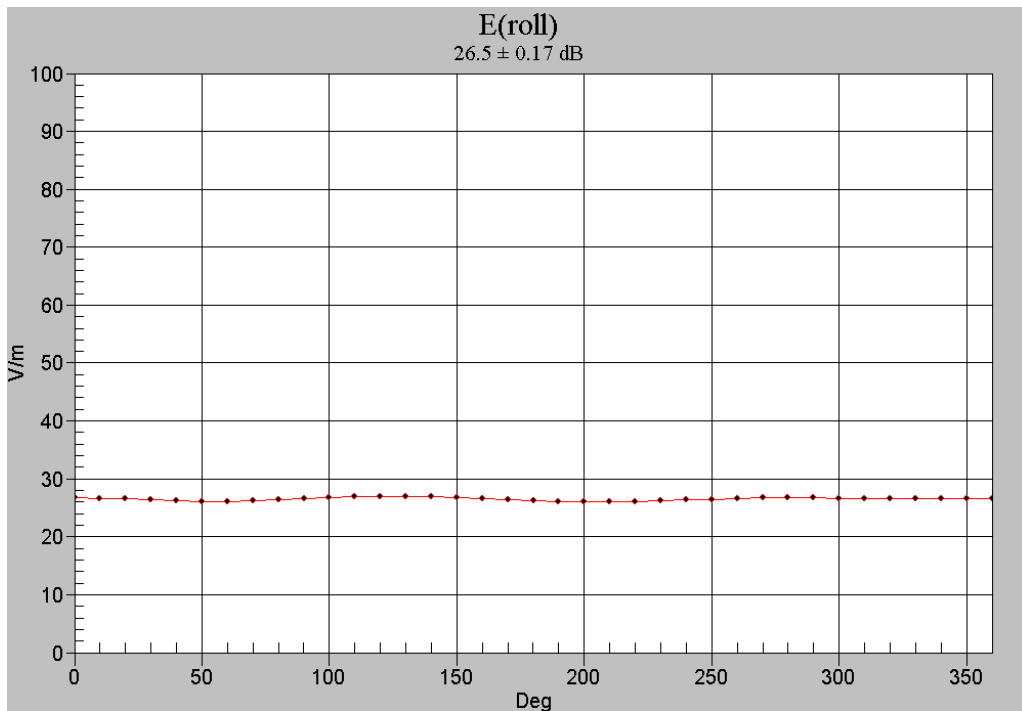



Figure 10-3
Worst-Case Probe Rotation about Azimuth axis

* Note: Location of probe rotation is shown in Figure 10-1 or Figure 10-2



FCC ID: PP4EZ2	 PCTEST microtest	HAC (RF EMISSIONS) TEST REPORT	 PANTECH & CURITEL	Reviewed by: Quality Manager
HAC Filename: 0705310542.PP4	Test Dates: June 6 - 8, 2007	EUT Type: Cellular/PCS CDMA Phone	Page 23 of 70	

11. EQUIPMENT LIST

Manufacturer	Model / Equipment	Calibration Date	Cal Interval	Calibration Due	Serial No.
Agilent	E4407B ESA Spectrum Analyzer	4/29/2007	Annual	4/28/2008	US39210313
Agilent	N4010A Wireless Connectivity Test Set	6/11/2006	Annual	6/11/2007	GB46170464
Agilent	E5515C Wireless Communications Test Set	7/27/2006	Biennial	7/26/2008	GB41450275
Agilent	E5515C Wireless Communications Test Set	10/6/2006	Biennial	10/5/2008	GB43193972
Agilent	E4432B ESG-D Series Signal Generator	8/8/2006	Annual	8/8/2007	US40053896
Agilent	8648D (9kHz-4GHz) Signal Generator	10/1/2006	Annual	10/1/2007	3613A00315
Agilent	E5515C Wireless Communications Test Set	10/26/2006	Biennial	10/25/2008	GB46310798
Rohde & Schwarz	CMU200 Base Station Simulator	11/8/2006	Annual	11/8/2007	107826
Rohde & Schwarz	CMU200 Base Station Simulator	7/26/2006	Annual	7/26/2007	833855/010
SPEAG	CD835V3 Freespace 835 MHz Dipole	1/16/2007	Biennial	1/15/2009	1003
SPEAG	CD1880V3 Freespace 1880 MHz Dipole	1/16/2007	Biennial	1/15/2009	1002
SPEAG	H3DV6 Freespace H-field Probe	1/23/2007	Annual	1/23/2008	6180
SPEAG	ER3DV6 Freespace E-field Probe	1/23/2007	Annual	1/23/2008	2332
SPEAG	DAE4	5/24/2007	Annual	5/23/2008	704
SPEAG	CD835V3 Freespace 835 MHz Dipole	7/17/2006	Biennial	7/16/2008	1082
SPEAG	CD1880V3 Freespace 1880 MHz Dipole	7/18/2006	Biennial	7/17/2008	1064
SPEAG	CD2450V3 Freespace 2450 MHz Dipole	7/18/2006	Biennial	7/17/2008	1062
SPEAG	H3DV6 Freespace H-field Probe	7/10/2006	Annual	7/10/2007	6207
SPEAG	ER3DV6 Freespace E-field Probe	7/10/2006	Annual	7/10/2007	2335
SPEAG	DAE4	9/4/2006	Annual	9/4/2007	665
SPEAG	H3DV6 Freespace H-field Probe	10/13/2006	Annual	10/13/2007	6170
SPEAG	ER3DV6 Freespace E-field Probe	10/13/2006	Annual	10/13/2007	2353
SPEAG	DAE3	10/16/2006	Annual	10/16/2007	455
SPEAG	DAE4	1/23/2007	Annual	1/23/2008	649

Table 11-1
Equipment List

*Calibration traceable to the National Institute of Standards and Technology (NIST).

FCC ID: PP4EZ2	 PCTEST Engineering Laboratory, Inc.	HAC (RF EMISSIONS) TEST REPORT	 PANTECH & CURITEL	Reviewed by: Quality Manager
HAC Filename: 0705310542.PP4	Test Dates: June 6 - 8, 2007	EUT Type: Cellular/PCS CDMA Phone	Page 24 of 70	

12. MEASUREMENT UNCERTAINTY



Wireless Communications Device Near-Field Measurement						
Uncertainty Estimation						
Uncertainty Component	Data (dB)	Data Type	Prob. Dist.	Divisor	Unc. (dB)	Notes/Comments
Measurement System						
RF System Reflections	0.50	Tolerance	N	1.00	0.50	Ref. < -20 dB
Field Probe Calibration	0.21	Tolerance	N	1.00	0.21	
Field Probe Isotropy	0.01	Tolerance	N	1.00	0.01	
Field Probe Frequency Response	0.135	Tolerance	N	1.00	0.14	
Field Probe Linearity	0.013	Tolerance	N	1.00	0.01	
Probe Modulation Factor	0.468	Accuracy	R	1.73	0.28	
Boundary Effects	0.105	Accuracy	R	1.73	0.06	*
Probe Positioning Accuracy	0.20	Accuracy	R	1.73	0.12	*
Probe Positioner	0.050	Accuracy	R	1.73	0.03	*
Extrapolation/Interpolation	0.045	Tolerance	R	1.73	0.03	*
System Detection Limit	0.05	Tolerance	R	1.73	0.03	*
Readout Electronics	0.015	Tolerance	N	1.00	0.02	*
Integration Time	0.11	Tolerance	R	1.73	0.06	*
Response Time	0.033	Tolerance	R	1.73	0.02	*
Phantom Thickness	0.10	Tolerance	R	1.73	0.06	*
System Repeatability (Field x 2=power)	0.17	Tolerance	N	1.00	0.17	
Test Sample Related						
Device Positioning Vertical	0.2	Tolerance	R	1.73	0.12	*
Device Positioning Lateral	0.045	Tolerance	R	1.73	0.03	*
Device Holder and Phantom	0.1	Tolerance	R	1.73	0.06	*
Power Drift	0.21	Tolerance	R	1.73	0.12	
<i>Combined Standard Uncertainty (k=1)</i>					0.67	16.6%
<i>Expanded Uncertainty [95% confidence] (k=2)</i>					1.34	32.6%
Expanded Uncertainty [95% confidence] on Field					0.67	16.3%

Table 12-1
Uncertainty Estimation Table

Notes:



1. Test equipments are calibrated according to techniques outlined in NIS81, NIS3003 and NIST Tech Note 1297. All equipments have traceability according to NIST. Measurement Uncertainties are defined in further detail in NIS 81 and NIST Tech Note 1297 and UKAS M3003.
2. * Uncertainty specifications from Schmidt & Partner Engineering AG (not site specific)

Measurement uncertainty reflects the quality and accuracy of a measured result as compared to the true value. Such statements are generally required when stating results of measurements so that it is clear to the intended audience that the results may differ when reproduced by different facilities. Measurement results vary due to the measurement uncertainty of the instrumentation, measurement technique, and test engineer. Most uncertainties are calculated using the tolerances of the instrumentation used in the measurement, the measurement setup variability, and the technique used in performing the test. While not generally included, the variability of the equipment under test also figures into the overall measurement uncertainty. Another component of the overall uncertainty is based on the variability of repeated measurements (so-called Type A uncertainty). This may mean that the Hearing Aid immunity tests may have to be repeated by taking down the test setup and resetting it up so that there are a statistically significant number of repeat measurements to identify the measurement uncertainty. By combining the repeat measurement results with that of the instrumentation chain using the technique contained in NIS 81 and NIS 3003, the overall measurement uncertainty was estimated.

FCC ID: PP4EZ2	 PCTEST <small>Engineering Laboratory</small>	HAC (RF EMISSIONS) TEST REPORT	 PANTECH & CURITEL	Reviewed by: Quality Manager
HAC Filename: 0705310542.PP4	Test Dates: June 6 - 8, 2007	EUT Type: Cellular/PCS CDMA Phone	Page 25 of 70	

13. TEST DATA

See following Attached Pages for Test Data.

FCC ID: PP4EZ2	 PCTEST wired	HAC (RF EMISSIONS) TEST REPORT		Reviewed by: Quality Manager
HAC Filename: 0705310542.PP4	Test Dates: June 6 - 8, 2007	EUT Type: Cellular/PCS CDMA Phone	Page 26 of 70	



PCTEST Hearing-Aid Compatibility Facility

DUT: CD835V3 - SN1082

Type: CD835V3
Serial: 1082

Communication System: CW; Frequency: 835 MHz;

Measurement Standard: DAS4 (High Precision Assessment)

DASY4 Configuration:

- Probe: ER3DV6 - SN2335; Calibrated: 7/10/2006
- Sensor-Surface: 0mm (Fix Surface)
- Electronics: DAE3 Sn455; Calibrated: 10/16/2006
- Phantom: HAC Test Arch with Coil; Type: SD HAC P01 BA;
- Measurement SW: DAS4, V4.7 Build 53;

835MHz, 100mW/20dBm/Hearing Aid Compatibility Test (41x361x1):

Measurement grid: dx=5mm, dy=5mm
Reference Value = 112.5 V/m; Power Drift = 0.088 dB
Average value of Total (interpolated) = 177.7 V/m

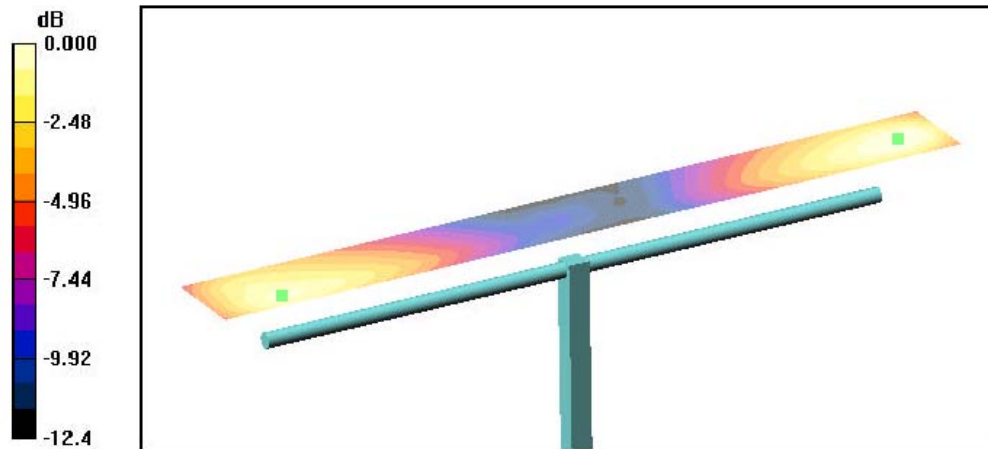

0 dB = 184.3V/m

© 2007 PCTEST

FCC ID: PP4EZ2	PCTEST wireless	HAC (RF EMISSIONS) TEST REPORT	PANTECH & CURITEL	Reviewed by: Quality Manager
HAC Filename: 0705310542.PP4	Test Dates: June 6 - 8, 2007	EUT Type: Cellular/PCS CDMA Phone		Page 27 of 70



PCTEST Hearing-Aid Compatibility Facility

DUT: CD1880V3 - SN1064

Type: CD1880V3
Serial: 1064

Communication System: CW; Frequency: 1880 MHz;

Measurement Standard: DASY4 (High Precision Assessment)

DASY4 Configuration:

- Probe: ER3DV6 - SN2335; Calibrated: 7/10/2006
- Sensor-Surface: 0mm (Fix Surface)
- Electronics: DAE3 Sn455; Calibrated: 10/16/2006
- Phantom: HAC Test Arch with Coil; Type: SD HAC P01 BA;
- Measurement SW: DASY4, V4.7 Build 53;

1880MHz, 100mW/20dBm/Hearing Aid Compatibility Test (41x181x1):

Measurement grid: dx=5mm, dy=5mm
Reference Value = 140.5 V/m; Power Drift = -0.002 dB
Average value of Total (interpolated) = 134.6 V/m

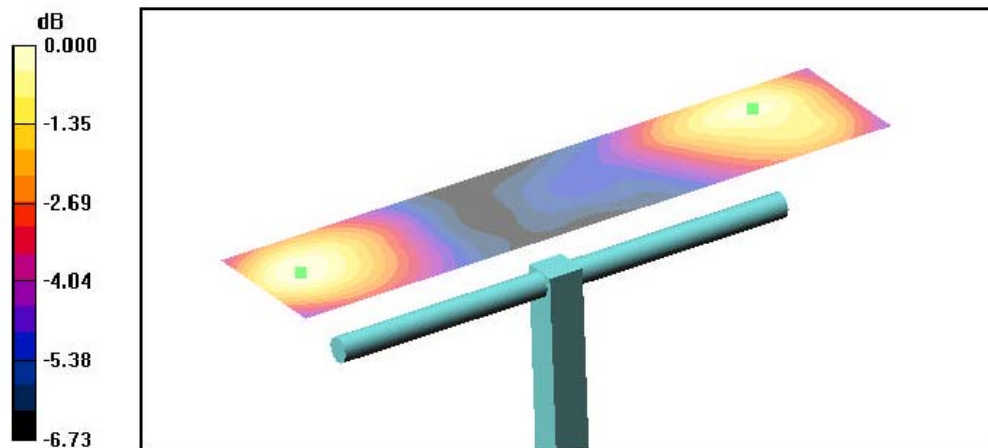

0 dB = 141.8V/m

© 2007 PCTEST

FCC ID: PP4EZ2	PCTEST	HAC (RF EMISSIONS) TEST REPORT	PANTECH & CURITEL	Reviewed by: Quality Manager
HAC Filename: 0705310542.PP4	Test Dates: June 6 - 8, 2007	EUT Type: Cellular/PCS CDMA Phone		Page 28 of 70



PCTEST Hearing-Aid Compatibility Facility

DUT: CD835V3 - SN1082

Type: CD835V3
Serial: 1082

Communication System: CW; Frequency: 835 MHz;

Measurement Standard: DAS4 (High Precision Assessment)

DASY4 Configuration:

- Probe: H3DV6 - SN6207; Calibrated: 7/10/2006
- Sensor-Surface: 0mm (Fix Surface)
- Electronics: DAE3 Sn455; Calibrated: 10/16/2006
- Phantom: HAC Test Arch with Coil; Type: SD HAC P01 BA;
- Measurement SW: DASY4, V4.7 Build 53;

835MHz, 100mW/20dBm/Hearing Aid Compatibility Test (41x361x1):

Measurement grid: dx=5mm, dy=5mm
Reference Value = 0.507 A/m; Power Drift = -0.097 dB
Maximum value of Total (interpolated) = 0.463 A/m

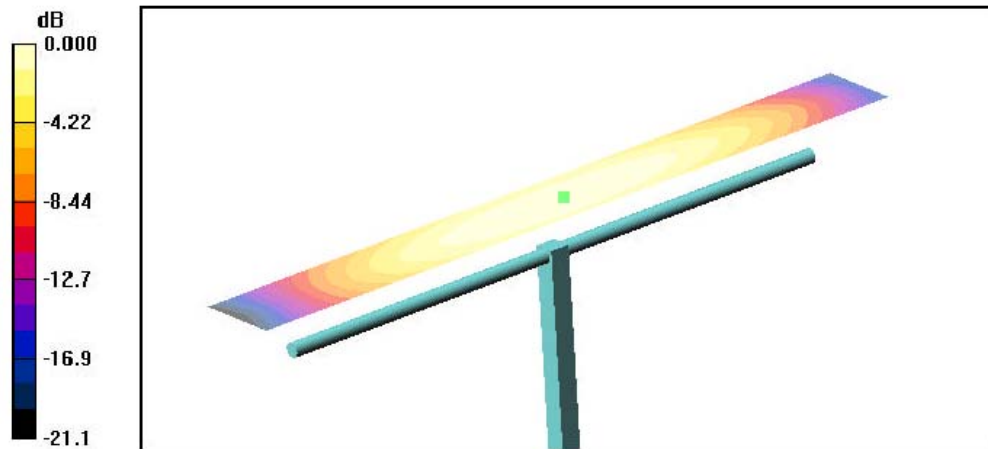

0 dB = 0.463A/m

© 2007 PCTEST

FCC ID: PP4EZ2	PCTEST	HAC (RF EMISSIONS) TEST REPORT	PANTECH & CURITEL	Reviewed by: Quality Manager
HAC Filename: 0705310542.PP4	Test Dates: June 6 - 8, 2007	EUT Type: Cellular/PCS CDMA Phone		Page 29 of 70



PCTEST Hearing-Aid Compatibility Facility

DUT: CD1880V3 - SN1064

Type: CD1880V3
Serial: 1064

Communication System: CW; Frequency: 1880 MHz;

Measurement Standard: DASY4 (High Precision Assessment)

DASY4 Configuration:

- Probe: H3DV6 - SN6207; Calibrated: 7/10/2006
- Sensor-Surface: 0mm (Fix Surface)
- Electronics: DAE3 Sn455; Calibrated: 10/16/2006
- Phantom: HAC Test Arch with Coil; Type: SD HAC P01 BA;
- Measurement SW: DASY4, V4.7 Build 53;

1880MHz, 100mW/20dBm/Hearing Aid Compatibility Test (41x181x1):

Measurement grid: dx=5mm, dy=5mm
Reference Value = 0.411 A/m; Power Drift = -0.020 dB
Maximum value of Total (interpolated) = 0.408 A/m

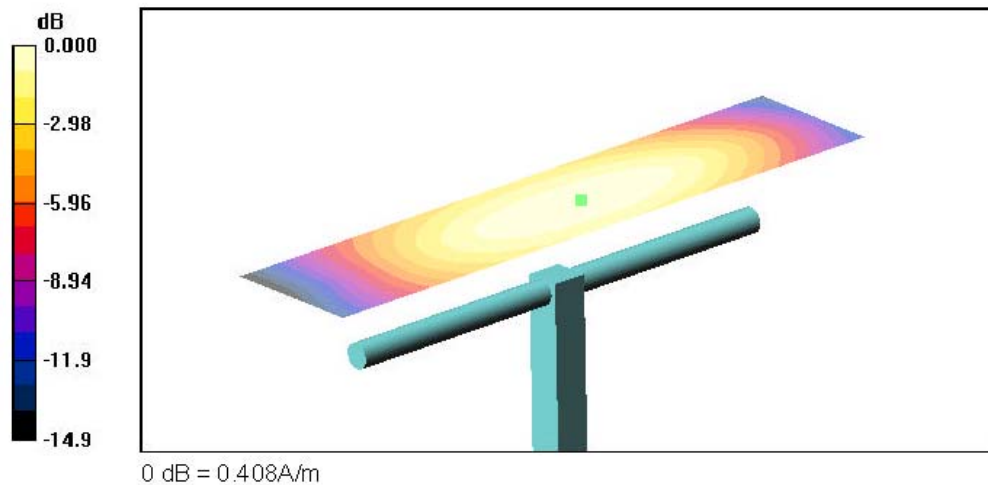

© 2007 PCTEST

FCC ID: PP4EZ2	PCTEST wireless	HAC (RF EMISSIONS) TEST REPORT	PANTECH & CURITEL	Reviewed by: Quality Manager
HAC Filename: 0705310542.PP4	Test Dates: June 6 - 8, 2007	EUT Type: Cellular/PCS CDMA Phone		Page 30 of 70



PCTEST Hearing-Aid Compatibility Facility

DUT: EZ2

Type: Cellular/PCS CDMA Phone
 Serial: #1
 Backlight on
 Duty Cycle: 1:1

Communication System: PCS CDMA; Frequency: 1880 MHz;

Measurement Standard: DAS4 (High Precision Assessment)

DASY4 Configuration:

- Probe: ER3DV6 - SN2353; Calibrated: 10/13/2006
- Sensor-Surface: (Fix Surface)
- Electronics: DAE3 Sn455; Calibrated: 10/16/2006
- Phantom: HAC Test Arch with Coil; Type: SD HAC P01 BA;
- Measurement SW: DASY4, V4.7 Build 53;

Mid.ch/Hearing Aid Compatibility Test (251x251x1):

Measurement grid: dx=2mm, dy=2mm
 Maximum value of peak Total field = 25.4 V/m
 Probe Modulation Factor = 0.968
 Reference Value = 16.2 V/m; Power Drift = -0.205 dB
Hearing Aid Near-Field Category: M4 (AWF 0 dB)

Peak E-field in V/m

Grid 1	Grid 2	Grid 3
11.1	12.9	13.0
Grid 4	Grid 5	Grid 6
17.8	18.8	18.8
Grid 7	Grid 8	Grid 9
25.4	25.4	20.7

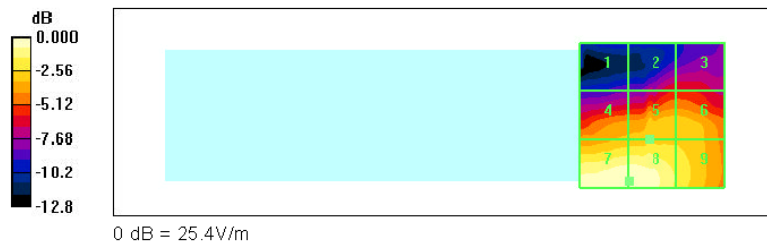

© 2007 PCTEST

Note: Under ANSI C63.19-2006 limits, this configuration has a Hearing Aid Near-Field Category of M4.

FCC ID: PP4EZ2	PCTEST	HAC (RF EMISSIONS) TEST REPORT	PANTECH & CURITEL	Reviewed by: Quality Manager
HAC Filename: 0705310542.PP4	Test Dates: June 6 - 8, 2007	EUT Type: Cellular/PCS CDMA Phone	Page 31 of 70	



PCTEST Hearing-Aid Compatibility Facility

DUT: EZ2

Type: Cellular/PCS CDMA Phone
 Serial: #1
 Backlight on
 Duty Cycle: 1:1

Communication System: PCS CDMA; Frequency: 848.31 MHz;

Measurement Standard: DASY4 (High Precision Assessment)

DASY4 Configuration:

- Probe: ER3DV6 - SN2353; Calibrated: 10/13/2006
- Sensor-Surface: (Fix Surface)
- Electronics: DAE3 Sn455; Calibrated: 10/16/2006
- Phantom: HAC Test Arch with Coil; Type: SD HAC P01 BA;
- Measurement SW: DASY4, V4.7 Build 53;

High.ch CDMA/Hearing Aid Compatibility Test (251x251x1):

Measurement grid: dx=2mm, dy=2mm
 Maximum value of peak Total field = 59.4 V/m
 Probe Modulation Factor = 0.939
 Reference Value = 57.7 V/m; Power Drift = 0.173 dB
Hearing Aid Near-Field Category: M4 (AWF 0 dB)

Peak E-field in V/m

Grid 1	Grid 2	Grid 3
43.6	54.3	52.6
Grid 4	Grid 5	Grid 6
47.2	59.4	58.9
Grid 7	Grid 8	Grid 9
51.7	59.2	58.0

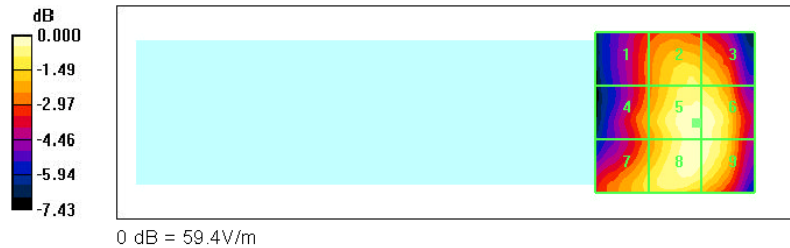

© 2007 PCTEST

FCC ID: PP4EZ2	PCTEST	HAC (RF EMISSIONS) TEST REPORT	PANTECH & CURITEL	Reviewed by: Quality Manager
HAC Filename: 0705310542.PP4	Test Dates: June 6 - 8, 2007	EUT Type: Cellular/PCS CDMA Phone		Page 32 of 70



PCTEST Hearing-Aid Compatibility Facility

DUT: EZ2

Type: Cellular/PCS CDMA Phone
 Serial: #1
 Backlight on
 Duty Cycle: 1:1

Communication System: PCS CDMA; Frequency: 848.31 MHz;

Measurement Standard: DASY4 (High Precision Assessment)

DASY4 Configuration:

- Probe: H3DV6 - SN6207; Calibrated: 7/10/2006
- Sensor-Surface: (Fix Surface)
- Electronics: DAE3 Sn455; Calibrated: 10/16/2006
- Phantom: HAC Test Arch with Coil; Type: SD HAC P01 BA;
- Measurement SW: DASY4, V4.7 Build 53;

High.ch cdma/Hearing Aid Compatibility Test (251x251x1):

Measurement grid: dx=2mm, dy=2mm
 Maximum value of peak Total field = 0.085 A/m
 Probe Modulation Factor = 0.791
 Reference Value = 0.065 A/m; Power Drift = 0.165 dB
Hearing Aid Near-Field Category: M4 (AWF 0 dB)

Peak H-field in A/m

Grid 1	Grid 2	Grid 3
0.081	0.062	0.040
Grid 4	Grid 5	Grid 6
0.079	0.063	0.043
Grid 7	Grid 8	Grid 9
0.085	0.065	0.043

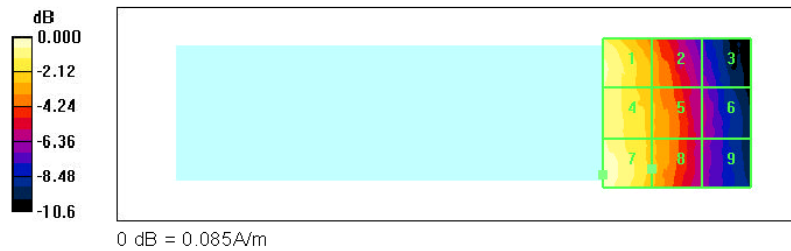

© 2007 PCTEST

FCC ID: PP4EZ2	PCTEST	HAC (RF EMISSIONS) TEST REPORT	PANTECH & CURITEL	Reviewed by: Quality Manager
HAC Filename: 0705310542.PP4	Test Dates: June 6 - 8, 2007	EUT Type: Cellular/PCS CDMA Phone	Page 33 of 70	



PCTEST Hearing-Aid Compatibility Facility

DUT: EZ2

Type: Cellular/PCS CDMA Phone
 Serial: #1
 Backlight on
 Duty Cycle: 1:1

Communication System: PCS CDMA; Frequency: 1908.75 MHz;

Measurement Standard: DASYS4 (High Precision Assessment)

DASY4 Configuration:

- Probe: H3DV6 - SN6207; Calibrated: 7/10/2006
- Sensor-Surface: (Fix Surface)
- Electronics: DAE3 Sn455; Calibrated: 10/16/2006
- Phantom: HAC Test Arch with Coil; Type: SD HAC P01 BA;
- Measurement SW: DASYS4, V4.7 Build 53;

High.ch/Hearing Aid Compatibility Test (251x251x1):

Measurement grid: dx=2mm, dy=2mm
 Maximum value of peak Total field = 0.043 A/m
 Probe Modulation Factor = 0.671
 Reference Value = 0.033 A/m; Power Drift = -0.25 dB
Hearing Aid Near-Field Category: M4 (AWF 0 dB)

Peak H-field in A/m

Grid 1	Grid 2	Grid 3
0.025	0.022	0.023
Grid 4	Grid 5	Grid 6
0.028	0.026	0.023
Grid 7	Grid 8	Grid 9
0.043	0.031	0.023

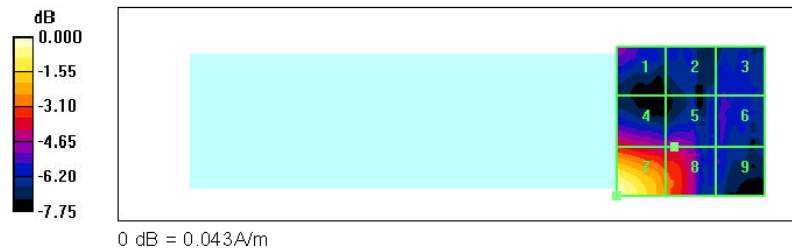

© 2007 PCTEST

FCC ID: PP4EZ2	PCTEST	HAC (RF EMISSIONS) TEST REPORT	PANTECH & CURITEL	Reviewed by: Quality Manager
HAC Filename: 0705310542.PP4	Test Dates: June 6 - 8, 2007	EUT Type: Cellular/PCS CDMA Phone	Page 34 of 70	