

HCT CO., LTD.



SAN 136-1, AMI-RI, BUBAL-EUP, ICHEON-SI, KYOUNGKI-DO, 467-701, KOREA

TEL: +82 31 639 8565 FAX: +82 31 639 8525 www.hct.co.kr

HAC RF Emission TEST REPORT

PANTECH&CURITEL COMMUNICATIONS, INC.

110-1, ONGJEONG-RI, TONGJIN-EUP, GIMPO-SI,
GYOUNGGI-DO, 415-865, KOREA

Date of Issue: Mar. 23, 2009

Test Report No.: HCT-IA0903 -1102-02

Test Site: HCT CO., LTD.

FCC ID: PP4ELVISPLUS

APPLICANT: PANTECH&CURITEL COMMUNICATIONS, INC.

EUT Type:	Tri-Band CDMA/PCS/AWS Phone with Bluetooth
Tx Frequency:	824.70 – 848.31 MHz (CDMA) 1 711.25 – 1 753.75 MHz (AWS CDMA) 1 851.25 – 1 908.75 MHz (PCS CDMA)
Maximum Conducted Power (HAC):	0.316 W CDMA (25.0 dBm) 0.316 W PCS CDMA (25.0 dBm) 0.316 W AWS CDMA (25.0 dBm)
Trade Name/Model(s):	PANTECH&CURITEL / TXT8026
FCC Classification:	Licensed Portable Transmitter Held to Ear (PCE)
FCC Rule Part(s):	§20.19
HAC Standard:	ANSI C63.19-2006 V3.12

Hearing Aid Near-Field Category: M4

This wireless portable device has been shown to be hearing-aid compatible under the above rated category, specified in ANSI/IEEE Std. C63.19-2006 and had been tested in accordance with the specified measurement procedures. Hearing-Aid Compatibility is based on the assumption that all production units will be designed electrically identical to the device tested in this report.

I attest to the accuracy of data. All measurements reported herein were performed by me or were made under my supervision and are correct to the best of my knowledge and belief. I assume full responsibility for the completeness of these measurements and vouch for the qualifications of all persons taking them.

HCT Co., Ltd. Certifies that no party to this application has been denied FCC benefits pursuant to section 5301 of the Anti- Drug Abuse Act of 1998, 21 U.S. C. 862.

Report prepared by

: Sun-Hee Kim

Test Engineer of SAR Part

Approved by

: Jae-Sang So

Manager of SAR Part

Table of Contents

1. APPLICANT / EUT DESCRIPTION -----	3
2. HAC MEASUREMENT SET- UP -----	4
3. SYSTEM SPECIFICATIONS -----	5
4. EUT ARRANGEMENT -----	7
5. SYSTEM VALIDATION -----	8
6. PROBE MODULATION FACTOR -----	10
7. FCC 3G MEASUREMENTS – MAY / JUNE 2006 -----	13
8. TEST PROCEDURE -----	14
9. ANSI/IEEE C63.19 PERFORMANCE CATEGORIES -----	16
10. MEASUREMENT UNCERTAINTIES -----	17
11. HAC TEST DATA SUMMARY -----	19
12. HAC TEST EQUIPMENT LIST -----	24
13. CONCLUSION -----	25

Appendix A_HAC TEST PLOTS

Appendix B_TEST SET-UP PHOTO

Appendix C_DIPOLE VALIDATION PLOTS

Appendix D_PROBE CALIBRATION DATA

Appendix E_DIPOLE CALIBRATION DATA

HAC MEASUREMENT REPORT

1. APPLICANT / EUT DESCRIPTION

1.1 Applicant

• Company Name:	PANTECH&CURITEL COMMUNICATIONS, INC.
• Address:	ONGJEONG-RI, TONGJIN-EUP, GIMPO-SI, GYOUNGGI-DO, 415-865, KOREA
• Attention:	Ki Yeoul, LEE
• Tel. / Fax :	+82-31-999-8801 / +82-31-984-9771
• E-Mail :	leekiyeoul@pantech.com

1.2 EUT Description

• EUT Type:	Tri-Band CDMA/PCS/AWS Phone with Bluetooth
• Trade Name:	PANTECH&CURITEL
• Model(s):	TXT8026
• FCC ID:	PP4ELVISPLUS
• Serial Number(s):	#1
• Tx Frequency:	824.70 – 848.31 MHz (CDMA) 1 711.25 – 1 753.75 MHz (AWS CDMA) 1 851.25 – 1 908.75 MHz (PCS CDMA)
• FCC Classification:	Licensed Portable Transmitter Held to Ear (PCE)
• FCC Rule Part(s):	§ 20.19(b); §6.3(v), §7.3(v)
• Modulation(s):	CDMA835/AWS1700/PCS1900
• Antenna Type:	Intenna
• Date(s) of Tests:	Mar. 21, 2009
• Place of Tests:	HCT CO., LTD. Icheon, Kyoung ki-Do, KOREA
• Report Serial No.:	HCT-IA0903-1102-02
• Max E-Field Emission:	channel 25, 1 711.25 MHz = 34.7 dBV/m (M4)
• Max H-Field Emission:	channel 25, 1 711.25 MHz = - 21.1 dBA/m (M4)

2. HAC MEASUREMENT SET-UP

These measurements are performed using the DASY4 automated dosimetric assessment system. It is made by Schmid & Partner Engineering AG (SPEAG) in Zurich, Switzerland. It consists of high precision robotics system (Staubli), robot controller, Pentium IV computer, near-field probe, probe alignment sensor. The robot is a six-axis industrial robot performing precise movements.

A cell controller system contains the power supply, robot controller, teach pendant (Joystick), and remote control, is used to drive the robot motors. The PC consists of the HP Pentium IV 3.0 GHz computer with Windows XP system and HAC Measurement Software DASY4, A/D interface card, monitor, mouse, and keyboard. The Staubli Robot is connected to the cell controller to allow software manipulation of the robot. A data acquisition electronic (DAE) circuit performs the signal amplification, signal multiplexing, AD-conversion, offset measurements, mechanical surface detection, collision detection, etc. is connected to the Electro-optical coupler (EOC). The EOC performs the conversion from the optical into digital electric signal of the DAE and transfers data to the PC plug-in card.

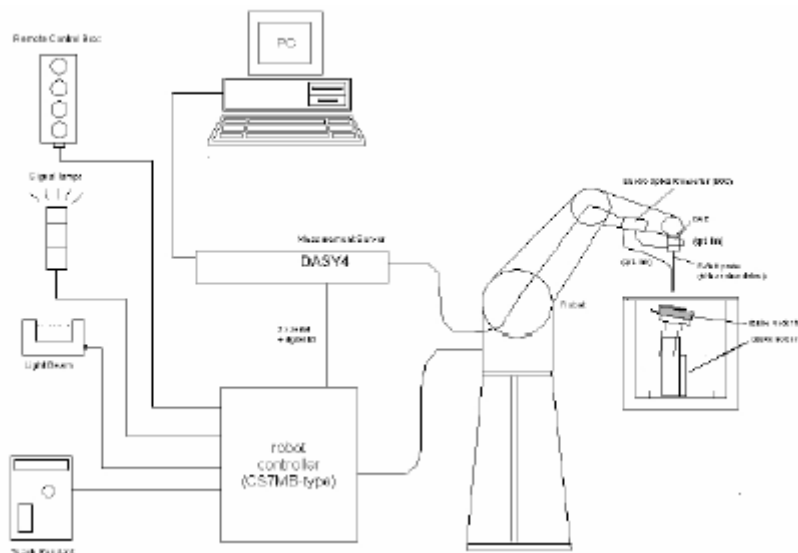



Figure 1. HAC Test Measurement Set-up

The DAE4 consists of a highly sensitive electrometer-grade preamplifier with auto-zeroing, a channel and gain-switching multiplexer, a fast 16 bit AD-converter and a command decoder and control logic unit. Transmission to the PC-card is accomplished through an optical downlink for data and status information and an optical uplink for commands and clock lines. The mechanical probe mounting device includes two different sensor systems for frontal and sidewise probe contacts. They are also used for mechanical surface detection and probe collision detection. The robot uses its own controller with a built in VME-bus computer.

3. SYSTEM SPECIFICATIONS

3.1 Probe

3.1.1 E-Field Probe Description

Construction	One dipole parallel, two dipoles normal to probe axis Built-in shielding against static charges	 <p>[E-Field Probe]</p>
Calibration	In air from 100 MHz to 3.0 GHz (absolute accuracy $\pm 6.0\%$, $k = 2$)	
Frequency	100 MHz to > 6 GHz; Linearity: ± 0.2 dB (100 MHz to 3 GHz)	
Directivity	± 0.2 dB in air (rotation around probe axis) ± 0.4 dB in air (rotation normal to probe axis)	
Dynamic Range	2 V/m to > 1000 V/m (M3 or better device readings fall well below diode compression point)	
Linearity	± 0.2 dB	
Dimensions	Overall length: 330 mm (Tip: 16 mm) Tip diameter: 8 mm (Body: 12 mm) Distance from probe tip to dipole centers: 2.5 mm	

3.1.2 H-Field Probe Description

Construction	Three concentric loop sensors with 3.8 mm loop diameters resistively loaded detector diodes for linear response Built-in shielding against static charges PEEK enclosure material (resistant to organic solvents, e.g., glycoether)	 <p>[H-Field Probe]</p>
Frequency	200 MHz to > 3 GHz (absolute accuracy $\pm 6.0\%$, $k = 2$); Output linearized	
Directivity	± 0.25 dB (spherical isotropy error)	
Dynamic Range	10 mA/m to 2 A/m at 1 GHz	
E-Field Interference	< 10 % at 3 GHz (for plane wave)	
Dimensions	Overall length: 330 mm (Tip: 40 mm) Tip diameter: 6 mm (Body: 12 mm) Distance from probe tip to dipole centers: 3 mm The closest part of the sensor element is 1.9 mm closer to the tip	

3.2 Phantom & Device Holder

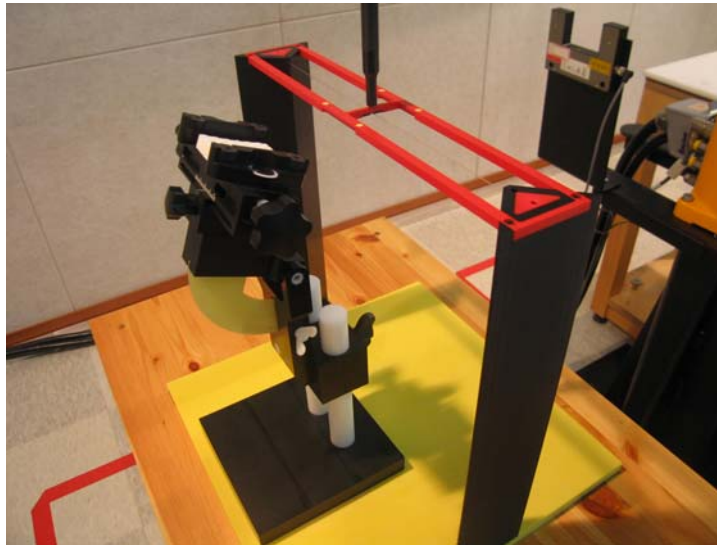

Figure 2. HAC Phantom & Device Holder

The Test Arch phantom should be positioned horizontally on a stable surface. Reference markings on the Phantom allow the complete setup of all predefined phantom positions and measurement grids by manually teaching three points in the robot.

The devices can be easily, accurately, and repeatably positioned according to the FCC specifications.

3.3 Robotic System Specifications

Specifications	
POSITIONER:	Stäubli Unimation Corp. Robot Model: RX90LB
Repeatability:	0.02 mm
No. of axis:	6
Data Acquisition Electronic (DAE) System	
Cell Controller	
Processor:	Pentium IV
Clock Speed:	3.0 GHz
Operating System:	Windows XP
Data Card:	DASY4 PC-Board
Data Converter	
Features:	Signal Amplifier, multiplexer, A/D converter, and control logic
Software:	DASY4 software
Connecting Lines:	Optical downlink for data and status info. Optical uplink for commands and clock
PC Interface Card	
Function:	24 bit (64 MHz) DSP for real time processing Link to DAE3 16 bit A/D converter for surface detection system serial link to robot direct emergency stop output for robot

4. EUT ARRANGEMENT

4.1 WD RF Emission Measurements Reference and Plane

Figure 3. Illustrate the references and reference plane that shall be used in the WD emissions measurement.

- The grid is 5 cm by 5 cm area that is divided into 9 evenly sized blocks or sub-grids.
- The grid is centered on the audio frequency output transducer of the WD (speaker or T-coil).
- The grid is in a reference plane, which is defined as the planar area that contains the highest point in the area of the phone that normally rests against the user's ear. It is parallel to the centerline of the receiver area of the phone and is defined by the points of the receiver-end of the WD handset, which, in normal handset use, rest against the ear.
- The measurement plane is parallel to, and 1.5 cm in front of, the reference plane.



Figure 3. WD reference and plane for RF emission measurements

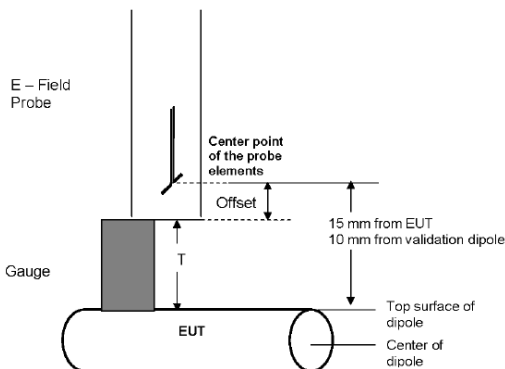

Figure 4. Gauge Block with E-Field Probe

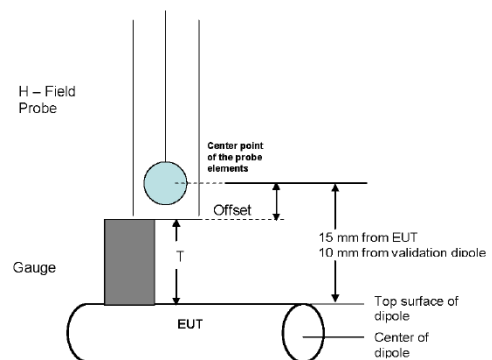

Figure 5. Gauge Block with H-Field Probe

5. SYSTEM VALIDATION

The test setup was validated when configured and verified periodically thereafter to ensure proper function. The procedure is a validation procedure using dipole antennas for which the field levels were computed by FDTD modeling.

5.1 Validation Procedure

Place a dipole antenna meeting the requirements given in ANSI-C63.19 in the position normally occupied by the WD. The dipole antenna serves as a known source for an electrical and magnetic output. Position the E-field and H-field probes so that:

- the probes and their cables are parallel to the coaxial feed of the dipole antenna
- the probe cables and the coaxial feed of the dipole antenna approach the measurement area from opposite directions; and
- the probes are 10 mm from the surface of the dipole elements.

Scan the length of the dipole with both E-field and H-field probes and record the maximum values for each. Compare the readings to expected values.

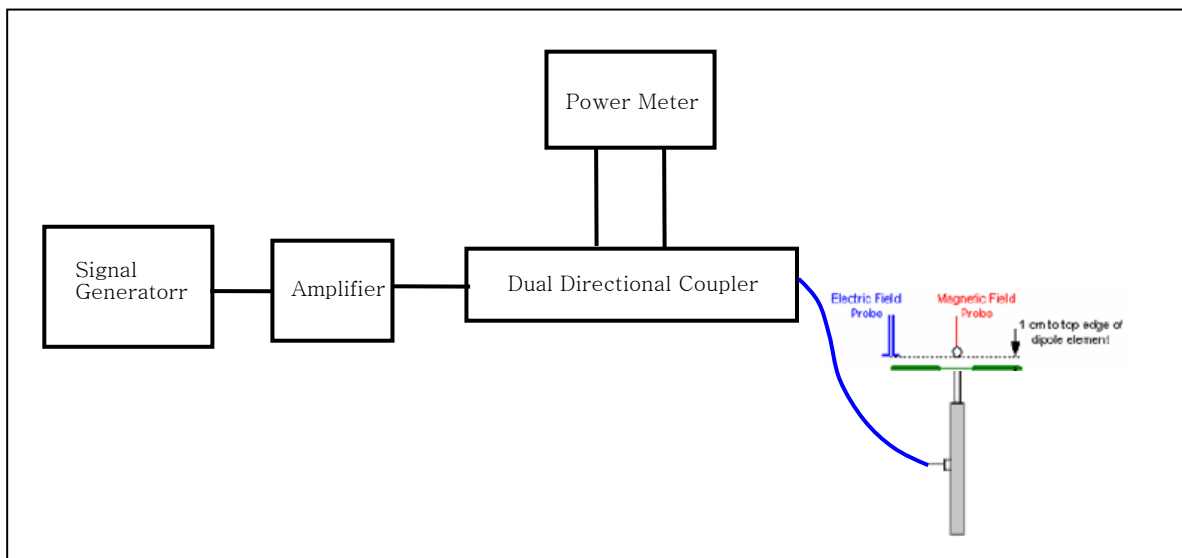

Figure 6. Dipole Validation SET-UP

5.2 Validation Result

5.2.1 E-Field Scan

Mode	Freq. [MHz]	Input Power [dBm]	Measured Value [V/m]	Target Value [V/m] SPEAG	Deviation [%]	Limit [%]
CW	835	20	163.3	159	+ 2.70	± 25
CW	1 880	20	140.5	140.25	+ 0.18	± 25

5.2.2 H-Field Scan

Mode	Freq. [MHz]	Input Power [dBm]	Measured Value [A/m]	Target Value [A/m] SPEAG	Deviation [%]	Limit [%]
CW	835	20	0.445	0.445	0.00	± 25
CW	1 880	20	0.473	0.469	+ 0.85	± 25

Notes:

- 1) Deviation (%) = 100 * (Measured value minus Target value) divided by Target value.
ANSI-C63.19 requires values to be within 25 % of their targets. 12 % is deviation and 13 % is measurement uncertainty.
- 2) The maximum E-field or H-field were evaluated and compared to the target values provided by SPEAG in the calibration certificate of specific dipoles.
- 3) Please refer to the attachment for detailed measurement data and plot.

6. Probe Modulation Factor

A calibration was made of the modulation response of the probe and its instrumentation chain. This calibration was performed with the field probe, attached to its instrumentation. The response of the probe system to a CW field at the frequency of interest is compared to its response to a modulated signal with equal peak amplitude to that of a CW signal. The field level of the test signals are ensured to be more than 10 dB above the ambient level and the noise floor of the instrumentation being used. The ratio of the CW reading to that taken with a modulated reading was applied to the DUT measurements.

All voice modes for this device have been investigated in this section of the report. According to the FCC 3G Measurement Procedures, May 2006 for RF Emissions, variations in peak field and power readings.

This was done using the following procedure:

1. The probe was illuminated with a CW signal at the intended measurement frequency and wireless device power.
2. The probe was positioned at the field maxima over the dipole antenna (determined after an area scan over the dipole) illuminated with the CW signal.
3. The reading of the probe measurement system of the CW signal at the maximum point was recorded.
4. Using a Spectrum Analyzer, the modulated signal adjusted with the same peak level of the CW signal was determined.
5. The probe measurement system reading was recorded with the modulated signal. The appropriate system crest factors for the modulation type were configured in the software to the system measurements.
6. The ratio of the CW reading to modulated signal reading is the probe modulation factor (PMF) for the modulation and field probe combination. This was repeated for 80 % AM.
7. Steps 1-6 were repeated at all frequency bands and for both E and H field probes.

The modulation factors obtained were applied to readings taken of the actual wireless device, in order to obtain an accurate peak field reading using the formula:

$$\text{Peak} = 20 \cdot \log (\text{Raw} \cdot \text{PMF})$$

This method correlates well with the modulation using the DUT in the alternative substitution method. See below for correlation of signal:

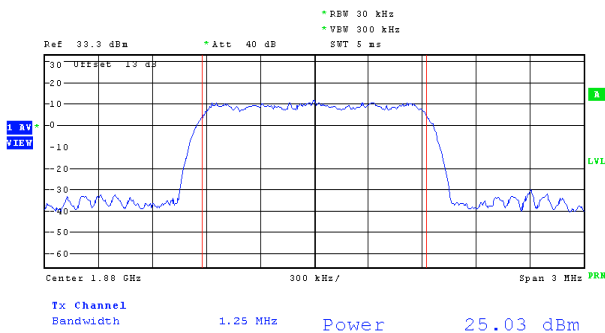

Figure. 7

Signal Generator Modulated Signal

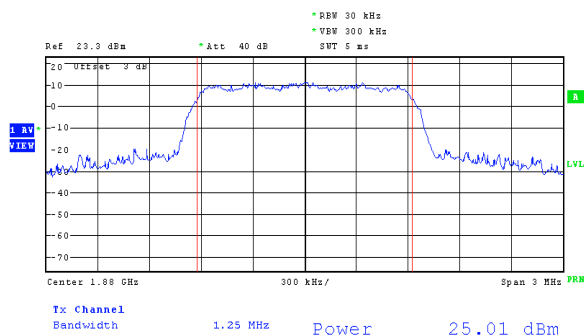

Figure. 8

Wireless Device Modulated Signal

6.2 Modulation Factor

6.2.1 E-Field

Mode	Freq. [MHz]	Input Power [dB]	E-Field measured value [V/m]	Probe Modulation Factor
CW	835	25	287.1	-
80 % AM		25	176	1.631
CDMA (Full Rate)		25	305.1	0.941
CDMA (1/8 Rate)		25	90.53	3.171
CW	1 880	25	243.1	-
80 % AM		25	150.1	1.620
CDMA (Full Rate)		25	251.7	0.966
CDMA (1/8 Rate)		25	78.87	3.082

6.2.2 H-Field

Mode	Freq. [MHz]	Input Power [dB]	H-Field measured value [A/m]	Probe Modulation Factor
CW	835	25	0.847	-
80 % AM		25	0.531	1.595
CDMA (Full Rate)		25	0.996	0.850
CDMA (1/8 Rate)		25	0.293	2.891
CW	1 880	25	0.765	-
80 % AM		25	0.489	1.564
CDMA (Full Rate)		25	1.176	0.651
CDMA (1/8 Rate)		25	0.275	2.782

Notes:

- 1) Modulation Factor = CW / WD_CDMA

6.2.3 PMF Peak Power Measurement Plots

■ Probe Modulation Factor (CW)

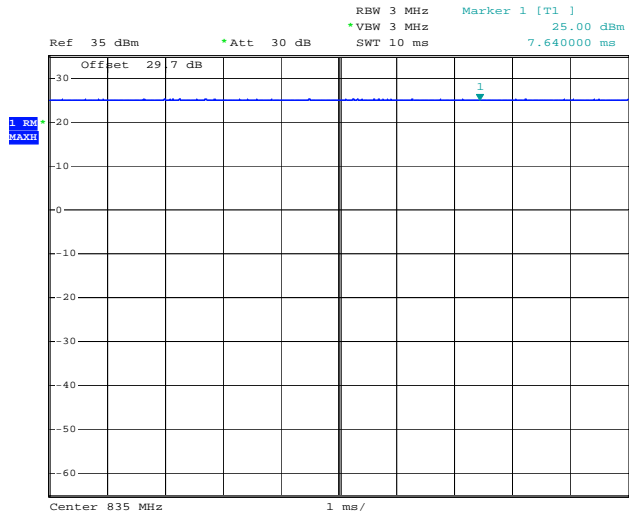

Date: 3.JUL.2007 14:06:31

■ Probe Modulation Factor (AM 80 %)

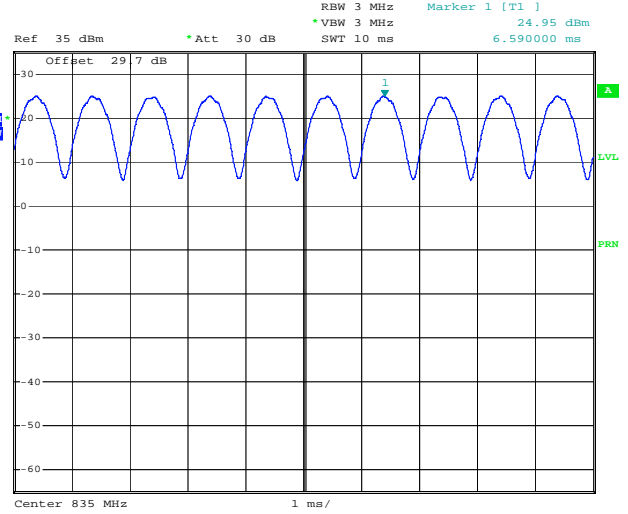

Date: 3.JUL.2007 14:07:23

■ Probe Modulation Factor (CDMA: full rate)

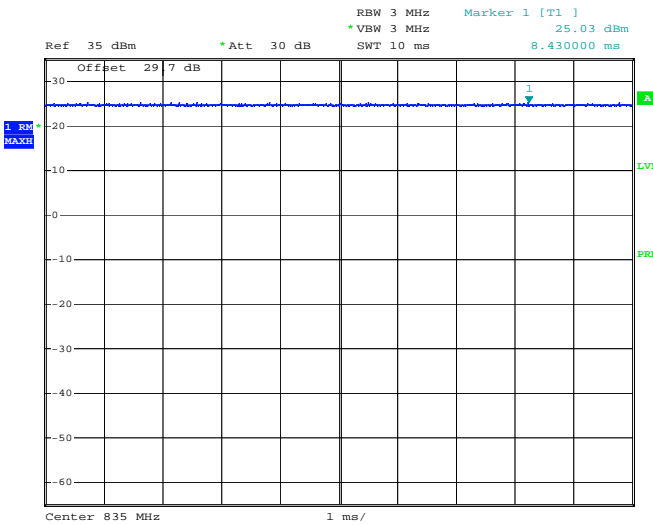

Date: 3.JUL.2007 14:10:56

■ Probe Modulation Factor (CDMA: 1/8 rate)

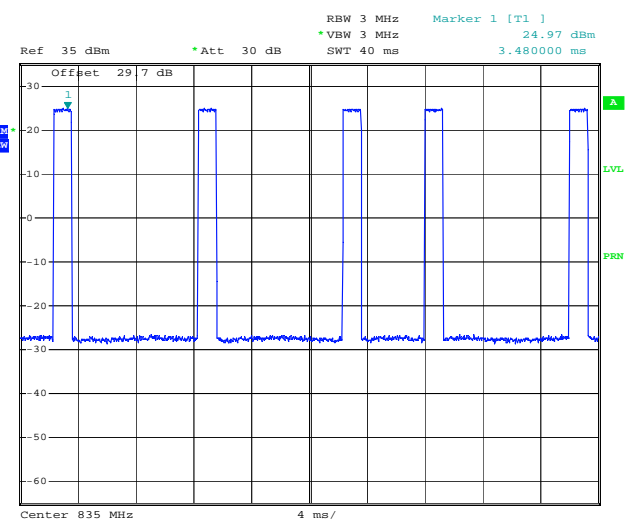

Date: 3.JUL.2007 14:15:45

Spectrum Analyzer Settings

- Input Power: 25.0 dBm
- RBW: 3 MHz
- Video Bandwidth: 3 MHz
- Span: Zero
- Sweep Time: 10 ms
- Detection: Peak detection (RMS)

7. FCC 3G MEASUREMENTS – MAY / JUNE 2006

Sample pre-testing of the various modes were performed at the worst case probe location as part of subset testing justification. See below for measured conducted power for applicable device modes:

7.1 Handset Measured Conducted Powers

Average Output Power Measurement for FCC ID: PP4ELVISPLUS

Band	Channel	SO2	SO2	SO55	SO55	TDSO
		RC1/1	RC3/3	RC1/1	RC3/3	SO32 RC3/3
CDMA	1013	24.98	24.99	24.97	24.97	25.07
	384	24.78	24.78	24.83	24.81	24.84
	777	24.85	24.90	24.78	24.89	24.91
PCS	25	24.97	24.93	24.95	24.92	24.97
	600	24.89	24.85	24.84	24.86	24.92
	1175	24.78	24.78	24.79	24.80	24.81
AWS	25	24.70	24.73	24.67	24.76	24.78
	450	24.81	24.93	24.84	24.95	24.99
	875	24.71	24.76	24.72	24.77	24.79

7.2 Worst-Case Probe Location Measurements

Below are RC/SO mode investigation results of the device at the worst-case (maximum) field point location.

The worst-case RC/SO was used for HAC testing.

Mode	Channel	Backlight	RC/SO	Battery	Antenna	Conducted Power [dBm]	Time Avg. Field [V/m]	Peak Field [dBV/m]	FCC Limit [dBV/m]	FCC MARGIN [dB]	RESULT
AWS	25	off	SO55/RC3	Standard	Intenna	24.86	54.70	34.5	41	- 6.54	M4
AWS	25	on	SO55/RC1	Standard	Intenna	24.84	54.97	34.5	41	- 6.50	M4
AWS	25	off	SO2/RC1	Standard	Intenna	24.89	55.09	34.5	41	- 6.48	M4
AWS	25	off	SO3/RC1	Standard	Intenna	24.87	19.21	35.4	41	- 5.55	M4
AWS	25	off	SO55/RC1	Standard	Intenna	24.84	55.36	34.6	41	- 6.44	M4
AWS	25	off	SO9/RC2	Standard	Intenna	24.85	55.05	34.5	41	- 6.49	M4
AWS	25	off	SO2/RC3	Standard	Intenna	24.85	55.18	34.5	41	- 6.46	M4
AWS	25	off	SO3/RC3	Standard	Intenna	24.89	55.24	34.5	41	- 6.46	M4

8. TEST PROCEDURE

Test Instructions

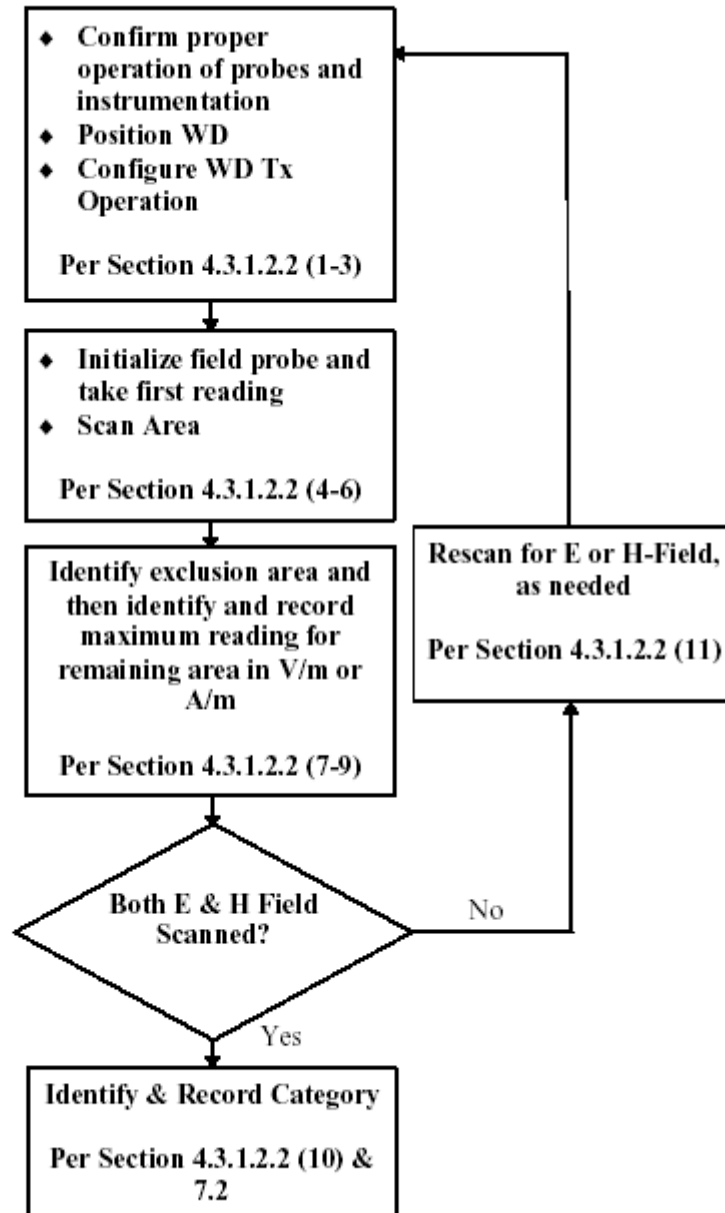

Figure 9. WD near-field emission automated test flowchart

The evaluation was performed with the following procedure:

1. Confirm proper operation of the field probe, probe measurement system and other instrumentation and the positioning system.
2. Position the WD in its intended test position. The measurement should be performed at a distance 1cm from the probe elements so the gauge block can simplify this positioning.
3. Configure the WD normal operation for maximum rated RF output power, at the desired channel and other operating parameters, as intended for the test.
4. The center sub-grid shall be centered on the center of the WD output (acoustic or T-Coil output), as appropriate.
5. A Surface calibration was performed before each setup change to ensure repeatable spacing and proper maintenance of the measurement plane using the HAC Phantom.
6. Locate the field probe at reference location and measure the field strength.
7. Scan the entire 5 cm by 5 cm region at 5 mm increments and record the reading at each measurement point.
8. Identify the maximum field reading within the non-excluded sub-grids identified in Step 7.
9. Move the probe to the location of maximum scan measurement and then 360° rotating the probe to align it for the maximum reading at that position.
10. Locate the field probe at the reference location and measure the field strength for drift evaluation. If conducted power deviations of more than 5 % occurred, the tests were repeated.
11. Convert the maximum field strength reading identified in Step 8 to V/m or A/m, as appropriate. For probes which require a probe modulation factor, this conversion shall be done using the appropriate probe modulation.
12. Repeat Step 1 through Step 11 for both the E and H field measurements.

9. ANSI/IEEE C63.19 PERFORMANCE CATEGORIES

The EUT must meet the following M3 or M4 category:

Category	Telephone RF Parameters		
Near Field	AWF [dB]	E-Field Emissions dB [V/m]	H-Field Emissions dB [A/m]
Frequency < 960 MHz			
M1	0	56 to 61	+ 5.6 to + 10.6
	-5	53.5 to 58.5	+ 3.1 to + 8.1
M2	0	51 to 56	+ 0.6 to + 5.6
	-5	48.5 to 53.5	- 1.9 to + 3.1
M3	0	46 to 51	- 4.4 to + 0.6
	-5	43.5 to 48.5	- 6.9 to - 1.9
M4	0	< 46	< - 4.4
	-5	< 43.5	< - 6.9
Frequency > 960 MHz			
M1	0	46 to 51	- 4.4 to 0.6
	-5	43.5 to 48.5	- 6.9 to -1.9
M2	0	41 to 46	- 9.4 to - 4.4
	-5	38.5 to 43.5	-11.9 to - 6.9
M3	0	36 to 41	- 14.4 to - 9.4
	-5	33.5 to 38.5	- 16.9 to -11.9
M4	0	< 36	< - 14.4
	-5	< 33.5	< - 16.9

Table 1. Telephone near-field categories in linear units

10. MEASUREMENT UNCERTAINTIES

10.1 E-Field

HAC (E-Field) Uncertainty Budget [According to ANSI C63.19]										Note/ Comment
Error Description	Uncertainty [%]	Probability Distribution	Divisor	ci [E]	Standard Uncertainty [E]	Stand Uncert*2	(Stand Uncert*2) X (ci*2)	Vi & Veff		
Measurement system										
1	Probe Calibration	5.1 %	Normal	1.00	1	5.1 %	26.01	26.01	∞	
2	Axial Isotropy	4.7 %	Rectangular	1.73	1	2.7 %	7.36	7.36	∞	
3	Sensor Displacement	16.5 %	Rectangular	1.73	1	9.5 %	90.75	90.75	∞	
4	Boundary effect	2.4 %	Rectangular	1.73	1	1.4 %	1.92	1.92	∞	
5	Linearity	4.7 %	Rectangular	1.73	1	2.7 %	7.36	7.36	∞	
6	Scaling to peak Envelope Power	2.0 %	Rectangular	1.73	1	1.2 %	1.33	1.33	∞	
7	System Detection limits	1.0 %	Rectangular	1.73	1	0.6 %	0.33	0.33	∞	
8	Readout Electronics	0.3 %	Normal	1.00	1	0.3 %	0.09	0.09	∞	
9	Response time	0.8 %	Rectangular	1.73	1	0.5 %	0.21	0.21	∞	
10	Integration time	2.6 %	Rectangular	1.73	1	1.5 %	2.25	2.25	∞	
11	RF Ambient Conditions	3.0 %	Rectangular	1.73	1	1.7 %	3.00	3.00	∞	
12	RF Reflections	1.2 %	Rectangular	1.73	1	0.7 %	0.50	0.50	∞	
13	Probe positioner	1.2 %	Rectangular	1.73	1	0.7 %	0.48	0.48	∞	
14	Probe positioning	4.7 %	Rectangular	1.73	1	2.7 %	7.36	7.36	∞	
15	Extrap. And Interpolation	1.0 %	Rectangular	1.73	1	0.6 %	0.33	0.33	∞	
Test Sample Related										
16	Device Positioning Vertical	4.7 %	Rectangular	1.73	1	2.7 %	7.36	7.36	∞	
17	Device Positioning Lateral	1.0 %	Rectangular	1.73	1	0.6 %	0.33	0.33	∞	
18	Device Holder and Phantom	2.4 %	Rectangular	1.73	1	1.4 %	1.92	1.92	∞	
19	Test Sample	0.4 %	Normal	1.00	1	0.4 %	0.16	0.16	g	0.17 dB
20	Power drift	3.0 %	Rectangular	1.73	1	1.7 %	3.00	3.00	∞	
PMF Calculations										
21	Power Sensor	1.0 %	Rectangular	1.73	1	0.6 %	0.32	0.32	∞	
22	Dual Directional Coupler	1.0 %	Rectangular	1.73	1	0.6 %	0.32	0.32	∞	
Phantom and Setup Related										
23	Phantom Thickness	2.4 %	Rectangular	1.73	1	1.4 %	1.92	1.92	∞	
Combined standard Uncertainty [%]						12.8 %		164.64		0.523 dB
Expanded standard Uncertainty [k = 2 , Confidence 95 %]						25.7 %				0.993 dB

Table 2. Uncertainties (E-Field)

Notes:

1. Worst-Case uncertainty budget for HAC free field assessment according to ANSI-C 63.19[1]. The budget is valid for the frequency range 800 MHz-3 GHz and represents a worst-Case analysis. For specific test sand configurations, the uncertainty could be considerably smaller. Some of the parameters are dependent on the user situations and need adjustment according to the actual laboratory conditions.
2. * Uncertainty specifications from Schmidt & Partner Engineering AG (not site specific)

10.2 H-Field

HAC (H-Field) Uncertainty Budget [According to ANSI C63.19]										Note/ Comment
Error Description	Uncertainty [%]	Probability Distribution	Divisor	ci [H]	Standard Uncertainty [H]	Stand Uncert*2	(Stand Uncert*2) X (ci^2)	V _i & V _{eff}		
Measurement system										
1	Probe Calibration	5.1 %	Normal	1.00	1	5.1 %	26.01	26.01	∞	
2	Axial Isotropy	4.7 %	Rectangular	1.73	1	2.7 %	7.36	7.36	∞	
3	Sensor Displacement	16.5 %	Rectangular	1.73	0.145	1.4 %	1.91	0.04	∞	
4	Boundary effect	2.4 %	Rectangular	1.73	1	1.4 %	1.92	1.92	∞	
5	Linearity	4.7 %	Rectangular	1.73	1	2.7 %	7.36	7.36	∞	
6	Scaling to peak Envelope Power	2.0 %	Rectangular	1.73	1	1.2 %	1.33	1.33	∞	
7	System Detection limits	1.0 %	Rectangular	1.73	1	0.6 %	0.33	0.33	∞	
8	Readout Electronics	0.3 %	Normal	1.00	1	0.3 %	0.09	0.09	∞	
9	Response time	0.8 %	Rectangular	1.73	1	0.5 %	0.21	0.21	∞	
10	Integration time	2.6 %	Rectangular	1.73	1	1.5 %	2.25	2.25	∞	
11	RF Ambient Conditions	3.0 %	Rectangular	1.73	1	1.7 %	3.00	3.00	∞	
12	RF Reflections	1.1 %	Rectangular	1.00	1	1.1 %	1.14	1.14	∞	
13	Probe positioner	1.2 %	Rectangular	1.73	0.67	0.5 %	0.22	0.10	∞	
14	Probe positioning	4.7 %	Rectangular	1.73	0.67	1.8 %	3.31	1.48	∞	
15	Extrap. And Interpolation	1.0 %	Rectangular	1.73	1	0.6 %	0.33	0.33	∞	
Test Sample Related										
16	Device Positioning Vertical	4.7 %	Rectangular	1.73	0.67	1.8 %	3.31	7.32	∞	
17	Device Positioning Lateral	1.0 %	Rectangular	1.73	1	0.6 %	0.33	0.33	∞	
18	Device Holder and Phantom	2.4 %	Rectangular	1.73	1	1.4 %	1.92	1.92	∞	
19	Test Sample	0.3 %	Normal	1.00	1	0.3 %	0.08	0.08	9	0.013 dB
20	Power drift	3.0 %	Rectangular	1.73	1	1.7 %	3.00	3.00	∞	
PMF Calculations										
21	Power Sensor	1.0 %	Rectangular	1.73	1	0.6 %	0.32	0.10	∞	
22	Dual Directional Coupler	1.0 %	Rectangular	1.73	1	0.6 %	0.32	0.32	∞	
Phantom and Setup Related										
23	Phantom Thickness	2.4 %	Rectangular	1.73	0.67	0.9 %	0.86	0.39	∞	
Combined standard Uncertainty [%]						8.2 %		66.44		0.342 dB
Expanded standard Uncertainty [k = 2 , Confidence 95 %]						16.3 %				0.6558 dB

Table 2. Uncertainties (H-Field)

Notes:

1. Worst-Case uncertainty budget for HAC free field assessment according to ANSI-C 63.19[1]. The budget is valid for the frequency range 800 MHz-3 GHz and represents a worst-Case analysis. For specific test sand configurations, the uncertainty could be considerably smaller. Some of the parameters are dependent on the user situations and need adjustment according to the actual laboratory conditions.

2. * Uncertainty specifications from Schmidt & Partner Engineering AG (not site specific)

11. HAC TEST DATA SUMMARY

Ambient TEMPERATURE (°C): 21.4
S/N: #1

11.1 Measurement Results (E-Field CDMA / PCS DATA/ AWS DATA Slide up)

Mode	Ch.	Backlight	RC/SO	Battery	Antenna	Conducted Power (dBm)	Time Avg. Field (V/m)	Peak Field (dBV/m)	FCC Limit (dBV/m)	FCC MARGIN (dB)	Exclusion Block	RESULT
CDMA	1013	off	SO55/RC1	Standard	Intenna	24.97	68.3	36.2	51	- 14.84	none	M4
CDMA	384	off	SO55/RC1	Standard	Intenna	24.83	66.5	35.9	51	- 15.07	none	M4
CDMA	777	off	SO55/RC1	Standard	Intenna	24.78	73.2	36.8	51	- 14.24	none	M4
PCS	25	off	SO55/RC1	Standard	Intenna	24.95	40.2	31.8	41	- 9.23	none	M4
PCS	600	off	SO55/RC1	Standard	Intenna	24.84	35.3	30.7	41	- 10.35	none	M4
PCS	1175	off	SO55/RC1	Standard	Intenna	24.79	32.0	29.8	41	- 11.19	none	M4
AWS	25	off	SO55/RC1	Standard	Intenna	24.67	56.2	34.7	41	- 6.30	none	M4
AWS	450	off	SO55/RC1	Standard	Intenna	24.84	52.0	34.0	41	- 6.99	none	M4
AWS	875	off	SO55/RC1	Standard	Intenna	24.72	51.2	33.9	41	- 7.12	none	M4

NOTES:

- All modes of operation were investigated and the worst-case are reported.
- Battery Type Standard Extended Fixed
- Power Measured Conducted EIRP ERP
- Test Signal Call Mode Manual Test cord Base Station Simulator
- SAR Measurement System SPEAG

11. HAC TEST DATA SUMMARY

Ambient TEMPERATURE (°C): 21.4
S/N: #1

11.2 Measurement Results (H-Field CDMA / PCS DATA/ AWS DATA Slide up)

Mode	Ch.	Backlight	RC/SO	Battery	Antenna	Conducted Power (dBm)	Time Avg. Field (V/m)	Peak Field (dBV/m)	FCC Limit (dBV/m)	FCC MARGIN (dB)	Exclusion Block	RESULT
CDMA	1013	off	SO55/RC1	Standard	Intenna	24.97	0.131	- 19.1	0.6	- 19.69	none	M4
CDMA	384	off	SO55/RC1	Standard	Intenna	24.83	0.128	- 19.3	0.6	- 19.87	none	M4
CDMA	777	off	SO55/RC1	Standard	Intenna	24.78	0.140	- 18.5	0.6	- 19.07	none	M4
PCS	25	off	SO55/RC1	Standard	Intenna	24.95	0.106	- 23.2	- 9.4	- 13.84	none	M4
PCS	600	off	SO55/RC1	Standard	Intenna	24.84	0.108	- 23.1	- 9.4	- 13.68	none	M4
PCS	1175	off	SO55/RC1	Standard	Intenna	24.79	0.129	- 21.5	- 9.4	- 12.10	none	M4
AWS	25	off	SO55/RC1	Standard	Intenna	24.67	0.117	- 22.3	- 9.4	- 12.94	none	M4
AWS	450	off	SO55/RC1	Standard	Intenna	24.84	0.135	- 21.1	- 9.4	- 11.70	none	M4
AWS	875	off	SO55/RC1	Standard	Intenna	24.72	0.118	- 22.3	- 9.4	- 12.92	none	M4

NOTES:

- All modes of operation were investigated and the worst-case are reported.
- Battery Type Standard Extended Fixed
- Power Measured Conducted EIRP ERP
- Test Signal Call Mode Manual Test cord Base Station Simulator
- SAR Measurement System SPEAG

11. HAC TEST DATA SUMMARY

Ambient TEMPERATURE (°C): 21.4
S/N: #1

11.3 Measurement Results (E-Field CDMA / PCS DATA/ AWS DATA Slide down)

Mode	Ch.	Backlight	RC/SO	Battery	Antenna	Conducted Power (dBm)	Time Avg. Field (V/m)	Peak Field (dBV/m)	FCC Limit (dBV/m)	FCC MARGIN (dB)	Exclusion Block	RESULT
CDMA	1013	off	SO55/RC1	Standard	Intenna	24.97	67.2	36.0	51	- 14.99	none	M4
CDMA	384	off	SO55/RC1	Standard	Intenna	24.83	64.7	35.7	51	- 15.31	none	M4
CDMA	777	off	SO55/RC1	Standard	Intenna	24.78	68.4	36.2	51	- 14.83	none	M4
PCS	25	off	SO55/RC1	Standard	Intenna	24.95	36.2	30.9	41	- 10.14	none	M4
PCS	600	off	SO55/RC1	Standard	Intenna	24.84	32.7	30.0	41	- 11.00	none	M4
PCS	1175	off	SO55/RC1	Standard	Intenna	24.79	34.3	30.4	41	- 10.60	none	M4
AWS	25	off	SO55/RC1	Standard	Intenna	24.67	42.8	32.3	41	- 8.67	none	M4
AWS	450	off	SO55/RC1	Standard	Intenna	24.84	47.0	33.1	41	- 7.86	none	M4
AWS	875	off	SO55/RC1	Standard	Intenna	24.72	44.0	32.6	41	- 8.43	none	M4

NOTES:

- All modes of operation were investigated and the worst-case are reported.
- Battery Type Standard Extended Fixed
- Power Measured Conducted EIRP ERP
- Test Signal Call Mode Manual Test cord Base Station Simulator
- SAR Measurement System SPEAG

11. HAC TEST DATA SUMMARY

Ambient TEMPERATURE (°C): 21.4
S/N: #1

11.4 Measurement Results (H-Field CDMA / PCS DATA/ AWS DATA Slide down)

Mode	Ch.	Backlight	RC/SO	Battery	Antenna	Conducted Power (dBm)	Time Avg. Field (V/m)	Peak Field (dBV/m)	FCC Limit (dBV/m)	FCC MARGIN (dB)	Exclusion Block	RESULT
CDMA	1013	off	SO55/RC1	Standard	Intenna	24.97	0.134	- 18.9	0.6	- 19.47	none	M4
CDMA	384	off	SO55/RC1	Standard	Intenna	24.83	0.135	- 18.8	0.6	- 19.39	none	M4
CDMA	777	off	SO55/RC1	Standard	Intenna	24.78	0.143	- 18.3	0.6	- 18.88	none	M4
PCS	25	off	SO55/RC1	Standard	Intenna	24.95	0.109	- 23.0	- 9.4	- 13.56	none	M4
PCS	600	off	SO55/RC1	Standard	Intenna	24.84	0.109	- 23.0	- 9.4	- 13.61	none	M4
PCS	1175	off	SO55/RC1	Standard	Intenna	24.79	0.131	- 21.4	- 9.4	- 12.02	none	M4
AWS	25	off	SO55/RC1	Standard	Intenna	24.67	0.114	- 22.6	- 9.4	- 13.16	none	M4
AWS	450	off	SO55/RC1	Standard	Intenna	24.84	0.131	- 21.4	- 9.4	- 11.96	none	M4
AWS	875	off	SO55/RC1	Standard	Intenna	24.72	0.114	- 22.6	- 9.4	- 13.22	none	M4

NOTES:

- All modes of operation were investigated and the worst-case are reported.
- Battery Type Standard Extended Fixed
- Power Measured Conducted EIRP ERP
- Test Signal Call Mode Manual Test cord Base Station Simulator
- SAR Measurement System SPEAG

11. HAC TEST DATA SUMMARY

Ambient TEMPERATURE (°C): 21.4

S/N: #1

11.5 Worst-case Configuration Evaluation

Peak Reading 360° Probe Rotation at Azimuth axis

Mode	Channel	Backlight	RC/SO	Antenna	Conducted Power (dBm)	Time Avg. Field (A/m)	Peak Field (dBA/m)	FCC Limit (dBA/m)	FCC MARGIN (dB)	Exclusion Block	RESULT
AWS	25	off	SO55/RC1	Standard	24.67	56.3	34.7	41	- 6.28	none	M4

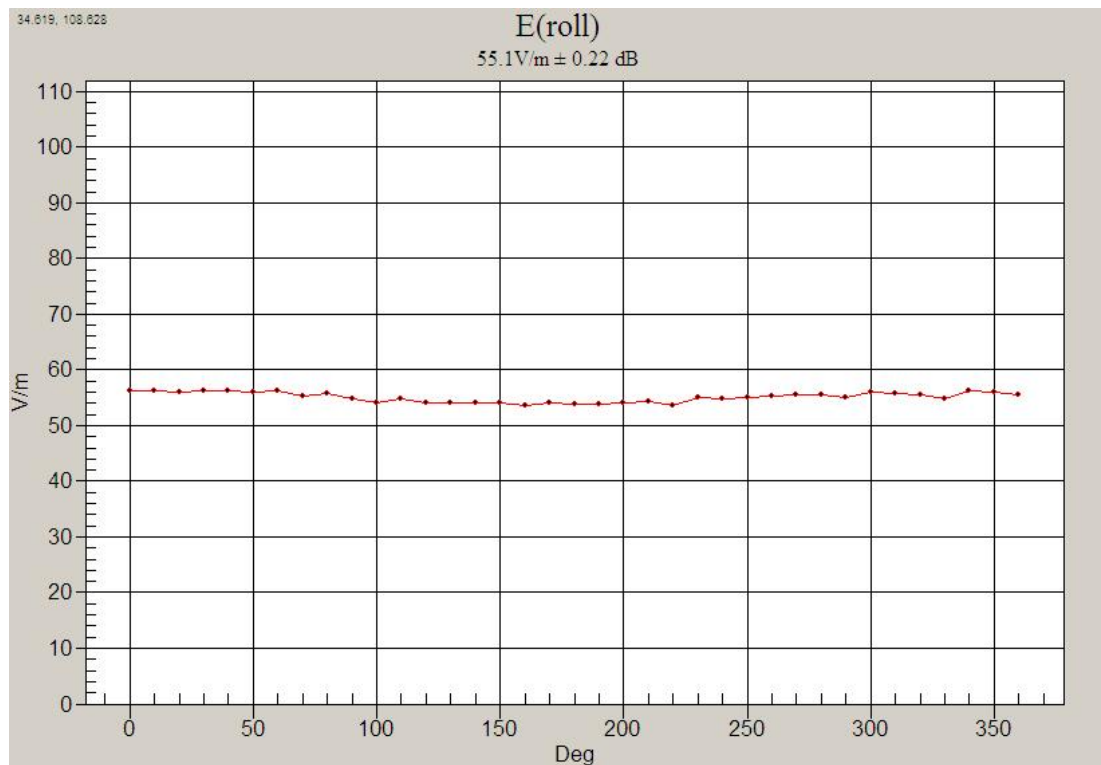

Worst-Case Probe Rotation about Azimuth axis

12. HAC TEST EQUIPMENT LIST

Manufacturer	Type / Model	S/N	Calib. Date	Calib. Interval	Calib. Due
Staubli	Robot RX90L	F01/ 5K09A1/A/01	N/A	N/A	N/A
Staubli	Robot ControllerCS7MB	F99/5A82A1/C/01	N/A	N/A	N/A
Staubli	Teach Pendant (Joystick)	D221340.01	N/A	N/A	N/A
HP	Pavilion t000_puffer	KRJ51201TV	N/A	N/A	N/A
SPEAG	SPEAG HAC Phantom	-	N/A	N/A	N/A
SPEAG	Light Alignment Sensor	265	N/A	N/A	N/A
SPEAG	DAE3	466	07/17/08	Annual	07/17/09
SPEAG	DAE4	869	09/03/ 08	Annual	09/03/09
SPEAG	E-Field Probe	2343	05/19/08	Annual	05/19/09
SPEAG	H-Field Probe	6101	05/19/08	Annual	05/19/09
SPEAG	Validation Dipole CD835V2	1024	03/11/08	Biennial	03/11/10
SPEAG	Validation Dipole CD1880V2	1019	03/11/08	Biennial	03/11/10
Agilent	Power Meter(F) E4419B	MY41291386	11/05/08	Annual	11/05/09
Agilent	Power Sensor(G) 8481	MY41090870	11/05/08	Annual	11/05/09
HP	Signal Generator E4438C	MY42082646	12/24/08	Annual	12/24/09
EM POWER	Power Amp BBS3Q7ELU	1009D/C0028	11/05/08	Annual	11/05/09
HP	Dual Directional Coupler 778D	16072	11/05/08	Annual	11/05/09
R&S	Base Station CMU200	110740	07/26/08	Annual	07/26/09
Agilent	Base Station E5515C	GB44400269	02/10/09	Annual	02/10/10
R&S	Spectrum Analyzer FSP30	839117/011	07/31/08	Annual	07/31/09

NOTE:

The probe was calibrated by SPEAG, by the waveguide technique procedure. Dipole Validation measurement is performed by HCT Lab. before each test.

13. CONCLUSION

The HAC measurement indicates that the EUT complies with the HAC limits of the ANSI-C63.19-2006. These measurements are taken to simulate the RF effects exposure under worst-case conditions. Precise Laboratory measures were taken to assure repeatability of the tests.