



# PCTEST Engineering Laboratory, Inc.

6660-B Dobbin Road • Columbia, MD 21045 • U.S.A.

TEL (410) 290-6652 • FAX (410) 290-6654

www.pctestlab.com



## CERTIFICATE OF COMPLIANCE FCC Part 22 Certification

HYUNDAI Curitel Inc.  
San 136-1, Ami-Ri, Bubal-Eub  
Ichon-Si, Kyungki-Do, KOREA 467-701  
Attn: Mr. Ki-Soo Kim, QM Dept.  
System Quality Assurance Office

Dates of Tests: June 12-14, 2001  
Test Report S/N: 22.210611363.PP4  
Test Site: PCTEST Lab, Columbia MD USA

FCC ID

**PP4DX-20B**

APPLICANT

**HYUNDAI Curitel Inc.**

Classification:	Non-Broadcast Transmitter held to ear (TNE)
FCC Rule Part(s):	§22(H), §22.901(d), §2
EUT Type:	Dual-Mode Cellular Phone (AMPS/CDMA)
Trade Name/Model(s):	<i>HYUNDAI DX-20B</i>
Tx Frequency Range:	824.04 - 848.97MHz (AMPS) 824.70 - 848.31 MHz (CDMA)
Rx Frequency Range:	869.04 - 893.97MHz (AMPS) 869.70 - 893.31 MHz (CDMA)
Max. RF Output Power:	0.607 W ERP AMPS (27.835 dBm) / 0.443 W ERP CDMA (26.462 dBm)
Max SAR Measurement:	HEAD SAR: 1.310mW/g Amps Head SAR; 1.000mW/g CDMA Head SAR BODY SAR: 0.419mW/g Amps Body SAR; 0.267mW/g CDMA Body SAR
Frequency Tolerance:	0.00025% (2.5 ppm)
Emission Designators:	40K0F8W, 40K0F1D, 1M25F9W

This equipment has been shown to be capable of compliance with the applicable technical standards as indicated in the measurement report and was tested in accordance with the measurement procedures specified in §2.947.

I attest to the accuracy of data. All measurements reported herein were performed by me or were made under my supervision and are correct to the best of my knowledge and belief. I assume full responsibility for the completeness of these measurements and vouch for the qualifications of all persons taking them.

*PCTEST certifies that no party to this application has been denied the FCC benefits pursuant to Section 5301 of the Anti-Drug Abuse Act of 1988, 21 U.S.C. 862.*



\_\_\_\_\_  
Randy Ortanez  
President

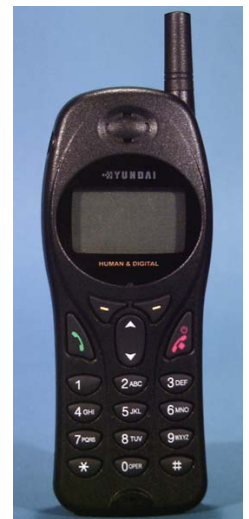

**NVLAP**<sup>®</sup>  
LAB CODE 100431-0

## TABLE OF CONTENTS

---

<b>ATTACHMENT A: COVER LETTER(S)</b>	
<b>ATTACHMENT B: ATTESTATION STATEMENT(S)</b>	
<b>ATTACHMENT C: TEST REPORT</b>	
<b>1.1 SCOPE</b>	<b>1</b>
<b>2.1 INTRODUCTION</b>	<b>2</b>
<b>3.1 INSERTS PER §2.1033(d)</b>	<b>3</b>
<b>4.1 DESCRIPTION OF TESTS</b>	<b>4-6</b>
<b>5.1 EFFECTIVE RADIATED POWER OUTPUT</b>	<b>7-8</b>
<b>6.1 RADIATED MEASUREMENTS</b>	<b>9-14</b>
<b>7.1 FREQUENCY STABILITY</b>	<b>15-18</b>
<b>8.1 PLOTS OF EMISSIONS</b>	<b>19</b>
<b>9.1 LIST OF TEST EQUIPMENT</b>	<b>20</b>
<b>10.1 SAMPLE CALCULATIONS</b>	<b>21</b>
<b>11.1 CONCLUSION</b>	<b>22</b>
<b>ATTACHMENT D: TEST PLOTS</b>	
<b>ATTACHMENT E: FCC ID LABEL &amp; LOCATION</b>	
<b>ATTACHMENT F: TEST SETUP PHOTOGRAPHS</b>	
<b>ATTACHMENT G: EXTERNAL PHOTOGRAPHS</b>	
<b>ATTACHMENT H: INTERNAL PHOTOGRAPHS</b>	
<b>ATTACHMENT I: BLOCK DIAGRAM(S) / CIRCUIT DIAGRAMS</b>	
<b>ATTACHMENT J: PARTS LIST/TUNE UP PROCEDURE</b>	
<b>ATTACHMENT K: OPERATIONAL DESCRIPTION</b>	
<b>ATTACHMENT L: USER'S MANUAL</b>	
<b>ATTACHMENT M: SAR MEASUREMENT REPORT</b>	
<b>ATTACHMENT N: SAR TEST DATA</b>	
<b>ATTACHMENT O: SAR TEST SETUP PHOTOGRAPHS</b>	
<b>ATTACHMENT P: DIPOLE VALIDATION</b>	
<b>ATTACHMENT Q: PROBE CALIBRATION</b>	

# MEASUREMENT REPORT

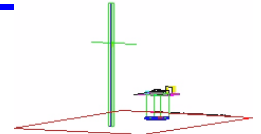
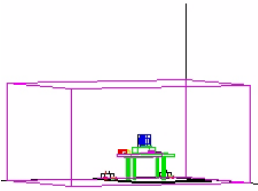

## 1.1 Scope

Measurement and determination of electromagnetic emissions (EME) of radio frequency devices including intentional and/or unintentional radiators for compliance with the technical rules and regulations of the Federal Communications Commission.

## §2.1033 General Information

<b>Applicant:</b>	<b>HYUNDAI Curitel Inc.</b>
<b>Address:</b>	<b>San 136-1, Ami-ri, Bubal-Eub Ichon-Si, Kyungki-Do, KOREA 467-701</b>
<b>Attention:</b>	<b>Mr. Ki-Soo Kim, QM Dept System Quality Assurance Office</b>

- FCC ID: **PP4DX-20B**
- Trade Name(s): **HYUNDAI**
- Model(s): **DX-20B**
- Quantity: Quantity production is planned
- Emission Designator: 40K0F8W, 40K0F1D, 1M25F9W
- Tx Freq. Range: 824.04 – 848.97 MHz (AMPS) / 824.70 ~ 848.31 (CDMA)  
Rx Freq. Range: 869.04 – 893.97 MHz (AMPS) / 869.70 ~ 893.31 (CDMA)
- Equipment Class: Non-Broadcast Transmitter Held to Ear (TNE)
- Equipment Type: Dual-Mode Cellular Phone
- Modulation(s): AMPS / CDMA
- Frequency Tolerance:  $\pm 0.00025\%$  (2.5 ppm)
- Max. RF Output Power: 0.607W ERP AMPS (27.835 dBm)  
0.443W ERP CDMA (26.467 dBm)
- Max SAR Measurement: 1.310mW/g AMPS Head SAR; 1.000 mW/g CDMA Head SAR  
0.419mW/g AMPS Body SAR; 0.267mW/g CDMA Body SAR
- FCC Rule Part(s): §22(H), §22.901(d), §2
- Antenna Specifications: ACE Technology Model: DX-20B (Fixed Antenna)  
3.41 cm ~ length
- Battery Pack: 3.6VDC; 950mAh
- Dates of Tests: June 12-14, 2001
- Place of Tests: PCTEST Lab, Columbia, MD U.S.A.

## 2.1 INTRODUCTION

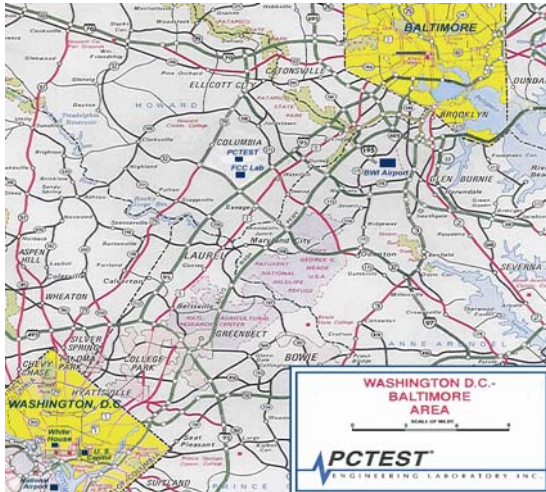

Figure 1. Map of the Greater Baltimore and Metropolitan Washington, D.C. area.

These measurement tests were conducted at **PCTEST Engineering Laboratory, Inc.** facility in New Concept Business Park, Guilford Industrial Park, Columbia, Maryland. The site address is 6660-B Dobbin Road, Columbia, MD 21045. The test site is one of the highest points in the Columbia area with an elevation of 390 feet above mean sea level. The site coordinates are 39° 11'15" N latitude and 76° 49'38" W longitude. The facility is 1.5 miles North of the FCC laboratory, and the ambient signal and ambient signal strength are approximately equal to those of the FCC laboratory. There are no FM or TV transmitters within 15 miles of the site. The detailed description of the measurement facility was found to be in compliance with the requirements of § 2.948 according to ANSI C63.4 on October 19, 1992.

### Measurement Procedure

The radiated and spurious measurements were made outdoors at a 3-meter test range (see Figure 2). The equipment under test is placed on a wooden turntable 3-meters from the receive antenna. The receive antenna height and turntable rotations were adjusted for the highest reading on the receive spectrum analyzer. A half-wave dipole was substituted in place of the EUT. This dipole antenna was driven by a signal generator and the level of the signal generator was adjusted to obtain the same receive spectrum analyzer reading. This level is recorded. For readings above 1GHz, the above procedure is repeated using horn antennas and the difference between the gain of the horn and an isotropic antenna are taken into consideration.

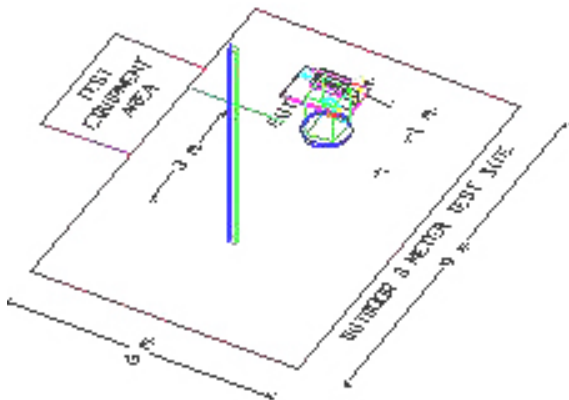

Figure 2. 3-meter Outdoor Test Site

### 3.1 INSERTS PER §2.1033(d)

---

#### **§2.1033(d) Function of Active Devices (Confidential)**

The Function of active devices are shown in Attachment J.

#### **§2.1033(d) Block/Circuit Diagrams (Confidential)**

The circuit diagrams and block diagrams are shown in Attachment I.

#### **§2.1033(d) Operating Instructions**

The instruction manual is shown in Attachment L.

#### **§2.1033(d) Parts List & Tune-Up Procedure (Confidential)**

The parts list & tune-up procedure are shown in Attachment J.

#### **§2.1033(d) Description of Freq. Stabilization Circuit (Confidential)**

The description of frequency stabilization circuit is shown in Attachment K.

#### **§2.1033(d) Description for Suppression of Spurious Radiation, for Limiting Modulation, and Harmonic Suppression Circuits (Confidential)**

The description of suppression stabilization circuits are shown in Attachment K.

## 4.1 DESCRIPTION OF TESTS

### **4.2 §2.1047(a) Transmitter Audio Frequency Response**

The frequency response of the audio modulating circuit over the frequency range 100 – 5000 Hz is measured. The audio signal generator is connected to the audio input circuit/microphone of the EUT. The audio signal input is adjusted to obtain 50% modulation at 1kHz and this point is taken as the 0dB reference. With the input held constant and below the limit at all frequencies, the audio signal generator is varied from 100 to 50 kHz.

### **4.3 §22.915(d) Audio Low Pass Filter Frequency Response**

The response in dB relative to 1kHz is measured using the HP8901 a Modulation Analyzer. For the frequency response of the audio low-pass filter, the audio input is connected at the input to the modulation limiter and the modulated stage. The audio output is connected at the output of the modulated stage. The corresponding plots are shown herein.

### **4.4 §2.1047(b) & §22.915(b) Modulation Limiting**

The audio signal generator is connected to the audio input circuit/microphone of the EUT. The modulation response is measured for each of the three modulating frequencies (300Hz, 1000 Hz, and 3000Hz), and the input voltage is varied from 30% modulation ( $\pm 3.6$ kHz deviation) to at least 20dB higher than the saturation point. Measurements of modulation and the plots are attached herein. Measurements were performed for ST, SAT, and wide-band data modulations. The corresponding results are shown herein.

Note: ST, SAT, & Wide-Band data were internally generated by the EUT.

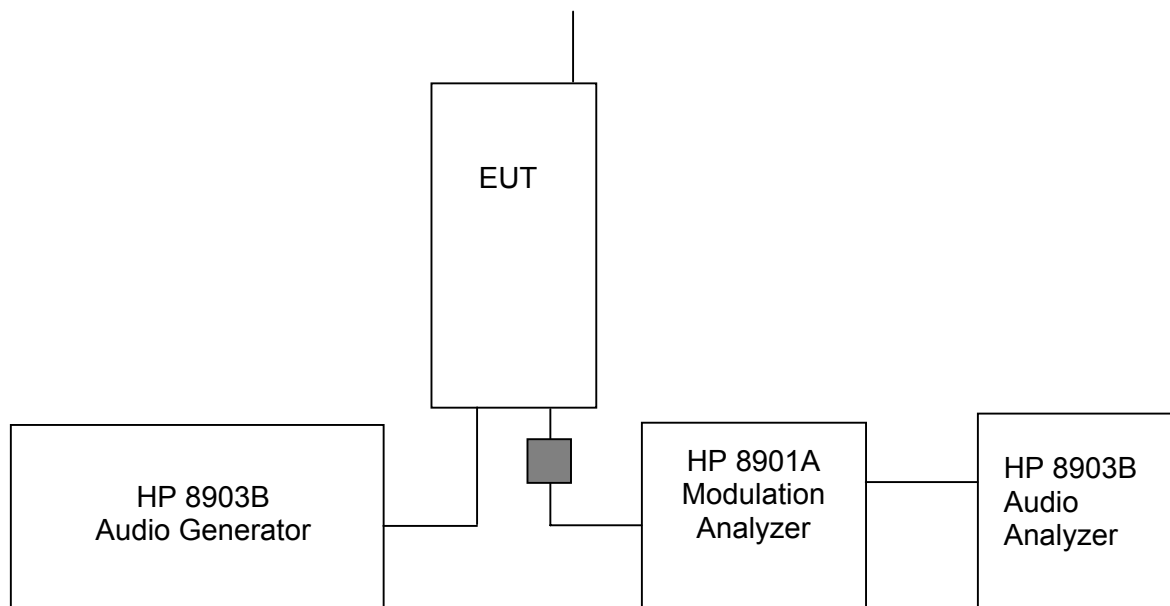

Fig. 3. Transmitter Audio Frequency & Tone Modulation Test Setup.

## **4.1 DESCRIPTION OF TESTS (CONTINUED)**

---

### **4.4 §2.1049(c) Occupied Bandwidth**

The audio signal generator is adjusted to 1kHz. The output level is set to +/- 6kHz deviation. With the level constant, the freq. is set to 2,500Hz. Then the audio signal level is increased by 16dB. The occupied bandwidth data is obtained for the SAT (Supervisory Audio Tone), ST (Signaling Tone), WBD (Wideband Data), and DTMF (Dual Tone Multi Frequencies). The results are shown on the attached graphs.

Specified Limits:

- (a) On any frequency removed from the assigned carrier frequency by more than 20kHz, up to and including 45kHz, the sideband is at least 26dB below the carrier.
- (b) On any frequency removed from the assigned carrier frequency by more than 45kHz, up to and including 90kHz, the sideband is at least 45dB below the carrier.
- (c) On any frequency removed from the assigned carrier frequency by more than 90kHz, up to the first multiple of the carrier frequency, the sideband is at least 60dB below the carrier of  $40 + \log_{10}$  (mean power output in Watts) dB, whichever is the smaller attenuation.

### **4.5 §2.1051 Spurious and Harmonic Emissions at Antenna Terminal**

The level of the carrier and the various conducted spurious and harmonic frequencies is measured by means of a calibrated spectrum analyzer. The spectrum is scanned from the lowest frequency generated in the equipment up to 10 GHz. The transmitter is modulated with a 2500Hz tone at a level of 16dB greater than that required to provide 50% modulation.

At the input terminals of the spectrum analyzer, an isolator (RF circulator with one port terminated with 50 ohms) and an 870 MHz to 890 MHz bandpass filter is connected between the test transceiver (for conducted tests) or the receive antenna (for radiated tests) and the analyzer. The rejection of the bandpass filter to signals in the 825 – 845 MHz range is adequate to limit the transmit energy from the test transceiver which appears to a level which will allow the analyzer to measure signals less than -90dBm. Calibration of the test receiver is performed in the 870 – 890 MHz range to insure accuracy to allow variation in the bandpass filter insertion loss to be calibrated.

### **4.7 §2.1053 Radiation Spurious and Harmonic Emissions**

Radiation and harmonic emissions above 1 GHz is measured outdoors at our 3-meter test range. The equipment under test is placed on a wooden turntable 3-meters from the receive antenna. The receive antenna height and turntable rotations were adjusted for the highest reading on the receive spectrum analyzer. A half-wave dipole was substituted in place of the EUT. This dipole antenna was driven by a signal generator with the level of the signal generator being adjusted to obtain the same receive spectrum analyzer reading. This level is recorded. For readings above 1GHz, the above procedure is repeated using horn antennas and the difference between the gain of the horn and an isotropic antenna are taken into consideration.

## 4.1 DESCRIPTION OF TESTS (CONTINUED)

---

### **4.8 §2.995 Frequency Stability/Temperature Variation**

The frequency stability of the transmitter is measured by:

- a.) **Temperature:** The temperature is varied from -30°C to +60°C using an environmental chamber.
- b.) **Primary Supply Voltage:** The primary supply voltage is varied from 85% to 115% of the voltage normally at the input to the device or at the power supply terminals if cables are not normally supplied.

*Specification – The minimum frequency stability shall be +/- 0.00025% at any time during normal operation.*

#### **Time Period and Procedure:**

1. The carrier frequency of the transmitter and the individual oscillators is measured at room temperature (25°C to 27°C to provide a reference).
2. The equipment is subjected to an overnight “soak” at -30°C without any power applied.
3. After the overnight “soak” at 30°C (usually 14-16 hours), the equipment is turned on in a “standby” condition for one minute before applying power to the transmitter. Measurement of the carrier frequency of the transmitter and the individual oscillators is made within a three minute interval after applying power to the transmitter.
4. Frequency measurements is made at 10°C interval up to room temperature. At least a period of one and one half hour is provided to allow stabilization of the equipment at each temperature level.
5. Again the transmitter carrier frequency and the individual oscillators is measured at room temperature to begin measurement of the upper temperature levels.
6. Frequency were made at 10 intervals starting at 30°C up to +50°C allowing at least two hours at each temperature for stabilization. In all measurements the frequency is measured within three minutes after applying power to the transmitter.
7. The artificial load is mounted external to the temperature chamber.

**NOTE: The EUT is tested down to the battery endpoint.**



## 5.1 Test Data

---

### 5.2 Effective Radiated Power Output

A. POWER: **Low (Analog Mode)**

Freq. Tuned (MHz)	LEVEL (dBm)	POL (H/V)	ERP (W)	ERP (dBm)
824.04	-34.455	H	0.00482	6.818
836.49	-34.731	H	0.00469	6.698
848.97	-34.739	H	0.00485	6.846

B. POWER: **High (Analog Mode)**

Freq. Tuned (MHz)	LEVEL (dBm)	POL (H/V)	ERP (W)	ERP (dBm)	BATTERY
824.04	-13.465	H	0.60371	27.808	Standard
836.49	-13.699	H	0.59291	27.730	Standard
848.97	-13.750	H	0.60742	27.835	Standard

**NOTES:**

ERP Measurements by Substitution Method:

The EUT was placed on a wooden turn table 3-meters from the receive antenna. The receive antenna height and turntable rotation was adjusted for the highest reading on the receive spectrum analyzer. A half-wave dipole was substituted in place of the EUT. This dipole antenna was driven by a signal generator and the level of the signal generator was adjusted to obtain the same receive spectrum analyzer reading. This ERP level is recorded. For readings above 1GHz, the above procedure is repeated using horn antennas and the difference between the gain of the horn and an isotropic antenna are taken into consideration.

## Test Data

---

### 5.3 Effective Radiated Power Output

---

A. POWER: **High (CDMA Mode)**

Freq. Tuned (MHz)	LEVEL (dBm)	POL (H/V)	ERP (W)	ERP (dBm)	BATTERY
824.70	-14.831	H	0.44162	26.451	Standard
835.89	-15.312	H	0.40826	26.109	Standard
848.31	-15.115	H	0.44276	26.462	Standard

**NOTES:**

---

ERP Measurements by Substitution Method:

The EUT was placed on a wooden turn table 3-meters from the receive antenna. The receive antenna height and turntable rotation was adjusted for the highest reading on the receive spectrum analyzer. A half-wave dipole was substituted in place of the EUT. This dipole antenna was driven by a signal generator and the level of the signal generator was adjusted to obtain the same receive spectrum analyzer reading. This ERP level is recorded. For readings above 1GHz, the above procedure is repeated using horn antennas and the difference between the gain of the horn and an isotropic antenna are taken into consideration.

## 6.1 Test Data

### 6.2 AMPS Radiated Measurements

#### Field Strength of SPURIOUS Radiation

OPERATING FREQUENCY: 824.04 MHz  
CHANNEL: 0991 (Low)  
MEASURED OUTPUT POWER: 27.835 dBm = 0.607 W  
MODULATION SIGNAL: FM (Internal)  
DISTANCE: 3 meters  
LIMIT:  $43 + 10 \log_{10} (W) =$  40.84 dBc

FREQ . (M H z)	LEVEL (dBm )	POL (H /V )	(dB c)
1648.08	-85.34	V	69.1
2472.12	-93.78	V	73.2
3296.16	-101.96	V	77.7
4120.20	-109.35	V	81.5
4944.24	< -130		

#### NOTES:

##### Radiated Spurious Emission Measurements by Substitution Method:

The EUT was placed on a wooden turn table 3-meters from the receive antenna. The receive antenna height and turntable rotation was adjusted for the highest reading on the receive spectrum analyzer. A half-wave dipole was substituted in place of the EUT. This dipole antenna was driven by a signal generator and the level of the signal generator was adjusted to obtain the same receive spectrum analyzer reading. This spurious level is recorded. For readings above 1GHz, the above procedure is repeated using horn antennas and the difference between the gain of the horn and an isotropic or dipole antenna are taken into consideration.

## 6.1 Test Data (Continued)

### 6.3 AMPS Radiated Measurements

#### Field Strength of SPURIOUS Radiation

OPERATING FREQUENCY: 836.49 MHz  
 CHANNEL: 0383 (Mid)  
 MEASURED OUTPUT POWER: 27.835 dBm = 0.607 W  
 MODULATION SIGNAL: FM (Internal)  
 DISTANCE: 3 meters  
 LIMIT:  $43 + 10 \log_{10} (W) =$  40.84 dBc

FREQ . (MHz)	LEVEL (dBm)	POL (H/V)	(dBc)
1672.98	-87.85	V	71.6
2509.47	-98.63	V	77.8
3345.96	-102.06	V	77.6
4182.45	-110.83	V	82.8
5018.94	< -130		

#### NOTES:

##### Radiated Spurious Emission Measurements by Substitution Method:

The EUT was placed on a wooden turn table 3-meters from the receive antenna. The receive antenna height and turntable rotation was adjusted for the highest reading on the receive spectrum analyzer. A half-wave dipole was substituted in place of the EUT. This dipole antenna was driven by a signal generator and the level of the signal generator was adjusted to obtain the same receive spectrum analyzer reading. This spurious level is recorded. For readings above 1GHz, the above procedure is repeated using horn antennas and the difference between the gain of the horn and an isotropic or dipole antenna are taken into consideration.

## 6.1 Test Data (Continued)

### 6.4 AMPS Radiated Measurements

#### Field Strength of SPURIOUS Radiation

OPERATING FREQUENCY: 848.97 MHz  
 CHANNEL: 0799 (High)  
 MEASURED OUTPUT POWER: 27.835 dBm = 0.607 W  
 MODULATION SIGNAL: FM (Internal)  
 DISTANCE: 3 meters  
 LIMIT:  $43 + 10 \log_{10} (W) =$  40.84 dBc

FREQ . (MHz)	LEVEL (dBm )	POL (H /V )	(dBc)
1697.94	-85.24	V	68.6
2546.91	-94.25	V	73.3
3395.88	-101.84	V	77.1
4244.85	-108.84	V	81.0
5093.82	< -130		

#### NOTES:

Radiated Spurious Emission Measurements by Substitution Method:  
 The EUT was placed on a wooden turn table 3-meters from the receive antenna. The receive antenna height and turntable rotation was adjusted for the highest reading on the receive spectrum analyzer. A half-wave dipole was substituted in place of the EUT. This dipole antenna was driven by a signal generator and the level of the signal generator was adjusted to obtain the same receive spectrum analyzer reading. This spurious level is recorded. For readings above 1GHz, the above procedure is repeated using horn antennas and the difference between the gain of the horn and an isotropic or dipole antenna are taken into consideration.

## 6.1 Test Data (Continued)

### 6.5 CELLULAR CDMA Radiated Measurements

#### Field Strength of SPURIOUS Radiation

OPERATING FREQUENCY: 824.70 MHz  
CHANNEL: 1013 (Low)  
MEASURED OUTPUT POWER: 26.462 dBm = 0.443 W  
MODULATION SIGNAL: CDMA (Internal)  
DISTANCE: 3 meters  
LIMIT:  $43 + 10 \log_{10} (W) =$  39.46 dBc

FREQ . (M H z)	LEVEL (dBm )	POL (H /V )	(dB c)
1649.40	-87.74	V	70.1
2474.10	-96.82	V	74.9
3298.80	-100.83	V	75.2
4123.50	-111.73	V	82.5
4948.20	< -130		

#### NOTES:

##### Radiated Spurious Emission Measurements by Substitution Method:

The EUT was placed on a wooden turn table 3-meters from the receive antenna. The receive antenna height and turntable rotation was adjusted for the highest reading on the receive spectrum analyzer. A half-wave dipole was substituted in place of the EUT. This dipole antenna was driven by a signal generator and the level of the signal generator was adjusted to obtain the same receive spectrum analyzer reading. This spurious level is recorded. For readings above 1GHz, the above procedure is repeated using horn antennas and the difference between the gain of the horn and an isotropic or dipole antenna are taken into consideration.

## 6.1 Test Data (Continued)

### 6.6 CELLULAR CDMA Radiated Measurements

#### Field Strength of SPURIOUS Radiation

OPERATING FREQUENCY: 835.89 MHz  
 CHANNEL: 0363 (Mid)  
 MEASURED OUTPUT POWER: 26.462 dBm = 0.443 W  
 MODULATION SIGNAL: CDMA (Internal)  
 DISTANCE: 3 meters  
 LIMIT:  $43 + 10 \log_{10} (W) =$  39.46 dBc

FREQ . (M H z)	LEVEL (dBm )	POL (H /V)	(dB c)
1671.78	-86.92	V	69.3
2507.67	-95.85	V	73.7
3343.56	-101.02	V	75.2
4179.45	-110.29	V	80.9
5015.34	< -130		

#### NOTES:

##### Radiated Spurious Emission Measurements by Substitution Method:

The EUT was placed on a wooden turn table 3-meters from the receive antenna. The receive antenna height and turntable rotation was adjusted for the highest reading on the receive spectrum analyzer. A half-wave dipole was substituted in place of the EUT. This dipole antenna was driven by a signal generator and the level of the signal generator was adjusted to obtain the same receive spectrum analyzer reading. This spurious level is recorded. For readings above 1GHz, the above procedure is repeated using horn antennas and the difference between the gain of the horn and an isotropic or dipole antenna are taken into consideration.

## 6.1 Test Data (Continued)

### 6.7 CELULAR CDMA Radiated Measurements

#### Field Strength of SPURIOUS Radiation

OPERATING FREQUENCY: 848.31 MHz  
 CHANNEL: 0777 (High)  
 MEASURED OUTPUT POWER: 26.462 dBm = 0.443 W  
 MODULATION SIGNAL: CDMA (Internal)  
 DISTANCE: 3 meters  
 LIMIT:  $43 + 10 \log_{10} (W) =$  39.46 dBc

FREQ . (M H z)	LEVEL (dBm )	POL (H /V )	(dB c)
1696.62	-86.08	V	68.0
2544.93	-94.52	V	72.2
3393.24	-98.10	V	72.0
4241.55	-102.31	V	72.8
5089.86	< -130		

#### NOTES:

##### Radiated Spurious Emission Measurements by Substitution Method:

The EUT was placed on a wooden turn table 3-meters from the receive antenna. The receive antenna height and turntable rotation was adjusted for the highest reading on the receive spectrum analyzer. A half-wave dipole was substituted in place of the EUT. This dipole antenna was driven by a signal generator and the level of the signal generator was adjusted to obtain the same receive spectrum analyzer reading. This spurious level is recorded. For readings above 1GHz, the above procedure is repeated using horn antennas and the difference between the gain of the horn and an isotropic or dipole antenna are taken into consideration.



## 7.1 Test Data (Continued)

### 7.2 FREQUENCY STABILITY (AMPS)

OPERATING FREQUENCY: 836,490,009 Hz  
 CHANNEL: 383  
 REFERENCE VOLTAGE: 3.6 VDC  
 DEVIATION LIMIT: ± 0.00025 % or 2.5 ppm

VOLTAGE (%)	POWER (VDC)	TEMP (°C)	FREQ. (Hz)	Deviation (%)
100 %	3.60	+ 20 (Ref)	836,490,009	0.000000
100 %		-30	836,490,335	-0.000039
100 %		-20	836,490,385	-0.000045
100 %		-10	836,490,419	-0.000049
100 %		0	836,490,327	-0.000038
100 %		+ 10	836,490,268	-0.000031
100 %		+ 20	836,490,009	0.000000
100 %		+ 25	836,489,967	0.000005
100 %		+ 30	836,489,909	0.000012
100 %		+ 40	836,489,783	0.000027
100 %		+ 50	836,489,825	0.000022
100 %		+ 60	836,489,800	0.000025
85 %		3.06	+ 20	836,490,009
115 %	4.14	+ 20	836,490,009	0.000000
BATT. ENDPOINT	2.92	+ 20	836,490,009	0.000000

## 7.1 Test Data (Continued)

---

### 7.3 FREQUENCY STABILITY (AMPS)

---

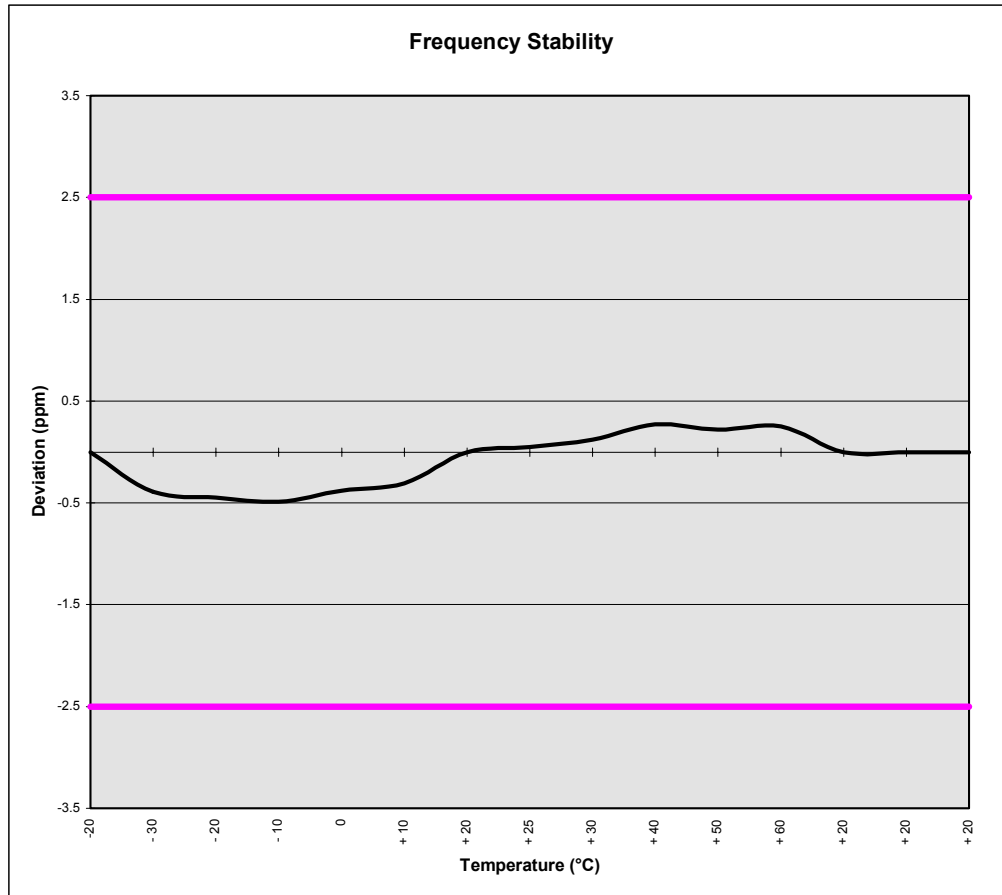

## 7.1 Test Data

### 7.4 FREQUENCY STABILITY

OPERATING FREQUENCY: 835,890,004 Hz  
 CHANNEL: 363  
 REFERENCE VOLTAGE: 3.6 VDC  
 DEVIATION LIMIT: ± 0.00025 % or 2.5 ppm

VOLTAGE (%)	POWER (VDC)	TEMP (°C)	FREQ. (Hz)	Deviation (%)
100 %	3.60	+ 20 (Ref)	835,890,004	0.000000
100 %		-30	835,889,762	0.000029
100 %		-20	835,889,812	0.000023
100 %		-10	835,889,862	0.000017
100 %		0	835,889,929	0.000009
100 %		+ 10	835,890,000	0.000001
100 %		+ 20	835,890,004	0.000000
100 %		+ 25	835,890,054	-0.000006
100 %		+ 30	835,890,238	-0.000028
100 %		+ 40	835,890,297	-0.000035
100 %		+ 50	835,890,238	-0.000028
100 %		+ 60	835,890,138	-0.000016
85 %		3.06	+ 20	835,890,004
115 %	4.14	+ 20	835,890,004	0.000000
BATT. ENDPOINT	2.76	+ 20	835,890,004	0.000000

## 7.1 Test Data (Continued)

### 7.5 FREQUENCY STABILITY

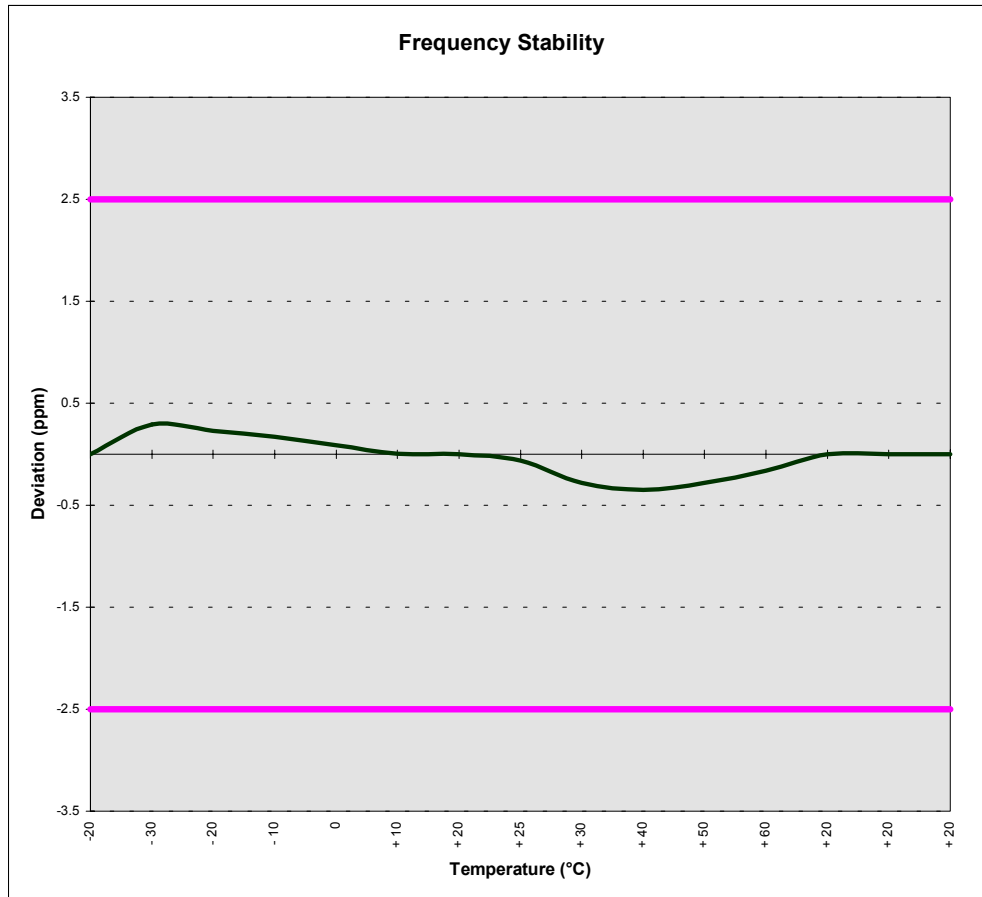

## 8.1 PLOT(S) OF EMISSIONS

---

SEE ATTACHMENT D

## 9.1 TEST EQUIPMENT

Type	Model	Cal. Due Date	S/N
Microwave Spectrum Analyzer	HP 8566B (100Hz-22GHz)	08/15/01	3638A08713
Microwave Spectrum Analyzer	HP 8566B (100Hz-22GHz)	04/17/02	2542A11898
Spectrum Analyzer/Tracking Gen.	HP 8591A (100Hz-1.8GHz)	08/10/01	3144A02458
Signal Generator*	HP 8640B (500Hz-1GHz)	06/03/02	2232A19558
Signal Generator*	HP 8640B (500Hz-1GHz)	06/03/02	1851A09816
Signal Generator*	Rohde & Schwarz (0.1-1000MHz)	09/11/01	894215/012
Alltech/Eaton Receiver	NM 37/57A-SL (30-1000MHz)	04/12/02	0792-03271
Alltech/Eaton Receiver	NM 37/57A (30-1000MHz)	03/11/02	0805-03334
Alltech/Eaton Receiver	NM17/27A (0.1-32MHz)	09/17/01	0608-03241
Quasi-Peak Adapter	HP 85650A	08/15/01	2043A00301
Alltech/Eaton Adapter	CCA-7 CISPR/ANSI QP Adapter	03/11/02	0194-04082
Gigatronics Universal Power Meter	8657A		1835256
Gigatronics Power Sensor	80701A (0.05-18GHz)		1833460
Signal Generator	HP 8648D (9kHz-4GHz)		3613A00315
Amplifier Research	5SIG4 (5W, 800MHz-4.2GHz)		22322
Network Analyzer	HP 8753E (30kHz-3GHz)		JP38020182
Audio Analyzer	HP 8903B		3011A09025
Modulation Analyzer	HP 8901A		2432A03467
Power Meter	HP 437B		3125U24437
Power Sensor	HP 8482H (30μW-3W)		2237A02084
Harmonic/Flicker Test System	HP 6841A (IEC 555-2/3)		3531A00115
Broadband Amplifier (2)	HP 8447D		1145A00470, 1937A03348
Broadband Amplifier	HP 8447F		2443A03784
Horn Antenna	EMCO Model 3115 (1-18GHz)	9704-5182	
Horn Antenna	EMCO Model 3115 (1-18GHz)	9205-3874	
Horn Antenna	EMCO Model 3116 (18-40GHz)		9203-2178
Biconical Antenna (4)	Eaton 94455/Eaton 94455-1/Singer 94455-1/Compliance Design 1295, 1332, 0355		
Log-Spiral Antenna (3)	Alltech/Eaton 93490-1		0608, 1103, 1104
Roberts Dipoles	Compliance Design (1 set)		
Alltech Dipoles	DM-105A (1 set)		33448-111
EMCO LISN (6)	3816/2		1079
Microwave Preamplifier 40dB Gain	HP 83017A (0.5-26.5GHz)		3123A00181
Microwave Cables	MicroCoax (1.0-26.5GHz)		
Alltech/Eaton Receiver	NM37/57A-SL		0792-03271
Spectrum Analyzer	HP 8594A		3051A00187
Spectrum Analyzer (2)	HP 8591A		3034A01395, 3108A02053
Microwave Survey Meter	Holaday Model 1501 (2.450GHz)		80931
Digital Thermometer	Extech Instruments 421305		426966
Attenuator	HP 8495A (0-70dB) DC-4GHz		
Bi-Directional Coax Coupler	Narda 3020A (50-1000MHz)		
Shielded Screen Room	RF Lindgren Model 26-2/2-0		6710 (PCT270)
Shielded Semi-Anechoic Chamber	Ray Proof Model S81		R2437 (PCT278)
Environmental Chamber	Associated Systems Model 1025 (Temperature/Humidity)		PCT285

\* Calibration traceable to the National Institute of Standards and Technology (NIST).

## 10.1 SAMPLE CALCULATIONS

---

### **A. ERP Calculation**

$$\text{Level } \mu\text{V/m @ 3 meters} = \text{Log}_{10}^{-1} \left( \frac{\text{dBm} + 107 + \text{AFCL}}{20} \right)$$

$$\text{Log}_{10}^{-1} \left( \frac{-14 + 107 + 31.7}{20} \right)$$

1717908.4  $\mu\text{V/m}$  @ 3 meters

Sample Calculation (relative to a dipole)

$$\text{ERP (dBm)} = 10 \text{Log}_{10} \left( \frac{(r(\mu\text{V/m})1 \times 10^6)^2}{49.2/1 \times 10^{-3}} \right)$$

$$\text{ERP (dBm)} = 10 \text{Log}_{10} \left( \frac{(3(1717908.4)1 \times 10^6)^2}{49.2/1 \times 10^{-3}} \right)$$

$$\text{ERP (dBm)} = 28.95$$

### **B. Emission Designator per §2.201**

CDMA Sample

2M + 2DK

CDMA BW = 1.25 MHz

F = Frequency Modulation

9 = Composite Digital Info

W = Combination (Audio/Data)

Emission Designator = 1M25F9W

## 11.1 CONCLUSION

---

The data collected shows that the **HYUNDAI Dual-Mode Cellular Phone FCC ID: PP4DX-20B** complies with all the requirements of Parts 2 and 22 of the FCC rules.