

Important Safety Notice

This product contains sensitive electronic components and may be damaged when dropped, crashed or exposed to water. DO NOT open or attempt to repair Xplorer by yourself, contact XIRO customer service or XIRO authorized dealer.

Key

Hints and Tips Warning or Important Definitions

LED key

OFF Blinking ON

Watch the Tutorial Video

Please watch the tutorial videos below to learn how to use Xplorer series correct and safely. <http://www.xirodrone.com/support>



Downloads

Scan QR code at the right side to download and install the XIRO app.



Register and Login

Access the Internet to register and login.

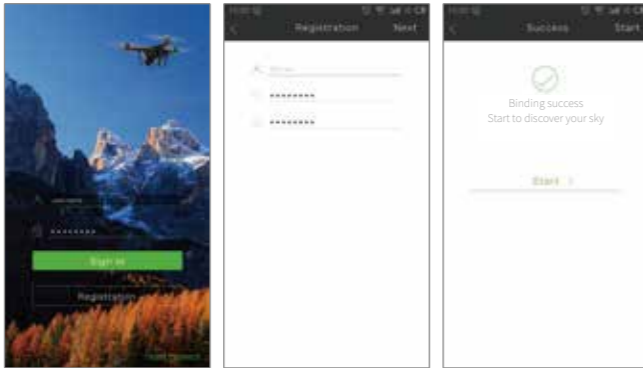

2 The Remote Control

- GPS Mode** More than 6 GPS satellites are found. The aircraft are ready to fly. Location based functions are enabled.
- Attitude Mode** Less than 6 GPS satellites are found. The aircraft are ready to fly (non GPS). Location based functions are not enabled.
- HOME Point** The position that the aircraft enters GPS mode.
- Return Home** Aircraft automatically return to HOME point and landed, return route: when the distance between HOME point and the return point is less than 25m or initial height is more than 20 meters, the aircraft fly back to home point at it current height and land. When the distance between HOME point and the return point is more than 25m and initial height is less than 20 meters, the aircraft first ascend to 20 meters and then fly back to home point and land.

3 Flight Level Selector

Flight Level	1	2	3
Flight Height (m)	50	120	120
Flight Distance (m)	100	300	Unlimited
Max.Horizontal Speed (m/s)	2	6	8
Max.Vertical Speed (m/s)	2	2	3
Attitude Mode	take off prohibited	✓	✓
GPS Mode	✓	✓	✓

Improper operation can lead to aircraft damage. A beginner should always select Level 1, in level 1 the aircraft can only take off in GPS mode. A beginner should operate the aircraft in an open area to make sure it can enter GPS mode.

Return Home button

Location based functions. Enabled only in GPS mode.
Press down to call back Xplorer to HOME point. Press up the button after Xplorer landing.

IOC button

Location based functions. Enabled only in GPS mode.
Press down to enter Intelligent Orientation Control mode. Aircraft will ignore its current nose orientation and use the HOME point as a reference, Push the stick forward: the aircraft will fly away along the extension line of the current position and the HOME point. Pull the stick backward: the aircraft will fly along connection line of the current position and HOME point to HOME point.

If you can not judge the nose of the aircraft when it is far away from you, using this function can be very convenient to fly the aircraft towards the HOME point.

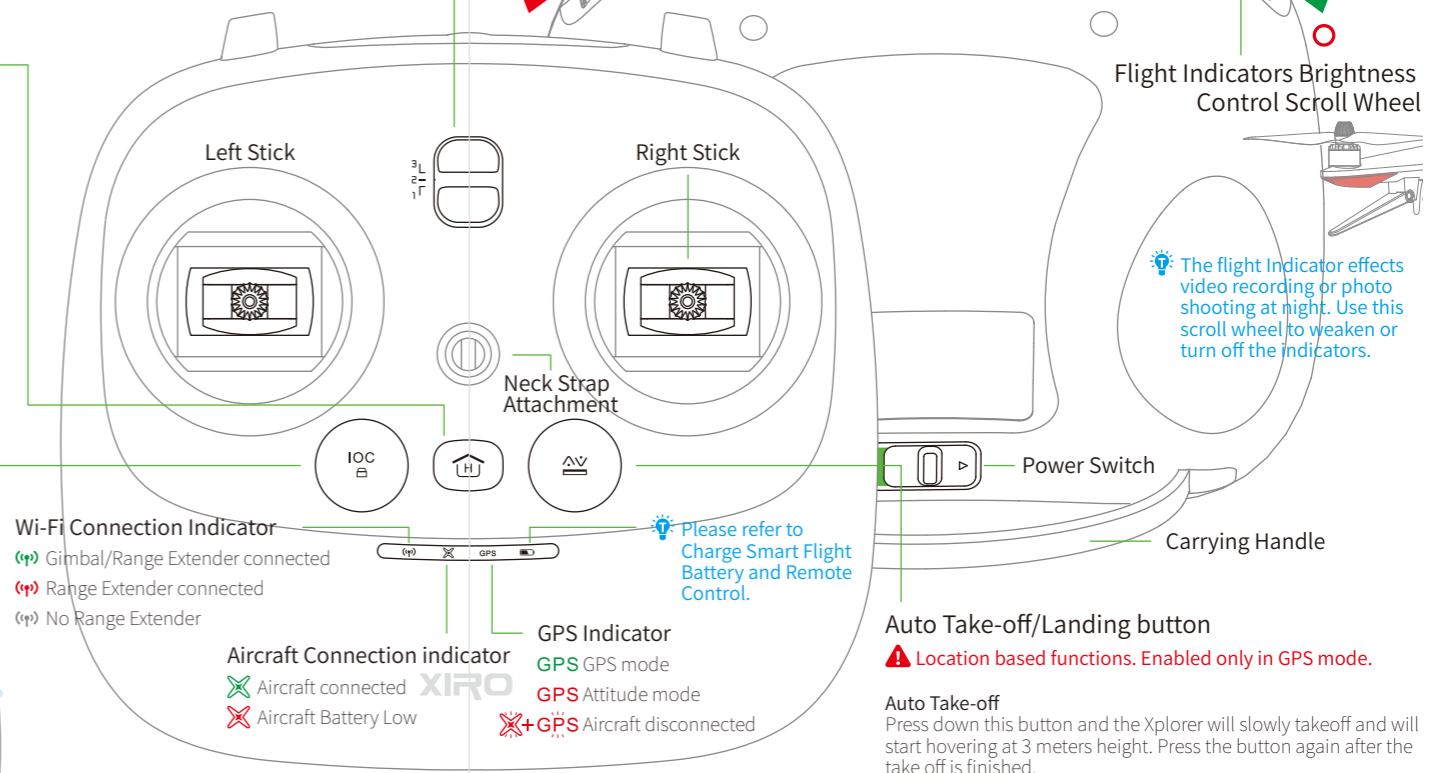

1 Charge Smart Flight Battery and Remote Control

Ensure Smart Flight Battery and Remote Control are fully charged before flying the Xplorer.

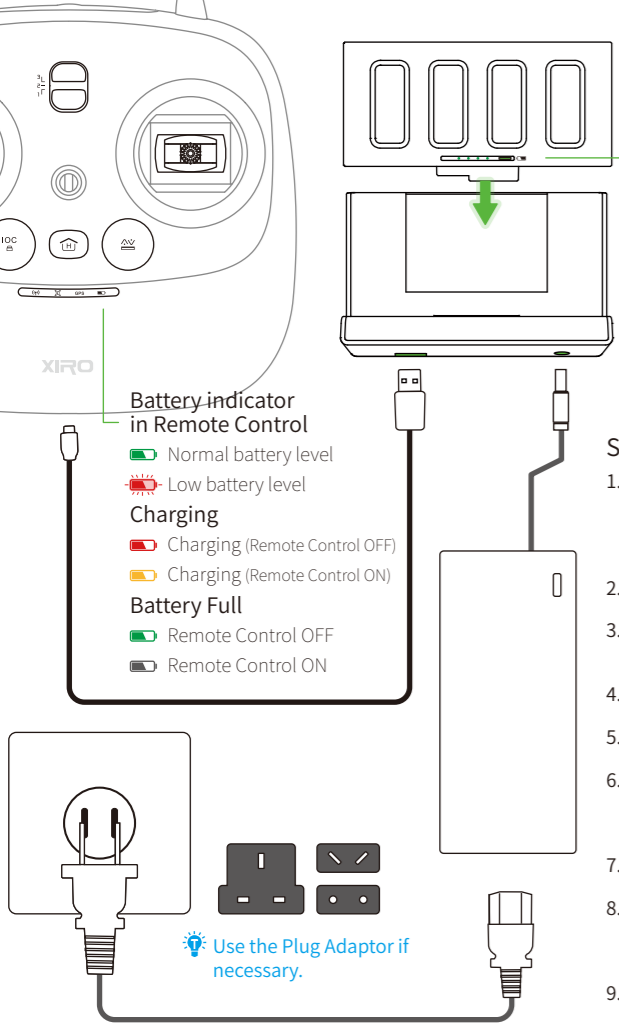
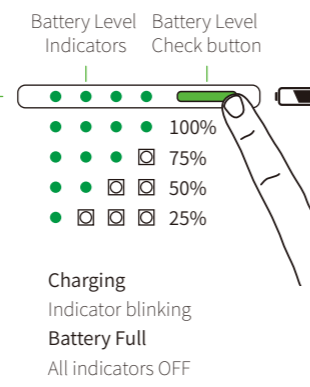

Smart Flight Battery Safety Guideline

- Use only XIRO batteries and Battery should only be charged with the charger provided by XIRO. XIRO does not take any responsibility for damage caused by third party battery or battery chargers. DO NOT charge battery immediately after flight.
- Purchase a new battery after your current battery has been discharged over 300 times.
- Never recharge a battery that is swollen or damaged in any way.
- For long term storage, make sure the battery is charged only 50% or less.
- Charge and discharge the battery completely once every 20 charge/discharge cycles. This power cycling procedure will optimize the battery life.
- Dispose of battery into specific recycling box after a complete discharge.
- If the electrolytes in the battery splash onto your skin or eyes, immediately wash with fresh water for at least 15 minutes and then see a doctor.
- Put out battery fire using sand or dry powder extinguisher. DO NOT use water.

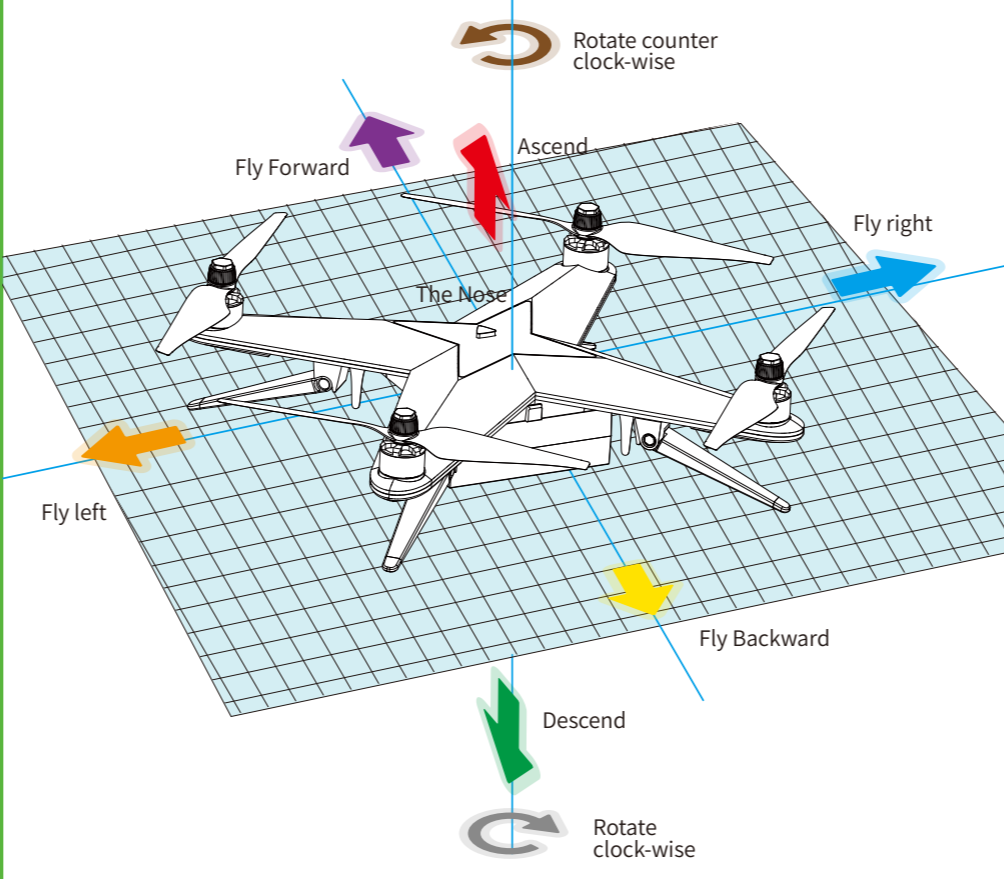

Install Range Extender * For Xplorer V/P only

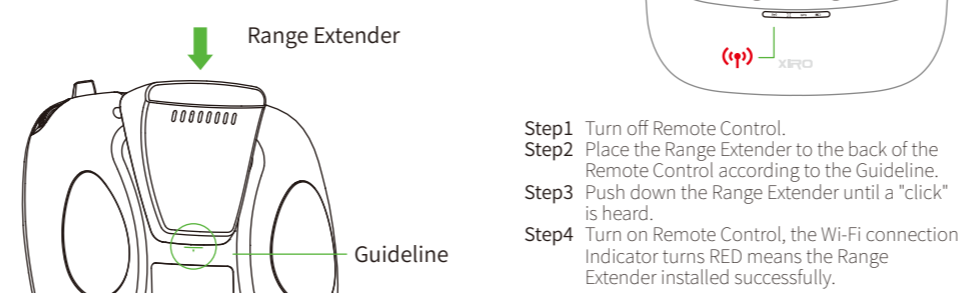

- Turn off Remote Control.
- Place the Range Extender to the back of the Remote Control according to the Guideline.
- Push down the Range Extender until a "click" is heard.
- Turn on Remote Control, the Wi-Fi connection Indicator turns RED means the Range Extender installed successfully.

Remote Control Operation

The Remote Control is set to Mode 2 by default. If this setting is inconsistent with your previous usage, please refer to "Change Remote Control Operation Mode" for your habitual mode.

Stick Neutral/mid point

Control stick are placed at the central position.

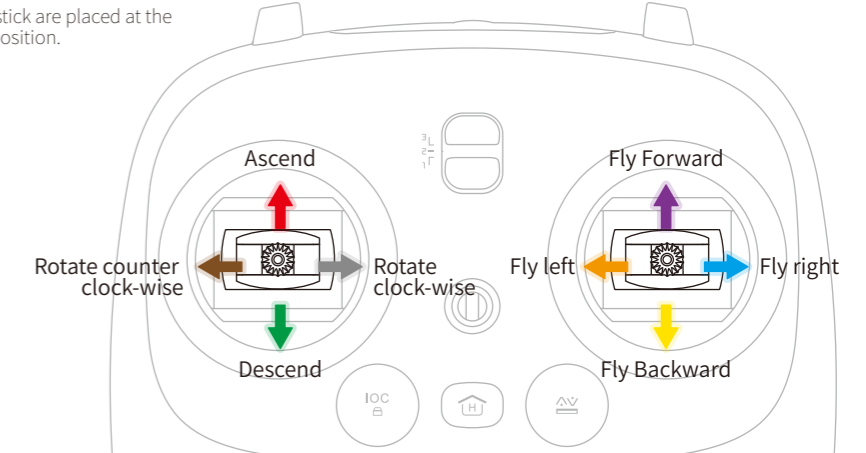

Change the Remote Control Operation Mode

Ignore this step if your remote has the right settings for you and if you don't want to switch the functionality of the sticks from left hand to right hand.

- Power OFF Remote Control.
- Push the stick as right figure and hold.
- Turn ON remote control. The Remote Control now is in Operation Mode Configuration Mode, release the stick when the current setting is displayed.
- Press down/up the "return home" button until the indicators show your desired operation mode.
- Turn OFF remote Control to finish the configuration.

The Remote Control will store the settings.

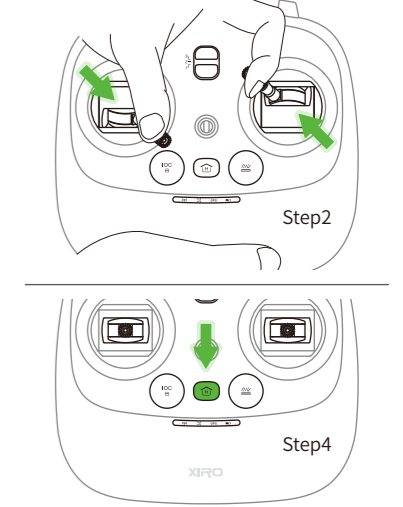

The Remote Control can be charged by PC or USB charger.

Please read the user manual and battery warnings before use. The users takes full responsibility for all operations and usage.

3 The Xplorer

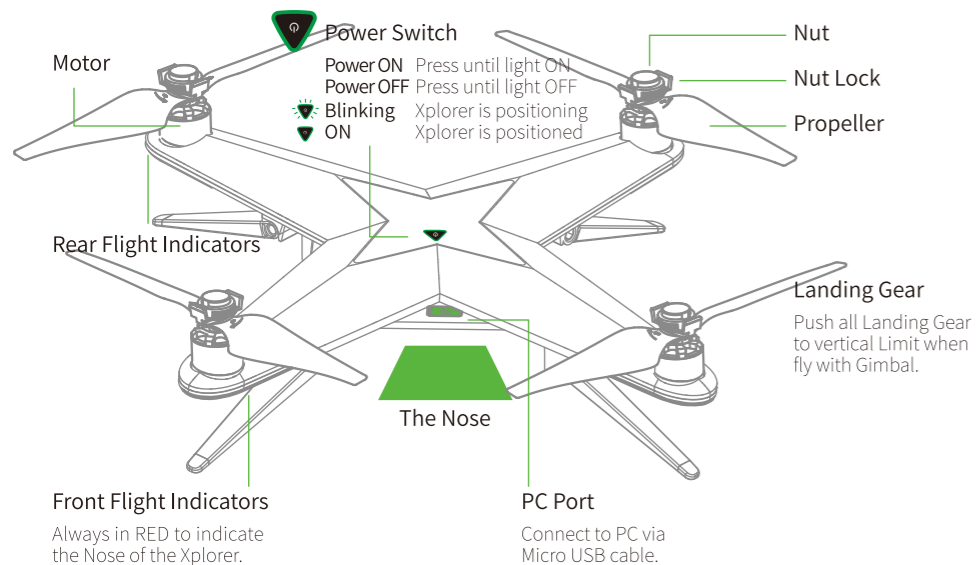

Install Smart Flight Battery to aircraft

- Step1** Place the battery on back of the aircraft according to the guideline.
- Step2** Push battery forward until a "click" is heard.

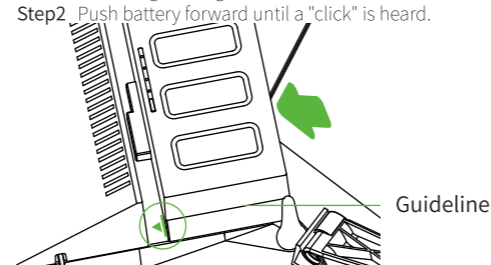

⚠️ Push the battery backward to make sure the battery doesn't slide.

Remove Smart Flight Battery from aircraft.

- Step1** Push the Battery Lock Button UP.
- Step2** Push the battery backward.

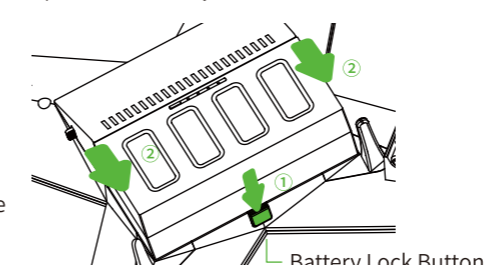

Removing the Propellers

- Step1** Remove the Nut Lock. **Step2** Hold the end of propeller and use hand or the included wrench to loosen the nut. **Step3** Remove the propellers.

- ⚠️ 1. Check that propellers are installed firmly and the Nut Lock is already installed before every flight.**
- 2. Do not use broken propellers.**
- 3. Stand clear of and Do not touch propellers when these are spinning.**
- 4. Put on a glove when installing or removing the propellers.**

4 Flight

Flight Environment Requirements.

- Do not use the aircraft in severe weather conditions. These include wind speeds exceeding cat.4, snow, rain and smog.
- Fly in open fields as high buildings or steel structures may affect the accuracy of the compass onboard.
- Keep the Xplorer away from obstacles, crowds, high voltage power line, trees and water during flight.
- The Xplorer can not fly within polar areas.
- Do not fly your Xplorer within no-fly zones specified by local laws and regulations.

⚠️ Do not execute this SCC during normal flight, This will stop motors and cause the aircraft to drop.

Starting Motors

- Step1** A Stick Combination Command (SCC) as show in the right side figure is used to start the motors instead of pushing the stick up.
- Step2** Once the motors have started, release both sticks simultaneously.

Stopping Motors

- Step1** The Motors will stop if the same SCC as starting motors is conducted when Motors are spinning. The Motors will auto stop after landing on the Ground.
- Step2** Once the motors have stopped, release both sticks simultaneously.

Flight Test

- Step1** Place Xplorer with the smart flight battery facing towards you in an open area.
- Step2** Select a suitable flight level.
- Step3** Power ON the Remote Control.
- Step4** Power ON the aircraft.
- Step5** Wait until the Rear Flight Indicator blinks in Green (GPS mode) or in Yellow (Attitude Mode).
- Step6** Calibrate Compass.
- Step7** Start Motors.



Make sure the aircraft was placed in a safe and open area. DO NOT point the nose to user.



The user should keep over 5 meters distance from the aircraft when taking off.

Taking off and Landing in GPS mode

Taking off Press the "Auto take off/landing" button down, the Xplorer will take off. Press the button up again after take off.

Landing Hover over a level surface, press the "Auto takeoff/landing" button down, the Xplorer will descend and land. Press the button up again after landing.

💡 You can move the sticks to change hovering or landing position when the aircraft is automatically taking off or landing.

Taking off and Landing in Attitude mode

Taking off Push the throttle up slowly to take off.

Landing Pull down the throttle down slowly to descend. Motors stop automatically after landing.

- ⚠️ 1. If the Flight Level is selected to 1, the aircraft can not take off in Attitude mode (Rear Flight Indicator blinking in Yellow)**
- 2. DO NOT carry Gimbal in Test Flight or Training flight.**

Advance Flight Skill Training

Run XIRO APP, enter the setting- instruction Manuals - Advanced Flight Training Guide, improve your flight skills in subsequent flights using the Training Guide.

The Lost Connection protection function

In GPS Flight Mode

When the aircraft loses connection with the Remote Control in GPS flight mode. It will hover in the position where the connection was lost and try to be reconnected. If the connection is not restored within 15 seconds, the aircraft will automatically return to the HOME point.

💡 If the aircraft is reconnected when flying back to the HOME point, It will stop the Return Home procedure and it will start hovering over the reconnected point, the user will have full control of aircraft again.

In Attitude Flight Mode

When the aircraft loses connection with Remote Control in Attitude flight mode, it might drift away when the connection is lost, and it will try to be reconnected. The aircraft will start to descend slowly when the battery power gets low.

💡 The user can move with the Remote Control towards to the flight direction if the connection with the aircraft is lost in the Attitude Flight Mode. The connection may re-established when the distance is shortened.

Low Battery Level Warning function

Low Battery Level warning

The aircraft will trigger the Low battery warning when 30% of the battery capacity is left.

Remote Intermittent vibration, The Aircraft indicator turns RED.

Aircraft APP The Rear Flight Indicator blinking slowly in RED. A warning message will appear.

💡 The user can call back the Xplorer by pressing down the "Return Home" button when the battery runs low.

Critical Low Battery Level

The aircraft will trigger the low battery warning at 10% of battery capacity.

Remote Continuous vibration, The Aircraft indicator turns RED.

Aircraft The Rear Flight Indicators start blinking quickly in RED and the aircraft will begin to descend and land automatically.

Compass Calibration

- ⚠️ 1. Make sure to calibrate the compass when flying on a new location. The compass is very sensitive to electromagnetic interference, which can cause abnormal compass data leading to a poor flight performance. Regular calibration of the compass is required for optimal performance.**
- 2. DO NOT calibrate the compass when in an area with strong magnetic interference, for parking structures or areas with steel reinforcement underground.**
- 3. DO NOT carry ferromagnetic materials with you when calibrating the compass.**
- 4. DO NOT calibrate the compass next to massive metal objects.**

Calibration Procedures

Step1 Place the aircraft on a horizontal surface and power ON the aircraft.

Step2 Wait until the Rear Flight Indicator blinks in Green (GPS mode) or in Yellow (Attitude Mode). Pull down the throttle to its lowest position and hold, Press down/up the "IOC" button in 3 cycles. The Rear Indicator will turn to solid green indicating that you can start the calibration now.

Step3 720°rotate the aircraft horizontally until the Rear Flight Indicators turns to fast blinking in yellow.

Step4 The rear flight indicators should stay solid green while rotating, until these start blinking yellow fast.

Step5 720°rotate the aircraft vertically (Nose downward) until the Rear Flight Indicators turns to slow blinking in Green or Yellow. You need to keep the Rear Flight Indicator in solid yellow when rotating.

5 Gimbal

* For Xplorer V/P only

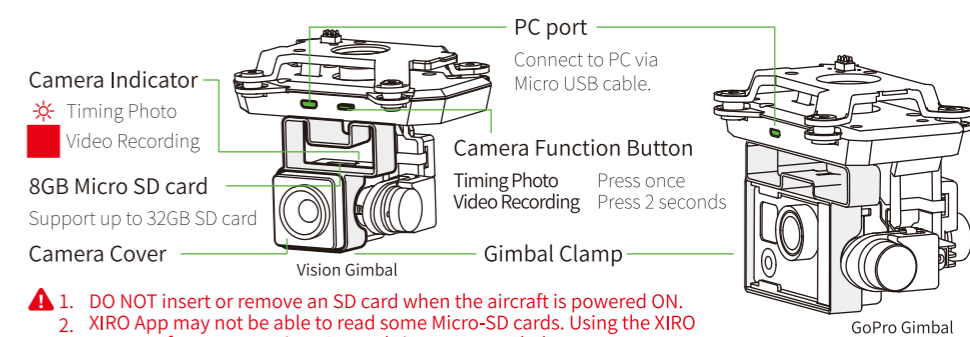

- ⚠️ 1. DO NOT insert or remove an SD card when the aircraft is powered ON.**
- 2. XIRO App may not be able to read some Micro-SD cards. Using the XIRO App to reformat new Micro-SD cards is recommended.**
- FPV Mode** Gimbal will lock to the movements of the aircraft for a FPV experience.
- Non FPV Mode** The gimbal will stabilize through 3-axes for smooth aerial shooting.

Install the Gimbal to aircraft

⚠️ Gimbal is a sensitive and expensive device. DO Not install the gimbal to the aircraft until you are skilled in controlling the aircraft.

- Step1** Put the Landing Gear in horizontal limit and remove Smart Flight Battery.
- Step2** Remove the front cover.
- Step3** Insert the Gimbal to the slot at the left side.
- Step4** Push the right side of the gimbal until a "click" is heard.

- Step5** Install the Smart Flight Battery and put the landing gear in the vertical limit.
- Step6** Remove Gimbal clamp.

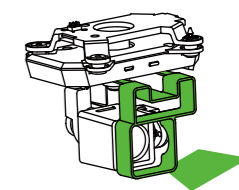

- Step7** Power ON the Remote Control.
- Step8** Power On the Aircraft.

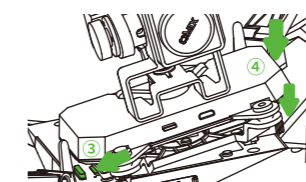

💡 The Wi-Fi connection indicator turns GREEN when Gimbal is connected to the Range Extender.

Gimbal Power On Check

If a gimbal motor error is detected or the gimbal clamp is not removed after the power is switched on, there will be a warning prompt on the camera page of the XIRO App.

- ⚠️ 1. Remove the Gimbal Clamp before turning on the aircraft's power.**
- 2. Flying in heavy fog or clouds may make the gimbal wet, leading to a temporary failure. The Gimbal will function normal again after drying.**

Connecting the Camera

- Step1** Power ON the Remote Control.
- Step2** Power ON the aircraft.
- Step3** Wait until the Wi-Fi connection indicator turns GREEN.
- Step4** Enable Wi-Fi in your mobile device, wait for 30 seconds, and then select "Xplorer XXXX" from the Wi-Fi Network List.
- Step5** Run the XIRO app on your mobile device.
- Step6** Tap the "Camera" icon and the XIRO App will begin a live camera preview. This means the whole system is functioning normally.

Rename Range Extender SSID

Rename your Range Extender SSID for easy memory.

Declaration of Conformity / 安规声明

Any Changes or modifications not expressly approved by the party responsible for compliance could void the user's authority to operate the equipment.

This device complies with part 15 of the FCC Rules. Operation is subject to the following two conditions: (1) This device may not cause harmful interference, and (2) this device must accept any interference received, including interference that may cause undesired operation.

FCC Radiation Exposure Statement:

This equipment complies with FCC radiation exposure limits set forth for an uncontrolled environment.

This Aircraft and Vision Gimbal should be installed and operated with minimum 20CM between the radiator&your body.

This transmitter must not be co-located or operating in conjunction with any other antenna or transmitter.

IC RSS Warning

This device complies with Industry Canada licence-exempt RSS standard (s). Operation is subject to the following two conditions: (1) this device may not cause interference, and (2) this device must accept any interference, including interference that may cause undesired operation of the device.

Le présent appareil est conforme aux CNR d'Industrie Canada applicables aux appareils radio exempts de licence.

L'exploitation est autorisée aux deux conditions suivantes:

- (1) l'appareil ne doit pas produire de brouillage, et
- (2) l'utilisateur de l'appareil doit accepter tout brouillage radioélectrique subi, même si le brouillage est susceptible d'en compromettre le fonctionnement.

IC Radiation Exposure Statement:

This equipment complies with IC RF radiation exposure limits set forth for an uncontrolled environment. This transmitter must not be co-located or operating in conjunction with any other antenna or transmitter.

This Aircraft and Vision Gimbal should be installed and operated with minimum 20CM between the radiator&your body.

Any Changes or modifications not expressly approved by the party responsible for compliance could void the user's authority to operate the equipment.

产品中有毒有害物质或元素的名称及含量 根据中国《电子信息产品污染控制管理办法》

飞机套装						
有毒有害物质或元素						
部件名称 Parts	铅 (Pb)	汞 (Hg)	镉 (Cd)	六价铬 (Cr(VI))	多溴联苯 (PBB)	多溴二苯醚 (PBDE)
电缆 Cable	○	○	○	○	○	○
电路板组件 PWAs	○	○	○	○	○	○
塑料部件 Plastic Parts	○	○	○	○	○	○
金属部件 Metal Parts	○	○	○	○	○	○
橡胶部件 Rubber Parts	○	○	○	○	○	○
电源组件 Power Parts	○	○	○	○	○	○
磁铁 Magnetic Part	○	○	○	○	○	○

○ = 表示该有毒有害物质在该部件所有均质材料中的含量均在 SJ/T 11363-2006 标准规定的限量要求以下。
x = 表示该有毒有害物质至少在该部件的某一均质的含量超出 SJ/T 11363-2006 标准规定的限量要求。
表中标有“x”的所有部件都符合欧盟 RoHS 指令 2011/65/EU 及其修正指令。
注：环保使用期限的参考标取决于产品正常工作的温度和湿度等条件。

补偿

在保质期内，您享有以下售后权利

- (1) 7 天内出现质量问题，根据国家“三包”规定于产品外观与包装完整的情况下，将硬件退还给购买地点或者雷柏指定地点，凭购买的有效凭证，退回您所支付的硬件产品货款。
- (2) 60 天内出现产品质量问题，您可以到购买地点或者雷柏指定地点更换硬件产品，或者到雷柏指定的维修网点保修，更换之后的硬件保质期为质保期的剩余天数。
- (3) 1 年内出现产品质量问题，您可以到雷柏指定的维修网点保修。

质保限制

本有限质保不涵盖由于以下原因导致的问题或损坏：

- (1) 意外事件、误用、操作不当或任何未授权的维修、改装或者拆卸；
- (2) 操作或维护不当，使用过程中违反产品说明或连接到不适当的电压源；
- (3) 或者适用并非由雷柏提供的消耗品（如备用电池），但适用法律禁止此类限制的情况除外。但足万一发生此类情况，您可以选择有偿维修服务。

Safety instructions

Do not open or repair this product.
Do not use the product in a damp environment.
Clean the product with a dry cloth.

安全提醒

请不要打开或修理本产品。
请不要在潮湿的环境使用本产品。
请用干布擦拭本产品。

保修服務卡

保修期限	
购买日期	
购买地点	
产品序列号	
商品编号	
盖章	

备注：请将各条填写清楚，请勿擅自涂改，并妥善保管好本保修服务卡，以维护您的合法权益。如需服务或有任何疑问，请咨询当地经销商或与我们联系。

* 以上信息仅适用于中国大陆 *

NCC 警告語

根據低功率電波輻射性電機管理辦法規定：

第十二條 經型式認證合格之低功率射頻電機，非經許可，公司、商號或使用者均不得擅自變更頻率、加大功率或變更原設計之特性及功能。

第十四條 低功率射頻電機之使用不得影響飛航安全及干擾合法通信；經發現有干擾現象時，應立即停用，並改善至無干擾時方得繼續使用。前項合法通信，指依電信法規定作業之無線電通信。低功率射頻電機須忍受合法通信或工業、科學及醫療用電波輻射性電機設備之干擾。



Copyright

It is forbidden to reproduce any part of this quick start guide without the permission of Rapoo Technology Co., Ltd.

知识产权信息

未经雷柏的许可，禁止复制本快速开始指南的内容。

Warranty

The device is provided with one year limited hardware warranty from the purchase day. Please see www.xirodrone.com for more information.

质保条款

本设备提供自购买之日起 1 年的有限产品硬件保修服务，具体详情请查询 www.xirodrone.com。

日期	维修情况