

# MTP41S User Manual

Wideband Wireless  
Professional Pocket  
Transmitter

SN: \_\_\_\_\_

Rev.04 (rif. FW 1.30.OP)

Date: 19 April 2018



## INTRODUCTION

"MTP41S is an extremely small and light pocket transmitter especially designed for professional wireless microphone applications"

Very easy and quick to use thanks to OLED display, dedicated buttons and a joggle selector.

MTP41S benefits also of the latest Wisycom RF technology along with an enhanced robustness against noise and inter-modulation.

Fig. 1



### Turn on wireless:

Move the Wireless **power switch** in "I" position:

A green blinking gives you indications on battery status.

### Turn on display:

Push <select switch> and hold it.

### Open MIC Body:

Push the side buttons and flip down the cover, to access internal setup controls and batteries.

- 1 Switch to enable wireless transmission it also indicates the battery status and peak/mute operation (with PTT)
- 2 LED to show information on RF transmission/battery status/modulation peak/PTT status
- 3 OLED display for transmitter setup
- 4 <ch>, <gain> and 3 positions <selector>
- 5 Battery holder
- 6 Cover (to open push side buttons)



Fig. 2

---

## **SAFETY INSTRUCTION**

---

- Read this safety instruction and the manual first
- Follow all instructions and information.
- Do not lose this manual.
- Do not use this apparatus under the rain or near the water.
- Do not install the apparatus near heaters or in hot environments, do not use outside the operating temperature range.
- Do not open the apparatus, only qualified service technician are enabled to operate on it. The apparatus needs servicing when it is not properly working or is damaged by liquids, moisture or other objects are fallen in the apparatus.
- Use only accessories or replacement parts authorized or specified by the manufacturer.
- Clean the apparatus only with dry cloths, do not use liquids.
- Report the serial number and the purchasing date in front of the manual. It is needed to have proper replacement parts or accessories from the manufacturer.
- When replacement parts are needed, use only replacement parts authorized from the manufacturer. Substitution with not authorized parts could result in electric shock, hazards or fire.
- Keep attention on all the labels with warnings or hazards on the apparatus.

## LED INDICATIONS

LED indication with LED RGB (red, green, blue) in front led (2):

- Wireless transmission status: **Green** when RF transmission power is on (on power on the device, this LED is **red** and become green when the RF transmission power is on).
- Battery status: **green** steady, slowly blinking (< 25%), quickly blinking (<12%).
- Modulation peek (if activated and the limiter is disabled): **red**.
- Ptt status: **red** if active (push to talk “pushed”).
- Limiter in action (if activated): **blue**.

## BATTERIES

MTP41S is working with 1 AA alkaline or NiMH or Lithium batteries (select correct type on setup controls). Battery status can be checked on internal OLED display or looking the LED status on front (2).

### BATTERY SUBSTITUTION

- Open transmitter cover and insert the battery following polarity indicated.

## ANTENNAS

MTP41S is supplied with a couple of antennas. According to the working band, different antenna models can be supplied. All the models have black cap and a black label with code in white colour. For more details see the below table.



Band	Range (MHz)	Code
1	470-547	507
	547-640	590
2	566-672	616
	672-798	732
3	510-595	552
	595-698	646
8	940-960	950

**Ant: 590**

In order to help the user to connect the correct antenna, the display shows the antenna code during the switch on of the transmitter and during the tuning selection after a change of frequency range. (ex. if the user changes the frequency from 566 to 672 MHz, the display shows Ant. 732)

## POWERING UP

Move the wireless power switch (see Fig. 1) in “I” position to activate wireless transmission: the front LED **2** lights up red and then green when the RF transmission power is on (blinking when battery is low!)

## SETUP CONTROL

Open transmitter Body to access the “display and controls” area (Fig. 3):

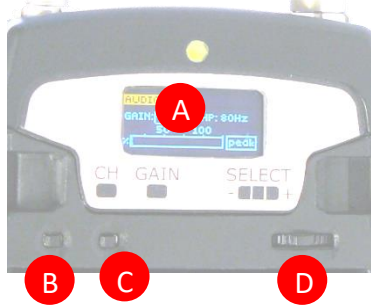

- A.** Graphics Display (**OLED**)
- B.** Channel selection buttons (**ch**)
- C.** MIC gain setup buttons (**gain**)
- D.** 3 position selector (**up / down / click**)

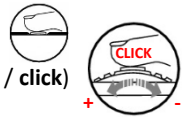

Fig. 3

## OLED Power UP (OLED IS IN OFF CONDITION)

Pushing down selector (**click**), oled turns on. A first menu with Serial Number and brand logo is displayed, then <status> menu enters automatically.

Turn on the transmitter pushing and holding selector (**click**) > 2 sec, Serial Number menu is displayed till (-/+ ) is selected.

## OLED Power DOWN (OLED IS IN ON CONDITION)

Pushing and holding selector (**click**) > 2 sec, display is turned off.

Display turns off automatically after 15 sec, unless in <AUDIO> menu (with audio level < 5% from nominal).

## DISPLAY MENU

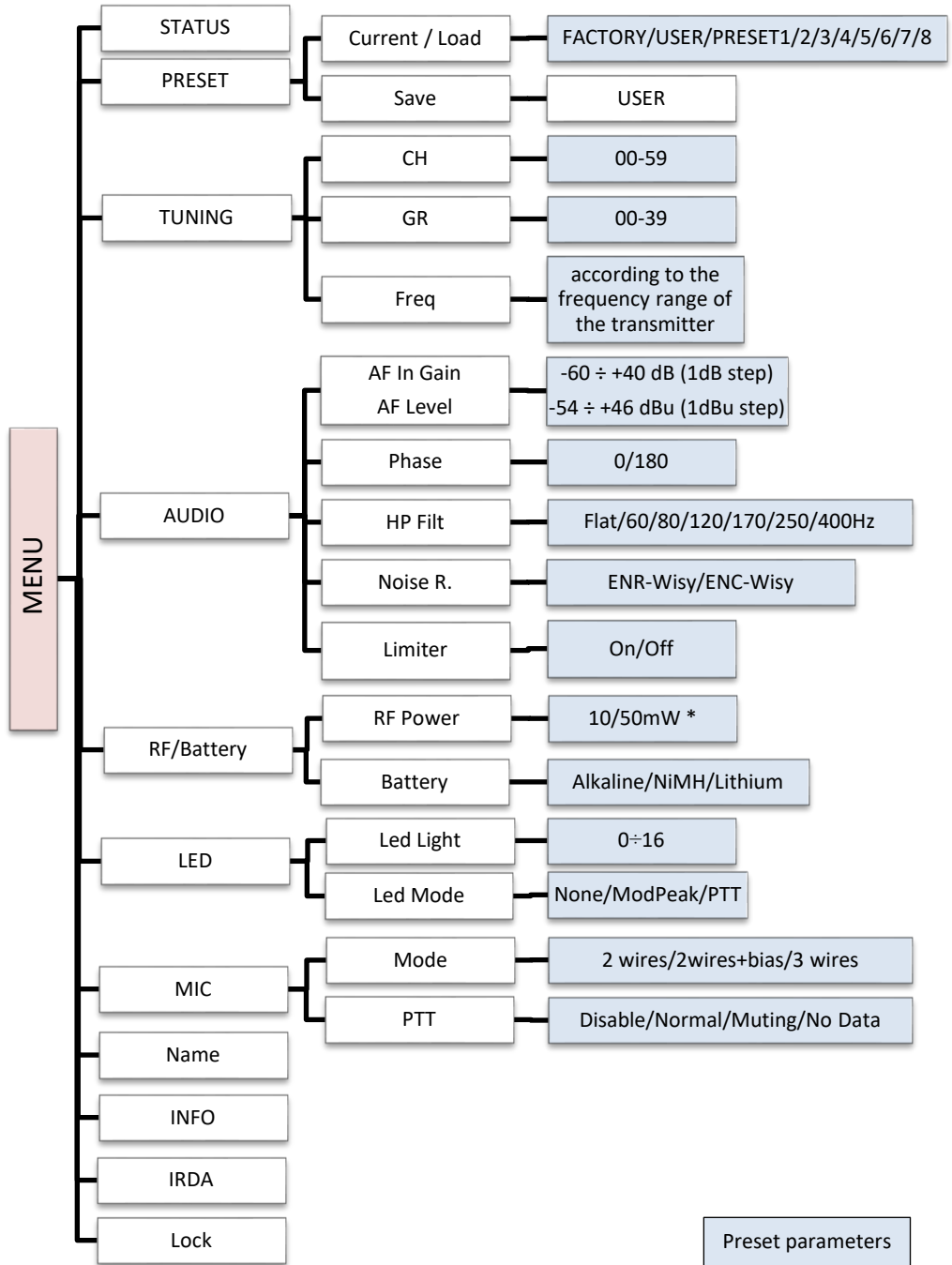

Preset parameters

\* Depending on the Power Profile

Using <+/-> selector all menus can be accessed in sequence, push <click> to enter edit mode:



<+/-> to setup field

<click> again to confirm changes and exit.

**exit without confirmation** if no button is pressed after a few seconds time out.

### <START UP> menu

These menus are displayed during power up for few seconds.

	<p>First one gives information of antenna to be used. The number displayed is the center-band of the antenna to be used.</p>
	<p>The second menu gives indication on product:</p> <ul style="list-style-type: none"> <li>- product id (MTP41),</li> <li>- the firmware release (ex. 1.30.0A),</li> <li>- the band in extended format and</li> <li>- the serial number.</li> </ul> <p><b>Keep selector pushed to hold this menu!</b></p>

### <STATUS> menu

This is the first menu displayed after power up.

	<p>Major info are displayed:</p> <ul style="list-style-type: none"> <li>- Current channel/group (i.e. CH:00 GR:39)</li> <li>- Current frequency (i.e. 566.000 MHz)</li> <li>- Mic gain (i.e. AF: +00dB) and high pass filter (i.e. HP:60 Hz)</li> <li>- If in the top right there is "RF 50" or "RF 10", the transmission is active respectively at 50mW or 10mW</li> <li>- On left side, the battery bar is displayed</li> </ul>
--	-----------------------------------------------------------------------------------------------------------------------------------------------------------------------------------------------------------------------------------------------------------------------------------------------------------------------------------------------------------------------------------------------------------------------------------

### <PRESET> menu

This menu can be entered by scrolling selector

	<p>MTP41S can recall configuration presets. "FACTORY" recalls the Wisycom factory configuration. "USER" recalls the user configuration (the transmitter configuration is copied into the USER using the "save to" submenu). All "USER" menus are not locked by default, thus this is quick way to unlock features! When the user changes some parameters from the PRESET configuration (for less than frequency) an asterisk appears on the top-right corner until a save command is executed.</p>
--	--------------------------------------------------------------------------------------------------------------------------------------------------------------------------------------------------------------------------------------------------------------------------------------------------------------------------------------------------------------------------------------------------------------------------------------------------------------------------------------------------------------------

*The other 8 configuration presets are user programmable thru the infrared and the PC interface (using the programmer UPK 300/UPKMini or the receiver MRK950/MRK960).*



*We provide the device with some preset configurations specifically designed for certain types of microphone or applications (it's possible to change these presets in any time using the TX manager). All parameters can be "left unchanged", "changed" or "changed and lock", allowing a very flexible way to pre-program MTP41S configuration.*

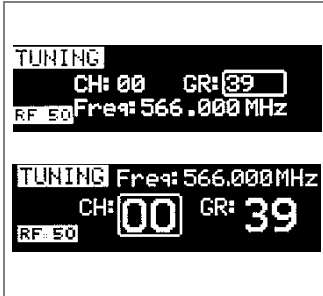

## <TUNING> menu

This menu can be entered by scrolling selector or using *quick channel setup* buttons (<ch>).

	<p>In this menu current channel/group and frequencies can be setup. The name of the group is shown on the top right of the display. Sync group is a quick self-settable channel synchronized by receiver (with SYNC group, on the top right of the display is shown the name of the synchronized receiver). Use the selector to change values (&lt;+/-&gt;) and &lt;click&gt; to confirm.</p> <p>Using quick channel setup buttons (&lt;CH&gt;), it is possible to enter quickly in the tuning menu. Note that the menu has a different layout (see the side image)</p>
----------------------------------------------------------------------------------	-------------------------------------------------------------------------------------------------------------------------------------------------------------------------------------------------------------------------------------------------------------------------------------------------------------------------------------------------------------------------------------------------------------------------------------------------------------------------------------------------------------------------------------------------------------------------

## <AUDIO> menu

In the AUDIO menu are shown all the audio parameters (this menu can be entered by pushing <+/->).

	<p>The sensitivity of the audio input is settable between “AF Gain” (measured in dB) or “AF Level” (measured in dBu). To help proper audio gain setting, an audio bar is supplied (with maximum peak indicator) indicating the headroom to audio peak (0 dB , nominal deviation 40KHz). <i>Set the gain, with the maximum input signal, avoiding the peak on the audio bar.</i></p> <p><b>TRY TO SETUP TO HAVE A MAX PEAK HOLD BAR CLOSE TO -6dB.</b></p> <p>Using quick gain setup buttons (&lt;GAIN&gt;), it is possible to enter quickly in the audio gain menu. Note that the menu has a different layout (see the side image)</p>
	<p>The second &lt;AUDIO&gt; menu allows to set:</p> <ul style="list-style-type: none"> <li>- Audio phase: 0° or 180°</li> </ul> <p><b>Note:</b> Since common “2-wires + bias” microphones invert the phase, when the MIC mode of the transmitter is set to “2wires+ bias”, the phase is automatically inverted and so the complete system (MTP4x+MIC) has 0° phase (an asterisk appear on the display near the phase to indicate that the phase was inverted).</p> <ul style="list-style-type: none"> <li>- High Pass Filter: applies different audio HP filter: Flat/ 60Hz/ 80Hz/ 120Hz/ 170Hz/ 250Hz/ 400Hz.</li> </ul>
	<p>The third &lt;AUDIO&gt; menu allows to set:</p> <ul style="list-style-type: none"> <li>-Noise reduction: <ul style="list-style-type: none"> <li>• ENR: designed for maximum noise reduction</li> <li>• ENC: designed for maximum audio fidelity (use this in case of special vocal application or to remote instruments)</li> </ul> </li> <li>-Limiter: if is set “On”, an input audio signal above the peak threshold (<i>up to 30 dB above peak</i>) is not cut but attenuate, <u>without lost quality</u>. The limiter acts as a variable attenuator (thanks to the feedback system), maintaining a distortion &lt;3%. <ul style="list-style-type: none"> <li>• When the limiter intervene, the front led turns blue.</li> </ul> </li> </ul> <p>If this parameter is set “Off”, the limiter is disable.</p>



**<RF/BATTERY> menu**

This menu can be entered by scrolling selector.

	<p>RF power can be setup to 50mW, 20mW or 10mW according to the power profile. Use the Battery menu to select the type of battery used. MTP41S support Alkaline/NiMH/Lithium battery type.</p>
----------------------------------------------------------------------------------	----------------------------------------------------------------------------------------------------------------------------------------------------------------------------------------------------

**<LED> menu**

This menu can be entered by scrolling selector.

	<p>Led Light allows to change the brightness of the front led (0÷16) . Led Mode: - <u>None</u>: allows to disable modulation peak LED on front led (the red light) - <u>ModPeak</u>: allows to enable modulation peak LED on front led (become RED when audio get close to saturation when the limiter is not enable) - <u>PTT</u>: allows to enable RED color on front led when PTT button is pushed.</p>
----------------------------------------------------------------------------------	----------------------------------------------------------------------------------------------------------------------------------------------------------------------------------------------------------------------------------------------------------------------------------------------------------------------------------------------------------------------------------------------------------------------------

**<MIC> menu**

This menu can be entered by scrolling selector.

	<p><b>Mode:</b> Following Mic mode can be setup (for LEMO option) - <b>2 wires:</b> (PTT is possible) for external audio input - <b>2 wires + bias:</b> (PTT is possible) for most 2 wires MIC - <b>3 wires:</b> (no PTT) for most 3 wires MIC</p>
<p><b>PTT</b> setting defines how and what information the transmitter has to send in normal use or when the PTT button is pushed:</p> <ul style="list-style-type: none"> <li>- <b>Disable:</b> when the PTT button is pushed, nothing happen. (the transmitter sends AF+Tone squelch)</li> <li>- <b>Normal:</b> when the PTT button is pushed, the transmitter send a different RF signal. According to the receiver configuration the audio can be enabled/disable on LINE (and/or COM).</li> <li>- <b>Muting:</b> the transmitter doesn't send the audio. The voice is cut, it doesn't enter to the microphone</li> <li>- <b>No Data:</b> the transmitter sends neither tone squelch nor battery data.</li> </ul> <p>Use the selector to change values (&lt;+/-&gt;) and &lt;click&gt; to confirm.</p>	

**NOTE:** For DPA option (2 pin microdot audio connector), even if the MIC mode menu allows to set one of the 5 MIC modes, only **2 wires** or **2 wires+bias** mode are possible.

**<NAME> menu**

This menu can be entered by scrolling selector.

	<p>In this menu it's possible to see the frequency set on the device and the name of the transmitter. It's possible to enter on this menu also pressing at the same time the CH/GAIN buttons (<b>B+C</b>)</p>
------------------------------------------------------------------------------------	-------------------------------------------------------------------------------------------------------------------------------------------------------------------------------------------------------------------

## <INFO> menu

This menu can be entered by scrolling selector.

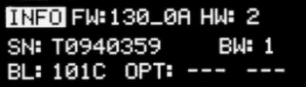
	In this menu it's possible to see: <ul style="list-style-type: none"><li>- FW version</li><li>- HW version</li><li>- Serial number</li><li>- Bandwidth</li><li>- Bootloader version</li><li>- Option</li></ul>
----------------------------------------------------------------------------------	----------------------------------------------------------------------------------------------------------------------------------------------------------------------------------------------------------------

## <IRDA> menu

This menu can be entered by scrolling selector.

	While there is this menu, the device can be connected to IRDA for setup or firmware upgrades. <u>Note: if the IRDA interface is enabled and there's no communication for around 10 seconds, the IRDA interface is automatically turned off.</u>
----------------------------------------------------------------------------------	----------------------------------------------------------------------------------------------------------------------------------------------------------------------------------------------------------------------------------------------------

*On power on the device, the IRDA interface is enabled for 14 seconds.*

## <LOCK> menu

This menu can be entered by scrolling selector.

	Long pressing (2 sec.) selector button ( <b>click</b> ) it locks MTP41S in transmission mode. To unlock, long pressing (2 sec.) selector button again.
----------------------------------------------------------------------------------	-----------------------------------------------------------------------------------------------------------------------------------------------------------

## <BOOTLOAD> menu

This menu can be entered by turning on the transmitter while pushing **at the same time** both quick channel setup buttons (<ch> & <gain>) or connecting the device via IRDA using the IR Programmer for FW update

	Device is forced in bootloader mode to allow <b>FIRMWARE UPDATE</b> .
------------------------------------------------------------------------------------	-----------------------------------------------------------------------

The following table sums up which parameters can be set and the related range settings.

MENU	PARAMETER	MEANING	RANGE SETTINGS
TUNING	CH	Channel	0 ÷ 59
	GR	Group	0 ÷ 39 + SYNC GROUP
	Freq	Frequency	depends on the MTP41S Model, see technical spec. and variants for further details
AUDIO	AF In Gain	Gain of the audio signal	-60dB ÷ +40dB step of 1dB
	AF Level		-54dBu ÷ +46dBu step of 1dBu
	Phase	Audio signal phase	0° or 180°
	HP Filt.	High Pass filter	Flat/60/80/120/170/250/400 Hz
	Noise R.	Noise reduction	ENR: Wisycom Extended-NR, noise optimized ENC: Wisycom Extended-NC, voice optimized
Limiter	Limiter	On/Off	
RF/BATTERY	RF Power	RF Power	50mW / 20mW / 10mW (depending on the power profile)
	Battery	Battery type	Alkaline / NiMH / Lithium
LED	Led Light	Power switch green brightness	0 ÷ 16
	Led Mode	It defines when the power switch led (see Fig. 3) has to become RED	None: never ModPeak: when audio get close to saturation PTT: when the PTT button is pushed
MIC	Mode	MIC type	'2 wires' '2 wires + bias' '3 wires'
	PTT Mode	It defines how and what information the transmitter has to send	<b>Disable:</b> when the PTT button is pushed, nothing happen. (the transmitter sends AF+Tone squelch). <b>Normal:</b> when the PTT button is pushed, the transmitter send a different RF signal. According to the receiver configuration the audio can be enabled/disable on LINE (and/or COM). <b>Muting:</b> the transmitter doesn't send the audio. The voice is cut, it doesn't enter to the microphone. <b>No Data:</b> the transmitter sends neither tone squelch nor battery data.

MIC Mode setting (only for LEMO option):

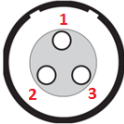
MIC Mode:	Pin out	Gain	PTT	Led Mode
'2 wires':	 1=GND 3=AF	-60/40 dB	Disable Normal Muting No data	None Mod. Peak PTT
'2 wires + bias':	1=GND 3=AF+5.5V	-60/40 dB	Disable Normal Muting No data	None Mod. peak PTT
'3 wires':	1=GND 2=5.5V 3=AF	-60/40 dB	Disable No data	None Mod. peak

### 3 PIN LEMO CONNECTOR

(use FVB.00.003.NLN on Mic)

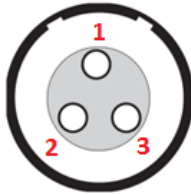

## HOW TO USE WISYCOM TX MANAGER

Wisycom TX Manager allows to read, modify and update the configuration of Wisycom transmitters. It is necessary to

- connected the programmer UPK300E/UPKΜίμί or the receiver MRK950/MRK960 to the PC thru **USB connection**
- run the Wisycom TX Manager
- enable the IRDA communication on the transmitter (see IRDA menu)

NOTE: Wisycom IR Programmer doesn't work whit MRK950/MRK960 if it is connected to the PC using an Ethernet cable.

The Wisycom IR Programmer's window is divided in 4 parts (see the image below):

- 1 Interface and Device panel** contains all the major information of the connected device
- 2 Current Settings panel** shows the current configuration. Thanks the PRESET panel, a previous saved configuration can be chosen and loaded like current setting.
- 3 Tuning Frequencies panel** allows to handle Groups, Channels and Frequencies
- 4 Presets panel** allows to read, change and save different configurations

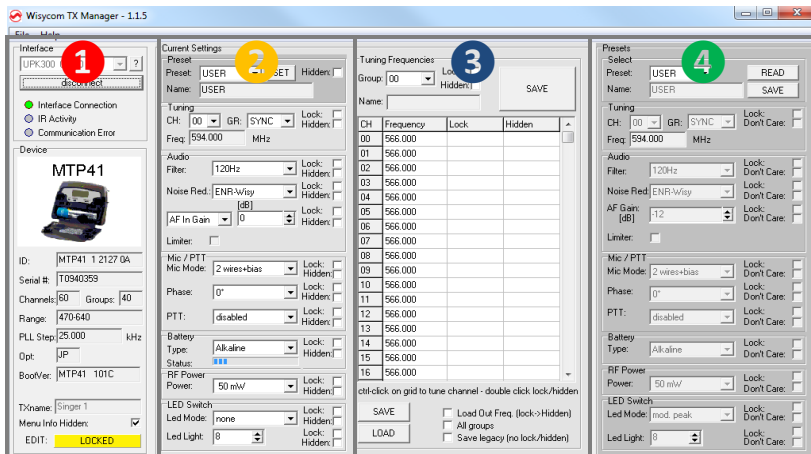

10 different configurations are available:

- FACTORY configuration is a locked configuration: no parameter can be changed.
- USER configuration is the only configuration that can be saved using the OLED display (see <PRESET> menu). Note: It is not possible to change the name of this configuration.
- Other 8 configurations where the user can change both the name and the values of all parameters.

## INTERFACE AND DEVICE PANEL (1)

At the beginning, the program checks which IR devices are detected and they appears on the **Interface** panel.

The user has to select the device and push <connect> button in order to open the communication with the IR device. A picture on the top in the Interface panel help the user in this selection showing the type of devices detected. During this process the “IR activity” led blinks to indicate that the program wait connection’s answer from the IR device.

A successful connection is signaled with the “interface connection” green led, while a failed connection is signaled with the “communication error” led.

Once a supported device is found, the software automatically reads all the data related to the remote configuration, as well as the frequencies that are pre-programmed.

Firstly, in order to avoid unwanted operation, no parameters can be changes and the EDIT button, presents on the bottom of **Device** panel, is yellow and set to **LOCKED** state. Pushing the EDIT button, it becomes grey and sets to **UNLOCKED** state to indicate that the configurations can be modified.

In this panel it’s possible to assign a name to the TX (not available for FW v.1.22.0F or previous). Under this parameter, there is a flag to hide the info menu on the TX (not available for FW v.1.22.0F or previous)

## CURRENT SETTINGS PANEL (2)

In the Current Settings panel the user can

- with Preset panel → load one of the 10 available configurations
- with other panels → modify all the configuration’s parameters (the same that are changeable in the OLED display). Each parameter can be locked or hidden clicking the related lock/hidden button, so the set value cannot be changed next or cannot be visible on the OLED display.



Preset			
Preset:	USER	SET	Hidden: <input type="checkbox"/>
Name:	USER		

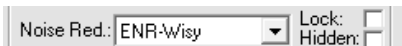

Noise Red.:	ENR-Wisy	Lock: <input type="checkbox"/>
		Hidden: <input type="checkbox"/>

ATTENTION: All the modifies applied to the Current Settings panel are instantaneous: they are applied directly to the device and save in its memory but no saved in the preset configuration.

## TUNING FREQUENCIES PANEL (3)

With the Tuning Frequencies panel the user can select a frequencies group (0=39) and for each one execute the following operations:

- modify the Group's Name
- lock and/or hidden the group
- for each channel (0 ÷59) of the selected group: change the frequency value and the related status (locked/hidden) (in the center grid frequency)

The SAVE button, at the top of the panel, save the changes of the group selected (name group, lock/hidden group).



To change a frequency value for a specific channel: double click on the grid frequency panel (row=channel's number), insert the new frequency value and press OK button.

1 double click

2 insert freq. value

3 press OK

CH	Frequency	Lock	Hidden
00	630.000		
01	630.000		
02	630.000		
03	630.000		
04	630.000		
05	630.000		
06	630.000		
07	630.000		
08	630.000		
09	630.000		
10	630.000		
11	630.000		
12	630.000		
13	630.000		
14	630.000		
15	630.000		

ctrl-click on grid to tune channel - double click lock/hidden

CH	Frequency	Lock	Hidden
00	630.000		
01	630.000		
02	630.000	lock	
03	630.000		hidden

double click to LOCK the channel

double click to HIDE the channel

To lock/hide a specific channel, double click on the grid frequency panel.

NOTE: keeping pressed the CTRL button on the keyboard and clicking the wanted channel/group shown on the frequencies grid, the tuning process is executed. It is equivalent to configure the Tuning in the Current Settings panel but it is easier. The device is re-tuned immediately, so be sure that the RF power is turned off while changing frequencies with other RF systems in use around you!

If the currently tuned channel is on the same group that is listed on the grid, the background color of the related cell (channel) on the grid becomes yellow.

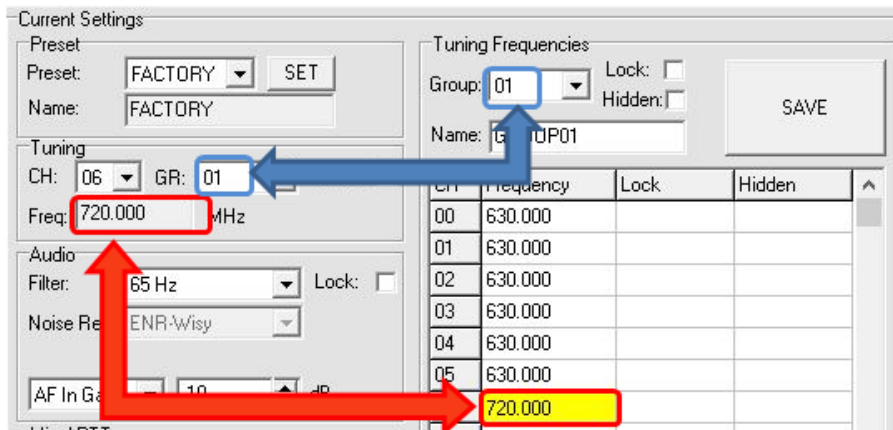

Using the LOAD/SAVE button, at the bottom of the panel, it is possible to **load/save** the frequencies for the selected group from/to a .wdf file. To save the frequencies of all the groups click to the related button above. The legacy option save the channels without the hidden/lock info.





## PRESETS PANEL ( 4 )

The Preset panel allows to manage all the 10s available configurations.

For each configuration it is possible to set the name and all the parameters value except for FACTORY and USER configurations (see table below).

PRESETS:	NAME*	LOCK/DON'T CARE	PARAMETERS VALUE
FACTORY			
USER			√
OTHERS	√	√	√

√=change is allowed

\* Be careful to write a meaningful name for the preset because the name will appear on the settings list of the device menu! Please, avoid empty names.

If a parameter is “locked”, it cannot be modified by device menu (using OLED display), while if “don’t care” propriety is active, when the user load the configuration, the parameter’s value doesn’t changed.

**ATTENTION: Changes are applied only after a “save” action.**

NOTE: “a trick” In case of the user have a locked parameter and he is in great need for modify it, he can save the configuration to USER configuration by OLED (see PRESET menu) and then load the USER configuration (in this way all the parameters have the lock propriety disable and the user can modify all the parameters).

## FILE MENU

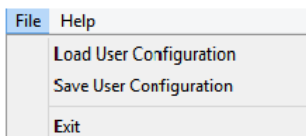

Using a file menu at the top left of the panel it is possible to **load/save all the configuration** values of the device to/from a .wcf file (Wisycom Configuration File).

### Save a .wcf file

With an infrared device correctly connected, select File->Save User Configuration and select the destination file.

### Load a .wcf file

To load a user configuration select File->Load User Configuration and select a previously saved data file; a form will be shown, where it's possible to select which data has to be restored and which skipped. This allow the user to load a particular configuration while keeping other data.

## TECHNICAL SPECIFICATIONS

<b>Switchable channels</b>	2400 allocated by 40 groups of 60 channels (in specific frequency range), quickly selectable with dedicated buttons
<b>Switching window</b>	Up to 232 MHz, depending on band (see <i>Variants</i> on the next page)
<b>Frequencies</b>	Quartz PLL frequency synthesizer circuit (25 kHz step)
<b>Frequency stability</b>	▪ $\pm 2,5$ ppm (in the rated temperature range)
<b>Temp.range</b>	-10 $\div$ +55 °C
<b>Max RF power</b>	▪ 10mW (ERP) (to respect some local norm) ▪ 20mW/50mW (ERP) (note: in some countries middle power can be disabled, for local norm!)
<b>Spurious emissions</b>	< 2 nW
<b>Modulation</b>	wideband FM with pre-emphasis
<b>Nominal deviation</b>	$\pm 40$ kHz (Peak deviation = $\pm 56$ kHz)
<b>Telemetry feature</b>	MTP41S transmits also a digitally modulated sub-carrier, suitable for: ▪ <i>tone-squelch operating</i> ▪ <i>remote battery monitoring</i> ▪ <i>optional PTT (push to talk) operation</i>
<b>AF input connector LEMO option</b>	Configurable on 'mic' display menu in 3 options: ▪ '2 wires': gain selectable -60 $\div$ +40 dB (-54 dBu $\div$ +46 dBu peak), no bias voltage ▪ '2 wires + bias': gain selectable -60 $\div$ +40 dB (-54 dBu $\div$ +46 dBu peak), 5.5 V on 4k7 bias supply ▪ '3 wires': gain selectable -60 $\div$ +40 dB (-54 dBu $\div$ +46 dBu peak)
<b>AF input level</b>	100 dB adjustable range from -54 dBu (775 $\mu$ V) to 46 dBu (15.5 V) at peak deviation (1 kHz), adjustable in 1 dB steps
<b>Max. input level</b>	+46 dBu (15.5 V) at clipping, +20 dBu (7.75 V) at nominal level
<b>Noise-Reduction</b>	ENR (Wisycom Extended-NR), with independent Attack- and Recovery-time, noise optimized ENC (Wisycom Extended-NC), with independent Attack- and Recovery-time, voice optimized & with reduced pre-emphasis
<b>AF bandwidth</b>	▪ 45 Hz $\div$ 21 KHz (3dB) ▪ 55 Hz $\div$ 20 KHz (1dB)
<b>Distortion</b>	< 0.3 % (0.15 % typ.)
<b>Signal-to-noise ratio</b>	▪ typ. 115 dB (A) <sub>rms</sub> with 40 kHz deviation ▪ typ. 121 dB (A) <sub>rms</sub> with 56 kHz deviation
<b>Led</b>	Led indication with bicolor led (red & green) on wireless power switch: ▪ Wireless transmission status: GREEN on/off ▪ Modulation peek (if activated & the limiter is disabled): RED ▪ Battery lifetime status: GREEN - <u>steady</u> (> 25%) - <u>slowly blinking</u> (< 25%) - <u>quickly blinking</u> (<12%) ▪ Ptt status: RED if active ▪ Limiter into action: Blue
<b>Display</b>	High contrast OLED (Organic light-emitting diode) bicolor display (96 x 36 pixels) 8 step battery lifetime indication: 7 <u>bars</u> (100%-87%-75%-63-50%-38%-25%) and " <u>empty bar</u> " quickly blinking (12% remaining)
<b>PTT function</b>	Pin 3 of the AF connector can be setup to an external push button
<b>Power supply</b>	1 AA size batteries (Alkaline, rechargeable NiMH, Lithium)
<b>MTP41S Battery life</b>	▪ approx. 11 hours @ 50mW continuous working Lithium ▪ approx. 8 hours @ 50mW continuous working with NiMH ▪ approx. 4.5 hours @ 50mW continuous working with Alkaline
<b>Dimensions</b>	58.2 x 64.5 x 21.7 mm (Height-Width-Depth)
<b>Weight</b>	Approx. 80 g. without batteries (120g with batt.)

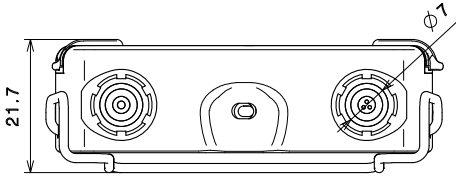

Note: unit is mm

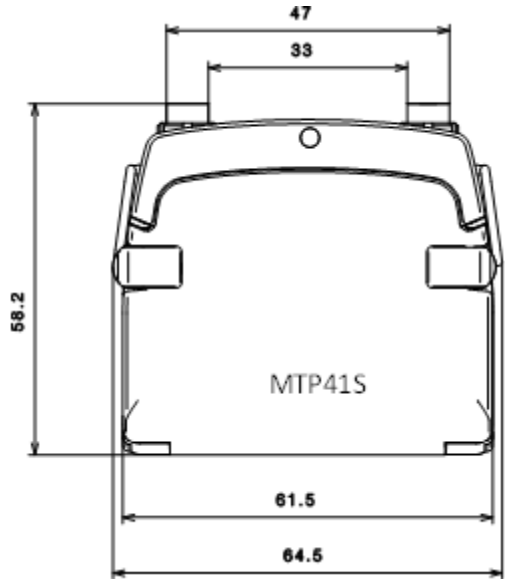

## **POWER PROFILE & COUNTRY**

### **FREQUENCY RANGE:**

- EU** max power 50mW (Europe)
- US** max power 50mW (USA)
- JP** max power 10mW (Japan)
- NZ** max power 50mW (New Zealand)
- AU** max power 50mW (Australia)
- CN** max power 50mW (China)
- US8** max power 50mW (USA)

### **VARIANTS:**

#### **• AUDIO CONNECTOR**

- LM** 3 PIN LEMO CONNECTOR
- DP** 2 PIN DPA MICRODOT CONNECTOR





#### **• COLOR**

- BL** color black (powder coating)

#### **• FREQUENCY RANGE**

- B5** 470-654 MHz
- B2** 566-798 MHz
- B3** 510-698 MHz
- B8** 510-698 MHz

## Compliance

<b>Model</b>	<b>In Compliance with</b>	<b>Max Power</b>	<b>Country</b>
<b>MTP41S-EU</b>	EN 301 489-1/-9 EN 600065 EN 300 422-1/-2	50mW	Europe CE
<b>MTP41S-US</b>	 PART 74 FCC-ID: <b>POUMTP41</b> <b>RSS-123, RSS-102</b> IC: <b>11967A-MTP41</b>  Limited to 698MHz	50mW	USA, Canada
<b>MTP41S-US8</b>	 PART 74 FCC-ID: <b>POUMTP41SUS8</b> <b>RSS-123, RSS-102</b> IC: <b>11967A-MTP41SUS8</b>  Limited to 941.50-952.00MHz, 952.85-956.25MHz, 956.45-959.85MHz	100mW	USA, Canada
<b>MTP41S-JP</b>	  <b>202-LSD045</b>  Limited to 714 MHz  MIC marking identifier can be found in the battery compartment.	10mW	Japan
<b>MTP41S-NZ</b>	EN 300 422-1/-2 EN 300 454-1/-2  Limited to the range 502÷698MHz	50mW	New Zealand
<b>MTP41S-AU</b>	Limited to the range 520÷694MHz	50mW	Australia



**Before putting the device into operation, please observe the respective country-specific regulations!**

---

## MANUFACTURER DECLARATIONS

---

### In compliance with the following requirements

- RoHS Directive (2002/95/EC)



- WEEE Directive (2002/96/EC)

Please dispose of the diversity transmitter at the end of its operational lifetime by taking it to your local collection point or recycling center for such equipment



- Battery Directive (2006/66/EC)

The supplier batteries or rechargeable batteries can be recycled. Please dispose of them as special waste or return them to your specialist dealer. In order to protect the environment, only dispose of exhausted batteries.

### **Obblighi di informazione agli utilizzatori**

ai sensi dell'art. 13 del Decreto Legislativo 25 luglio 2005, n. 151 "Attuazione delle Direttive 2002/95/CE, 2002/96/CE e 2003/108/CE, relative alla riduzione dell'uso di sostanze pericolose nelle apparecchiature elettriche ed elettroniche, nonché allo smaltimento dei rifiuti"

#### **Smaltimento di apparecchiature elettriche ed elettroniche di tipo professionale**



Il simbolo del cassonetto barrato riportato sull'apparecchiatura o sulla sua confezione indica che il prodotto alla fine della propria vita utile deve essere raccolto separatamente dagli altri rifiuti.

La raccolta differenziata della presente apparecchiatura giunta a fine vita è organizzata e gestita dal produttore. L'utente che vorrà disfarsi della presente apparecchiatura dovrà quindi contattare il produttore e seguire il sistema che questo ha adottato per consentire

la raccolta separata dell'apparecchiatura giunta a fine vita.

L'adeguata raccolta differenziata per l'avvio successivo dell'apparecchiatura dismessa al riciclaggio, al trattamento e allo smaltimento ambientalmente compatibile contribuisce ad evitare possibili effetti negativi sull'ambiente e sulla salute e favorisce il reimpiego e/o riciclo dei materiali di cui è composta l'apparecchiatura.

Lo smaltimento abusivo del prodotto da parte del detentore comporta l'applicazione delle sanzioni amministrative previste dalla normativa vigente.

#### **Smaltimento batterie usate**



Questo prodotto può contenere batterie. Questo simbolo apposto sulle batterie significa che non possono essere smaltite insieme a normali rifiuti domestici, bensì devono essere depositate negli appositi punti di raccolta delle batterie.

Iscrizione al Registro A.E.E. n. IT0910000006319

## EC DECLARATION OF CONFORMITY

### DICHIARAZIONE DI CONFORMITA' DECLARATION OF CONFORMITY

Il sottoscritto, rappresentante il seguente costruttore  
*The undersigned, representative of the following manufacturer*

WISYCOM S.r.l.  
via Spin, 156 - 36060 Romano d'Ezzelino (VI) - Italy

DICHIARA che l'apparecchiatura descritta in appresso:

*DECLARES that the product:*

Descrizione <i>Description</i>	Pocket transmitter
Modello <i>Model</i>	MTP41S

è conforme alle disposizioni legislative che traspongono le seguenti direttive:

- direttiva 2004/108 CE (Direttiva EMC)
- direttiva 2006/95 CE (Direttiva Bassa Tensione)
- direttiva 99/5 CEE (Direttiva Apparecchiature Radio)

*is in accordance with the following Directives:*

- 2004/108 EC Directive (EMC Directive)
- 2006/95 EC Directive (Low Voltage Directive)
- 99/5 EEC (Radio Equipment Directive)

e che sono state applicate tutte le norme e/o specifiche tecniche di seguito indicate  
*and that all the following standards have been applied*

EN 60065:2002 + A1:2006 + A11:2008 + A2:2010 + A12:2011

EN 301 489-1 V1.9.2

EN 301 489-9 V1.4.1

EN 300 422-2 V1.3.1

Luogo Romano D'Ezzelino  
*Place*

Data 14 January 2015  
*Date*

Firma Franco Maestrelli  
*Sign*  
(nome e funzione)  
*(name and title)*

AMMINISTRATORE UNICO

WISYCOM s.r.l.

Via Spin, 156 - 36060 Romano D'EZZ. (VI)  
Tel. + 39 0424 382505 - Fax +39 0424 382733  
sales@wisycom.com - www.wisycom.com  
P. IVA (VAT) / C.F. IT 02765640244



# WISYCOM™

VOX INFRAGILIS

Via Spin 156 • I-36060 Romano d'Ezzelino • Italy  
Tel. +39 -0424 -382605 • Fax +39 - 0424 - 382733  
[www.wisycom.com](http://www.wisycom.com) • e-mail: [sales@wisycom.com](mailto:sales@wisycom.com)

