

# MTK952 User Manual

Dual Transmitter

Mono - Stereo - Intercom

Modulation



SN: \_\_\_\_\_

rev.09 (ref. FW 2.3)

Date: 22 October 2018

## BRIEF DESCRIPTION

MTK952 is a versatile dual transmitter capable of working in a huge UHF bandwidth and of generating any kind of narrow-band modulations, with very high quality and low spurious emissions.

### Main features:

- 330 MHz Bandwidth (470 MHz – 800 MHz)
- 2400 user-defined frequencies (40 group by 60 freq.)
- Stereo, mono, intercom audio modulation
- Output power up to 2 Watt (/W option)
- Analogue & digital input (AES3)
- Redundant power supply 230/110 Vac & 12 VDC
- DSP audio processing (40bit floating point / 2Gflops) with multi-companding
- Direct Digital Synthesis (DDS) of signal for the highest flexibility and quality (> 70 dB stereo separation) SWR (Stationary Wave Ratio) sensing on antenna outputs

Above a schematic with the functional diagram of one transmitter of MTK952.

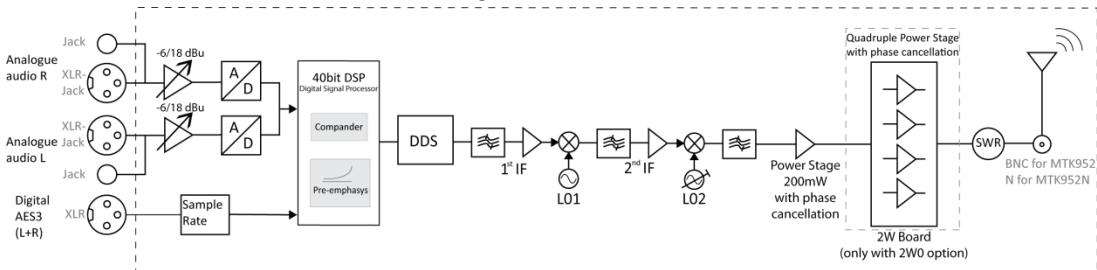

MTK952 use extreme technologies like:

#### ✓ Direct Digital Synthesizer (DDS)

DDS is a type of frequency synthesizer used for creating arbitrary waveforms from a single, fixed-frequency reference clock. A DDS has many advantages over its analog counterpart, the phase-locked loop (PLL), including much better frequency agility, improved phase noise, and precise control of the output phase across frequency switching transitions. The Direct Digital Synthesis (DDS) technology can generate virtually any kind of modulation while keeping an absolute phase accuracy.

#### ✓ Double conversion stage

Using a double conversion and saw filter at IFs (intermediate frequencies) we can achieve a very low spurious emission and a great bandwidth agility (330 MHz).

#### ✓ Intermodulation cancelling power amplifiers

PA module (power amplifiers) is designed with an exclusive circuitry that reduce the intermodulation generated by external carriers using a wideband phase cancelling design.

#### ✓ Digital audio with Shark™ DSP 40bit floating point & 2 Gflops power from Analog Device

A very powerful Analog Design Shark DSP processor manages the audio with very low delay (< 1 ms) and emulates by software all companding and pre-emphasis effects.

---

## SAFETY INSTRUCTION

---

- Read this safety instruction and the manual first
- Follow all instructions and information.
- Do not lose this manual.
- Do not use this apparatus under the rain or near the water.
- Do not install the apparatus near heaters or in hot environments, do not use outside the operating temperature range.
- Mount the apparatus as indicated in the instruction, do not block side grids for air ventilation
- **ATTENTION:** supply the apparatus with a correct mains voltage and with the ground connection. Check the power cord integrity.
- The power cord must be protected from damage
- Do not install the apparatus near heaters or in hot environments, do not use outside the operating temperature range.
- Do not open the apparatus, only qualified service technician are enabled to operate on it. The apparatus needs servicing when it is not properly working or is damaged by liquids, moisture or other objects are fallen in the apparatus.
- Use only accessories or replacement parts authorized or specified by the manufacturer.
- Clean the apparatus only with dry cloths, do not use liquids.
- The ON/OFF is a double pole circuit breaker, but to ensure the complete disconnection of the apparatus, disconnect the power cord.
- Report the serial number and the purchasing date in front of the manual. It is needed to have proper replacement parts or accessories from the manufacturer.
- When replacement parts are needed, use only replacement parts authorized from the manufacturer. Substitution with not authorized parts could result in electric shock, hazards or fire.
- Keep attention on all the labels with warnings or hazards on the apparatus.

**WARNING!** The apparatus is intended for professional use; anyway the manufacturer alerts the user that the headphone output power of the apparatus could exceed the level of 85 dB(A) of sound pressure level and this could be dangerous for the hearings. Do not use the headphone with high power level or for long time. Reduce the power or suspend the hearing in case of any kind of hearing problem.

# QUICK START INSTRUCTION

1. Connect to the power outlet using the supplied power cable (see [rear panel](#): connector 1)
2. Attach the antennas to the antenna out BNC connections (N connectors for MTK952N) (see [rear panel](#): connectors 8 and 13)
3. Connect the audio sources to the relative audio input connectors (see rear [rear panel](#): connectors 7 for digital audio sources, connectors 9÷12 for analog audio sources)  
NOTE: the cascade configuration allows to use the same analog audio input for more transmitter
4. Power on the MTK952
5. Switch off the RF output:
  - a. While the MTK952 is powering on and the progress bar appears, push the 3<sup>rd</sup> button at the bottom (see indication "OFF" on the display)
  - b. At the end of MTK952 power on, push the lower button on the right of the displays
6. Enter in the **MAIN>Audio source** menu and
  - a. configure the **input** parameter between *digital* and *analog* (according to the audio source connected at point 3)
  - b. configure the **AF level meter** parameter as *modulation*
  - c. if digital audio source:
    - leave **audio gain left** and **right** parameters to 0dB and adjust the audio level with the mixer
    - if need change the **audio gain left** and **right** parameters
  - d. if analog audio source:
    - leave **audio gain left** and **right** parameters to 0dB and adjust **Max audio level** parameter. NOTE: this parameters is unique for both the channels (right and left)
    - if need change the **audio gain left** and **right** parameters

NOTE: adjust the **audio level** (thru the mixer and/or **Max audio level** and/or the **audio gain left** and **right** parameters) so that, for the maximum input signal level,

the AF level bars show the **MAXIMUM NUMBERS OF GREEN LED INDICATORS AND NO YELLOW/RED CLIP LED INDICATORS**



the MOD. (modulation) bar shows the **MAXIMUM NUMBERS OF GREEN LED INDICATORS AND NO YELLOW/RED PEAK LED INDICATOR**



7. Enter in the **MAIN>Ch-Gr** menu and set the *group/channel/frequency*
8. Enter in the **MAIN>Mode** menu and set the appropriate *Mode* (see [Compatibility table](#) for more detail)
9. Enter in the **MAIN>TX Power** menu and set the *TX power (10÷200mW)*
10. Exit from the menu and switch on the RF power output pushing the lower button on the right of the display

## FRONT PANEL CONTROL AND FUNCTIONS

MTK952 allows an easy and quick configuration using buttons, push knobs and displays.



The front panel is functionally divided in the following section:

### A – SCAN, SYNC and INFRARED

Automatic sync with “MPR30” receiver through infrared interface. The SCAN function allows to display the results of a scan previously done from a MPR30 and set a frequency on the receivers.

### B and C - TRANSMITTER1 and TRANSMITTER2

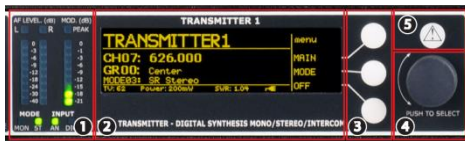

Transmitter 1 and 2 configuration and monitor of radio/audio levels.

#### 1 Audio and Modulation indicators

- two LED bars for the AF levels (L=left & R=right levels): they can show AF input levels or modulation levels (after the pre-emphasis and compander phases, before the modulation phase) according to the *AF level meter* parameter on [Audio source menu](#)
- FM modulation of the transmitter channel (modulation in dB referred to the nominal deviation)

2 LCD display.(64 x 254 yellow-lighted display)

3 3 push buttons (membrane). The function of each button (upper, middle and lower) will be readable from the context menu on the display.

4 Push rotary knob. Rotate and push to select.

5 Warning (YELLOW) and Alarm (RED) light indicator

### D - MONITOR

**Monitor 1 and 2:** it activates monitor audio on headphone jack output (6.3mm - 1/4”) for transmitter 1 and 2, respectively (a green LED is lighted when audio is enable). Audio level can be adjusted with the rotary knob. The red led (CLIP) indicates a clipping in the audio monitor output.

### E - POWER & LOCK

**LOCK:** it locks the editing of both the displays.

**POWER:** ON/OFF square powering button turns on/off the transmitter. When in OFF position both phases are disconnected from power.

# REAR PANEL

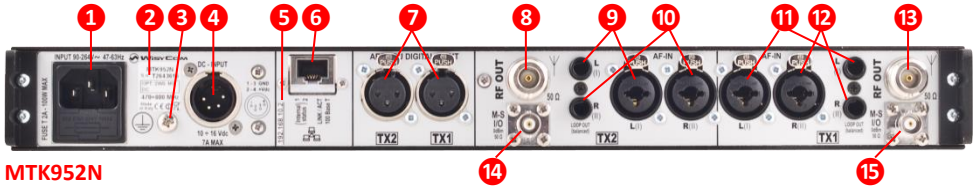

MTK952N

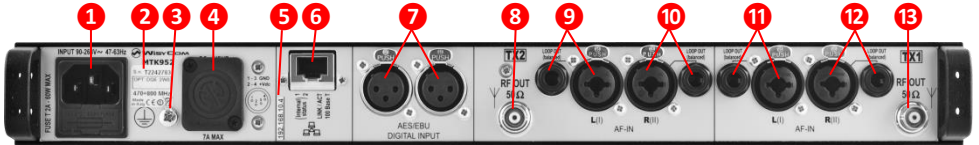

MTK952

- 1 AC Power Plug AC mains power input, IEC Connector 90-264 Vac
- 2 Product label with Serial Number, Options and Bandwidth
- 3 Ground point To connect the rack to ground
- 4 DC Power Plug (optional) DC power input, 10-16Vdc, Max 7A\*
- 5 label with IP address of Ethernet interface configured on the MTK952 (it can be modified using the Manager application)
- 6 Ethernet socket (RJ45) for connection to a network or computer
- 7 AES/EBU (XLR 3 pin connector) for digital audio input TX1 and TX2
- 8 Antenna output TX2 (RF output) BNC socket (N socket for MTK952N)
- 9 Audio input left TX2 (balanced AF input) ¼" (6,3mm) jack/XLR-3 combo socket and ¼" jack
- 10 Audio input right TX2 (balanced AF input) ¼" (6,3mm) jack/XLR-3 combo socket and ¼" jack
- 11 Audio input left TX1 (balanced AF input) ¼" (6,3mm) jack/XLR-3 combo socket and ¼" jack
- 12 Audio input right TX1 (balanced AF input) ¼" (6,3mm) jack/XLR-3 combo socket and ¼" jack
- 13 Antenna output TX1 (RF output) BNC socket (N socket for MTK952N)
- 14 M-S input/output connector TX2 (optional) for Master-Slave option, BNC socket
- 15 M-S input/output connector TX1 (optional) for Master-Slave option, BNC socket



\*NOTE: increased to 10÷28 Vdc since May 2015

## LCD DISPLAY: TRANSMITTER MENU

### MTK952 info screen

Switch on the MTK952 and by pushing one of rotatory knobs (at the right of the display) all the basic information are displayed:

Display of TRANSMITTER 1

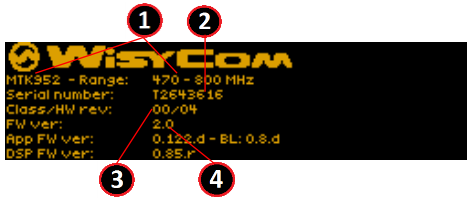

- ① product and bandwidth
- ② serial number
- ③ class and hardware version
- ④ Firmware version: it includes application firmware version and DSP firmware version

Display of TRANSMITTER 2

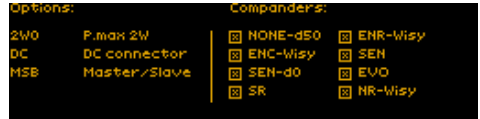

On the display of TX2, it is possible to check the max level of power transmitted of the MK952, the installed options and the companders.

**Option:**



- W05 / 0W2 / 2W0 are the commercial codes to identify the max power transmitted (50/2000/2000mW)
- DC indicate that the DC option (for DC power supply) is installed
- MSB indicate that the Master-Slave board is installed (MS option)

### Status screen

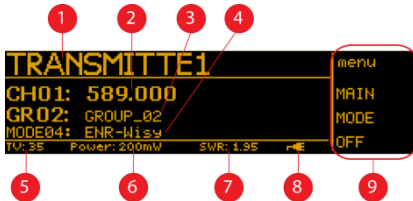
After switch on, the transmitters display the Status screen



The main view has the following info:

- ① transmitter name
- ② current channel number and current tuning frequency
- ③ current group number and group name
- ④ current mode
- ⑤ TV channel used for the current frequency
- ⑥ current TX power setting
- ⑦ current SWR (Stationary Wave Ratio)
- ⑧ power supply type (  for AC power  for DC power)
- ⑨ menu

Thru the main menu on the LCD display and the LED bars for the AF level and modulation the user has the complete monitoring in real time of the wireless channel in use.

# MENU TREE

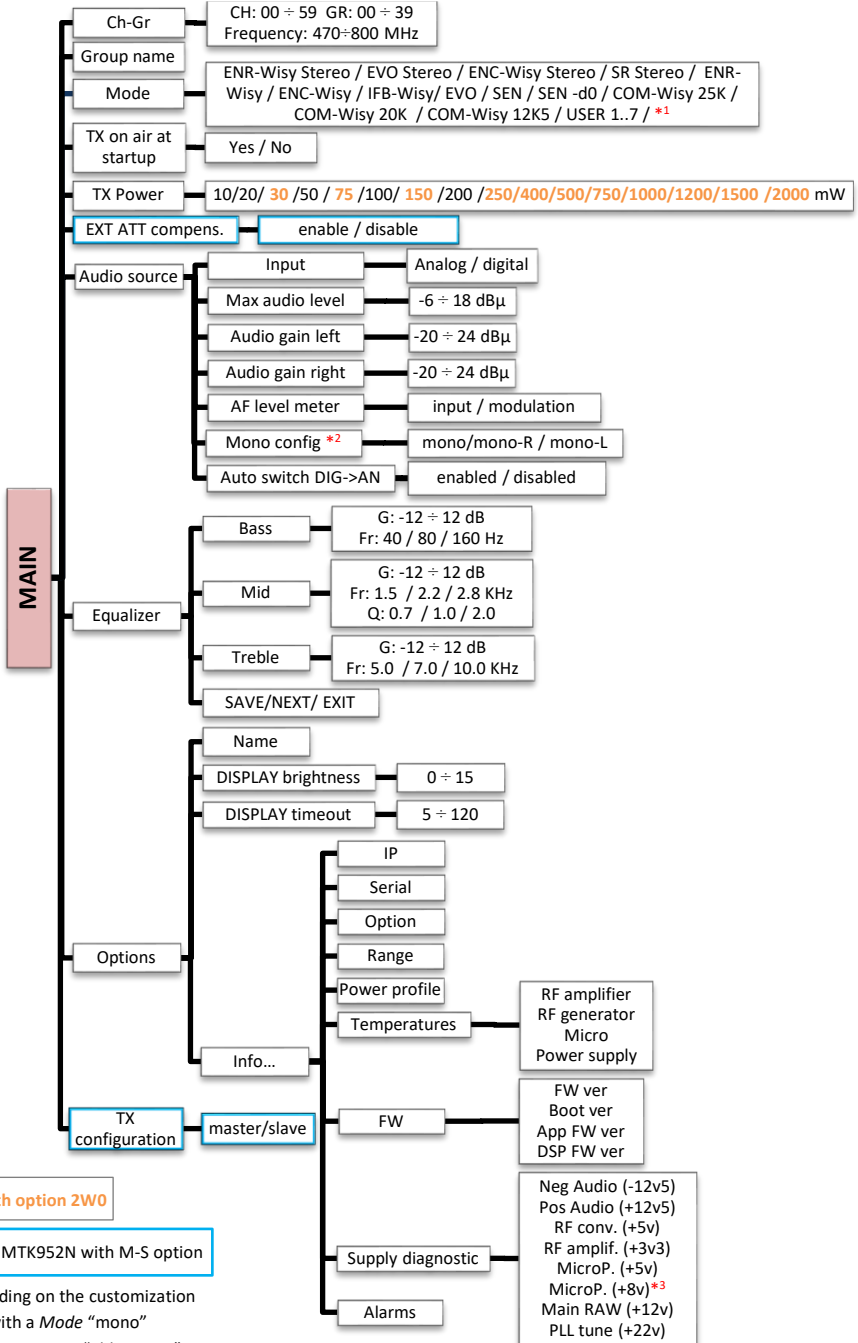

Only with option 2W0

Only for MTK952N with M-S option

\*1 Depending on the customization  
 \*2 Only with a Mode "mono"  
 \*3 +3v3 for MTK952 "old version"



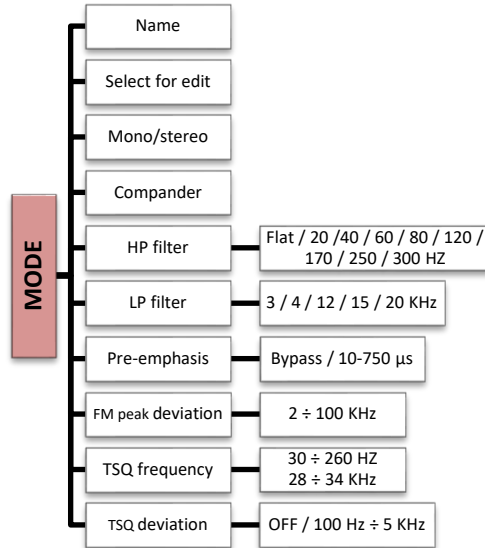

To access the configuration menu of the transmitter is necessary to press the rotary knob (at the right of the display ①).

To activate one of the items in the menu, press the corresponding button to the right of the display (see picture hereafter ②).



## MAIN MENU

The first item on the menu tree is “MAIN”.

### Ch-Gr

The **CHANNEL-GROUP** item enables the user to edit channel, channel group and frequency of the selected item. Change, rotating the knob, the channel or the group of channels and confirm or exit with the buttons. To edit the frequency of selected channel, press the middle button and change it with the knob. Press the knob to move between MHz and KHz. Confirm or exit with the buttons.

As shown in the above picture, the display area has 3 rows with:

- 1) Channel number (0 to 60) and Channel frequency (in 5kHz step)
- 2) Number (1 to 40) and Group name (8 char.)
- 3) Group description (30 char.)

The MTK952 has 40 groups of 60 channels each. Normally this is too much for wireless microphones applications.

Connecting with computer with WISYCOM Rack MANAGER software, it is possible to hide single channels or even complete groups of channels: once hidden those items are not shown anymore on the channels or groups selection. To show channels or groups hidden use again the WISYCOM Rack MANAGER software.

Using this software it is also possible to lock channels or groups. When a channel is locked, it is not possible to change the frequency from the front panel of the transmitter. Locking a group means that all channels are locked. When a channel or a group are locked, at the left of the group name in the Chan-Group menu will appear a lock icon . When the lock picture is shown, the central button is not displayed, thus changing frequency is not possible.

### Group name

The second item on the Main menu is **GROUP NAME**; with this function is possible to assign or change a name to a group of channel. This short name (8 character) is displayed at the right of the group number in the main display view. First chose the group and then press the knob. You will be able to edit any character of the group name rotating the knob. Push the knob to edit the next character. Confirm or exit with the buttons.

NOTE: when the Group name is SYNC (see [synchronization](#)) it is not possible to change it.

### Mode

The MODE menu allows to assign a Mode setting at the transmitter. Rotating the knob it is possible to change current mode among the modes available (for more detail see [MODE menu](#)).

## TX on air at startup

This menu allows to decide if turn ON or turn OFF the RF power of the transmitter while the MTK952 is powering on.

If set to **No**: while the MTK952 is powering on, the RF output remains mute. The Status Screen on the display shows “TX OFF “ and the set Group, Channel and frequency.

NOTE: When the RF power of the transmitter is OFF, all the led and the bars remain turned off. Pushing the rotatory knob (at the right of the display) it is possible to activate the led and bars (keeping the RF power OFF) and enter on the menu.



In order to activate the RF output press the 3<sup>rd</sup> button at the bottom (see indication “ON” on the display).

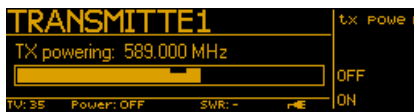

If set to **Yes**: during the MTK952 power on, the progress bar appears for 10 seconds.

During this interval (10 sec.) it is possible to switch off the RF output. If no button is pushed, at the end of the timer the RF output is enabled automatically.

## TX power

This menu allows to set the power of the transmitter. Rotating the knob it is possible to change current TX power setting among 10/20/50/100/200 mW (2W only for MTK952 with 2W option). Push the SAVE button to confirm. In the same screen is showed the reflected power and the SWR (Stationary Wave Ratio) sensing on antenna outputs.

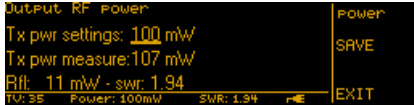

The set TX power and the measured SWR are always showed at the bottom of the display.

## EXT ATT compens.

For future uses.

## Audio source

This menu allows to set several parameters of audio input

Parameters	Range setting	Function
Input	digital/analog	To set the audio input
Max audio level (only for analog input)	-6/0/6/12/18 dBu	To change (increase or decrease) the analogue audio input for both R(right) and L(left) channels input
Audio gain left	-20÷24dB	To change (increase or decrease) the input level of the left channel on DSP
Audio gain right	-20÷24dB	To change (increase or decrease) the input level of the right channel on DSP
AF level meter	input/modulation	To set which AF level is shown in the two LED bars for the AF levels (L=left & R=right levels): they can show AF input levels or modulation levels (after the pre-emphasys and compander phases)
Mono config (only for mono Mode)	Mono/mono-R/mono-L	To set the type of mono input
Auto switch DIG->AN	enabled / disabled	If enabled and the digital signal is lost (parameter Input set to digital), the transmitter takes the signal from the analog input.

## Equalizer

This menu allows to of adjusting the gain between frequency components (bass, mid and treble) within the audio signal. There are 4 windows in cascade:

**bass** windows: allows to change gain and frequency of low frequencies

**mid** windows: allows to change gain and frequency of middle frequencies

**treble** windows: allows to change gain and frequency of high frequencies

**eq** windows: allows to save the equalization parameter or exit without save

Each window shows the following information:

1 windows name  
 2 parameter to set (gain or frequency)  
 3 graphic equalizer: frequency on horizontal axis, gain on the vertical axis  
 4 set gain  
 5 set frequency  
 6 LP filter set in the mode menu  
 7 HP filter set in the mode menu

For each window it is showed the graphic equalizer which help to see the set parameters. Push the rotatory knob to change the parameter between gain and frequency (the respective letter **G** or **Fr** is highlighted during the setting phase) and

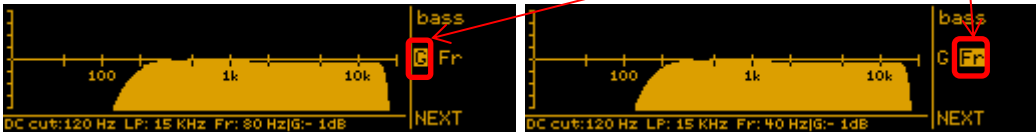

rotate it to change the value of the parameter. The set value is showed on the bottom of the windows (see points 4 and 5 on the above image).

Push the lower membrane button to go on the next windows.

The following table recaps the settable values on the 3 windows:

	Fr (frequency)	G (gain)	Q (Q factor)
<b>bass</b>	40/80/160 Hz	-12÷12dB (1dB step)	-
<b>mid</b>	1.5/2.2/2.8kHz		0.7/1.0/2.0
<b>treble</b>	5/7/10kHz		-

NOTE: High Q factor means narrow bandwidth. Low Q factor means wide bandwidth.

## Options

This menu allows to change some parameters of the transmitter or display some information

Parameters		Range setting	Function	
Name		ex. <i>TRANSMITTER1</i>	To change the name of the transmitter shown in the <a href="#">Status screen</a> . 12 alphanumeric characters (A-Za-z0-9, case-sensitive)	
DISPLAY brightness		0÷15 step 1	To set the brightness of the display	
DISPLAY timeout		5÷60 step 5sec. 60÷120 step 10 sec.	To set the display timeout for: <ul style="list-style-type: none"> <li>• decrease the brightness of the display and</li> <li>• return to Status screen</li> </ul>	
Info	IP address	ex. <i>192.168.10.1</i>	to show the IP address	
	Serial	ex. <i>R1825694</i>	to show the serial number of the product (the same indicated in the product label)	
	Option	ex. <i>0W2</i>	To show the option	
	Range	ex. <i>470-800</i>	to show the frequency range (MHz)	
	Temperatures	RF amplifier	ex. <i>30°C</i>	to show the temperature took near the RF amplifier (°C)
		RF generator	ex. <i>31°C</i>	to show the temperature took near the RF generator (°C)
		Micro	ex. <i>33°C</i>	to show the temperature took near the RF microprocessor (°C)
		Power supply	ex. <i>31°C</i>	to show the temperature took near the power supply (°C)
	FW	FW ver	ex. <i>1.1</i>	to show the firmware version (it sums up Boot+App+DSP versions)
		Boot ver	ex. <i>0.2.d</i>	to show the bootloader version
		App FW ver	ex. <i>0.36.d</i>	to show the application firmware version
		DSP FW ver	ex. <i>0.61.d</i>	to show the DSP firmware version
	Supply diagnostic	Neg Audio (-12v5)	ex. <i>-12.42V</i>	To show the power supply of the input audio stages
		Pos Audio (+12v5)	ex. <i>12.36V</i>	To show the power supply of the output audio stages
		RF conv. (+5v)	ex. <i>5.33V</i>	To show the power supply of the RF converters
		RF amplif. (+8v)	ex. <i>7.82V</i>	To show the power supply of the RF amplifiers
		MicroP. (+5v)	ex. <i>5.14V</i>	To show the power supply of the microprocessor and the digital section
		Micro.P (+3v3)	ex. <i>3.41V</i>	To show the power supply of the microprocessor and the digital section
		Main RAW (+12v)	ex. <i>12.62V</i>	To show the main power supply
		PLL tune (+22v)	ex. <i>23.29V</i>	To show the power supply of the PLL
	Alarms		ex. <i>0</i>	To show the number “n” of active alarms: <ul style="list-style-type: none"> <li>• n=0 → 0 active alarms</li> <li>• n&gt;0 → n active alarms</li> </ul> When “n”>0, it is possible to enter in the alarm submenu which allows to show the alarms list: a brief description and an alarm code for each alarm.
				
			For the complete list of alarms, see <a href="#">Alarm List</a> section	

Note: the complete software and hardware status is displayed on the [MTK952 info screen](#)

## TX configuration (only for MTK952N with option MS)

This parameter permits to use the transmitter in *Master* or *Slave* configuration.

When the MTK952N is in Master configuration, the signal is transmitted as a normal MTK952N (without MS option) but at the same time, the signal is sent also in the M-S I/O BNC connector at 0dBm (without amplification).

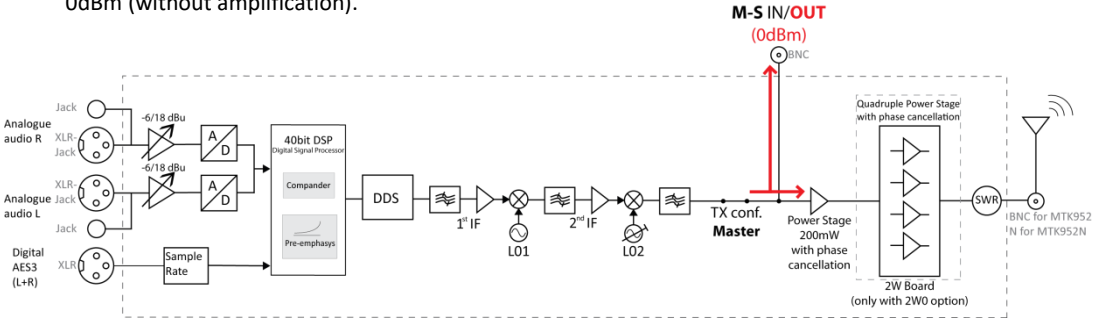

When the MTK952N is in Slave configuration, everything that is before the power stage is excluded and the device take as input the signal that enter in the M-S I/O BNC connector, amplifies the signal (at the power set on the MTK952N-Slave) and transmits it.

MTK952N is able to detect a signal in the range  $-6\text{dBm} \div +6\text{dBm}$  (than the 0dBm sent from the MTK952 Master).

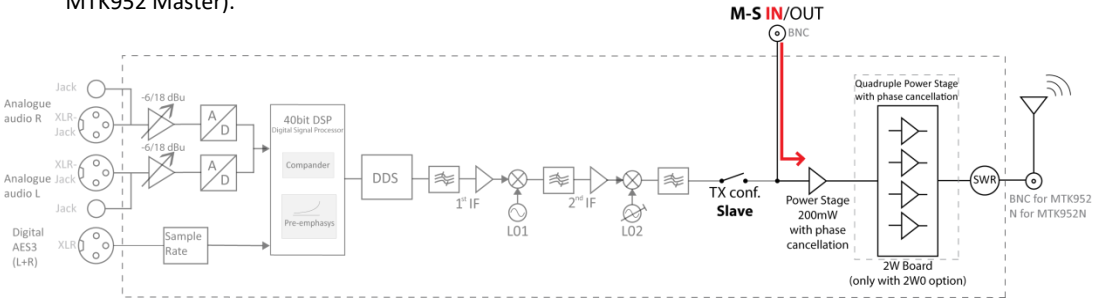

### Example of configurations: iso-frequency areas

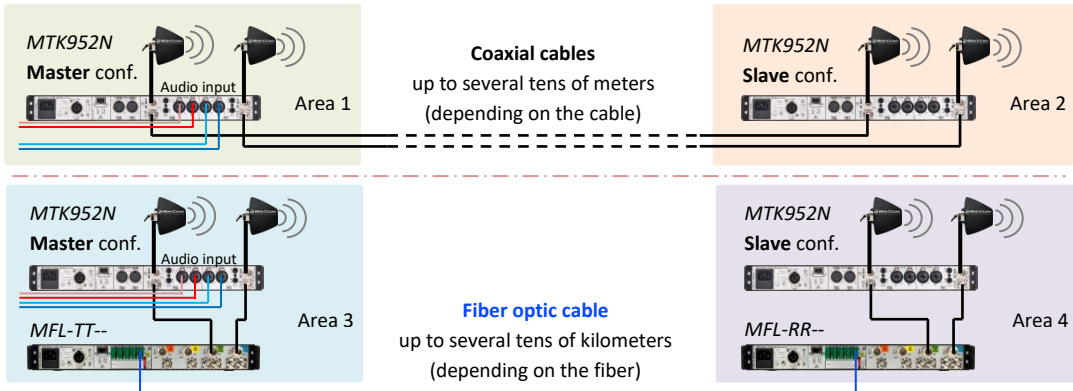

## MODE menu

The second item on the menu tree is “MODE”. It allows to manage several modes.

Each mode is a setup saved in an external memory that allows to customized the transmission changing some parameters of the DSP. There are 2 types of modes:

- PRESET mode: it allows to change only some parameters (the other are fixed). See [compatibility table](#) at the end of the manual for more detail
- USER mode: it allows to change all the parameters. Currently 8 USER modes are available

The menu Select for edit allows to select the MODE to edit. Push the knob to select the mode and push the button LOAD to load the previously saved parameters. It is possible to change the parameter value only where the EDIT indication appears.

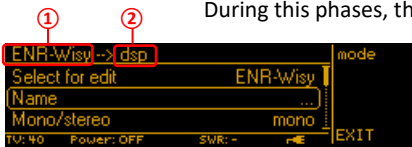

During this phases, the name of the MODE to edit appears on the left top of the display ①. If the MODE to edit is the current mode loaded on DSP (on the Main>Mode menu), “dsp” abbreviation is shown ②.

Shown below the complete parameters list

Parameter	Range setting	Description	Changeable	
			PRESET MODE	USER MODE
Name		name of mode	no	yes
Mono/stereo	mono/stereo	type of transmission	no	yes
Compander		compander type	no	yes
HP filter	Flat/20/40/60/80/120/170/250/300 Hz	High Pass filter	yes	yes
LP filter	3/4/12/15/20 Kz	Low Pass filter	yes	yes
Pre-emphasis	Bypass/10-750 μs	Pre-emphasis	related to the mode	yes
FM peak deviation	2±100 KHz	Max peak deviation (audio+tone squelch)		yes
TSQ frequency	30±260Hz and 28±34KHz	Frequency of Tone Squelch signal		yes
TSQ deviation	OFF/100Hz±5kHz	Deviation of Tone Squelch signal		yes

## Synchronization

The SYNC function is useful to tune a transmitter on the same frequency of the receiver via the IR interface.

- Enable the IRDA on the receiver and place the IR windows of the receiver in front of the IR interface of the transmitter as indicate in the below image.



- Press the SYNC button  on the transmitter: the following message is showed on both the displays

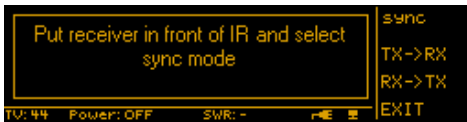

- Using the membrane buttons of the desired transmitter (TX1 or TX2) select:
  - TX->RX to set the receiver at the same frequency of the transmitter: the transmitter will send to the receiver some parameters (frequency, channel, group and transmitter’s name) and after synchronization, the receiver shows the name of the transmitter
  - RX->TX to set the transmitter at the same frequency of the receiver: the receiver will send to the transmitter some parameters (frequency, channel, group and receiver’s name) and after synchronization, the transmitter shows the name of the receiver (ex. *SINGER\_1*)

If the operation is not possible, (i.e. the frequency range of the transmitter is not compatible with the frequency of the receiver or vice versa), the display shows an error message.

If the synchronization is successful, the display of the devices shows number of channel and group or SYNC channel according to the frequency plan memorized on the Wisycom product:



CASE A: if frequency, channel and group are the same in the two devices, channel and group are also displayed (ex: *CH00: 566.000, GR39: Unlock*)

CASE B: If frequency, channel & group of the transmitter are different from those of the receiver, the transmitter shows only the frequency after the word SYNC. (ex: *SYNC: 620.000*)

Ex: *RX->TX*

	Message displayed after the synchronization	Status screen
Case A		
Case B		

## Scan

The SCAN function allows to display a results of a scan previously done from a MPR30-IEM or MPR30-ENG.

- Do a scan with an MPR30-IEM
- Enable the IRDA on the receiver or select the function Deploy on the SCAN menu (only for MPR30-ENG with FW>1.9 and MPR30-IEM with FW>1.6) and place the IR windows of the receiver in front of the IR interface of the transmitter
- Press the SCAN button on the transmitter: the following message is showed on both the displays.



- Using the membrane buttons of the desired transmitter (TX1 or TX2) select GET
- Wait some seconds (the receiver sends all the data of the scan to the transmitter)
- The display of transmitter1 show the scan result in graphic way, while the display of transmitter2 gives more detailed information of the result (according to the position of the cursor in display1)

Ex. FREQUENCY SCAN

Display of Transmitter1

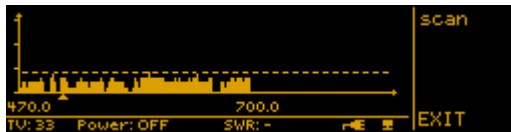

Display of Transmitter2

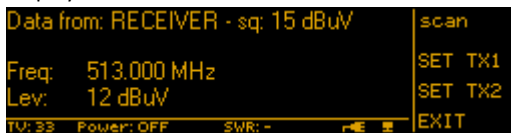

Ex: GROUP SCAN

Display of Transmitter1



Display of Transmitter2

```

Data from: RECEIVER - sq: 15 dBuV
GR: 00
Free: 17      Almost free: 11
TV: 40 Power: OFF SWR: -
scan
EXIT

```

- Use the membrane buttons on display2 to set the frequency to TX1 – TX2

NOTE: The results of the scan are saved on the volatile memory of the transmitter:

- After the switch off of the transmitter the data are lost.
- It is possible to re-load the data of a previous scan. Pushing the SCAN button and selecting VIEW

```

DATA PRESENT
Groups scan
TV: 33 Power: OFF SWR: -
scan
GET
VIEW
EXIT

```

## Alarm List

When an alarm occurs, the MTK952 can do one or more of the following acts:

A. Show a message on the display



B. Turn on the yellow or red alarm led



C. Insert the alarm on the alarm list in the [MAIN>Options>Info>Alarms menu](#)

The alarm can be related to a specific transmitter (TX1 or TX2) or general. Shown below the complete alarms list:

Alarms	Code	Type	Message on display (A)	Led (B)	Alarm list (C)
TX Power Mismatch	-	TX	ATTENTION: antenna mismatch! High SWR on Tx out	yellow	no
TX Power reduced	0x05	TX	ATTENTION: antenna mismatch! High SWR on Tx out. Rf pwr reduced	yellow	Tx power reduced
Timeout 5 sec on PLL	0x84	TX	ATTENTION: RF PLL lock lost	red	Rf PLL lock lost
Errore bus I2C		general	EEPROM access error (only on TX1)	red	Error on I2C bus
Timeout 5 sec on PLL OL969	0x84	general	ATTENTION: OL PLL lock lost (only on TX1)	red	OL PLL lock lost
High internal temperature	0x04	general	ATTENTION: internal temperature high (only on TX1)	yellow	High internal temperature
Fan #1 doesn't work	0x02	general	ATTENTION: fan #1 doesn't work properly (only on TX1)	yellow	Fan #1 doesn't work
Fan #2 doesn't work	0x03	general	ATTENTION: fan #2 doesn't work properly (only on TX1)	yellow	Fan #2 doesn't work
Recovered configuration and calibration data from copy1 on the memory	0x80	general	no	no	Mem. copy1 recovered
Recovered configuration and calibration data from copy2 on the memory	0x81	general	no	no	Mem. copy2 recovered
Load default configuration and calibration data	0x8D	general	no	no	Mem. init. Service req.

## Troubleshooting

Alarms	Alarm description	Troubleshooting
TX Power Mismatch	The SWR on Tx out is too high	<ul style="list-style-type: none"> <li>- check if the antenna is correctly connected</li> <li>- check if the antenna cable is correctly connected</li> <li>- check if the antenna frequency is according to the one set on the transmitter</li> </ul>
reduced TX Power	The SWR on Tx out is too high, the RF power is reduced	<ul style="list-style-type: none"> <li>- check if the antenna is correctly connected</li> <li>- check if the antenna cable is correctly connected</li> <li>- check if the antenna frequency is according to the one set on the transmitter</li> </ul>
Timeout 5 sec on PLL	Error during frequency tuning	- send to repair at Wisycom Repair Centre
bus I2C Error	Error on I2C bus	- send to repair at Wisycom Repair Centre
Timeout 5 sec on PLL OL 969	Error during frequency tuning	- send to repair at Wisycom Repair Centre
High internal temperature	One of the 4 temperature sensors measures a temperature > 60°C	<ul style="list-style-type: none"> <li>- check if the two fans work properly (check alarms code 0x02 or 0x03 on the alarm list)</li> <li>- switch off the MTK952 for cooling and check the location temperature</li> <li>- clean the ventilation grids</li> </ul>
Fan #1 doesn't work	The fan on the left (#1) doesn't turn	- switch off and switch on the MTK952
Fan #2 doesn't work	The fan on the right (#2) doesn't turn	- switch off and switch on the MTK952
Recovered configuration and calibration data from copy1 on the memory	During the MTK952 initialization phase, the CRC-16 check of data (copy1) detects error.	- none (the MTK952 automatically replaces the corrupt copy1 with copy2)
Recovered configuration and calibration data from copy2 on the memory	During the MTK952 initialization phase, the CRC-16 check of data (copy2) detects error.	- none (the MTK952 automatically replaces the corrupt copy2 with copy1)
Load default configuration and calibration data	During the MTK952 initialization phase, the CRC-16 check of data (copy1 and copy2) detects error.	- check in the MAIN>Options>info menu the Serial take on the 'UNCAL' vale. In this case send the MTK952 to the Wisycom Repair Centre for recalibration.

If a problem not listed in the above table occurs or if the problem cannot solved with the proposed troubleshooting, please contact support service at [support@wisycom.com](mailto:support@wisycom.com) or [sales@wisycom.com](mailto:sales@wisycom.com).

# RACK TX MANAGER MTK952

## How to install Rack Tx Manager MTK952

Run the executable file (i.e. Rack Tx Manager (MTK952) SERVICE vx.x.x.x Setup.msi) and follow the installation instructions.

## How to update Rack Tx Manager MTK952

Uninstall the *Rack Tx Manager MTK952* program active in your computer and afterwards install the newest version of *Rack Tx Manager MTK952*.

## How to connect MTK952 to Rack Tx Manager MTK952

1. Connect to the PC to the MTK952 using the supplied Ethernet cable
2. Run *Rack Tx Manager MTK952*
3. Power on the transmitter
4. Push Disconnected button. On the *Device connection* windows select Ethernet port and fill in the MTK952 IP address. Remember that the label on the rear panel shows the IP address configured in the factory. Then click OK.
5. If the connection is ended well, the Connected icon is showed on the top of the panel and “Connected on Ethernet” is displayed on the information panel

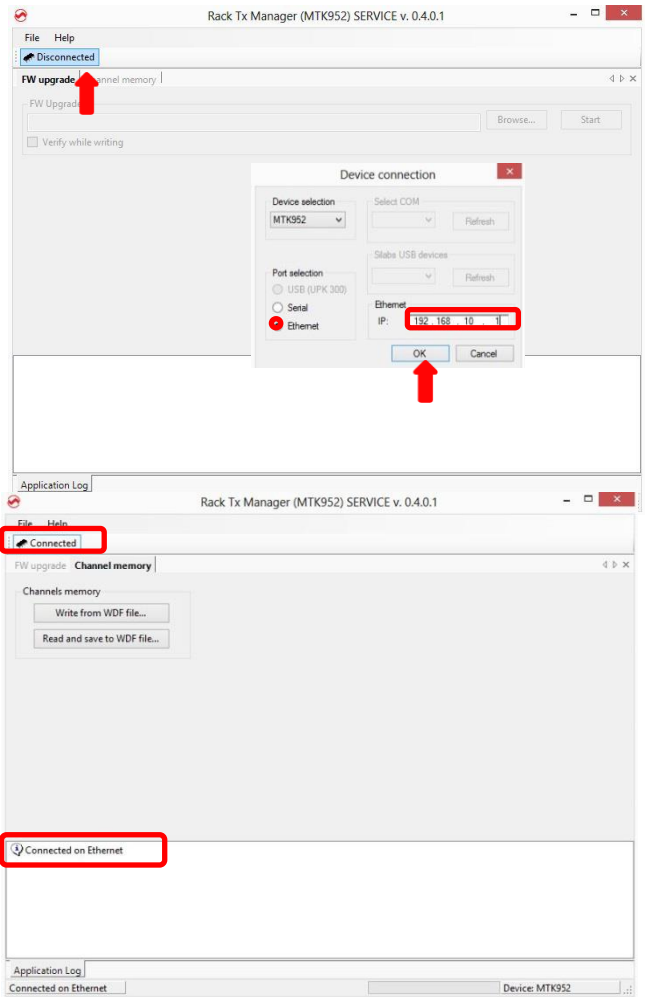

## How to load/save channels memory

Select **Channel memory** panel

### Write:

Push the button **Write from WDF file...** and select the wdf file to load a wdf file on the MTK952.

### Read and save:

Push the button **Read and save to WDF file...**, insert the .wdf file name and the path where to save the wdf file.

During the process of writing/reading & saving, a green bar below the panel shows the progress of the process and on the information panel it is possible to verify what the application is doing.



To **Modify** the wdf file, it is possible to use the spreadsheet *FREQUENCY 2010 v15 beta.xls* presents at the following [link](#):

- open the file and enable changes and macro
- load the wdf file clicking on READ WDF button
- execute the desiderate changes
- save the wdf file clicking on SAVE WDF button

The WDF thus modified can be used to write on the MTK952's channels memory.

## Mode setting & Wisycom receiver compatibility

MODE SETTING						WISYCOM RECEIVER
Name	Mono/Stereo	Compander type	Max peak deviation	Send Tone Squelch		
ENR-Wisy Stereo	Stereo	ENR	48 kHz	NO		MPR30-IEM
ENC-Wisy Stereo	Stereo	ENC	48 kHz	NO		Unavailable
ENR-Wisy	Mono	ENR	56 kHz	YES		MCR42 MPR30-ENG MRK960
ENC-Wisy	Mono	ENC	56 kHz	YES		MRK950 MSR916 (ENR)
IFB-Wisy	Mono	ENR	40 kHz	YES		MRP30-IFB
COM-Wisy 25K	Mono	NR	4,5 kHz*	YES		CPR30
COM-Wisy 20K	Mono	NR	4 kHz*	YES		CSR50
COM-Wisy 12k5	Mono	NR	2,3 kHz*	YES		RPU300 (Rx)

\*adjustable parameter

**NOTE:** receiver and transmitter have to be configured with the same compander type



## TECHNICAL SPECIFICATION

<b>Switchable channels</b>	:	2400 allocated by 40 groups of 60 channels quickly selectable with dedicated buttons
<b>Frequency bandwidth</b>	:	470-800 MHz
<b>Switching bandwidth</b>	:	330 MHz tuneable in 5 kHz steps
<b>Temperature range</b>	:	-10 ÷ +55 °C
<b>RF output power</b>	:	Selectable: 10,20,50,100,200 mW for MTK952-0W2
<b>Max RF output power</b>	:	MTK952-0W2: 200mW MTK952-2W0: 2Watt <b>[NOTE]</b> RF power can be limited on frequency base accordingly to specific country restrictions (software based), see Compliance table
<b>“TX1” / “TX2” antenna output</b>	:	BNC type female connectors (for MTK952) N type female connectors (for MTK952N)
<b>M-S I/O</b>	:	2x BNC type female connectors (only for MTK952N with MS option)
<b>RF impedance</b>	:	50 Ω
<b>Spurious emissions</b>	:	< 2 nW (in the transmitter bandwidth)
<b>Modulation</b>	:	FM, MPX Stereo or mono, selectable with dedicated menu
<b>Peak deviation</b>	:	±56 kHz for mono, ±48 kHz for stereo (preset mode) NOTE: custom setting can set peak deviation from 2kHz to 100kHz
<b>MPX Pilot tone</b>	:	19kHz
<b>Tone squelch</b>	:	32.789Hz (for Wisycom wireless microphone, i.e. ENR/ENC) 131,8 (for Wisycom intercom, i.e. NR) NOTE: custom setting can change the Tone squelch (30-260Hz and 18-38KHz)
<b>Frequency response</b>	:	20÷20kHz (mono) 30÷15kHz (stereo) NOTE: custom setting can change audio bandwidth (3/4/12/15/20kHz)
<b><u>Analogue audio input</u></b>		
<b>Connector type</b>	:	XLR-3 / 1/4” (6,3mm) jack combo socket, electronically balanced
<b>Max. input level</b>	:	+18dBu
<b>Pin Assignments</b>	:	<b>XLR:</b> 1=ground 2=hot 3=cold <b>6.35mm (1/4”) TRS:</b> Tip=hot Ring=cold Sleeve=ground
<b><u>Digital audio input</u></b>		
<b>Connection</b>	:	AES3 on XLR-3M (32kHz ÷108 kHz)
<b><u>Monitor output</u></b>		
<b>Connector type</b>	:	6.35mm (1/4”) jack socket, balanced
<b>Monitor output level</b>	:	120+120mW@24Ω , 80+80mW@150Ω
<b>Monitor out impedance</b>	:	25 ohm for auricle
<b>Compander</b>	:	ENR (Wisycom Extended-NR), with independent Attack- and Recovery-time, noise optimized ENC (Wisycom Extended-NC), with independent Attack- and Recovery-time, voice optimized & with reduced pre-emphasys NONE-d50, no compander, pre-emphasis 50 µs NR, to work with Wisycom Intercom system Other compander on request
<b>Display</b>	:	64 x 256 OLED (yellow)
<b>Configuration/monitor interfaces</b>	:	10/100 Base TX Ethernet port on RJ45 connector
<b>Power supply</b>	:	90 - 264 V AC, 50/60 Hz <b>option DC:</b> 10÷19 VDC (NOTE: increased to 10÷28 Vdc since May 2015), Max 7A
<b>Dimensions</b>	:	19”/1U 483 x 407 x 43,8 mm (WxDxH) with brackets

## Variants

**MTK952N- <RF Power> - <Country> - <MasterSlave> - <PowerSupply>**





**RF Power:**  
**0W2** max power 200mW  
**2W0** max power 2Watt

**Country Power Profile:**  
**EU** Europe (max power 50mW)  
**EUX** Europe (max power 200mW for 0W2, 2Watt for 2W0)  
**US** USA & Canada (max power 200mW for 0W2, 250mW for 2W0; limited to 698MHz)  
**JP** Japan (max power 10mW for 0W2, limited to 714MHz)  
**NZ** New Zealand (max power 500mW for 2W0, 502-698MHz)  
**AU** Australia (max power 100mW(EIRP) for 0W2, 520-694MHz)

**Master Slave:**  
**MS** additional Master Slave board for iso-frequency system

**Power Supply:**  
**DC** redundant Vdc power supply

## Compliance

<i>Model</i>	<i>In Compliance with</i>	<i>Max Power&amp; Freq. range</i>	<i>Country</i>
MTK952N-W05 MTK952N-0W2-EU	EN 301 489-1/-9 EN 600065 EN 300 422-1/-2	50mW 470-800MHz	Europe CE
MTK952N-0W2 MTK952N-0W2-EUX	EN 301 489-1/-9 EN 600065 EN 300 422-1/-2 EN 300 454-1/-2	200mW* <sup>1</sup> 470-800MHz	Europe CE
MTK952N-2W0 MTK952N-2W0-EUX	EN 301 489-1/-9 EN 600065 EN 300 422-1/-2 EN 300 454-1/-2	2W* <sup>1</sup> 470-800MHz	Europe CE
MTK952N-0W2-US	 PART 74 FCC-ID: <b>POUMTK952N-0W2</b> <b>RSS-123, RSS-210</b> IC: <b>11967A-MTK952N0W2</b>  Limited to 663MHz	200mW 470-608MHz and 614-698MHz	USA, Canada
MTK952N-2W0-US	 PART 74 FCC-ID: <b>POUMTK952N-2W0</b> <b>RSS-123, RSS-210</b> IC: <b>11967A-MTK952N2W0</b>  Limited to 663MHz	250mW 470-608MHz and 614-698MHz	USA, Canada
MTK952N-0W2-JP	  <b>202-LSD031</b>  Limited to 714 MHz	10mW 470-714MHz	Japan
MTK952N-0W2-NZ	EN 300 422-1/-2 EN 300 454-1/-2 Limited to the range 502÷698MHz	200mW 502-606MHz and 622-698MHz	New Zealand
MTK952N-2W0-NZ	EN 300 422-1/-2 EN 300 454-1/-2 Limited to the range 502÷698MHz	500mW 502-606MHz and 622-698MHz	New Zealand
MTK952N-0W2-AU	Limited to the range 520÷694MHz	100mW (EIRP) 520-694MHz	Australia

\*<sup>1</sup> MTK952N-0W2-EUX/ MTK952N-2W0-EUX is not an SRD device, thus it requires specific authorization by your local frequency authority!

***Before putting the device into operation, please observe the  
respective country-specific regulations!***

## MANUFACTURER DECLARATIONS

### In compliance with the following requirements

- RoHS Directive (2002/95/EC)



- WEEE Directive (2002/96/EC)  
Please dispose of the diversity transmitter at the end of its operational lifetime by taking it to your local collection point or recycling center for such equipment

### ITALY ONLY

#### Obblighi di informazione agli utilizzatori

ai sensi dell'art. 13 del Decreto Legislativo 25 luglio 2005, n. 151 "Attuazione delle Direttive 2002/95/CE, 2002/96/CE e 2003/108/CE, relative alla riduzione dell'uso di sostanze pericolose nelle apparecchiature elettriche ed elettroniche, nonché allo smaltimento dei rifiuti"

#### Smaltimento di apparecchiature elettriche ed elettroniche di tipo professionale



Il simbolo del cassonetto barrato riportato sull'apparecchiatura o sulla sua confezione indica che il prodotto alla fine della propria vita utile deve essere raccolto separatamente dagli altri rifiuti.

La raccolta differenziata della presente apparecchiatura giunta a fine vita è organizzata e gestita dal produttore. L'utente che vorrà disfarsi della presente apparecchiatura dovrà quindi contattare il produttore e seguire il sistema che questo ha adottato per consentire

la raccolta separata dell'apparecchiatura giunta a fine vita.

L'adeguata raccolta differenziata per l'avvio successivo dell'apparecchiatura dismessa al riciclaggio, al trattamento e allo smaltimento ambientale compatibile contribuisce ad evitare possibili effetti negativi sull'ambiente e sulla salute e favorisce il reimpiego e/o riciclo dei materiali di cui è composta l'apparecchiatura.

Lo smaltimento abusivo del prodotto da parte del detentore comporta l'applicazione delle sanzioni amministrative previste dalla normativa vigente.

Iscrizione al Registro A.E.E. n. IT0910000006319

## Statements regarding FCC and Industry Canada

### EN

This device operates on a no-protection, no-interference basis. Should the user seek to obtain protection from other radio services operating in the same TV bands, a radio licence is required. For further details, consult Innovation, Science and Economic Development Canada's document Client Procedures Circular CPC-2-1-28, Voluntary Licensing of Licence-Exempt Low-Power Radio Apparatus in the TV Bands.

This device contains licence-exempt transmitter(s)/receiver(s) that comply with Innovation, Science and Economic Development Canada's licence-exempt RSS(s).

This device complies with Part 15 of the FCC Rules. Operation is subject to the following two conditions:

- (1) This device may not cause interference.
- (2) This device must accept any interference, including interference that may cause undesired operation of the device.

This device has been designed to operate with the antennas having a maximum gain of 5 dBi.

Antennas having a greater gain are strictly prohibited for use with this device. The required antenna impedance is 50 ohms.

The antenna(s) must be installed and operated at a minimum distance of 20cm between the radiator and your body.

### FR

Ce dispositif fonctionne selon un régime de non-brouillage et de non-protection. Si l'utilisateur devait chercher à obtenir une certaine protection contre d'autres services radio fonctionnant dans les mêmes bandes de télévision, une licence radio serait requise. Pour en savoir plus, veuillez consulter la Circulaire des procédures concernant les clients CPC-2-1-28, Délivrance de licences sur une base volontaire pour les appareils radio de faible puissance exempts de licence et exploités dans les bandes de télévision d'Innovation, Sciences et Développement économique Canada.

L'émetteur/récepteur exempt de licence contenu dans le présent appareil est conforme aux CNR d'Innovation, Sciences et Développement économique Canada applicables aux appareils radio exempts de licence.

L'exploitation est autorisée aux deux conditions suivantes :

- 1) L'appareil ne doit pas produire de brouillage;
- 2) L'appareil doit accepter tout brouillage radioélectrique subi, même si le brouillage est susceptible d'en compromettre le fonctionnement.

Ce produit a été conçu pour être opérationnel avec des antennes ayant un gain maximal de 5 dBi. Antennes ayant un gain supérieur sont strictement interdites pour une utilisation avec ce produit. L'impédance nécessaire de l'antenne est 50 ohms. Les antennes doivent être installées et utilisées à une distance minimale de 20 cm entre l'émetteur et votre corps

This equipment has been tested and found to comply with the limits for a Class B digital device, pursuant to Part 15 of the FCC Rules. These limits are designed to provide reasonable protection against harmful interference in a residential installation. This equipment generates, uses and can radiate radio frequency energy and, if not installed and used in accordance with the instructions, may cause harmful interference to radio communications. However, there is no guarantee that interference will not occur in a particular installation. If this equipment does cause harmful interference to radio or television reception, which can be determined by turning the equipment off and on, the user is encouraged to try to correct the interference by one or more of the following measures:

- Reorient or relocate the receiving antenna.
- Increase the separation between the equipment and receiver.
- Connect the equipment into an outlet on a circuit different from that to which the receiver is connected.
- Consult the dealer or an experienced radio/TV technician for help.

Changes or modifications made to this equipment not expressly approved by Wisycom srl may void the FCC authorization to operate this equipment.

# DECLARATION OF CONFORMITY



## EU DECLARATION OF CONFORMITY

We,

WISYCOM S.r.l.  
via Spin, 156 - 36060  
Romano d'Ezzelino (VI) - Italy

declare under our sole responsibility that the product

*Description*  
*Model*

**MTK952**  
**Dual UHF Transmitter**

conforms to the essential requirements of the following European Directives and their associated norms:

Directive	Applicable Standards	Description
RADIO Directive 2014/53/EU (RED)	EN 300 422-1 v2.1.2	Wireless Microphones; Audio PMSE up to 3 GHz; Part 1: Class A Receivers; Harmonised Standard covering the essential requirements of article 3.2 of Directive 2014/53/EU
	EN 300 454-2 v1.1.1	Electromagnetic compatibility and Radio spectrum Matters (ERM); Wide band audio links; Part 2: Harmonized EN under article 3.2 of the R&TTE Directive
EMC	EN 301 489-1 v1.9.2	Electromagnetic compatibility and Radio spectrum Matters (ERM); ElectroMagnetic Compatibility (EMC) standard for radio equipment and services; Part 1: Common technical requirements
	EN 301 489-9 v1.4.1	Electromagnetic compatibility and Radio spectrum Matters (ERM); ElectroMagnetic Compatibility (EMC) standard for radio equipment and services; Part 34: Specific conditions for External Power Supply (EPS) for mobile phones
Safety	EN 62368-1 2014	Audio/video, information and communication technology equipment — Part 1: Safety requirements (IEC 62368-1:2014, modified)
Human Exposure	EN 62311:2008	Assessment of electronic and electrical equipment related to human exposure restrictions for electromagnetic fields (0 Hz — 300 GHz)
RoHS	EN 50581 2012	Technical documentation for the assessment of electrical and electronic products with respect to the restriction of hazardous substances

Date: 10 July 2018

Franco Maestrelli, Managing director

WISYCOM S.r.l.  
via Spin, 156 - 36060 ROMANO D'EZELINO (VI)  
Tel. +39 0424 332511 - Fax +39 0424 392733  
sales@wisycom.com - www.wisycom.com  
P. IVA (VAT) I.C.F. 02765640244



# WISYCOM™

VOX INFRAGILIS

Via Spin 156 • I-36060 Romano d'Ezzelino • Italy  
Tel. +39 -0424 -382605 • Fax +39 - 0424 - 382733  
[www.wisycom.com](http://www.wisycom.com) • e-mail: [sales@wisycom.com](mailto:sales@wisycom.com)

