



**FCC 47 CFR PART 15 SUBPART C**

**TEST REPORT**

**For**

**Pandigital novel mule-Rader**

**Model: PRD07TXXXXXX (X=A~Z, a~z, 0-9 or blank )**

**Trade Name: PANDIGITAL**

*Issued to*

**Inventec Appliances Corp.**  
**37, Wu-Kung 5 Road, Wu-Ku Industrial Wu-Ku Hsiang ,**  
**Taipei Hsien, Taiwan 248**

*Issued by*

**Compliance Certification Services Inc.**  
**No. 11, Wu-Gong 6<sup>th</sup> Rd., Wugu Industrial Park,**  
**Taipei Hsien 248, Taiwan (R.O.C.)**  
**<http://www.ccsrf.com>**  
**[service@ccsrf.com](mailto:service@ccsrf.com)**



---

***Note:** This report shall not be reproduced except in full, without the written approval of Compliance Certification Services Inc. This document may be altered or revised by Compliance Certification Services Inc. personnel only, and shall be noted in the revision section of the document.*



## TABLE OF CONTENTS

<b>1. TEST RESULT CERTIFICATION.....</b>	<b>3</b>
<b>2. EUT DESCRIPTION .....</b>	<b>4</b>
<b>3. TEST METHODOLOGY .....</b>	<b>5</b>
3.1 EUT CONFIGURATION .....	5
3.2 EUT EXERCISE.....	5
3.3 GENERAL TEST PROCEDURES.....	5
3.4 FCC PART 15.205 RESTRICTED BANDS OF OPERATIONS .....	6
3.5 DESCRIPTION OF TEST MODES .....	7
<b>4. INSTRUMENT CALIBRATION.....</b>	<b>8</b>
4.1 MEASURING INSTRUMENT CALIBRATION .....	8
4.2 MEASUREMENT EQUIPMENT USED .....	8
4.3 MEASUREMENT UNCERTAINTY .....	9
<b>5. FACILITIES AND ACCREDITATIONS.....</b>	<b>10</b>
5.1 FACILITIES .....	10
5.2 EQUIPMENT.....	10
5.3 TABLE OF ACCREDITATIONS AND LISTINGS.....	11
<b>6. SETUP OF EQUIPMENT UNDER TEST .....</b>	<b>12</b>
6.1 SETUP CONFIGURATION OF EUT.....	12
6.2 SUPPORT EQUIPMENT .....	12
<b>7. FCC PART 15.247 REQUIREMENTS.....</b>	<b>13</b>
7.1 6DB BANDWIDTH.....	13
7.2 PEAK POWER.....	18
7.3 AVERAGE POWER.....	19
7.4 BAND EDGES MEASUREMENT .....	20
7.5 PEAK POWER SPECTRAL DENSITY .....	29
7.6 SPURIOUS EMISSIONS.....	34
7.7 POWERLINE CONDUCTED EMISSIONS.....	49
<b>APPENDIX I RADIO FREQUENCY EXPOSURE.....</b>	<b>54</b>
<b>APPENDIX II PHOTOGRAPHS OF TEST SETUP .....</b>	<b>55</b>
<b>APPENDIX 1 - PHOTOGRAPHS OF EUT</b>	



# 1. TEST RESULT CERTIFICATION

**Applicant:** Inventec Appliances Corp.  
 37, Wu-Kung 5 Road, Wu-Ku Industrial Wu-Ku Hsiang ,  
 Taipei Hsien, Taiwan 248

**Equipment Under Test:** Pandigital novel mule-Rader

**Trade Name:** PANDIGITAL

**Model:** PRD07TXXXXXX (X=A~Z, a~z, 0-9 or blank )

**Date of Test:** May 14 ~ 19, 2010

APPLICABLE STANDARDS	
STANDARD	TEST RESULT
FCC 47 CFR Part 15 Subpart C	No non-compliance noted
Deviation from Applicable Standard	
N/A	

### We hereby certify that:

The above equipment was tested by Compliance Certification Services Inc. The test data, data evaluation, test procedures, and equipment configurations shown in this report were made in accordance with the procedures given in **ANSI C63.4: 2003** and the energy emitted by the sample EUT tested as described in this report is in compliance with the requirements of FCC Rules Part 15.207, 15.209, 15.247.

The test results of this report relate only to the tested sample EUT identified in this report.

Approved by:

Reviewed by:

---

Rex Lai  
 Section Manager  
 Compliance Certification Services Inc.

---

Gina Lo  
 Section Manager  
 Compliance Certification Services Inc.



## 2. EUT DESCRIPTION

<b>Product</b>	Pandigital novel mule-Rader
<b>Trade Name</b>	PANDIGITAL
<b>Model Number</b>	PRD07TXXXXXX (X=A~Z, a~z, 0-9 or blank )
<b>Model Discrepancy</b>	All the specification and layout are identical except they come with different model numbers for marketing purposes.
<b>Power Adapter</b>	Trade Name / Model: DVE / DSA-12PFA-05 FUS 050200 I/P: 100-240V, 50-60Hz, 0.5A O/P: 5V, 2A
<b>Frequency Range</b>	2412 ~ 2462 MHz
<b>Transmit Power</b>	IEEE 802.11b: 16.14 dBm IEEE 802.11g: 20.23 dBm
<b>Modulation Technique</b>	IEEE 802.11b: DSSS (CCK, DQPSK, DBPSK) IEEE 802.11g: OFDM (QPSK, BPSK, 16-QAM, 64-QAM)
<b>Transmit Data Rate</b>	IEEE 802.11b Mode: 11, 5.5, 2, 1 Mbps IEEE 802.11g Mode: 54, 48, 36, 24, 18, 12, 9, 6Mbps
<b>Number of Channels</b>	11 Channels
<b>Antenna Specification</b>	Gain: 2 dBi
<b>Antenna Designation</b>	PIFA Antenna

**Remark:**

1. The sample selected for test was production product and was provided by manufacturer.
2. This submittal(s) (test report) is intended for FCC ID: **POTPRD07T** filing to comply with Section 15.207, 15.209 and 15.247 of the FCC Part 15, Subpart C Rules.



### **3. TEST METHODOLOGY**

The tests documented in this report were performed in accordance with ANSI C63.4 and FCC CFR 47 Part 15.207, 15.209 and 15.247.

#### **3.1 EUT CONFIGURATION**

The EUT configuration for testing is installed on RF field strength measurement to meet the Commissions requirement and operating in a manner that intends to maximize its emission characteristics in a continuous normal application.

#### **3.2 EUT EXERCISE**

The EUT was operated in the engineering mode to fix the TX frequency that was for the purpose of the measurements.

According to its specifications, the EUT must comply with the requirements of the Section 15.207, 15.209 and 15.247 under the FCC Rules Part 15 Subpart C.

#### **3.3 GENERAL TEST PROCEDURES**

##### **Conducted Emissions**

The EUT is placed on the turntable, which is 0.8 m above ground plane. According to the requirements in Section 13.1.4.1 of ANSI C63.4: 2003 Conducted emissions from the EUT measured in the frequency range between 0.15 MHz and 30MHz using CISPR Quasi-peak and average detector modes.

##### **Radiated Emissions**

The EUT is placed on a turn table, which is 0.8 m above ground plane. The turntable shall rotate 360 degrees to determine the position of maximum emission level. EUT is set 3m away from the receiving antenna, which varied from 1m to 4m to find out the highest emission. And also, each emission was to be maximized by changing the polarization of receiving antenna both horizontal and vertical. In order to find out the maximum emissions, exploratory radiated emission measurements were made according to the requirements in Section 13.1.4.1 of ANSI C63.4: 2003.



### 3.4 FCC PART 15.205 RESTRICTED BANDS OF OPERATIONS

(a) Except as shown in paragraph (d) of this section, only spurious emissions are permitted in any of the frequency bands listed below:

MHz	MHz	MHz	GHz
0.090 - 0.110	16.42 - 16.423	399.9 - 410	4.5 - 5.15
<sup>1</sup> 0.495 - 0.505	16.69475 - 16.69525	608 - 614	5.35 - 5.46
2.1735 - 2.1905	16.80425 - 16.80475	960 - 1240	7.25 - 7.75
4.125 - 4.128	25.5 - 25.67	1300 - 1427	8.025 - 8.5
4.17725 - 4.17775	37.5 - 38.25	1435 - 1626.5	9.0 - 9.2
4.20725 - 4.20775	73 - 74.6	1645.5 - 1646.5	9.3 - 9.5
6.215 - 6.218	74.8 - 75.2	1660 - 1710	10.6 - 12.7
6.26775 - 6.26825	108 - 121.94	1718.8 - 1722.2	13.25 - 13.4
6.31175 - 6.31225	123 - 138	2200 - 2300	14.47 - 14.5
8.291 - 8.294	149.9 - 150.05	2310 - 2390	15.35 - 16.2
8.362 - 8.366	156.52475 -	2483.5 - 2500	17.7 - 21.4
8.37625 - 8.38675	156.52525	2655 - 2900	22.01 - 23.12
8.41425 - 8.41475	156.7 - 156.9	3260 - 3267	23.6 - 24.0
12.29 - 12.293	162.0125 - 167.17	3332 - 3339	31.2 - 31.8
12.51975 - 12.52025	167.72 - 173.2	3345.8 - 3358	36.43 - 36.5
12.57675 - 12.57725	240 - 285	3600 - 4400	( <sup>2</sup> )
13.36 - 13.41	322 - 335.4		

<sup>1</sup> Until February 1, 1999, this restricted band shall be 0.490-0.510 MHz.

<sup>2</sup> Above 38.6

(b) Except as provided in paragraphs (d) and (e), the field strength of emissions appearing within these frequency bands shall not exceed the limits shown in Section 15.209. At frequencies equal to or less than 1000 MHz, compliance with the limits in Section 15.209 shall be demonstrated using measurement instrumentation employing a CISPR quasi-peak detector. Above 1000 MHz, compliance with the emission limits in Section 15.209 shall be demonstrated based on the average value of the measured emissions. The provisions in Section 15.35 apply to these measurements.



### **3.5 DESCRIPTION OF TEST MODES**

The EUT (model: PRD07T20WBL1) had been tested under operating condition.

Software used to control the EUT for staying in continuous transmitting mode was programmed.

This device is for handheld operation only.

After verification, all tests were carried out with the worst case test modes as shown below except radiated spurious emission below 1GHz and power line conducted emissions below 30MHz, which worst case was in normal link mode only.

IEEE 802.11b mode:

Channel 1(2412MHz), Channel 6(2437MHz) and Channel 11(2462MHz) with 1Mbps data rate were chosen for the final testing.

IEEE 802.11g mode:

Channel 1(2412MHz), Channel 6(2437MHz) and Channel 11(2462MHz) with 6Mbps data rate were chosen for the final testing.

The field strength of spurious emission was measured in the following position: EUT stand-up position (Z axis), lie-down position (X, Y axis). The worst emission was found stand-up position (Z axis) and the worst case was recorded.



## 4. INSTRUMENT CALIBRATION

### 4.1 MEASURING INSTRUMENT CALIBRATION

The measuring equipment, which was utilized in performing the tests documented herein, has been calibrated in accordance with the manufacturer's recommendations for utilizing calibration equipment, which is traceable to recognized national standards.

### 4.2 MEASUREMENT EQUIPMENT USED

#### Equipment Used for Emissions Measurement

*Remark: Each piece of equipment is scheduled for calibration once a year.*

Conducted Emissions Test Site				
Name of Equipment	Manufacturer	Model	Serial Number	Calibration Due
Spectrum Analyzer	Agilent	E4446A	MY43360131	03/03/2011
Power Meter	Agilent	E4416A	GB41291611	06/28/2010
Power Sensor	Agilent	E9327A	US40441097	06/28/2010

3M Semi Anechoic Chamber				
Name of Equipment	Manufacturer	Model	Serial Number	Calibration Due
Spectrum Analyzer	Agilent	E4446A	US42510252	10/26/2010
EMI Test Receiver	R&S	ESCI	100064	02/04/2011
Pre-Amplifier	Mini-Circuits	ZFL-1000LN	SF350700823	01/13/2011
Pre-Amplifier	MITEQ	AFS44-00102650-42-10P-44	1415367	11/20/2010
Bilog Antenna	Sunol Sciences	JB3	A030105	09/11/2010
Horn Antenna	EMCO	3117	00055165	12/07/2010
Loop Antenna	EMCO	6502	8905/2356	05/28/2010
Turn Table	CCS	CC-T-1F	N/A	N.C.R
Antenna Tower	CCS	CC-A-1F	N/A	N.C.R
Controller	CCS	CC-C-1F	N/A	N.C.R
Site NSA	CCS	N/A	N/A	12/31/2010
Test S/W	EZ-EMC (CCS-3A1RE)			

Powerline Conducted Emissions Test Site				
Name of Equipment	Manufacturer	Model	Serial Number	Calibration Due
EMI Test Receiver	R&S	ESHS10	843743/015	03/25/2011
LISN	SCHWARZBECK	NSLK 8127	8127-541	03/14/2011
LISN	FCC	FCC-LISN-50/250-16-2-07	06012	11/29/2010
Current Probe	TEGAM	95236-1	12567	03/22/2011
Capacitive Voltg Probe	FCC	F-CVP-1	100185	02/17/2011
Test S/W	CCS-3A1-CE			





### 4.3 MEASUREMENT UNCERTAINTY

PARAMETER	UNCERTAINTY
Powerline Conducted Emission	+/- 1.6516
3M Semi Anechoic Chamber / 30M~200M	+/- 4.0606
3M Semi Anechoic Chamber / 200M~1000M	+/- 3.9979
3M Semi Anechoic Chamber / 1G~8G	+/- 2.5790
3M Semi Anechoic Chamber / 8G~18G	+/- 2.5928
3M Semi Anechoic Chamber / 18G~26G	+/- 2.7212
3M Semi Anechoic Chamber / 26G~40G	+/- 2.9520

**Remark:** This uncertainty represents an expanded uncertainty expressed at approximately the 95% confidence level using a coverage factor of  $k=2$ .



## 5. FACILITIES AND ACCREDITATIONS

### 5.1 FACILITIES

All measurement facilities used to collect the measurement data are located at

No.199, Chunghsen Road, Hsintien City, Taipei Hsien, Taiwan, R.O.C.

Tel: 886-2-2217-0894 / Fax: 886-2-2217-1029

No.11, Wugong 6th Rd., Wugu Industrial Park, Taipei Hsien 248, Taiwan

Tel: 886-2-2299-9720 / Fax: 886-2-2298-4045

No.81-1, Lane 210, Bade 2nd Rd., Luchu Hsiang, Taoyuan Hsien 338, Taiwan

Tel: 886-3-324-0332 / Fax: 886-3-324-5235

The sites are constructed in conformance with the requirements of ANSI C63.7, ANSI C63.4 and CISPR Publication 22.

### 5.2 EQUIPMENT



Radiated emissions are measured with one or more of the following types of linearly polarized antennas: tuned dipole, biconical, log periodic, bi-log, and/or ridged waveguide, horn. Spectrum analyzers with pre-selectors and quasi-peak detectors are used to perform radiated measurements.

Conducted emissions are measured with Line Impedance Stabilization Networks and EMI Test Receivers.

Calibrated wideband preamplifiers, coaxial cables, and coaxial attenuators are also used for making measurements.

All receiving equipment conforms to CISPR Publication 16-1, "Radio Interference Measuring Apparatus and Measurement Methods."

### 5.3 TABLE OF ACCREDITATIONS AND LISTINGS

Country	Agency	Scope of Accreditation	Logo
USA	FCC	3M Semi Anechoic Chamber (FCC MRA: TW1039) to perform FCC Part 15 measurements	 FCC MRA: TW1039
Taiwan	TAF	LP0002, RTTE01, FCC Method-47 CFR Part 15 Subpart C, D, E, RSS-210, RSS-310 IDA TS SRD, AS/NZS 4268, AS/NZS 4771, TS 12.1 & 12.2, ETSI EN 300 440-1, ETSI EN 300 440-2, ETSI EN 300 328, ETSI EN 300 220-1, ETSI EN 300 220-2, ETSI EN 301 893, ETSI EN 301 489-1/3/7/17 FCC OET Bulletin 65 + Supplement C, EN 50360, EN 50361, EN 50371, RSS 102, EN 50383, EN 50385, EN 50392, IEC 62209, CNS 14958-1, CNS 14959 FCC Method -47 CFR Part 15 Subpart B IEC / EN 61000-3-2, IEC / EN 61000-3-3, IEC / EN 61000-4-2/3/4/5/6/8/11	
Canada	Industry Canada	3M Semi Anechoic Chamber (IC 2324G-1 / IC 2324G-2) to perform	 IC 2324G-1 IC 2324G-2

*\* No part of this report may be used to claim or imply product endorsement by A2LA or any agency of the US Government.*



## 6. SETUP OF EQUIPMENT UNDER TEST

### 6.1 SETUP CONFIGURATION OF EUT

See test photographs attached in Appendix II for the actual connections between EUT and support equipment.

### 6.2 SUPPORT EQUIPMENT

No.	Device Type	Brand	Model	Series No.	FCC ID	Data Cable	Power Cord
1.	Notebook PC	HP	dv6-1332TX	CNF9491GLJ	PD9112BNHU	N/A	AC I/P: Unshielded, 1.8m DC O/P: Unshielded, 1.8m with a core
2.	Notebook PC	ASUS	M5200AE	5BN0AG019631	PD9WM3B2100	N/A	AC I/P: Unshielded, 1.8m with a core DC O/P: Unshielded, 1.8m
3.	LCD Monitor	DELL	2407WFPb	CN-0FC255-46633-675-22 TJS	FCC DoC	Shielded, 1.8m with 2 cores	Unshielded, 1.8m
4.	USB Mouse	Logitech	M-UAG96B	HC8500L	FCC DoC	Shielded, 1.8m	N/A
5.	320GB 2.5" HDD	Seagate	9ZA2MG-500	2GE3NHH0	FCC DoC	Shielded, 1.8m	N/A
6.	Multimedia Earphone	Labtec	Axis-301	N/A	FCC DoC	Unshielded, 1.8m*2	N/A
7.	Wireless Router (Remote)	ASUS	WL-500g	471GA12838	MSQWL500G	N/A	Unshielded, 1.8m
8.	Notebook PC (Remote)	HP	dv6-1332TX	CNF9491GM9	PD9112BNHU	N/A	AC I/P: Unshielded, 1.8m DC O/P: Unshielded, 1.8m with a core

**Remark:**

1. All the equipment/cables were placed in the worst-case configuration to maximize the emission during the test.
2. Grounding was established in accordance with the manufacturer's requirements and conditions for the intended use.



## 7. FCC PART 15.247 REQUIREMENTS

### 7.1 6DB BANDWIDTH

#### LIMIT

According to §15.247(a)(2), systems using digital modulation techniques may operate in the 902 - 928 MHz, 2400 - 2483.5 MHz, and 5725 - 5850 MHz bands. The minimum 6 dB bandwidth shall be at least 500 kHz.

#### Test Configuration

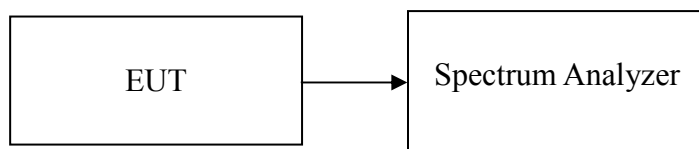

#### TEST PROCEDURE

1. Place the EUT on the table and set it in the transmitting mode.
2. Remove the antenna from the EUT and then connect a low loss RF cable from the antenna port to the spectrum analyzer.
3. Set the spectrum analyzer as RBW = 100kHz, VBW = RBW, Span = 50MHz, Sweep = auto.
4. Mark the peak frequency and -6dB (upper and lower) frequency.
5. Repeat until all the rest channels are investigated.

#### TEST RESULTS

*No non-compliance noted.*



**Test mode: IEEE 802.11b**

Channel	Frequency (MHz)	6dB Bandwidth (kHz)	Limit (kHz)	Result
Low	2412	9920	>500	PASS
Mid	2437	9750		PASS
High	2462	9920		PASS

**Test mode: IEEE 802.11g**

Channel	Frequency (MHz)	6dB Bandwidth (kHz)	Limit (kHz)	Result
Low	2412	16580	>500	PASS
Mid	2437	16580		PASS
High	2462	16580		PASS



### Test Plot

### IEEE 802.11b

### 6dB Bandwidth (CH Low)

Agilent 18:20:35 May 18, 2010

R T

Δ Mkr1 9.92 MHz  
-0.39 dB

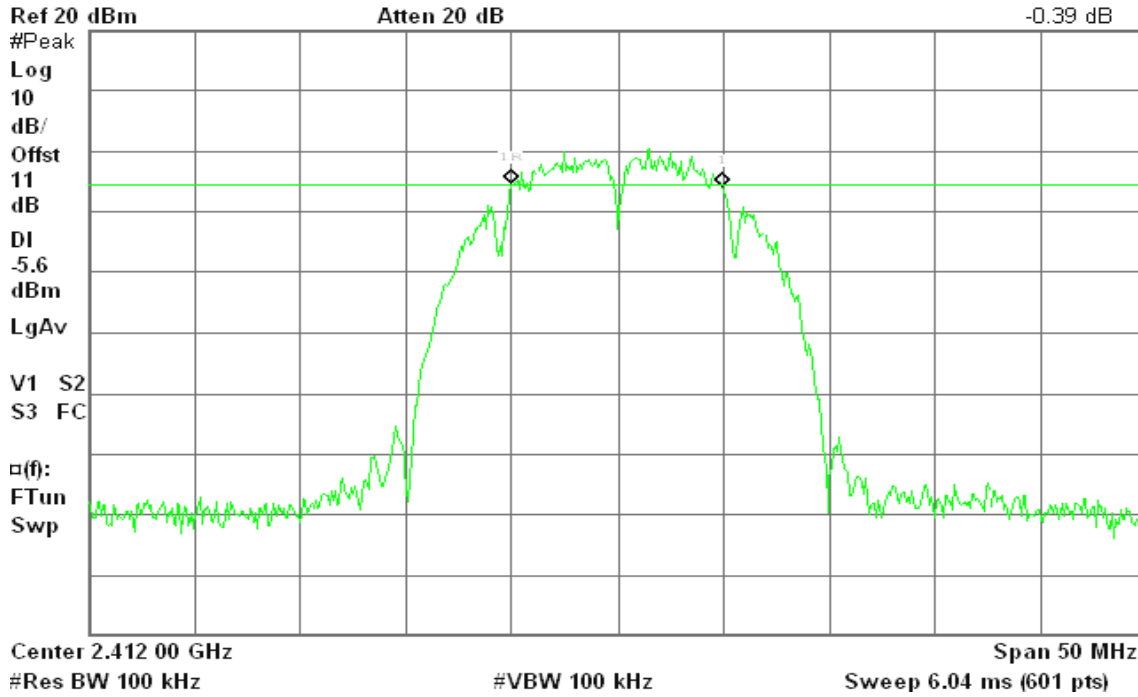

### 6dB Bandwidth (CH Mid)

Agilent 18:24:33 May 18, 2010

R L

Δ Mkr1 9.75 MHz  
0.50 dB

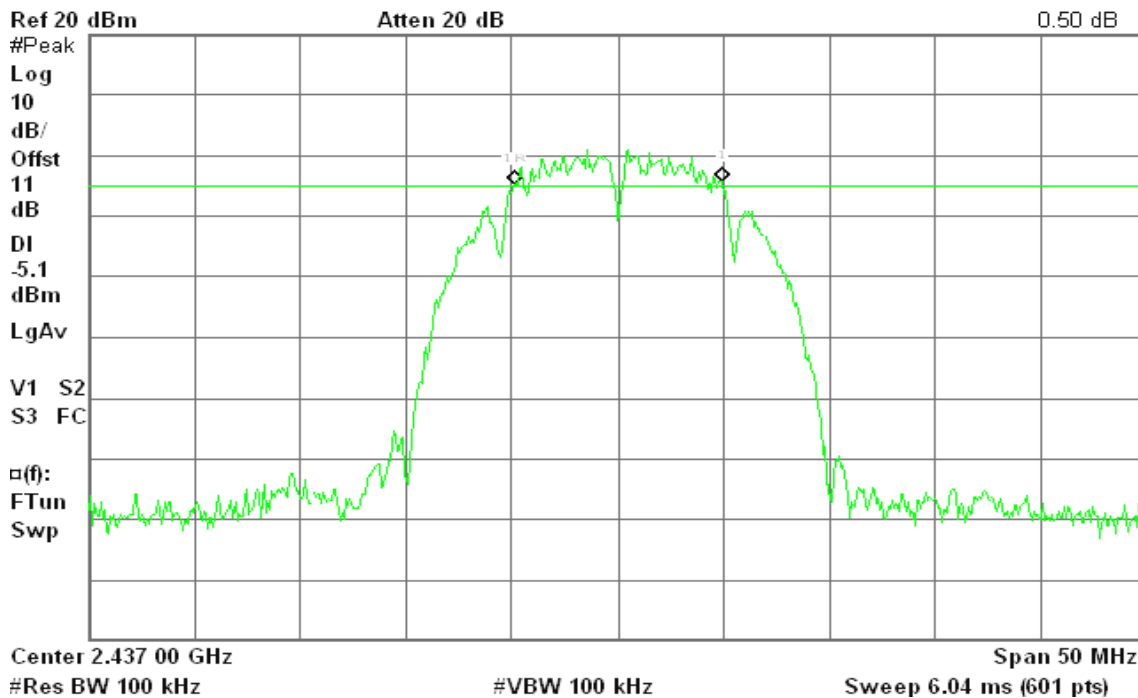



### 6dB Bandwidth (CH High)

Agilent 18:28:12 May 18, 2010

R T

Δ Mkr1 9.92 MHz  
0.78 dB

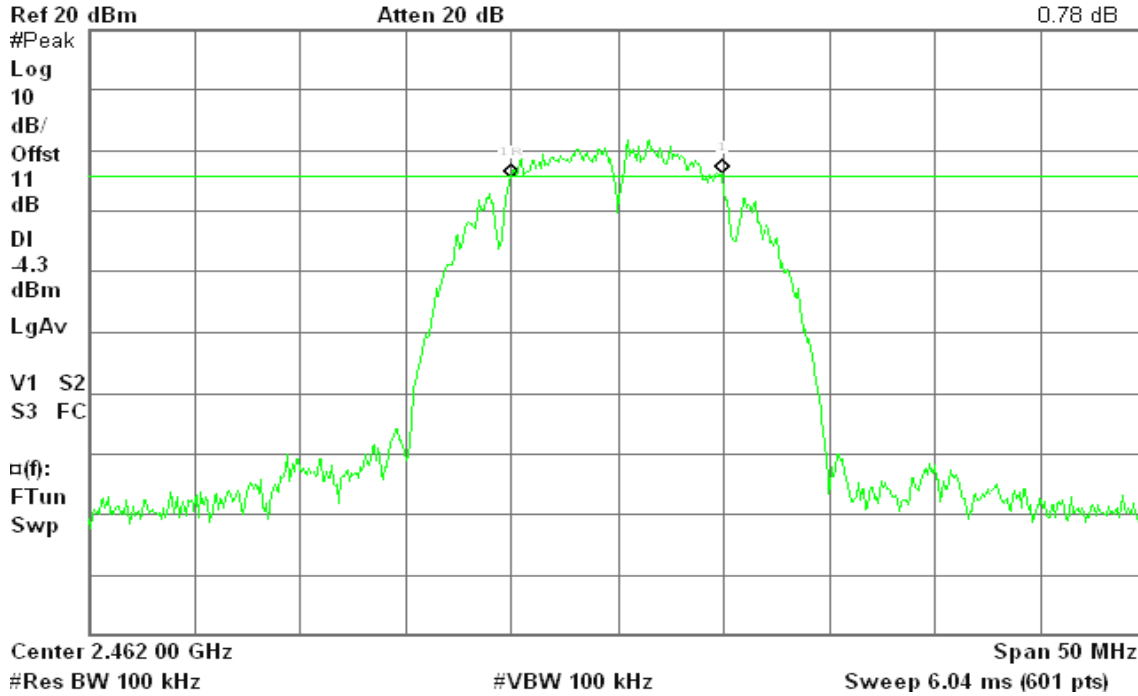

### IEEE 802.11g

### 6dB Bandwidth (CH Low)

Agilent 18:32:12 May 18, 2010

R T

Δ Mkr1 16.58 MHz  
2.49 dB

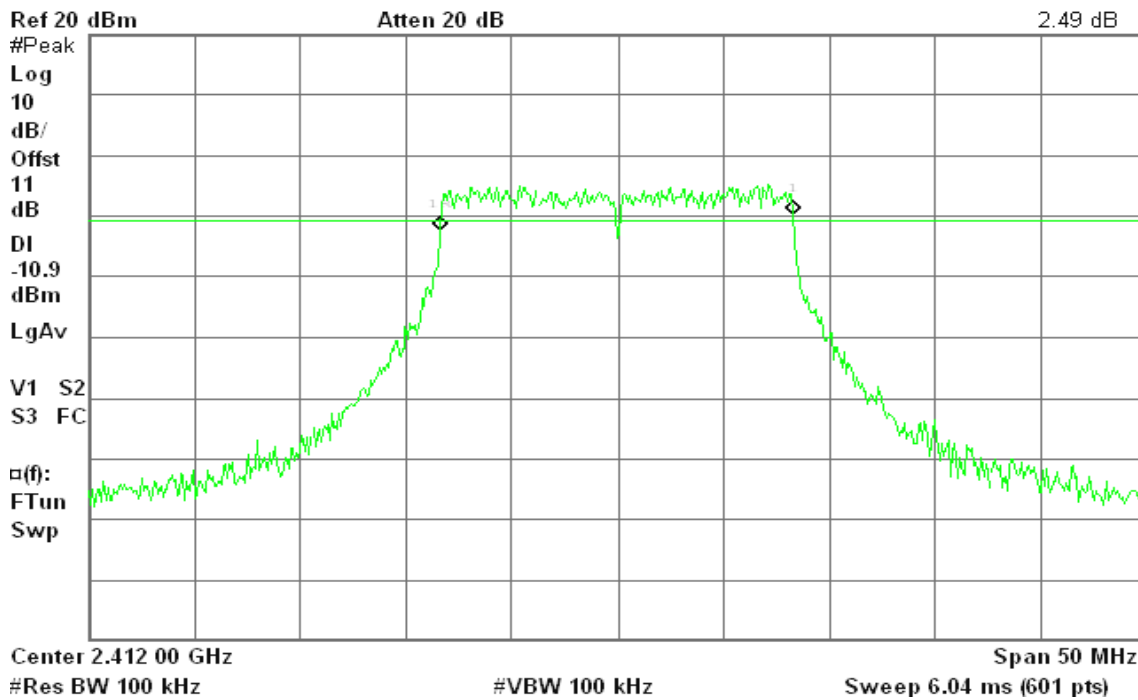





### 6dB Bandwidth (CH Mid)

Agilent 18:37:25 May 18, 2010

R T

Δ Mkr1 16.58 MHz  
2.64 dB

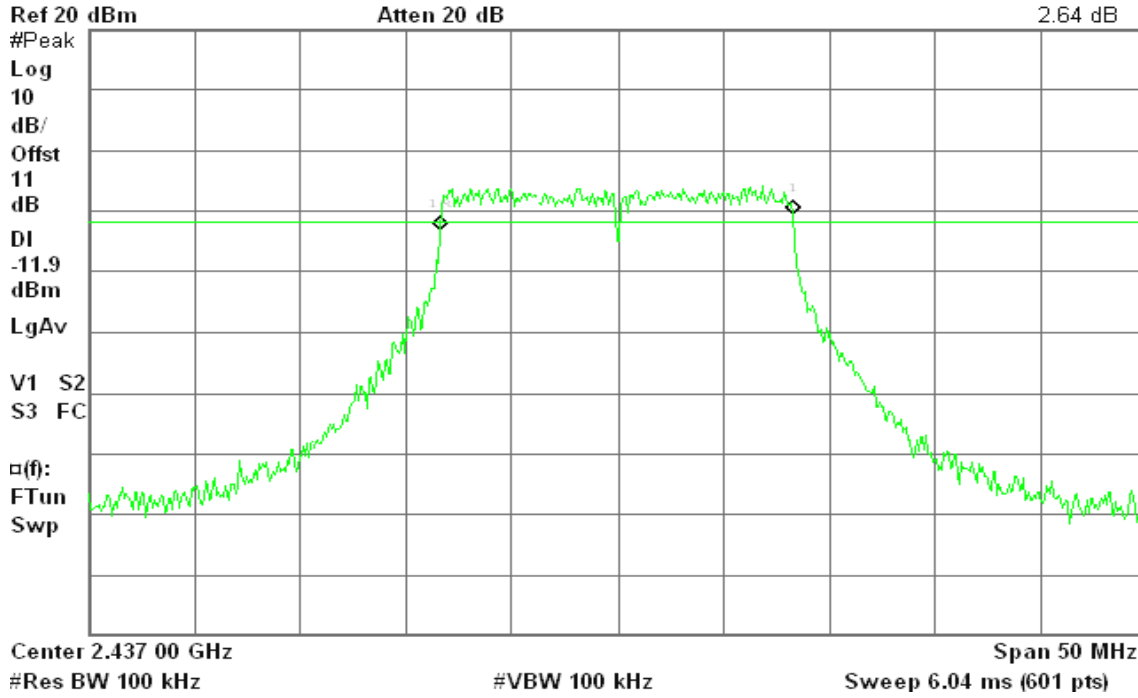

### 6dB Bandwidth (CH High)

Agilent 18:43:16 May 18, 2010

R T

Δ Mkr1 16.58 MHz  
1.84 dB

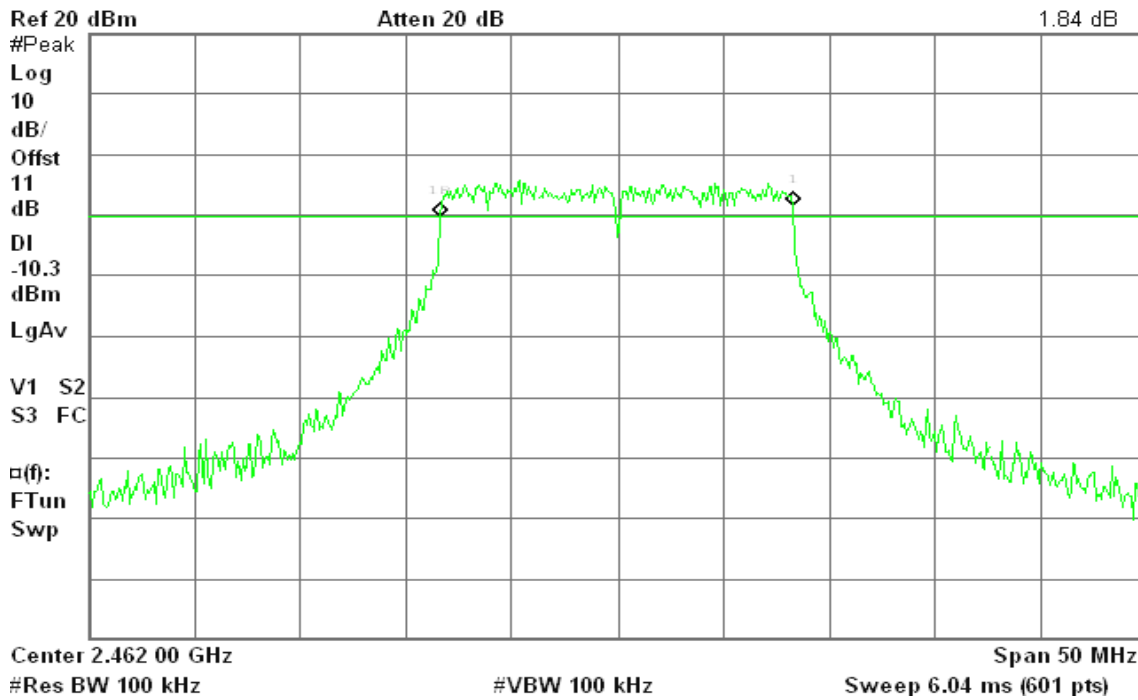



## 7.2 PEAK POWER

### LIMIT

The maximum peak output power of the intentional radiator shall not exceed the following:

1. According to §15.247(b)(3), for systems using digital modulation in the bands of 902-928 MHz, 2400-2483.5 MHz, and 5725-5850 MHz: 1 Watt.
2. According to §15.247(b)(4), the conducted output power limit specified in paragraph (b) of this section is based on the use of antennas with directional gains that do not exceed 6 dBi. Except as shown in paragraph (c) of this section, if transmitting antennas of directional gain greater than 6 dBi are used, the conducted output power from the intentional radiator shall be reduced below the stated values in paragraphs (b)(1), (b)(2), and (b)(3) of this section, as appropriate, by the amount in dB that the directional gain of the antenna exceeds 6 dBi.

### Test Configuration

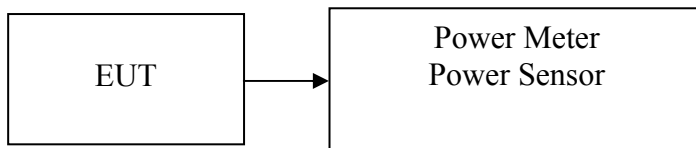

### TEST PROCEDURE

The transmitter output is connected to the Power Meter. The Power Meter is set to the peak power detection.

### Test Data

#### Test mode: IEEE 802.11b

Channel	Frequency (MHz)	Output Power (dBm)	Output Power (W)	Limit (W)	Result
Low	2412	15.55	0.0359	1.00	PASS
Mid	2437	15.85	0.0385		PASS
High	2462	16.14	0.0411		PASS

#### Test mode: IEEE 802.11g

Channel	Frequency (MHz)	Output Power (dBm)	Output Power (W)	Limit (W)	Result
Low	2412	20.23	0.1054	1.00	PASS
Mid	2437	20.11	0.1026		PASS
High	2462	19.97	0.0993		PASS



### 7.3 AVERAGE POWER

#### LIMIT

None; for reporting purposes only.

#### Test Configuration

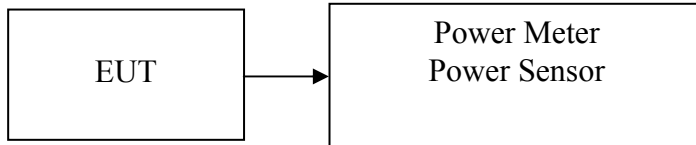

#### TEST PROCEDURE

The transmitter output is connected to the Power Meter. The Power Meter is set to the peak power detection.

#### Test Data

##### Test mode: IEEE 802.11b mode

Channel	Frequency (MHz)	Output Power (dBm)
Low	2412	13.09
Mid	2437	13.46
High	2462	13.79

##### Test mode: IEEE 802.11g mode

Channel	Frequency (MHz)	Output Power (dBm)
Low	2412	11.08
Mid	2437	11.06
High	2462	11.21

## 7.4 BAND EDGES MEASUREMENT

### LIMIT

According to §15.247(d), in any 100 kHz bandwidth outside the frequency bands in which the spread spectrum intentional radiator is operating, the radio frequency power that is produced by the intentional radiator shall be at least 20 dB below that in the 100 kHz bandwidth within the band that contains the highest level of the desired power, based on either an RF conducted or a radiated measurement, provided the transmitter demonstrates compliance with the peak conducted power limits. In addition, radiated emissions which fall in the restricted bands, as defined in §15.205(a), must also comply with the radiated emission limits specified in 15.209(a) (see Section 15.205(c)).

### Test Configuration

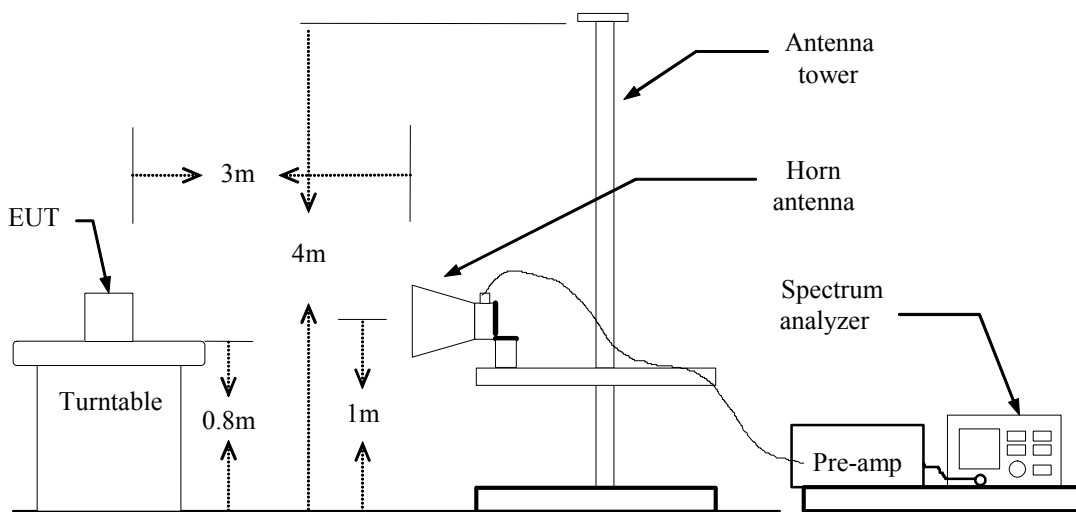

### TEST PROCEDURE

1. The EUT is placed on a turntable, which is 0.8m above the ground plane.
2. The turntable shall be rotated for 360 degrees to determine the position of maximum emission level.
3. EUT is set 3m away from the receiving antenna, which is varied from 1m to 4m to find out the highest emission.
4. Set the spectrum analyzer in the following setting in order to capture the lower and upper band-edges of the emission:
  - (a) PEAK: RBW=VBW=1MHz / Sweep=AUTO
  - (b) AVERAGE: RBW=1MHz / VBW=10Hz / Sweep=AUTO
5. Repeat the procedures until all the PEAK and AVERAGE versus POLARIZATION are measured.

### TEST RESULTS

Refer to attach spectrum analyzer data chart.



### Band Edges (IEEE 802.11b / CH Low)

Detector mode: Peak

Polarity: Vertical

Agilent 18:30:38 May 19, 2010

R T

Mkr2 2.400 0 GHz  
56.74 dBμV

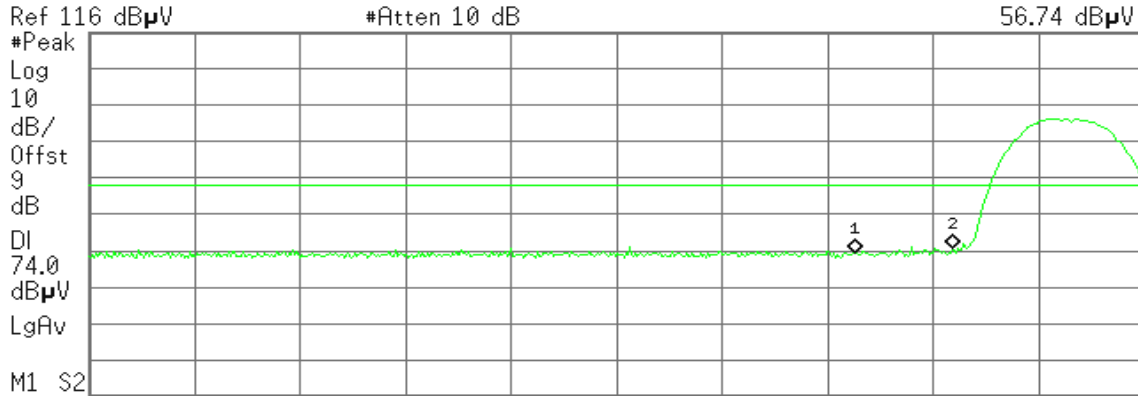

Marker	Trace	Type	X Axis	Amplitude
1	(1)	Freq	2.390 0 GHz	55.48 dBμU
2	(1)	Freq	2.400 0 GHz	56.74 dBμU

Detector mode: Average

Polarity: Vertical

Agilent 18:30:54 May 19, 2010

R T

Mkr2 2.400 0 GHz  
43.82 dBμV



Marker	Trace	Type	X Axis	Amplitude
1	(1)	Freq	2.390 0 GHz	43.16 dBμU
2	(1)	Freq	2.400 0 GHz	43.82 dBμU



Detector mode: Peak

Polarity: Horizontal

Agilent 18:28:59 May 19, 2010

R T

Mkr2 2.400 0 GHz  
58.38 dBμV

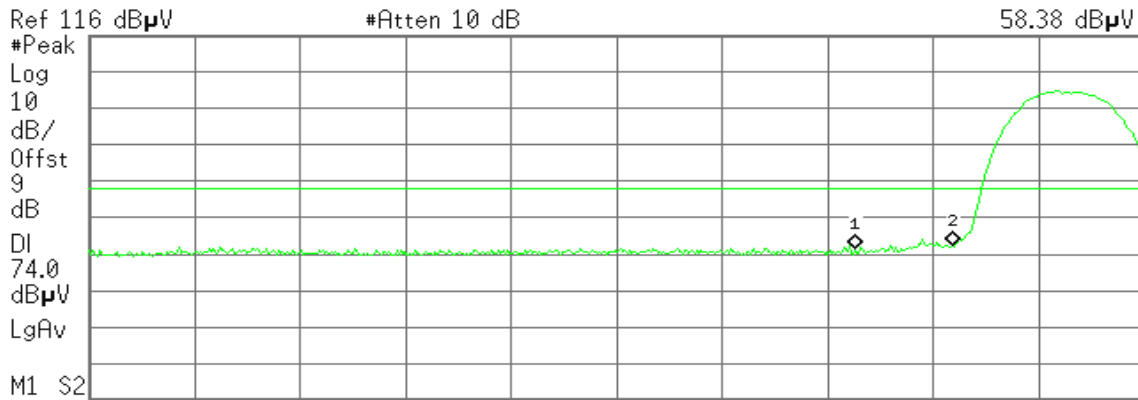

#Atten 10 dB #Res BW 1 MHz #VBW 1 MHz #Sweep 100 ms (601 pts)

Marker	Trace	Type	X Axis	Amplitude
1	(1)	Freq	2.390 0 GHz	57.65 dBμU
2	(1)	Freq	2.400 0 GHz	58.38 dBμU

Detector mode: Average

Polarity: Horizontal

Agilent 18:29:16 May 19, 2010

R T

Mkr2 2.400 0 GHz  
46.95 dBμV

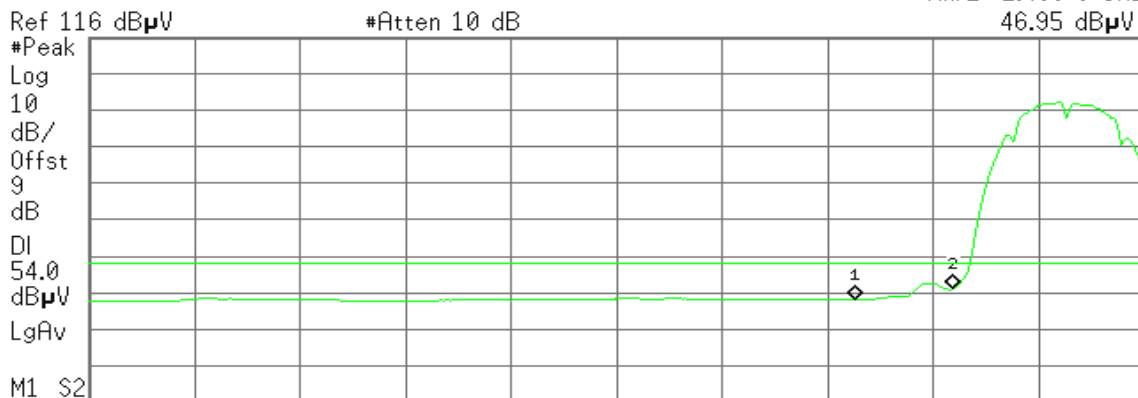

#Atten 10 dB #Res BW 1 MHz #VBW 10 Hz Sweep 8.577 s (601 pts)

Marker	Trace	Type	X Axis	Amplitude
1	(1)	Freq	2.390 0 GHz	44.19 dBμU
2	(1)	Freq	2.400 0 GHz	46.95 dBμU



### Band Edges (IEEE 802.11b / CH High)

Detector mode: Peak

Polarity: Vertical

Agilent 18:36:53 May 19, 2010

R T

Mkr2 2.476 60 GHz  
57.76 dB $\mu$ V

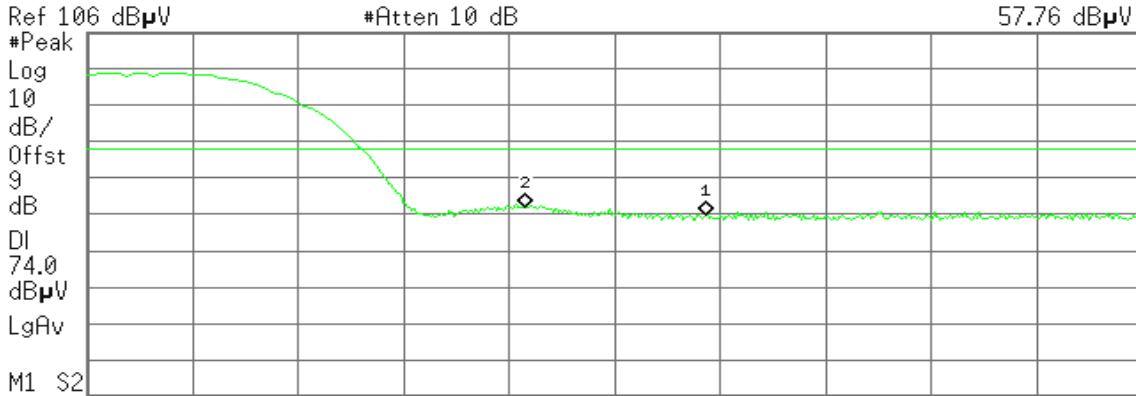

Start 2.460 00 GHz Stop 2.500 00 GHz  
#Res BW 1 MHz #VBW 1 MHz #Sweep 100 ms (601 pts)

Marker	Trace	Type	X Axis	Amplitude
1	(1)	Freq	2.483 50 GHz	55.64 dB $\mu$ U
2	(1)	Freq	2.476 60 GHz	57.76 dB $\mu$ U

Detector mode: Average

Polarity: Vertical

Agilent 18:36:29 May 19, 2010

R T

Mkr2 2.476 60 GHz  
48.32 dB $\mu$ V

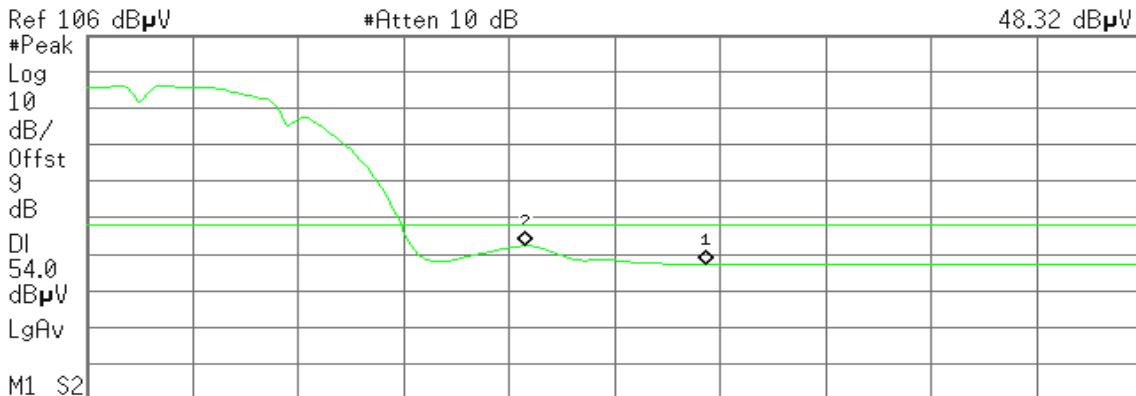

Start 2.460 00 GHz Stop 2.500 00 GHz  
#Res BW 1 MHz #VBW 10 Hz Sweep 3.119 s (601 pts)

Marker	Trace	Type	X Axis	Amplitude
1	(1)	Freq	2.483 50 GHz	43.30 dB $\mu$ U
2	(1)	Freq	2.476 60 GHz	48.32 dB $\mu$ U



Detector mode: Peak

Polarity: Horizontal

Agilent 18:39:49 May 19, 2010

R T

Mkr2 2.476 73 GHz  
59.67 dBμV

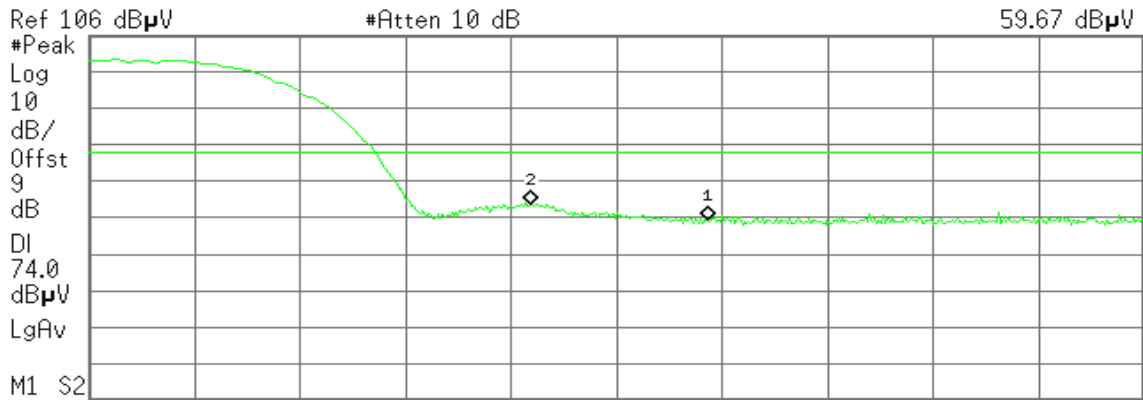

Start 2.460 00 GHz Stop 2.500 00 GHz  
#Res BW 1 MHz #VBW 1 MHz #Sweep 100 ms (601 pts)

Marker	Trace	Type	X Axis	Amplitude
1	(1)	Freq	2.483 58 GHz	55.18 dBμU
2	(1)	Freq	2.476 73 GHz	59.67 dBμU

Detector mode: Average

Polarity: Horizontal

Agilent 18:39:33 May 19, 2010

R T

Mkr2 2.476 73 GHz  
51.11 dBμV

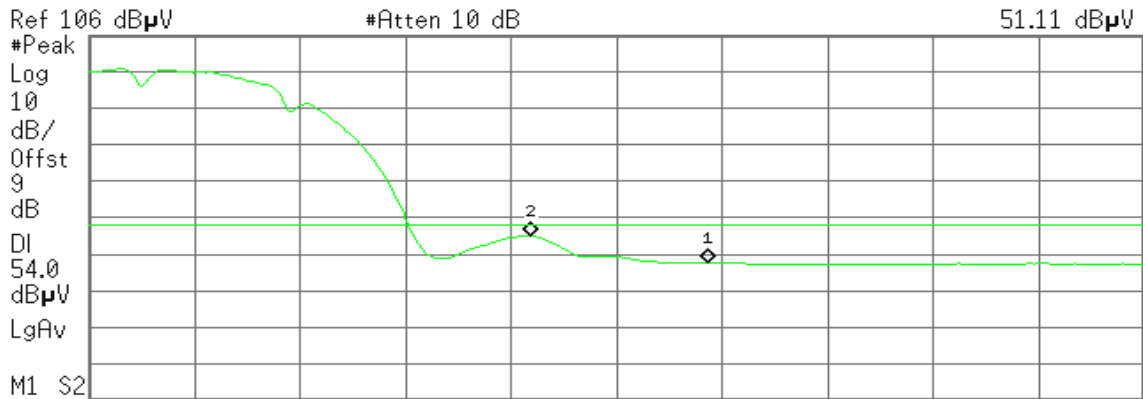

Start 2.460 00 GHz Stop 2.500 00 GHz  
#Res BW 1 MHz #VBW 10 Hz Sweep 3.119 s (601 pts)

Marker	Trace	Type	X Axis	Amplitude
1	(1)	Freq	2.483 58 GHz	43.55 dBμU
2	(1)	Freq	2.476 73 GHz	51.11 dBμU





### Band Edges (IEEE 802.11g / CH Low)

Detector mode: Peak

Polarity: Vertical

Agilent 19:22:21 May 19, 2010

R T

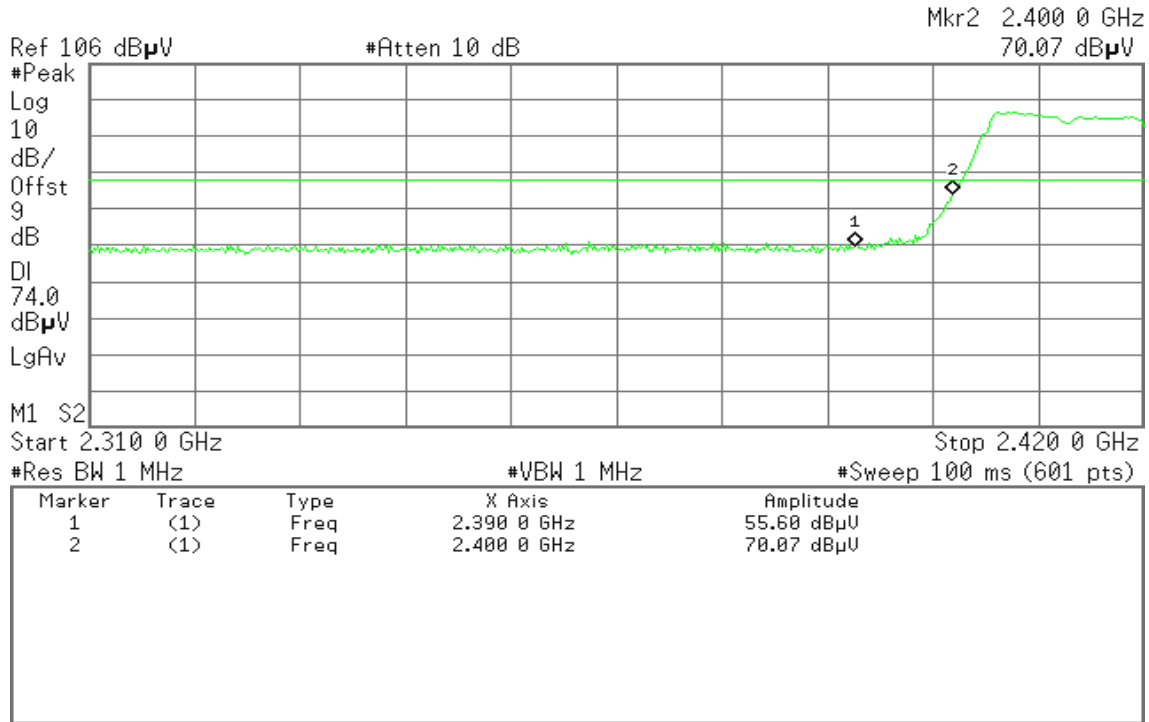

Detector mode: Average

Polarity: Vertical

Agilent 19:22:02 May 19, 2010

R T

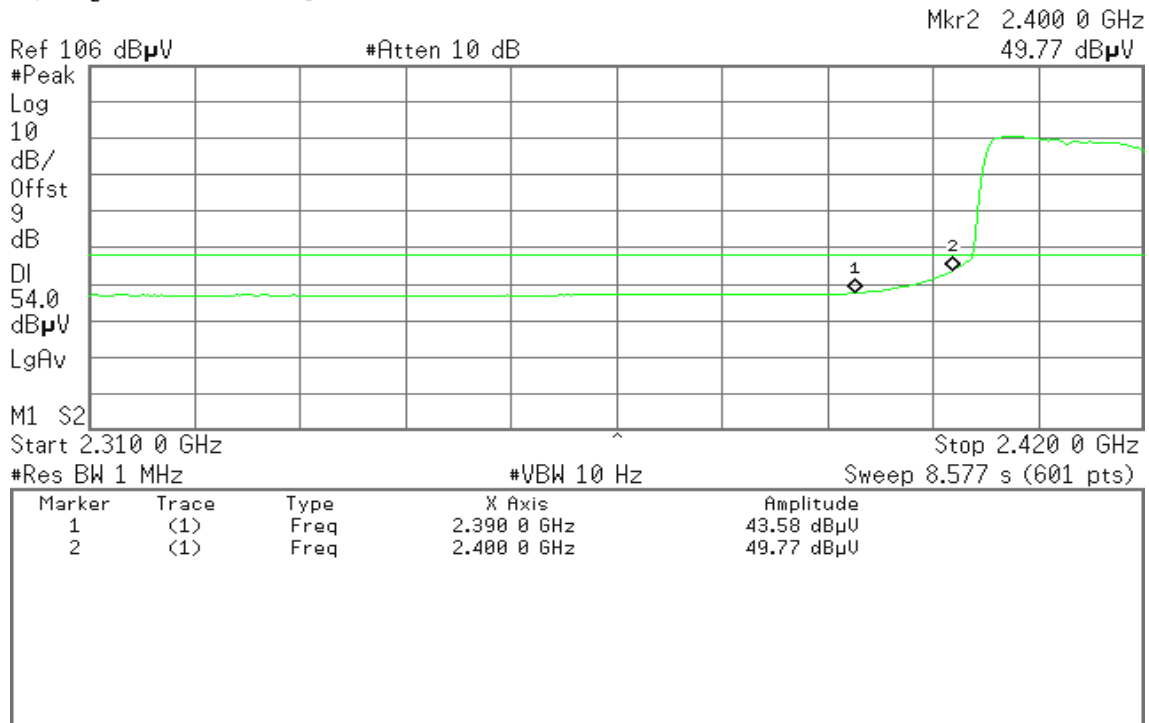



Detector mode: Peak

Polarity: Horizontal

Agilent 19:26:15 May 19, 2010

R T

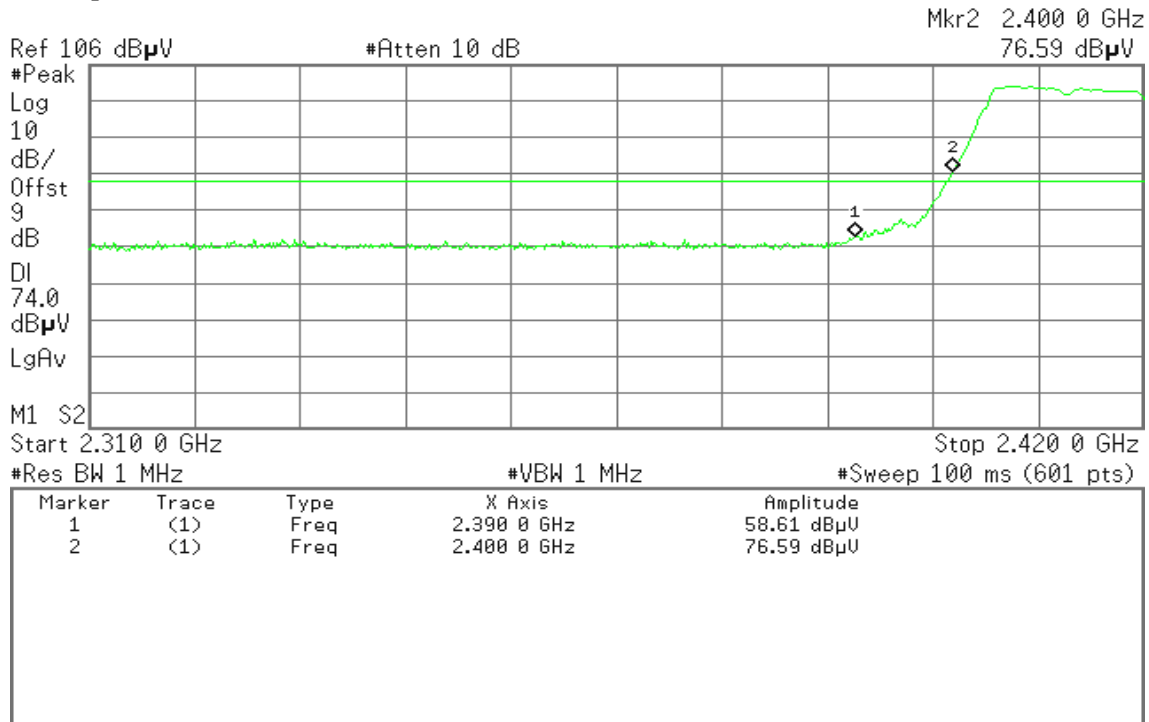

Detector mode: Average

Polarity: Horizontal

Agilent 19:26:45 May 19, 2010

R T

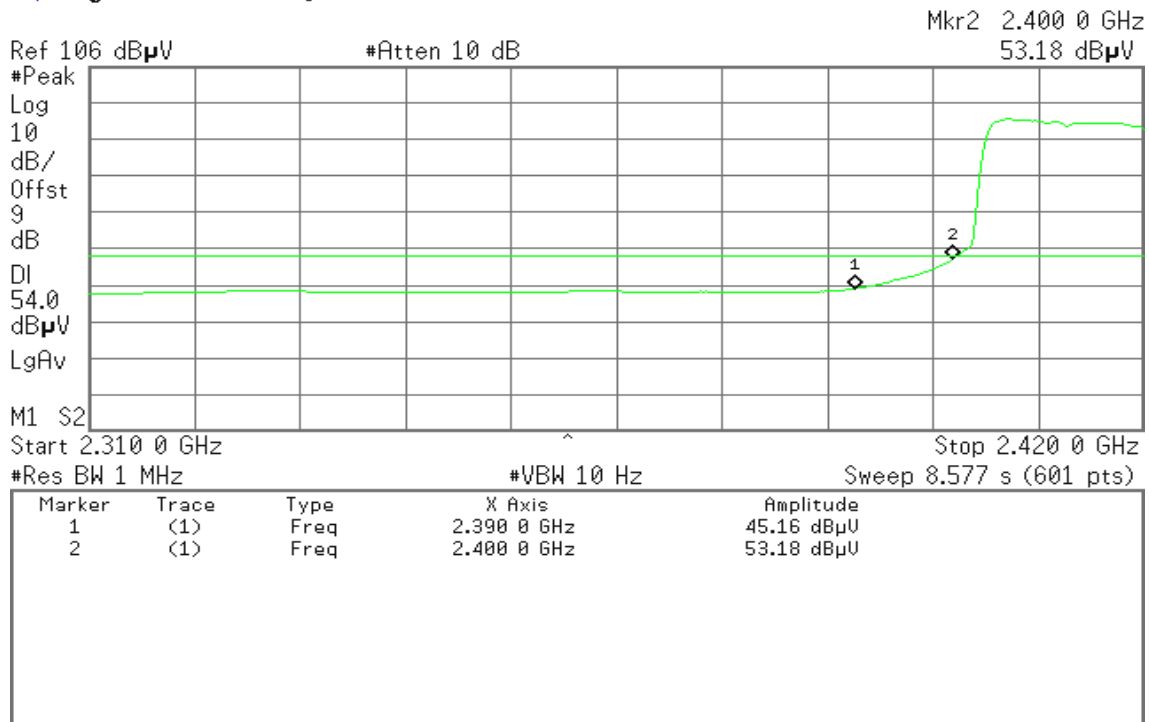



### Band Edges (IEEE 802.11g / CH High)

Detector mode: Peak

Polarity: Vertical

Agilent 18:51:42 May 19, 2010

R T

Mkr1 2.483 50 GHz  
56.39 dB $\mu$ V

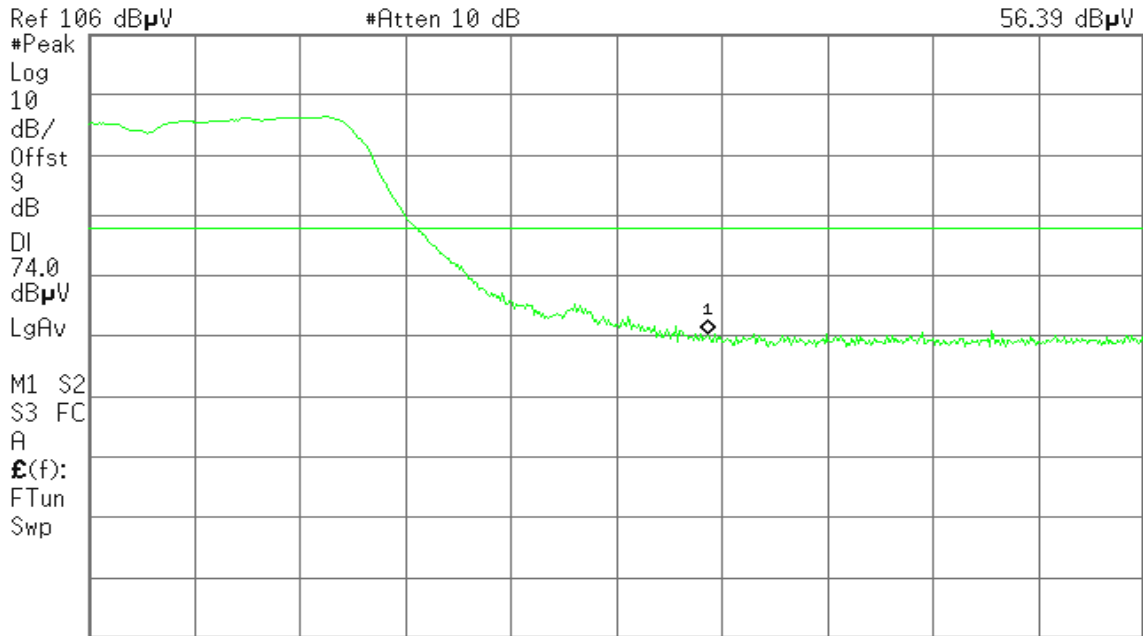

Start 2.460 00 GHz Stop 2.500 00 GHz  
#Res BW 1 MHz #VBW 1 MHz #Sweep 100 ms (601 pts)

Detector mode: Average

Polarity: Vertical

Agilent 18:51:55 May 19, 2010

R T

Mkr1 2.483 50 GHz  
43.66 dB $\mu$ V

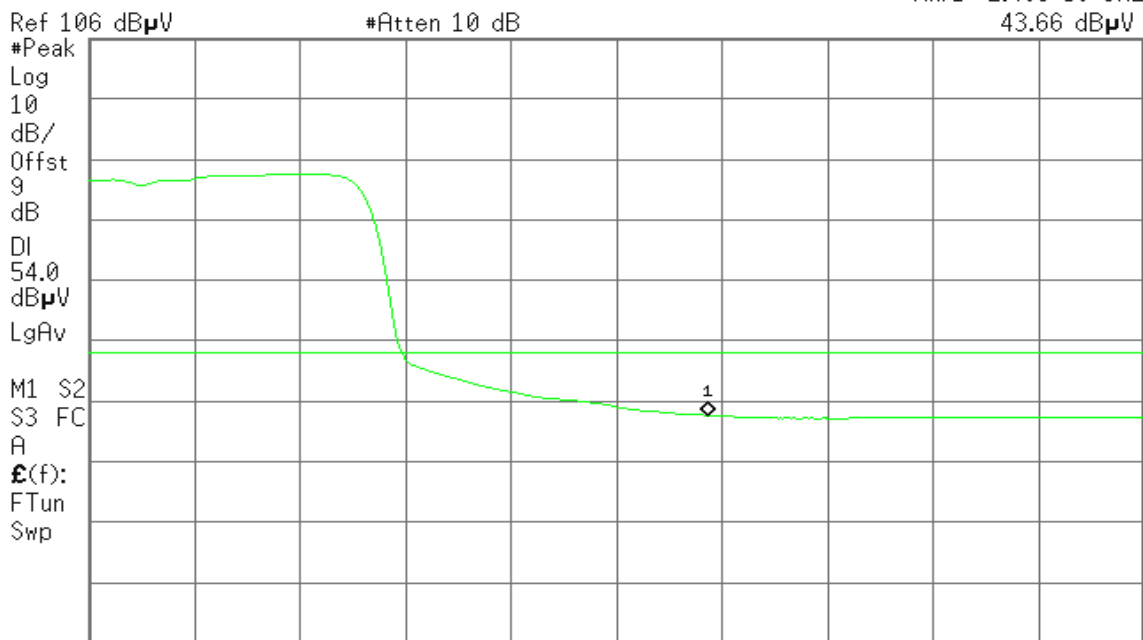

Start 2.460 00 GHz Stop 2.500 00 GHz  
#Res BW 1 MHz #VBW 10 Hz Sweep 3.119 s (601 pts)



Detector mode: Peak

Polarity: Horizontal

Agilent 19:32:39 May 19, 2010

R T

Mkr1 2.483 50 GHz  
59.11 dBµV

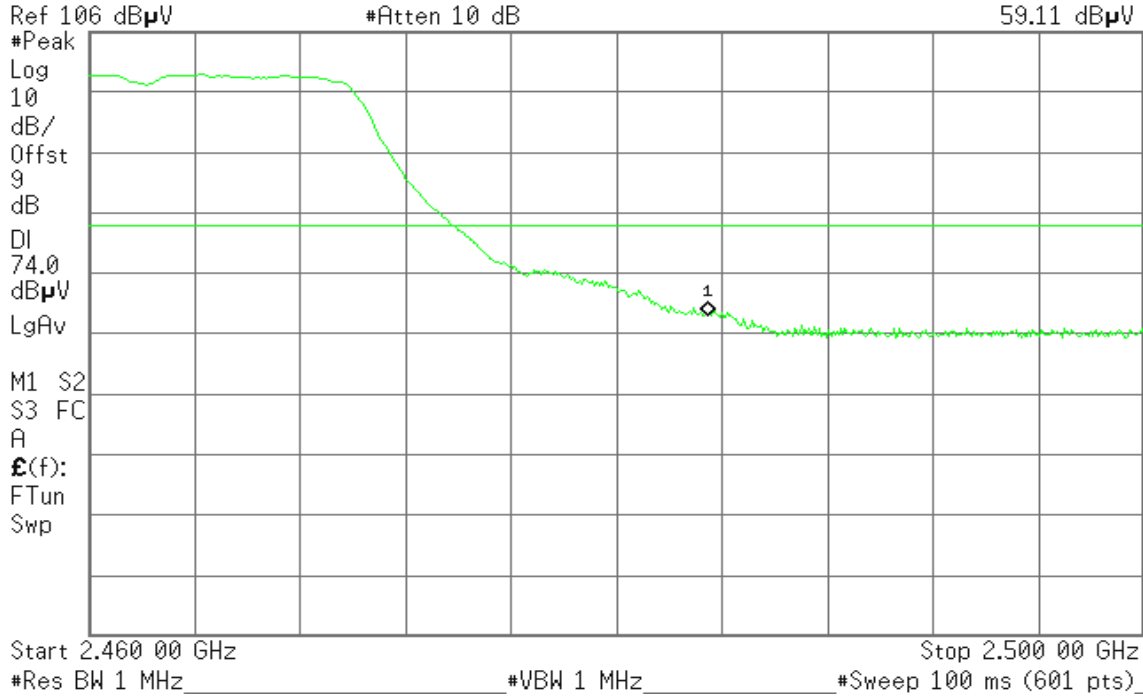

Detector mode: Average

Polarity: Horizontal

Agilent 19:32:58 May 19, 2010

R T

Mkr1 2.483 50 GHz  
45.13 dBµV

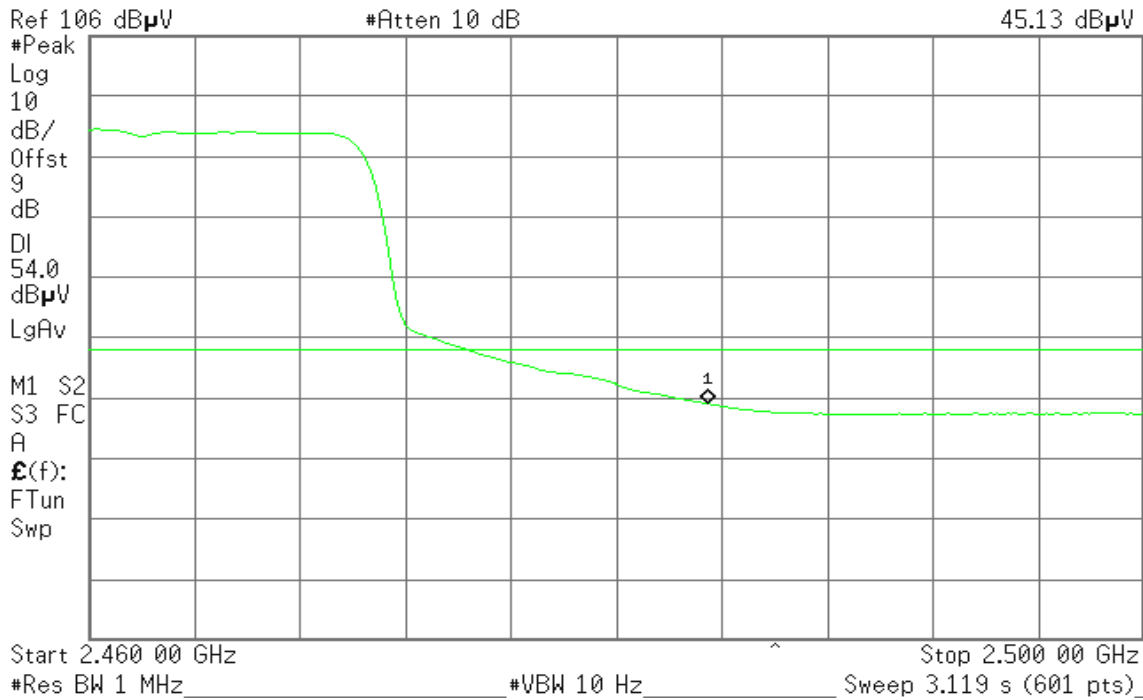



## 7.5 PEAK POWER SPECTRAL DENSITY

### LIMIT

1. According to §15.247(e), for digitally modulated systems, the power spectral density conducted from the intentional radiator to the antenna shall not be greater than 8 dBm in any 3 kHz band during any time interval of continuous transmission.
2. According to §15.247(f), the digital modulation operation of the hybrid system, with the frequency hopping turned off, shall comply with the power density requirements of paragraph (d) of this section.

### Test Configuration

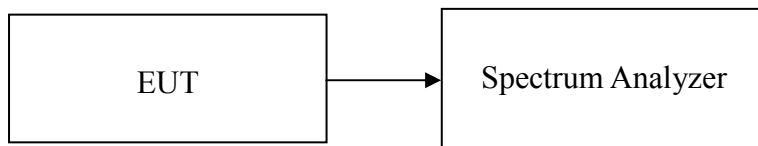

### TEST PROCEDURE

1. Place the EUT on the table and set it in transmitting mode.  
Remove the antenna from the EUT and then connect a low loss RF cable from the antenna port to the spectrum analyzer.
2. Set the spectrum analyzer as RBW = 3kHz, VBW = 10kHz, Span = 300kHz, Sweep=100s
3. Record the max. reading.
4. Repeat the above procedure until the measurements for all frequencies are completed.

### TEST RESULTS

*No non-compliance noted.*



**Test Data**

**Test mode: IEEE 802.11b**

Channel	Frequency (MHz)	PPSD (dBm)	Limit (dBm)	Result
Low	2412	-17.50	8.00	PASS
Mid	2437	-16.86		PASS
High	2462	-16.24		PASS

**Test mode: IEEE 802.11g**

Channel	Frequency (MHz)	PPSD (dBm)	Limit (dBm)	Result
Low	2412	-17.12	8.00	PASS
Mid	2437	-20.13		PASS
High	2462	-18.54		PASS



Test Plot

IEEE 802.11b

PPSD (CH Low)

Agilent 18:23:17 May 18, 2010

R T

Mkr1 2.412 699 6 GHz  
-17.50 dBm

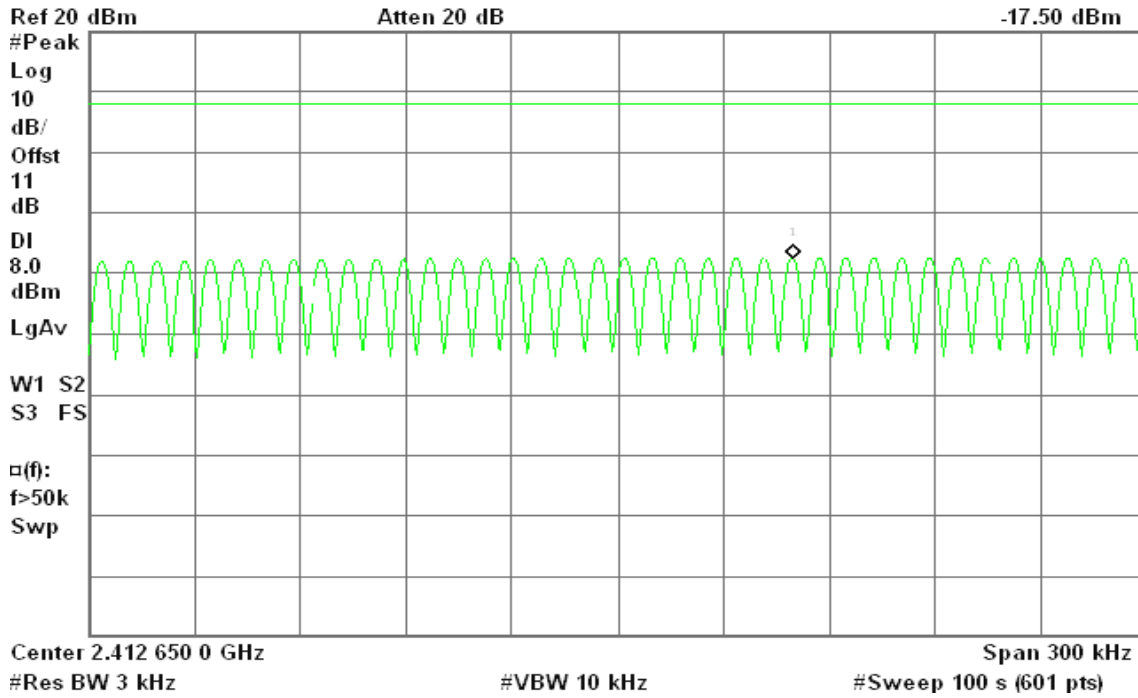

PPSD (CH Mid)

Agilent 18:27:07 May 18, 2010

R L

Mkr1 2.437 675 0 GHz  
-16.86 dBm

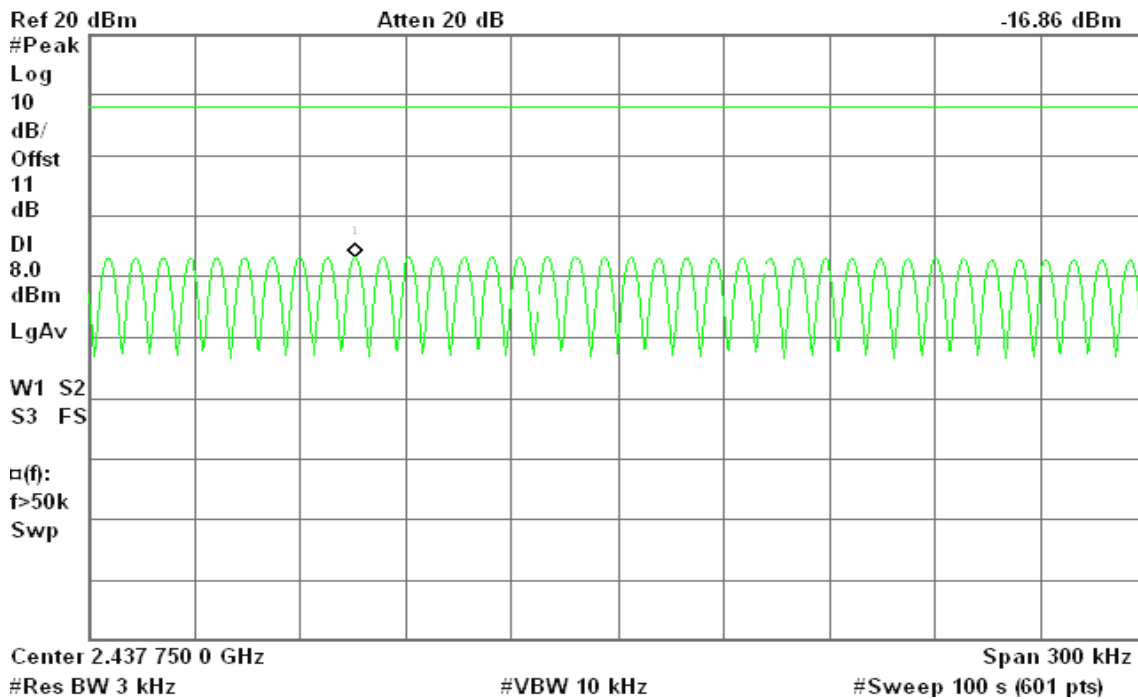



### PPSD (CH High)

Agilent 18:30:42 May 18, 2010

R T

Mkr1 2.461 289 0 GHz  
-16.24 dBm

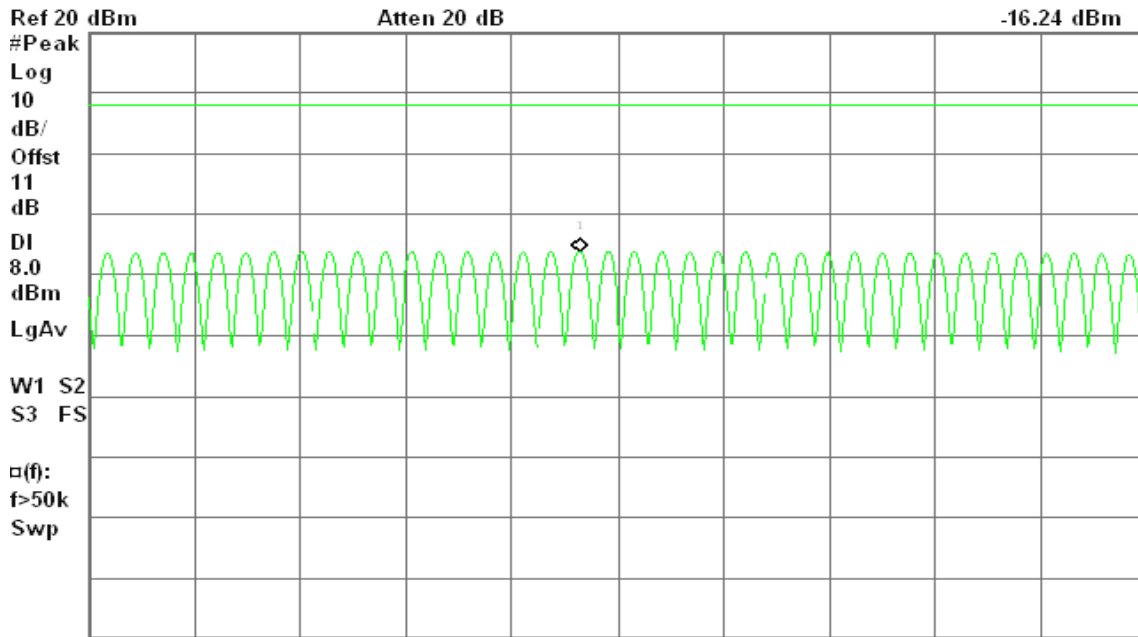

Center 2.461 300 0 GHz      Span 300 kHz  
#Res BW 3 kHz      #VBW 10 kHz      #Sweep 100 s (601 pts)

### IEEE 802.11g

### PPSD (CH Low)

Agilent 18:34:42 May 18, 2010

R T

Mkr1 2.411 990 5 GHz  
-17.12 dBm

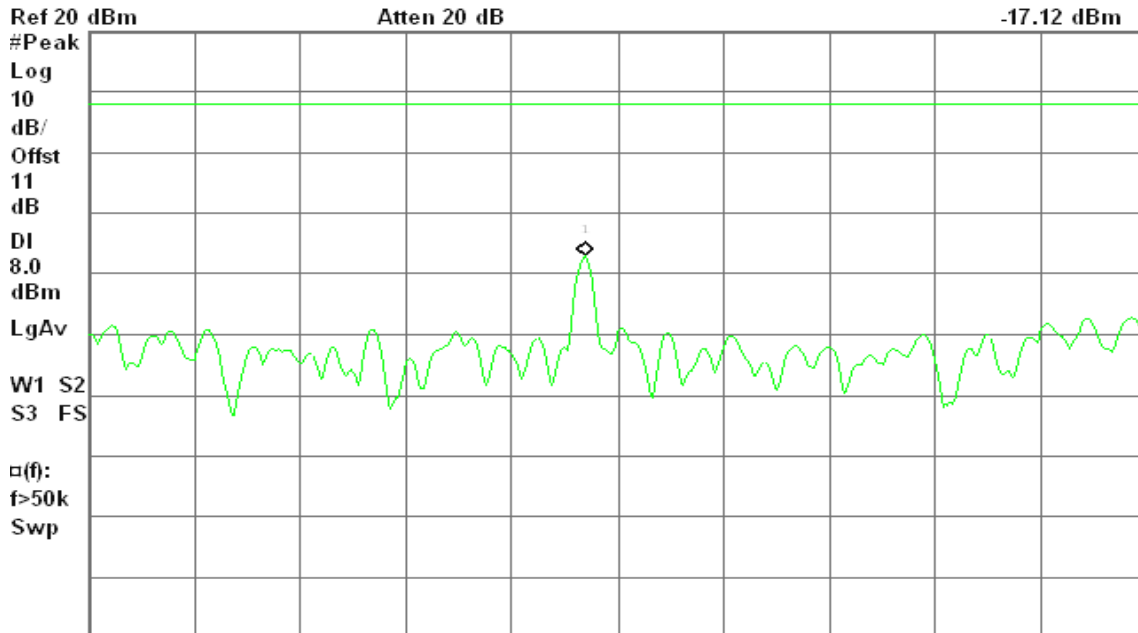

Center 2.412 000 0 GHz      Span 300 kHz  
#Res BW 3 kHz      #VBW 10 kHz      #Sweep 100 s (601 pts)





### PPSD (CH Mid)

Agilent 18:39:58 May 18, 2010

R T

Mkr1 2.436 055 0 GHz  
-20.13 dBm

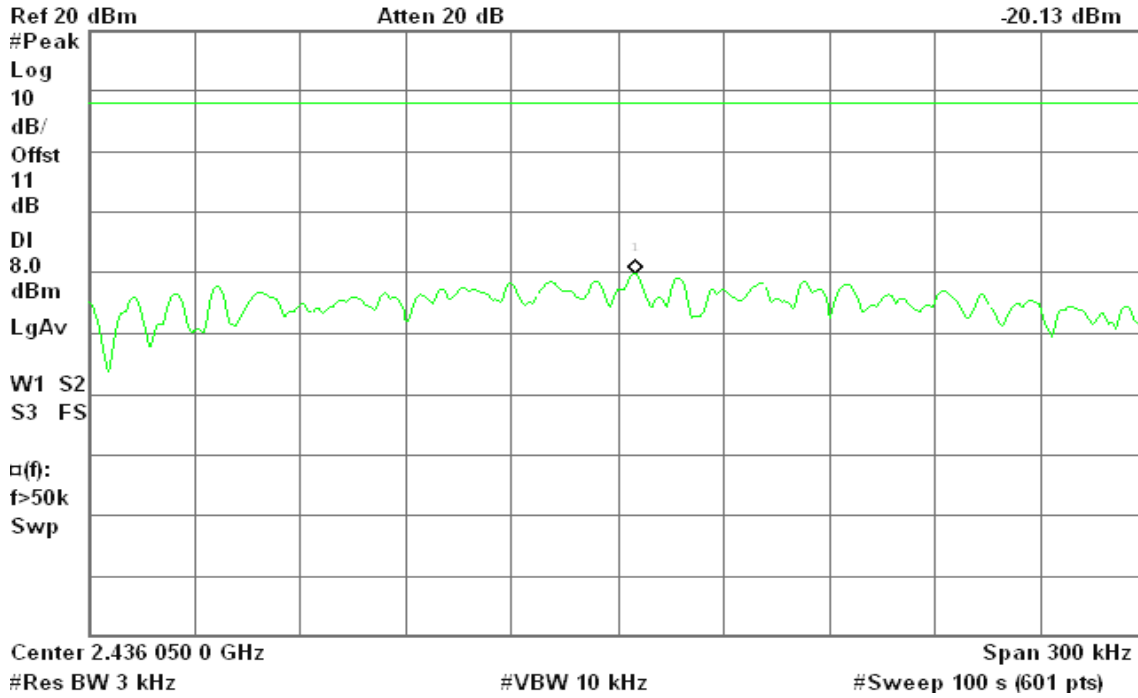

### PPSD (CH High)

Agilent 18:46:49 May 18, 2010

R T

Mkr1 2.455 102 0 GHz  
-18.54 dBm

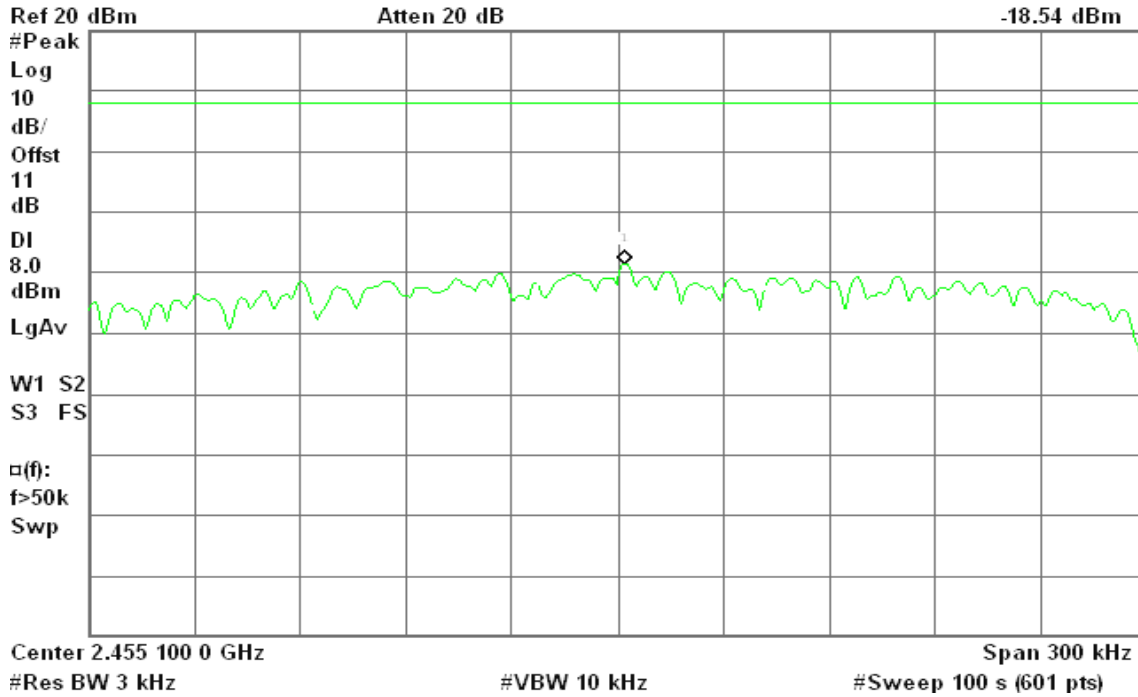



## 7.6 SPURIOUS EMISSIONS

### 7.6.1 Conducted Measurement

#### LIMIT

According to §15.247(d), in any 100 kHz bandwidth outside the frequency bands in which the spread spectrum intentional radiator is operating, the radio frequency power that is produced by the intentional radiator shall be at least 20 dB below that in the 100 kHz bandwidth within the band that contains the highest level of the desired power, based on either an RF conducted or a radiated measurement, provided the transmitter demonstrates compliance with the peak conducted power limits. In addition, radiated emissions which fall in the restricted bands, as defined in §15.205(a), must also comply with the radiated emission limits specified in 15.209(a) (see Section 15.205(c)).

#### Test Configuration

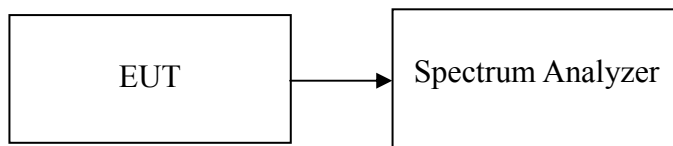

#### TEST PROCEDURE

Conducted RF measurements of the transmitter output were made to confirm that the EUT antenna port conducted emissions meet the specified limit and to identify any spurious signals that require further investigation or measurements on the radiated emissions site.

The transmitter output is connected to the spectrum analyzer. The resolution bandwidth is set to 100 kHz. The video bandwidth is set to 100 kHz.

Measurements are made over the 13GHz to 26GHz range with the transmitter set to the lowest, middle, and highest channels.

#### TEST RESULTS

*No non-compliance noted.*



Test Plot

IEEE 802.11b

CH Low

Agilent 18:23:59 May 18, 2010

R T

Mkr1 2.42 GHz  
0.28 dBm

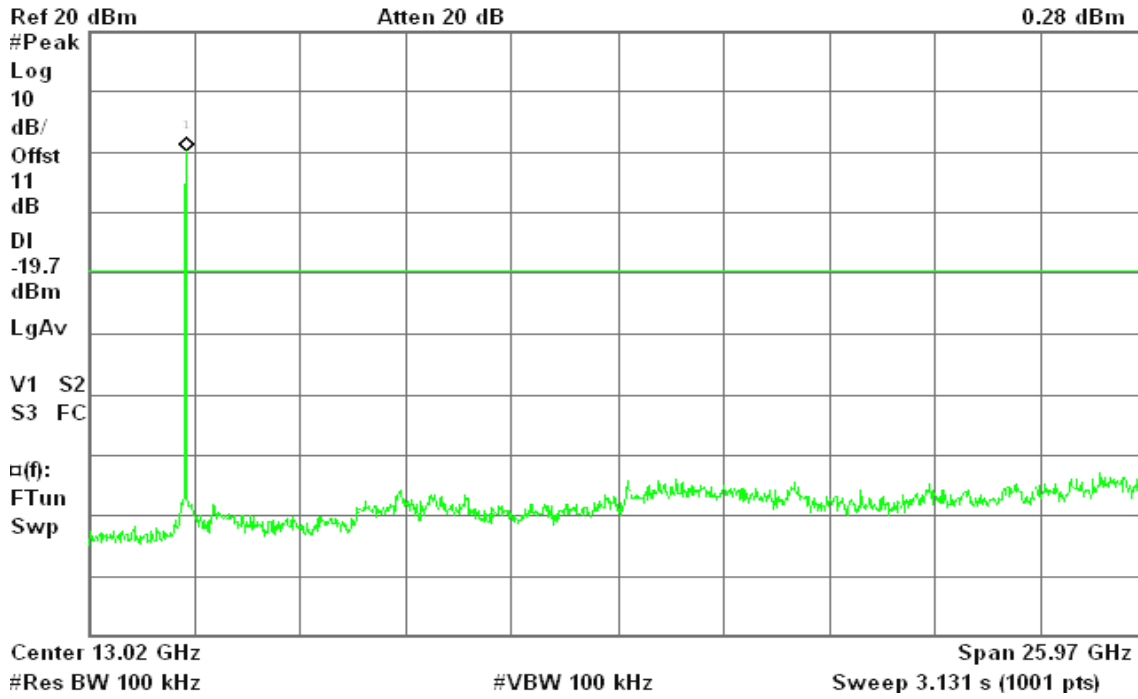

CH Mid

Agilent 18:27:41 May 18, 2010

R T

Mkr1 2.45 GHz  
-0.58 dBm

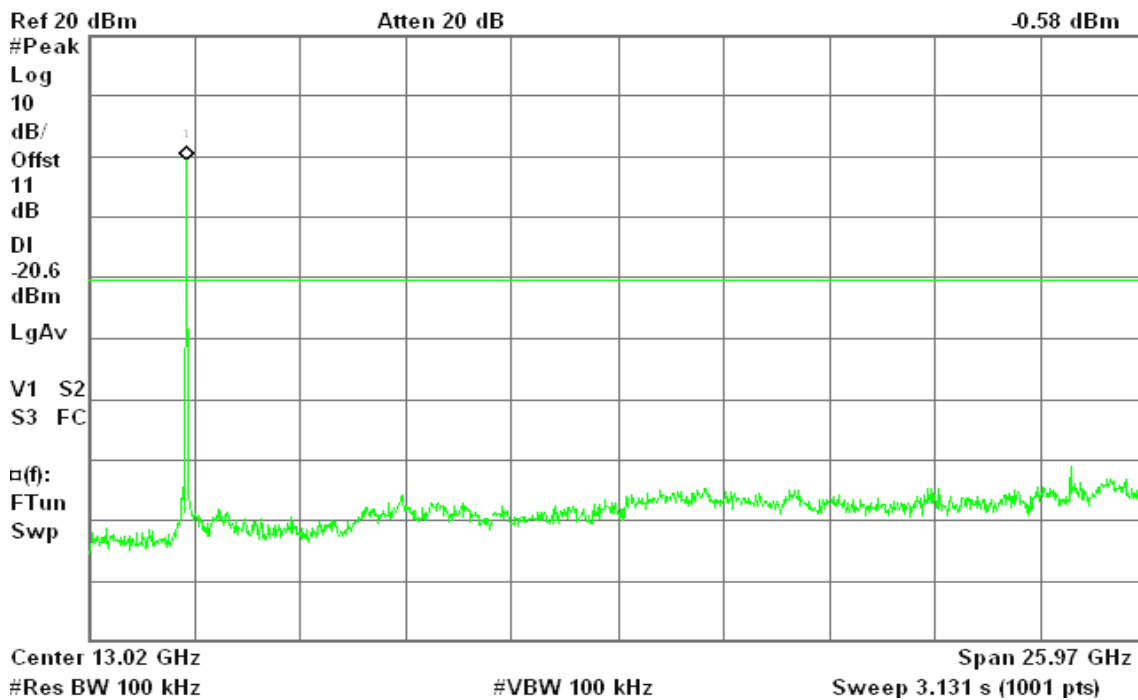



### CH High

Agilent 18:31:20 May 18, 2010

R L

Mkr1 2.47 GHz  
0.34 dBm

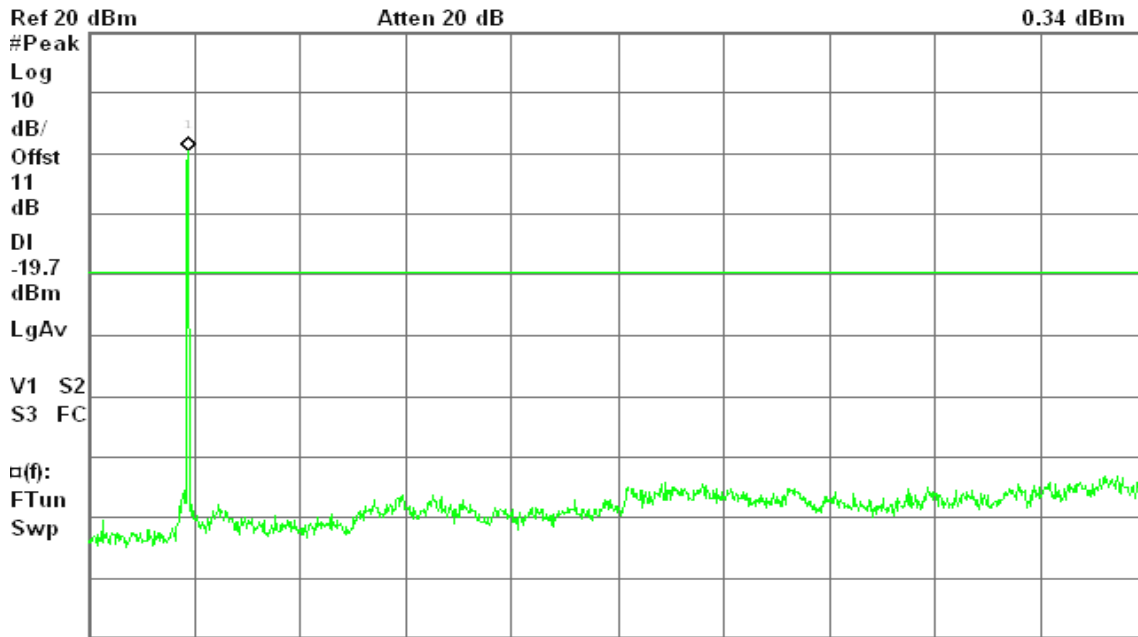

Center 13.02 GHz

Span 25.97 GHz

#Res BW 100 kHz

#VBW 100 kHz

Sweep 3.131 s (1001 pts)

### IEEE 802.11g

#### CH Low

Agilent 18:36:50 May 18, 2010

R L

Mkr1 2.42 GHz  
-5.41 dBm

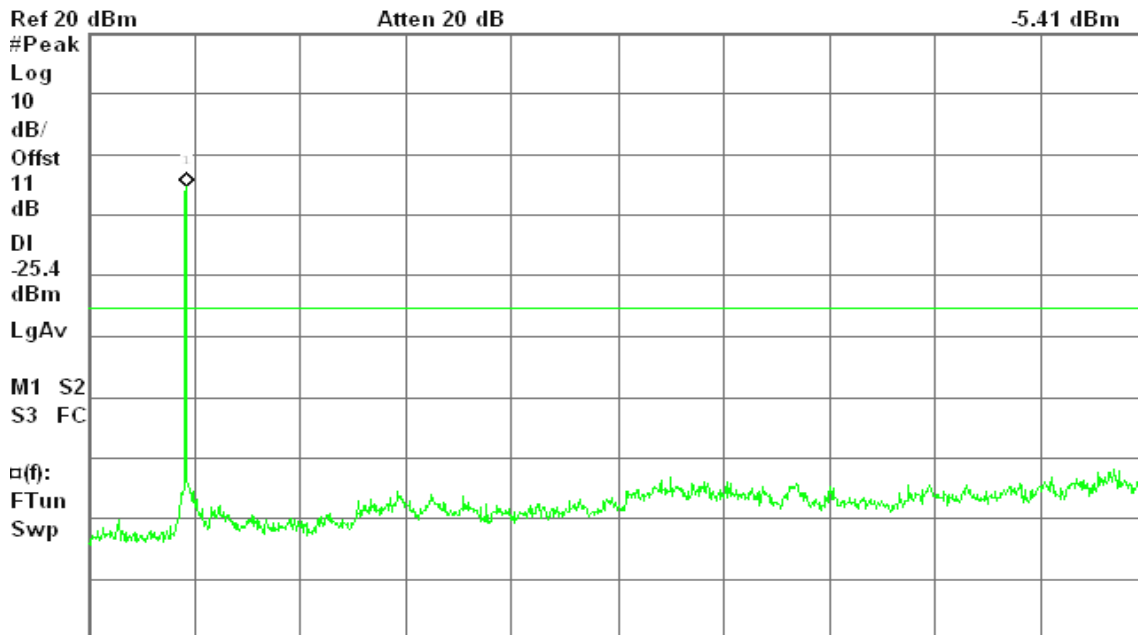

Center 13.02 GHz

Span 25.97 GHz

#Res BW 100 kHz

#VBW 100 kHz

Sweep 3.131 s (1001 pts)





### 7.6.2 Radiated Emissions

#### LIMIT

1. According to §15.209(a), except as provided elsewhere in this Subpart, the emissions from an intentional radiator shall not exceed the field strength levels specified in the following table:

Frequency (MHz)	Field Strength ( $\mu\text{V/m}$ )	Measurement Distance (m)
30-88	100*	3
88-216	150*	3
216-960	200*	3
Above 960	500	3

**Remark:** Except as provided in paragraph (g), fundamental emissions from intentional radiators operating under this Section shall not be located in the frequency bands 54-72 MHz, 76-88 MHz, 174-216 MHz or 470-806 MHz. However, operation within these frequency bands is permitted under other sections of this Part, e.g., Sections 15.231 and 15.241.

2. In the emission table above, the tighter limit applies at the band edges.

Frequency (MHz)	Field Strength ( $\mu\text{V/m}$ at 3-meter)	Field Strength (dB $\mu\text{V/m}$ at 3-meter)
30-88	100	40
88-216	150	43.5
216-960	200	46
Above 960	500	54

### Test Configuration

#### 9kHz ~ 30MHz

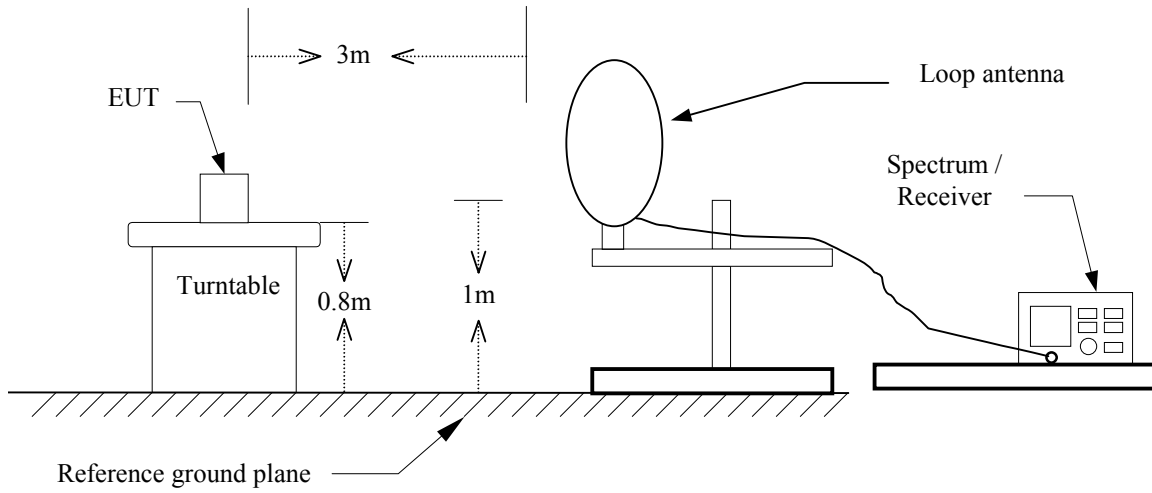

#### 30MHz ~ 1GHz

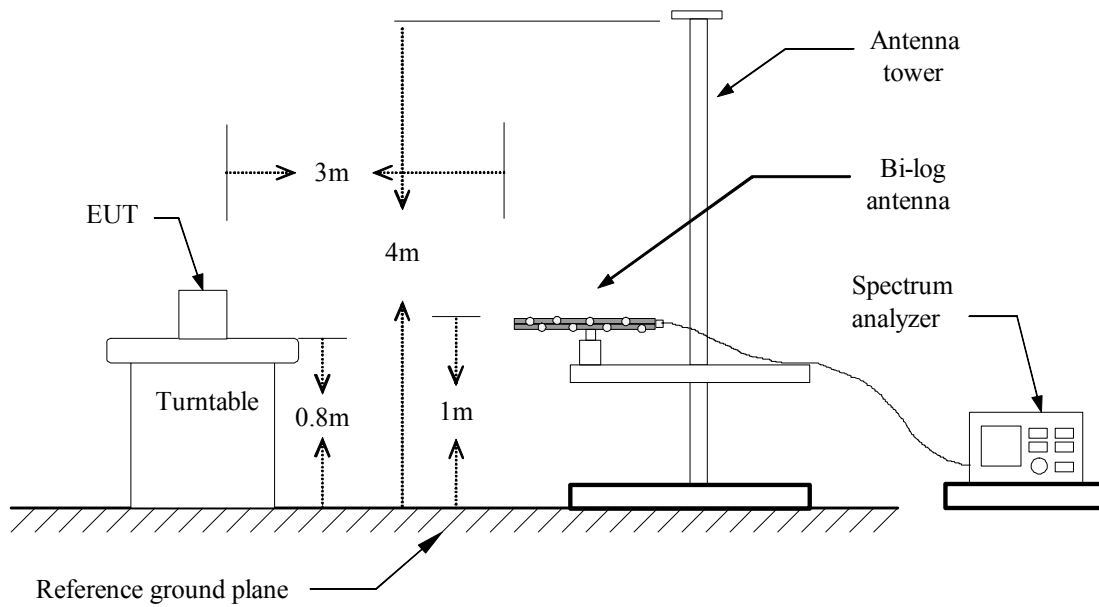

Above 1 GHz

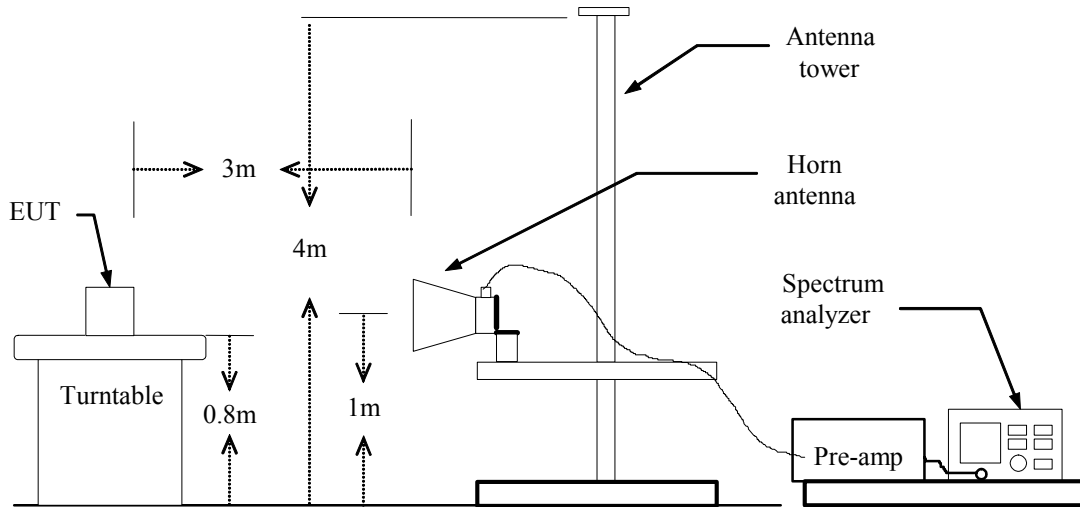





## **TEST PROCEDURE**

1. The EUT is placed on a turntable, which is 0.8m above ground plane.
2. The turntable shall be rotated for 360 degrees to determine the position of maximum emission level.
3. EUT is set 3m away from the receiving antenna, which is varied from 1m to 4m to find out the highest emissions.
4. Maximum procedure was performed on the six highest emissions to ensure EUT compliance.
5. And also, each emission was to be maximized by changing the polarization of receiving antenna both horizontal and vertical.
6. Set the spectrum analyzer in the following setting as:  
Below 1GHz:  
RBW=100kHz / VBW=300kHz / Sweep=AUTO  
Above 1GHz:  
(a) PEAK: RBW=VBW=1MHz / Sweep=AUTO  
(b) AVERAGE: RBW=1MHz / VBW=10Hz / Sweep=AUTO
7. Repeat above procedures until the measurements for all frequencies are complete.

**Below 1 GHz****Operation Mode:** Normal Link**Test Date:** May 17, 2010**Temperature:** 23C**Tested by:** Mimic Yang**Humidity:** 53 % RH**Polarity:** Ver. / Hor.

Frequency (MHz)	Ant.Pol. (H/V)	Reading (dBuV)	Correction Factor (dB/m)	Result (dBuV/m)	Limit (dBuV/m)	Margin (dB)	Remark
133.47	V	38.43	-9.79	28.64	43.50	-14.86	Peak
249.87	V	44.58	-10.90	33.67	46.00	-12.33	Peak
266.03	V	49.05	-9.83	39.23	46.00	-6.77	Peak
316.15	V	43.26	-8.86	34.40	46.00	-11.60	Peak
332.32	V	44.19	-8.47	35.72	46.00	-10.28	Peak
631.40	V	38.28	-3.33	34.95	46.00	-11.05	Peak
332.32	H	42.36	-8.47	33.89	46.00	-12.11	Peak
366.27	H	44.21	-7.74	36.48	46.00	-9.52	Peak
382.43	H	43.95	-7.43	36.52	46.00	-9.48	Peak
398.60	H	39.70	-7.12	32.58	46.00	-13.42	Peak
565.12	H	38.51	-4.35	34.17	46.00	-11.83	Peak
797.92	H	36.97	-1.36	35.61	46.00	-10.39	Peak

**Remark:**

1. No emission found between lowest internal used/generated frequency to 30MHz (9kHz~30MHz)
2. Radiated emissions measured in frequency range from 30 MHz to 1000MHz were made with an instrument using peak/quasi-peak detector mode.
3. Quasi-peak test would be performed if the peak result were greater than the quasi-peak limit or as required by the applicant.
4. Measurements above show only up to 6 maximum emissions noted, or would be lesser, with " N/A " remark, if no specific emissions from the EUT are recorded (ie: margin>20dB from the applicable limit) and considered that's already beyond the background noise floor.
5. Margin (dB) = Remark result (dBuV/m) – Quasi-peak limit (dBuV/m).



**Above 1 GHz**

**Operation Mode:** IEEE 802.11b / TX / CH Low

**Test Date:** May 19, 2010

**Temperature:** 25°C

**Tested by:** Ryan Chen

**Humidity:** 50 % RH

**Polarity:** Ver. / Hor.

Frequency (MHz)	Ant.Pol. (H/V)	Reading (Peak) (dBuV)	Reading (Average) (dBuV)	Correction Factor (dB/m)	Result (Peak) (dBuV/m)	Result (Average) (dBuV/m)	Limit (Peak) (dBuV/m)	Limit (Average) (dBuV/m)	Margin (Peak) (dB)	Margin (Average) (dB)
1330.00	V	59.68	---	-9.04	50.63	---	74.00	54.00	-23.37	---
N/A										
1026.67	H	62.59	48.13	-9.55	53.04	38.58	74.00	54.00	-20.96	-15.42
1676.67	H	56.71	---	-7.13	49.58	---	74.00	54.00	-24.42	---
N/A										

**Remark:**

1. Measuring frequencies from 1 GHz to the 10th harmonic of highest fundamental frequency.
2. Radiated emissions measured in frequency above 1000MHz were made with an instrument using peak/average detector mode.
3. Average test would be performed if the peak result were greater than the average limit or as required by the applicant.
4. Data of measurement within this frequency range shown " --- " in the table above means the reading of emissions are attenuated more than 20dB below the permissible limits or the field strength is too small to be measured.
5. Measurements above show only up to 6 maximum emissions noted, or would be lesser, with " N/A " remark, if no specific emissions from the EUT are recorded (ie: margin>20dB from the applicable limit) and considered that's already beyond the background noise floor.
6. Peak Margin (dB) = Peak result (dBuV/m) –Peak limit (dBuV/m).  
Average Margin (dB) = Average result (dBuV/m) –Average limit (dBuV/m).



Operation Mode: IEEE 802.11b / TX / CH Mid

Test Date: May 19, 2010

Temperature: 25°C

Tested by: Ryan Chen

Humidity: 50 % RH

Polarity: Ver. / Hor.

Frequency (MHz)	Ant.Pol. (H/V)	Reading (Peak) (dBuV)	Reading (Average) (dBuV)	Correction Factor (dB/m)	Result (Peak) (dBuV/m)	Result (Average) (dBuV/m)	Limit (Peak) (dBuV/m)	Limit (Average) (dBuV/m)	Margin (Peak) (dB)	Margin (Average) (dB)
1330.00	V	60.01	---	-9.04	50.96	---	74.00	54.00	-23.04	---
N/A										
1753.33	H	57.42	---	-6.42	51.00	---	74.00	54.00	-23.00	---
N/A										

Remark:

1. Measuring frequencies from 1 GHz to the 10th harmonic of highest fundamental frequency.
2. Radiated emissions measured in frequency above 1000MHz were made with an instrument using peak/average detector mode.
3. Average test would be performed if the peak result were greater than the average limit or as required by the applicant.
4. Data of measurement within this frequency range shown " --- " in the table above means the reading of emissions are attenuated more than 20dB below the permissible limits or the field strength is too small to be measured.
5. Measurements above show only up to 6 maximum emissions noted, or would be lesser; with " N/A " remark, if no specific emissions from the EUT are recorded (ie: margin>20dB from the applicable limit) and considered that's already beyond the background noise floor.
6. Peak Margin (dB) = Peak result (dBuV/m) –Peak limit (dBuV/m).  
Average Margin (dB) = Average result (dBuV/m) –Average limit (dBuV/m).



Operation Mode: IEEE 802.11b / TX / CH High

Test Date: May 19, 2010

Temperature: 25°C

Tested by: Ryan Chen

Humidity: 50 % RH

Polarity: Ver. / Hor.

Frequency (MHz)	Ant.Pol. (H/V)	Reading (Peak) (dBuV)	Reading (Average) (dBuV)	Correction Factor (dB/m)	Result (Peak) (dBuV/m)	Result (Average) (dBuV/m)	Limit (Peak) (dBuV/m)	Limit (Average) (dBuV/m)	Margin (Peak) (dB)	Margin (Average) (dB)
1396.67	V	57.05	---	-8.93	48.11	---	74.00	54.00	-25.89	---
N/A										
1430.00	H	58.10	---	-8.88	49.23	---	74.00	54.00	-24.77	---
2326.67	H	61.26	48.24	-3.18	58.09	45.06	74.00	54.00	-15.91	-8.94
N/A										

Remark:

1. Measuring frequencies from 1 GHz to the 10th harmonic of highest fundamental frequency.
2. Radiated emissions measured in frequency above 1000MHz were made with an instrument using peak/average detector mode.
3. Average test would be performed if the peak result were greater than the average limit or as required by the applicant.
4. Data of measurement within this frequency range shown " --- " in the table above means the reading of emissions are attenuated more than 20dB below the permissible limits or the field strength is too small to be measured.
5. Measurements above show only up to 6 maximum emissions noted, or would be lesser; with " N/A " remark, if no specific emissions from the EUT are recorded (ie: margin > 20dB from the applicable limit) and considered that's already beyond the background noise floor.
6. Peak Margin (dB) = Peak result (dBuV/m) – Peak limit (dBuV/m).  
Average Margin (dB) = Average result (dBuV/m) – Average limit (dBuV/m).



Operation Mode: IEEE 802.11g / TX / CH Low

Test Date: May 19, 2010

Temperature: 25°C

Tested by: Ryan Chen

Humidity: 50 % RH

Polarity: Ver. / Hor.

Frequency (MHz)	Ant.Pol. (H/V)	Reading (Peak) (dBuV)	Reading (Average) (dBuV)	Correction Factor (dB/m)	Result (Peak) (dBuV/m)	Result (Average) (dBuV/m)	Limit (Peak) (dBuV/m)	Limit (Average) (dBuV/m)	Margin (Peak) (dB)	Margin (Average) (dB)
1330.00	V	59.31	---	-9.04	50.26	---	74.00	54.00	-23.74	---
N/A										
1330.00	H	59.52	---	-9.04	50.48	---	74.00	54.00	-23.52	---
N/A										

Remark:

1. Measuring frequencies from 1 GHz to the 10th harmonic of highest fundamental frequency.
2. Radiated emissions measured in frequency above 1000MHz were made with an instrument using peak/average detector mode.
3. Average test would be performed if the peak result were greater than the average limit or as required by the applicant.
4. Data of measurement within this frequency range shown “ --- ” in the table above means the reading of emissions are attenuated more than 20dB below the permissible limits or the field strength is too small to be measured.
5. Measurements above show only up to 6 maximum emissions noted, or would be lesser; with “ N/A ” remark, if no specific emissions from the EUT are recorded (ie: margin>20dB from the applicable limit) and considered that's already beyond the background noise floor.
6. Peak Margin (dB) = Peak result (dBuV/m) –Peak limit (dBuV/m).  
Average Margin (dB) = Average result (dBuV/m) –Average limit (dBuV/m).



Operation Mode: IEEE 802.11g / TX / CH Mid

Test Date: May 19, 2010

Temperature: 25°C

Tested by: Ryan Chen

Humidity: 50 % RH

Polarity: Ver. / Hor.

Frequency (MHz)	Ant.Pol. (H/V)	Reading (Peak) (dBuV)	Reading (Average) (dBuV)	Correction Factor (dB/m)	Result (Peak) (dBuV/m)	Result (Average) (dBuV/m)	Limit (Peak) (dBuV/m)	Limit (Average) (dBuV/m)	Margin (Peak) (dB)	Margin (Average) (dB)
1080.00	V	60.87	---	-9.46	51.41	---	74.00	54.00	-22.59	---
1326.67	V	60.38	---	-9.05	51.33	---	74.00	54.00	-22.67	---
N/A										
1333.33	H	58.85	---	-9.04	49.81	---	74.00	54.00	-24.19	---
N/A										

Remark:

1. Measuring frequencies from 1 GHz to the 10th harmonic of highest fundamental frequency.
2. Radiated emissions measured in frequency above 1000MHz were made with an instrument using peak/average detector mode.
3. Average test would be performed if the peak result were greater than the average limit or as required by the applicant.
4. Data of measurement within this frequency range shown " --- " in the table above means the reading of emissions are attenuated more than 20dB below the permissible limits or the field strength is too small to be measured.
5. Measurements above show only up to 6 maximum emissions noted, or would be lesser; with " N/A " remark, if no specific emissions from the EUT are recorded (ie: margin>20dB from the applicable limit) and considered that's already beyond the background noise floor.
6. Peak Margin (dB) = Peak result (dBuV/m) –Peak limit (dBuV/m).  
Average Margin (dB) = Average result (dBuV/m) –Average limit (dBuV/m).



Operation Mode: IEEE 802.11g / TX / CH High

Test Date: May 19, 2010

Temperature: 25°C

Tested by: Ryan Chen

Humidity: 50 % RH

Polarity: Ver. / Hor.

Frequency (MHz)	Ant.Pol. (H/V)	Reading (Peak) (dBuV)	Reading (Average) (dBuV)	Correction Factor (dB/m)	Result (Peak) (dBuV/m)	Result (Average) (dBuV/m)	Limit (Peak) (dBuV/m)	Limit (Average) (dBuV/m)	Margin (Peak) (dB)	Margin (Average) (dB)
1326.67	V	61.52	---	-9.05	52.47	---	74.00	54.00	-21.53	---
N/A										
1333.33	H	58.37	---	-9.04	49.33	---	74.00	54.00	-24.67	---
N/A										

Remark:

1. Measuring frequencies from 1 GHz to the 10th harmonic of highest fundamental frequency.
2. Radiated emissions measured in frequency above 1000MHz were made with an instrument using peak/average detector mode.
3. Average test would be performed if the peak result were greater than the average limit or as required by the applicant.
4. Data of measurement within this frequency range shown “ --- ” in the table above means the reading of emissions are attenuated more than 20dB below the permissible limits or the field strength is too small to be measured.
5. Measurements above show only up to 6 maximum emissions noted, or would be lesser; with “ N/A ” remark, if no specific emissions from the EUT are recorded (ie: margin>20dB from the applicable limit) and considered that's already beyond the background noise floor.
6. Peak Margin (dB) = Peak result (dBuV/m) –Peak limit (dBuV/m).  
Average Margin (dB) = Average result (dBuV/m) –Average limit (dBuV/m).





## 7.7 POWERLINE CONDUCTED EMISSIONS

### LIMIT

According to §15.207(a), except as shown in paragraphs (b) and (c) of this section, for an intentional radiator that is designed to be connected to the public utility (AC) power line, the radio frequency voltage that is conducted back onto the AC power line on any frequency or frequencies within the band 150 kHz to 30 MHz shall not exceed the limits in the following table, as measured using a 50 μH/50 ohms line impedance stabilization network (LISN). Compliance with the provisions of this paragraph shall be based on the measurement of the radio frequency voltage between each power line and ground at the power terminal. The lower limit applies at the boundary between the frequency ranges.

Frequency Range (MHz)	Limits (dBμV)	
	Quasi-peak	Average
0.15 to 0.50	66 to 56*	56 to 46*
0.50 to 5	56	46
5 to 30	60	50

### Test Configuration

See test photographs attached in Appendix II for the actual connections between EUT and support equipment.

### TEST PROCEDURE

1. The EUT was placed on a table, which is 0.8m above ground plane.
2. Maximum procedure was performed on the six highest emissions to ensure EUT compliance.
3. Repeat above procedures until all frequency measured were complete.



## TEST RESULTS

The initial step in collecting conducted data is a spectrum analyzer peak scan of the measurement range. Significant peaks are then marked as shown on the following data page, and these signals are then quasi-peaked.

### Test Data

**Operation Mode:** MP3 Mode                      **Test Date:** May 14, 2010  
**Temperature:** 26C                                **Tested by:** Eddy Chung  
**Humidity:** 60 RH

Frequency (MHz)	QP Reading (dBuV)	AV Reading (dBuV)	Corr. factor (dB)	QP Result (dBuV)	AV Result (dBuV)	QP Limit (dBuV)	AV Limit (dBuV)	QP Margin (dB)	AV Margin (dB)	Note
0.2400	36.67	23.37	0.03	36.70	23.40	62.10	52.10	-25.40	-28.70	L1
0.3840	37.26	24.26	0.04	37.30	24.30	58.19	48.19	-20.89	-23.89	L1
2.1660	35.14	20.94	0.06	35.20	21.00	56.00	46.00	-20.80	-25.00	L1
5.2620	37.99	25.69	0.11	38.10	25.80	60.00	50.00	-21.90	-24.20	L1
5.8200	38.28	26.98	0.12	38.40	27.10	60.00	50.00	-21.60	-22.90	L1
8.7270	35.93	25.83	0.17	36.10	26.00	60.00	50.00	-23.90	-24.00	L1
0.3930	38.67	26.67	0.03	38.70	26.70	58.00	48.00	-19.30	-21.30	L2
0.7170	37.56	25.56	0.04	37.60	25.60	56.00	46.00	-18.40	-20.40	L2
2.9490	38.34	24.84	0.06	38.40	24.90	56.00	46.00	-17.60	-21.10	L2
3.7140	37.73	26.33	0.07	37.80	26.40	56.00	46.00	-18.20	-19.60	L2
4.7400	38.92	27.62	0.08	39.00	27.70	56.00	46.00	-17.00	-18.30	L2
9.5910	35.34	26.54	0.16	35.50	26.70	60.00	50.00	-24.50	-23.30	L2

### **Remark:**

1. Measuring frequencies from 0.15 MHz to 30MHz.
2. The emissions measured in frequency range from 0.15 MHz to 30MHz were made with an instrument using Quasi-peak detector and average detector.
3. The IF bandwidth of SPA between 0.15MHz to 30MHz was 10kHz; the IF bandwidth of Test Receiver between 0.15MHz to 30MHz was 9kHz;
4. L1 = Line One (Live Line) / L2 = Line Two (Neutral Line)
5. "-" means Quasi-peak reading value also meets average limit and measurement with the average detector is unnecessary.



**Test Plots**

**Conducted emissions (Line 1)**

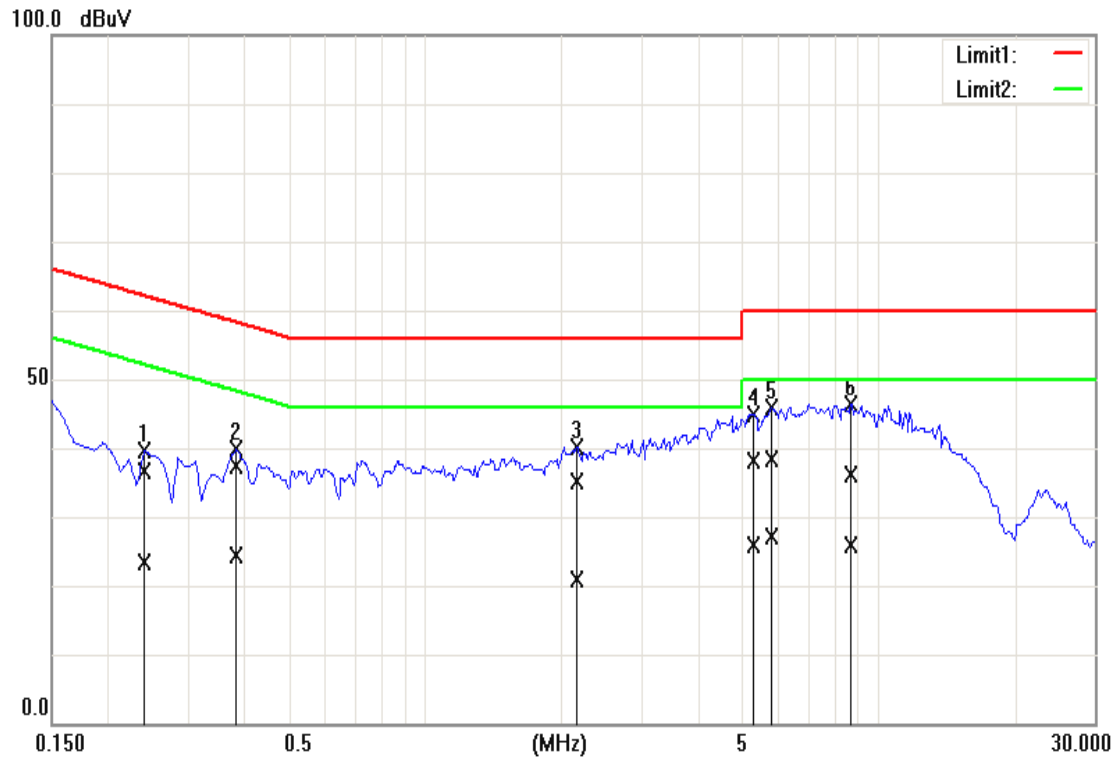

**Conducted emissions (Line 2)**

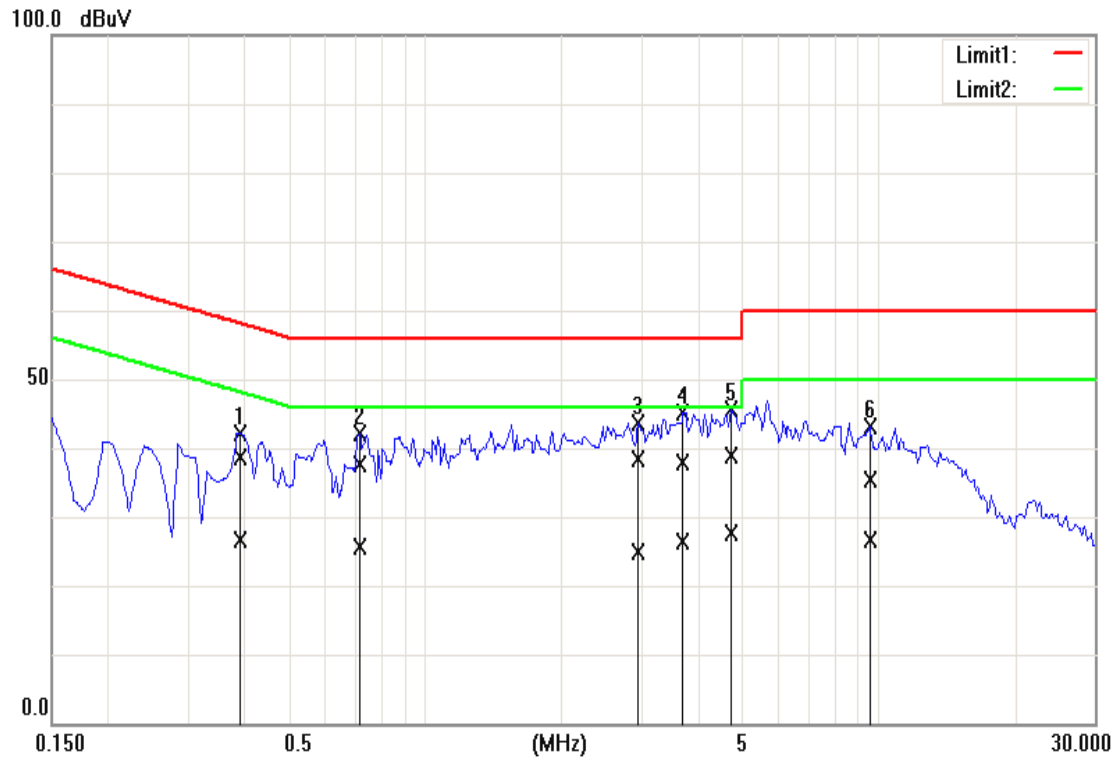



**Operation Mode:** USB Mode                      **Test Date:** May 14, 2010  
**Temperature:** 26C                                **Tested by:** Eddy Chung  
**Humidity:** 60 RH

Frequency (MHz)	QP Reading (dBuV)	AV Reading (dBuV)	Corr. factor (dB)	QP Result (dBuV)	AV Result (dBuV)	QP Limit (dBuV)	AV Limit (dBuV)	QP Margin (dB)	AV Margin (dB)	Note
0.4560	41.66	27.16	0.04	41.70	27.20	56.77	46.77	-15.07	-19.57	L1
1.0680	43.25	26.25	0.05	43.30	26.30	56.00	46.00	-12.70	-19.70	L1
1.3920	42.85	26.85	0.05	42.90	26.90	56.00	46.00	-13.10	-19.10	L1
2.1480	43.74	28.14	0.06	43.80	28.20	56.00	46.00	-12.20	-17.80	L1
2.5890	44.03	28.93	0.07	44.10	29.00	56.00	46.00	-11.90	-17.00	L1
6.0090	48.08	34.28	0.12	48.20	34.40	60.00	50.00	-11.80	-15.60	L1
0.1680	39.97	21.87	0.03	40.00	21.90	65.05	55.06	-25.05	-33.16	L2
0.2490	36.48	25.58	0.02	36.50	25.60	61.79	51.79	-25.29	-26.19	L2
1.1130	39.46	26.76	0.04	39.50	26.80	56.00	46.00	-16.50	-19.20	L2
2.3640	39.05	28.55	0.05	39.10	28.60	56.00	46.00	-16.90	-17.40	L2
4.5870	40.62	30.32	0.08	40.70	30.40	56.00	46.00	-15.30	-15.60	L2
7.8090	39.77	29.97	0.13	39.90	30.10	60.00	50.00	-20.10	-19.90	L2

**Remark:**

6. Measuring frequencies from 0.15 MHz to 30MHz.
7. The emissions measured in frequency range from 0.15 MHz to 30MHz were made with an instrument using Quasi-peak detector and average detector.
8. The IF bandwidth of SPA between 0.15MHz to 30MHz was 10kHz; the IF bandwidth of Test Receiver between 0.15MHz to 30MHz was 9kHz;
9. L1 = Line One (Live Line) / L2 = Line Two (Neutral Line)
10. "-" means Quasi-peak reading value also meets average limit and measurement with the average detector is unnecessary.



**Test Plots**

**Conducted emissions (Line 1)**

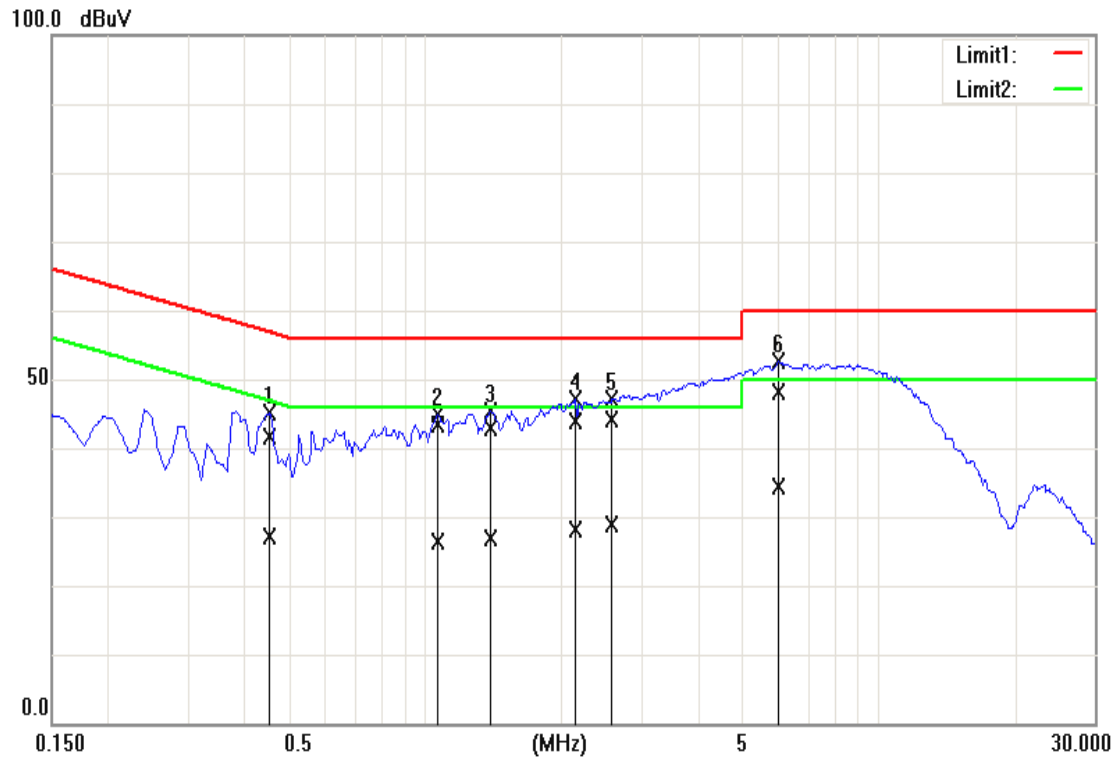

**Conducted emissions (Line 2)**

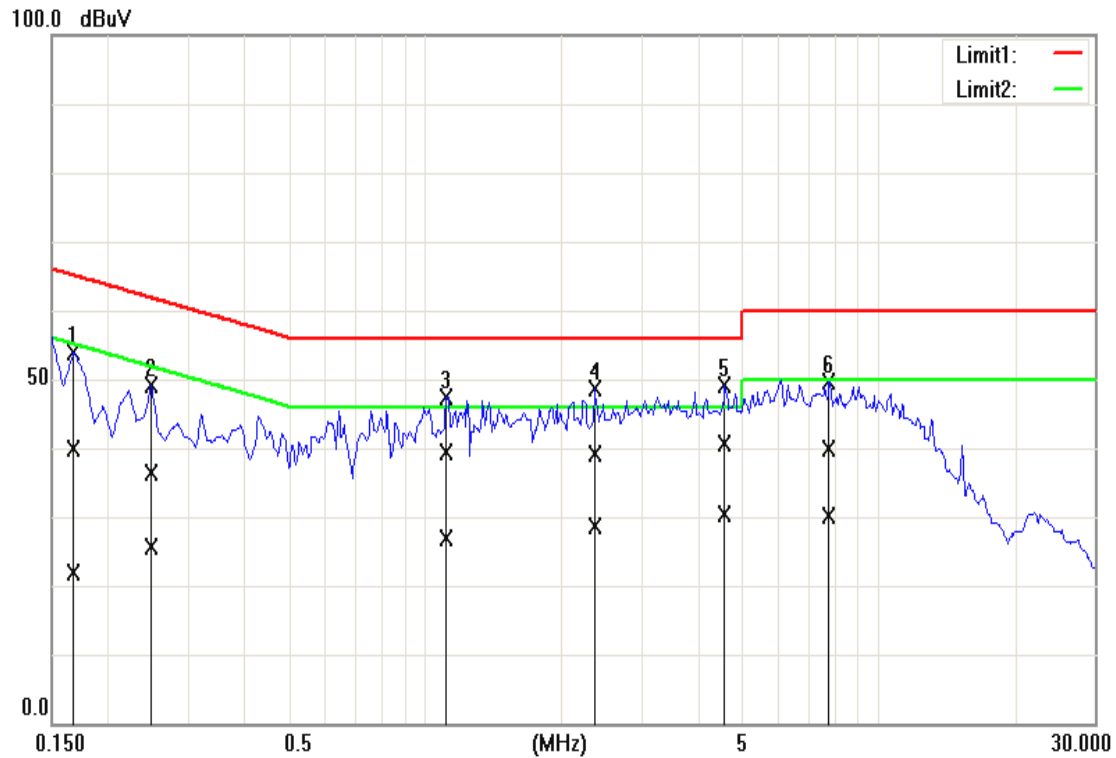



# APPENDIX I RADIO FREQUENCY EXPOSURE

## LIMIT

Systems operating under the provisions of this section shall be operated in a manner that ensures that the public is not exposed to radio frequency energy levels in excess of the Commission's guidelines. See §15.247(i) and §1.1307(b)(1) of this chapter.

## EUT Specification

<b>EUT</b>	Pandigital novel mule-Rader
<b>Frequency band (Operating)</b>	<input checked="" type="checkbox"/> WLAN: 2.412GHz ~ 2.462GHz <input type="checkbox"/> WLAN: 5.18GHz ~ 5.32GHz / 5.50GHz ~ 5.70GHz <input type="checkbox"/> WLAN: 5.745GHz ~ 5.825GHz <input type="checkbox"/> Bluetooth: <u>2.402GHz ~ 2.480 GHz</u>
<b>Device category</b>	<input checked="" type="checkbox"/> Portable (<20cm separation) <input type="checkbox"/> Mobile (>20cm separation)
<b>Exposure classification</b>	<input type="checkbox"/> Occupational/Controlled exposure (S = 5mW/cm2) <input checked="" type="checkbox"/> General Population/Uncontrolled exposure (S=1mW/cm2)
<b>Antenna diversity</b>	<input checked="" type="checkbox"/> Single antenna <input type="checkbox"/> Multiple antennas <input type="checkbox"/> Tx diversity <input type="checkbox"/> Rx diversity <input type="checkbox"/> Tx/Rx diversity
<b>Max. output power</b>	IEEE 802.11b: 16.14 dBm (41.11mW) IEEE 802.11g: 20.23 dBm (105.43mW)
<b>Antenna gain (Max)</b>	2 dBi (Numeric gain: 1.58)
<b>Evaluation applied</b>	<input type="checkbox"/> MPE Evaluation <input checked="" type="checkbox"/> SAR Evaluation* <input type="checkbox"/> N/A

### Remark:

1. The maximum output power is 20.23dBm (105.43mW) at 2412MHz (with 1.58 numeric antenna gain.)
2. DTS device is not subject to routine RF evaluation; MPE estimate is used to justify the compliance.
3. For mobile or fixed location transmitters, no SAR consideration applied. The maximum power density is  $1.0 \text{ mW/cm}^2$  even if the calculation indicates that the power density would be larger.

## TEST RESULTS

No non-compliance noted.

**Remark:** Please refer to the separated SAR report.