

FCC SAR Measurement and Test Report

For

Inventec Appliances Corp.

37 Wugong 5th road, New Taipei Industrial Park, Wugu District

FCC ID: POT-NC125A

Test Standards:	FCC Part 2.1093 ANSI / IEEE C95.1 :2005+A1:2010 <u>ANSI / IEEE C95.3 :2002(R2008)</u>
Product Description:	<u>Notebook</u>
Tested Model:	<u>NEBP12</u>
Report No.:	<u>STR17108171H</u>
Max. SAR Values:	<u>Body: 0.112 W/kg(1g)</u>
Sample Receipt Date:	<u>2017-11-01</u>
Tested Date:	<u>2017-11-01 to 2017-11-04</u>
Issued Date:	<u>2017-11-06</u>
Tested By:	<u>Lucy Wei / Engineer</u> <i>Lucy Wei</i>
Reviewed By:	<u>Silin Chen / EMC Manager</u> <i>Silin Chen</i>
Approved & Authorized By:	<u>Jandy So / PSQ Manager</u> <i>Jandy So</i>
Prepared By:	

Shenzhen SEM Test Technology Co., Ltd.
1/F, Building A, Hongwei Industrial Park, Liuxian 2nd Road,
Bao'an District, Shenzhen, P.R.C. (518101)
Tel.: +86-755-33663308 Fax.: +86-755-33663309 Website: www.semtest.com.cn

Note: This test report is limited to the above client company and the product model only. It may not be duplicated without prior permitted by Shenzhen SEM. Test Technology Co., Ltd.

TABLE OF CONTENTS

1. General Information	3
1.1 Product Description for Equipment Under Test (EUT).....	3
1.2 Test Standards	5
1.3 Test Methodology.....	5
1.4 Test Facility	5
2. Summary of Test Results	6
3. Specific Absorption Rate (SAR)	7
3.1 Introduction.....	7
3.2 SAR Definition	7
4. SAR Measurement System	8
4.1 The Measurement System	8
4.2 Probe.....	8
4.3 Probe Calibration Process	10
4.4 Phantom	11
4.5 Device Holder	11
4.6 Test Equipment List.....	12
5. Tissue Simulating Liquids	13
5.1 Composition of Tissue Simulating Liquid.....	13
5.2 Tissue Dielectric Parameters for Head and Body Phantoms	14
5.3 Tissue Calibration Result.....	15
6. SAR Measurement Evaluation	16
6.1 Purpose of System Performance Check.....	16
6.2 System Setup	16
6.3 Validation Results.....	17
7. EUT Testing Position	18
7.1 EUT Antenna Position	18
7.2 EUT Testing Position.....	19
8. SAR Measurement Procedures	20
8.1 Measurement Procedures	20
8.2 Spatial Peak SAR Evaluation	20
8.3 Area & Zoom Scan Procedures.....	21
8.4 Volume Scan Procedures.....	21
8.5 SAR Averaged Methods	21
8.6 Power Drift Monitoring.....	21
9. SAR Test Result	22
9.1 Conducted RF Output Power	22
9.2 Test Results for Standalone SAR Test.....	24
10. Measurement Uncertainty	25
10.1 Uncertainty for EUT SAR Test.....	25
10.2 Uncertainty for System Performance Check.....	26
Annex A. Plots of System Performance Check	28
Annex B. Plots of SAR Measurement	30
Annex C. EUT Photos	35
Annex D. Test Setup Photos	37
Annex E. Calibration Certificate	38

1. General Information

1.1 Product Description for Equipment Under Test (EUT)

Client Information

Applicant: Inventec Appliances Corp.
Address of applicant: 37 Wugong 5th road, New Taipei Industrial Park,
Wugu District

Manufacturer: Inventec Appliances(Pudong) Corporation
Address of manufacturer: No.789 Pu Xing Road, Shanghai, PRC

General Description of EUT	
Product Name:	Notebook
Brand Name:	NuVision
Model No.	NEBP12
Adding Model(s):	NEBP12-C464SSA; NEBP12-C464SBA; NEBP12-C464SGA; NEBP12-C464SBLA ; NEBP12-C464SGNA;NEBP12-C464SPA;
Rated Voltage:	Battery DC 7.6V
Battery Capacity:	4200mAh
Power Adapter:	Model: B036-120 Input: AC100-240,50/60Hz, 0.6A; Output: DC12.0V~3A
<i>Note: The test data is gathered from a production sample provided by the manufacturer. The appearance of others models listed in the report is different from main-test model NEBP12, but the circuit and the electronic construction do not change, declared by the manufacturer.</i>	

Technical Characteristics of EUT:	
WIFI (2.4G)	
Support Standards:	802.11b, 802.11g, 802.11n
Frequency Range:	2412-2462MHz for 11b/g/n(HT20) 2422-2452MHz for 11n(HT40)
RF Output Power:	Antenna A : 12.41dBm(Conducted) Antenna B : 12.78dBm (Conducted)
Type of Modulation:	CCK, OFDM, QPSK, BPSK, 16QAM, 64QAM
Data Rate:	1-11Mbps, 6-54Mbps, up to 150Mbps
Quantity of Channels:	11/7
Channel Separation:	5MHz
Antenna Type:	Internal Antenna
Antenna Gain:	2.0dBi
Bluetooth	
Bluetooth Version:	V4.2
Frequency Range:	2402-2480MHz
RF Output Power:	2.572dBm (Conducted)
Data Rate:	1Mbps, 2Mbps, 3Mbps
Modulation:	GFSK, Pi/4 QDPSK, 8DPSK
Quantity of Channels:	79/40
Channel Separation:	1MHz/2MHz
Antenna Type:	Internal Antenna
Antenna Gain:	2.0dBi

1.2 Test Standards

The following report is prepared on behalf of the Inventec Appliances Corp. in accordance with FCC 47 CFR Part 2.1093, ANSI/IEEE C95.1-2005, ANSI / IEEE C95.3 :2002, IEEE 1528-2013, and KDB 865664 D01 v01r04 and KDB 865664 D02 v01r02 and 616217 D04 SAR for laptop and tablets v01r02 and 248227 D01 802 11 Wi-Fi SAR v02r02.

The objective is to determine compliance with FCC Part 2.1093 of the Federal Communication Commissions rules.

Maintenance of compliance is the responsibility of the manufacturer. Any modification of the product, which result in lowering the emission, should be checked to ensure compliance has been maintained.

1.3 Test Methodology

All measurements contained in this report were conducted with KDB 865664 D01 v01r04 and KDB 865664 D02 v01r02. The public notice KDB 447498 D01 v06 for Mobile and Portable Devices RF Exposure Procedure also.

1.4 Test Facility

FCC – Registration No.: 125990

Shenzhen SEM Test Technology Co., Ltd. Laboratory has been recognized to perform compliance testing on equipment subject to the Commissions Declaration Of Conformity (DOC). The Designation Number is CN5010, and Test Firm Registration Number is 125990.

Industry Canada (IC) Registration No.: 11464A

The 3m Semi-anechoic chamber of Shenzhen SEM.Test Technology Co., Ltd. has been registered by Certification and Engineering Bureau of Industry Canada for radio equipment testing with Registration No.: 11464A.

2. Summary of Test Results

The maximum results of Specific Absorption Rate (SAR) have found during testing are as follows:

Frequency Band	Body (0mm Gap)	SAR _{1g} Limit (W/kg)
	Maximum SAR _{1g} (W/kg)	
Antenna A_WLAN 2.4G	0.112	1.6
Antenna B_WLAN 2.4G	0.088	1.6

The device is in compliance with Specific Absorption Rate (SAR) for general population/uncontrolled exposure limits (1.6 W/kg) specified in FCC 47 CFR Part 2.1093 and ANSI/IEEE C95.1-2005, and had been tested in accordance with the measurement methods and procedure specified in KDB 865664 D01 v01r04 and KDB 865664 D02 v01r02

3. Specific Absorption Rate (SAR)

3.1 Introduction

SAR is related to the rate at which energy is absorbed per unit mass in an object exposed to a radio field. The SAR distribution in a biological body is complicated and is usually carried out by experimental techniques or numerical modeling. The standard recommends limits for two tiers of groups, occupational/controlled and general population/uncontrolled, based on a person's awareness and ability to exercise control over his or her exposure. In general, occupational/controlled exposure limits are higher than the limits for general population/uncontrolled.

3.2 SAR Definition

The SAR definition is the time derivative (rate) of the incremental energy (dW) absorbed by (dissipated in) an incremental mass (dm) contained in a volume element (dv) of a given density (ρ). The equation description is as below:

$$\text{SAR} = \frac{d}{dt} \left(\frac{dW}{dm} \right) = \frac{d}{dt} \left(\frac{dW}{\rho dv} \right)$$

SAR is expressed in units of Watts per kilogram (W/kg)

SAR measurement can be either related to the temperature elevation in tissue by

$$\text{SAR} = C \left(\frac{\delta T}{\delta t} \right)$$

Where: C is the specific heat capacity, δT is the temperature rise and δt is the exposure duration, or related to the electrical field in the tissue by

$$\text{SAR} = \frac{\sigma |E|^2}{\rho}$$

Where: σ is the conductivity of the tissue, ρ is the mass density of the tissue and E is the RMS electrical field strength.

However for evaluating SAR of low power transmitter, electrical field measurement is typically applied.

4. SAR Measurement System

4.1 The Measurement System

Comosar is a system that is able to determine the SAR distribution inside a phantom of human being according to different standards. The Comosar system consists of the following items:

- Main computer to control all the system
- 6 axis robot
- Data acquisition system
- Miniature E-field probe
- Phone holder
- Head simulating tissue

The following figure shows the system.



The EUT under test operating at the maximum power level is placed in the phone holder, under the phantom, which is filled with head simulating liquid. The E-Field probe measures the electric field inside the phantom. The OpenSAR software computes the results to give a SAR value in a 1g or 10g mass.

4.2 Probe

For the measurements the Specific Dosimetric E-Field Probe SSE5 SN 09/13 EP168 with following specifications is used

- Dynamic range: 0.01-100 W/kg
- Probe Length: 330 mm
- Length of Individual Dipoles: 4.5 mm
- Maximum external diameter: 8 mm
- Probe Tip External Diameter : 5 mm
- Distance between dipoles / probe extremity: 2.7mm

- Probe linearity: <0.25 dB
 - Axial Isotropy: <0.25 dB
 - Spherical Isotropy: <0.50 dB
 - Calibration range: 700 to 3000MHz for head & body simulating liquid.
- Angle between probe axis (evaluation axis) and surface normal line: less than 30°

Probe calibration is realized, in compliance with EN 62209-1 and IEEE 1528 STD, with CALISAR, Antenna proprietary calibration system. The calibration is performed with the EN 62209-1 annexe technique using reference guide at the five frequencies.

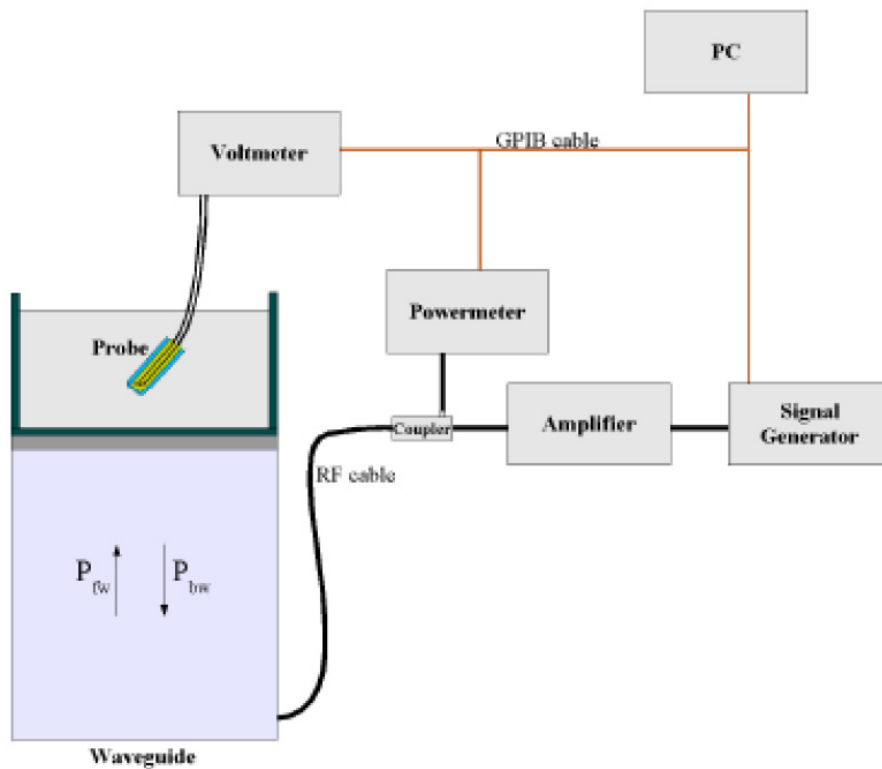

$$SAR = \frac{4(P_{fw} - P_{bw})}{ab\delta} \cos^2\left(\pi \frac{y}{a}\right) c \quad (2z/\delta)$$

Where :

P_{fw} = Forward Power

P_{bw} = Backward Power

a and b = Waveguide dimensions

δ = Skin depth

Keithley configuration:

Rate = Medium; Filter = ON; RDGS = 10; Filter type = Moving Average; Range auto after each calibration, a SAR measurement is performed on a validation dipole and compared with a NPL calibrated probe, to verify it.

The calibration factors, CF(N), for the 3 sensors corresponding to dipole 1, dipole 2 and dipole 3 are:

$$CF(N)=SAR(N)/V_{lin}(N) \quad (N=1,2,3)$$

The linearised output voltage $V_{lin}(N)$ is obtained from the displayed output voltage $V(N)$ using

$$V_{lin}(N)=V(N)*(1+V(N)/DCP(N)) \quad (N=1,2,3)$$

where DCP is the diode compression point in mV.

4.3 Probe Calibration Process

Dosimetric Assessment Procedure

Each E-Probe/Probe Amplifier combination has unique calibration parameters. SATIMO Probe calibration procedure is conducted to determine the proper amplifier settings to enter in the probe parameters. The amplifier settings are determined for a given frequency by subjecting the probe to a known E-field density (1 mW/cm²) using an with CALISAR, Antenna proprietary calibration system.

Free Space Assessment Procedure

The free space E-field from amplified probe outputs is determined in a test chamber. This calibration can be performed in a TEM cell if the frequency is below 1 GHz and in a waveguide or other methodologies above 1 GHz for free space. For the free space calibration, the probe is placed in the volumetric center of the cavity and at the proper orientation with the field. The probe is rotated 360 degrees until the three channels show the maximum reading. The power density readings equates to 1mW/cm².

Temperature Assessment Procedure

E-field temperature correlation calibration is performed in a flat phantom filled with the appropriate simulated head tissue. The E-field in the medium correlates with the temperature rise in the dielectric medium. For temperature correlation calibration a RF transparent thermistor-based temperature probe is used in conjunction with the E-field probe.

Where:

$$SAR = C \frac{\Delta T}{\Delta t}$$

Δt = exposure time (30 seconds),

C = heat capacity of tissue (brain or muscle),

ΔT = temperature increase due to RF exposure.

SAR is proportional to $\Delta T/\Delta t$, the initial rate of tissue heating, before thermal diffusion takes place. The electric field in the simulated tissue can be used to estimate SAR by equating the thermally derived SAR to that with the E- field component.

$$\text{SAR} = \frac{|\mathbf{E}|^2 \cdot \sigma}{\rho}$$

Where:

σ = simulated tissue conductivity,

ρ = Tissue density (1.25 g/cm³ for brain tissue)

4.4 Phantom

For the measurements the Specific Anthropomorphic Mannequin (SAM) defined by the IEEE SCC-34/SC2 group is used. The phantom is a polyurethane shell integrated in a wooden table. The thickness of the phantom amounts to 2mm +/- 0.2mm. It enables the dosimetric evaluation of left and right phone usage and includes an additional flat phantom part for the simplified performance check. The phantom set-up includes a cover, which prevents the evaporation of the liquid.

4.5 Device Holder

The positioning system allows obtaining cheek and tilting position with a very good accuracy. In compliance with CENELEC, the tilt angle uncertainty is lower than 1°.

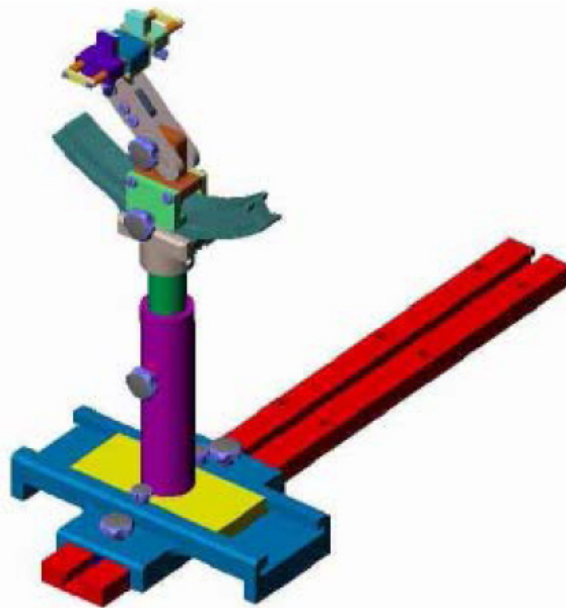

System Material	Permittivity	Loss Tangent
Delrin	3.7	0.005

4.6 Test Equipment List

Description	Manufacturer	Model	Serial Number	Cal. Date	Due. Date
E-Field Probe	SATIMO	SSE5	SN 09/13 EP168	2017-06-01	2018-05-31
2450MHz Dipole	SATIMO	SID2450	SN 13/15 DIP 2G450-364	2017-03-16	2018-03-15
Dielectric Probe Kit	SATIMO	SCLMP	SN 47/12 OCPG49	2017-03-16	2018-03-15
SAM Phantom	SATIMO	SAM	SN/ 47/12 SAM95	N/A	N/A
MULTIMETER	KEITHLEY	Keithley 2000	4006367	2017-06-12	2018-06-11
Signal Generator	Rohde & Schwarz	SMR20	100047	2017-06-12	2018-06-11
Universal Tester	Rohde & Schwarz	CMU200	112012	2017-06-12	2018-06-11
Network Analyzer	HP	8753C	2901A00831	2017-06-12	2018-06-11
Data Acquisition Electronics	SATIMO	DAE4	915	2017-06-12	2018-06-11
Directional Couplers	Agilent	778D	20160	2017-06-12	2018-06-11

5. Tissue Simulating Liquids

5.1 Composition of Tissue Simulating Liquid

For the measurement of the field distribution inside the SAM phantom with SMTIMO, the phantom must be filled with around 25 liters of homogeneous body tissue simulating liquid. For head SAR testing, the liquid height from the ear reference point (ERP) of the phantom to the liquid top surface is larger than 15 cm. For body SAR testing, the liquid height from the center of the flat phantom to the liquid top surface is larger than 15 cm. Please see the following photos for the liquid height.

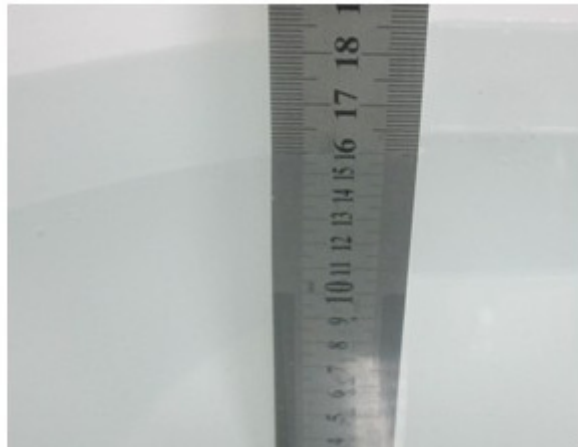

Liquid Height for Body SAR

The Composition of Tissue Simulating Liquid

Frequency (MHz)	Water (%)	Salt (%)	Sugar (%)	HEC (%)	Preventol (%)	DGBE (%)
Body						
2450	55.0	0.1	0	0	0	44.9

5.2 Tissue Dielectric Parameters for Head and Body Phantoms

The IEEE Std. 1528, FCC KDBs and CEI/IEC 62209 standards state that the system validation measurements must be performed using a reference dipole meeting the fore mentioned return loss and mechanical dimension requirements. The validation measurement must be performed against a liquid filled flat phantom, with the phantom constructed as outlined in the fore mentioned standards. Per the standards, the dipole shall be positioned below the bottom of the phantom, with the dipole length centered and parallel to the longest dimension of the flat phantom, with the top surface of the dipole at the described distance from the bottom surface of the phantom.

Target Frequency (MHz)	Head		Body	
	Conductivity (σ)	Permittivity (ϵ_r)	Conductivity (σ)	Permittivity (ϵ_r)
150	0.76	52.3	0.80	61.9
300	0.87	45.3	0.92	58.2
450	0.87	43.5	0.94	56.7
750	0.89	41.9	0.96	55.5
835	0.90	41.5	0.97	55.2
900	0.97	41.5	1.05	55.0
915	0.98	41.5	1.06	55.0
1450	1.20	40.5	1.30	54.0
1610	1.29	40.3	1.40	53.8
1800-2000	1.40	40.0	1.52	53.3
2450	1.80	39.2	1.95	52.7
3000	2.40	38.5	2.73	52.0
5800	5.27	35.3	6.00	48.2

5.3 Tissue Calibration Result

The dielectric parameters of the liquids were verified prior to the SAR evaluation using COMOSAR Dielectric Probe Kit and an Agilent Network Analyzer.

Calibration Result for Dielectric Parameters of Tissue Simulating Liquid

Body Tissue Simulating Liquid									
Freq. MHz.	Temp. (°C)	Conductivity			Permittivity			Limit (%)	Date
		Reading (σ)	Target (σ)	Delta (%)	Reading (ϵ_r)	Target (ϵ_r)	Delta (%)		
2450	21.3	1.91	1.95	-2.05	52.01	52.70	-1.31	±5	2017-11-01

6. SAR Measurement Evaluation

6.1 Purpose of System Performance Check

The system performance check verifies that the system operates within its specifications. System and operator errors can be detected and corrected. It is recommended that the system performance check be performed prior to any usage of the system in order to guarantee reproducible results. The system performance check uses normal SAR measurements in a simplified setup with a well characterized source. This setup was selected to give a high sensitivity to all parameters that might fail or vary over time. The system check does not intend to replace the calibration of the components, but indicates situations where the system uncertainty is exceeded due to drift or failure.

6.2 System Setup

In the simplified setup for system evaluation, the EUT is replaced by a calibrated dipole and the power source is replaced by a continuous wave which comes from a signal generator at frequency 2450MHz. The calibrated dipole must be placed beneath the flat phantom section of the SAM twin phantom with the correct distance holder. The distance holder should touch the phantom surface with a light pressure at the reference marking and be oriented parallel to the long side of the phantom.

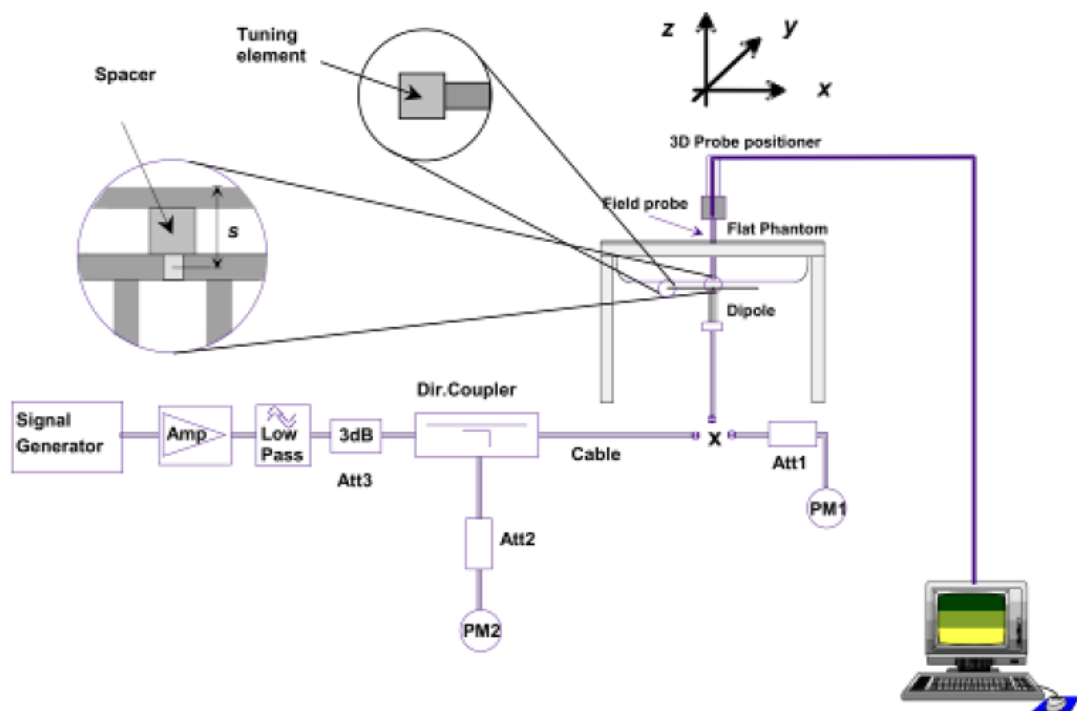

System Verification Setup Block Diagram



Setup Photo of Dipole Antenna

The output power on dipole port must be calibrated to 24 dBm(250 mW) before dipole is connected.

6.3 Validation Results

Comparing to the original SAR value provided by SATIMO, the validation data should be within its specification of 10 %. Table 6.1 shows the target SAR and measured SAR after normalized to 1W input power. The table below indicates the system performance check can meet the variation criterion.

Frequency	Targeted SAR _{1g}	Measured SAR _{1g}	Normalized SAR _{1g}	Tolerance	Date
MHz	(W/kg)	(W/kg)	(W/kg)	(%)	
Body					
2450	50.33	12.60	50.4	0.14	2017-11-01

Targeted and Measurement SAR

Please refer to Annex A for the plots of system performance check.

7. EUT Testing Position

7.1 EUT Antenna Position

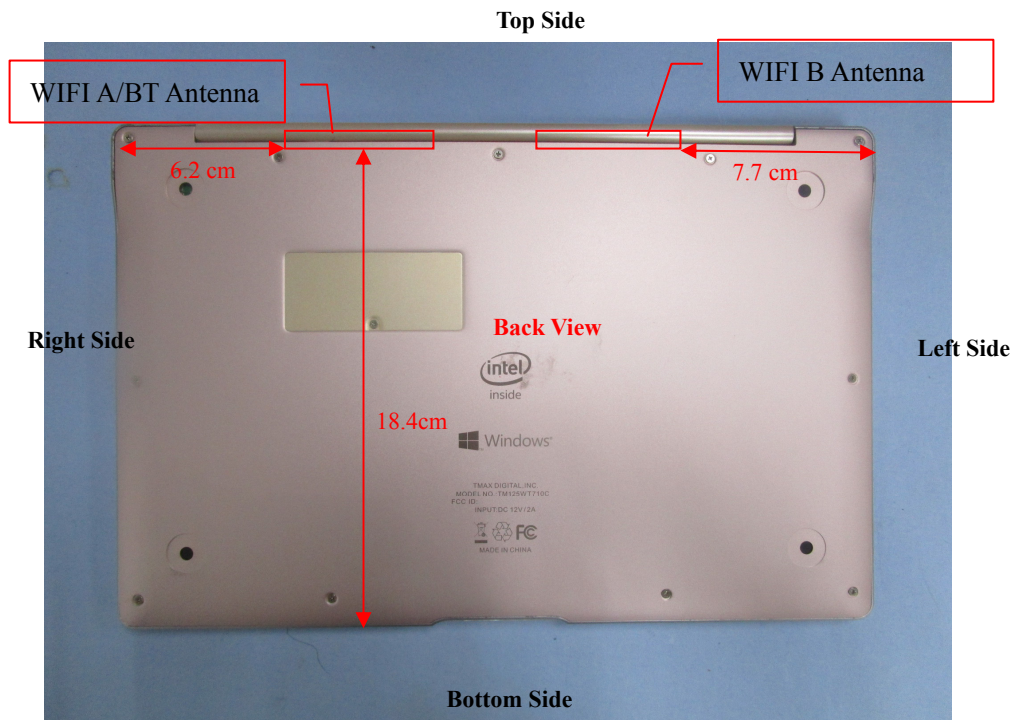

Block Diagram for EUT Antenna Position

7.2 EUT Testing Position

Exclusion Distance Calculation				
Frequency Bands	Service	Maximum Tune-up Power	Average Power	Exclusion Distance
Antenna A- WLAN(2.4G)	802.11b	13.0dBm	13.0dBm	15mm
Antenna B- WLAN(2.4G)	802.11b	13.0dBm	13.0dBm	15mm

Note: Refer to Chapter 9.1 Conducted RF Output Power

Remark:

- Referring to KDB 447498 D01v06 and KDB616217 D04 v01r02, the distance of the antennas to all adjacent edges SAR test exclusion for adjacent edges.

Body mode SAR assessments are required for this device. This EUT was tested in different positions for different SAR test modes, more information as below:

Body SAR tests, Test distance: 0mm						
Antennas	Front	Back	Right Side	Left Side	Top Side	Bottom Side
WLAN A	No	Yes	No	No	Yes	No
WLAN B	No	Yes	No	No	Yes	No

Remark:

- Referring to KDB 616217 D04 v01r02, and KDB 447498 D01 v06, this device is overall diagonal dimension(>20cm) tablet, tested in direct contact (no gap) with flat phantom.

Please refer to Annex D for the EUT test setup photos.

8. SAR Measurement Procedures

8.1 Measurement Procedures

The measurement procedures are as follows:

- (a) Use base station simulator (if applicable) or engineering software to transmit RF power continuously (continuous Tx) in the highest power channel.
- (b) Keep EUT to radiate maximum output power or 100% factor (if applicable)
- (c) Measure output power through RF cable and power meter.
- (d) Place the EUT in the positions as Annex D demonstrates.
- (e) Set scan area, grid size and other setting on the SATIMO software.
- (f) Measure SAR results for the highest power channel on each testing position.
- (g) Find out the largest SAR result on these testing positions of each band
- (h) Measure SAR results for other channels in worst SAR testing position if the SAR of highest power channel is larger than 0.8 W/kg

According to the test standard, the recommended procedure for assessing the peak spatial-average SAR value consists of the following steps:

- (a) Power reference measurement
- (b) Area scan
- (c) Zoom scan
- (d) Power drift measurement

8.2 Spatial Peak SAR Evaluation

The procedure for spatial peak SAR evaluation has been implemented according to the test standard. It can be conducted for 1g and 10g, as well as for user-specific masses. The SATIMO software includes all numerical procedures necessary to evaluate the spatial peak SAR value.

The base for the evaluation is a "cube" measurement. The measured volume must include the 1g and 10g cubes with the highest averaged SAR values. For that purpose, the center of the measured volume is aligned to the interpolated peak SAR value of a previously performed area scan.

The entire evaluation of the spatial peak values is performed within the post-processing engine. The system always gives the maximum values for the 1g and 10g cubes. The algorithm to find the cube with highest averaged SAR is divided into the following stages:

- (a) Extraction of the measured data (grid and values) from the Zoom Scan
- (b) Calculation of the SAR value at every measurement point based on all stored data
- (c) Generation of a high-resolution mesh within the measured volume
- (d) Interpolation of all measured values from the measurement grid to the high-resolution grid
- (e) Extrapolation of the entire 3D field distribution to the phantom surface over the distance from sensor to surface
- (f) Calculation of the averaged SAR within masses of 1g and 10g

8.3 Area & Zoom Scan Procedures

First Area Scan is used to locate the approximate location(s) of the local peak SAR value(s). The measurement grid within an Area Scan is defined by the grid extent, grid step size and grid offset. Next, in order to determine the EM field distribution in a three-dimensional spatial extension, Zoom Scan is required. The Zoom Scan measures 5x5x7 points with step size 8, 8 and 5 mm for 300 MHz to 3 GHz, and 8x8x8 points with step size 4, 4 and 2.5 mm for 3 GHz to 6 GHz. The Zoom Scan is performed around the highest E-field value to determine the averaged SAR-distribution over 10 g.

8.4 Volume Scan Procedures

The volume scan is used for assess overlapping SAR distributions for antennas transmitting in different frequency bands. It is equivalent to an oversized zoom scan used in standalone measurements. The measurement volume will be used to enclose all the simultaneous transmitting antennas. For antennas transmitting simultaneously in different frequency bands, the volume scan is measured separately in each frequency band. In order to sum correctly to compute the 1g aggregate SAR, the EUT remain in the same test position for all measurements and all volume scan use the same spatial resolution and grid spacing (step-size is 4, 4 and 2.5 mm). When all volume scan were completed, the software can combine and subsequently superpose these measurement data to calculating the multiband SAR.

8.5 SAR Averaged Methods

The local SAR inside the phantom is measured using small dipole sensing elements inside a probe body. The probe tip must not be in contact with the phantom surface in order to minimize measurements errors, but the highest local SAR will occur at the surface of the phantom.

An extrapolation is using to determinate this highest local SAR values. The extrapolation is based on a fourth-order least-square polynomial fit of measured data. The local SAR value is then extrapolated from the liquid surface with a 1mm step.

The measurements have to be performed over a limited time (due to the duration of the battery) so the step of measurement is high. It could vary between 5 and 8 mm. To obtain an accurate assessment of the maximum SAR averaged over 10g and 1 g requires a very fine resolution in the three dimensional scanned data array.

8.6 Power Drift Monitoring

All SAR testing is under the EUT install full charged battery and transmit maximum output power. In SATIMO measurement software, the power reference measurement and power drift measurement procedures are used for monitoring the power drift of EUT during SAR test. Both these procedures measure the field at a specified reference position before and after the SAR testing. The software will calculate the field difference in dB. If the power drift more than 5%, the SAR will be retested.

9. SAR Test Result

9.1 Conducted RF Output Power

Antenna A- WLAN(2.4G) - Maximum Average Power					
Test Mode	Data Rate	Channel	Frequency (MHz)	Average Power (dBm)	Tune-up power (dBm)
802.11b	11Mbps	CH 01	2412	12.41	13.0
		CH 06	2437	11.98	13.0
		CH 11	2462	11.08	13.0
802.11g	54Mbps	CH 01	2412	10.3	11.0
		CH 06	2437	10.87	11.0
		CH 11	2462	10.39	11.0
802.11n (20MHz)	MCS7	CH 01	2412	9.64	11.5
		CH 06	2437	11.11	11.5
		CH 11	2462	10.08	11.5
802.11n (40MHz)	MCS7	CH 03	2422	9.62	10.5
		CH 06	2437	10.13	10.5
		CH 09	2452	9.29	10.5

Antenna B- WLAN(2.4G) - Maximum Average Power					
Test Mode	Data Rate	Channel	Frequency (MHz)	Average Power (dBm)	Tune-up power (dBm)
802.11b	11Mbps	CH 01	2412	12.31	13.0
		CH 06	2437	12.78	13.0
		CH 11	2462	11.7	13.0
802.11g	54Mbps	CH 01	2412	10.52	12.5
		CH 06	2437	12.07	12.5
		CH 11	2462	10.03	12.5
802.11n (20MHz)	MCS7	CH 01	2412	9.86	10.5
		CH 06	2437	10.1	10.5
		CH 11	2462	9.71	10.5
802.11n (40MHz)	MCS7	CH 03	2422	9.14	9.5
		CH 06	2437	9.15	9.5
		CH 09	2452	8.74	9.5

Remark:

1. Per KDB 248227 D01 v02r02, For 802.11b DSSS SAR measurements, DSSS SAR procedure applies to fixed exposure test position and initial test position procedure applies to multiple exposure test positions.
2. Per KDB 248227 D01v02r02, For 802.11b DSSS SAR measurements ,when the reported SAR of the highest measured maximum output power channel (see 3.1) for the exposure configuration is ≤ 0.8 W/kg, no further SAR testing is

required for 802.11b DSSS in that exposure configuration. When the reported SAR is > 0.8 W/kg, SAR is required for that exposure configuration using the next highest measured output power channel. When any reported SAR is > 1.2 W/kg, SAR is required for the third channel; i.e., all channels require testing.

3 .For OFDM modes (802.11g/n), SAR is not required when the highest reported SAR for DSSS is adjusted by the ratio of OFDM to DSSS specified maximum output power and it is $\leq 1.2W/kg$.

Bluetooth - Maximum Average Power			
Test Mode	Data Rate	Average Power(dBm)	Tune-up power(dBm)
GFSK	1Mbps	2.572	3.0
Pi/4 QDPSK	2Mbps	-0.094	3.0
8DPSK	3Mbps	-1.139	3.0

Bluetooth - Maximum Average Power					
Test Mode	Data Rate	Channel	Frequency (MHz)	Average Power (dBm)	Tune-up power(dBm)
BLE	1Mbps	CH 00	2402	1.446	2.0
		CH 19	2440	1.667	2.0
		CH 39	2480	1.211	2.0

Remark:

1. Bluetooth maximum output power is 2.572dBm, and Maximum Tune-Up output power is 3.0dBm. Per KDB 447498 D01 V06, the 1-g and 10-g SAR test exclusion thresholds for 100 MHz to 6 GHz at test separation distances ≤ 50 mm are determined by:

$[(\text{max. power of channel, including tune-up tolerance, mW}) / (\text{min. test separation distance, mm})] \cdot [\sqrt{f(\text{GHz})}] \leq 3.0$ for 1-g SAR and ≤ 7.5 for 10-g extremity SAR, 16 where

- f(GHz) is the RF channel transmit frequency in GHz
- Power and distance are rounded to the nearest mW and mm before calculation¹⁷
- The result is rounded to one decimal place for comparison

Tune-Up Power (dBm)	Max. Power (mW)	Distance (mm)	Frequency (GHz)	Result	Limit
3.0	2.00	5	2.402	0.62	3

The exclusion thresholds is $0.62 < 3$, therefore, the RF exposure evaluation is not required.

2. WLAN and Bluetooth cannot transmit simultaneously.

3. WLAN A and WLAN B cannot transmit simultaneously

9.2 Test Results for Standalone SAR Test

Body SAR

Antenna A -WLAN 2.4GHz– Body SAR Test									
Plot No.	Mode	Test Position Body	Frequency		Output Power (dBm)	Rated Limit (dBm)	Scaling Factor	SAR1g (W/kg)	Scaled SAR1g (W/kg)
			CH.	MHz					
1.	802.11b	Back side	01	2412	12.41	13.0	1.146	0.098	0.112
2.	802.11b	Top side	01	2412	12.41	13.0	1.146	0.007	0.008

Antenna B -WLAN 2.4GHz– Body SAR Test									
Plot No.	Mode	Test Position Body	Frequency		Output Power (dBm)	Rated Limit (dBm)	Scaling Factor	SAR1g (W/kg)	Scaled SAR1g (W/kg)
			CH.	MHz					
3.	802.11b	Back side	01	2412	12.78	13.0	1.052	0.084	0.088
4.	802.11b	Top side	01	2412	12.78	13.0	1.052	0.014	0.015

Remark: Per KDB 447498 D01 v06, if the highest output channel SAR for each exposure position ≤ 0.8 W/kg other channels SAR tests are not necessary.

10. Measurement Uncertainty

10.1 Uncertainty for EUT SAR Test

a	b	c	d	e= f(d,k)	f	g	h= c*f/e	i= c*g/e	k
Uncertainty Component	Sec.	Tol (+- %)	Prob. Dist.	Div.	Ci (1g)	Ci (10g)	1g Ui (+-%)	10g Ui (+-%)	Vi
Measurement System									
Probe calibration	E.2.1	7.0	N	1	1	1	7.00	7.00	∞
Axial Isotropy	E.2.2	2.5	R	$\sqrt{3}$	$(1_{Cp})^{1/2}$	$(1_{Cp})^{1/2}$	1.02	1.02	∞
Hemispherical Isotropy	E.2.2	4.0	R	$\sqrt{3}$	$(Cp)^{1/2}$	$(Cp)^{1/2}$	1.63	1.63	∞
Boundary effect	E.2.3	1.0	R	$\sqrt{3}$	1	1	0.58	0.58	∞
Linearity	E.2.4	5.0	R	$\sqrt{3}$	1	1	2.89	2.89	∞
System detection limits	E.2.5	1.0	R	$\sqrt{3}$	1	1	0.58	0.58	∞
Readout Electronics	E.2.6	0.02	N	1	1	1	0.02	0.02	∞
Reponse Time	E.2.7	3.0	R	$\sqrt{3}$	1	1	1.73	1.73	∞
Integration Time	E.2.8	2.0	R	$\sqrt{3}$	1	1	1.15	1.15	∞
RF ambient Conditions – Noise	E.6.1	3.0	R	$\sqrt{3}$	1	1	1.73	1.73	∞
RF ambient Conditions - Reflections	E.6.1	3.0	R	$\sqrt{3}$	1	1	1.73	1.73	∞
Probe positioner Mechanical Tolerance	E.6.2	2.0	R	$\sqrt{3}$	1	1	1.15	1.15	∞
Probe positioning with respect to Phantom Shell	E.6.3	0.05	R	$\sqrt{3}$	1	1	0.03	0.03	∞
Extrapolation, interpolation and integration Algorithms for Max. SAR Evaluation	E.5	5.0	R	$\sqrt{3}$	1	1	2.89	2.89	∞
Test Sample Related									
Test sample positioning	E.4.2	0.03	N	1	1	1	0.03	0.03	N-1
Device Holder Uncertainty	E.4.1	5.00	N	1	1	1	5.00	5.00	
Output power Variation - SAR drift measurement	E.2.9	12.02	R	$\sqrt{3}$	1	1	6.94	6.94	∞
SAR scaling	E6.5	0.0	R	$\sqrt{3}$	1	1	0.0	0.0	∞
Phantom and Tissue Parameters									
Phantom Uncertainty (Shape and thickness tolerances)	E.3.1	0.05	R	$\sqrt{3}$	1	1	0.03	0.03	∞
Uncertainty in SAR correction for deviations in permittivity and conductivity	E3.2	1.9	R	$\sqrt{3}$	1	0.84	1.10	0.90	∞
Liquid conductivity - deviation	E.3.2	5.00	R	$\sqrt{3}$	0.64	0.43	1.85	1.24	∞

from target value										
Liquid conductivity measurement uncertainty	E.3.3	5.00	N	1	0.64	0.43	3.20	2.15	∞	
Liquid permittivity - deviation from target value	E.3.2	0.37	R	$\sqrt{3}$	0.6	0.49	0.13	0.10	∞	
Liquid permittivity measurement uncertainty	E.3.3	10.00	N	1	0.6	0.49	6.00	4.90	∞	
Combined Standard Uncertainty			RSS				12.98	12.53		
Expanded Uncertainty (95% Confidence interval)			K=2				25.32	24.43		

10.2 Uncertainty for System Performance Check

a	b	c	d	e= f(d,k)	f	g	h= c*f/e	i= c*g/e	k
Uncertainty Component	Sec.	Tol (+-%)	Prob. Dist.	Div.	Ci (1g)	Ci (10g)	1g Ui (+-%)	10g Ui (+-%)	Vi
Measurement System									
Probe calibration	E.2.1	7.0	N	1	1	1	7.00	7.00	∞
Axial Isotropy	E.2.2	2.5	R	$\sqrt{3}$	$(1_Cp)^{1/2}$	$(1_Cp)^{1/2}$	1.02	1.02	∞
Hemispherical Isotropy	E.2.2	4.0	R	$\sqrt{3}$	$(Cp)^{1/2}$	$(Cp)^{1/2}$	1.63	1.63	∞
Boundary effect	E.2.3	1.0	R	$\sqrt{3}$	1	1	0.58	0.58	∞
Linearity	E.2.4	5.0	R	$\sqrt{3}$	1	1	2.89	2.89	∞
System detection limits	E.2.5	1.0	R	$\sqrt{3}$	1	1	0.58	0.58	∞
Modulation response	E.2.5	0	R	$\sqrt{3}$	0	0	0.0	0.0	∞
Readout Electronics	E.2.6	0.02	N	1	1	1	0.02	0.02	∞
Reponse Time	E.2.7	3.0	R	$\sqrt{3}$	1	1	1.73	1.73	∞
Integration Time	E.2.8	2.0	R	$\sqrt{3}$	1	1	1.15	1.15	∞
RF ambient Conditions – Noise	E.6.1	3.0	R	$\sqrt{3}$	1	1	1.73	1.73	∞
RF ambient Conditions - Reflections	E.6.1	3.0	R	$\sqrt{3}$	1	1	1.73	1.73	∞
Probe positioner Mechanical Tolerance	E.6.2	2.0	R	$\sqrt{3}$	1	1	1.15	1.15	∞
Probe positioning with respect to Phantom Shell	E.6.3	0.05	R	$\sqrt{3}$	1	1	0.03	0.03	∞
Extrapolation, interpolation and integration Algorithms for Max.	E.5.2	5.0	R	$\sqrt{3}$	1	1	2.89	2.89	∞

SAR Evaluation									
Dipole									
Dipole axis to liquid Distance	8,E.4.2	1.00	N	$\sqrt{3}$	1	1	0.58	0.58	N-1
Input power and SAR drift measurement	8,6.6.2	12.02	R	$\sqrt{3}$	1	1	6.94	6.94	∞
Deviation of experimental dipole from numerical dipole	E.6.4	5.5	R	$\sqrt{3}$	1	1	3.20	3.20	∞
Phantom and Tissue Parameters									
Phantom Uncertainty (Shape and thickness tolerances)	E.3.1	0.05	R	$\sqrt{3}$	1	1	0.03	0.03	∞
Uncertainty in SAR correction for deviations in permittivity and conductivity	E3.2	2.0	R	$\sqrt{3}$	1	0.84	1.10	1.10	∞
Liquid conductivity - deviation from target value	E.3.2	5.00	R	$\sqrt{3}$	0.64	0.43	1.85	1.24	
Liquid conductivity - measurement uncertainty	E.3.3	5.00	N	1	0.64	0.43	3.20	2.15	
Liquid permittivity - deviation from target value	E.3.2	0.37	R	$\sqrt{3}$	0.6	0.49	0.13	0.10	
Liquid permittivity - measurement uncertainty	E.3.3	10.00	N	1	0.6	0.49	6.00	4.90	M
Combined Standard Uncertainty			RSS				12.00	11.50	
Expanded Uncertainty (95% Confidence interval)			K=2				23.39	22.43	

Annex A. Plots of System Performance Check

MEASUREMENT 1

For Body Liquid

Type: Validation measurement (Fast, 75.00 %)

Date of measurement: 2017/11/01

Measurement duration: 12 minutes 21 seconds

E-field Probe: SSE5 - SN 09/13 EP168; ConvF: 5.80; Calibrated: 2017/06/01

A. Experimental conditions

Area Scan	dx=8mm dy=8mm
Phantom	Validation plane
Device Position	Dipole
Band	CW2450
Signal	Duty Cycle 1:1

B. SAR Measurement Results

Frequency (MHz)	2450.000000
Relative Permittivity (real part)	52.010212
Conductivity (S/m)	1.910255
Power Variation (%)	1.369745
Ambient Temperature	21.1
Liquid Temperature	21.2

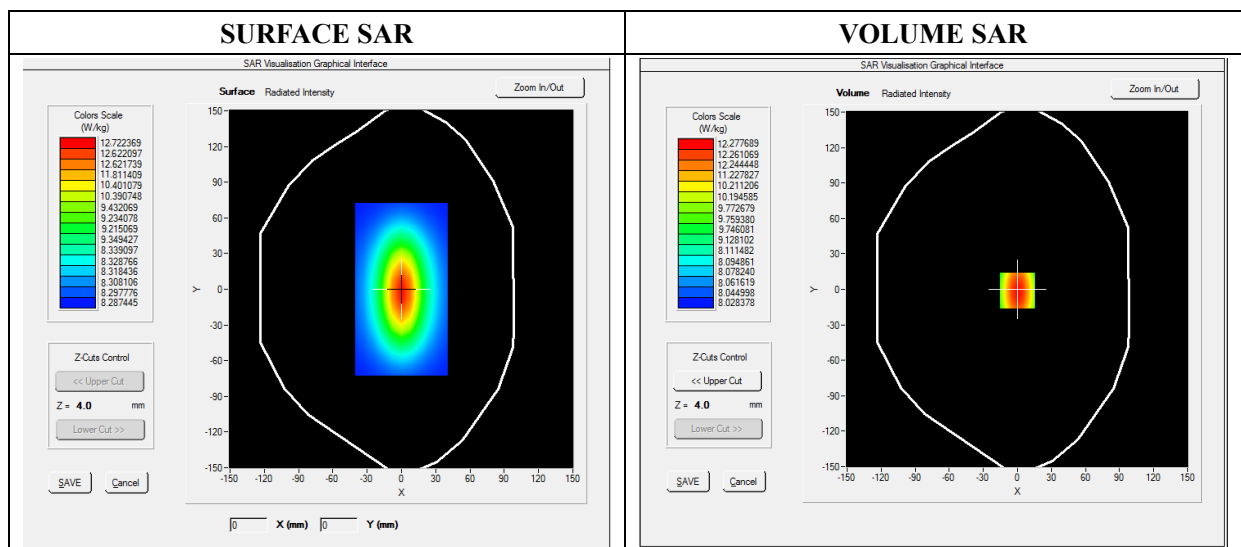

Maximum location: X=0.00, Y=0.00

SAR 10g (W/Kg)	6.351512
SAR 1g (W/Kg)	12.600533

Z Axis Scan

Z (mm)	0.00	4.00	9.00	14.00	19.00	24.00	29.00
SAR (W/Kg)	0.0000	12.1631	10.01221	9.2566	8.5623	6.3469	4.5626

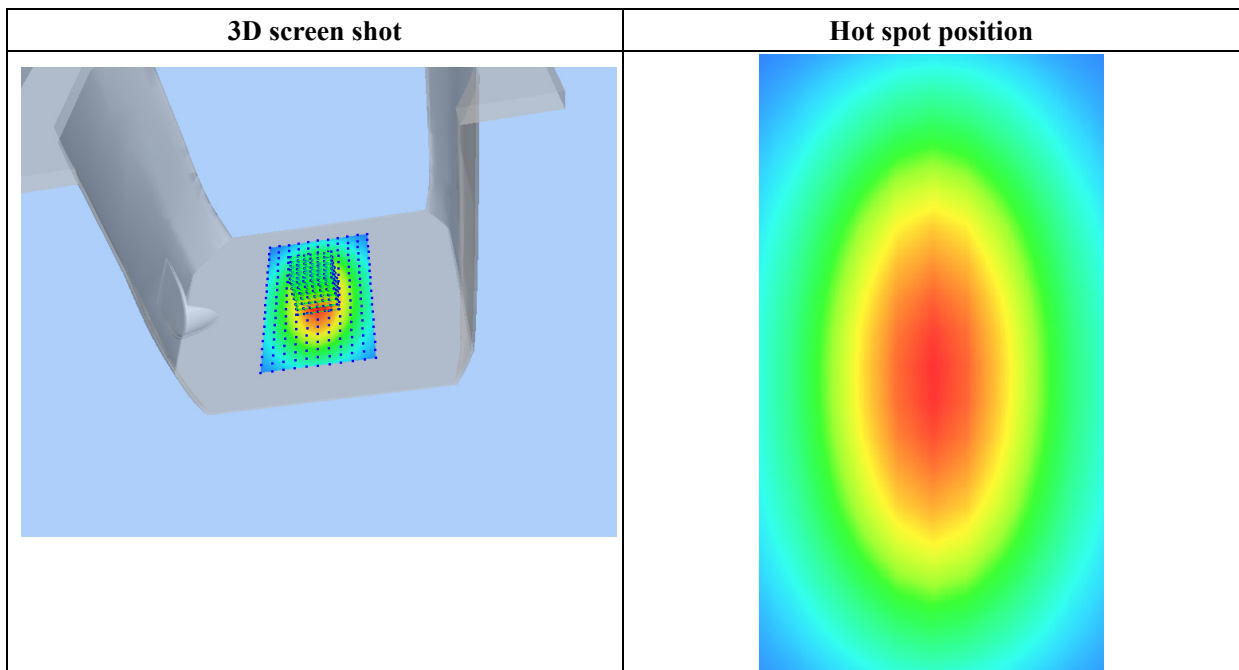
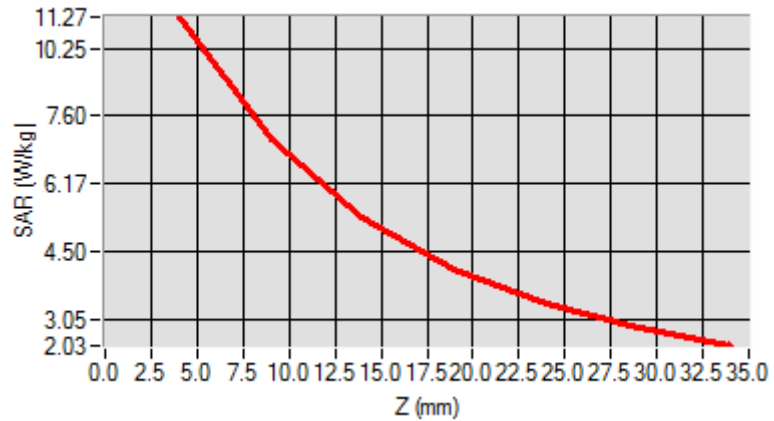

Annex B. Plots of SAR Measurement

<u>TYPE</u>	<u>BAND</u>	<u>PARAMETERS</u>
Tablet	Antenna A_WiFi_802.11b	<u>Measurement 1: Flat Plane with Back side device position on Low Channel in 802.11b mode</u>
Tablet	Antenna B_WiFi_802.11b	<u>Measurement 3: Flat Plane with Back side device position on Low Channel in 802.11b mode</u>
<i>Remark: SAR plot is showed the highest measured SAR in each exposure configuration, wireless mode and frequency band combination.</i>		

MEASUREMENT 1

Type: Phone measurement (Complete)

Date of measurement: 2017/11/01

Measurement duration: 12 minutes 3 seconds

E-field Probe: SSE5 - SN 09/13 EP168; ConvF: 5.80; Calibrated: 2017/06/01

A. Experimental conditions

Area Scan	sam_direct_droit2_surf8mm.txt
Phantom	Flat Plane
Device Position	Back
Band	Antenna A -WiFi_802.11b
Channels	Low
Signal	Duty Cycle 1:1

B. SAR Measurement Results

Frequency (MHz)	2412.000000
Relative Permittivity (real part)	52.010212
Conductivity (S/m)	1.910255
Power Variation (%)	0.937231
Ambient Temperature	21.1
Liquid Temperature	21.2

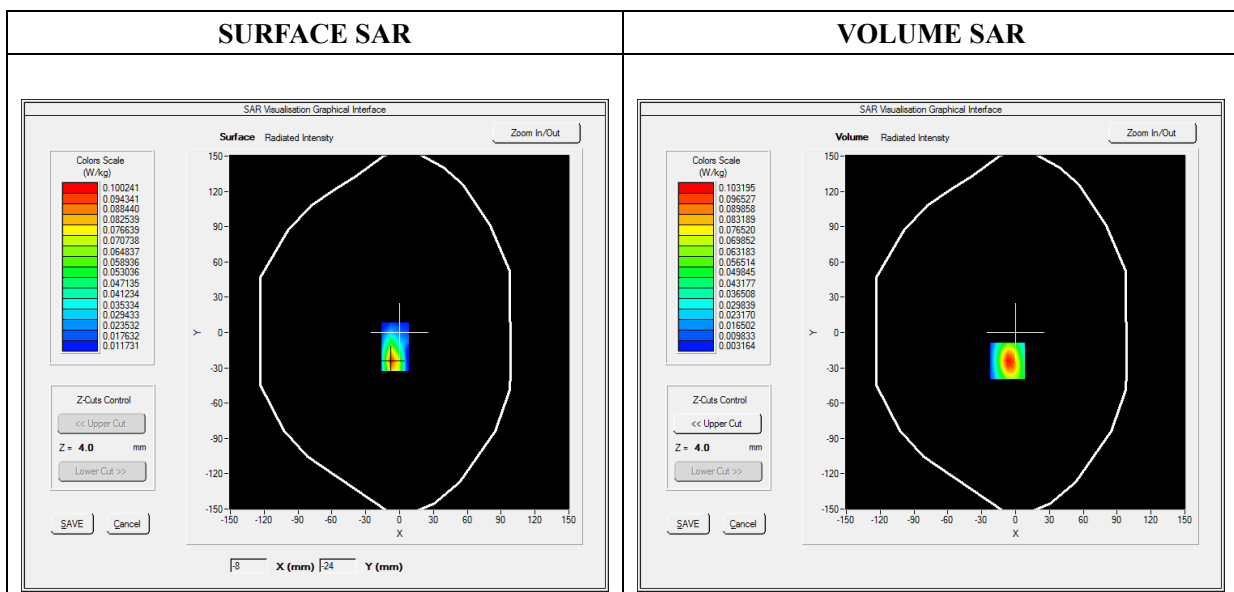

Maximum location: X=-7.00, Y=-24.00

SAR Peak: 0.24 W/kg

SAR 10g (W/Kg)	0.039330
SAR 1g (W/Kg)	0.097674

Z (mm)	0.00	4.00	9.00	14.00	19.00
SAR (W/Kg)	0.2355	0.1032	0.0297	0.0080	0.0040

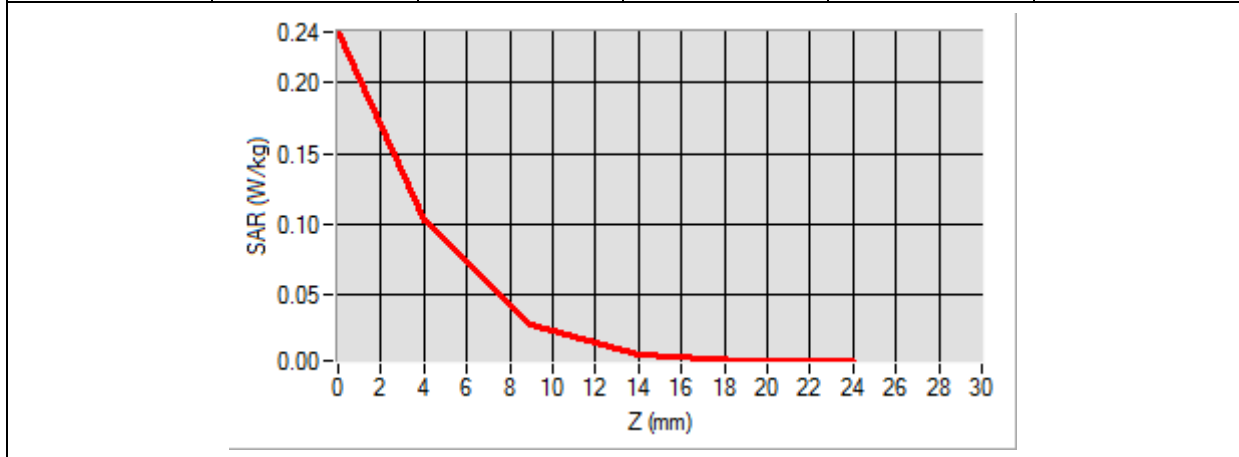

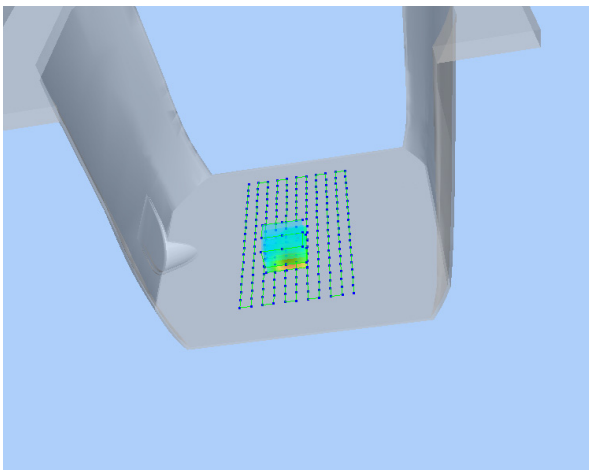
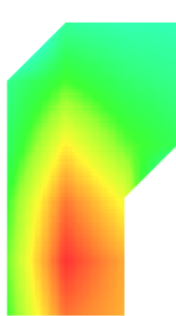
3D screen shot	Hot spot position
	

MEASUREMENT 3

Type: Phone measurement (Complete)

Date of measurement: 2017/11/01

Measurement duration: 12 minutes 3 seconds

E-field Probe: SSE5 - SN 09/13 EP168; ConvF: 5.80; Calibrated: 2017/06/01

A. Experimental conditions

Area Scan	sam_direct_droit2_surf8mm.txt
Phantom	Flat Plane
Device Position	Back
Band	Antenna B-WiFi_802.11b
Channels	Low
Signal	Duty Cycle 1:1

B. SAR Measurement Results

Frequency (MHz)	2412.000000
Relative Permittivity (real part)	52.010212
Conductivity (S/m)	1.910255
Power Variation (%)	0.648833
Ambient Temperature	21.1
Liquid Temperature	21.2

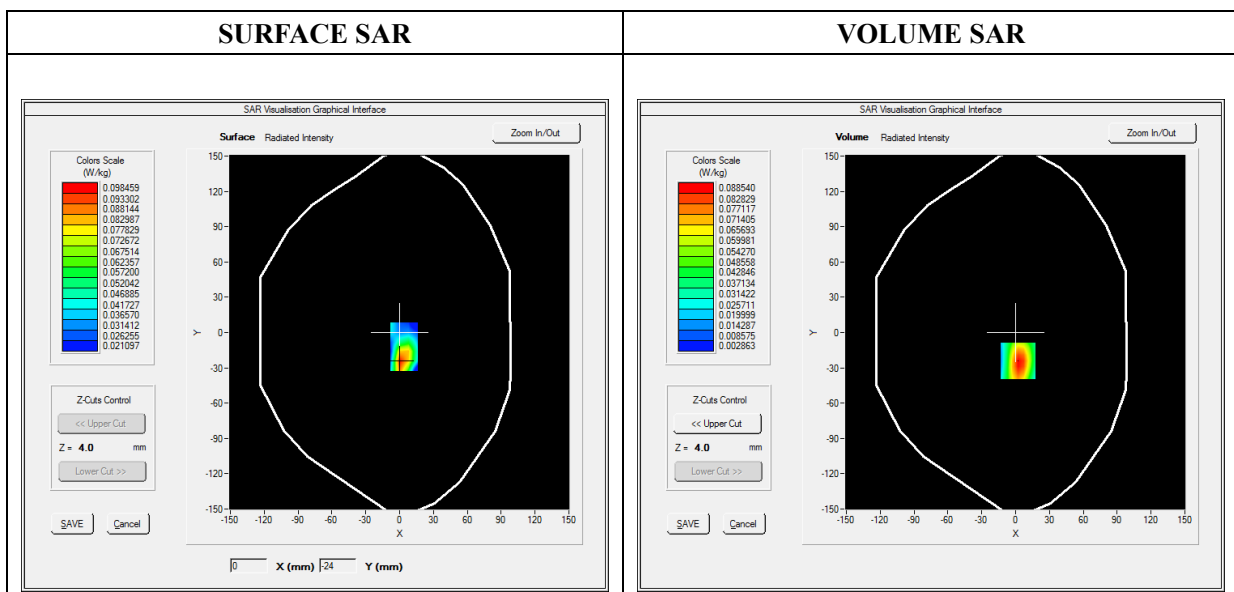

Maximum location: X=2.00, Y=-24.00

SAR Peak: 0.18 W/kg

SAR 10g (W/Kg)	0.037173
SAR 1g (W/Kg)	0.083796

Z (mm)	0.00	4.00	9.00	14.00	19.00
SAR (W/Kg)	0.1817	0.0885	0.0318	0.0114	0.0059

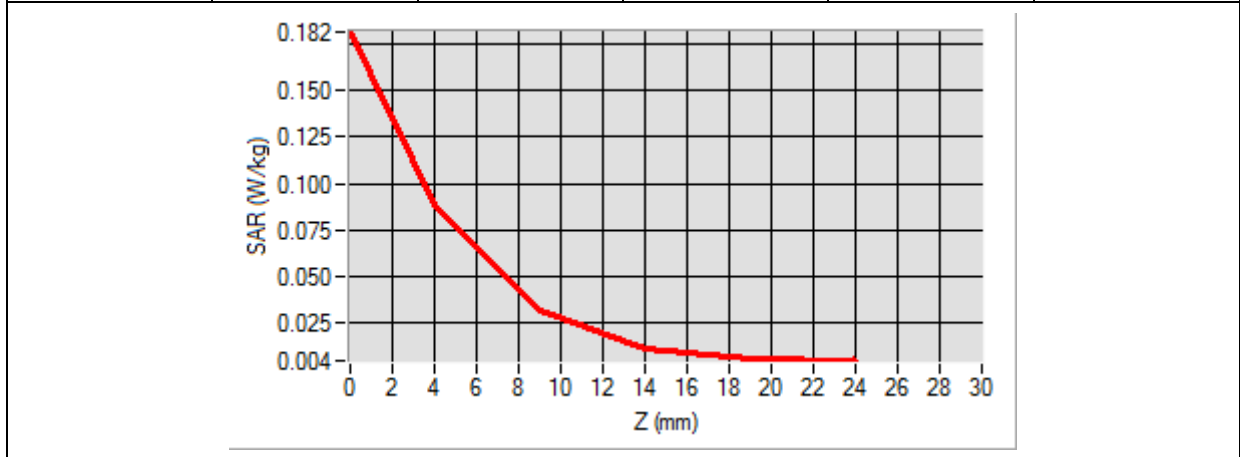

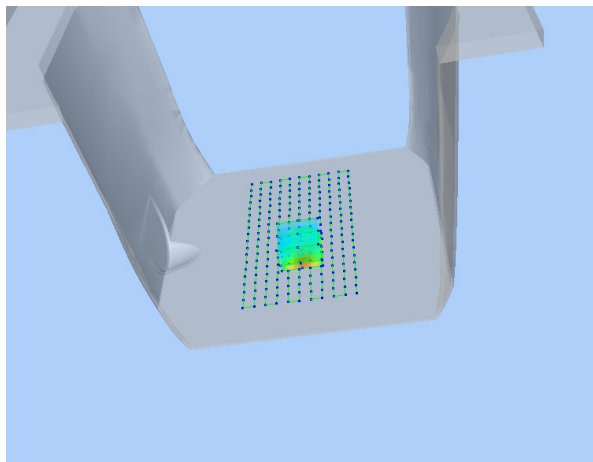
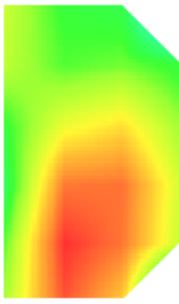
3D screen shot	Hot spot position
	

Annex C. EUT Photos

EUT View_1

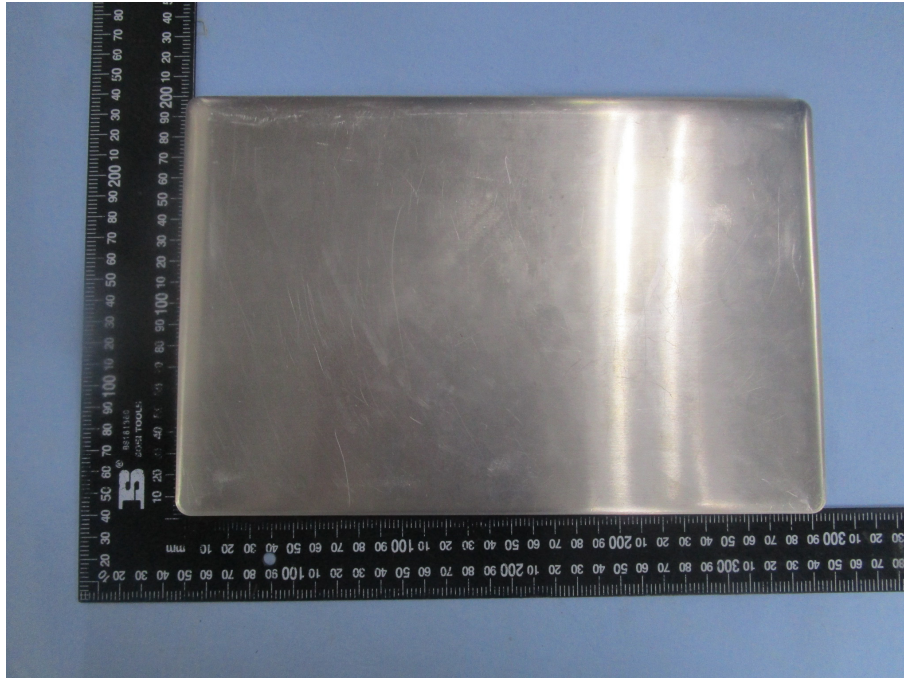

EUT View_2

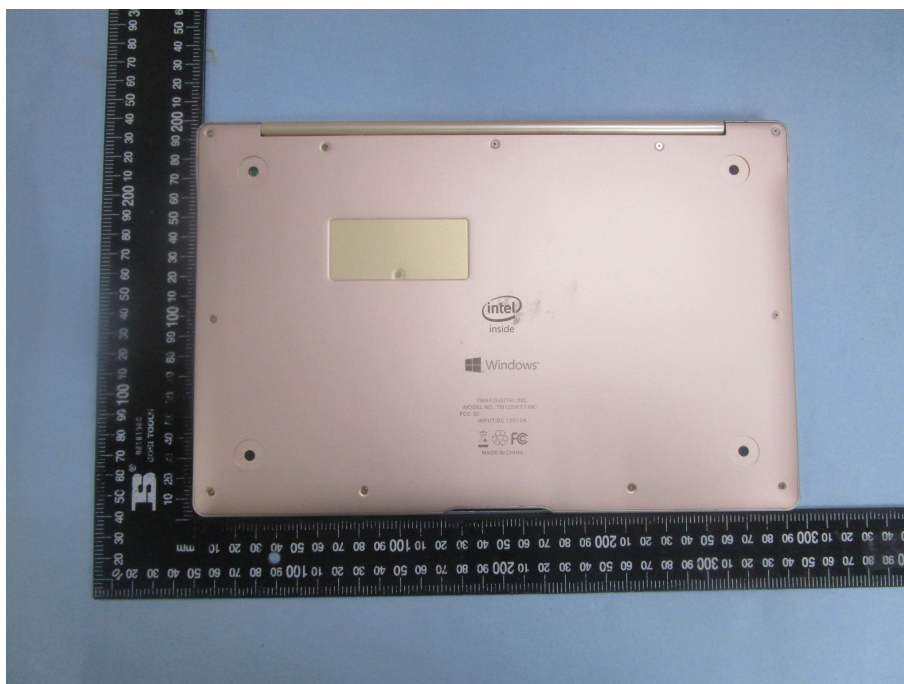

EUT View_3



Antenna View

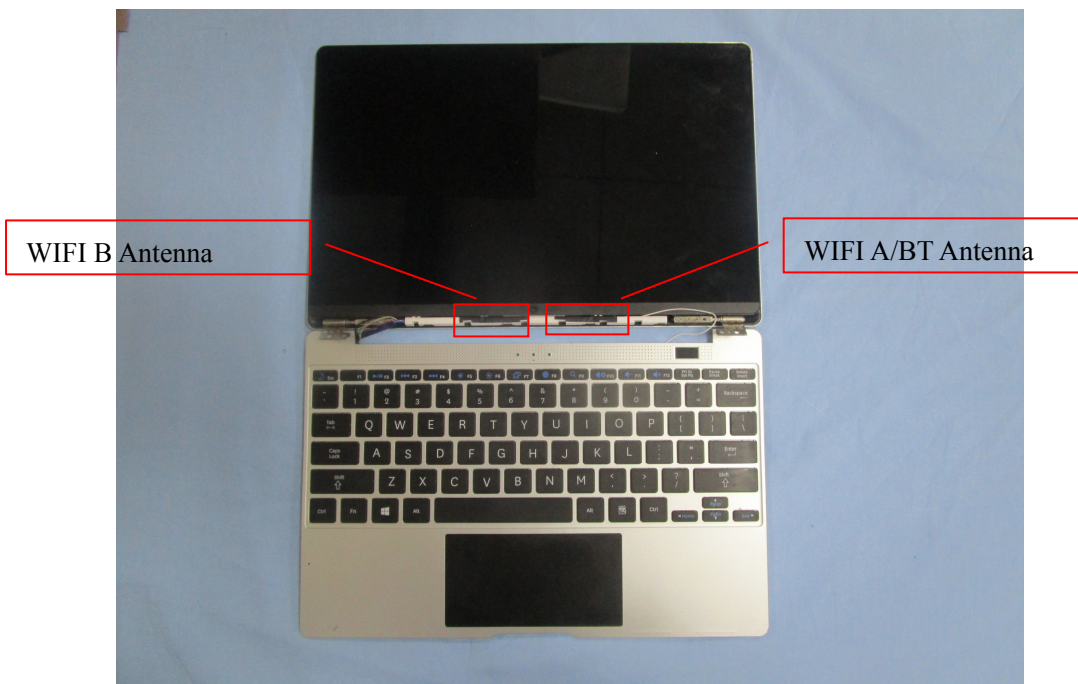

Annex D. Test Setup Photos

Test View 1

Body Back

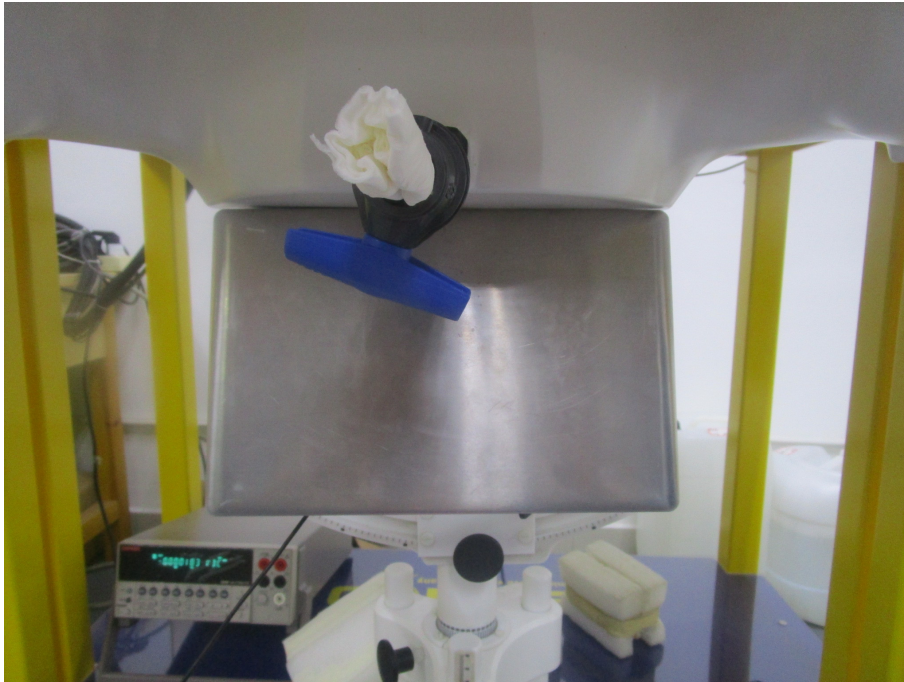

Body Top

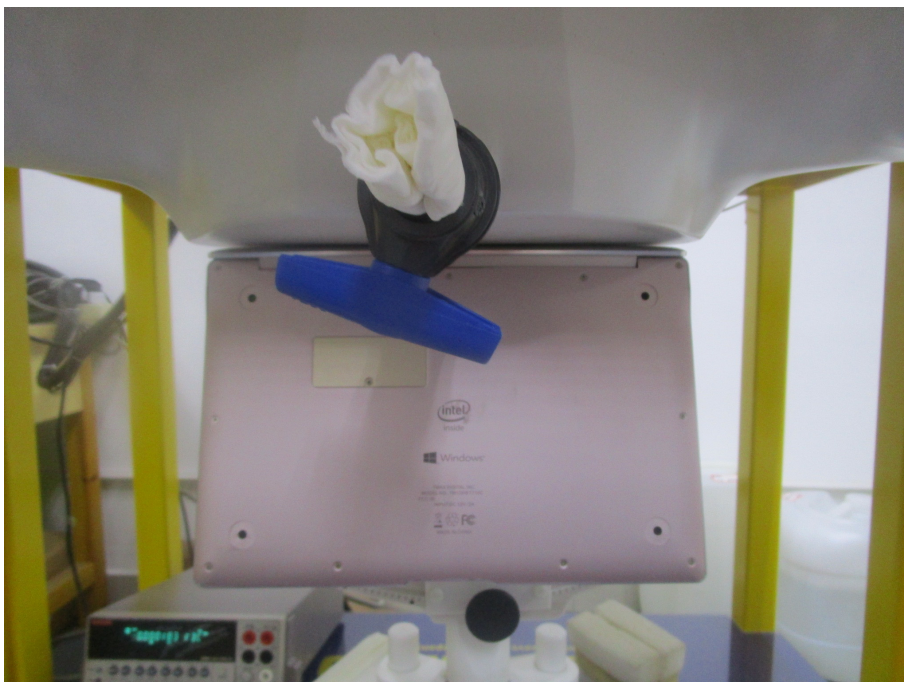

Annex E. Calibration Certificate

Please refer to the exhibit for the calibration certificate

***** END OF REPORT *****