



**FCC CFR47 PART 15 SUBPART C
CERTIFICATION
TEST REPORT**

FOR

BLUETOOTH MODULE

MODEL NUMBER: WML-C43

FCC ID: POOWML-C43

REPORT NUMBER: 06J10249-1

ISSUE DATE: JUNE 02, 2006

Prepared for

**MITSUMI ELECTRIC CO., LTD.
2-11-2, TSURUMAKI, TAMA-SHI
TOKYO 206-8567, JAPAN**

Prepared by

**COMPLIANCE CERTIFICATION SERVICES
561F MONTEREY ROAD
MORGAN HILL, CA 95037, USA
TEL: (408) 463-0885
FAX: (408) 463-0888**

NVLAP[®]

LAB CODE:200065-0

Revision History

<u>Rev.</u>	<u>Issue Date</u>	<u>Revisions</u>	<u>Revised By</u>
--	6/02/06	Initial Issue	A. Ilarina

TABLE OF CONTENTS

1. ATTESTATION OF TEST RESULTS.....	5
2. TEST METHODOLOGY	6
3. FACILITIES AND ACCREDITATION	6
4. CALIBRATION AND UNCERTAINTY.....	6
4.1. <i>MEASURING INSTRUMENT CALIBRATION.....</i>	<i>6</i>
4.2. <i>MEASUREMENT UNCERTAINTY.....</i>	<i>6</i>
5. EQUIPMENT UNDER TEST.....	7
5.1. <i>DESCRIPTION OF EUT.....</i>	<i>7</i>
5.2. <i>MAXIMUM OUTPUT POWER.....</i>	<i>7</i>
5.3. <i>DESCRIPTION OF AVAILABLE ANTENNAS.....</i>	<i>7</i>
5.4. <i>SOFTWARE AND FIRMWARE.....</i>	<i>7</i>
5.5. <i>WORST-CASE CONFIGURATION AND MODE.....</i>	<i>7</i>
5.6. <i>DESCRIPTION OF TEST SETUP.....</i>	<i>8</i>
6. TEST AND MEASUREMENT EQUIPMENT	10
7. LIMITS AND RESULTS	11
7.1. <i>ANTENNA PORT CHANNEL TESTS FOR 8PSK MODULATION.....</i>	<i>11</i>
7.1.1. 20 dB BANDWIDTH	11
7.1.2. PEAK OUTPUT POWER	15
7.1.3. MAXIMUM PERMISSIBLE EXPOSURE	19
7.1.4. AVERAGE POWER.....	22
7.1.5. CONDUCTED SPURIOUS EMISSIONS.....	23
7.2. <i>ANTENNA PORT CHANNEL TESTS FOR GFSK MODULATION.....</i>	<i>32</i>
7.2.1. 20 dB BANDWIDTH	32
7.2.2. PEAK OUTPUT POWER	36
7.2.3. MAXIMUM PERMISSIBLE EXPOSURE	40
7.2.4. AVERAGE POWER.....	43
7.2.5. CONDUCTED SPURIOUS EMISSIONS.....	44
7.3. <i>RADIATED EMISSIONS.....</i>	<i>53</i>
7.3.1. TRANSMITTER RADIATED SPURIOUS EMISSIONS	53
7.3.2. TRANSMITTER RADIATED EMISSIONS ABOVE 1 GHZ WITH 8PSK MODULATION	56
7.3.3. TRANSMITTER RADIATED EMISSIONS ABOVE 1 GHZ WITH GFSK MODULATION	65
7.3.4. WORST-CASE RADIATED EMISSIONS BELOW 1 GHz WITH 8PSK MODULATION	

7.3.5. WORST-CASE RADIATED EMISSIONS BELOW 1 GHz WITH GFSK
MODULATION 78

7.4. POWERLINE CONDUCTED EMISSIONS 82

8. SETUP PHOTOS 86

1. ATTESTATION OF TEST RESULTS

COMPANY NAME: MITSUMI ELECTRIC CO., LTD.
2-11-2, TSURUMAKI, TAMA-SHI
TOKYO 206-8567, JAPAN

EUT DESCRIPTION: BLUETOOTH MODULE

MODEL: WML-C43

SERIAL NUMBER: WS21E

DATE TESTED: MAY 16 - 30, 2006

APPLICABLE STANDARDS	
STANDARD	TEST RESULTS
FCC PART 15 SUBPART C	NO NON-COMPLIANCE NOTED

Compliance Certification Services, Inc. tested the above equipment in accordance with the requirements set forth in the above standards. The test results show that the equipment tested is capable of demonstrating compliance with the requirements as documented in this report.

Note: The results documented in this report apply only to the tested sample, under the conditions and modes of operation as described herein. This document may not be altered or revised in any way unless done so by Compliance Certification Services and all revisions are duly noted in the revisions section. Any alteration of this document not carried out by Compliance Certification Services will constitute fraud and shall nullify the document. No part of this report may be used to claim product certification, approval, or endorsement by NVLAP, NIST, or any government agency.

Approved & Released For CCS By:

Tested By:



ALVIN ILARINA
EMC SUPERVISOR
COMPLIANCE CERTIFICATION SERVICES



HSIN FU SHIH
EMC ENGINEER
COMPLIANCE CERTIFICATION SERVICES

2. TEST METHODOLOGY

The tests documented in this report were performed in accordance with ANSI C63.4-2003, FCC CFR 47 Part 2 and FCC CFR 47 Part 15.

3. FACILITIES AND ACCREDITATION

The test sites and measurement facilities used to collect data are located at 561F Monterey Road, Morgan Hill, California, USA. The sites are constructed in conformance with the requirements of ANSI C63.4, ANSI C63.7 and CISPR Publication 22. All receiving equipment conforms to CISPR Publication 16-1, "Radio Interference Measuring Apparatus and Measurement Methods."

CCS is accredited by NVLAP, Laboratory Code 200065-0. The full scope of accreditation can be viewed at <http://www.ccsemc.com>.

4. CALIBRATION AND UNCERTAINTY

4.1. MEASURING INSTRUMENT CALIBRATION

The measuring equipment utilized to perform the tests documented in this report has been calibrated in accordance with the manufacturer's recommendations, and is traceable to recognized national standards.

4.2. MEASUREMENT UNCERTAINTY

Where relevant, the following measurement uncertainty levels have been estimated for tests performed on the apparatus:

PARAMETER	UNCERTAINTY
Radiated Emission, 30 to 200 MHz	+/- 3.3 dB
Radiated Emission, 200 to 1000 MHz	+4.5 / -2.9 dB
Radiated Emission, 1000 to 2000 MHz	+4.5 / -2.9 dB
Power Line Conducted Emission	+/- 2.9 dB

Uncertainty figures are valid to a confidence level of 95%.

5. EQUIPMENT UNDER TEST

5.1. DESCRIPTION OF EUT

The EUT is a Ver. 2.0+EDR Bluetooth transceiver.

The radio module is manufactured by Mitsumi Electric Co., Ltd.

5.2. MAXIMUM OUTPUT POWER

The transmitter has a maximum peak conducted output power as follows:

8PSK 2400 to 2483.5 MHz Authorized Band

Frequency Range (MHz)	Output Power (dBm)	Output Power (mW)
2402 - 2480	5.83	3.83

GFSK 2400 to 2483.5 MHz Authorized Band

Frequency Range (MHz)	Output Power (dBm)	Output Power (mW)
2402 - 2480	3.66	2.32

5.3. DESCRIPTION OF AVAILABLE ANTENNAS

The radio utilizes an inverted F antenna with a maximum gain of 1.3 dBi.

5.4. SOFTWARE AND FIRMWARE

The firmware installed in the EUT during testing was BCM2045 Version 002.003.014.

The EUT driver software installed in the host support equipment during testing was USB Driver Version 5.0.1.400.

The test utility software used during testing was Bluetool Version 0.9.1.2.

5.5. WORST-CASE CONFIGURATION AND MODE

The worst-case channel is determined as the channel with the highest output power. The highest measured output power was at 2480 MHz for GFSK and 8PSK modulations.

5.6. DESCRIPTION OF TEST SETUP

SUPPORT EQUIPMENT

PERIPHERAL SUPPORT EQUIPMENT LIST				
Description	Manufacturer	Model	Serial Number	FCC ID
Laptop	DELL	INSPIRON 5100	HD1R241	DoC
Laptop Power Supply	DELL	PA-1900-05D	06G356	DoC
Test Fixture	Mitsumi	n/a	1749	n/a
Power Supply	Volgen	SP15U-03S	none	n/a

I/O CABLES

I/O CABLE LIST						
Cable No.	Port	# of Identical Ports	Connector Type	Cable Type	Cable Length	Remarks
1	USB	1	USB	Un-shielded	3.0'	
2	Power	1	Solder	Un-shielded	2.5'	
3	Power	1	Terminal	Un-shielded	2.5'	
4	Power	1	PC Power	Un-shielded	3.0'	
5	Power	1	PC Power	Un-shielded	3.0'	

TEST SETUP

The EUT is installed in a test fixture connected to a laptop computer during the tests. Test software exercised the EUT.

SETUP DIAGRAM FOR TESTS

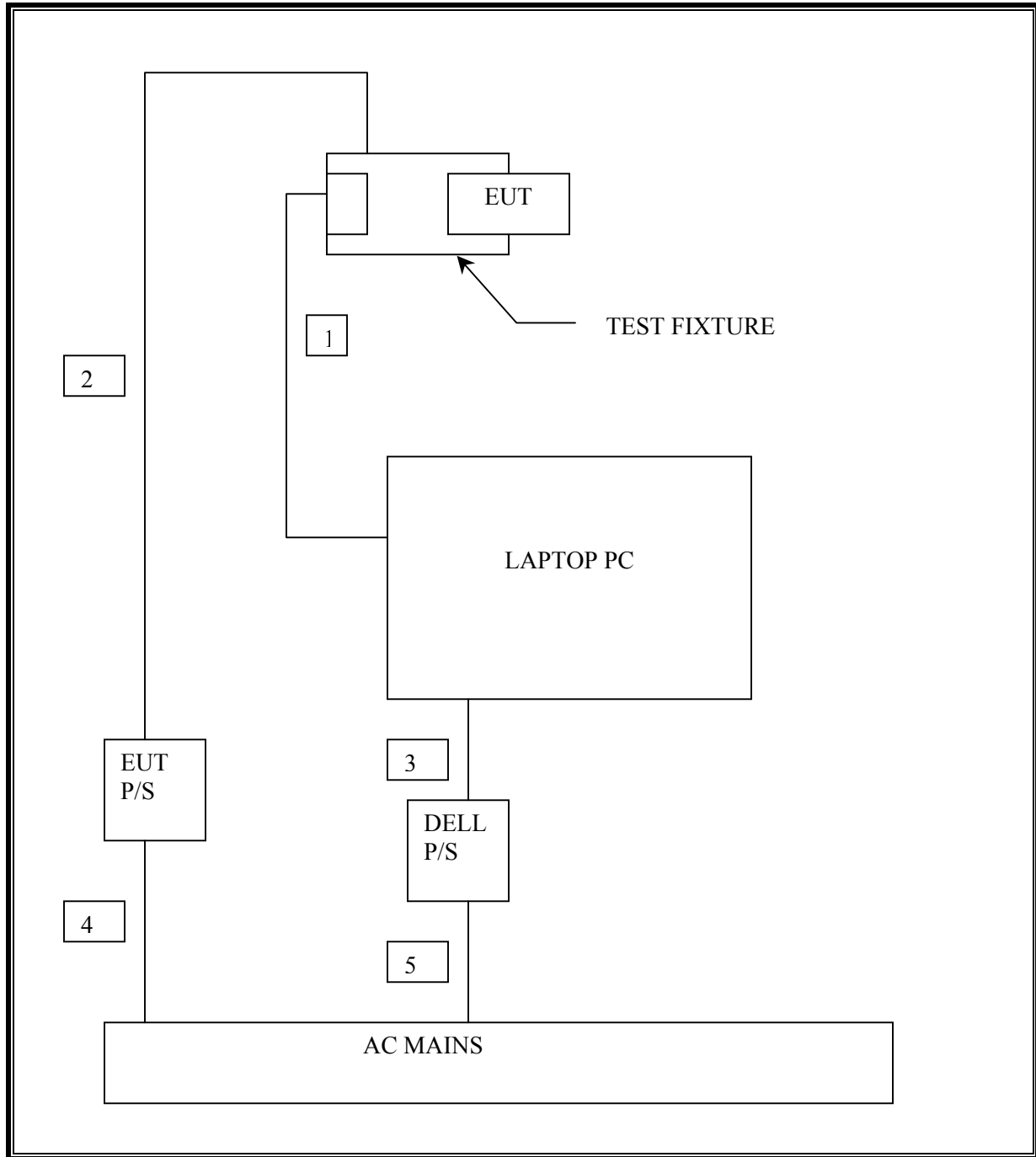

6. TEST AND MEASUREMENT EQUIPMENT

The following test and measurement equipment was utilized for the tests documented in this report:

TEST EQUIPMENT LIST				
Description	Manufacturer	Model	Serial Number	Cal Due
EMI Test Receiver	R & S	ESHS 20	827129/006	06/03/2006
Site A Line Stabilizer / Conditioner	Tripplite	LC-1800a	A0051681	CNR
LISN, 10 kHz ~ 30 MHz	FCC	LISN-50/250-25-2	2023	08/30/2006
LISN, 10 kHz ~ 30 MHz	Solar	8012-50-R-24-BNC	8379443	08/30/2006
Spectrum Analyzer	HP	E4446A	US42510266	10/19/2006
Antenna, Horn 1 ~ 18 GHz	EMCO	3117	29310	04/22/2007
Preamplifier, 1 ~ 26.5 GHz	HP	8449B	3008A00369	10/03/2007
Peak Power Meter	Agilent	E4416A	GB41291160	12/02/2007
Peak / Average Power Sensor	Agilent	E9327A	US40440755	12/02/2007
RF Filter Section	HP	85420E	3705A00256	02/04/2007
EMI Receiver, 9 kHz ~ 2.9 GHz	HP	8542E	3942A00286	02/04/2007
30MHz---- 2Ghz	Sunol Sciences	JB1 Antenna	A121003	09/03/2006
4.0 High Pass Filter	Micro Tronics	HPM13351	3	N/A

7. LIMITS AND RESULTS

7.1. ANTENNA PORT CHANNEL TESTS FOR 8PSK MODULATION

7.1.1. 20 dB BANDWIDTH

LIMIT

None; for reporting purposes only.

TEST PROCEDURE

The transmitter output is connected to a spectrum analyzer. The RBW is set to 1% to 3% of the 20 dB bandwidth. The VBW is set to 3 times the RBW. The sweep time is coupled.

RESULTS

No non-compliance noted:

Channel	Frequency (MHz)	20 dB Bandwidth (kHz)
Low	2402	1344
Middle	2441	1345
High	2480	1347

20 dB BANDWIDTH

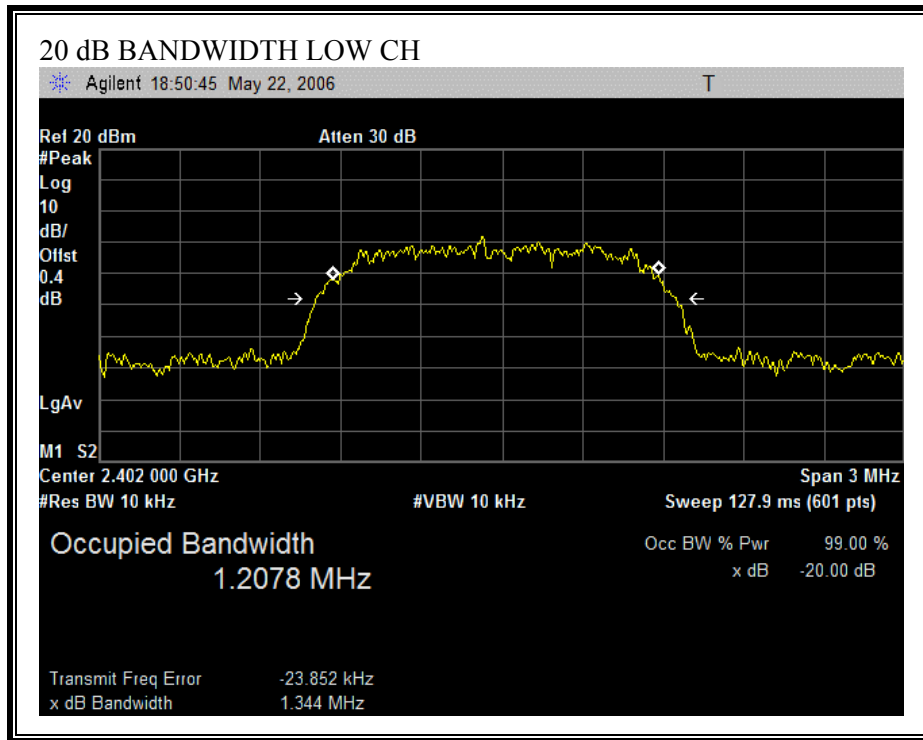

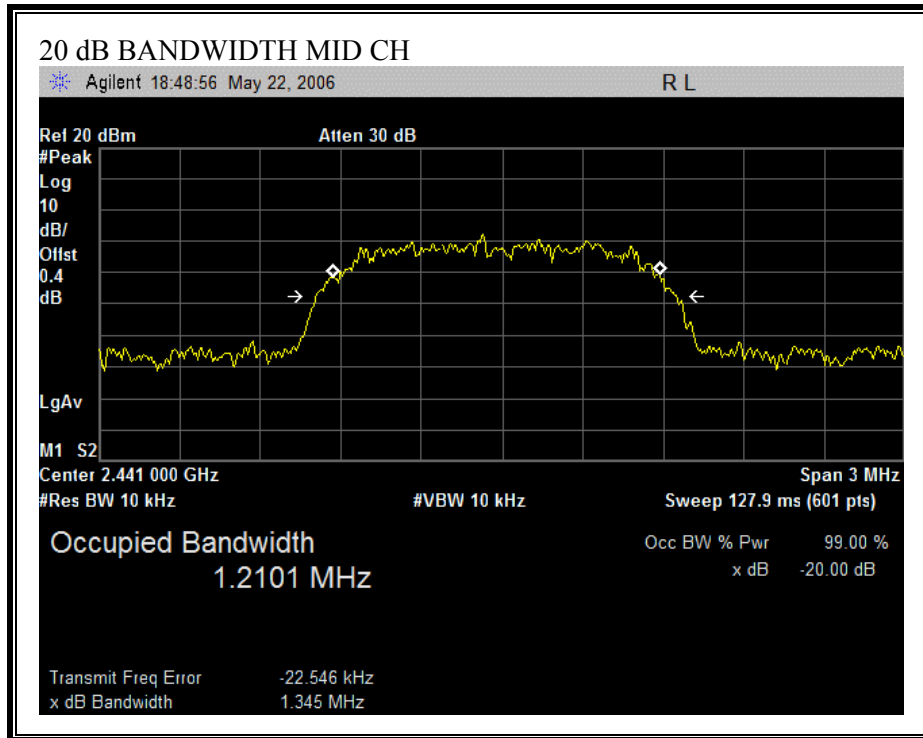

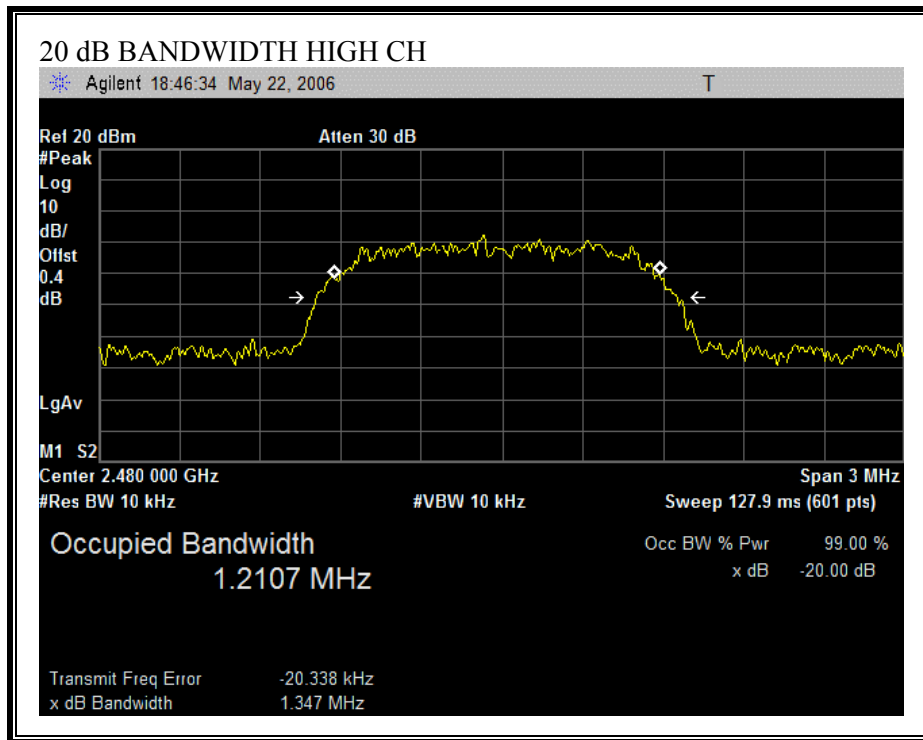

7.1.2. PEAK OUTPUT POWER

PEAK POWER LIMIT

§15.247 (b) The maximum peak output power of the intentional radiator shall not exceed the following:

§15.247 (b) (1) For frequency hopping systems operating in the 2400-2483.5 MHz band employing at least 75 hopping channels: 1 watt.

§15.247 (b) (4) Except as shown in paragraphs (b)(3) (i), (ii) and (iii) of this section, if transmitting antennas of directional gain greater than 6 dBi are used the peak output power from the intentional radiator shall be reduced below the stated values in paragraphs (b)(1) or (b)(2) of this section, as appropriate, by the amount in dB that the directional gain of the antenna exceeds 6 dBi.

The maximum antenna gain is 1.3 dBi, therefore the limit is 30 dBm.

TEST PROCEDURE

The transmitter output is connected to a spectrum analyzer and the analyzer bandwidth is set to a value greater than the 20 dB bandwidth of the EUT.

RESULTS

No non-compliance noted:

Channel	Frequency (MHz)	Peak Power (dBm)	Limit (dBm)	Margin (dB)
Low	2402	5.35	30	-24.65
Middle	2441	5.69	30	-24.31
High	2480	5.83	30	-24.17

OUTPUT POWER

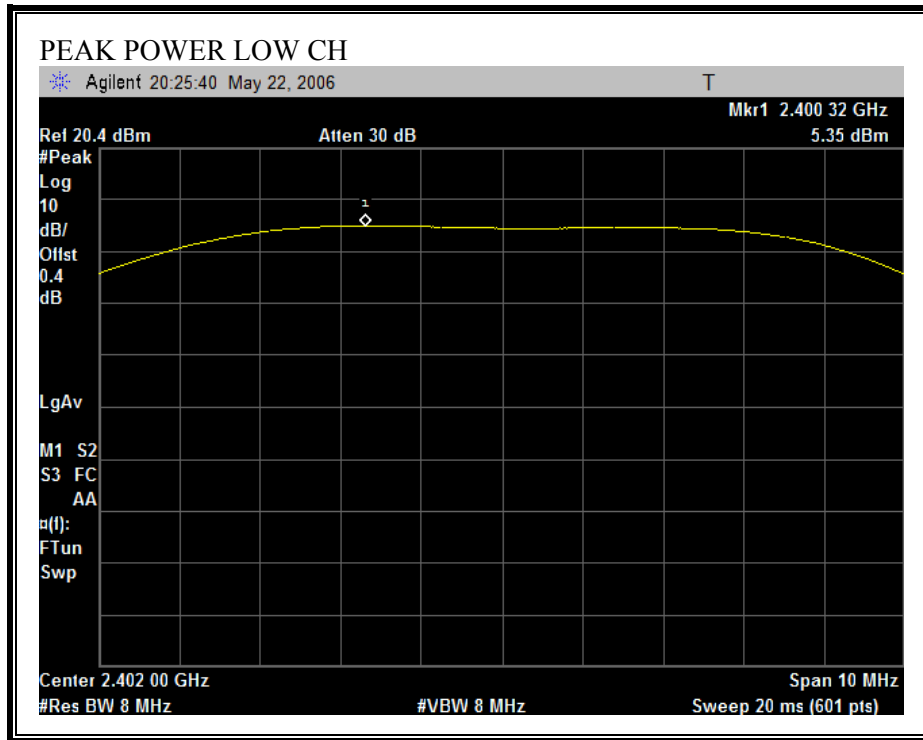

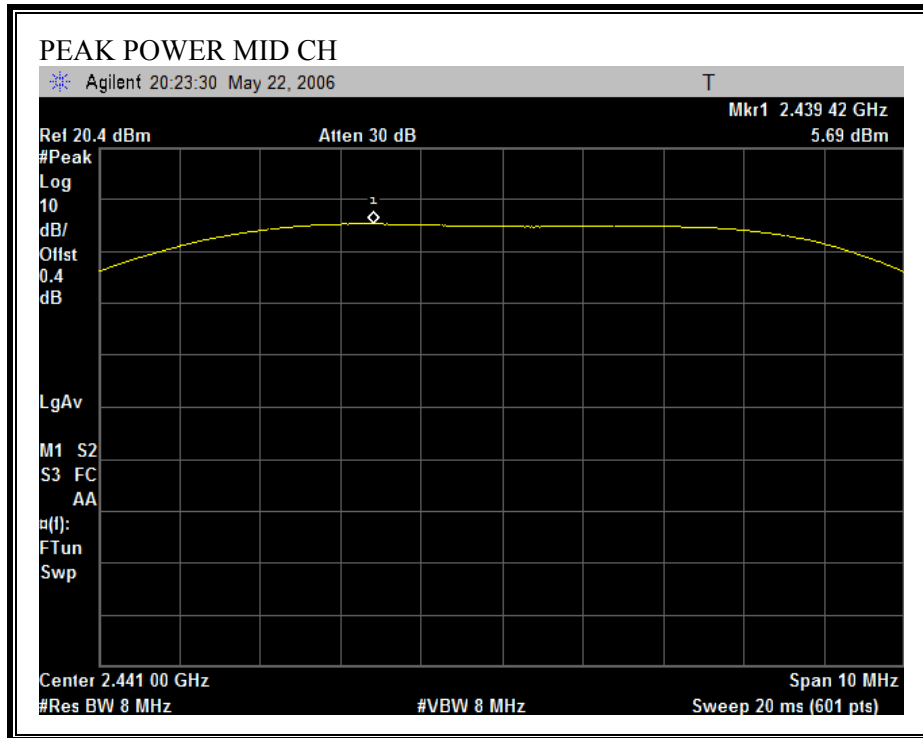

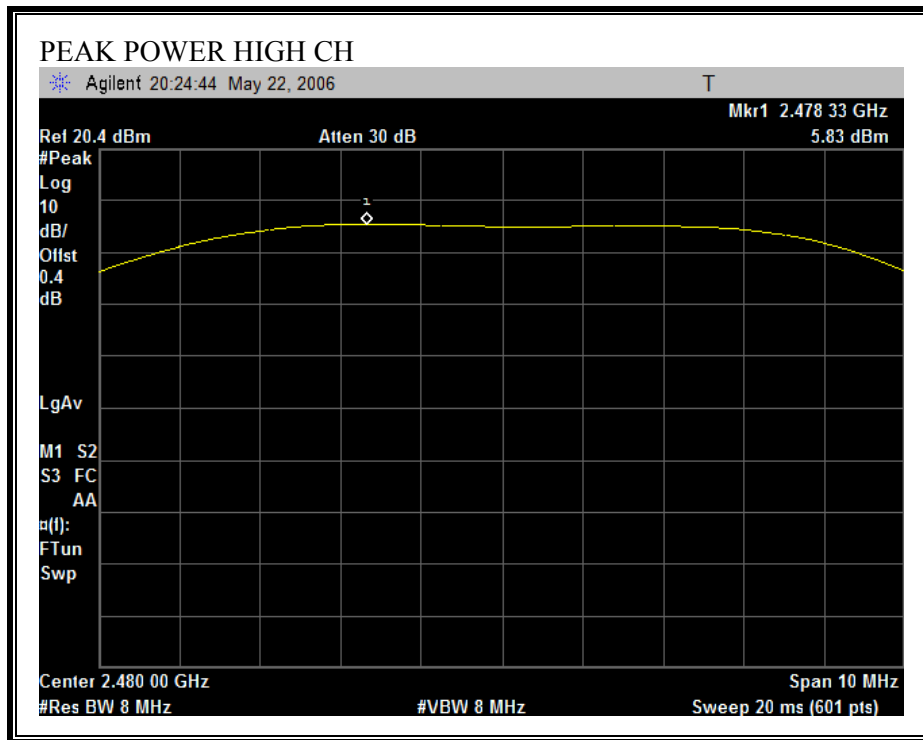

7.1.3. MAXIMUM PERMISSIBLE EXPOSURE

LIMITS

§1.1310 The criteria listed in Table 1 shall be used to evaluate the environmental impact of human exposure to radio-frequency (RF) radiation as specified in §1.1307(b), except in the case of portable devices which shall be evaluated according to the provisions of §2.1093 of this chapter.

TABLE 1—LIMITS FOR MAXIMUM PERMISSIBLE EXPOSURE (MPE)

Frequency range (MHz)	Electric field strength (V/m)	Magnetic field strength (A/m)	Power density (mW/cm ²)	Averaging time (minutes)
(A) Limits for Occupational/Controlled Exposures				
0.3–3.0	614	1.63	*(100)	6
3.0–30	1842/f	4.89/f	*(900/f ²)	6
30–300	61.4	0.163	1.0	6
300–1500	f/300	6
1500–100,000	5	6
(B) Limits for General Population/Uncontrolled Exposure				
0.3–1.34	614	1.63	*(100)	30
1.34–30	824/f	2.19/f	*(180/f ²)	30

TABLE 1—LIMITS FOR MAXIMUM PERMISSIBLE EXPOSURE (MPE)—Continued

Frequency range (MHz)	Electric field strength (V/m)	Magnetic field strength (A/m)	Power density (mW/cm ²)	Averaging time (minutes)
30–300	27.5	0.073	0.2	30
300–1500	f/1500	30
1500–100,000	1.0	30

f = frequency in MHz

* = Plane-wave equivalent power density

NOTE 1 TO TABLE 1: Occupational/controlled limits apply in situations in which persons are exposed as a consequence of their employment provided those persons are fully aware of the potential for exposure and can exercise control over their exposure. Limits for occupational/controlled exposure also apply in situations when an individual is transient through a location where occupational/controlled limits apply provided he or she is made aware of the potential for exposure.

NOTE 2 TO TABLE 1: General population/uncontrolled exposures apply in situations in which the general public may be exposed, or in which persons that are exposed as a consequence of their employment may not be fully aware of the potential for exposure or can not exercise control over their exposure.

CALCULATIONS

Given

$$E = \sqrt{(30 * P * G) / d}$$

and

$$S = E^2 / 3770$$

where

E = Field Strength in Volts/meter

P = Power in Watts

G = Numeric antenna gain

d = Distance in meters

S = Power Density in milliwatts/square centimeter

Combining equations and rearranging the terms to express the distance as a function of the remaining variables yields:

$$d = \sqrt{((30 * P * G) / (3770 * S))}$$

Changing to units of Power to mW and Distance to cm, using:

$$P \text{ (mW)} = P \text{ (W)} / 1000 \text{ and}$$

$$d \text{ (cm)} = 100 * d \text{ (m)}$$

yields

$$d = 100 * \sqrt{((30 * (P / 1000) * G) / (3770 * S))}$$

$$d = 0.282 * \sqrt{(P * G / S)}$$

where

d = distance in cm

P = Power in mW

G = Numeric antenna gain

S = Power Density in mW/cm²

Substituting the logarithmic form of power and gain using:

$$P \text{ (mW)} = 10^{(P \text{ (dBm)} / 10)} \text{ and}$$

$$G \text{ (numeric)} = 10^{(G \text{ (dBi)} / 10)}$$

yields

$$d = 0.282 * 10^{((P + G) / 20)} / \sqrt{S}$$

where

d = MPE distance in cm

P = Power in dBm

G = Antenna Gain in dBi

S = Power Density Limit in mW/cm²

Rearranging terms to calculate the power density at a specific distance yields

$$S = 0.0795 * 10^{((P + G) / 10)} / (d^2)$$

LIMITS

From §1.1310 Table 1 (B), the maximum value of $S = 1.0 \text{ mW/cm}^2$

RESULTS

MPE Distance (cm)	Output Power (dBm)	Antenna Gain (dBi)	Power Density (mW/cm²)
20.0	5.83	1.30	0.0010

NOTE: For mobile or fixed location transmitters, the minimum separation distance is 20 cm, even if calculations indicate that the MPE distance would be less.

7.1.4. AVERAGE POWER

AVERAGE POWER LIMIT

None; for reporting purposes only.

TEST PROCEDURE

The transmitter output is connected to a power meter.

RESULTS

No non-compliance noted:

The cable assembly insertion loss of 0.4 dB (including 0 dB pad and 0.4 dB cable) was entered as an offset in the power meter to allow for direct reading of power.

Channel	Frequency (MHz)	Average Power (dBm)
Low	2402	2.38
Middle	2441	2.82
High	2480	3.15

7.1.5. CONDUCTED SPURIOUS EMISSIONS

LIMITS

§15.247 (c) In any 100 kHz bandwidth outside the frequency band in which the spread spectrum intentional radiator is operating, the radio frequency power that is produced by the intentional radiator shall be at least 20 dB below that in the 100 kHz bandwidth within the band that contains the highest level of the desired power, based on either an RF conducted or a radiated measurement. Attenuation below the general limits specified in §15.209(a) is not required. In addition, radiated emissions which fall in the restricted bands, as defined in §15.205(a), must also comply with the radiated emission limits specified in §15.209(a) (see §15.205(c)).

TEST PROCEDURE

The transmitter output is connected to a spectrum analyzer. The resolution bandwidth is set to 100 kHz. The video bandwidth is set to 300 kHz.

The spectrum from 30 MHz to 26 GHz is investigated with the transmitter set to the lowest, middle, and highest channels.

RESULTS

No non-compliance noted:

SPURIOUS EMISSIONS, LOW CHANNEL

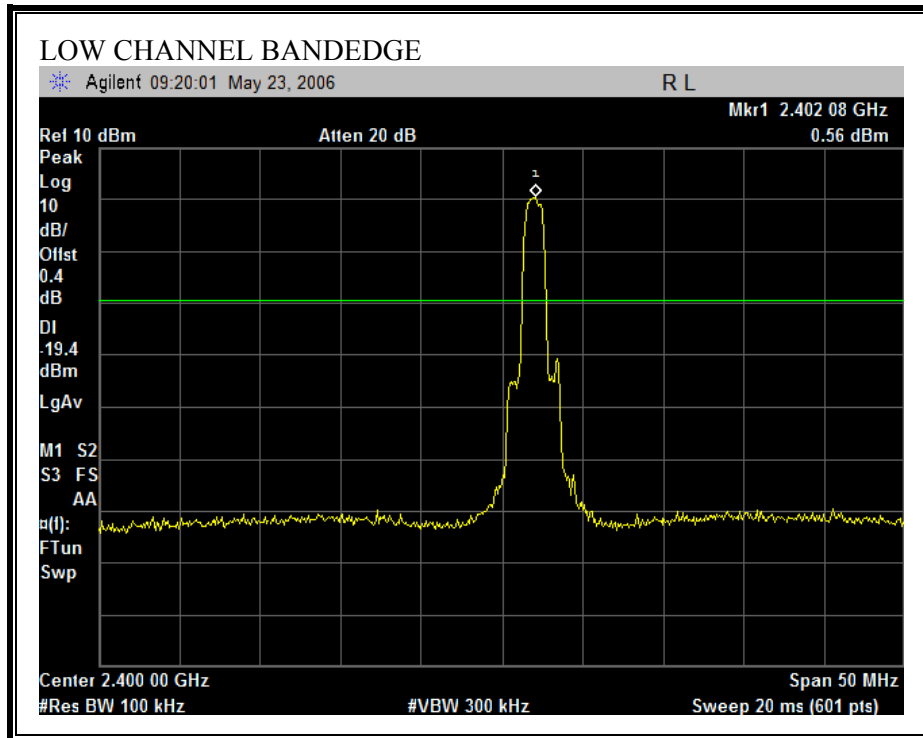

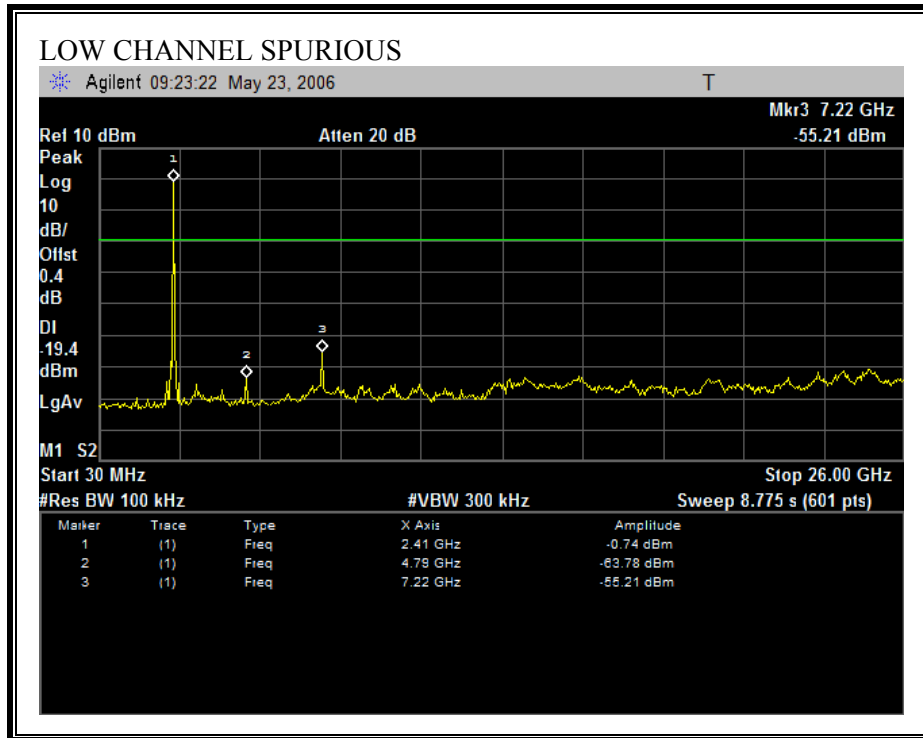

SPURIOUS EMISSIONS, MID CHANNEL

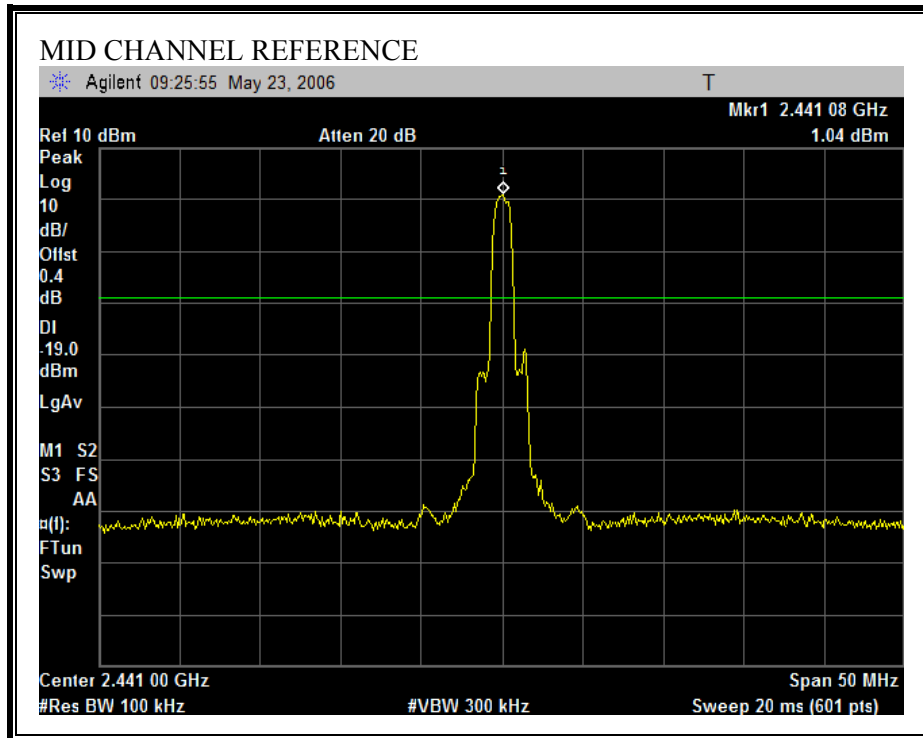

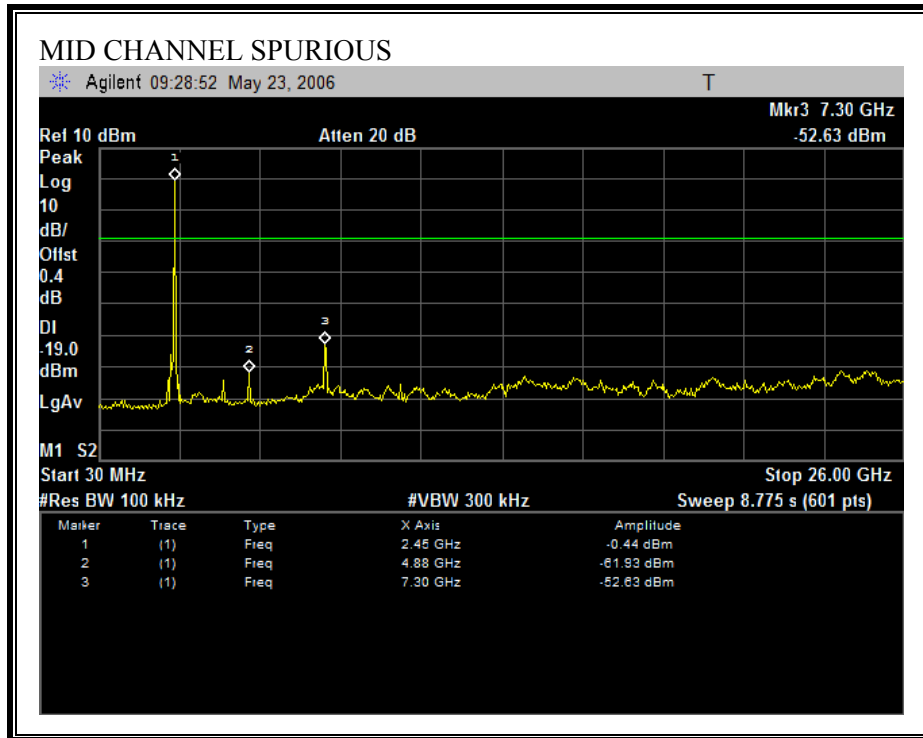

SPURIOUS EMISSIONS, HIGH CHANNEL

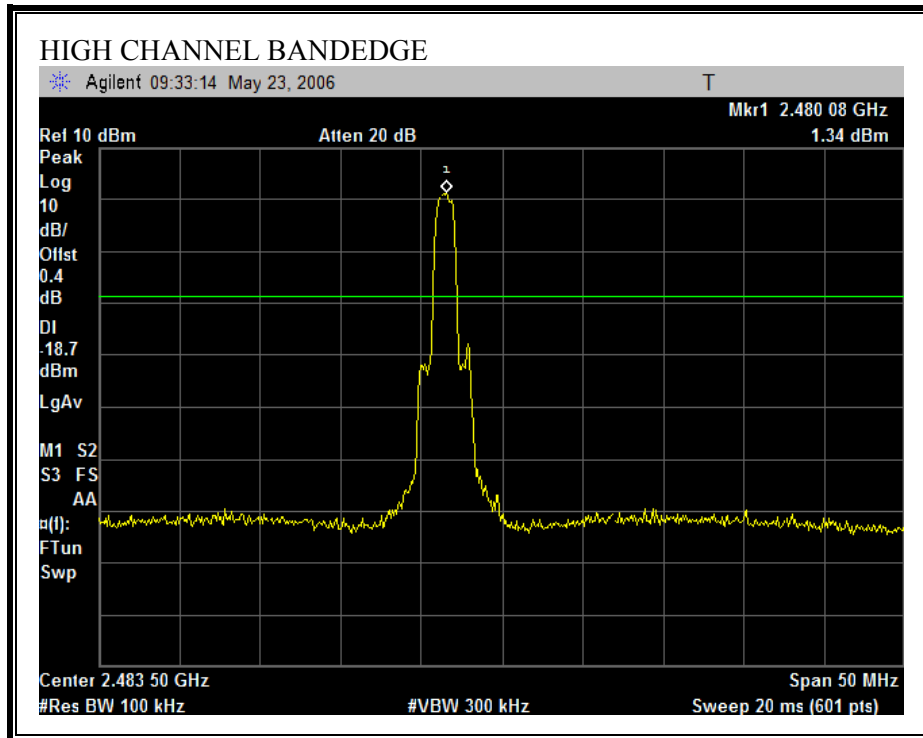

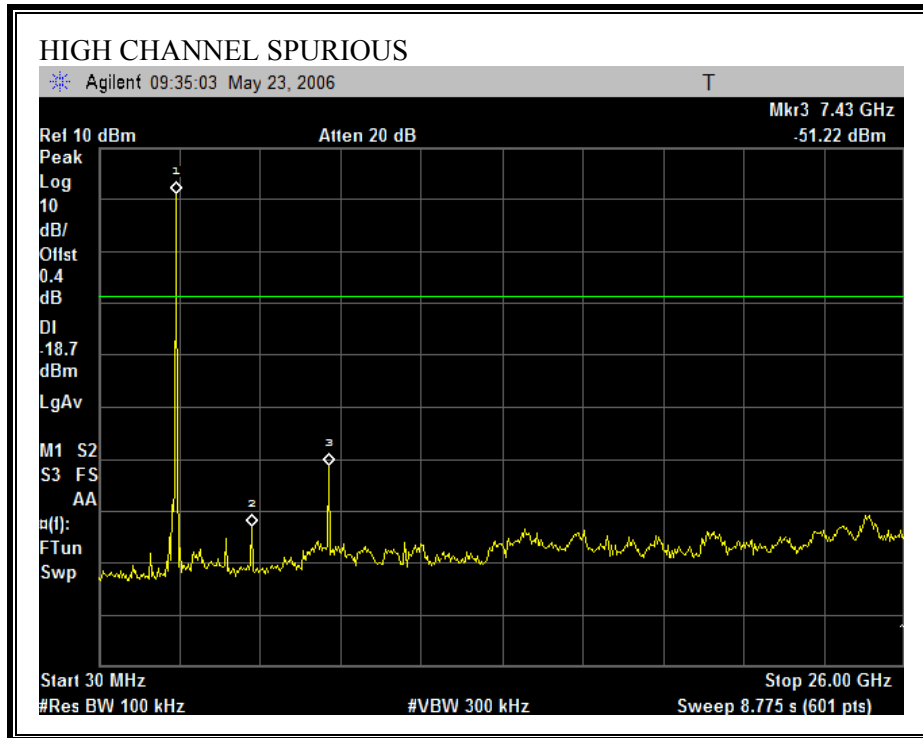

SPURIOUS BANDEDGE EMISSIONS WITH HOPPING ON

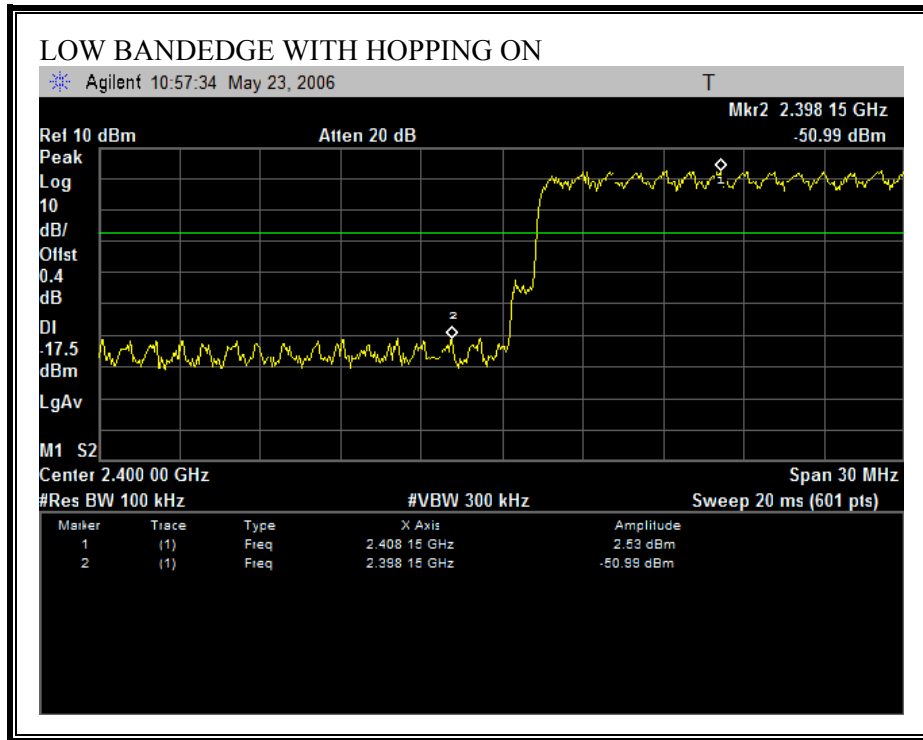

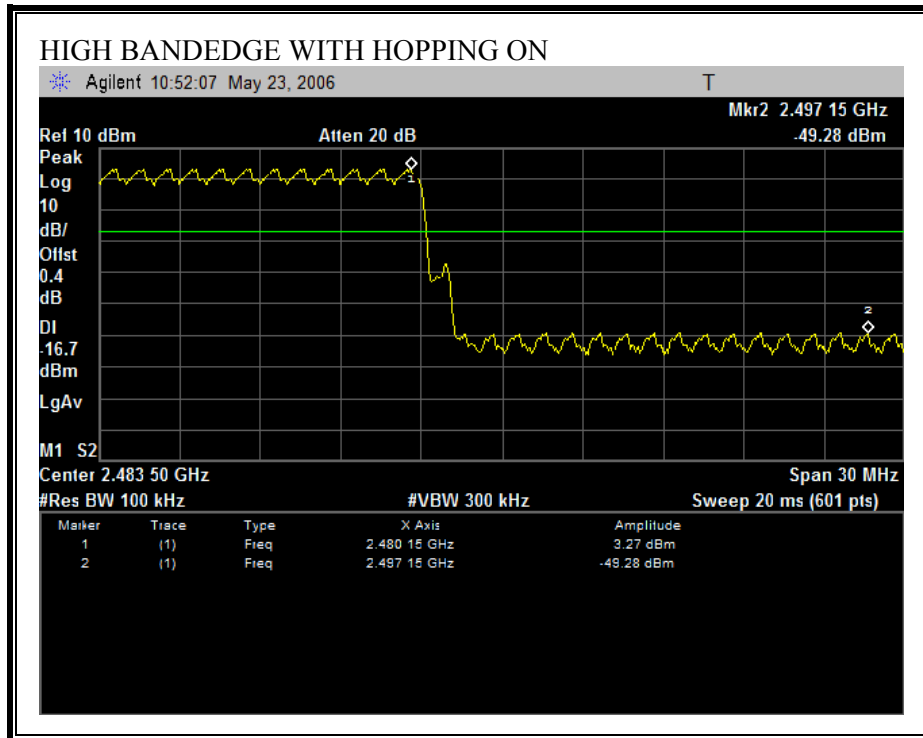

7.2. ANTENNA PORT CHANNEL TESTS FOR GFSK MODULATION

7.2.1. 20 dB BANDWIDTH

LIMIT

None; for reporting purposes only.

TEST PROCEDURE

The transmitter output is connected to a spectrum analyzer. The RBW is set to 1% to 3% of the 20 dB bandwidth. The VBW is set to 3 times the RBW. The sweep time is coupled.

RESULTS

No non-compliance noted:

Channel	Frequency (MHz)	20 dB Bandwidth (kHz)
Low	2402	920.419
Middle	2441	920.442
High	2480	922.168

20 dB BANDWIDTH

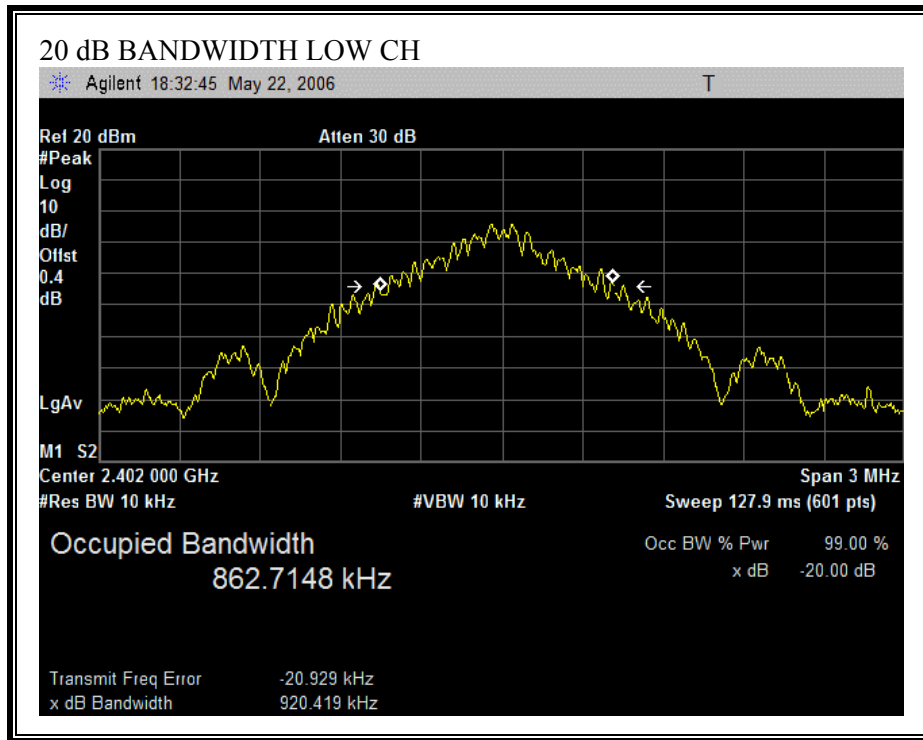

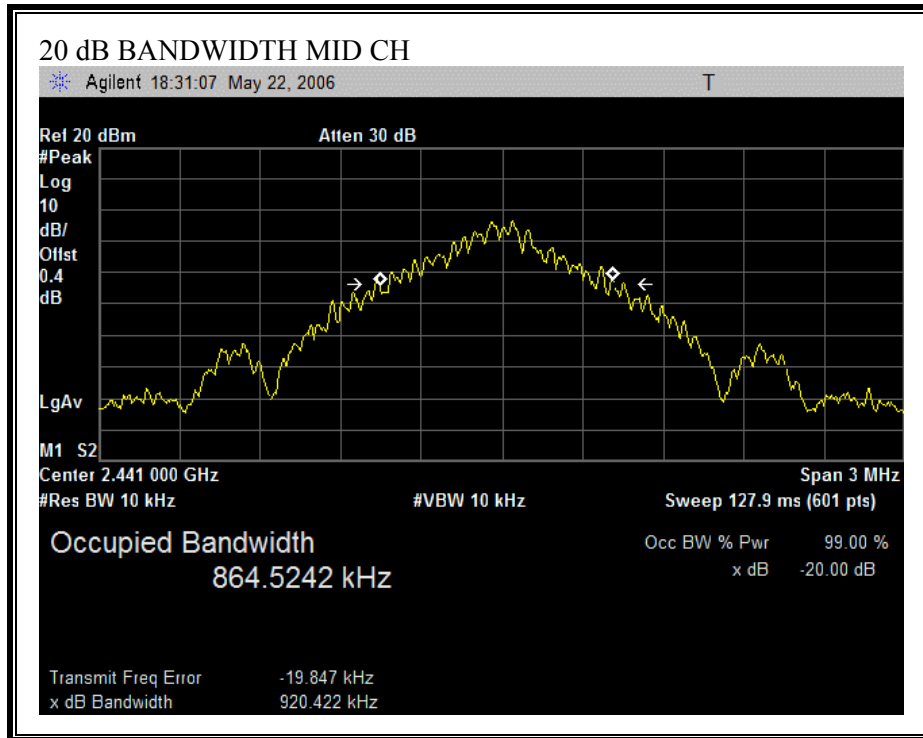

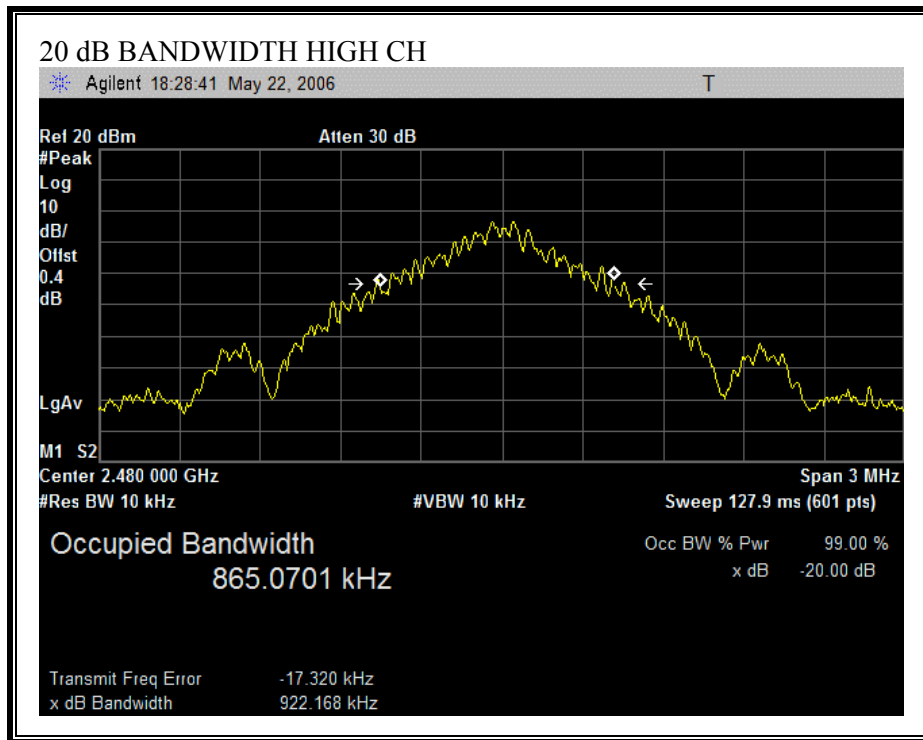

7.2.2. PEAK OUTPUT POWER

PEAK POWER LIMIT

§15.247 (b) The maximum peak output power of the intentional radiator shall not exceed the following:

§15.247 (b) (1) For frequency hopping systems operating in the 2400-2483.5 MHz band employing at least 75 hopping channels: 1 watt.

§15.247 (b) (4) Except as shown in paragraphs (b)(3) (i), (ii) and (iii) of this section, if transmitting antennas of directional gain greater than 6 dBi are used the peak output power from the intentional radiator shall be reduced below the stated values in paragraphs (b)(1) or (b)(2) of this section, as appropriate, by the amount in dB that the directional gain of the antenna exceeds 6 dBi.

The maximum antenna gain is 1.3 dBi, therefore the limit is 30 dBm.

TEST PROCEDURE

The transmitter output is connected to a spectrum analyzer and the analyzer bandwidth is set to a value greater than the 20 dB bandwidth of the EUT.

RESULTS

No non-compliance noted:

Channel	Frequency (MHz)	Peak Power (dBm)	Limit (dBm)	Margin (dB)
Low	2402	3.05	30	-26.95
Middle	2441	3.48	30	-26.52
High	2480	3.66	30	-26.34

OUTPUT POWER

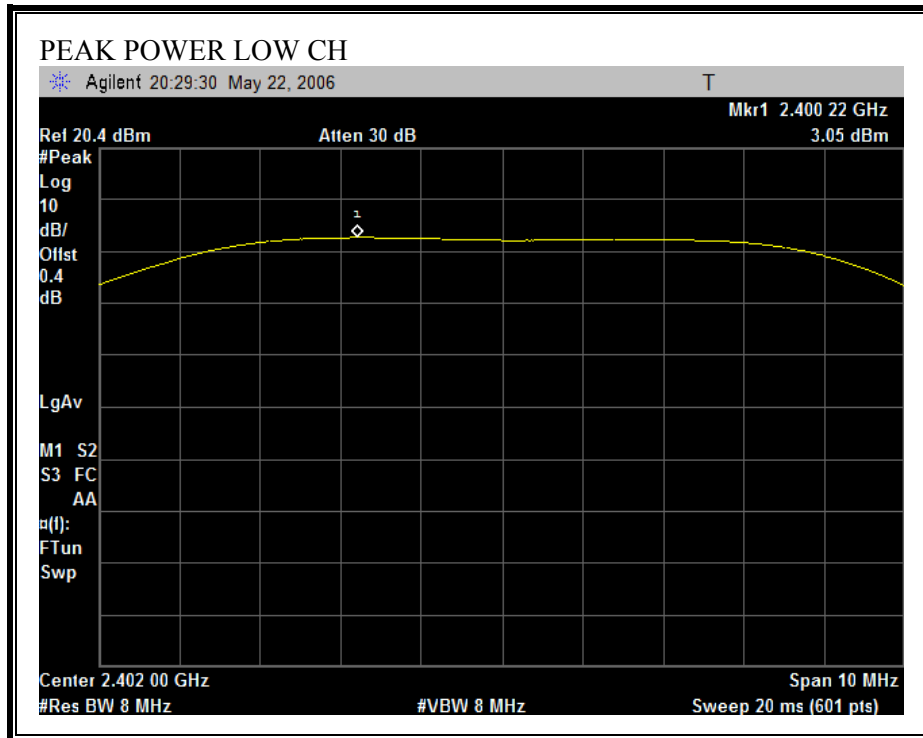

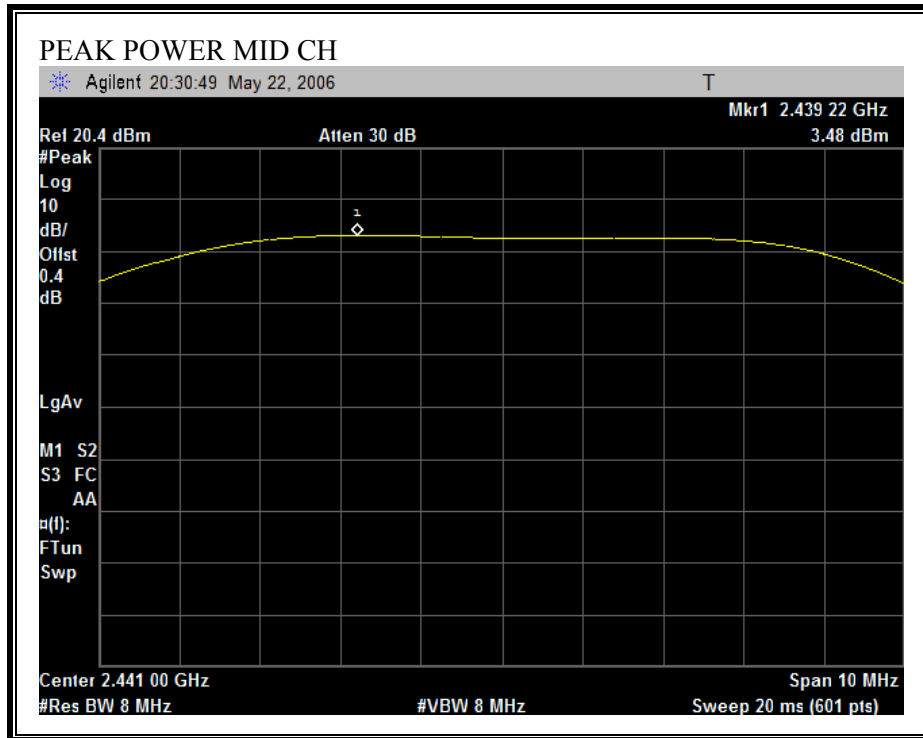

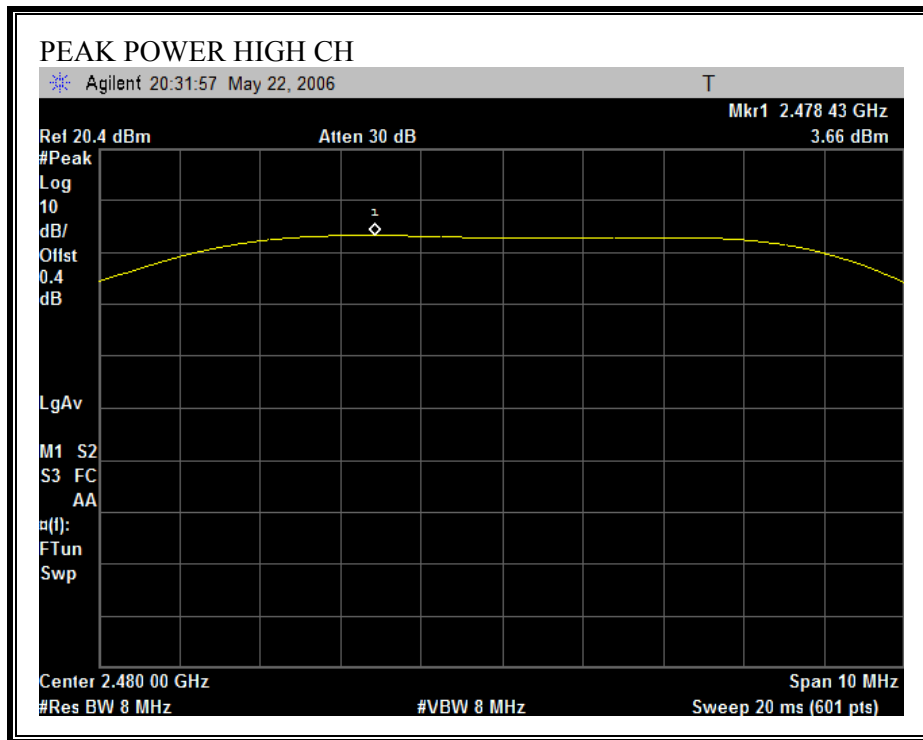

7.2.3. MAXIMUM PERMISSIBLE EXPOSURE

LIMITS

§1.1310 The criteria listed in Table 1 shall be used to evaluate the environmental impact of human exposure to radio-frequency (RF) radiation as specified in §1.1307(b), except in the case of portable devices which shall be evaluated according to the provisions of §2.1093 of this chapter.

TABLE 1—LIMITS FOR MAXIMUM PERMISSIBLE EXPOSURE (MPE)

Frequency range (MHz)	Electric field strength (V/m)	Magnetic field strength (A/m)	Power density (mW/cm ²)	Averaging time (minutes)
(A) Limits for Occupational/Controlled Exposures				
0.3–3.0	614	1.63	*(100)	6
3.0–30	1842/f	4.89/f	*(900/f ²)	6
30–300	61.4	0.163	1.0	6
300–1500	f/300	6
1500–100,000	5	6
(B) Limits for General Population/Uncontrolled Exposure				
0.3–1.34	614	1.63	*(100)	30
1.34–30	824/f	2.19/f	*(180/f ²)	30

TABLE 1—LIMITS FOR MAXIMUM PERMISSIBLE EXPOSURE (MPE)—Continued

Frequency range (MHz)	Electric field strength (V/m)	Magnetic field strength (A/m)	Power density (mW/cm ²)	Averaging time (minutes)
30–300	27.5	0.073	0.2	30
300–1500	f/1500	30
1500–100,000	1.0	30

f = frequency in MHz

* = Plane-wave equivalent power density

NOTE 1 TO TABLE 1: Occupational/controlled limits apply in situations in which persons are exposed as a consequence of their employment provided those persons are fully aware of the potential for exposure and can exercise control over their exposure. Limits for occupational/controlled exposure also apply in situations when an individual is transient through a location where occupational/controlled limits apply provided he or she is made aware of the potential for exposure.

NOTE 2 TO TABLE 1: General population/uncontrolled exposures apply in situations in which the general public may be exposed, or in which persons that are exposed as a consequence of their employment may not be fully aware of the potential for exposure or can not exercise control over their exposure.

CALCULATIONS

Given

$$E = \sqrt{(30 * P * G) / d}$$

and

$$S = E^2 / 3770$$

where

E = Field Strength in Volts/meter

P = Power in Watts

G = Numeric antenna gain

d = Distance in meters

S = Power Density in milliwatts/square centimeter

Combining equations and rearranging the terms to express the distance as a function of the remaining variables yields:

$$d = \sqrt{((30 * P * G) / (3770 * S))}$$

Changing to units of Power to mW and Distance to cm, using:

$$P \text{ (mW)} = P \text{ (W)} / 1000 \text{ and}$$

$$d \text{ (cm)} = 100 * d \text{ (m)}$$

yields

$$d = 100 * \sqrt{((30 * (P / 1000) * G) / (3770 * S))}$$

$$d = 0.282 * \sqrt{(P * G / S)}$$

where

d = distance in cm

P = Power in mW

G = Numeric antenna gain

S = Power Density in mW/cm²

Substituting the logarithmic form of power and gain using:

$$P \text{ (mW)} = 10^{(P \text{ (dBm)} / 10)} \text{ and}$$

$$G \text{ (numeric)} = 10^{(G \text{ (dBi)} / 10)}$$

yields

$$d = 0.282 * 10^{((P + G) / 20)} / \sqrt{S}$$

where

d = MPE distance in cm

P = Power in dBm

G = Antenna Gain in dBi

S = Power Density Limit in mW/cm²

Rearranging terms to calculate the power density at a specific distance yields

$$S = 0.0795 * 10^{((P + G) / 10)} / (d^2)$$

LIMITS

From §1.1310 Table 1 (B), the maximum value of $S = 1.0 \text{ mW/cm}^2$

RESULTS

MPE Distance (cm)	Output Power (dBm)	Antenna Gain (dBi)	Power Density (mW/cm²)
20.0	3.66	1.30	0.0006

NOTE: For mobile or fixed location transmitters, the minimum separation distance is 20 cm, even if calculations indicate that the MPE distance would be less.

7.2.4. AVERAGE POWER

AVERAGE POWER LIMIT

None; for reporting purposes only.

TEST PROCEDURE

The transmitter output is connected to a power meter.

RESULTS

No non-compliance noted:

The cable assembly insertion loss of 0.4 dB (including 0 dB pad and 0.4 dB cable) was entered as an offset in the power meter to allow for direct reading of power.

Channel	Frequency (MHz)	Average Power (dBm)
Low	2402	2.40
Middle	2441	2.85
High	2480	3.23

7.2.5. CONDUCTED SPURIOUS EMISSIONS

LIMITS

§15.247 (c) In any 100 kHz bandwidth outside the frequency band in which the spread spectrum intentional radiator is operating, the radio frequency power that is produced by the intentional radiator shall be at least 20 dB below that in the 100 kHz bandwidth within the band that contains the highest level of the desired power, based on either an RF conducted or a radiated measurement. Attenuation below the general limits specified in §15.209(a) is not required. In addition, radiated emissions which fall in the restricted bands, as defined in §15.205(a), must also comply with the radiated emission limits specified in §15.209(a) (see §15.205(c)).

TEST PROCEDURE

The transmitter output is connected to a spectrum analyzer. The resolution bandwidth is set to 100 kHz. The video bandwidth is set to 300 kHz.

The spectrum from 30 MHz to 26 GHz is investigated with the transmitter set to the lowest, middle, and highest channels.

RESULTS

No non-compliance noted:

SPURIOUS EMISSIONS, LOW CHANNEL

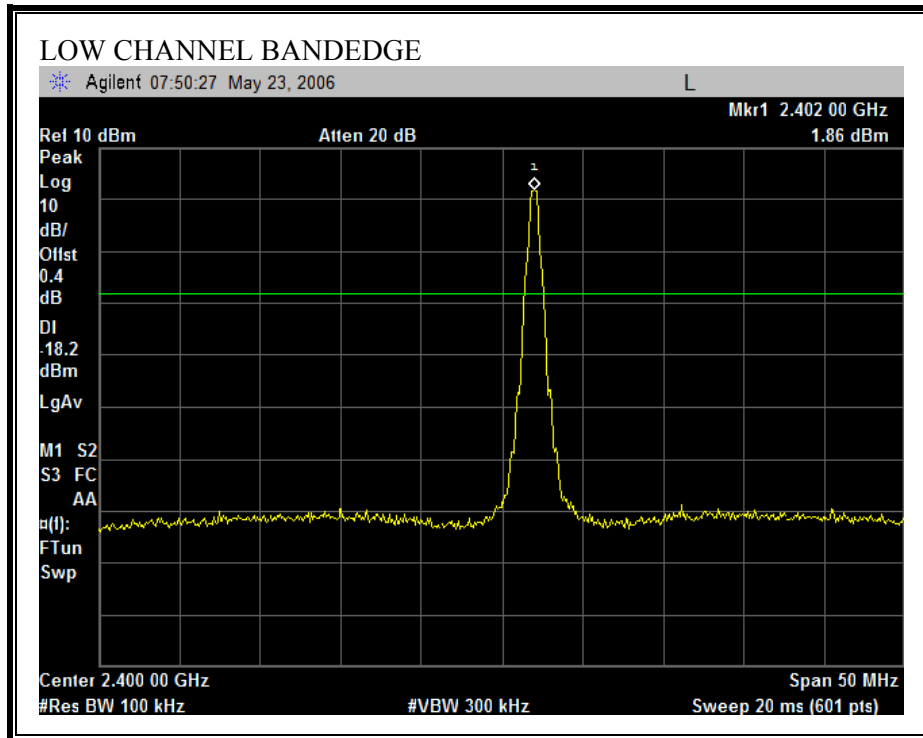

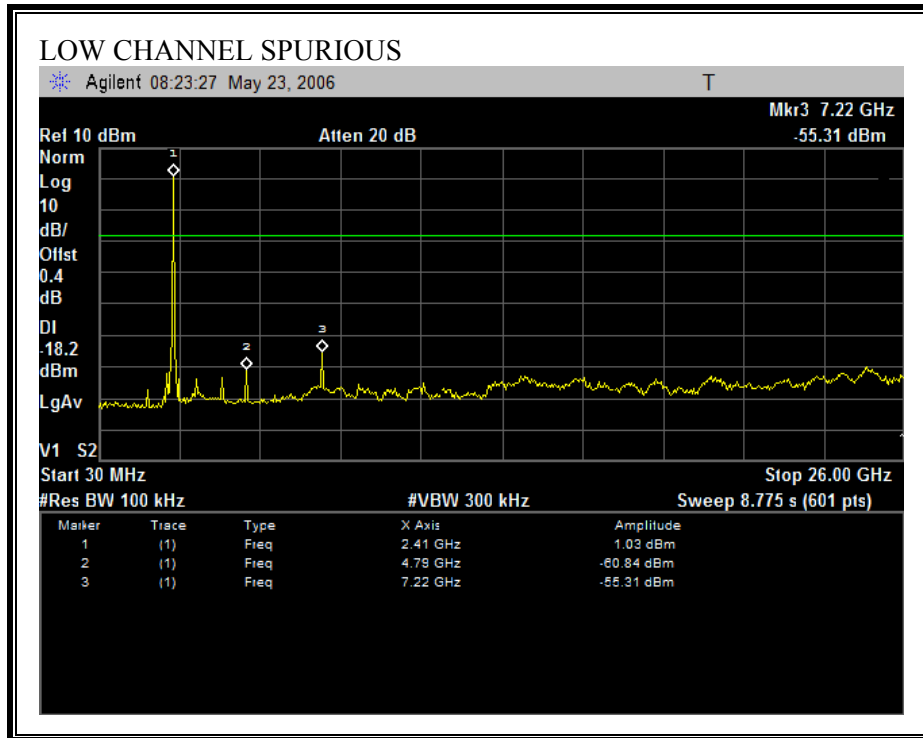

SPURIOUS EMISSIONS, MID CHANNEL

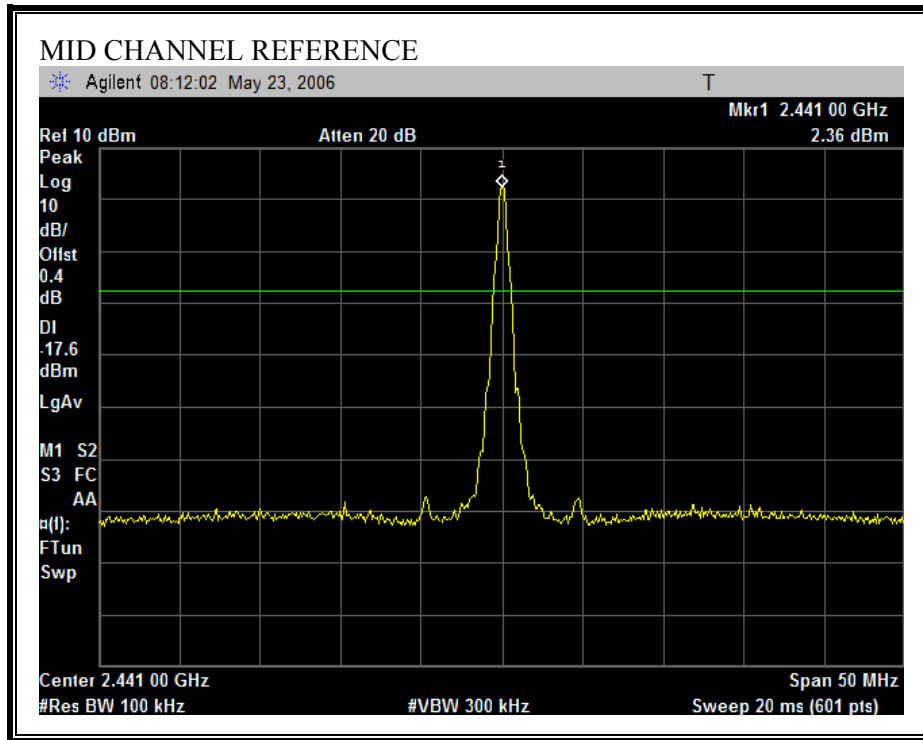

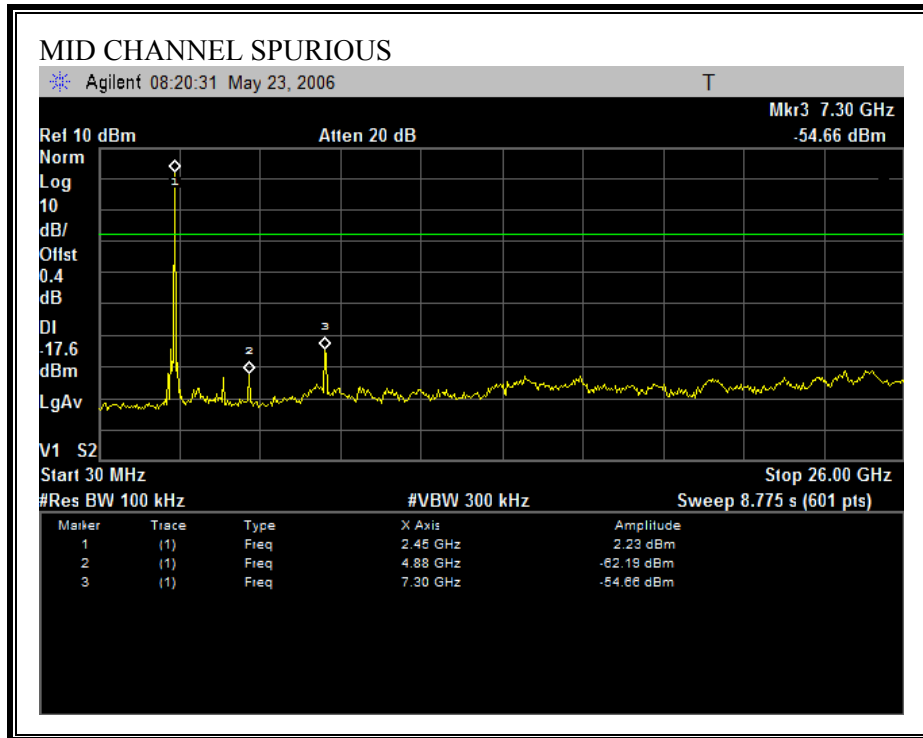

SPURIOUS EMISSIONS, HIGH CHANNEL

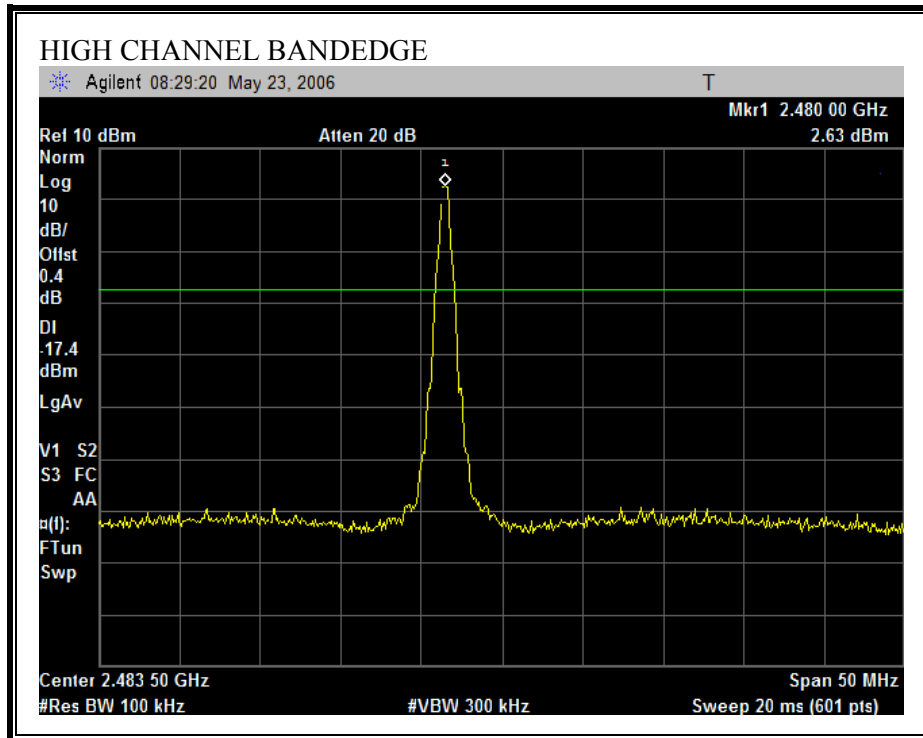

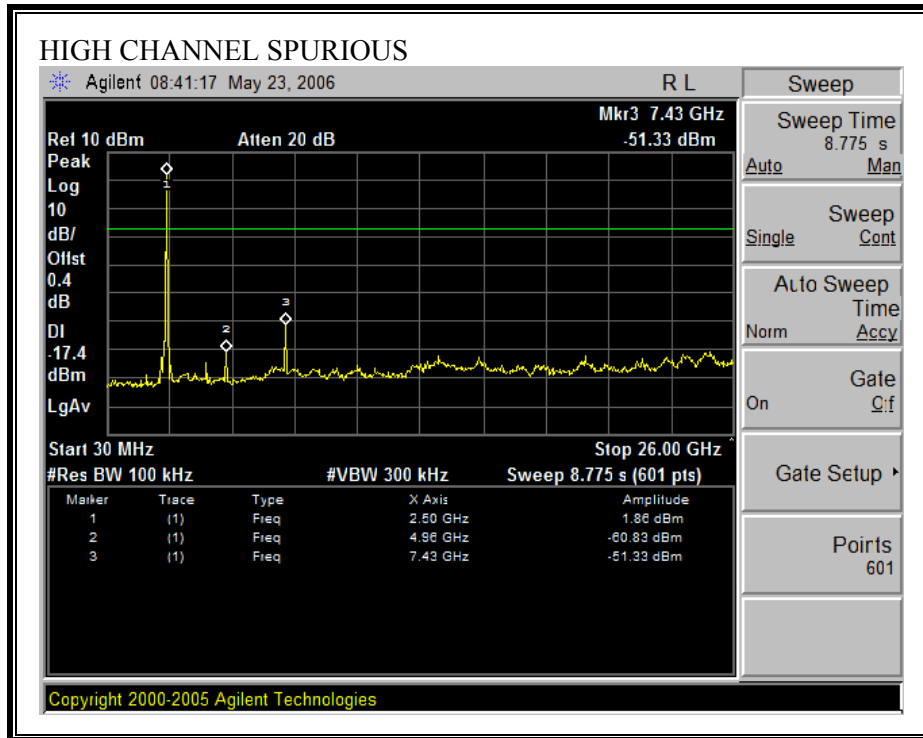

SPURIOUS BANDEDGE EMISSIONS WITH HOPPING ON

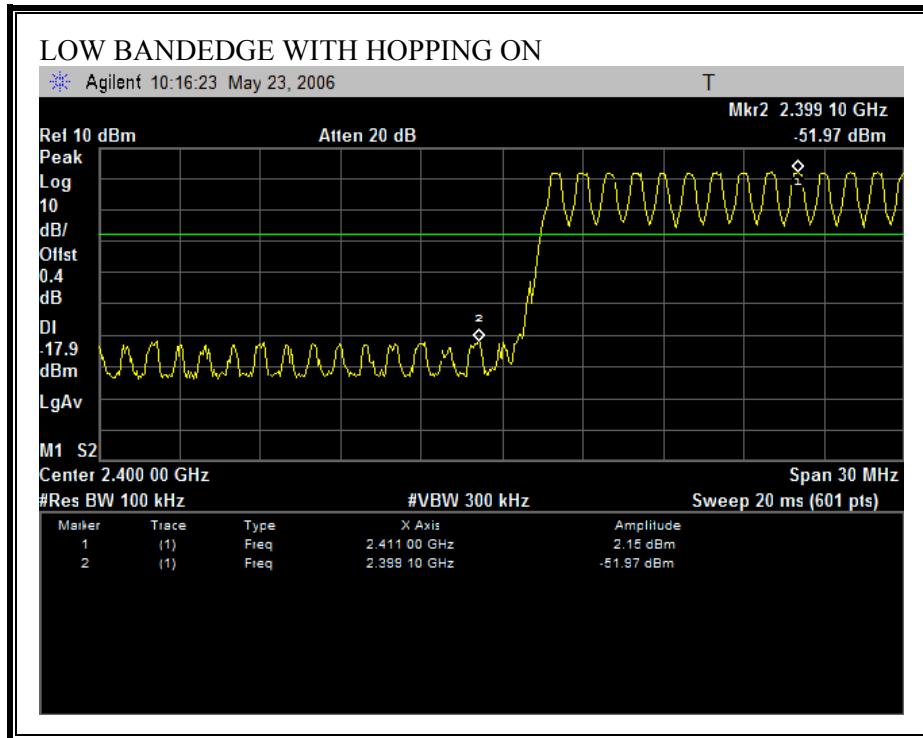

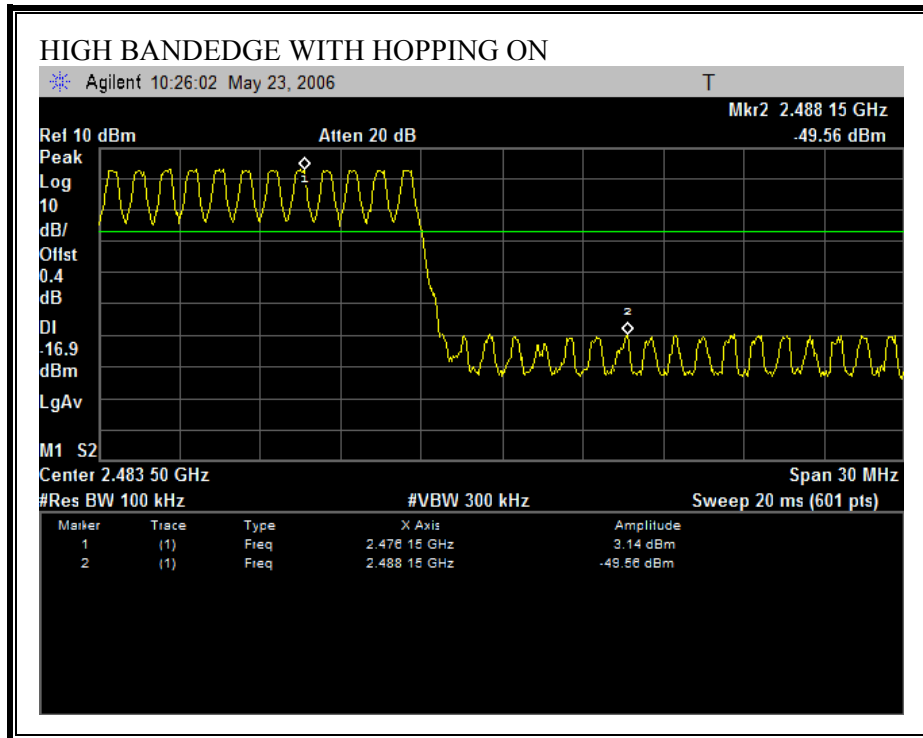

7.3. RADIATED EMISSIONS

7.3.1. TRANSMITTER RADIATED SPURIOUS EMISSIONS

LIMITS

§15.205 (a) Except as shown in paragraph (d) of this section, only spurious emissions are permitted in any of the frequency bands listed below:

MHz	MHz	MHz	GHz
0.090 - 0.110	16.42 - 16.423	399.9 - 410	4.5 - 5.15
¹ 0.495 - 0.505	16.69475 - 16.69525	608 - 614	5.35 - 5.46
2.1735 - 2.1905	16.80425 - 16.80475	960 - 1240	7.25 - 7.75
4.125 - 4.128	25.5 - 25.67	1300 - 1427	8.025 - 8.5
4.17725 - 4.17775	37.5 - 38.25	1435 - 1626.5	9.0 - 9.2
4.20725 - 4.20775	73 - 74.6	1645.5 - 1646.5	9.3 - 9.5
6.215 - 6.218	74.8 - 75.2	1660 - 1710	10.6 - 12.7
6.26775 - 6.26825	108 - 121.94	1718.8 - 1722.2	13.25 - 13.4
6.31175 - 6.31225	123 - 138	2200 - 2300	14.47 - 14.5
8.291 - 8.294	149.9 - 150.05	2310 - 2390	15.35 - 16.2
8.362 - 8.366	156.52475 - 156.52525	2483.5 - 2500	17.7 - 21.4
8.37625 - 8.38675	156.7 - 156.9	2655 - 2900	22.01 - 23.12
8.41425 - 8.41475	162.0125 - 167.17	3260 - 3267	23.6 - 24.0
12.29 - 12.293	167.72 - 173.2	3332 - 3339	31.2 - 31.8
12.51975 - 12.52025	240 - 285	3345.8 - 3358	36.43 - 36.5
12.57675 - 12.57725	322 - 335.4	3600 - 4400	(²)
13.36 - 13.41			

¹ Until February 1, 1999, this restricted band shall be 0.490-0.510 MHz.

² Above 38.6

§15.205 (b) Except as provided in paragraphs (d) and (e), the field strength of emissions appearing within these frequency bands shall not exceed the limits shown in Section 15.209. At frequencies equal to or less than 1000 MHz, compliance with the limits in Section 15.209 shall be demonstrated using measurement instrumentation employing a CISPR quasi-peak detector. Above 1000 MHz, compliance with the emission limits in Section 15.209 shall be demonstrated based on the average value of the measured emissions. The provisions in Section 15.35 apply to these measurements.

§15.209 (a) Except as provided elsewhere in this Subpart, the emissions from an intentional radiator shall not exceed the field strength levels specified in the following table:

Frequency (MHz)	Field Strength (microvolts/meter)	Measurement Distance (meters)
30 - 88	100 **	3
88 - 216	150 **	3
216 - 960	200 **	3
Above 960	500	3

** Except as provided in paragraph (g), fundamental emissions from intentional radiators operating under this Section shall not be located in the frequency bands 54-72 MHz, 76-88 MHz, 174-216 MHz or 470-806 MHz. However, operation within these frequency bands is permitted under other sections of this Part, e.g., Sections 15.231 and 15.241.

§15.209 (b) In the emission table above, the tighter limit applies at the band edges.

TEST PROCEDURE

The EUT is placed on a non-conducting table 80 cm above the ground plane. The antenna to EUT distance is 3 meters. The EUT is configured in accordance with ANSI C63.4. The EUT is set to transmit in a continuous mode.

For measurements below 1 GHz the resolution bandwidth is set to 100 kHz for peak detection measurements or 120 kHz for quasi-peak detection measurements. Peak detection is used unless otherwise noted as quasi-peak.

For measurements above 1 GHz the resolution bandwidth is set to 1 MHz, then the video bandwidth is set to 1 MHz for peak measurements and 10 Hz for average measurements.

The spectrum from 30 MHz to 26 GHz is investigated with the transmitter set to the lowest, middle, and highest channels in the 2.4 GHz band.

The spectrum from 30 MHz to 40 GHz is investigated with the transmitter set to the lowest, middle, and highest channels in each 5 GHz band.

The frequency range of interest is monitored at a fixed antenna height and EUT azimuth. The EUT is rotated through 360 degrees to maximize emissions received. The antenna is scanned from 1 to 4 meters above the ground plane to further maximize the emission. Measurements are made with the antenna polarized in both the vertical and the horizontal positions.

7.3.2. TRANSMITTER RADIATED EMISSIONS ABOVE 1 GHZ WITH 8PSK MODULATION

RESTRICTED BANDEDGE (LOW CHANNEL, HORIZONTAL)

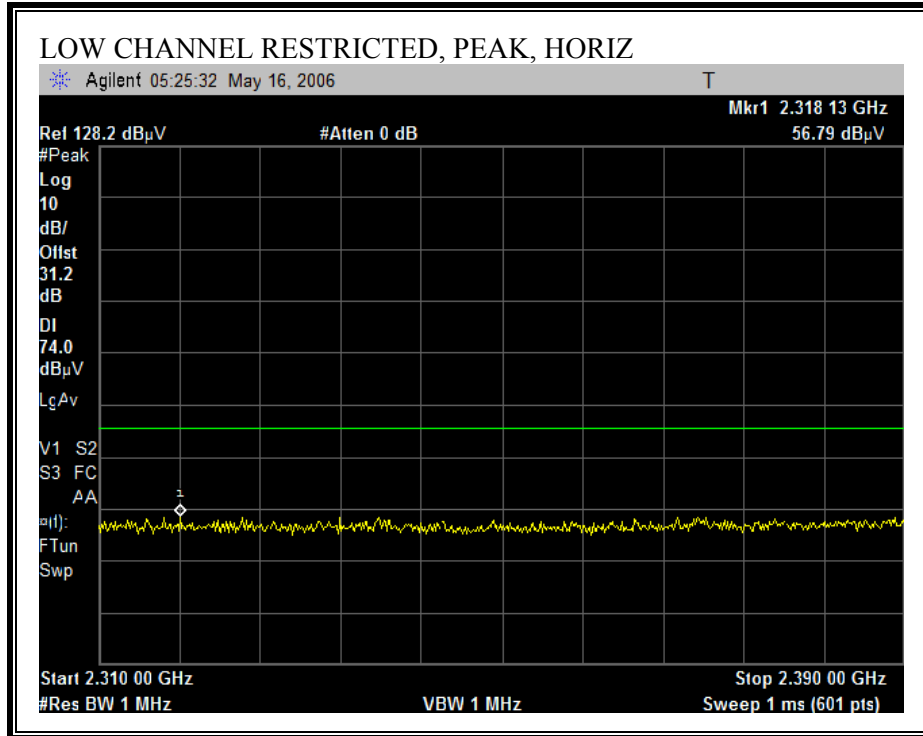

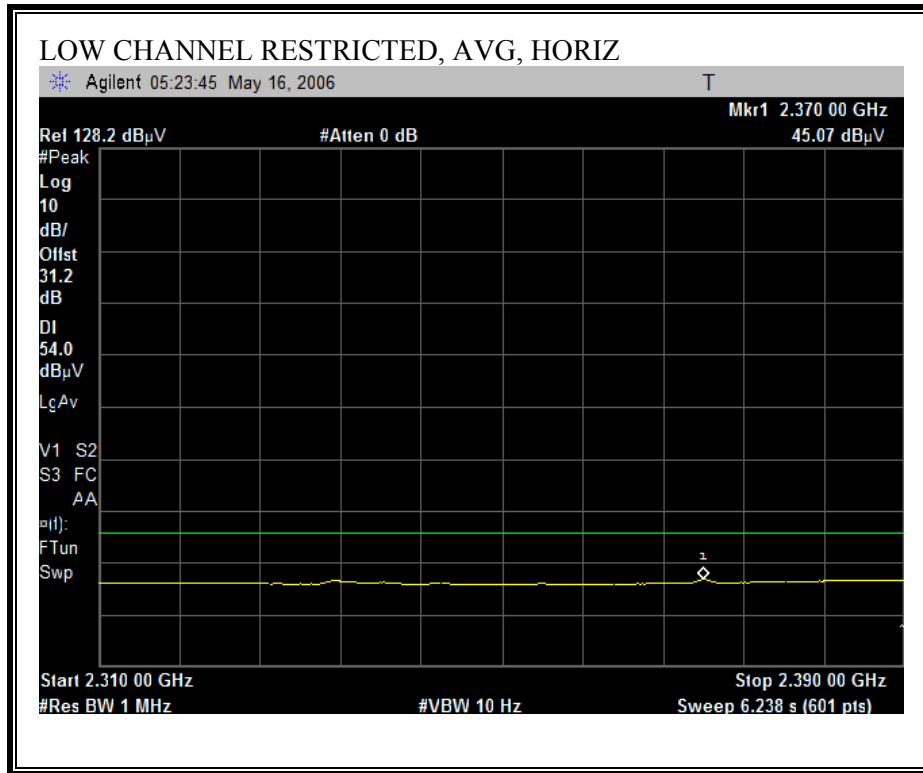

RESTRICTED BANDEDGE (LOW CHANNEL, VERTICAL)

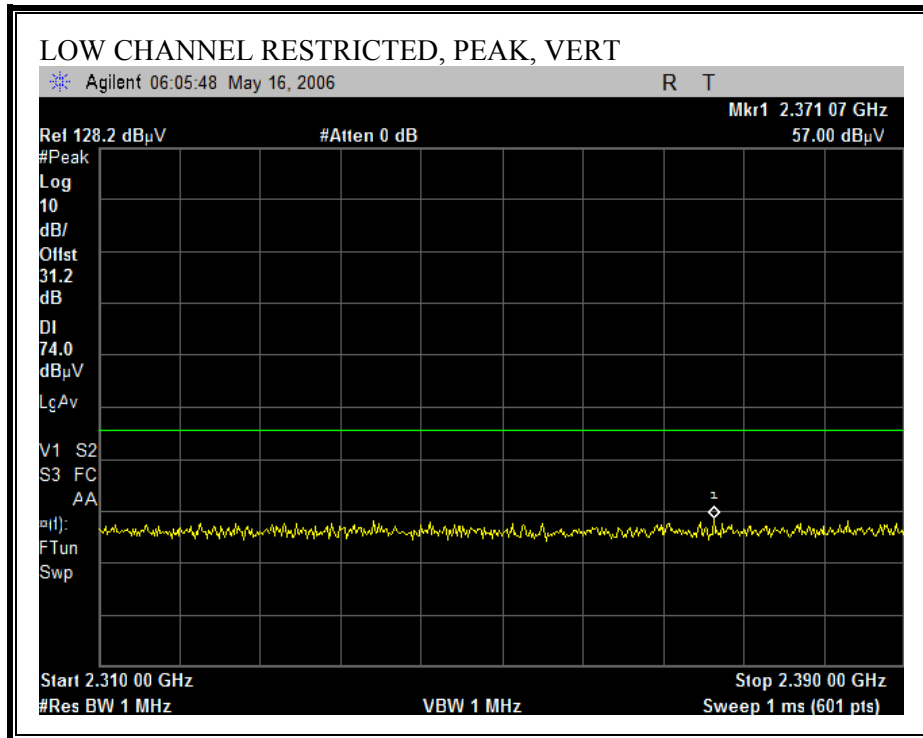

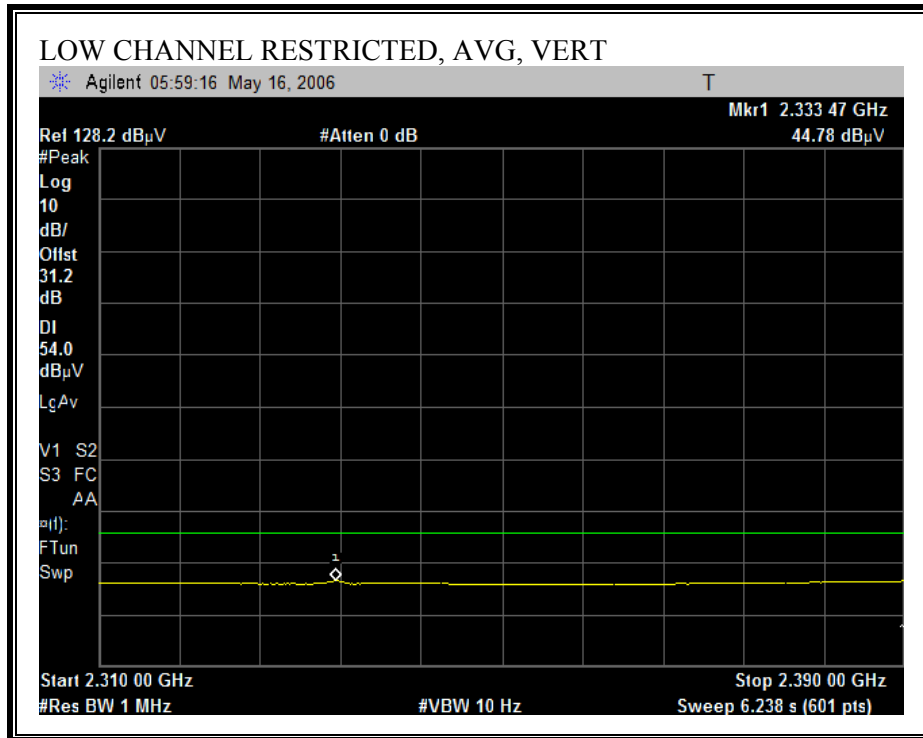

RESTRICTED BANDEDGE (HIGH CHANNEL, HORIZONTAL)

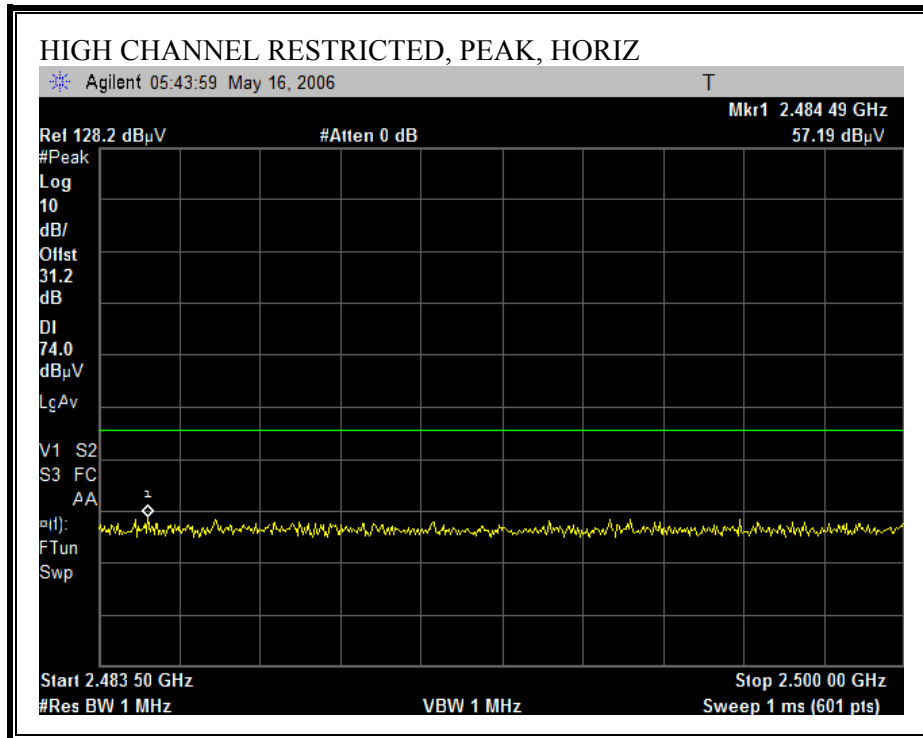

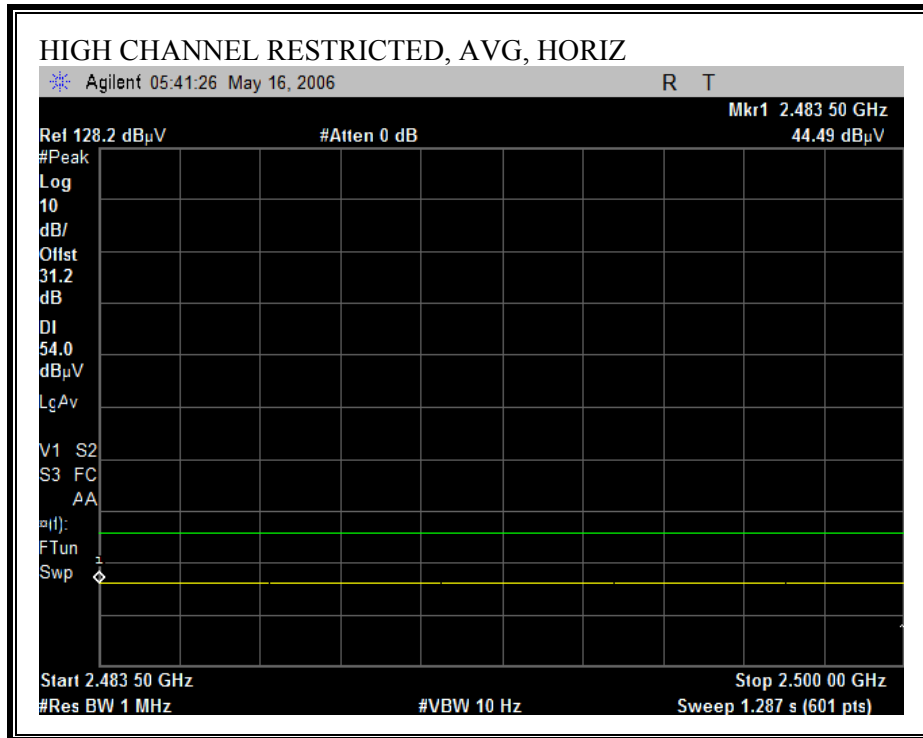

RESTRICTED BANDEDGE (HIGH CHANNEL, VERTICAL)

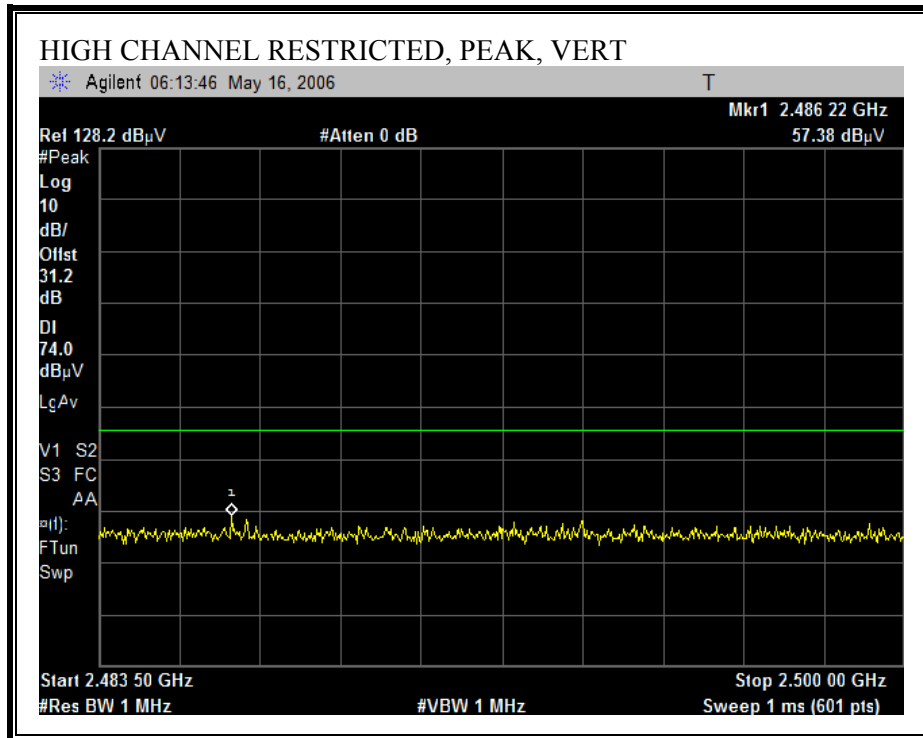

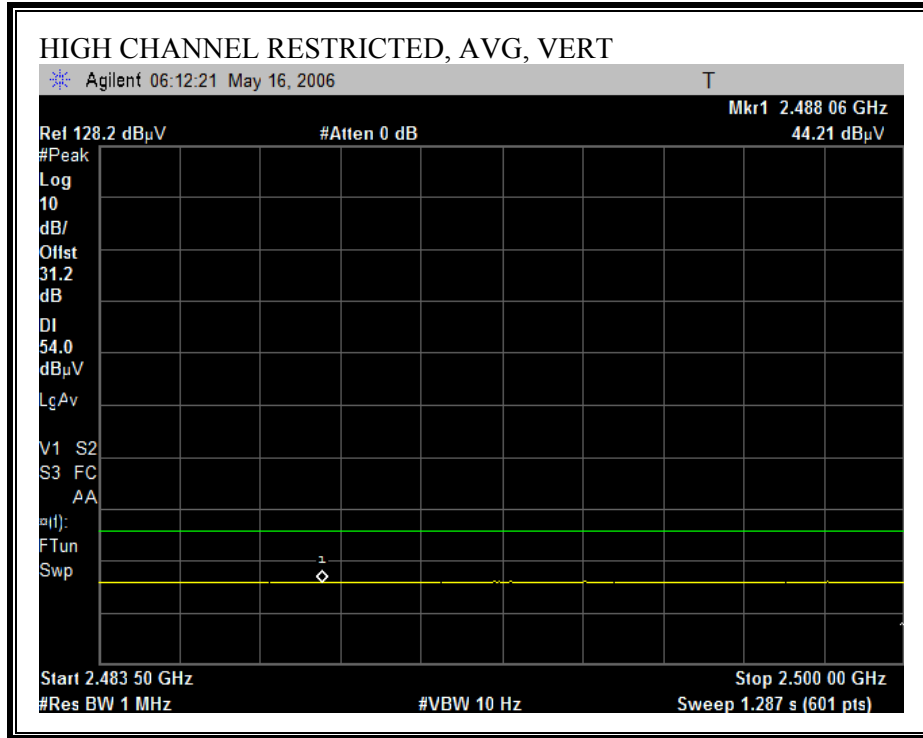

HARMONICS AND SPURIOUS EMISSIONS –8PSK MODULATIONS

High Frequency Measurement
 Compliance Certification Services, Morgan Hill Open Field Site

Company: Mitsumi
 Project #: 06J10249
 Date: May 16, 2006
 Test Engineer: Sunny Shih
 Configuration: Tx worst-case
 Mode: 8PSK

Test Equipment:

Horn 1-18GHz	Pre-amplifier 1-26GHz	Pre-amplifier 26-40GHz	Horn > 18GHz	Limit
T73; S/N: 6717 @3m	T144 Miteq 3008A00931			FCC 15.205

Hi Frequency Cables

2 foot cable	3 foot cable	12 foot cable	HPF	Reject Filter	Peak Measurements RBW=VBW=1MHz
	Sunny 187215005	Sunny 197539001	HPF_4.0GHz		Average Measurements RBW=1MHz ; VBW=10Hz

f GHz	Dist (m)	Read Pk dBuV	Read Avg. dBuV	AF dB/m	CL dB	Amp dB	D Corr dB	Filtr dB	Peak dBuV/m	Avg dBuV/m	Pk Lim dBuV/m	Avg Lim dBuV/m	Pk Mar dB	Avg Mar dB	Notes (V/H)
8PSK - Low channel (2402 MHz)															
4.804	3.0	44.0	32.0	33.3	3.6	-36.5	0.0	0.6	45.0	33.0	74	54	-29.0	-21.0	V
4.804	3.0	46.0	33.0	33.3	3.6	-36.5	0.0	0.6	47.0	34.0	74	54	-27.0	-20.0	H
8PSK - Middle channel (2441 MHz)															
4.882	3.0	40.0	31.0	33.4	3.6	-36.5	0.0	0.6	41.1	32.1	74	54	-32.9	-21.9	V
7.323	3.0	48.0	37.0	35.0	4.3	-36.2	0.0	0.6	51.7	40.7	74	54	-22.3	-13.3	V
4.882	3.0	45.0	32.0	33.4	3.6	-36.5	0.0	0.6	46.1	33.1	74	54	-27.9	-20.9	H
7.323	3.0	53.0	43.0	35.0	4.3	-36.2	0.0	0.6	56.7	46.7	74	54	-17.3	-7.3	H
8PSK - High channel (2480 MHz)															
4.960	3.0	43.2	31.2	33.4	3.6	-36.5	0.0	0.6	44.5	32.5	74	54	-29.5	-21.5	V
7.440	3.0	48.4	38.0	35.1	4.4	-36.2	0.0	0.6	52.2	41.8	74	54	-21.8	-12.2	V
4.960	3.0	43.5	31.3	33.4	3.6	-36.5	0.0	0.6	44.8	32.6	74	54	-29.2	-21.4	H
7.440	3.0	52.0	42.0	35.1	4.4	-36.2	0.0	0.6	55.8	45.8	74	54	-18.2	-8.2	H

f	Measurement Frequency	Amp	Preamp Gain	Avg Lim	Average Field Strength Limit
Dist	Distance to Antenna	D Corr	Distance Correct to 3 meters	Pk Lim	Peak Field Strength Limit
Read	Analyzer Reading	Avg	Average Field Strength @ 3 m	Avg Mar	Margin vs. Average Limit
AF	Antenna Factor	Peak	Calculated Peak Field Strength	Pk Mar	Margin vs. Peak Limit
CL	Cable Loss	HPF	High Pass Filter		

7.3.3. TRANSMITTER RADIATED EMISSIONS ABOVE 1 GHZ WITH GFSK MODULATION

RESTRICTED BANDEDGE (LOW CHANNEL, HORIZONTAL)

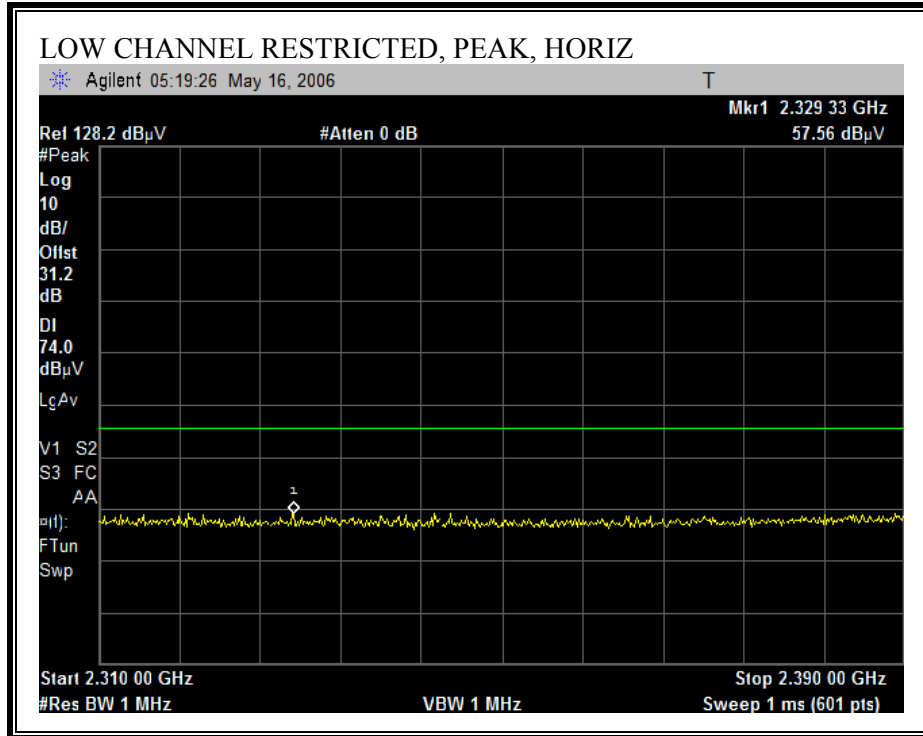

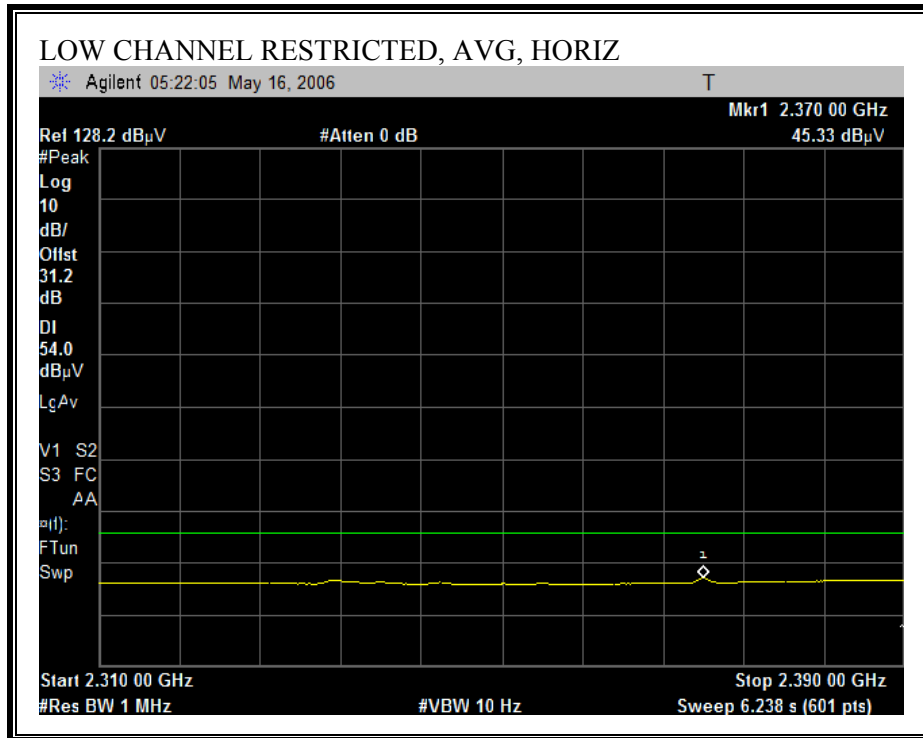

RESTRICTED BANDEDGE (LOW CHANNEL, VERTICAL)

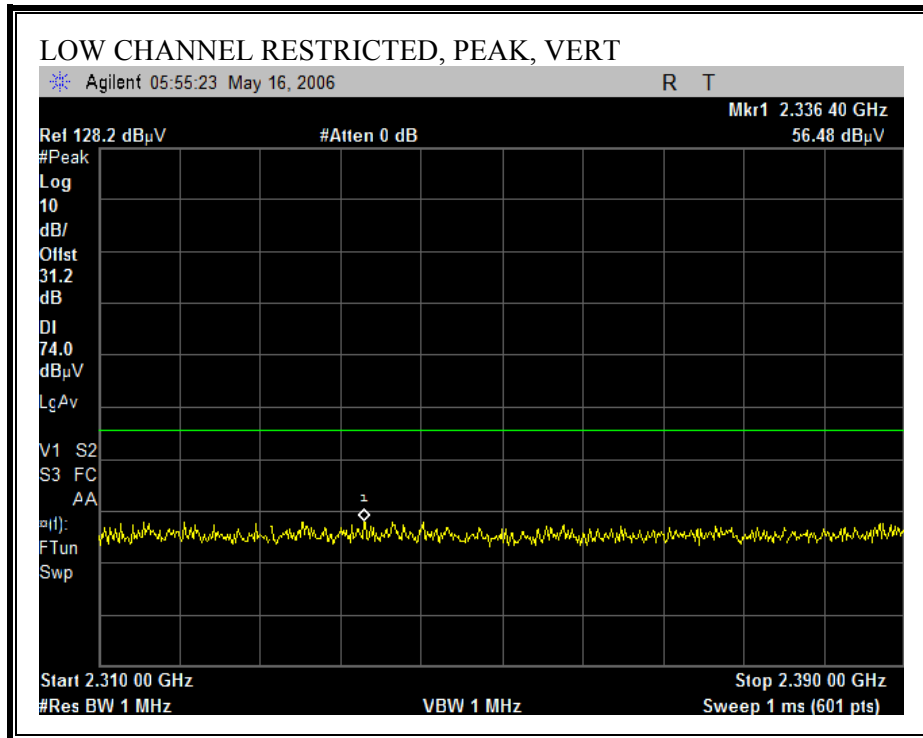

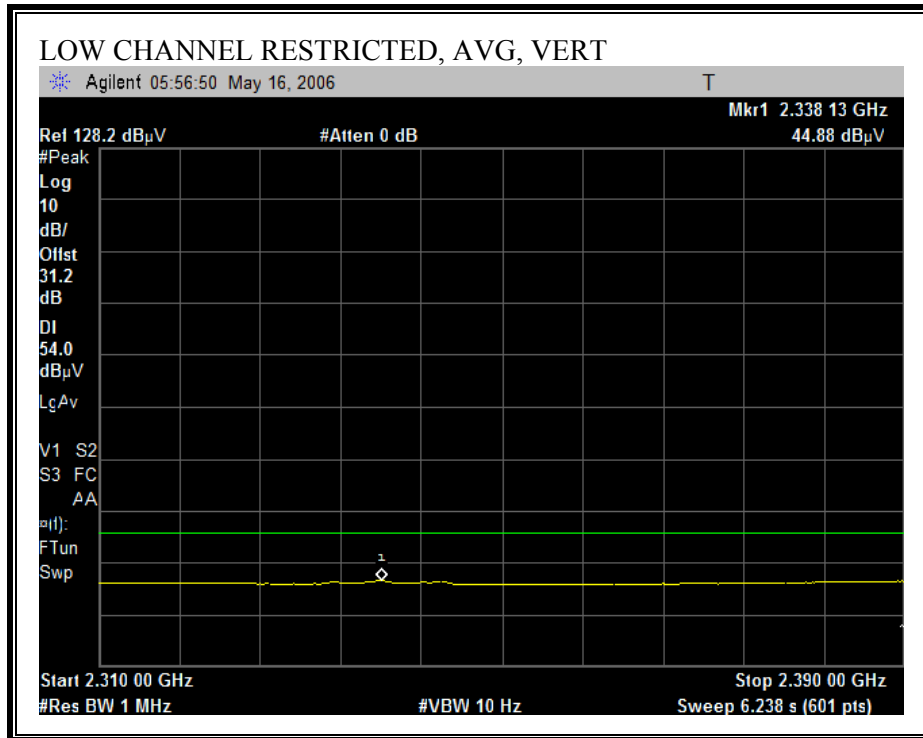

RESTRICTED BANDEDGE (HIGH CHANNEL, HORIZONTAL)

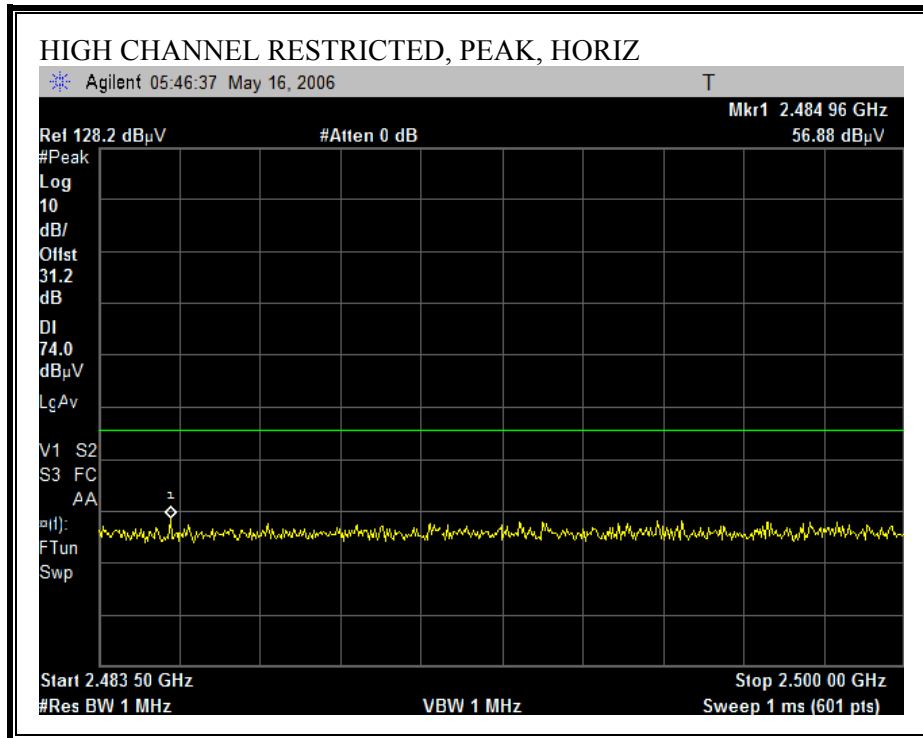

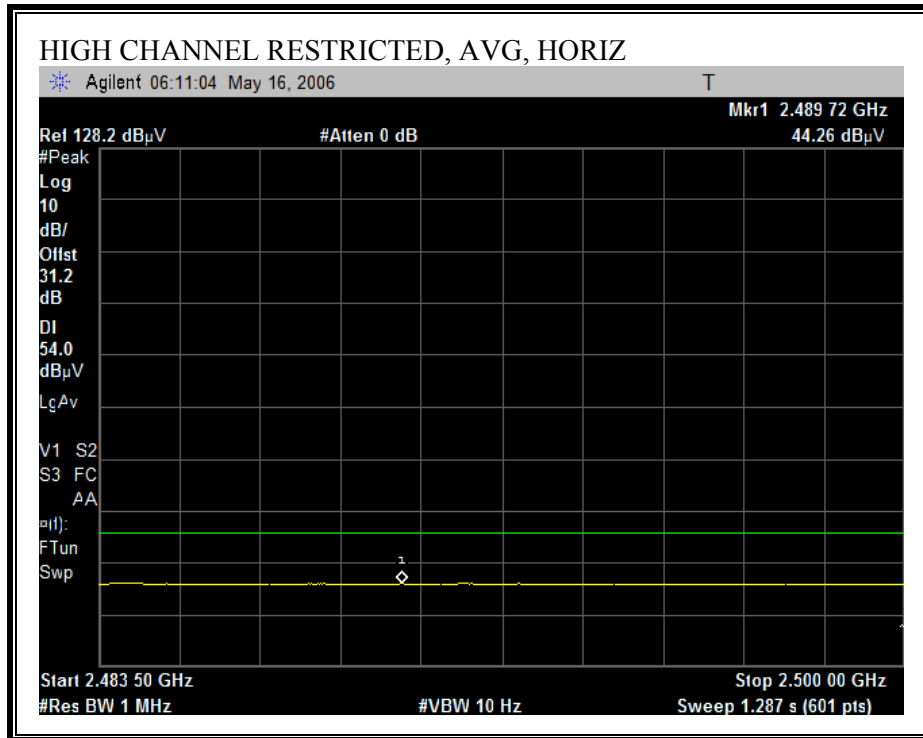

RESTRICTED BANDEDGE (HIGH CHANNEL, VERTICAL)

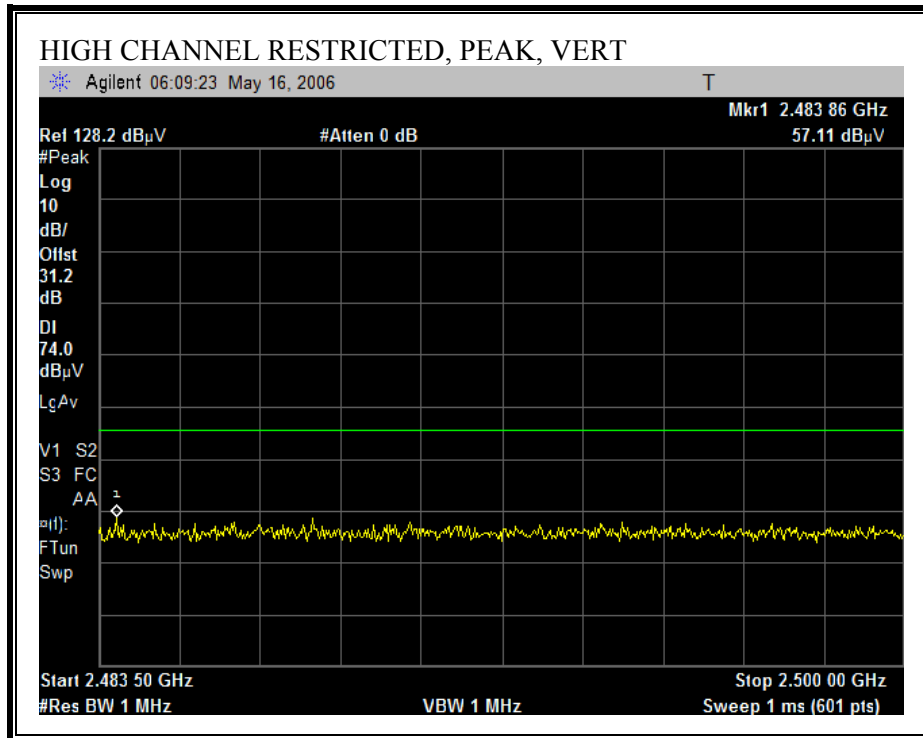

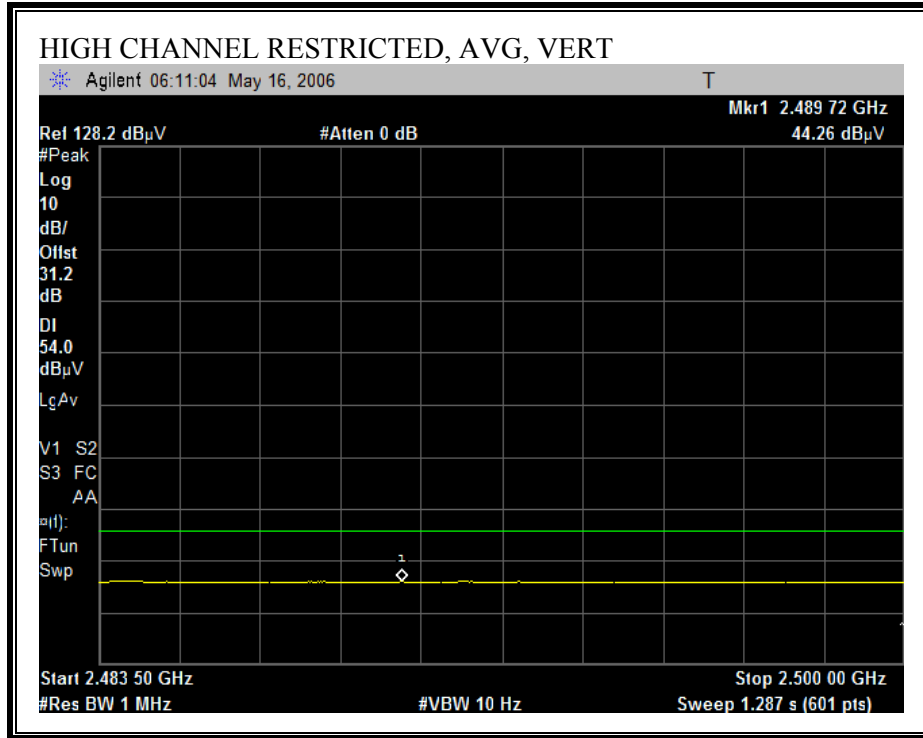

HARMONICS AND SPURIOUS EMISSIONS – WORST –CASE DATA OF GFSK MODULATION

High Frequency Measurement
 Compliance Certification Services, Morgan Hill Open Field Site

Company: Mitsumi
 Project #: 06J10249
 Date: May 16, 2006
 Test Engineer: Sunny Shih
 Configuration: Tx worst-case
 Mode: Both GFSK

Test Equipment:

Horn 1-18GHz	Pre-amplifer 1-26GHz	Pre-amplifer 26-40GHz	Horn > 18GHz	Limit
T73; S/N: 6717 @3m	T144 Miteq 3008A00931			FCC 15.205

Hi Frequency Cables

2 foot cable	3 foot cable	12 foot cable	HPF	Reject Filter	Peak Measurements RBW=VBW=1MHz
	Sunny 187215005	Sunny 197539001	HPF_4.0GHz		Average Measurements RBW=1MHz ; VBW=10Hz

f GHz	Dist (m)	Read Pk dBuV	Read Avg. dBuV	AF dB/m	CL dB	Amp dB	D Corr dB	Ftr dB	Peak dBuV/m	Avg dBuV/m	Pk Lim dBuV/m	Avg Lim dBuV/m	Pk Mar dB	Avg Mar dB	Notes (V/H)
GFSK - Low channel (2402 MHz)															
4.804	3.0	43.0	33.0	33.3	3.6	-36.5	0.0	0.6	44.0	34.0	74	54	-30.0	-20.0	V
4.804	3.0	42.0	32.0	33.3	3.6	-36.5	0.0	0.6	43.0	33.0	74	54	-31.0	-21.0	H
GFSK - Middle channel (2441 MHz)															
4.882	3.0	41.0	31.0	33.4	3.6	-36.5	0.0	0.6	42.1	32.1	74	54	-31.9	-21.9	V
7.323	3.0	47.0	34.0	35.0	4.3	-36.2	0.0	0.6	50.7	37.7	74	54	-23.3	-16.3	V
4.882	3.0	44.5	32.0	33.4	3.6	-36.5	0.0	0.6	45.6	33.1	74	54	-28.4	-20.9	H
7.323	3.0	49.6	44.0	35.0	4.3	-36.2	0.0	0.6	53.3	47.7	74	54	-20.7	-6.3	H
GFSK - High channel (2480 MHz)															
4.960	3.0	42.5	31.2	33.4	3.6	-36.5	0.0	0.6	43.8	32.4	74	54	-30.2	-21.6	V
7.440	3.0	46.3	37.4	35.1	4.4	-36.2	0.0	0.6	50.1	41.2	74	54	-23.9	-12.8	V
4.960	3.0	43.0	31.3	33.4	3.6	-36.5	0.0	0.6	44.3	32.6	74	54	-29.7	-21.4	H
7.440	3.0	49.0	42.5	35.1	4.4	-36.2	0.0	0.6	52.8	46.3	74	54	-21.2	-7.7	H

f	Measurement Frequency	Amp	Preamp Gain	Avg Lim	Average Field Strength Limit
Dist	Distance to Antenna	D Corr	Distance Correct to 3 meters	Pk Lim	Peak Field Strength Limit
Read	Analyzer Reading	Avg	Average Field Strength @ 3 m	Avg Mar	Margin vs. Average Limit
AF	Antenna Factor	Peak	Calculated Peak Field Strength	Pk Mar	Margin vs. Peak Limit
CL	Cable Loss	HPF	High Pass Filter		

7.3.4. WORST-CASE RADIATED EMISSIONS BELOW 1 GHz WITH 8PSK MODULATION

SPURIOUS EMISSIONS 30 TO 1000 MHz (WORST-CASE CONFIGURATION, HORIZONTAL)

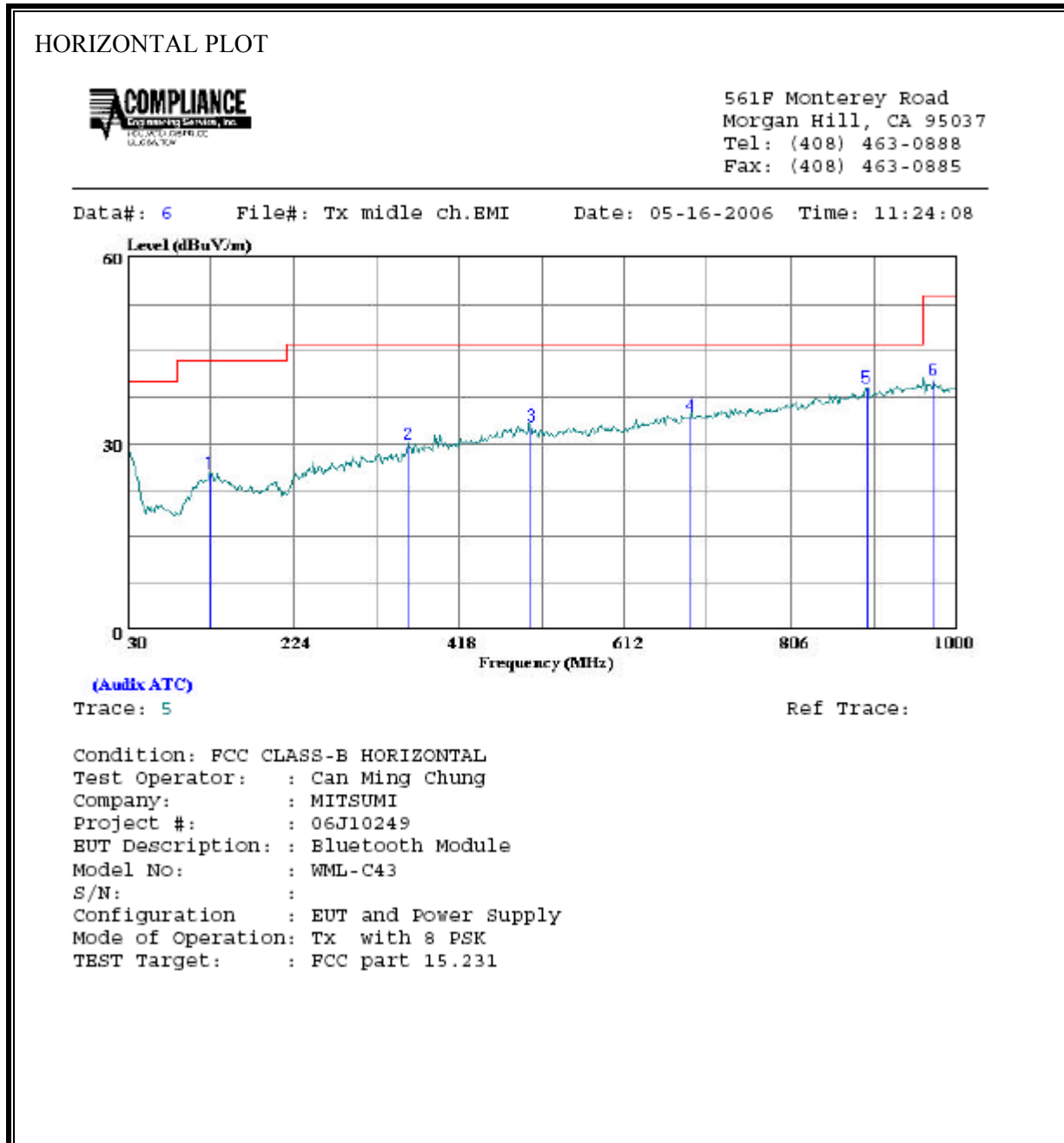

HORIZONTAL DATA

	Freq	Read Level	Factor	Level	Limit Line	Over Limit	Remark
	MHz	dBuV	dB	dBuV/m	dBuV/m	dB	
1	127.000	9.98	15.22	25.21	43.50	-18.29	Peak
2	359.800	12.82	17.14	29.96	46.00	-16.04	Peak
3	502.390	12.60	20.24	32.84	46.00	-13.16	Peak
4	689.600	11.59	22.90	34.49	46.00	-11.51	Peak
5	894.270	13.17	25.87	39.04	46.00	-6.96	Peak
6	972.840	13.64	26.69	40.33	54.00	-13.68	Peak

SPURIOUS EMISSIONS 30 TO 1000 MHz (WORST-CASE CONFIGURATION, VERTICAL)

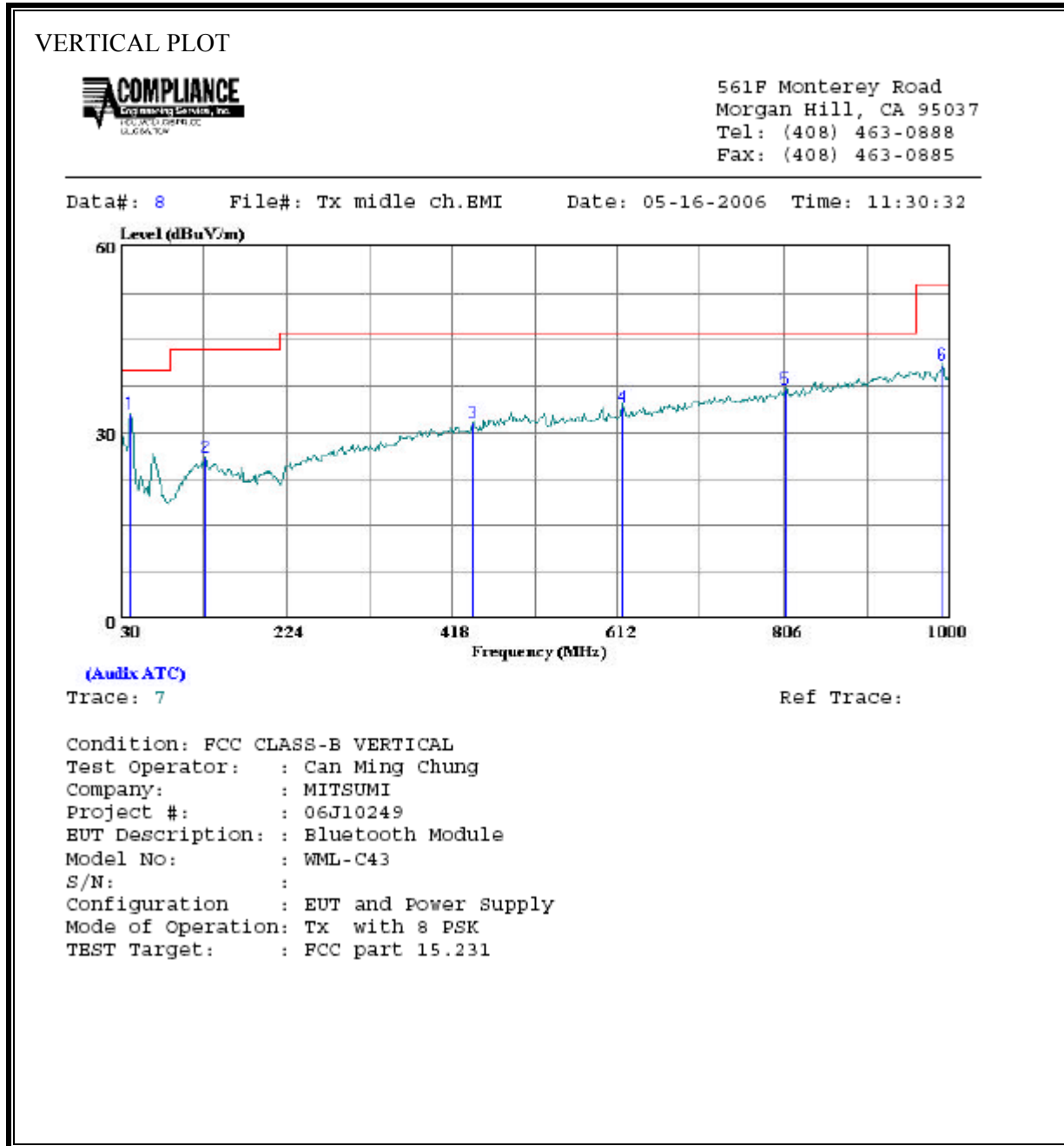

VERTICAL DATA

	Freq	Read Level	Factor	Level	Limit Line	Over Limit	Remark
	MHz	dBuV	dB	dBuV/m	dBuV/m	dB	
1	41.640	18.16	14.90	33.06	40.00	-6.94	Peak
2	128.940	10.91	15.15	26.06	43.50	-17.44	Peak
3	442.250	12.50	19.02	31.53	46.00	-14.47	Peak
4	617.820	12.14	21.84	33.98	46.00	-12.02	Peak
5	806.970	12.26	24.66	36.92	46.00	-9.08	Peak
6	991.270	14.07	26.90	40.97	54.00	-13.03	Peak

7.3.5. WORST-CASE RADIATED EMISSIONS BELOW 1 GHz WITH GFSK MODULATION

SPURIOUS EMISSIONS 30 TO 1000 MHz (WORST-CASE CONFIGURATION, HORIZONTAL)

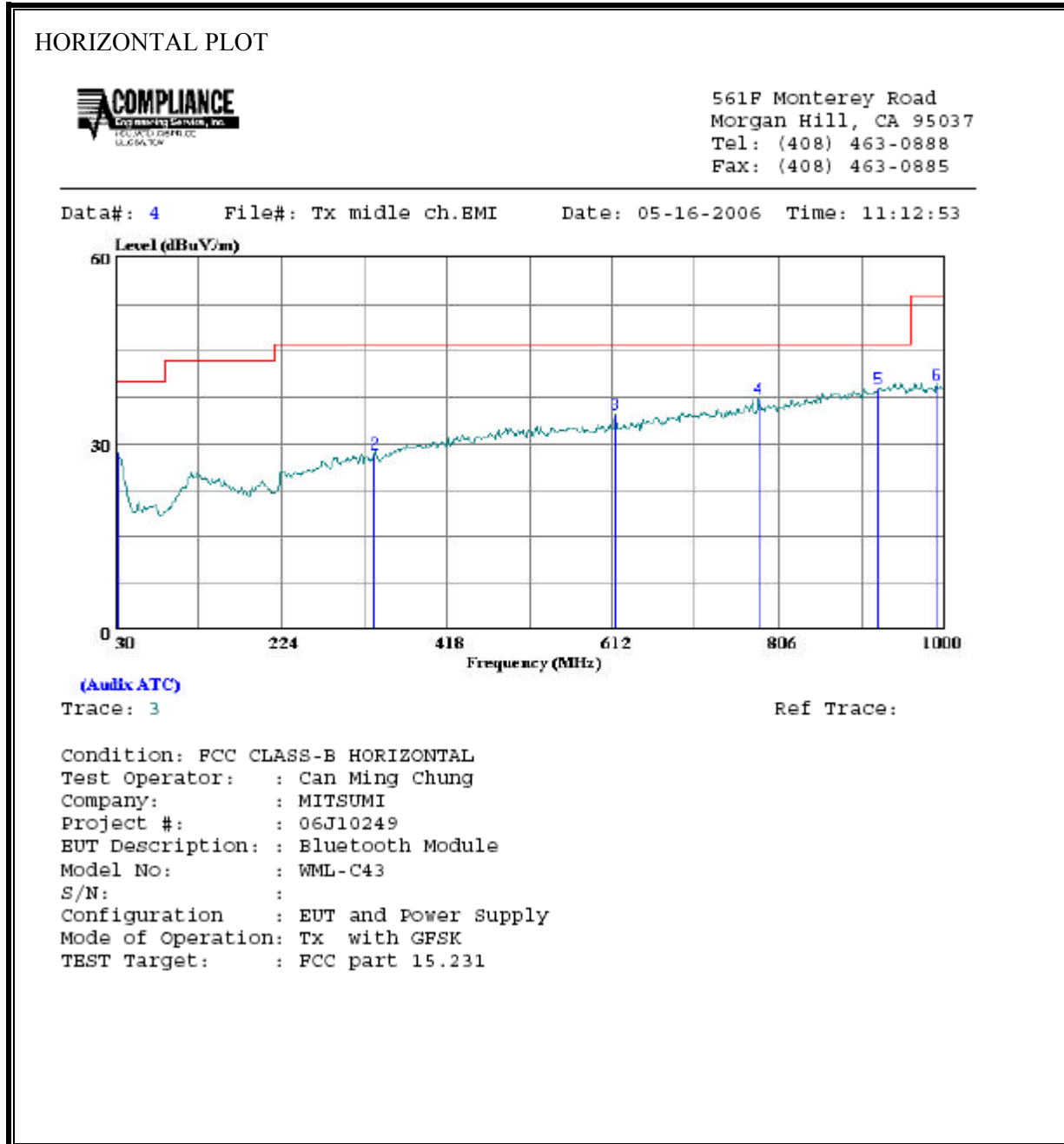

HORIZONTAL DATA

	Freq	Read Level	Factor	Level	Limit Line	Over Limit	Remark
	MHz	dBuV	dB	dBuV/m	dBuV/m	dB	
1	32.910	8.49	19.94	28.43	40.00	-11.57	Peak
2	333.610	11.73	16.50	28.23	46.00	-17.77	Peak
3	615.880	12.85	21.81	34.66	46.00	-11.34	Peak
4	781.750	12.76	24.31	37.07	46.00	-8.93	Peak
5	921.430	12.64	26.12	38.76	46.00	-7.24	Peak
6	990.300	12.60	26.88	39.49	54.00	-14.52	Peak

SPURIOUS EMISSIONS 30 TO 1000 MHz (WORST-CASE CONFIGURATION, VERTICAL)

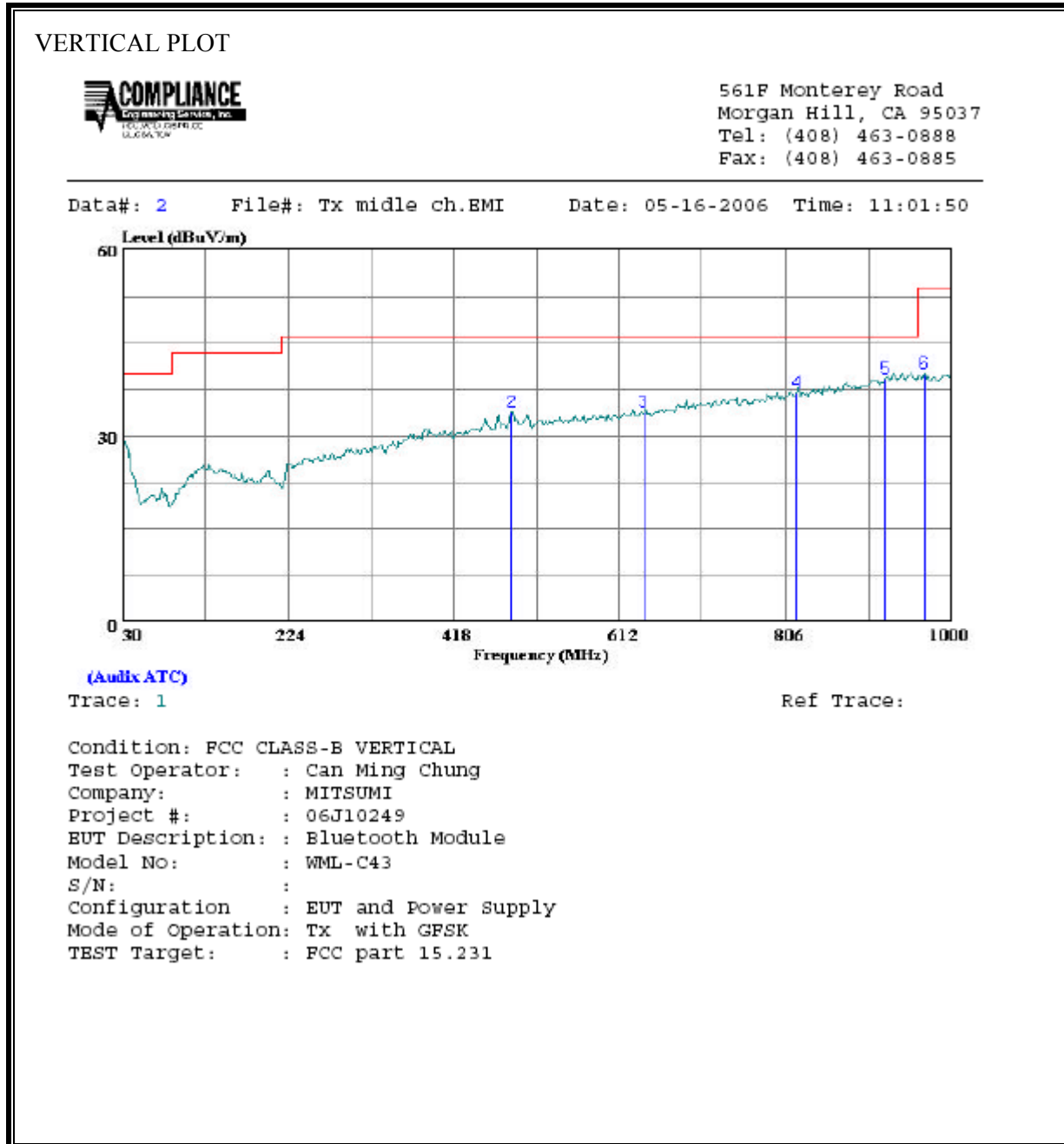

VERTICAL DATA

	Freq	Read Level	Factor	Level	Limit Line	Over Limit	Remark
	MHz	dBuV	dB	dBuV/m	dBuV/m	dB	
1	30.000	9.88	20.45	30.33	40.00	-9.67	Peak
2	485.900	13.84	19.95	33.79	46.00	-12.21	Peak
3	641.100	11.73	22.19	33.92	46.00	-12.08	Peak
4	817.640	12.05	24.83	36.88	46.00	-9.12	Peak
5	921.430	13.15	26.12	39.27	46.00	-6.73	Peak
6	967.990	13.44	26.65	40.09	54.00	-13.91	Peak

7.4. POWERLINE CONDUCTED EMISSIONS

LIMIT

§15.207 (a) Except as shown in paragraphs (b) and (c) of this section, for an intentional radiator that is designed to be connected to the public utility (AC) power line, the radio frequency voltage that is conducted back onto the AC power line on any frequency or frequencies within the band 150 kHz to 30 MHz shall not exceed the limits in the following table, as measured using a 50 μ H/50 ohms line impedance stabilization network (LISN). Compliance with the provisions of this paragraph shall be based on the measurement of the radio frequency voltage between each power line and ground at the power terminal.

The lower limit applies at the boundary between the frequency ranges.

Frequency of Emission (MHz)	Conducted Limit (dBuV)	
	Quasi-peak	Average
0.15-0.5	66 to 56*	56 to 46*
0.5-5	56	46
5-30	60	50

*Decreases with the logarithm of the frequency.

TEST PROCEDURE

The EUT is placed on a non-conducting table 40 cm from the vertical ground plane and 80 cm above the horizontal ground plane. The EUT is configured in accordance with ANSI C63.4.

The resolution bandwidth is set to 9 kHz for both peak detection and quasi-peak detection measurements. Peak detection is used unless otherwise noted as quasi-peak.

Line conducted data is recorded for both NEUTRAL and HOT lines.

RESULTS

No non-compliance noted:

6 WORST EMISSIONS

CONDUCTED EMISSIONS DATA (115VAC 60Hz)										
Freq. (MHz)	Reading			Class (dB)	Limit QP	EN B		Margin		Remark L1 / L2
	PK (dBuV)	QP (dBuV)	AV (dBuV)			AV	QP (dB)	AV (dB)		
0.29	54.14	--	45.75	0.00	60.67	50.67	-6.53	-4.92	L1	
15.97	56.36	--	45.46	0.00	60.00	50.00	-3.64	-4.54	L1	
20.92	51.60	--	42.36	0.00	60.00	50.00	-8.40	-7.64	L1	
0.28	50.04	--	42.03	0.00	60.76	50.76	-10.72	-8.73	L2	
15.97	56.70	--	46.96	0.00	60.00	50.00	-3.30	-3.04	L2	
20.92	51.70	--	42.48	0.00	60.00	50.00	-8.30	-7.52	L2	
6 Worst Data										

LINE 1 RESULTS

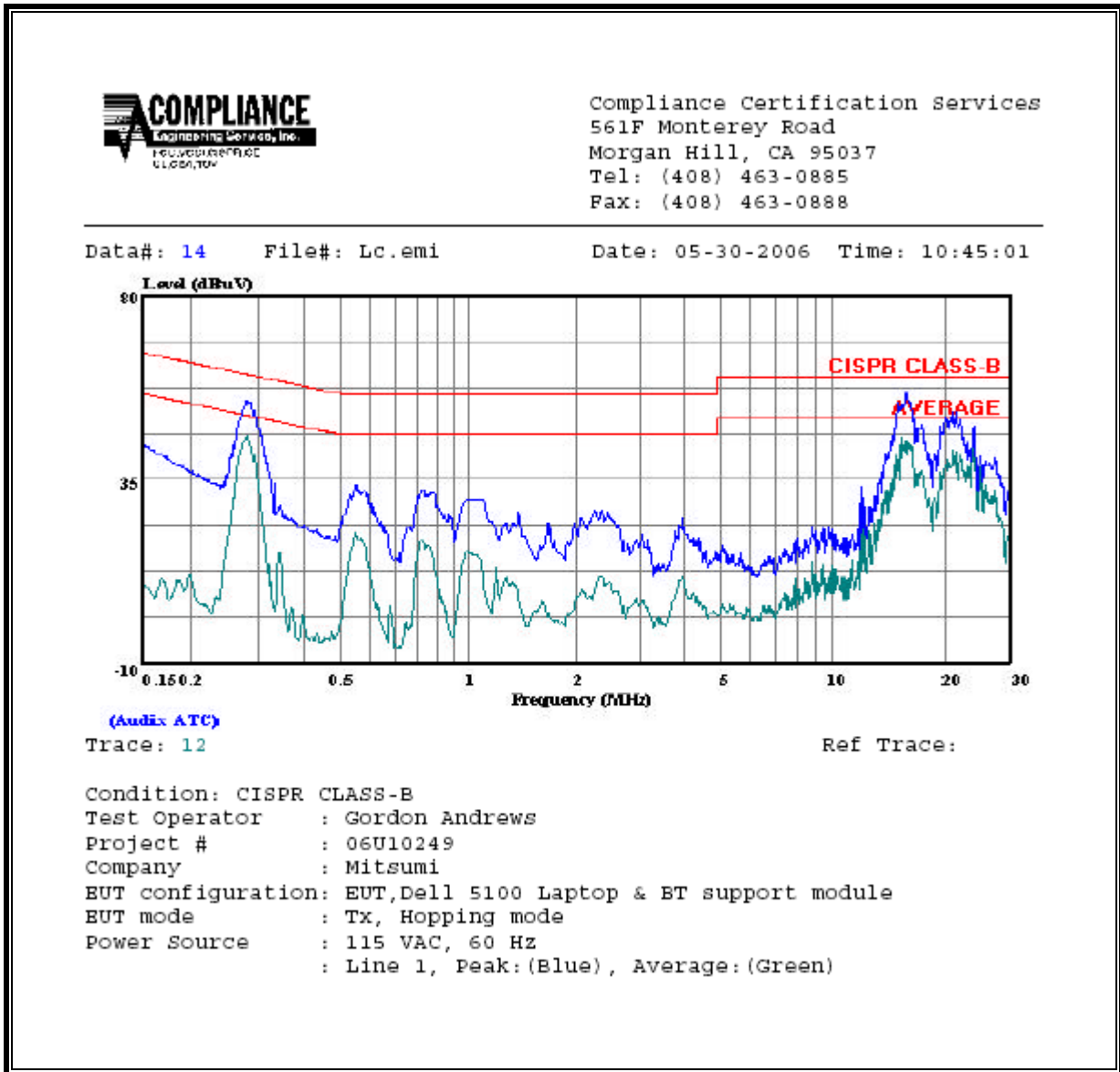

LINE 2 RESULTS

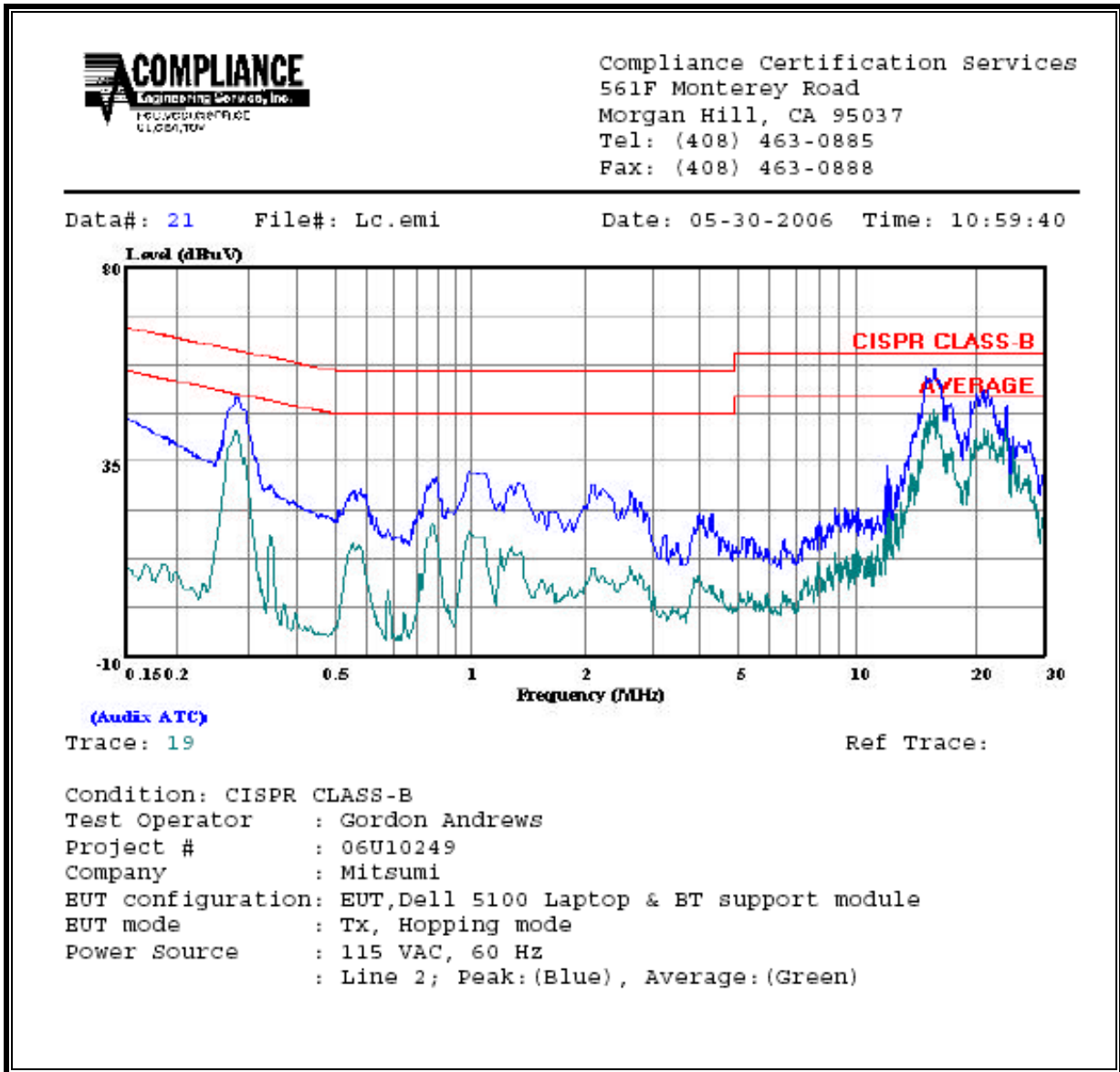

8. SETUP PHOTOS

ANTENNA PORT CONDUCTED RF MEASUREMENT SETUP

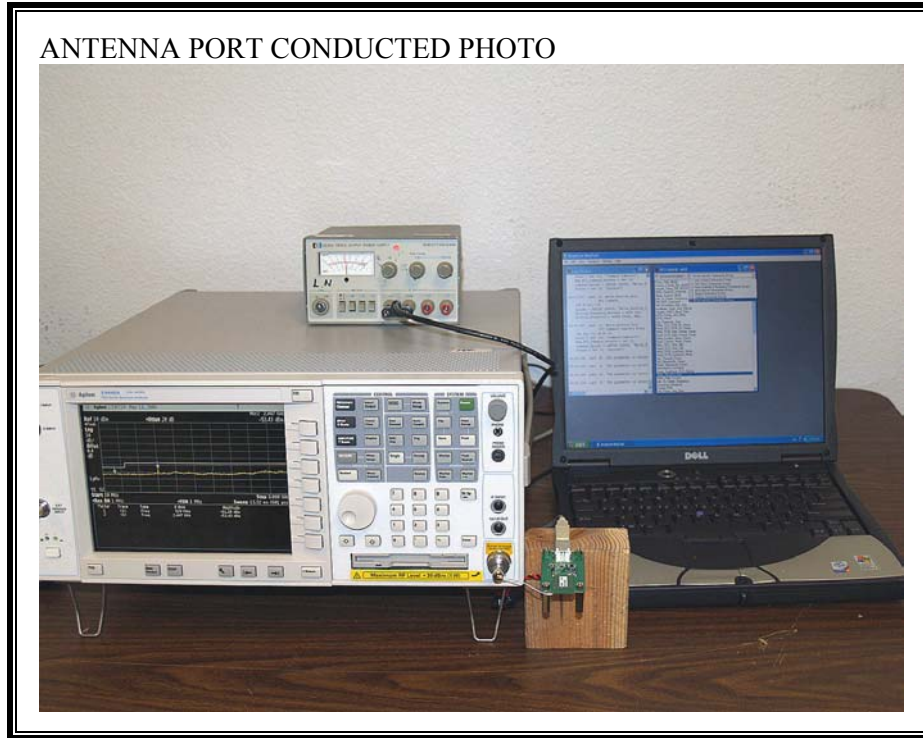

RADIATED RF MEASUREMENT SETUP





Z-AXIS PHOTO

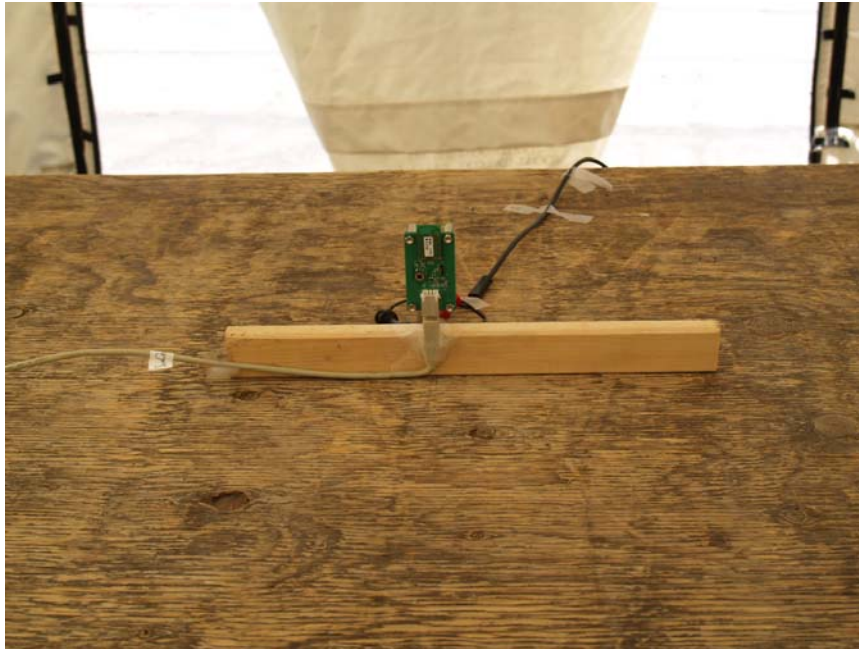

POWERLINE CONDUCTED EMISSIONS MEASUREMENT SETUP



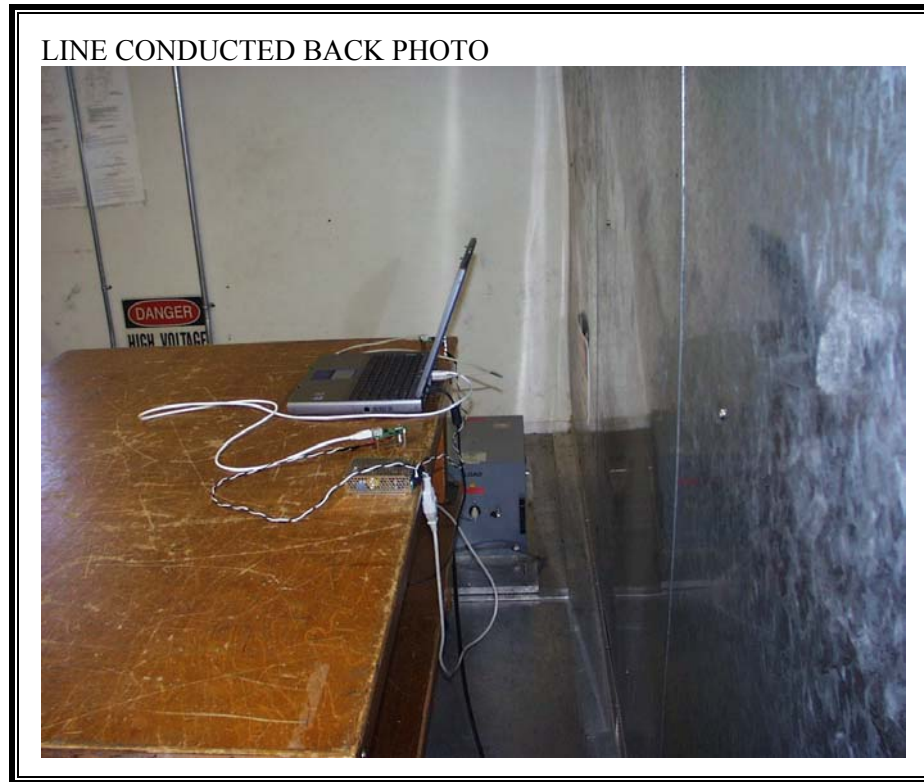

END OF REPORT