

Inter|Lab[®]

EMC Measurement/Technical Report on Bluetooth Module WML-C29

Report Reference: 4_MITSU_0104_BTT_FCCc

Test Laboratory (Headquarter):

7 Layers AG
Borsigstr. 11
40880 Ratingen
Germany



TTI-P-G 178/99

Note:

The following test results relate only to the devices specified in this document. This report shall not be reproduced in parts without the written approval of the testing laboratory.

7 layers AG, Borsigstrasse 11
40880 Ratingen, Germany
Phone: +49 (0) 2102 749 0
Fax: +49 (0) 2102 749 350
<http://www.7Layers.com>

Aufsichtsratsvorsitzender
Chairman of the Supervisory Board:
Michael Abels
Vorstand - Board of Directors:
Dr. Hans-Jürgen Meckelburg

Registergericht - registered in:
Düsseldorf, HRB 44096
USt-IdNr VAT Nr:
DE 203159652

Interlab is a registered trademark of 7 layers AG

Table of Contents

0. Summary	3
0.1 Technical Report Summary	3
0.2 Measurement Summary	4
1. Administrative Data	6
1.1 Testing Laboratory	6
1.2 Project Data	6
1.3 Applicant Data	6
1.4 Manufacturer Data	6
2. Product Labeling	7
2.1 FCC ID Label	7
2.2 Location of Label on the EUT	8
3. Testobject Data	8
3.1 General EUT Description	8
3.2 EUT Main Components	9
3.3 Ancillary Equipment	9
3.4 EUT Setups	9
3.5 Operating Modes	10
4. Test Results	11
- Conducted Emissions	-
4.1 Occupied Bandwidth	11
4.2 Peak Power Output	14
4.3 Spurious RF Conducted Emissions	17
4.4 Spurious RF Radiated Emissions	19
4.5 Dwell Time	23
4.6 Power Density	25
4.7 Channel Separation	27
- Processing Gain	-
5. Testequipment	28
6. Foto Report	31
7. Setup Drawings	33
8. Annex	35
Measurement plots	25 Pages



0 Summary

0.1 Technical Report Summary

Type of Authorization

Certification for an Intentional Radiator (Frequency Hopping Spread Spectrum)

Applicable FCC Rules:

Prepared in accordance with the requirements of FCC Rules and Regulations as listed in 47 CFR Ch.1 Parts 0 to 19 (10-1-98 Edition). The following subparts are applicable to the results in this test report.

Part 2, Subpart J - Equipment Authorization Procedures, Certification Sections

Part 15, Subpart C - Intentional Radiators

§ 15.201 Equipment authorization requirement

§ 15.207 Conducted limits

§ 15.209 Radiated emission limits; general requirements

§ 15.247 Operation within the bands 902-928 MHz, 2400-2483,5 MHz and 5725-5850 MHz

Note:

The tests were selected and performed with reference to the FCC Public Notice DA 00-705, released March 30, 2000

Summary Test Results:

The EUT complied with all performed tests as listed in chapter 0.2 Measurement Summary.



0.2 Measurement Summary

FCC Part 15, Subpart C § 15.247 (a) (1) (ii)

Occupied Bandwidth

The measurement was performed according to ANSI C63.4 1992

OP-Mode	Setup	Port	Final Result
op-mode 1	setup 1	temporary antenna connector	passed
op-mode 2	setup 1	temporary antenna connector	passed
op-mode 3	setup 1	temporary antenna connector	passed
op-mode 4	setup 1	temporary antenna connector	passed
op-mode 5	setup 1	temporary antenna connector	passed

FCC Part 15, Subpart C § 15.247 (b) (1)

Peak Power Output

The measurement was performed according to FCC §15.31 10-1-1998

OP-Mode	Setup	Port	Final Result
op-mode 1	setup 1	temporary antenna connector	passed
op-mode 2	setup 1	temporary antenna connector	passed
op-mode 3	setup 1	temporary antenna connector	passed
op-mode 4	setup 1	temporary antenna connector	passed
op-mode 5	setup 1	temporary antenna connector	passed

FCC Part 15, Subpart C § 15.247 (c)

Spurious RF Conducted Emissions

The measurement was performed according to FCC §15.31 10-1-1998

OP-Mode	Setup	Port	Final Result
op-mode 1	setup 1	temporary antenna connector	passed
op-mode 2	setup 1	temporary antenna connector	passed
op-mode 3	setup 1	temporary antenna connector	passed

FCC Part 15, Subpart C § 15.247 (c), §15.35 (b), § 15.209

Spurious Radiated Emissions

The measurement was performed according to ANSI C63.4 1992

OP-Mode	Setup	Port	Final Result
op-mode 1	setup 2	enclosure	passed
op-mode 2	setup 2	enclosure	passed
op-mode 3	setup 2	enclosure	passed

FCC Part 15, Subpart C § 15.247 (g)

Dwell Time

The measurement was performed according to FCC §15.31 10-1-1998

OP-Mode	Setup	Port	Final Result
op-mode 4	setup 1	temporary antenna connector	passed
op-mode 5	setup 1	temporary antenna connector	passed

FCC Part 15, Subpart C § 15.247 (g)

Power Density

The measurement was performed according to FCC §15.31 10-1-1998

OP-Mode	Setup	Port	Final Result
op-mode 4	setup 1	temporary antenna connector	passed
op-mode 5	setup 1	temporary antenna connector	passed

FCC Part 15, Subpart C § 15.247 (a) (1)

Channel Separation

The measurement was performed according to FCC §15.31 10-1-1998

OP-Mode	Setup	Port	Final Result
op-mode 6	setup 1	temporary antenna connector	passed

The tests were chosen on customer's demand.

Responsible for Accreditation Scope: _____

Responsible for Test Report: _____

1. Administrative Data

1.1 Testing Laboratory

Company Name: 7 Layers AG
Address: Borsigstr. 11
40880 Ratingen
Germany

This facility has been fully described in a report submitted to the FCC and accepted under the registration number 96716.

The test facility is also accredited by the following accreditation organisation:

- Deutscher Akkreditierungs Rat DAR-Registration no. TTI-P-G 178/99

Responsible for Accreditation Scope: Dipl.-Ing Bernhard Retka
Dipl.-Ing Arndt Stöcker
Dipl.-Ing Thomas Hoell

1.2 Project Data

Responsible for testing and report: Dipl.-Ing. Robert Machulec
Receipt of EUT: 2004-08-10
Date of Test(s): 2004-08-11 - 2004-10-22
Date of Report: 2004-11-04

1.3 Applicant Data

Company Name: Mitsumi Electric Co., Ltd.
Address: 2-11-2, Tsurumaki, Tama-Shi
206-8567 Tokyo
Japan
Contact Person: Mr. Ryoji Waki

1.4 Manufacturer Data

Company Name: please see Applicant data
Address:

Contact Person:

2.0 Product Labeling

2.1 FCC ID Label:

At the time of the test report there was no FCC label available.

2.2 Location of Label on the EUT:

see above

3. Testobject Data

3.1 General EUT Description

Equipment under Test:	Bluetooth Module
Type Designation:	WML-C29
Kind of Device: (optional)	Bluetooth transceiver module
Voltage Type:	DC
Voltage level:	3.3 V

General product description:

Bluetooth is a short-range radio link intended to be a cable replacement between portable and/or fixed electronic devices.

Bluetooth operates in the unlicensed ISM Band at 2.4 GHz. In the US a band of 83.5 MHz width is available. In this band, 79 RF channels spaced 1MHz apart are defined. The channel is represented by a pseudo-random hopping sequence through the 79 channels. The channel is divided into time slots, with a nominal slot length of 625 μ s, where each slot corresponds to different RF hop frequencies. The nominal hop rate is 1600 hops/s. All frequencies are equally used. The average time of occupancy is 0.3797 s within a 30 second period. The symbol rate on the channel is 1 Ms/s.

The EUT provides the following ports:

Ports

enclosure
temporary antenna connector

The main components of EUT are listed and described in Chapter 3.2

3.2 EUT Main components: Type, S/N, Short Descriptions etc. used in this Test Report

Short Description	Equipment under Test	Type Designation	Serial No.	HW Status	SW Status	Date of Receipt
EUT A (19022b00)	Bluetooth Module	WML-C29	Testsample 1	18.1	1	2004-08-10
EUT A is equipped with a temporary antenna connector.						
EUT B (19022b01)	Bluetooth Module	WML-C29	Testsample 2	18.1	1	2004-08-10
EUT B is equipped with internal antenna.						

NOTE: The short description is used to simplify the identification of the EUT in this test report

3.3 Ancillary Equipment

For the purposes of this test report, ancillary equipment is defined as equipment which is used in conjunction with the EUT to provide operational and control features to the EUT. It is necessary to configure the system in a typical fashion, as a customer would normally use it. But nevertheless Ancillary Equipment can influence the test results.

Short Description	Equipment under Test	Type Designation	HW Status	SW Status	Serial No.	FCC Id
AE 2	Casira box	-	-	-	-	-
AE 1	Mitsumi HCI Control board	BTDB02 (TZ16.0347)	-	-	AF49T	-

3.4 EUT Setups

This chapter describes the combination of EUT's and ancillary equipment used for testing.

Setup No.	Combination of EUTs	Description
setup 1	EUT A + AE 1	For conducted measurements
setup 2	EUT B + AE 2	For radiated measurements

3.5 Operating Modes

This chapter describes the operating modes of the EUT's used for testing.

Op. Mode	Description of Operating Modes	Remarks
op-mode 1	Loopback mode on 2402 MHz	The test system TS8960 was used as master and the EUT was configured as slave. Data (DH 1 packet, PRBS 9) was sent from the master to the slave and returned back by the slave.
op-mode 2	Loopback mode on 2441 MHz	The test system TS8960 was used as master and the EUT was configured as slave. Data (DH 1 packet, PRBS 9) was sent from the master to the slave and returned back by the slave.
op-mode 3	Loopback mode on 2480 MHz	The test system TS8960 was used as master and the EUT was configured as slave. Data (DH 1 packet, PRBS 9) was sent from the master to the slave and returned back by the slave.
op-mode 4	inquiry	The EUT transmits in Bluetooth inquiry mode
op-mode 5	paging	The EUT transmits in Bluetooth page mode
op-mode 6	10 neighbouring channels	The EUT is set to transmit on ten neighbouring channels one after the other to see the channel separation.

4. Test Results

4.1 Occupied Bandwidth

Standard FCC Part 15, 10-1-98
Subpart C

The test was performed according to: ANSI C63.4 1992

4.1.1 Test Description

The test set-up was made in accordance to the general provisions of ANSI C63.4-1992.

The Equipment Under Test (EUT) was setup in a shielded room to perform the occupied bandwidth measurements.

The reference level is the level of the highest amplitude signal observed from the transmitter at either the fundamental frequency or first-order modulation products in all typical modes of operation, including the unmodulated carrier, even if atypical.

The results recorded were measured with the modulation which produce the worst-case (widest) occupied bandwidth.

The resolution bandwidth for measuring the reference level and the occupied bandwidth was 10 kHz.

The reference level of the spectrum analyser was set equal to the reference level of the EUT.

4.1.2 Test Limits

FCC Part 15, Subpart C, §15.247 (a) (1) (ii)

(1) Frequency hopping systems operating in the 2400 - 2483.5 MHz band should use at least 75 hopping frequencies.

(2) The average time of occupancy on any frequency should not be greater than 0.4 seconds within a 30 second period.

(3) The maximum 20 dB bandwidth of the hopping channel is 1MHz.

4.1.3 Test Protocol

Temperature: 27 °C

Air Pressure: 1011 hPa

Humidity: 45 %

Op. Mode	Setup	Port	Test Parameter
op-mode 1	setup 1	temporary antenna connector	

20 dB Bandwidth MHz	Remarks
0,802	none

Remark: Please see annex for the measurement plot.

Temperature: 27 °C
 Air Pressure: 1011 hPa
 Humidity: 45 %

Op. Mode	Setup	Port	Test Parameter
op-mode 2	setup 1	temporary antenna connector	

20 dB Bandwidth MHz	Remarks
0,838	none

Remark: Please see annex for the measurement plot.

Temperature: 27 °C
 Air Pressure: 1011 hPa
 Humidity: 45 %

Op. Mode	Setup	Port	Test Parameter
op-mode 3	setup 1	temporary antenna connector	

20 dB Bandwidth MHz	Remarks
0,826	none

Remark: Please see annex for the measurement plot.

Temperature: 23 °C
 Air Pressure: 1025 hPa
 Humidity: 36 %

Op. Mode	Setup	Port	Test Parameter
op-mode 4	setup 1	temporary antenna connector	

20 dB Bandwidth MHz	Remarks
0,621	none

Remark: Please see annex for the measurement plot.

Temperature: 23 °C
 Air Pressure: 1025 hPa
 Humidity: 36 %

Op. Mode	Setup	Port	Test Parameter
op-mode 5	setup 1	temporary antenna connector	

20 dB Bandwidth MHz	Remarks
0,505	none

Remark: Please see annex for the measurement plot.



4.1.3 Test result: Occupied Bandwidth

FCC Part 15, Subpart C	Op. Mode	Setup	Port	Result
	op-mode 1	setup 1	temporary antenna connector	passed
	op-mode 2	setup 1	temporary antenna connector	passed
	op-mode 3	setup 1	temporary antenna connector	passed
	op-mode 4	setup 1	temporary antenna connector	passed
	op-mode 5	setup 1	temporary antenna connector	passed

4.2 Peak Power Output

Standard FCC Part 15, 10-1-98
Subpart C

The test was performed according to: FCC §15.31 10-1-1998

4.2.1 Test Description

The Equipment Under Test (EUT) was set up in a shielded room to perform the output power measurements.

The results recorded were measured with the modulation which produces the worst-case (highest) output power.

The resolution bandwidth for measuring the output power was 1 MHz.

The reference level of the spectrum analyser was set equal to the output power of the EUT.

The EUT was connected to the spectrum analyzer via a short coax cable (Type: Rosenberger RTK 161, 1m, SMA connectors), with a known loss.

4.2.2 Test Limits

FCC Part 15, Subpart C, §15.247 (b) (1)

(1) For frequency hopping systems operating in the band 2400 - 2483,5 MHz or 5725 - 5850 MHz and for all direct sequence systems: 1 Watt

Used conversion factor: Limit (dBm) = 10 log (Limit (W)/1mW)

==> Maximum Output Power: 30 dBm

4.2.3 Test Protocol

Temperature: 27 °C

Air Pressure: 1011 hPa

Humidity: 45 %

Op. Mode	Setup	Port	Test Parameter
op-mode 1	setup 1	temporary antenna connector	

Output Power dBm	Remarks
0,41	The EIRP including antenna gain (2,14 dBi) is 2,55 dBm

Remark: Please see annex for the measurement plot.

Temperature: 27 °C
 Air Pressure: 1011 hPa
 Humidity: 45 %

Op. Mode	Setup	Port	Test Parameter
op-mode 2	setup 1	temporary antenna connector	

Output Power dBm	Remarks
0,49	The EIRP including antenna gain (2,14 dBi) is 2,63 dBm

Remark: Please see annex for the measurement plot.

Temperature: 27 °C
 Air Pressure: 1011 hPa
 Humidity: 45 %

Op. Mode	Setup	Port	Test Parameter
op-mode 3	setup 1	temporary antenna connector	

Output Power dBm	Remarks
0,54	The EIRP including antenna gain (2,14 dBi) is 2,68 dBm

Remark: Please see annex for the measurement plot.

Temperature: 23 °C
 Air Pressure: 1025 hPa
 Humidity: 36 %

Op. Mode	Setup	Port	Test Parameter
op-mode 4	setup 1	temporary antenna connector	

Output Power dBm	Remarks
0,5	The EIRP including antenna gain (2,14 dBi) is 2,64 dBm

Remark: Please see annex for the measurement plot.

Temperature: 23 °C
 Air Pressure: 1025 hPa
 Humidity: 36 %

Op. Mode	Setup	Port	Test Parameter
op-mode 5	setup 1	temporary antenna connector	

Output Power dBm	Remarks
0,54	The EIRP including antenna gain (2,14 dBi) is 2,64 dBm

Remark: Please see annex for the measurement plot.



4.2.3 Test result: Peak Power Output

FCC Part 15, Subpart C	Op. Mode	Setup	Port	Result
	op-mode 1	setup 1	temporary antenna connector	passed
	op-mode 2	setup 1	temporary antenna connector	passed
	op-mode 3	setup 1	temporary antenna connector	passed
	op-mode 4	setup 1	temporary antenna connector	passed
	op-mode 5	setup 1	temporary antenna connector	passed

4.3 Spurious RF Conducted Emissions

Standard FCC Part 15, 10-1-98
Subpart C

The test was performed according to: FCC §15.31 10-1-1998

4.3.1 Test Description

The Equipment Under Test (EUT) was set up in a shielded room to perform the output power measurements

The EUT was connected to spectrum analyzer via a short coax cable (Type: Rosenberger RTK 161, 1m, SMA connectors), with a known loss.

Analyser settings:

- Detector: Peak-Maxhold
- Frequency range: 30 – 25000 MHz
- Resolution Bandwidth (RBW): 100 kHz
- Video Bandwidth (VBW): 100 kHz
- Sweep Time: Coupled

The reference level of the spectrum analyser was set equal to the reference level of the EUT.

4.3.2 Test Limits

FCC Part 15, Subpart C, §15.247 (c)

In any 100 kHz bandwidth outside the frequency band in which the spread spectrum intentional radiator is operating, the radio frequency power that is produced by the intentional radiator shall be at least 20dB below that in the 100kHz bandwidth within the band that contains the highest level of the desired power.

4.3.3 Test Protocol

Temperature: 27 °C
Air Pressure: 1011 hPa
Humidity: 45 %

Op. Mode	Setup	Port	Test Parameter
op-mode 1	setup 1	temporary antenna connector	

Frequency MHz	Measured Value dBm	Correction Factor dB	Corrected Value	Reference Value dBm	Limit dBm	Delta to Limit dB
30,00			-47,99	0,31	-19,69	29,60
2482,00			-53,69	0,31	-19,69	29,43
4784,00			-56,25	0,31	-19,69	32,16
7186,00			-55,76	0,31	-19,69	36,07

Remark: No (further) spurious emissions were found in the range 20 dB below the limit.

Temperature: 27 °C
 Air Pressure: 1011 hPa
 Humidity: 45%

Op. Mode	Setup	Port	Test Parameter
op-mode 2	setup 1	temporary antenna connector	

Frequency MHz	Measured Value dBm	Correction Factor dB	Corrected Value	Reference Value dBm	Limit dBm	Delta to Limit dB
30,00			-46,99	0,47	-19,53	28,78
4884,00			-52,93	0,47	-19,53	27,02
6936,00			-56,24	0,47	-19,53	36,71
7336,00			-56,66	0,47	-19,53	37,13

Remark: No (further) spurious emissions were found in the range 20 dB below the limit.

Temperature: 27 °C
 Air Pressure: 1011 hPa
 Humidity: 45 %

Op. Mode	Setup	Port	Test Parameter
op-mode 3	setup 1	temporary antenna connector	

Frequency MHz	Measured Value dBm	Correction Factor dB	Corrected Value	Reference Value dBm	Limit dBm	Delta to Limit dB
30,00			-47,44	0,50	-19,50	28,66
4934,00			-51,49	0,50	-19,50	25,73
7436,00			-56,35	0,50	-19,50	37,24

Remark: No (further) spurious emissions were found in the range 20 dB below the limit.

4.3.3 Test result: Spurious RF Conducted Emissions

FCC Part 15, Subpart C	Op. Mode	Setup	Port	Result
	op-mode 1	setup 1	temporary antenna connector	passed
	op-mode 2	setup 1	temporary antenna connector	passed
	op-mode 3	setup 1	temporary antenna connector	passed

4.4 Spurious Radiated Emissions

Standard FCC Part 15, 10-1-98
Subpart C

The test was performed according to: ANSI C63.4 1992

4.4.1 Test Description

The test set-up was made in accordance to the general provisions of ANSI C63.4-1992.

The Equipment Under Test (EUT) was set up on a non-conductive table 1.0 x 2.0 m in the semi-anechoic chamber. The test was performed at an EUT to receiving antenna distance of 3m.

The radiated emissions measurements were made in a typical installation configuration.

The measurement procedure consists of four steps. It is implemented into EMI test software ES-K1 from R&S.

Step 1: Preliminary scan

Preliminary test to identify the highest amplitudes relative to the limit.

Settings for step 1:

- Detector: Peak-Maxhold
- Frequency range: 30 – 1000 MHz
- Frequency steps: 60 kHz
- IF-Bandwidth: 120 kHz
- Measuring time / Frequency step: 100 μ s
- Turntable angle range: -180 to 180 °
- Turntable stepsize: 90°
- Height variation range: 1 – 3m
- Height variation stepsize: 2m
- Polarisation: Horizontal + Vertical

Intention of this step is, to determine the radiated EMI-profile of the EUT.

With this data, the test system performs (to reduce the number of final measurements) a data reduction with the following parameters:

- Offset for acceptance analysis: Limit line – 10 dB
- Maximum number of final measurements: 12

Step 2:

With the frequencies determined in step 1, an additional measurement with the following settings will be performed. Intention of this step is, to find out the approximate turntable angle and antenna height for each frequency.

Settings for step 2:

- Detector: Peak – Maxhold
- Measured frequencies: in step 1 determined frequencies
- IF – Bandwidth: 120 kHz
- Measuring time: 100ms
- Turntable angle range: -180 to 180 °
- Turntable stepsize: 45°
- Height variation range: 1 – 4m
- Height variation stepsize: 0,5m

- Polarisation: horizontal + vertical

After this step the EMI test system has determined the following values for each frequency (of step 1):

- Frequency
- Azimuth value (of turntable)
- Antenna height

The last two values have now the following accuracy:

- Azimuth value (of turntable): 45°
- Antenna height: 0,5m

Step 3:

In this step the accuracy of the turntable azimuth and antenna height will be improved. This is necessary to find out the maximum value of every frequency.

For each frequency the turntable azimuth and antenna height, which was determined in step 3, will be adjusted.

The turntable azimuth will be slowly varied by +/- 22,5° around this value. During this action the value of emission is continuously measured. The turntable azimuth at the highest emission will be recorded and adjusted. In this position the antenna height is also slowly varied by +/- 25 cm around the antenna height determined in step 3. During this action the value of emission is also continuously measured. The antenna height of the highest emission will also be recorded and adjusted.

Settings for step 3:

- Detector: Peak – Maxhold
- Measured frequencies: in step 1 determined frequencies
- IF – Bandwidth: 120 kHz
- Measuring time: 100ms
- Turntable angle range: -22,5° to + 22,5 ° around the value determined in step 2
- Height variation range: -0,25m to + 0,25m around the value determined in step 2

Step 4:

With the settings determined in step 3, the final measurement will be performed:

EMI receiver settings for step 4:

- Detector: Quasi-Peak(< 1GHz)
- Measured frequencies: in step 1 determined frequencies
- IF – Bandwidth: 120 kHz
- Measuring time: 1s

The following modifications apply to the measurement procedure for the frequency range

above 1 GHz:

The measurement distance was reduced to 1m. The results were extrapolated by the extrapolation factor of 20 dB/decade (invers linear-distance for field strength measurements, invers linear-distance squared for the power reference level measurements). Due to the fact that in this frequency range a double ridged wave guided horn antenna (up to 18 GHz) and a horn antenna (18-25 GHz) are used, the steps 2-4 are omitted. Step 1 was performed with one height of the receiving antenna only.

Detector: Peak, Average

RBW = VBW = 1 MHz, above 7 GHz 100 kHz

After the measurement a plot will be generated which contains a diagram with the results of the preliminary scan and a chart with the frequencies and values of the results of the final measurement.

4.4.2 Test Limits

FCC Part 15, Subpart C, §15.247 (c)

(2) A radiated emission test applies to harmonic/spurs that fall in the restricted bands as listed in § 15.205(a). The maximum permitted QP (< 1GHz) and average (> 1GHz) field strength is listed in § 15.209(a).

(3)

FCC Part 15, Subpart C, §15.209, Radiated Emission Limits

Frequency Range (MHz):	Class B Limit (dBµV/m)
30 – 88	40,0
88 – 216	43,5
216 – 960	46,0
above 960	54,0

§15.35(b)

..., there is also a limit on the radio frequency emissions, as measured using instrumentation with a peak detector function, corresponding to 20 dB above the maximum permitted average limit....

Used conversion factor: Limit (dBµV/m) = 20 log (Limit (µV/m)/1µV/m)

4.4.3 Test Protocol

Temperature: 24 °C
 Air Pressure: 1012 hPa
 Humidity: 30 %

Op. Mode	Setup	Port	Test Parameter						
op-mode 1	setup 2	enclosure							
Polarisation	Frequency MHz	Corrected Value dBµV/m			Limit QP/AV dBµV/m	Limit Peak dBµV/m	Delta to AV/QP Limit/dB	Delta to Peak Limit dB	
		QP	Peak	AV					
Vertical	4804,00		50,14	39,24	54,00	74,00	14,76	23,86	

Remark: No further spurious emission in the range 20 dB below the limit found.

Temperature: 24 °C
 Air Pressure: 1012 hPa
 Humidity: 30 %

Op. Mode	Setup	Port	Test Parameter						
op-mode 2	setup 2	enclosure							
Polarisation	Frequency MHz	Corrected Value dBµV/m			Limit QP/AV dBµV/m	Limit Peak dBµV/m	Delta to AV/QP Limit/dB	Delta to Peak Limit dB	
		QP	Peak	AV					
Vertical	4882,00		52,29	41,04	54,00	74,00	12,96	21,71	
Vertical	7323,00		43,37	31,22	54,00	74,00	22,78	30,63	

Remark: No further spurious emission in the range 20 dB below the limit found.

Temperature: 24 °C
 Air Pressure: 1012 hPa
 Humidity: 30 %

Op. Mode Setup Port Test Parameter
 op-mode 3 setup 2 enclosure

Polarisation	Frequency MHz	Corrected Value dBµV/m			Limit QP/AV dBµV/m	Limit Peak dBµV/m	Delta to AV/QP Limit/dB	Delta to Peak Limit dB
		QP	Peak	AV				
Vertical	2484,00		54,00	41,07	54,00	74,00	12,93	20,00
Vertical	4960,00		51,42	40,19	54,00	74,00	13,81	22,58
Vertical	7440,00		42,01	29,69	54,00	74,00	24,31	31,99

Remark: No further spurious emission in the range 20 dB below the limit found.

4.4.3 Test result: Spurious Radiated Emissions

FCC Part 15, Subpart C

Op. Mode	Setup	Port	Result
op-mode 1	setup 2	enclosure	passed
op-mode 2	setup 2	enclosure	passed
op-mode 3	setup 2	enclosure	passed

4.5 Dwell Time

Standard FCC Part 15, 10-1-98
Subpart C

The test was performed according to: FCC §15.31 10-1-1998

4.5.1 Test Description

The Equipment Under Test (EUT) was set up in a shielded room to perform the output power measurements.

The reference level of the spectrum analyser was set equal to the output power of the EUT.

The EUT was connected to the spectrum analyzer via a short coax cable (Type: Rosenberger RTK 161, 1m, SMA connectors), with a known loss.

To determine the dwell time, 3 single measurements are necessary.

The first plot shows the activity for an complete inquiry/paging on one channel.

The second plot shows the repetition rate on one channel, and the third plot shows the duration of the burst used in inquiry/paging.

With this 3 single values the dwell time of the channel can be calculated.

4.5.2 Test Limits

FCC Part 15, Subpart C, §15.247 (g)

The dwell time of the channel shall be less than 400 ms in a 30 s period

4.5.3 Test Protocol

Temperature: 23 °C

Air Pressure: 1025 hPa

Humidity: 36 %

Op. Mode	Setup	Port	Test Parameter
op-mode 4	setup 1	temporary antenna connector	

Dwell time ms	Remarks
96,4681	$(3 * 2,55511s / 10ms) * 125,85\mu s = 96,4681 \text{ ms}$

Remark: Please see annex for the measurement plot.

Temperature: 23 °C
 Air Pressure: 1025 hPa
 Humidity: 36 %

Op. Mode	Setup	Port	Test Parameter
op-mode 5	setup 1	temporary antenna connector	

Dwell time ms	Remarks
32,05	$(5,11022 \text{ s} / 20 \text{ ms}) * 125,45 \mu\text{s} = 32,05 \text{ ms}$

Remark: Please see annex for the measurement plot.

4.5.3 Test result: Dwell Time

FCC Part 15, Subpart C	Op. Mode	Setup	Port	Result
	op-mode 4	setup 1	temporary antenna connector	passed
	op-mode 5	setup 1	temporary antenna connector	passed

4.6 Power Density

Standard FCC Part 15, 10-1-98
Subpart C

The test was performed according to: FCC §15.31 10-1-1998

4.6.1 Test Description

The Equipment Under Test (EUT) was set up in a shielded room to perform the output power measurements

The EUT was connected to spectrum analyzer via a short coax cable (Type: Rosenberger RTK 161, 1m, SMA connectors), with a known loss.

The Analyser settings are according 15.247 (d):

- Detector: Peak-Maxhold
- Span: 2 MHz
- Resolution Bandwidth (RBW): 3 kHz
- Video Bandwidth (VBW): 3 kHz
- Sweep Time: Coupled

The reference level of the spectrum analyser was set equal to the reference level of the EUT.

4.6.2 Test Limits

FCC Part 15, Subpart C, §15.247 (g)

The power density shall be below 8 dBm measured with a resolution bandwidth of 3 kHz.

4.6.3 Test Protocol

Temperature: 23 °C
Air Pressure: 1025 hPa
Humidity: 36 %

Op. Mode	Setup	Port	Test Parameter
op-mode 4	setup 1	temporary antenna connector	

Power Density dBm/3 kHz	Remarks
-9,25	none

Remark: Please see annex for the measurement plot.

Temperature: 23 °C
 Air Pressure: 1025 hPa
 Humidity: 36 %

Op. Mode	Setup	Port	Test Parameter
op-mode 5	setup 1	temporary antenna connector	

Power Density dBm/3 kHz	Remarks
-12,37	none

Remark: Please see annex for the measurement plot.

4.6.3 Test result: Power Density

FCC Part 15, Subpart C	Op. Mode	Setup	Port	Result
	op-mode 4	setup 1	temporary antenna connector	passed
	op-mode 5	setup 1	temporary antenna connector	passed

4.7 Channel Separation

Standard FCC Part 15, 10-1-98
Subpart C

The test was performed according to: FCC §15.31 10-1-1998

4.7.1 Test Description

The Equipment Under Test (EUT) was set up in a shielded room to perform the channel separation measurements

The EUT was connected to spectrum analyzer via a short coax cable (Type: Rosenberger RTK 161, 1m, SMA connectors), with a known loss.

Analyser settings:

- Detector: Peak-Maxhold
- Span: 10 MHz
- Resolution Bandwidth (RBW): 300 kHz
- Video Bandwidth (VBW): 300 kHz
- Sweep Time: Coupled

The reference level of the spectrum analyser was set equal to the reference level of the EUT.

4.7.2 Test Limits

FCC Part 15, Subpart C, § 15.247 (a) (1)

Frequency hopping systems shall have hopping channel carrier frequencies separated by a minimum of 25 kHz or the 20 dB bandwidth of the hopping channel, whichever is greater.

4.7.3 Test Protocol

Temperature: 23 ° C

Air Pressure: 1025 hPa

Humidity: 36 %

Op. Mode	Setup	Port	Test Parameter
op-mode 6	setup 1	temporary antenna connector	

Channel Separation MHz	Remarks
1	none

Remark: Please see annex for the measurement plot.

4.7.3 Test result: Channel Separation

FCC Part 15, Subpart C	Op. Mode	Setup	Port	Result
	op-mode 6	setup 1	temporary antenna connector	passed

5. Testequipment

EUT Digital Signalling System

Equipment	Type	Serial No.	Manufacturer
Digital Radio Communication Tester	CMD 55	831050/020	Rohde & Schwarz
Signalling Unit for Bluetooth Spurious Emissions	PTW60	100004	Rohde & Schwarz
Universal Radio Communication Tester	CMU 200	102366	Rohde & Schwarz

EMI Test System

Equipment	Type	Serial No.	Manufacturer
Comparison Noise Emitter	CNE III	99/016	York
EMI Analyzer	ESI 26	830482/004	Rohde & Schwarz
Signal Generator	SMR 20	846834/008	Rohde & Schwarz

EMI Radiated Auxiliary Equipment

Equipment	Type	Serial No.	Manufacturer
Antenna mast 4m	MA 240	240/492	HD GmbH H. Deisel
Biconical dipole	VUBA 9117	9117108	Schwarzbeck
Broadband Amplifier 18MHz-26GHz	JS4-18002600-32-5P	849785	Miteq
Broadband Amplifier 30MHz-18GHz	JS4-00101800-35-5P	896037	Miteq
Broadband Amplifier 45MHz-27GHz	JS4-00102600-42-5A	619368	Miteq
Cable "ESI to EMI Antenna"	RTK081+Aircell7	W18.01+W38.01a	Huber+Suhner
Cable "ESI to Horn Antenna"	RTK 081	W18.04+3599/001	Rosenberger
Double-ridged horn	HF 906	357357/002	Rohde & Schwarz
Double-ridged horn	HF 906	357357/001	Rohde & Schwarz
High Pass Filter	5HC3500/12750-1.2-KK	200035008	Trilithic
High Pass Filter	5HC2700/12750-1.5-KK	9942012	Trilithic
High Pass Filter	4HC1600/12750-1.5-KK	9942011	Trilithic
KUEP pre amplifier	Kuep 00304000	001	7layers
Log.-per. Antenna	HL 562 Ultralog	830547/003	Rohde & Schwarz
Loop Antenna	HFH2-Z2	829324/006	Rohde & Schwarz
Pyramidal Horn Antenna 26,5 GHz	Model 3160-09	9910-1184	EMCO

EMI Conducted Auxiliary Equipment

Equipment	Type	Serial No.	Manufacturer
Cable "LISN to ESI"	RG214	W18.03+W48.03	Huber+Suhner
Two-Line V-Network	ESH 3-Z5	828304/029	Rohde & Schwarz
Two-Line V-Network	ESH 3-Z5	829996/002	Rohde & Schwarz

Auxiliary Test Equipment

Equipment	Type	Serial No.	Manufacturer
Broadband Resist. Power Divider N	1506A / 93459	LM390	Weinschel
Broadband Resist. Power Divider SMA	1515 / 93459	LN673	Weinschel
Digital Multimeter 01	Voltcraft M-3860M	IJ096055	Conrad
Digital Multimeter 02	Voltcraft M-3860M	IJ095955	Conrad
Digital Oscilloscope	TDS 784C	B021311	Tektronix
Fibre optic link Satellite	FO RS232 Link	181-018	Pontis
Fibre optic link Transceiver	FO RS232 Link	182-018	Pontis
I/Q Modulation Generator	AMIQ-B1	832085/018	Rohde & Schwarz
Notch Filter ultra stable	WRCA800/960-6EEK	24	Wainwright
Spectrum Analyzer 9KHz To 3GHz	FSP3	838164/004	Rohde & Schwarz
Temperature Chamber	VT 4002	58566002150010	Vötsch
Temperature Chamber	KWP 120/70	59226012190010	Weiss
ThermoHygro_01	430202		Fischer

Anechoic Chamber

Equipment	Type	Serial No.	Manufacturer
Air Compressor (pneumatic)			Atlas Copco
Controller	HD 100	100/603	HD GmbH H. Deisel
EMC Camera	CE-CAM/1		CE-SYS
EMC Camera for observation of EUT	CCD-400E	0005033	Mitsubishi
Filter ISDN	B84312-C110-E1		Siemens&Matsushita
Filter telephone systems / modem	B84312-C40-B1		Siemens&Matsushita
Filter Universal 1A	B84312-C30-H3		Siemens&Matsushita
Fully/Semi AE Chamber	10.58x6.38x6		Frankonia
Turntable	DS 420S	420/573/99	HD GmbH, H. Deisel
Valve Control Unit (pneum.)	VE 615P	615/348/99	HD GmbH, H. Deisel



7 layers Bluetooth™ Full RF Test Solution

Bluetooth RF Conformance Test System TS8960

Equipment	Type	Serial No.	Manufacturer
10MHz Reference	MFS	5489/001	Efratom
Power Meter 832025/059	NRVD	832025/059	Rohde & Schwarz
Power Sensor A 832279/013	NRV-Z1	832279/013	Rohde & Schwarz
Power Sensor B 832279/015	NRV-Z1	832279/015	Rohde & Schwarz
Power Supply	E3632A	MY40003776	Agilent
Power Supply	PS-2403D	-	Conrad
RF Step Attenuator 833695/001	RSP	833695/001	Rohde & Schwarz
Rubidium Frequency Normal	MFS	002	Efratom
Signal Analyser FSIQ26 832695/007	FSIQ26	832695/007	Rohde & Schwarz
Signal Analyser FSP30 100051	FSP30	100051	Rohde & Schwarz
Signal Generator 101175	SMIQ03B	101175	Rohde & Schwarz
Signal Generator 833680/003	SMP 03	833680/003	Rohde & Schwarz
Signal Generator A 834344/002	SMIQ03B	834344/002	Rohde & Schwarz
Signal Generator B 832870/017	SMIQ03B	832870/017	Rohde & Schwarz
Signal Switching and Conditioning Unit	SSCU	338826/005	Rohde & Schwarz
Signalling Unit PTW60 838312/014	PTW60 for TS8960	838312/014	Rohde & Schwarz
System Controller 829323/008	PSM12	829323/008	Rohde & Schwarz

6. Foto Report

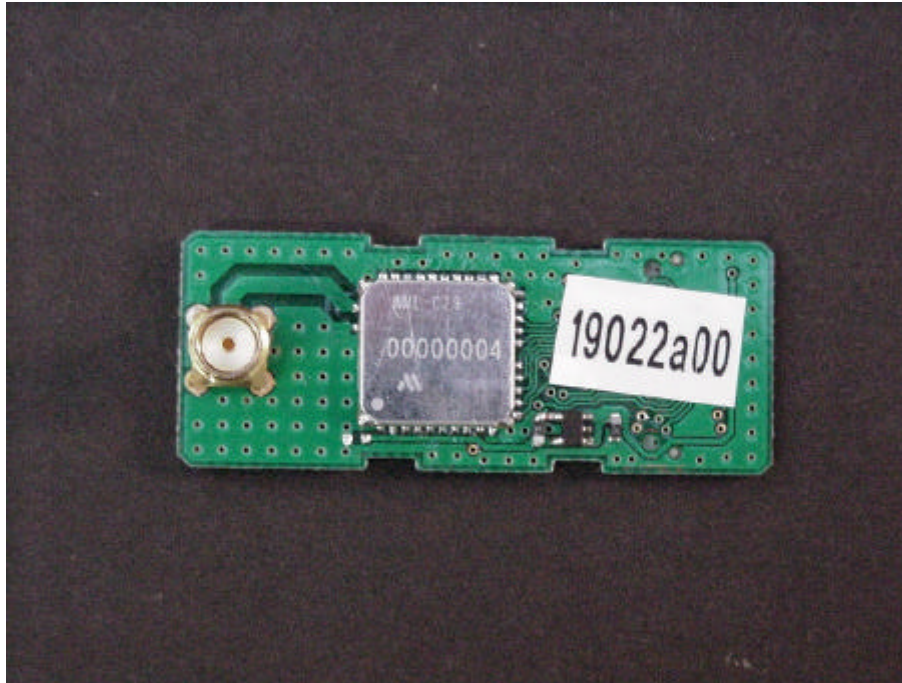

Picture 1 : EUT for conducted tests (front view)

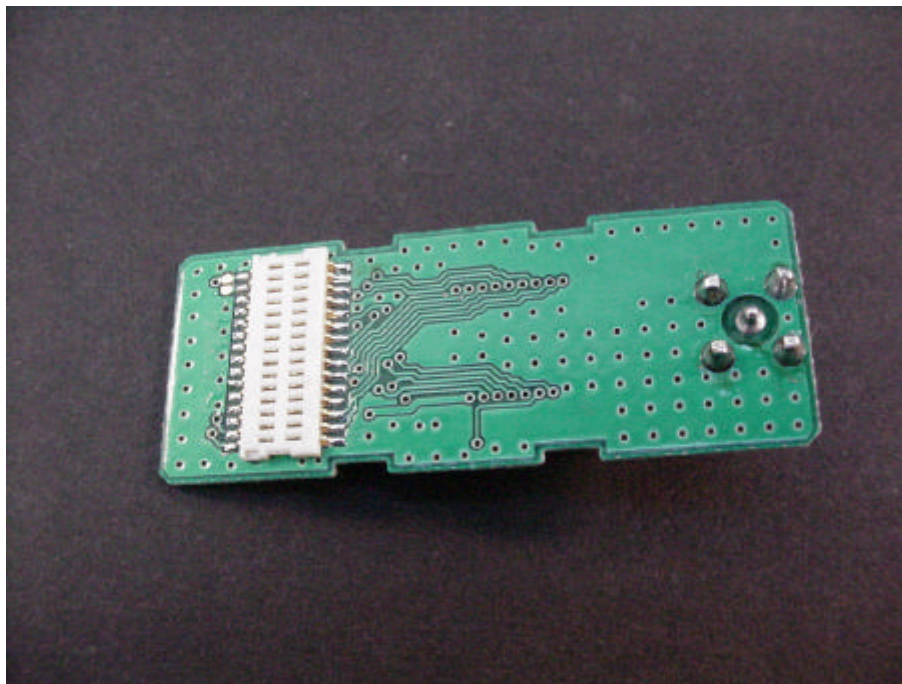

Picture 2 : EUT for conducted tests (rear view)

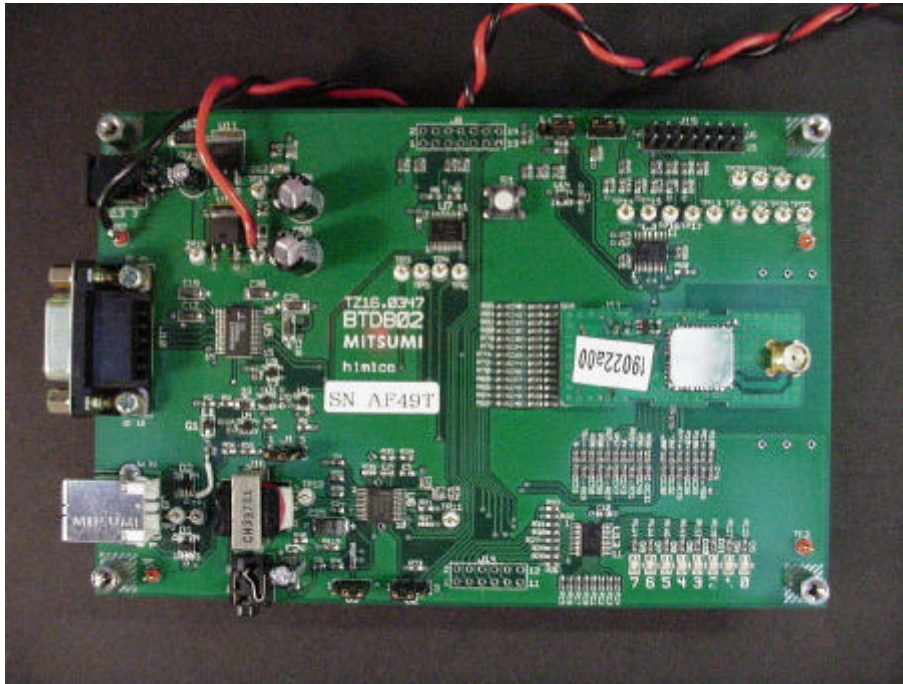

Picture 3 : EUT for conducted tests in the Mitsumi HCI control board

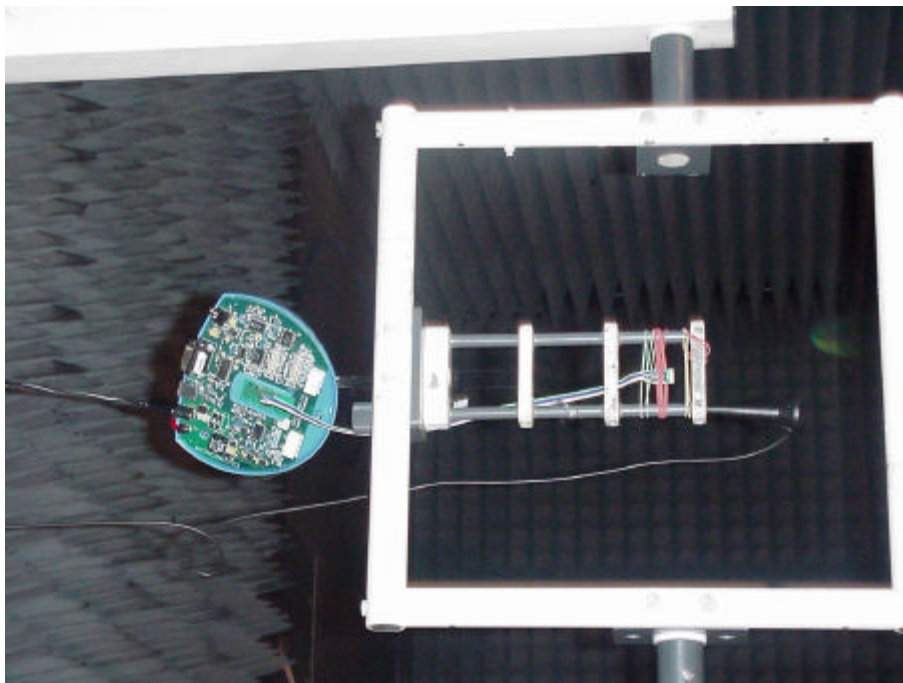

Picture 4 : EUT for radiated tests in the Casira box

7. Setup Drawings

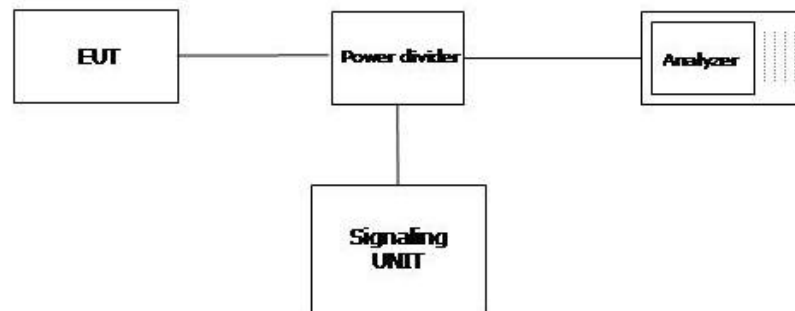

Drawing 1 : setup for conducted tests (in principle)

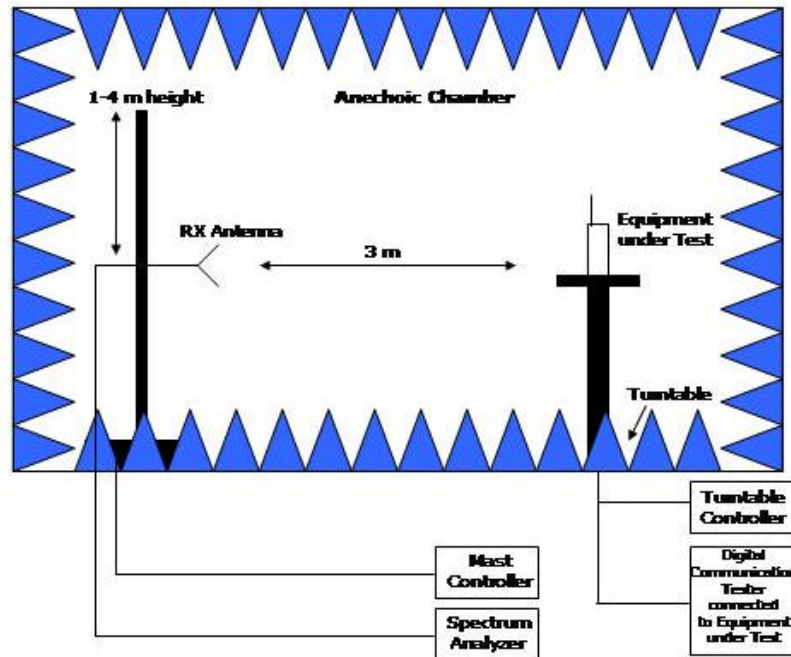

Remark: Depending on the frequency range suitable antenna types, attenuators or preamplifiers are used. For the frequency range below 1 GHz the floor absorbers are removed and a ground plane was used.

Drawing 2 : setup for radiated tests (in principle)

8. Annex

Measurement plots

Occupied Bandwidth

Op. Mode

op-mode 1 Loopback mode on 2402 MHz

Setup

setup 1

Port

temporary antenna connector

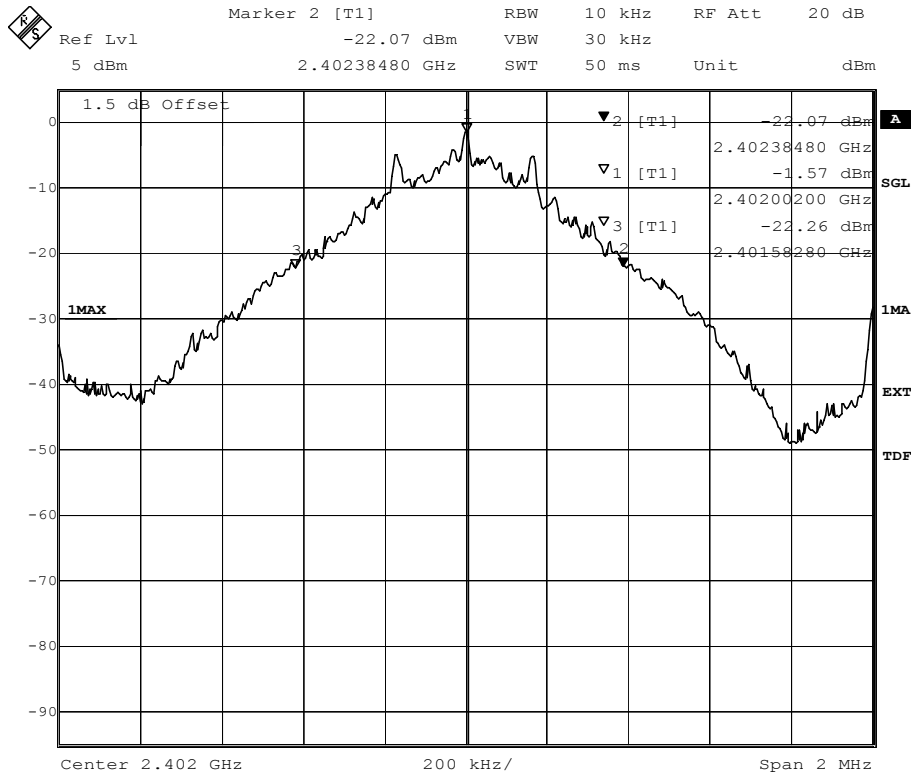

Title: 20dB Bandwidth
 Comment A: CH B: 2402 MHz; 20dB bandwidth (kHz):802
 Date: 11.AUG.2004 09:29:53

20 dB bandwidth

Occupied Bandwidth

Op. Mode

op-mode 2 Loopback mode on 2441 MHz

Setup

setup 1

Port

temporary antenna connector

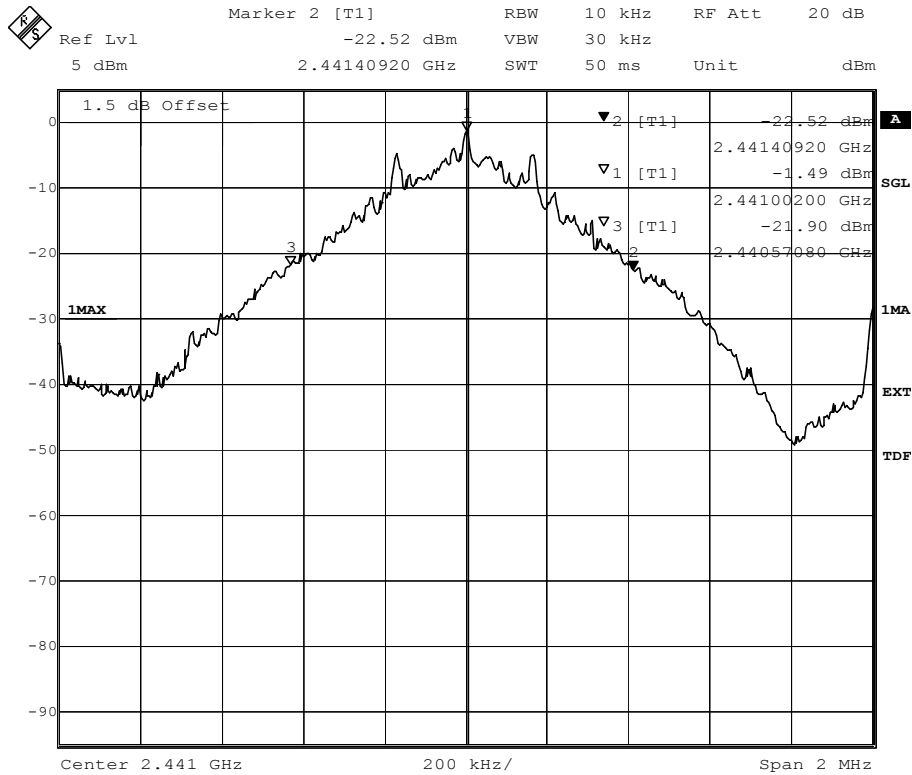

Title: 20dB Bandwidth
 Comment A: CH M: 2441 MHz; 20dB bandwidth (kHz):838.4
 Date: 11.AUG.2004 09:14:04

20 dB bandwidth

Occupied Bandwidth

Op. Mode

op-mode 3 Loopback mode on 2480 MHz

Setup

setup 1

Port

temporary antenna connector

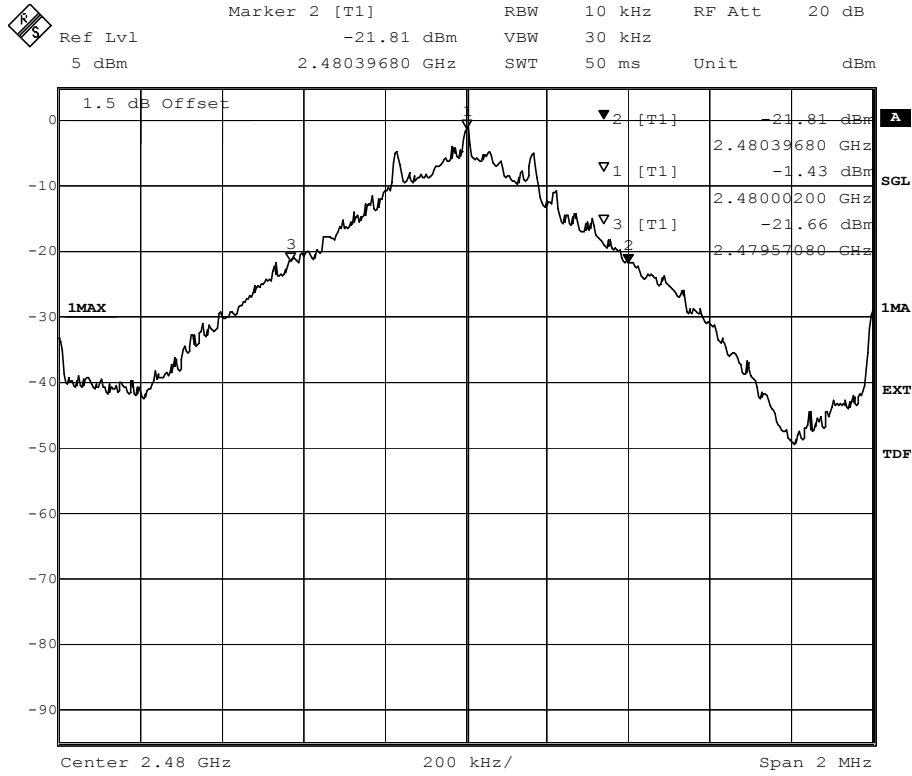

Title: 20dB Bandwidth
 Comment A: CH T: 2480 MHz; 20dB bandwidth (kHz):826
 Date: 11.AUG.2004 08:56:42

20 dB bandwidth

Occupied Bandwidth

Op. Mode

op-mode 4 inquiry

Setup

setup 1

Port

temporary antenna connector

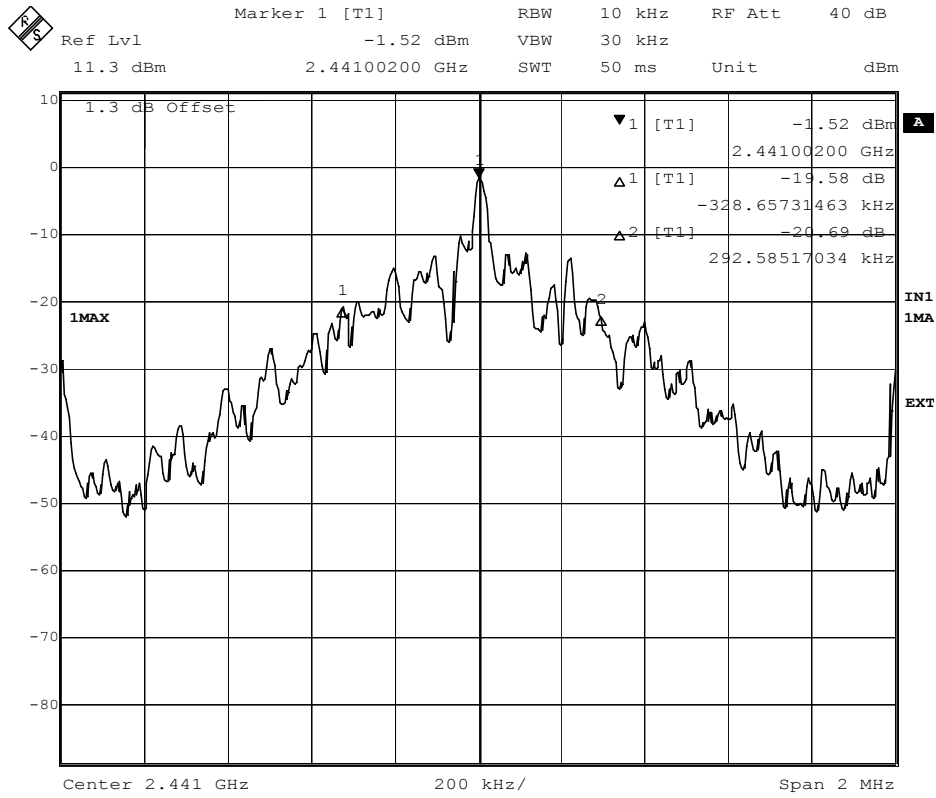

Title: WML-C29 (19022a00)
Date: 21.OCT.2004 14:51:25

20 dB bandwidth

Occupied Bandwidth

Op. Mode

op-mode 5 paging

Setup

setup 1

Port

temporary antenna connector

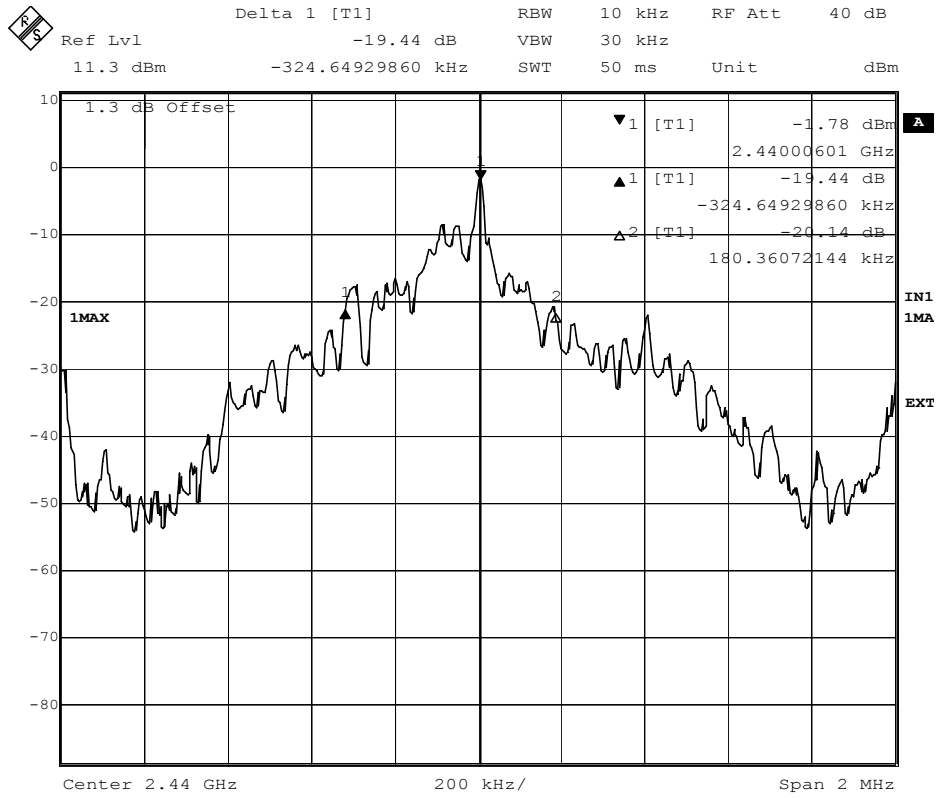

Title: WML-C29 (19022a00)
Date: 21.OCT.2004 15:34:19

20 dB bandwidth



Peak Power Output

Op. Mode

op-mode 1 Loopback mode on 2402 MHz

Setup

setup 1

Port

temporary antenna connector

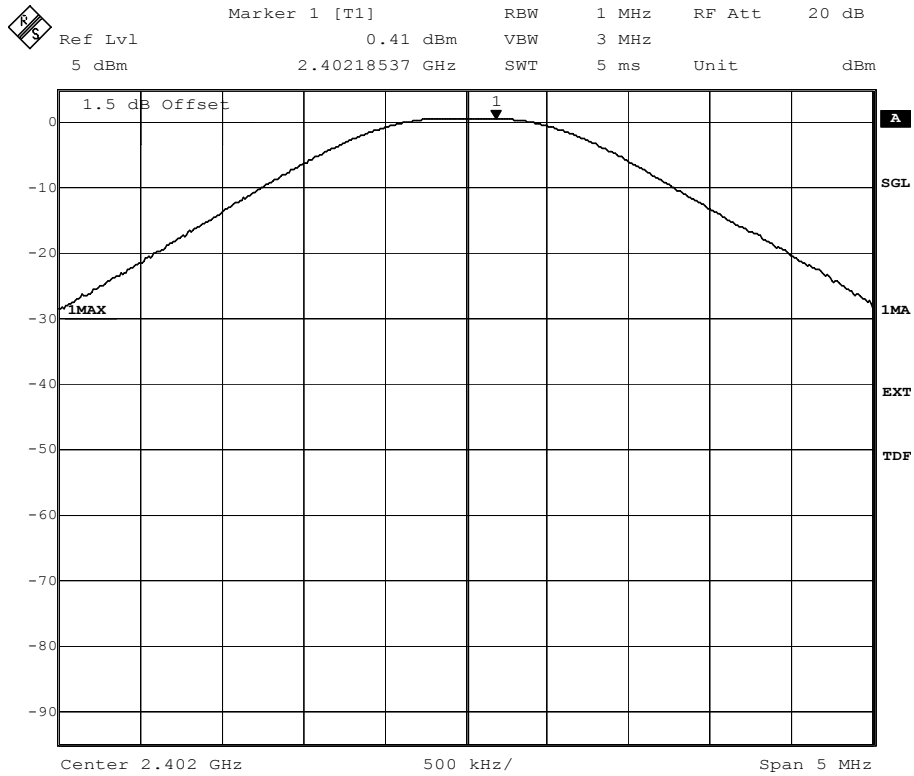

Title: Peak outputpower Power
Comment A: CH B: 2402 MHz
Date: 11.AUG.2004 09:30:21

peak output power



Peak Power Output

Op. Mode

op-mode 2 Loopback mode on 2441 MHz

Setup

setup 1

Port

temporary antenna connector

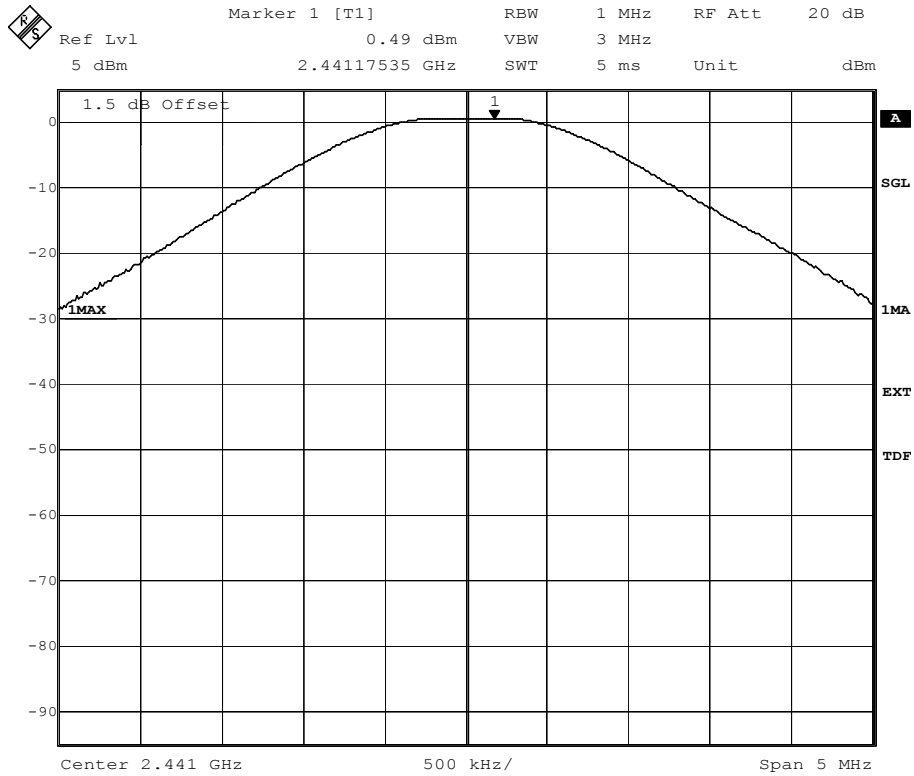

Title: Peak outputpower Power
Comment A: CH M: 2441 MHz
Date: 11.AUG.2004 09:14:32

peak output power



Peak Power Output

Op. Mode

op-mode 3 Loopback mode on 2480 MHz

Setup

setup 1

Port

temporary antenna connector

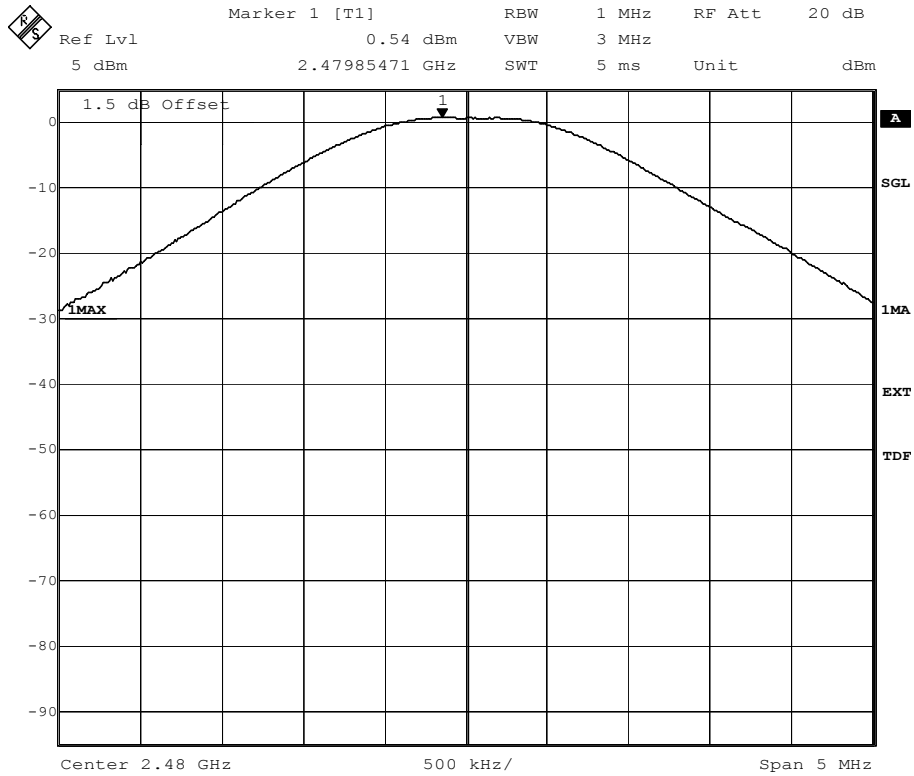

Title: Peak outputpower Power
Comment A: CH T: 2480 MHz
Date: 11.AUG.2004 08:57:08

peak output power



Peak Power Output

Op. Mode

op-mode 4 inquiry

Setup

setup 1

Port

temporary antenna connector

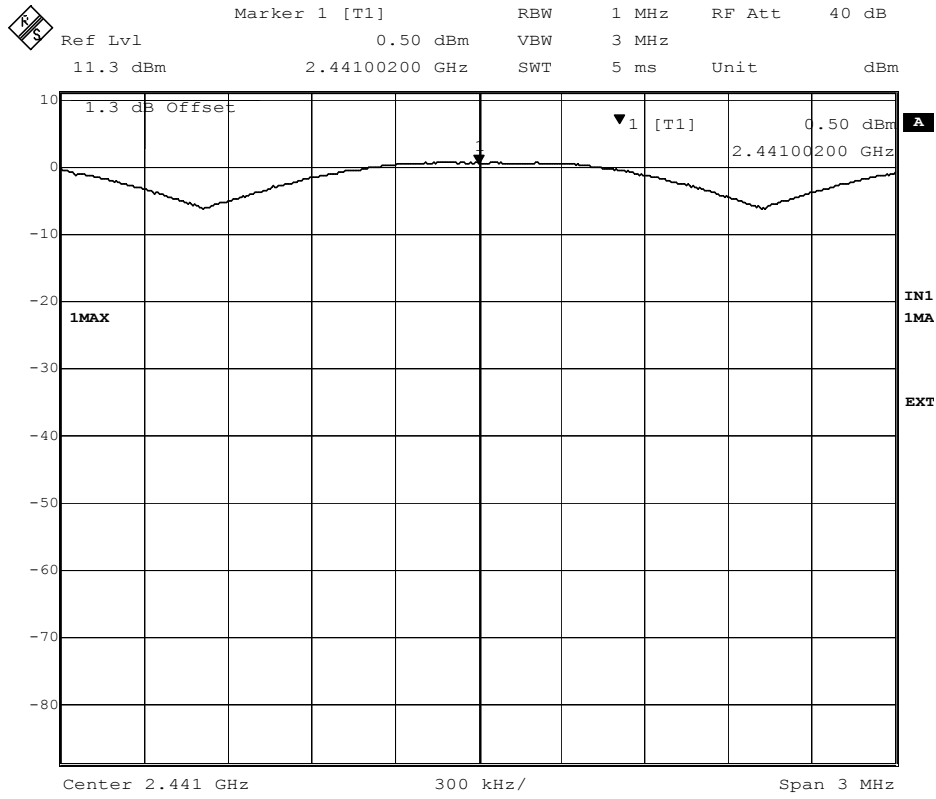

Title: WML-C29 (19022a00)
Date: 21.OCT.2004 14:57:44

peak output power



Peak Power Output

Op. Mode

op-mode 5 paging

Setup

setup 1

Port

temporary antenna connector

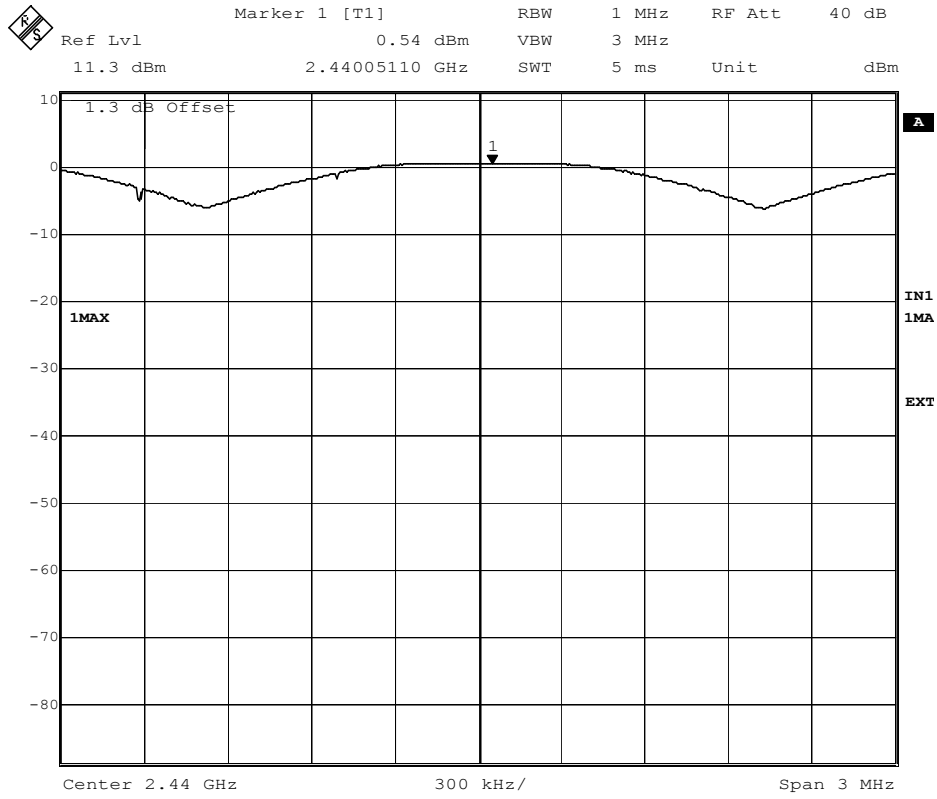

Title: WML-C29 (19022a00)
Date: 21.OCT.2004 16:22:43

peak output power

Spurious RF Conducted Emissions

Op. Mode

op-mode 1 Loopback mode on 2402 MHz

Setup

setup 1

Port

temporary antenna connector

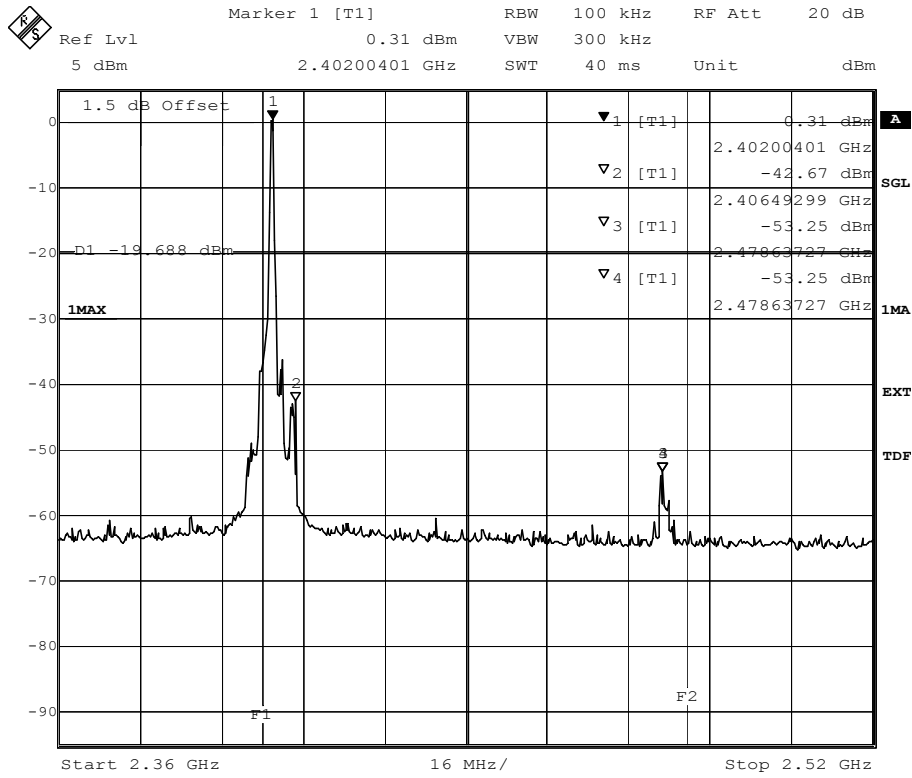

Title: Band Edge Compliance
 Comment A: CH B: 2402 MHz
 Date: 11.AUG.2004 09:19:58

band edge compliance



Spurious RF Conducted Emissions

Op. Mode

op-mode 1 Loopback mode on 2402 MHz

Setup

setup 1

Port

temporary antenna connector

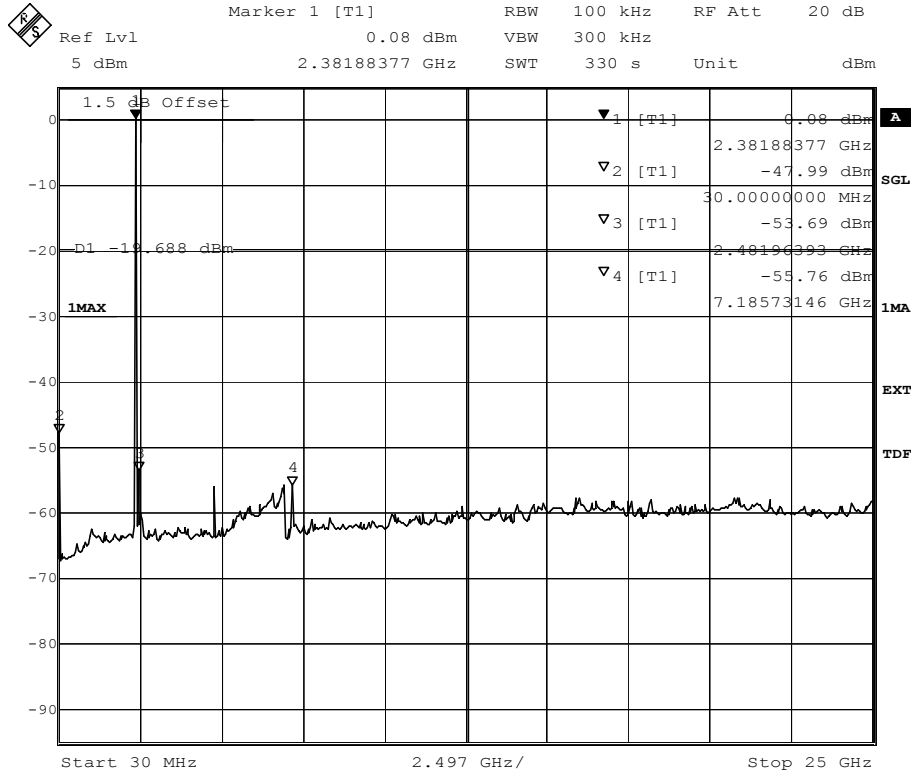

Title: spurious emissions
 Comment A: CH B: 2402 MHz
 Date: 11.AUG.2004 09:26:05

spurious emissions conducted

Spurious RF Conducted Emissions

Op. Mode

op-mode 2 Loopback mode on 2441 MHz

Setup

setup 1

Port

temporary antenna connector

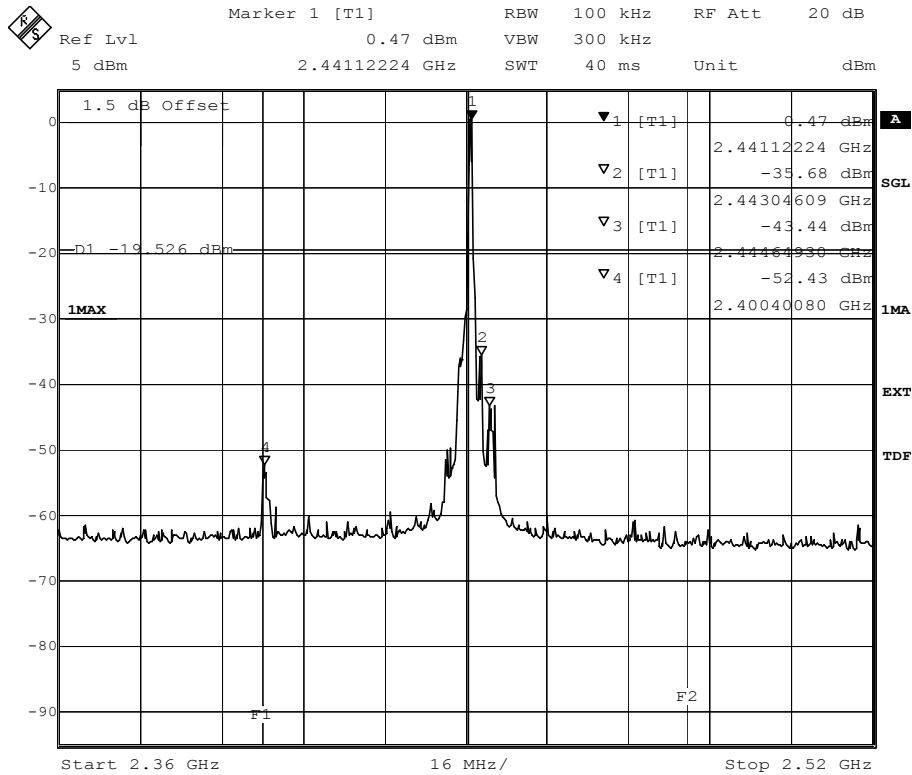

Title: Band Edge Compliance
 Comment A: CH M: 2441 MHz
 Date: 11.AUG.2004 09:04:22

Band edge compliance



Spurious RF Conducted Emissions

Op. Mode

op-mode 2 Loopback mode on 2441 MHz

Setup

setup 1

Port

temporary antenna connector

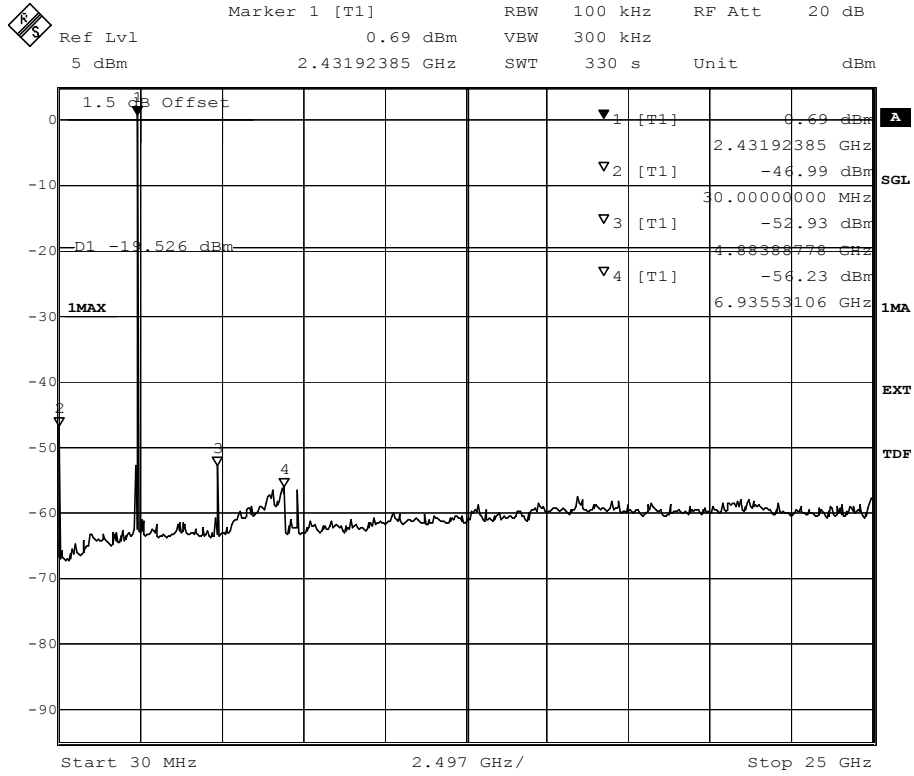

Title: spurious emissions
 Comment A: CH M: 2441 MHz
 Date: 11.AUG.2004 09:10:29

Spurious emissions



Spurious RF Conducted Emissions

Op. Mode

op-mode 3 Loopback mode on 2480 MHz

Setup

setup 1

Port

temporary antenna connector

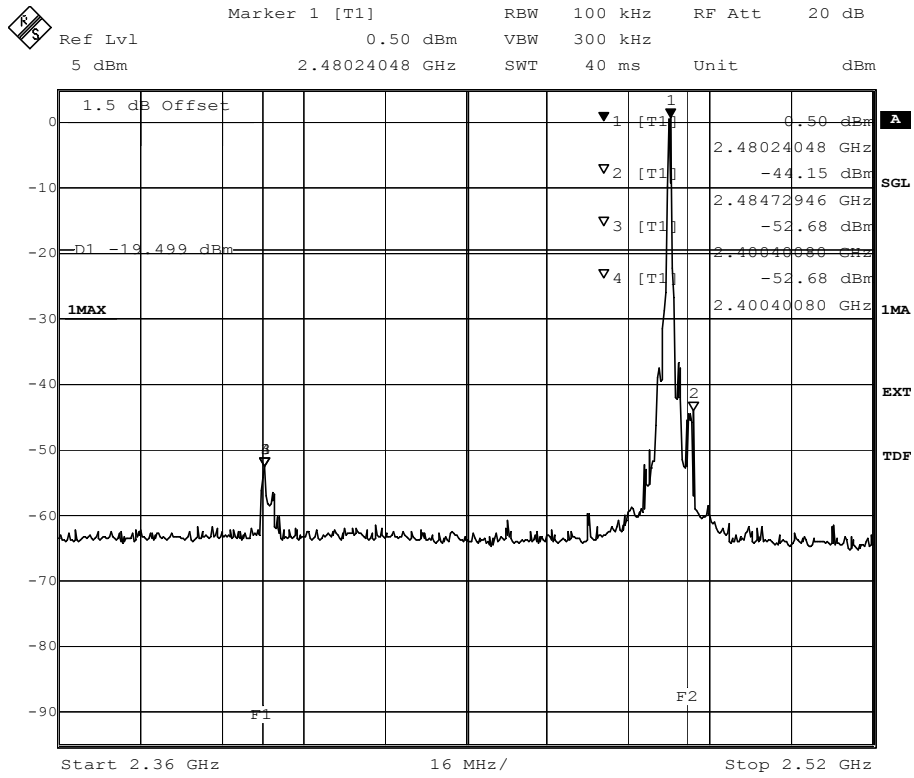

Title: Band Edge Compliance
 Comment A: CH T: 2480 MHz
 Date: 11.AUG.2004 08:46:49

Band edge compliance



Spurious RF Conducted Emissions

Op. Mode

op-mode 3 Loopback mode on 2480 MHz

Setup

setup 1

Port

temporary antenna connector

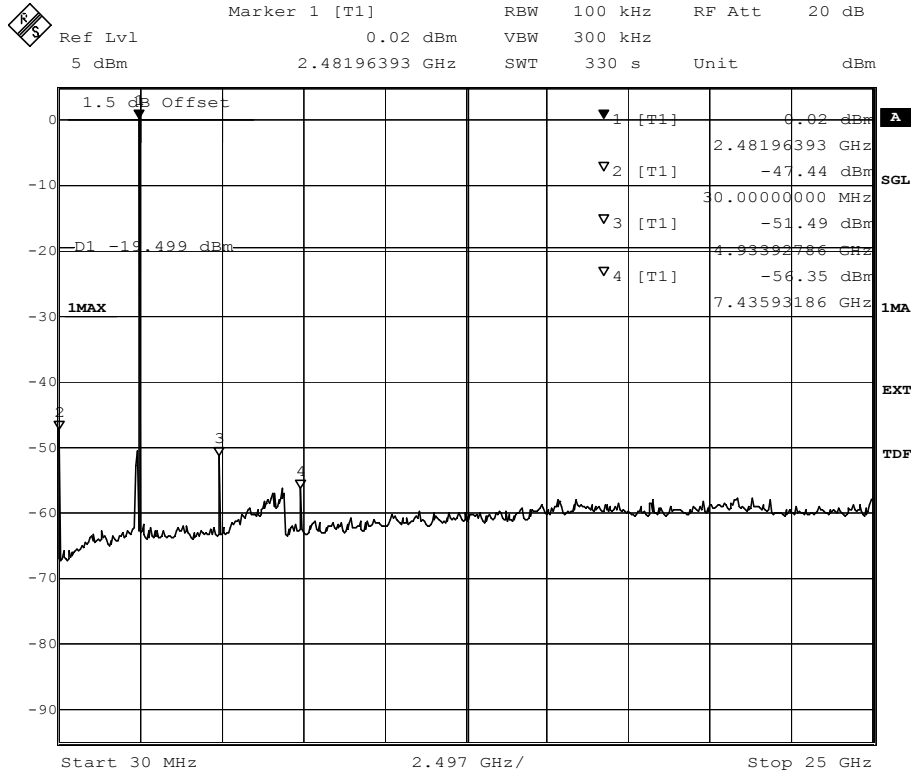

Title: spurious emissions
 Comment A: CH T: 2480 MHz
 Date: 11.AUG.2004 08:52:56

Spurious emissions



Dwell Time

Op. Mode

op-mode 4 inquiry

Setup

setup 1

Port

temporary antenna connector

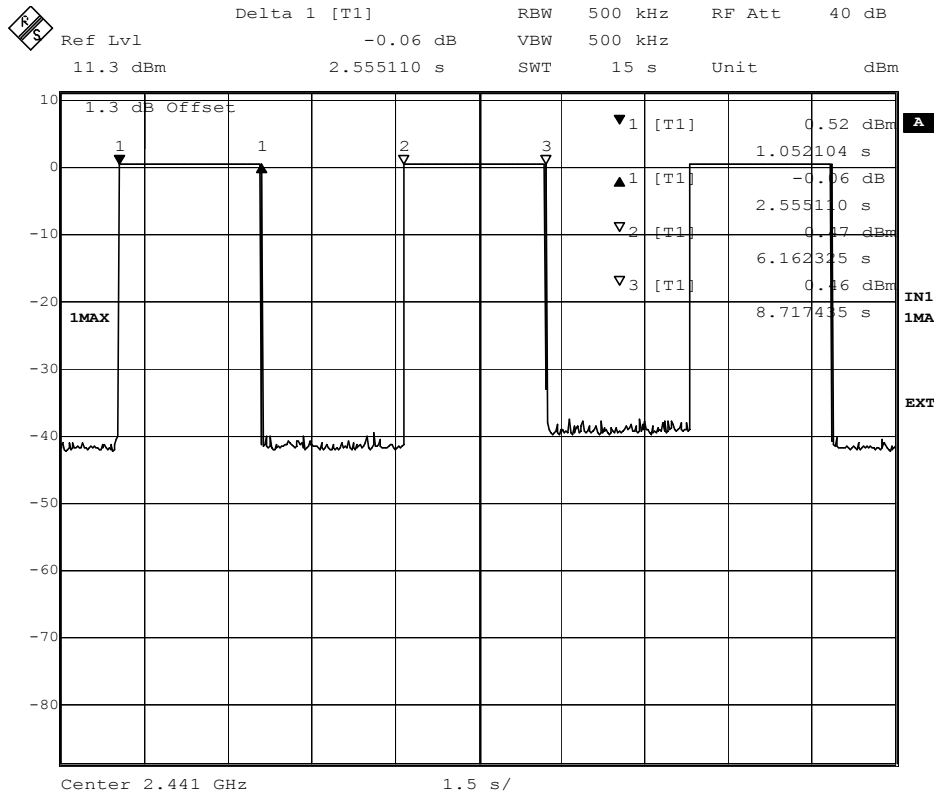

Title: WML-C29 (19022a00)
Date: 21.OCT.2004 15:10:19

15 seconds sweep for a complete inquiry

Dwell Time

Op. Mode

op-mode 4 inquiry

Setup

setup 1

Port

temporary antenna connector

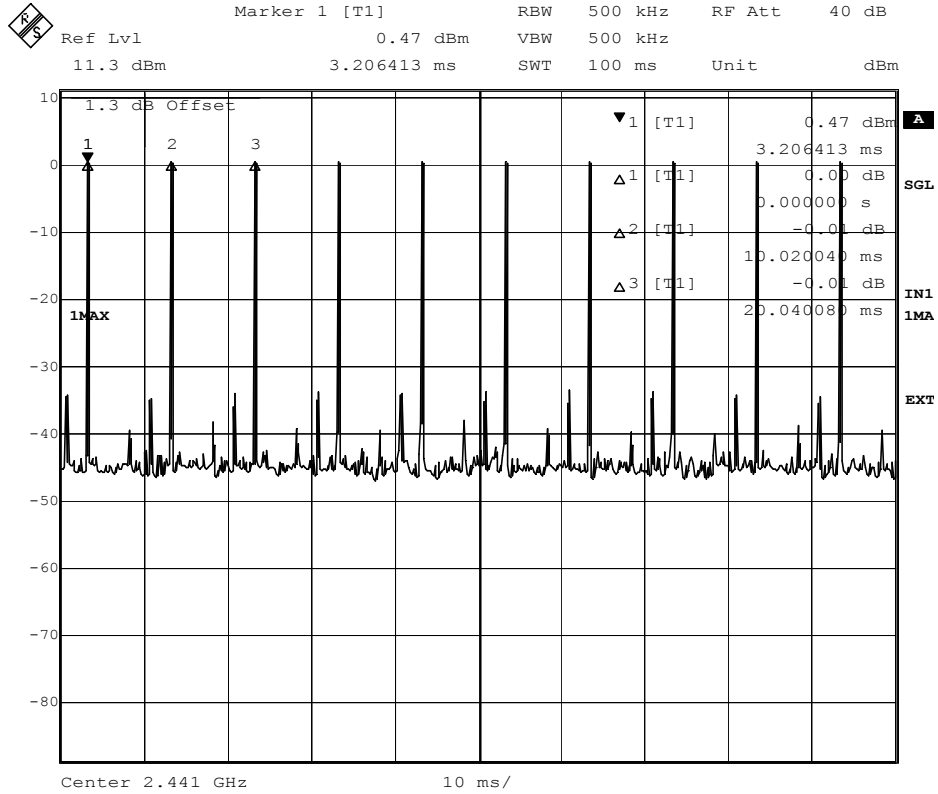

Title: WML-C29 (19022a00)
Date: 21.OCT.2004 14:34:23

100 ms sweep of a channel to determine the repetition frequency

Dwell Time

Op. Mode

op-mode 4 inquiry

Setup

setup 1

Port

temporary antenna connector

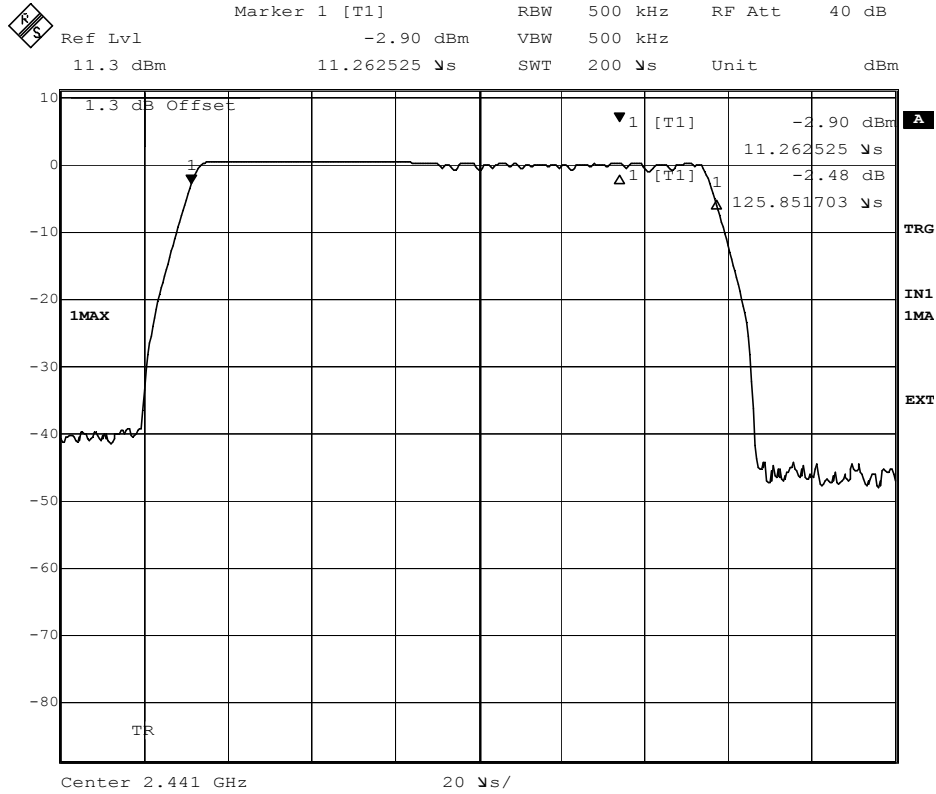

Title: WML-C29 (19022a00)
Date: 21.OCT.2004 14:38:57

200 μ s sweep for a complete burst



Dwell Time

Op. Mode

op-mode 5 paging

Setup

setup 1

Port

temporary antenna connector

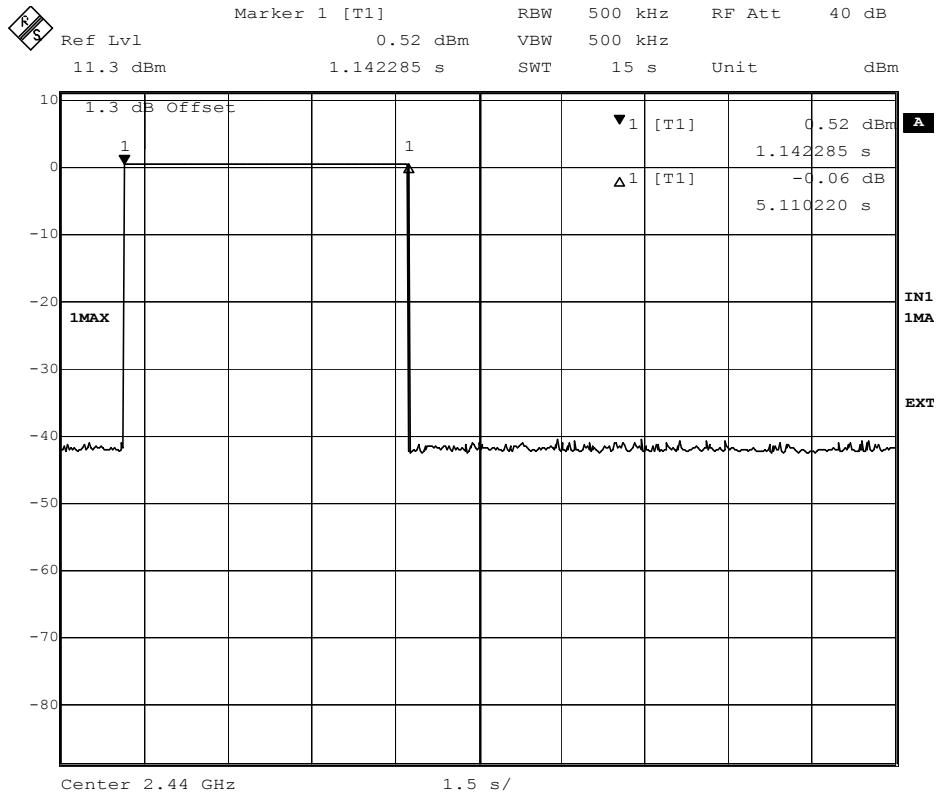

Title: WML-C29 (19022a00)
 Date: 21.OCT.2004 15:21:03

15 seconds sweep for a complete inquiry

Dwell Time

Op. Mode

op-mode 5 paging

Setup

setup 1

Port

temporary antenna connector

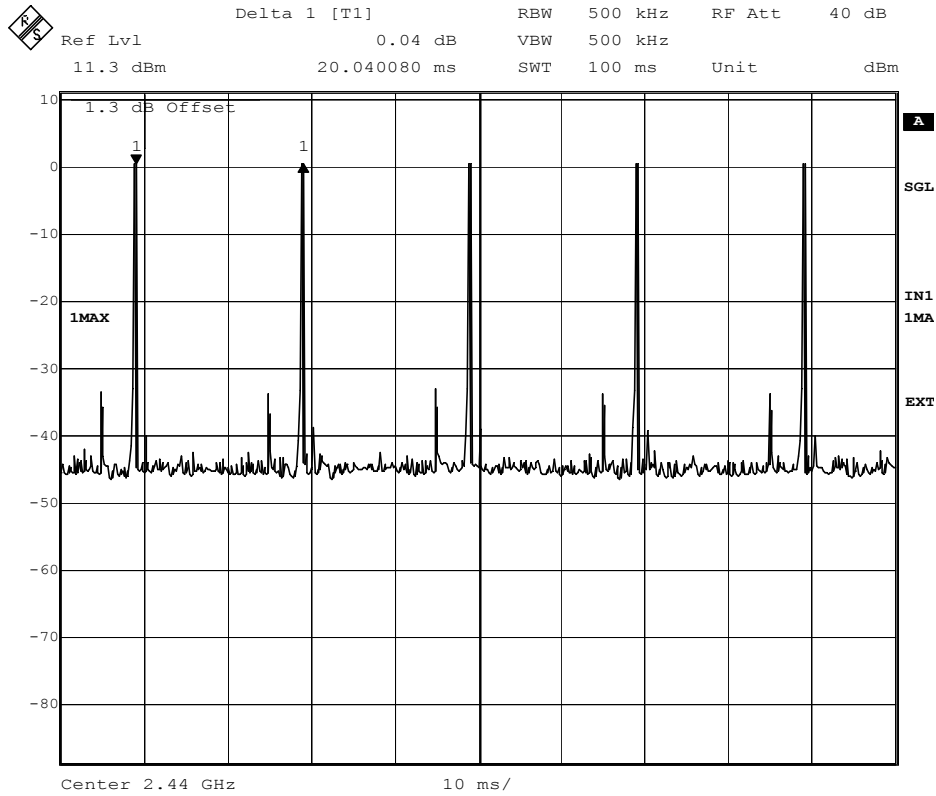

Title: WML-C29 (19022a00)
Date: 21.OCT.2004 15:22:57

100 ms sweep of a channel to determine the repetition frequency



Dwell Time

Op. Mode

op-mode 5 paging

Setup

setup 1

Port

temporary antenna connector

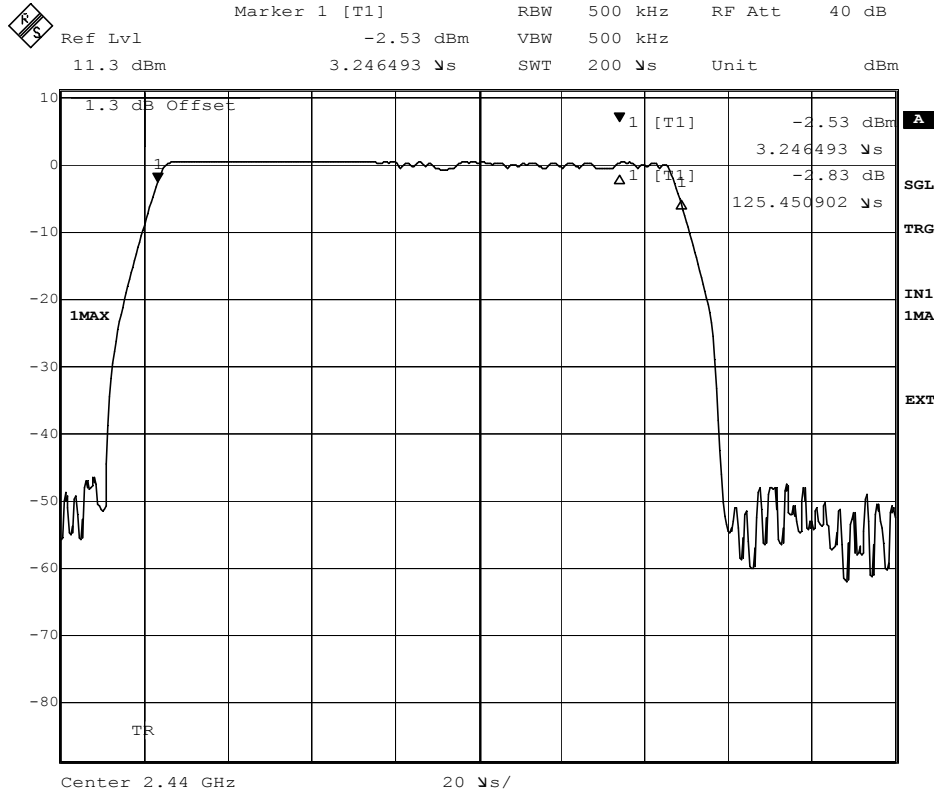

Title: WML-C29 (19022a00)
Date: 21.OCT.2004 15:24:36

200 μ s sweep for a complete burst



Power Density

Op. Mode

op-mode 4 inquiry

Setup

setup 1

Port

temporary antenna connector

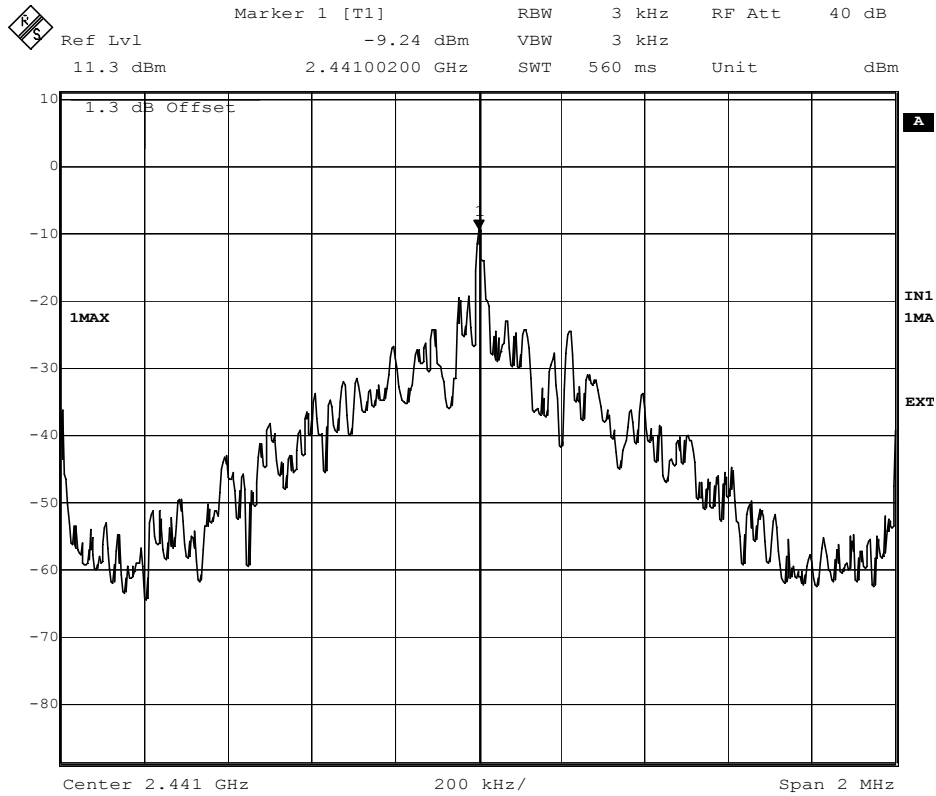

Title: WML-C29 (19022a00)
Date: 21.OCT.2004 14:45:50

power density



Power Density

Op. Mode

op-mode 5 paging

Setup

setup 1

Port

temporary antenna connector

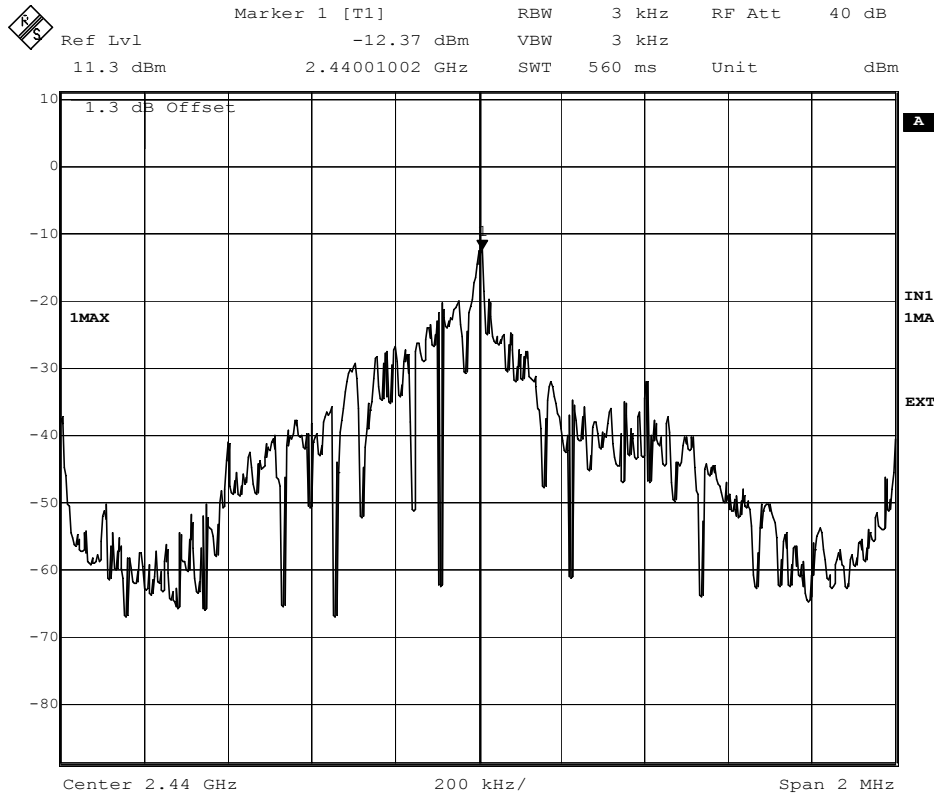

Title: WML-C29 (19022a00)
Date: 21.OCT.2004 15:29:53

power density



Channel Separation

Op. Mode

op-mode 6 10 neighbouring channels

Setup

setup 1

Port

temporary antenna connector

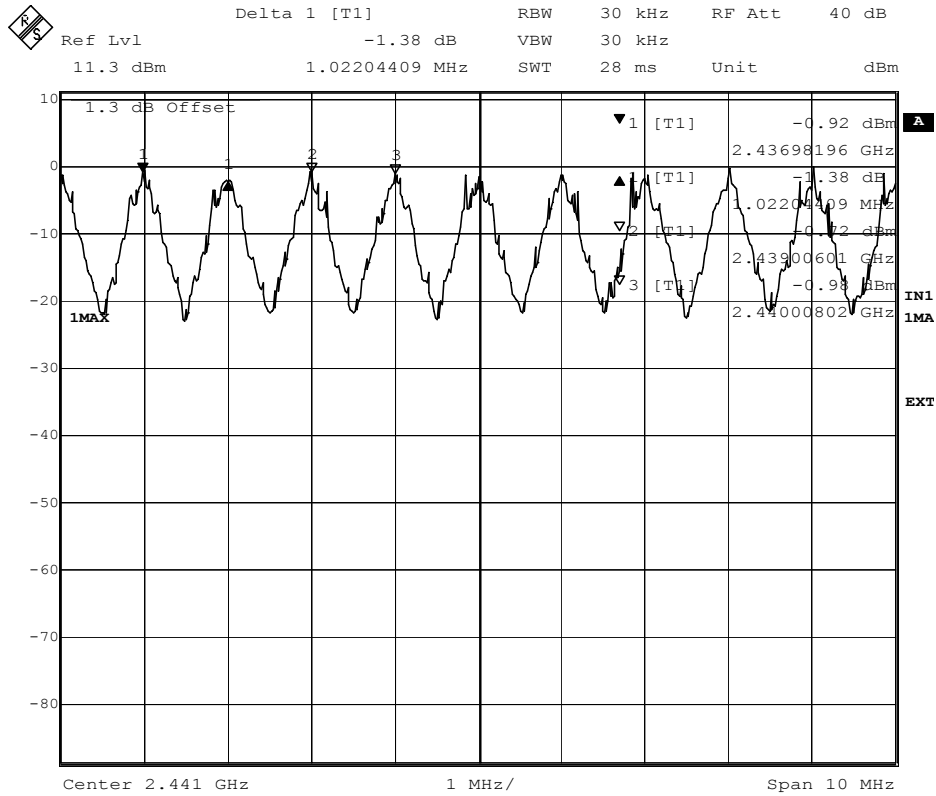

Title: WML-C29 (19022a00)
Date: 21.OCT.2004 16:15:13

channel separation