

---

# FCC Part 90 Test Report

---

Report No.: AGC092120801-2F2

**TEST NAME** : FCC Part 90  
**APPLICATION PURPOSE** : Original Equipment  
**FCC ID** : PODTH-UVF9  
**PRODUCT DESIGNATION** : Two-way Radio  
**BRAND NAME** : TYT  
**MODEL NAME** : TH-UVF9,TH-UVF10,TH-UV11,TH-UV12  
**CLIENT** : TYT ELECTRONICS CO.,LTD  
**DATE OF ISSUE** : Mar. 27, 2013  
**STANDARD(S)** : FCC Part 90 Rules

**Attestation of Global Compliance (Shenzhen) Co., Ltd.**

CAUTION: This report shall not be reproduced except in full without the written permission of the test laboratory and shall not be quoted out of context.

## VERIFICATION OF COMPLIANCE

Applicant:	TYT ELECTRONICS CO.,LTD
	Block 39-1,Optoelectronics information industry base,Nan'an,quanzhou,Fujian
Manufacturer:	TYT ELECTRONICS CO.,LTD
	Block 39-1,Optoelectronics information industry base,Nan'an,quanzhou,Fujian
Product Description:	Two-way Radio
Brand Name:	TYT
Model Name:	TH-UVF9,TH-UVF10,TH-UV11,TH-UV12
Model Difference:	All the same except for appearance and test model is TH-UVF9.
File Number:	AGC092120801-2F2
Date of Test:	Mar.19,2013 to Mar.22,2013

### We hereby certify that:

The above equipment was tested by Attestation of Global Compliance (Shenzhen) Co., Ltd. The data evaluation, test procedures, and equipment configurations shown in this report were made in accordance with the procedures given in ANSI C 63.4:2003 and TIA/EIA 603. The sample tested as described in this report is in compliance with the FCC Rules Part 90 requirements.

The test results of this report relate only to the tested sample identified in this report.

Tested By



\_\_\_\_\_  
Bart Xie Mar. 27, 2013

Reviewed By



\_\_\_\_\_  
Forrest Lei Mar. 27, 2013

Approved By

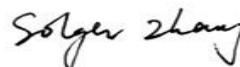

\_\_\_\_\_  
Solger Zhang Mar. 27, 2013

## TABLE OF CONTENTS

<b>1. GENERAL INFORMATION</b>	<b>4</b>
1.1 PRODUCT DESCRIPTION	4
1.3 TEST METHODOLOGY	5
1.4 TEST FACILITY	5
1.5 SPECIAL ACCESSORIES	5
1.6 EQUIPMENT MODIFICATIONS	5
<b>2. SYSTEM TEST CONFIGURATION</b>	<b>6</b>
2.1 EUT CONFIGURATION	6
2.2 EUT EXERCISE	6
2.3 GENERAL TECHNICAL REQUIREMENTS	6
2.4 CONFIGURATION OF TESTED SYSTEM	6
<b>3. SUMMARY OF TEST RESULTS</b>	<b>7</b>
<b>4. DESCRIPTION OF TEST MODES</b>	<b>8</b>
<b>5. CONDUCTED LIMITS</b>	<b>9</b>
5.1 PROVISIONS APPLICABLE	9
5.2 MEASUREMENT PROCEDURE	9
5.3 TEST SETUP BLOCK DIAGRAM	10
5.4 TEST EQUIPMENT USED	10
5.5 TEST RESULT	11
<b>6. FREQUENCY TOLERANCE</b>	<b>13</b>
6.1 PROVISIONS APPLICABLE	13
6.2 MEASUREMENT PROCEDURE	13
6.3 TEST SETUP BLOCK DIAGRAM	14
6.4 TEST EQUIPMENT USED:	14
6.5 TEST RESULT	14
<b>7. EMISSION BANDWIDTH</b>	<b>19</b>
7.1 PROVISIONS APPLICABLE	21
7.2 MEASUREMENT PROCEDURE	21
7.3 TEST SETUP BLOCK DIAGRAM	21
7.4 MEASUREMENT EQUIPMENT USED:	21
7.5 MEASUREMENT RESULT:	22
<b>8. UNWANTED RADIATION</b>	<b>23</b>
8.1 PROVISIONS APPLICABLE	24
8.2 MEASUREMENT PROCEDURE	24

8.3 TEST SETUP BLOCK DIAGRAM .....	25
8.4 MEASUREMENT EQUIPMENT USED: .....	27
8.5 MEASUREMENT RESULTS: .....	27
8.6 EMISSION MASK PLOT .....	30
<b>9. MODULATION CHARACTERISTICS .....</b>	<b>32</b>
9.1 PROVISIONS APPLICABLE .....	32
9.2 MEASUREMENT METHOD .....	32
9.3 MEASUREMENT INSTRUMENTS .....	32
9.4 MEASUREMENT RESULT .....	33
10.1 PROVISIONS APPLICABLE .....	39
10.2 TEST PROCEDURE .....	39
10.3 TEST INSTRUMENTS .....	39
10.4 TEST RESULT .....	40
10.4 CONDUCT SPURIOUS PLOT .....	41
<b>11. TRANSMITTER FREQUENCY BEHAVIOR .....</b>	<b>43</b>
11.1 PROVISIONS APPLICABLE .....	43
11.2 TEST METHOD .....	43
11.3 TEST INSTRUMENTS .....	43
<b>12. RADIATED EMISSION ON RECEIVING MODE .....</b>	<b>48</b>
12.1 PROVISIONS APPLICABLE .....	48
12.2 TEST METHOD .....	48
12.3 TEST INSTRUMENTS .....	48
12.4 MEASURE RESULT (MEASURED AT 3M USING FCC PART15 B LIMITS) .....	49
<b>13. AUDIO LOW PASS FILTER RESPONSE .....</b>	<b>51</b>
13.1 LIMITS .....	51
13.2. METHOD OF MEASUREMENTS .....	51
13.3 TEST DATA .....	51
<b>APPENDIX I .....</b>	<b>54</b>
<b>PHOTOGRAPHS OF SETUP .....</b>	<b>54</b>
<b>APPENDIX II .....</b>	<b>56</b>
<b>EXTERNAL VIEW OF EUT .....</b>	<b>56</b>

## 1. GENERAL INFORMATION

### 1.1 PRODUCT DESCRIPTION

The EUT is a single channel Two-way Radio designed for voice communication. It is designed by way of utilizing the FM modulation achieves the system operating.

A major technical description of EUT is described as following:

Communication Type	Voice / Tone only
Modulation	FM
Emission Type	F3E
Channel Separation:	12.5KHz
Emission Bandwidth	11.25KHz
Peak Frequency Deviation	1.83KHz
Audio Frequency Response	4KHz
Maximum Transmitter Power	36.45dBm
Antenna Designation	Detachable
Power Supply	DC 7.4V,2000mA by battery
Limiting Voltage	DC 6.29V
Operation Frequency Range and Channel	Frequency Range: 136~174MHz and 400~ 470MHz Channel Separation: 12.5KHz
	136 to 174MHz, Bottom Channel:136.025MHz Centre Channel:155.225 Top Channel:173.975  400MHz to 470MHz Bottom Channel: 400.025MHz, Centre Channel: 435.325MHz, Top Channel: 469.975MHz,
Frequency Tolerance	1.908ppm

## **1.2 RELATED SUBMITTAL(S) / GRANT (S)**

This submittal(s) (test report) is intended for **FCC ID: PODTH-UVF9**, filing to comply with the FCC Part 90 requirements.

## **1.3 TEST METHODOLOGY**

The radiated emission testing was performed according to the procedures of ANSI C 63.4: 2009; TIA/EIA 603 and FCC CFR 47 Rules of 2.1046, 2.1047, 2.1049, 2.1051, 2.1053, 2.1055, 2.1057.

## **1.4 TEST FACILITY**

The test site used to collect the radiated data is located on the address of Attestation of Global Compliance (Shenzhen) Co., Ltd. 2F., No.2 Building, Huafeng No.1 Technical Industrial Park, Sanwei, Xixiang, Baoan District, Shenzhen. The test site is constructed and calibrated to meet the FCC requirements in documents ANSI C63.4: 2003 .

FCC register No.: 259865

## **1.5 SPECIAL ACCESSORIES**

Not available for this EUT intended for grant.

## **1.6 EQUIPMENT MODIFICATIONS**

Not available for this EUT intended for grant.

## 2. SYSTEM TEST CONFIGURATION

### 2.1 EUT CONFIGURATION

The EUT configuration for testing is installed on RF field strength measurement to meet the Commission's requirement and operating in a manner which intends to maximize its emission characteristics in a continuous normal application.

### 2.2 EUT EXERCISE

The Transmitter was operated in the normal operating mode. The TX frequency was fixed which was for the purpose of the measurements.

### 2.3 GENERAL TECHNICAL REQUIREMENTS

- (1). Section 15.207: Conducted Limits
- (2). Section 90.205: Maximum ERP is dependent upon the station's antenna HAAT and required service area
- (3). Section 90.207: Modulation Characteristic
- (4). Section 90.209: Occupied Bandwidth
- (5). Section 90.210: Emission Mask
- (6). Section 90.213: Frequency Tolerance
- (7). Section 90.214: Transient Frequency Behavior
- (8). Section 15.109: Radiated Emission

### 2.4 CONFIGURATION OF TESTED SYSTEM

Fig. 2-1 Configuration of Tested System



Table 2-1 Equipment Used in Tested System

Item	Equipment	Model No.	Identifier	Note
1	Two-way Radio	TH-UVF9	FCC ID: PODTH-UVF9	EUT
2	Charger	N/A	N/A	Accessory
3	Battery	BP1L	N/A	Accessory

### 3. SUMMARY OF TEST RESULTS

<b>FCC Rules</b>	<b>Description Of Test</b>	<b>Result</b>
§15.107	Conducted Emission	Compliant
§90.205	Maximum Transmitter Power	Compliant
§90.207	Modulation Characteristic	Compliant
§90.209	Occupied Bandwidth	Compliant
§90.210	Emission Mask	Compliant
§90.213	Frequency Tolerance	Compliant
§90.214	Transient Frequency Behavior	Compliant
§15.109	Radiated Emission	Compliant



## 4. DESCRIPTION OF TEST MODES

### RF TEST MODES

The EUT (Handheld two way radio) has been tested under normal operating condition.

(The top channel, the middle channel and the bottom channel) are chosen for testing at each channel separation (12.5 KHz).

No.	TEST MODES	CHANNEL SEPARATION
1	Low Channel	12.5 KHz
2	Middle Channel	12.5 KHz
3	High Channel	12.5 KHz

**Note:** Above modes have been tested in two frequency range.

### EMC TEST MODES

No.	TEST MODES
1	Standby Mode + (Charging)

**Note:** only the result of the worst case was recorded in the report.

## 5. CONDUCTED LIMITS

### 5.1 PROVISIONS APPLICABLE

For an intentional radiator that is designed to be connected to the public utility (AC) power line, the, the radio frequency voltage that is conducted back onto the AC power line on any frequencies within the band 150 KHz to 30 MHz shall not exceed the limits in the following table, as measured using a 50uH/50 ohms line impedance stabilization network (LISN). Compliance with the provisions of this paragraph shall be based on the measurement of the radio frequency voltage between each power line and ground at the power terminal. The lower limit applies at the boundary between the frequencies ranges.

Frequency of Emission (MHz)	Conducted Limit(dBuV)	
	Quasi-Peak	Average
0.15 – 0.5	66 to 56 *	56 to 46 *
0.5 – 5	56	46
5 – 30	60	50

\* Decreases with the logarithm of the frequency.

### 5.2 MEASUREMENT PROCEDURE

- (1) The equipment was set up as per the test configuration to simulate typical actual usage per the user's manual. When the EUT is a tabletop system, a wooden table with a height of 0.8 meters is used and is placed on the ground plane as per ANSI C63.4 (see Test Facility for the dimensions of the ground plane used). When the EUT is a floor-standing equipment, it is placed on the ground plane which has a 3-12 mm non-conductive covering to insulate the EUT from the ground plane.
- (2) Support equipment, if needed, was placed as per ANSI C63.4.
- (3) All I/O cables were positioned to simulate typical actual usage as per ANSI C63.4.
- (4) The EUT received AC120V/60Hz power through a Line Impedance Stabilization Network (LISN) which supplied power source and was grounded to the ground plane.
- (5) All support equipments received AC power from a second LISN, if any.
- (6) The EUT test program was started. Emissions were measured on each current carrying line of the EUT using a spectrum Analyzer / Receiver connected to the LISN powering the EUT. The LISN has two monitoring points: Line 1 (Hot Side) and Line 2 (Neutral Side). Two scans were taken: one with Line 1 connected to Analyzer / Receiver and Line 2 connected to a 50 ohm load; the second scan had Line 1 connected to a 50 ohm load and Line 2 connected to the Analyzer / Receiver.
- (7) Analyzer / Receiver scanned from 150 KHz to 30MHz for emissions in each of the test modes.  
During the above scans, the emissions were maximized by cable manipulation.

### 5.3 TEST SETUP BLOCK DIAGRAM

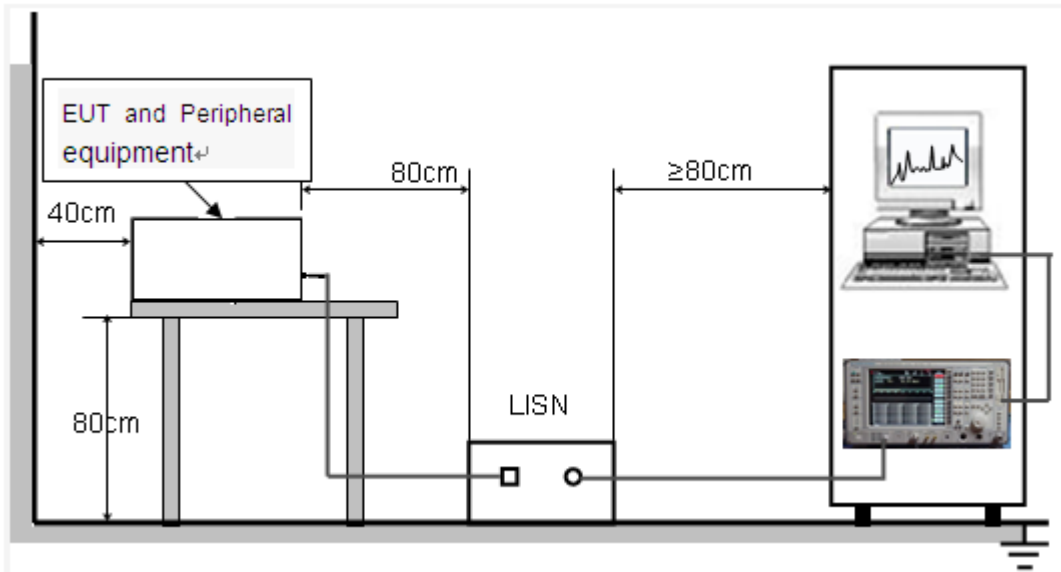

### 5.4 TEST EQUIPMENT USED

Conducted Emission Test Site				
Name of Equipment	Manufacturer	Model	Serial Number	Cal. Date
TEST RECEIVER	R&S	ESCI	N/A	2013.07.17
LISN	R&S	ESH3-Z5	N/A	2013.07.17

### 5.5 TEST RESULT

#### LINE CONDUCTED EMISSION TEST-L Conducted Emission Measurement

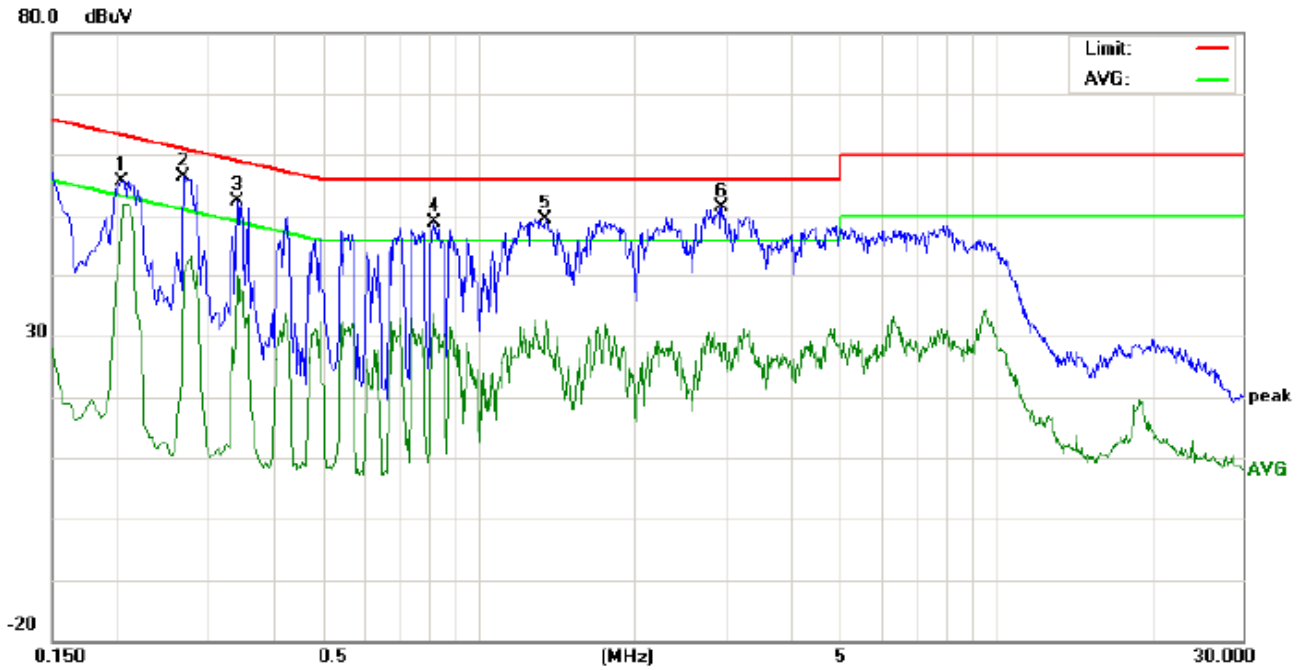

Site: Conduction  
Limit: FCC Class B Conduction(QP)  
EUT: TWO-Way radio  
M/N: TH-UVF9  
Mode: Charging  
Note:

Phase: **L1**  
Power:  
Temperature: 26  
Humidity: 60 %

No.	Freq. (MHz)	Reading_Level (dBuV)			Correct Factor (dB)	Measurement (dBuV)			Limit (dBuV)		Margin (dB)		P/F	Comment
		Peak	QP	AVG		Peak	QP	AVG	QP	AVG	QP	AVG		
1	0.2039	45.53		36.89	10.22	55.75		47.11	63.45	53.45	-7.70	-6.34	P	
2	0.2700	46.03		30.43	10.28	56.31		40.71	61.12	51.12	-4.81	-10.41	P	
3	0.3420	42.16		29.54	10.31	52.47		39.85	59.15	49.15	-6.68	-9.30	P	
4	0.8220	38.49		21.80	10.31	48.80		32.11	56.00	46.00	-7.20	-13.89	P	
5	1.3500	39.00		21.73	10.38	49.38		32.11	56.00	46.00	-6.62	-13.89	P	
6	2.9580	40.87		15.32	10.54	51.41		25.86	56.00	46.00	-4.59	-20.14	P	



## 6. FREQUENCY TOLERANCE

### 6.1 PROVISIONS APPLICABLE

- a). According to FCC Part 2 Section 2.1055(a)(1), the frequency stability shall be measured with variation of ambient temperature from  $-30^{\circ}\text{C}$  to  $+50^{\circ}\text{C}$  centigrade.
- b). According to FCC Part 2 Section 2.1055(d)(2), for battery powered equipment, the frequency stability shall be measured with reducing primary supply voltage to the battery operating end point, which is specified by the manufacturer.
- c). According to FCC Part 90 Section 90.213, the frequency tolerance must be maintained within 2.5 ppm in the 421–512 MHz band.

### 6.2 MEASUREMENT PROCEDURE

#### 6.2.1 Frequency stability versus environmental temperature

1. Setup the configuration per figure 1 for frequencies measurement inside an environment chamber, Install new battery in the EUT.
2. Turn on EUT and set SA center frequency to the EUT radiated frequency. Set SA Resolution Bandwidth to 1 KHz and Video Resolution Bandwidth to 1 KHz and Frequency Span to 50KHz. Record this frequency as reference frequency.
3. Set the temperature of chamber to  $50^{\circ}\text{C}$ . Allow sufficient time (approximately 30 min) for the temperature of the chamber to stabilize. While maintaining a constant temperature inside the chamber, turn the EUT on and measure the EUT operating frequency.
4. Repeat step 2 with a  $10^{\circ}\text{C}$  decreased per stage until the lowest temperature  $-30^{\circ}\text{C}$  is measured, record all measured frequencies on each temperature step.

#### 6.2.2 Frequency stability versus input voltage

1. Setup the configuration per figure 1 for frequencies measured at temperature if it is within  $15^{\circ}\text{C}$  to  $25^{\circ}\text{C}$ . Otherwise, an environment chamber set for a temperature of  $20^{\circ}\text{C}$  shall be used. The EUT shall be powered by DC 7.4V
2. Set SA center frequency to the EUT radiated frequency. Set SA Resolution Bandwidth to 1 KHz and Video Resolution Bandwidth to 1 KHz. Record this frequency as reference frequency.
3. Supply the EUT primary voltage at the operating end point which is specified by manufacturer and record the frequency.

**6.3 TEST SETUP BLOCK DIAGRAM**

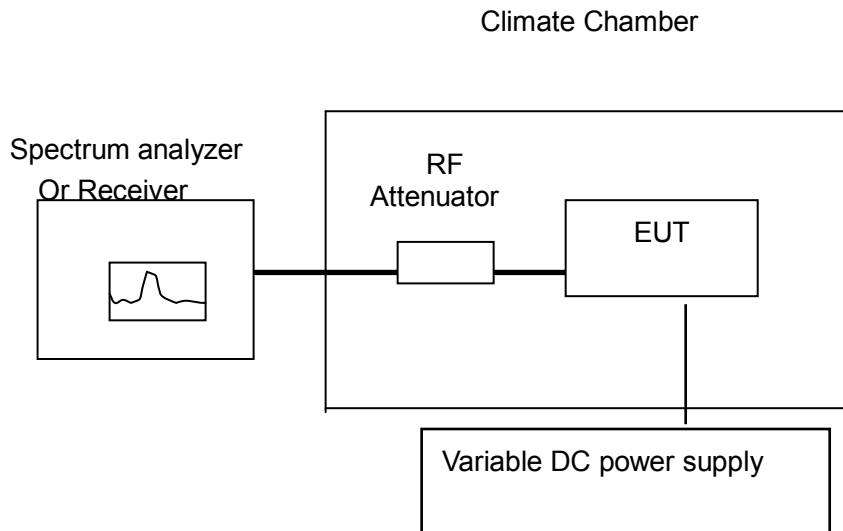

Figure 1

**6.4 TEST EQUIPMENT USED:**

NAME OF EQUIPMENT	MANUFACTURER	MODEL	SERIAL NUMBER	CAL. DATE
Receiver	R&S	ESCI	N/A	2013.07.17
Climate Chamber	EXPERY	TN-400	N/A	2013.07.17

**6.5 TEST RESULT**

(1) Frequency stability versus input voltage (Supply nominal voltage is DC 7.4V)

**For VHF BAND TEST RESULT**

**Bottom Channel @ 12.5 KHz Channel Separation**

Reference Frequency:	136.025 MHz	Limit:	2.5ppm
Environment Temperature	Power Supply	Frequency Deviation	
(°C)	(V)	(MHz)	ppm
50	DC 7.4V	136.025148	1.088
40	DC 7.4V	136.025119	0.875
30	DC 7.4V	136.025201	1.478
20	DC 7.4V	136.025152	1.117
10	DC 7.4V	136.025224	1.647
0	DC 7.4V	136.025213	1.566
-10	DC 7.4V	136.025181	1.331
-20	DC 7.4V	136.025169	1.242
-30	DC 7.4V	136.025214	1.573

**Middle Channel @ 12.5 KHz Channel Separation**

Reference Frequency:	152.225 MHz	Limit:	2.5ppm
Environment Temperature	Power Supply	Frequency Deviation	
(°C)	(V)	(MHz)	ppm
50	DC 7.4V	152.225214	1.406
40	DC 7.4V	152.225217	1.426
30	DC 7.4V	152.225224	1.472
20	DC 7.4V	152.225019	0.125
10	DC 7.4V	152.225119	0.782
0	DC 7.4V	152.225173	1.136
-10	DC 7.4V	152.225172	1.130
-20	DC 7.4V	152.225164	1.077
-30	DC 7.4V	152.225113	0.742

**Top Channel @ 12.5KHz Channel Separation**

Reference Frequency:	173.975 MHz	Limit:	2.5ppm
Environment Temperature	Power Supply	Frequency Deviation	
(°C)	(V)	(MHz)	ppm
50	DC 7.4V	173.975148	0.851
40	DC 7.4V	173.975205	1.178
30	DC 7.4V	173.975148	0.851
20	DC 7.4V	173.975264	1.517
10	DC 7.4V	173.975224	1.288
0	DC 7.4V	173.975205	1.178
-10	DC 7.4V	173.975216	1.242
-20	DC 7.4V	173.975204	1.173
-30	DC 7.4V	173.975134	0.770



**FOR UHF BAND TEST RESULT**  
**Bottom Channel @ 12.5 KHz Channel Separation**

Reference Frequency:	400.025 MHz	Limit:	2.5ppm
Environment Temperature	Power Supply	Frequency Deviation	
(°C)	(V)	(MHz)	ppm
50	DC 7.4V	400.025474	1.185
40	DC 7.4V	400.025246	0.615
30	DC 7.4V	400.025324	0.810
20	DC 7.4V	400.025251	0.627
10	DC 7.4V	400.025234	0.585
0	DC 7.4V	400.025257	0.642
-10	DC 7.4V	400.025283	0.707
-20	DC 7.4V	400.025341	0.852
-30	DC 7.4V	400.025481	1.202

**Middle Channel @ 12.5 KHz Channel Separation**

Reference Frequency:	435.325 MHz	Limit:	2.5ppm
Environment Temperature	Power Supply	Frequency Deviation	
(°C)	(V)	(MHz)	ppm
50	DC 7.4V	435.325514	1.181
40	DC 7.4V	435.325474	1.089
30	DC 7.4V	435.325335	0.770
20	DC 7.4V	435.325379	0.871
10	DC 7.4V	435.325326	0.749
0	DC 7.4V	435.325341	0.783
-10	DC 7.4V	435.325359	0.825
-20	DC 7.4V	435.325365	0.838
-30	DC 7.4V	435.325377	0.866

**Top Channel @ 12.5KHz Channel Separation**

Reference Frequency:	469.975 MHz	Limit:	2.5ppm
Environment Temperature	Power Supply	Frequency Deviation	
(°C)	(V)	(MHz)	ppm
50	DC 7.4V	469.975505	1.075
40	DC 7.4V	469.975474	1.009
30	DC 7.4V	469.975439	0.934
20	DC 7.4V	469.975412	0.877
10	DC 7.4V	469.975396	0.843
0	DC 7.4V	469.975512	1.089
-10	DC 7.4V	469.975513	1.092
-20	DC 7.4V	469.975417	0.887
-30	DC 7.4V	469.975438	0.932

(2) Frequency stability versus input voltage (Battery limiting voltage is DC 6.29V)

**FOR VHF BAND TEST RESULT**

**Bottom Channel @ 12.5 KHz Channel Separation**

Reference Frequency:	136.025 MHz	Limit:	2.5ppm
Environment Temperature	Power Supply	Frequency Deviation	
(°C)	(V)	(MHz)	ppm
50	DC 6.29V	136.025142	1.044
40	DC 6.29V	136.025167	1.228
30	DC 6.29V	136.025097	0.713
20	DC 6.29V	136.025135	0.992
10	DC 6.29V	136.025174	1.279
0	DC 6.29V	136.025182	1.338
-10	DC 6.29V	136.025194	1.426
-20	DC 6.29V	136.025147	1.081
-30	DC 6.29V	136.025183	1.345

**Middle Channel @ 12.5 KHz Channel Separation**

Reference Frequency:	152.225 MHz	Limit:	2.5ppm
Environment Temperature	Power Supply	Frequency Deviation	
(°C)	(V)	(MHz)	ppm
50	DC 6.29V	152.225214	1.406
40	DC 6.29V	152.225161	1.058
30	DC 6.29V	152.225209	1.373
20	DC 6.29V	152.225213	1.399
10	DC 6.29V	152.225204	1.340
0	DC 6.29V	152.225207	1.360
-10	DC 6.29V	152.225213	1.399
-20	DC 6.29V	152.225231	1.517
-30	DC 6.29V	152.225232	1.524

**Top Channel @ 12.5KHz Channel Separation**

Reference Frequency:	173.975 MHz	Limit:	2.5ppm
Environment Temperature	Power Supply	Frequency Deviation	
(°C)	(V)	(MHz)	ppm
50	DC 6.29V	173.975302	1.736
40	DC 6.29V	173.975224	1.288
30	DC 6.29V	173.975243	1.397
20	DC 6.29V	173.975208	1.196
10	DC 6.29V	173.975264	1.517
0	DC 6.29V	173.975243	1.397
-10	DC 6.29V	173.975315	1.811
-20	DC 6.29V	173.975332	1.908
-30	DC 6.29V	173.975314	1.805

**FOR UHF BAND TEST RESULT**

**Bottom Channel @ 12.5 KHz Channel Separation**

Reference Frequency:	400.025 MHz	Limit:	2.5ppm
Environment Temperature	Power Supply	Frequency Deviation	
(°C)	(V)	(MHz)	ppm
50	DC 6.29V	400.025433	1.082
40	DC 6.29V	400.025421	1.052
30	DC 6.29V	400.025414	1.035
20	DC 6.29V	400.025382	0.955
10	DC 6.29V	400.025356	0.890
0	DC 6.29V	400.025323	0.807
-10	DC 6.29V	400.025458	1.145
-20	DC 6.29V	400.025399	0.997
-30	DC 6.29V	400.025384	0.960

**Middle Channel @ 12.5 KHz Channel Separation**

Reference Frequency:	435.325 MHz	Limit:	2.5ppm
Environment Temperature	Power Supply	Frequency Deviation	
(°C)	(V)	(MHz)	ppm
50	DC 6.29V	435.325167	0.384
40	DC 6.29V	435.325284	0.652
30	DC 6.29V	435.325267	0.613
20	DC 6.29V	435.325251	0.577
10	DC 6.29V	435.325346	0.795
0	DC 6.29V	435.325324	0.744
-10	DC 6.29V	435.325347	0.797
-20	DC 6.29V	435.325391	0.898
-30	DC 6.29V	435.325415	0.953

**Top Channel @ 12.5KHz Channel Separation**

Reference Frequency:	469.975 MHz	Limit:	2.5ppm
Environment Temperature	Power Supply	Frequency Deviation	
(°C)	(V)	(MHz)	ppm
50	DC 6.29V	469.975457	0.972
40	DC 6.29V	469.975461	0.981
30	DC 6.29V	469.975403	0.857
20	DC 6.29V	469.975389	0.828
10	DC 6.29V	469.975431	0.917
0	DC 6.29V	469.975305	0.649
-10	DC 6.29V	469.975435	0.926
-20	DC 6.29V	469.975428	0.911
-30	DC 6.29V	469.975367	0.781

(3) Frequency stability versus input voltage (Battery Fully Charged voltage is DC 8.51V)

**FOR VHF BAND TEST RESULT**

**Bottom Channel @ 12.5 KHz Channel Separation**

Reference Frequency:	136.025 MHz	Limit:	2.5ppm
Environment Temperature	Power Supply	Frequency Deviation	
(°C)	(V)	(MHz)	ppm
50	DC 8.51V	136.025114	0.838
40	DC 8.51V	136.025097	0.713
30	DC 8.51V	136.025215	1.581
20	DC 8.51V	136.025104	0.765
10	DC 8.51V	136.025112	0.823
0	DC 8.51V	136.025141	1.037
-10	DC 8.51V	136.025134	0.985
-20	DC 8.51V	136.025143	1.051
-30	DC 8.51V	136.025148	1.088

**Middle Channel @ 12.5 KHz Channel Separation**

Reference Frequency:	152.225 MHz	Limit:	2.5ppm
Environment Temperature	Power Supply	Frequency Deviation	
(°C)	(V)	(MHz)	ppm
50	DC 8.51V	152.225114	0.749
40	DC 8.51V	152.225143	0.939
30	DC 8.51V	152.225147	0.966
20	DC 8.51V	152.225139	0.913
10	DC 8.51V	152.225138	0.907
0	DC 8.51V	152.225132	0.867
-10	DC 8.51V	152.225156	1.025
-20	DC 8.51V	152.225149	0.979
-30	DC 8.51V	152.225137	0.900

**Top Channel @ 12.5KHz Channel Separation**

Reference Frequency:	173.975MHz	Limit:	2.5ppm
Environment Temperature	Power Supply	Frequency Deviation	
(°C)	(V)	(MHz)	ppm
50	DC 8.51V	173.975246	1.414
40	DC 8.51V	173.975214	1.230
30	DC 8.51V	173.975231	1.328
20	DC 8.51V	173.975216	1.242
10	DC 8.51V	173.975205	1.178
0	DC 8.51V	173.975232	1.334
-10	DC 8.51V	173.975146	0.839
-20	DC 8.51V	173.975154	0.885
-30	DC 8.51V	173.975132	0.759

**FOR UHF BAND TEST RESULT**

**Bottom Channel @ 12.5 KHz Channel Separation**

Reference Frequency:	400.025 MHz	Limit:	2.5ppm
Environment Temperature	Power Supply	Frequency Deviation	
(°C)	(V)	(MHz)	ppm
50	DC 8.51V	400.025436	1.090
40	DC 8.51V	400.025451	1.127
30	DC 8.51V	400.025436	1.090
20	DC 8.51V	400.025374	0.935
10	DC 8.51V	400.025324	0.810
0	DC 8.51V	400.025361	0.902
-10	DC 8.51V	400.025429	1.072
-20	DC 8.51V	400.025452	1.130
-30	DC 8.51V	400.025407	1.017

**Middle Channel @ 12.5 KHz Channel Separation**

Reference Frequency:	435.325 MHz	Limit:	2.5ppm
Environment Temperature	Power Supply	Frequency Deviation	
(°C)	(V)	(MHz)	ppm
50	DC 8.51V	435.325338	0.776
40	DC 8.51V	435.325256	0.588
30	DC 8.51V	435.325231	0.531
20	DC 8.51V	435.325379	0.871
10	DC 8.51V	435.325342	0.786
0	DC 8.51V	435.325308	0.708
-10	DC 8.51V	435.325344	0.790
-20	DC 8.51V	435.325325	0.747
-30	DC 8.51V	435.325358	0.822

**Top Channel @ 12.5KHz Channel Separation**

Reference Frequency:	469.975 MHz	Limit:	2.5ppm
Environment Temperature	Power Supply	Frequency Deviation	
(°C)	(V)	(MHz)	ppm
50	DC 8.51V	469.975451	0.960
40	DC 8.51V	469.975447	0.951
30	DC 8.51V	469.975432	0.919
20	DC 8.51V	469.975383	0.815
10	DC 8.51V	469.975391	0.832
0	DC 8.51V	469.975368	0.783
-10	DC 8.51V	469.975425	0.904
-20	DC 8.51V	469.975449	0.955
-30	DC 8.51V	469.975438	0.932

## 7. EMISSION BANDWIDTH

### 7.1 PROVISIONS APPLICABLE

According to FCC Part 90 Section 90.209: The authorized bandwidth shall be 11.25 KHz for 12.5 KHz.

### 7.2 MEASUREMENT PROCEDURE

- 1). The EUT was placed on a turn table which is 0.8m above ground plane.
- 2). The EUT was modulated by 3.0 KHz Sine wave audio signal, The level of the audio signal employed is 16 dB greater than that necessary to produce 50% of rated system deviation. Rated system deviation is 2.5 kHz (12.5 kHz channel spacing) .
- 3). Set SPA Center Frequency = fundamental frequency, RBW=VBW= 300 Hz, Span =50 KHz.
- 4). Set SPA Max hold. Mark peak, -26 dB.

### 7.3 TEST SETUP BLOCK DIAGRAM

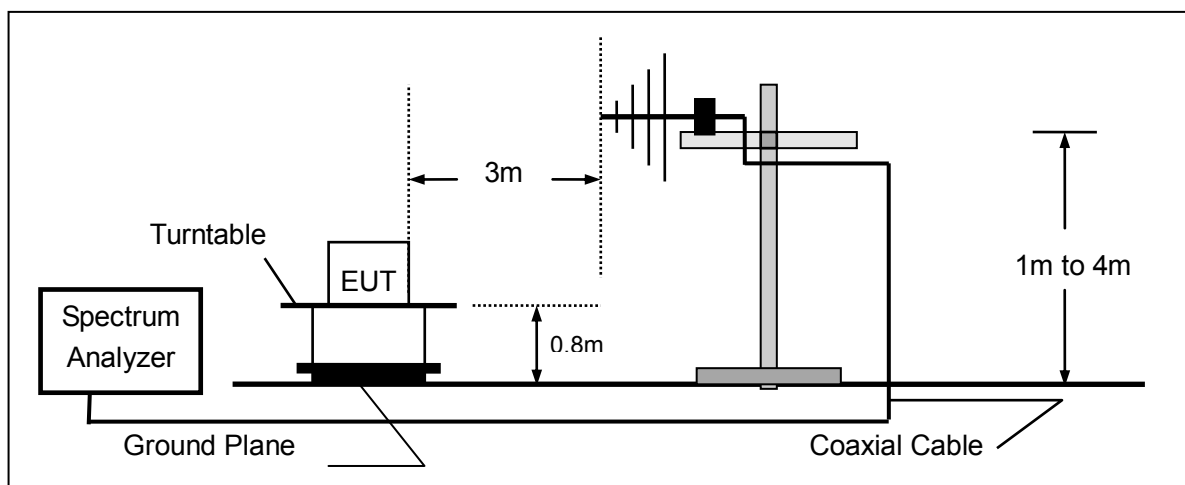

### 7.4 MEASUREMENT EQUIPMENT USED:

NAME OF EQUIPMENT	MANUFACTURER	MODEL	SERIAL NUMBER	CAL. DATE
SPECTRUM ANALYZER	AGILENT	E4440A	US44300399	2013.07.17
MODULATION ANALYZER	HP	8920B	3104A03367	2013.07.17
BROADBAND ANT.	A.H.	SAS-521-4	9163-194	2013.07.17

**7.5 MEASUREMENT RESULT:**

26 dB Bandwidth Measurement Result For VHF Band			
Operating Frequency	12.5 KHz Channel Separation		
	Test Data	Limits	Result
136.025MHz	10.693KHz	11.25 KHz	Pass
152.225MHz	10.714KHz	11.25 KHz	Pass
173.975MHz	10.702 KHz	11.25 KHz	Pass

**Occupied bandwidth of Middle Channel (Maximum)**

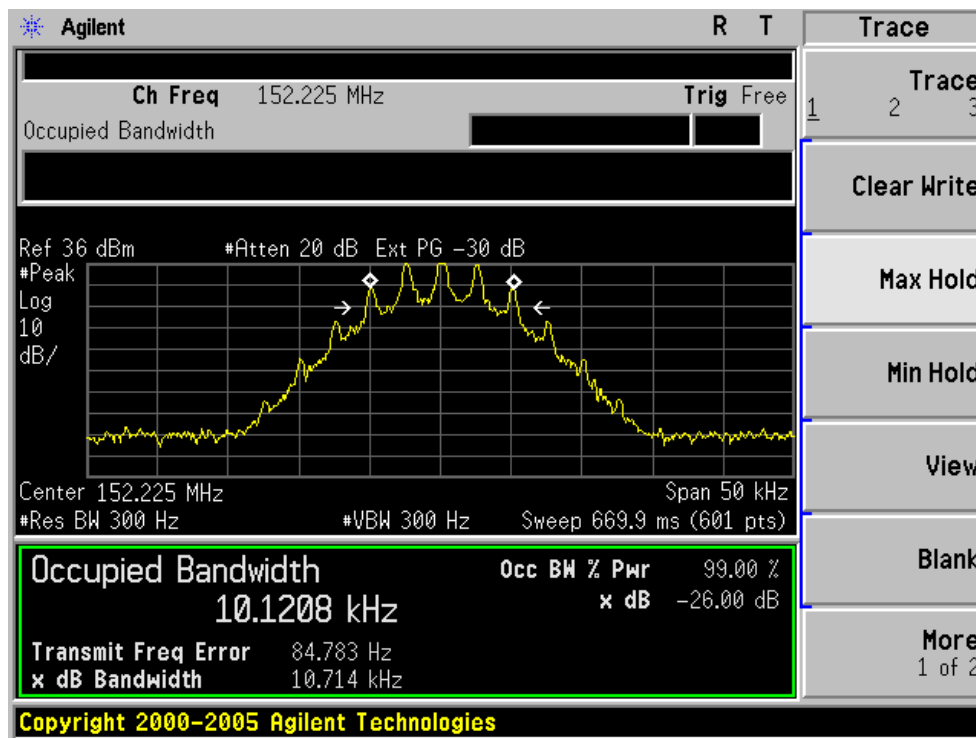

26 dB Bandwidth Measurement Result For UHF Band			
Operating Frequency	12.5 KHz Channel Separation for UHF Band		
	Test Data	Limits	Result
400.025MHz	10.654 KHz	11.25 KHz	Pass
435.325MHz	10.681KHz	11.25 KHz	Pass
469.975MHz	10.593 KHz	11.25 KHz	Pass

**Occupied bandwidth of Middle Channel (Maximum)**

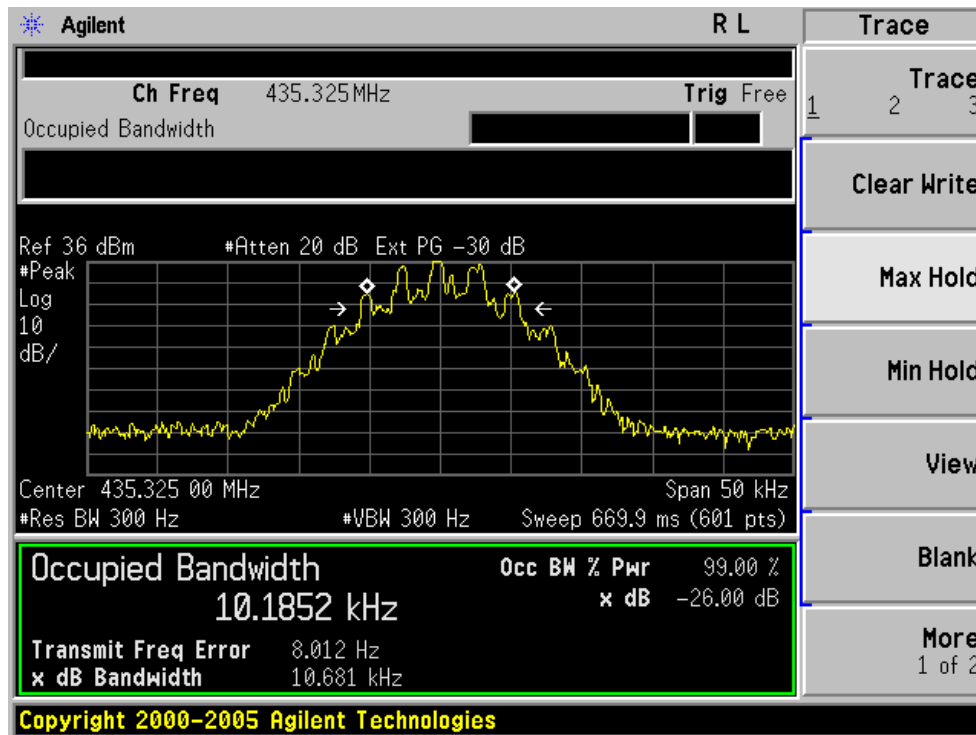



## 8. UNWANTED RADIATION

### 8.1 PROVISIONS APPLICABLE

8.1.1 According to Section 90.210, the power of each unwanted emission shall be less than Transmitted Power as specified below for transmitters designed to operate with 12.5 KHz channel bandwidth:

- (1). On any frequency removed from the center of the authorized bandwidth  $f_0$  to 5.625 KHz removed from  $f_0$ : Zero dB
- (2). On any frequency removed from the center of the authorized bandwidth by a displacement Frequency ( $f_d$  in KHz)  $f_0$  of more than 5.625 KHz but no more than 12.5 KHz: At least  $7.27(f_d - 2.88 \text{ KHz})$  dB
- (3). On any frequency removed from the center of the authorized bandwidth by a displacement Frequency ( $f_d$  in KHz)  $f_0$  of more than 12.5 KHz: At least  $50 + 10 \log(P)$  dB or 70 dB, which ever is lesser attenuation.

### 8.2 MEASUREMENT PROCEDURE

- (1) On a test site, the EUT shall be placed on a turntable and in the position closest to the normal use as declared by the user.
- (2) The test antenna shall be oriented initially for vertical polarization located 3m from the EUT to correspond to the transmitter.
- (3) The output of the antenna shall be connected to the measuring receiver and either a peak or quasi-peak detector was used for the measurement as indicated on the report. The detector selection is based on how close the emission level was approaching the limit.
- (4) The transmitter shall be switched on; if possible, without the modulation and the measurement receiver shall be tuned to the frequency of the transmitter under test.
- (5) The test antenna shall be raised and lowered through the specified range of height until the measuring receiver detects a maximum signal level.
- (6) The transmitter shall then be rotated through  $360^\circ$  in the horizontal plane, until the maximum signal level is detected by the measuring receiver.
- (7) The test antenna shall be raised and lowered again through the specified range of height until the measuring receiver detects a maximum signal level.
  
- (8) The maximum signal level detected by the measuring receiver shall be noted.
- (9) The measurement shall be repeated with the test antenna set to horizontal polarization.
- (10) Replace the antenna with a proper Antenna (substitution antenna).
- (11) The substitution antenna shall be oriented for vertical polarization and, if necessary, the length of the substitution antenna shall be adjusted to correspond to the frequency of transmitting.
- (12) The substitution antenna shall be connected to a calibrated signal generator.
- (13) If necessary, the input attenuator setting of the measuring receiver shall be adjusted in order to increase the sensitivity of the measuring receiver.
- (14) The test antenna shall be raised and lowered through the specified range of the height to ensure that the maximum signal is received.

(15)The input signal to substitution antenna shall be adjusted to the level that produces a level detected by the measuring receiver, that is equal to the level noted while the transmitter radiated power was measured, corrected for the change of input attenuation setting of the measuring receiver.

(16)The input level to the substitution antenna shall be recorded as power level in dBm, corrected for any change of input attenuator setting of the measuring receiver.

(17)The measurement shall be repeated with the test antenna and the substitution antenna oriented for horizontal polarization.

### 8.3 TEST SETUP BLOCK DIAGRAM

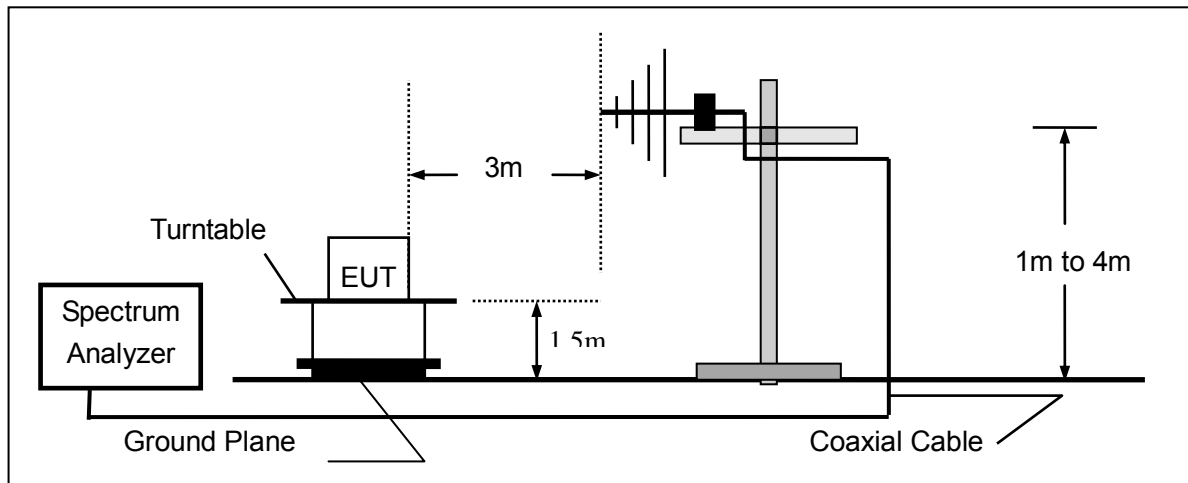

### SUBSTITUTION METHOD: (Radiated Emissions)

#### Radiated Below 1GHz

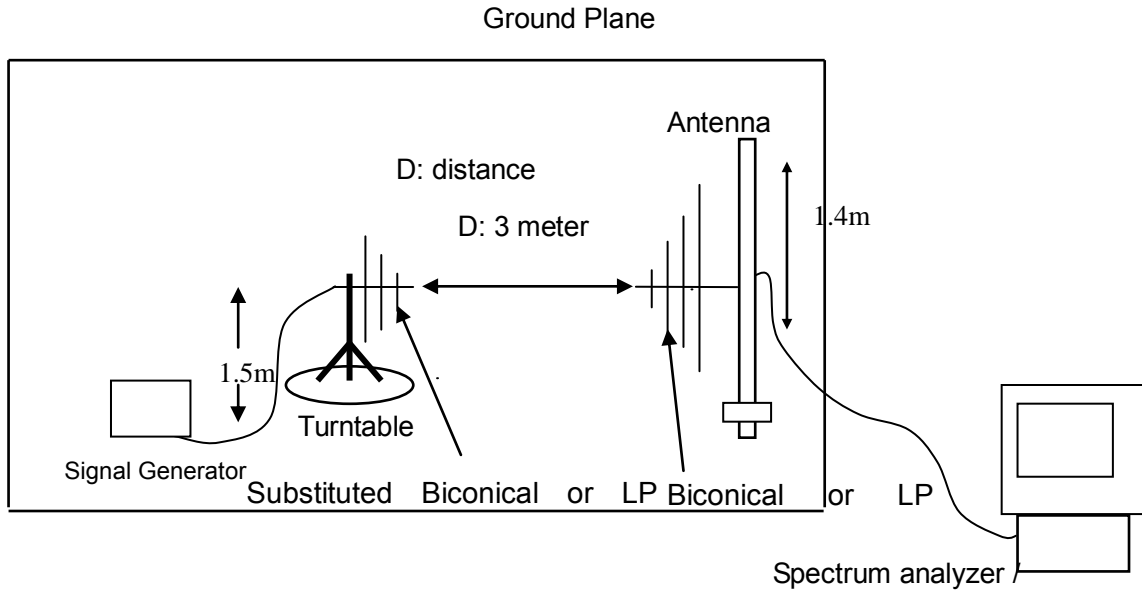

#### Radiated Above 1 GHz

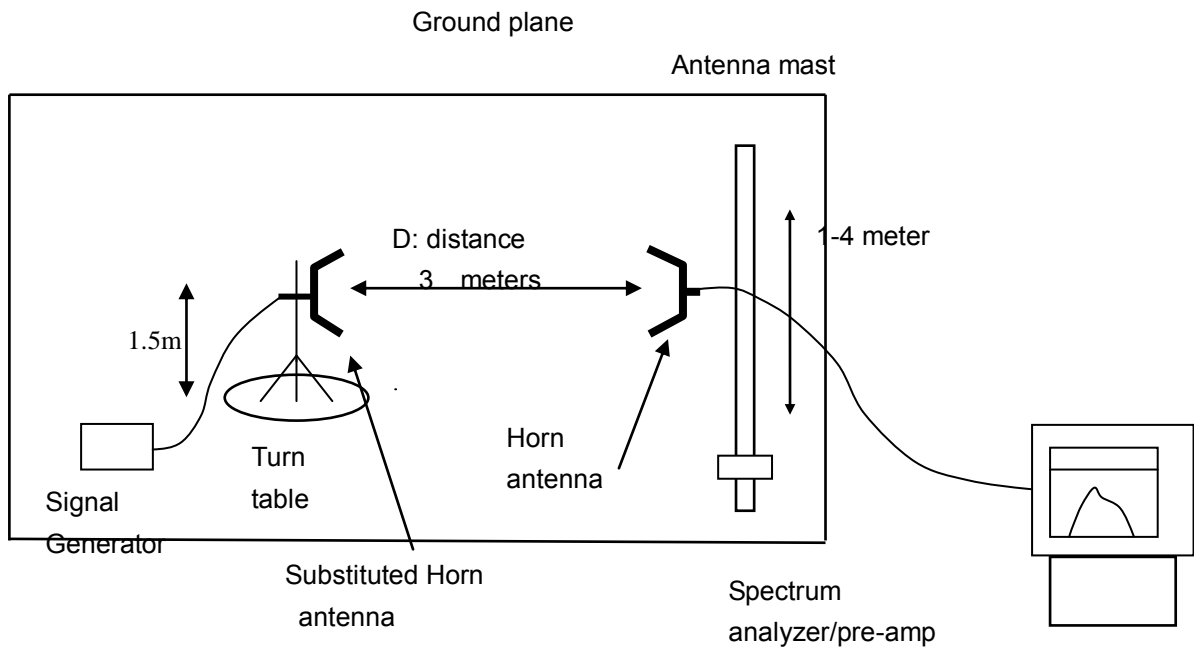

**8.4 MEASUREMENT EQUIPMENT USED:**

NAME OF EQUIPMENT	MANUFACTURER	MODEL	SERIAL NUMBER	CAL. DATE
SPECTRUM ANALYZER	AGILENT	E4440A	US44300399	2013.07.17
TEST RECEIVER	R&S	ESCI	N/A	2013.07.17
LOOP ANTENNA	A.H.	SAS-562B	N/A	2013.07.17
HORN ANTENNA	EM	EM-AH-10180	N/A	2013.07.17
BROADBAND ANT.	A.H.	SAS-521-4	N/A	2013.07.17

**8.5 MEASUREMENT RESULTS:**

**Measurement Result for 12.5 KHz Channel Separation-5W**

On any frequency removed from the center of the authorized bandwidth by a displacement Frequency ( $f_d$  in KHz)  $f_o$  of more than 12.5 KHz: At least  $50+10 \log(P)$  dB or 70 dB, which ever is lesser attenuation.

**Limit: At least  $50+10 \log(P) = 50+10\log(5)=57(\text{dBc})$**  (For VHF)

**At least  $50+10 \log(P) = 50+10\log(4)=56(\text{dBc})$**  (For UHF)

**Measurement Result for 12.5 KHz Channel Separation @ 136.025MHz**

Emission Frequency (MHz)	Ant. Polarity(H/V)	Measurement Result Below carrier(dBc)	Limit	Result(P/F)
136.025	v	0		pass
272.050	v	77.67(-40.67dBm)	57	pass
408.08	v	74.22(-37.22dBm)	57	pass
544.100	v	76.01(-39.01dBm)	57	pass
680.125	v	84.24	57	pass
816.150	v	82.78	57	pass
952.175	v	92.54	57	pass
1088.200	v	91.76	57	pass
1224.225	v	92.43	57	pass
1360.250	v	92.24	57	pass

**Measurement Result for 12.5 KHz Channel Separation @ 152.225MHz**

Emission Frequency (MHz)	Ant. Polarity(H/V)	Measurement Result Below carrier(dBc)	Limit	Result(P/F)
152.225	v	0		pass
304.450	v	75.44(-38.44dBm)	57	pass
456.675	v	79.39	57	pass
608.900	v	81.46	57	pass
761.125	v	85.65	57	pass
913.350	v	90.31	57	pass
1065.575	v	93.11	57	pass
1217.800	v	94.12	57	pass
1370.025	v	94.21	57	pass
1522.250	v	94.26	57	pass

**Measurement Result for 12.5 KHz Channel Separation @ 173.975MHz**

Emission Frequency (MHz)	Ant. Polarity(H/V)	Measurement Result Below carrier(dBc)	Limit	Result(P/F)
173.975	v	0		pass
347.950	v	76.43(-39.43dBm)	57	pass
521.925	v	83.34	57	pass
695.900	v	85.64	57	pass
869.875	v	87.27	57	pass
1043.850	v	91.65	57	pass
1217.825	v	92.15	57	pass
1391.800	v	94.21	57	pass
1565.775	v	95.21	57	pass
1739.750	v	97.22	57	pass

**Measurement Result for 12.5 KHz Channel Separation @ 400.025MHz**

Emission Frequency (MHz)	Ant. Polarity(H/V)	Measurement Result Below carrier(dBc)	Limit below carrier(dBc)	Result(P/F)
400.025	v	0		pass
800.050	v	66.73(-29.73dBm)	56	pass
1200.08	v	75.42(-38.42dBm)	56	pass
1600.100	v	78.33	56	pass
2000.125	v	81.73	56	pass
2400.150	v	84.32	56	pass
2800.175	v	85.54	56	pass
3200.200	v	88.81	56	pass
3600.225	v	90.37	56	pass
4000.250	v	90.42	56	pass

**Measurement Result for 12.5 KHz Channel Separation @ 435.325MHz**

Emission Frequency (MHz)	Ant. Polarity(H/V)	Measurement Result Below carrier(dBc)	Limit below carrier(dBc)	Result(P/F)
435.325	v	0		pass
870.650	v	72.34(-35.34dBm)	56	pass
1305.975	v	77.52	56	pass
1741.300	v	79.34	56	pass
2176.625	v	80.37	56	pass
2611.950	v	83.13	56	pass
3047.275	v	89.35	56	pass
3482.600	v	90.14	56	pass
3917.925	v	90.56	56	pass
4353.250	v	91.15	56	pass

**Measurement Result for 12.5 KHz Channel Separation @ 469.975MHz**

Emission Frequency (MHz)	Ant. Polarity(H/V)	Measurement Result Below carrier(dBc)	Limit below carrier(dBc)	Result(P/F)
469.975	v	0		pass
939.950	v	72.27(-35.27dBm)	56	pass
1409.925	v	75.63	56	pass
1879.900	v	80.56	56	pass
2349.875	v	83.42	56	pass
2819.850	v	89.75	56	pass
3289.825	v	90.27	56	pass
3759.800	v	91.33	56	pass
4229.775	v	91.72	56	pass
4699.750	v	92.16	56	pass

**Notes: The emissions were scanned from 30 MHz to 10th harmonics;**

### 8.6 EMISSION MASK PLOT

The detailed procedure employed for Emission Mask measurements are specified as following:

- The transmitter shall be modulated by a 2.5 KHz audio signal,
- The level of the audio signal employed is 16 dB greater than that necessary to produce 50% of rated system deviation. Rated system deviation is 2.5 KHz (12.5 KHz channel spacing) .

**The Worst Emission Mask for 12.5 KHz channel Separation (5W)**

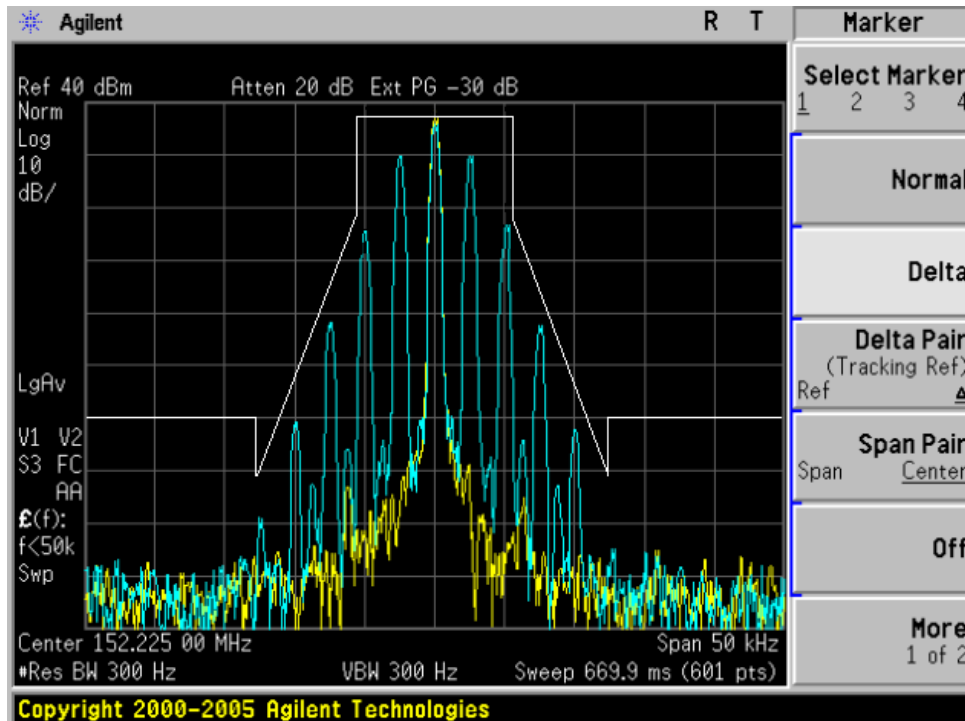

Copyright 2000-2005 Agilent Technologies

### The Worst Emission Mask for 12.5 KHz channel Separation (4W)

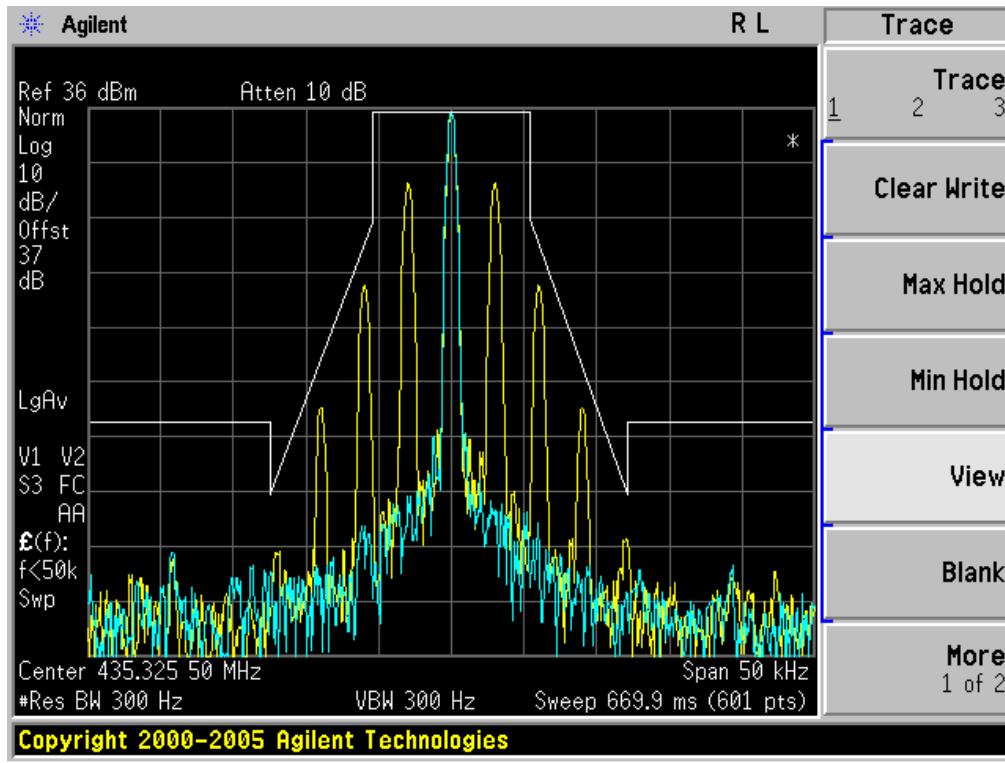



## 9. MODULATION CHARACTERISTICS

### 9.1 PROVISIONS APPLICABLE

According to CFR 47 section 2.1047(a), for Voice Modulation Communication Equipment, the frequency response of the audio modulation circuit over a range of 100 to 5000Hz shall be measured.

### 9.2 MEASUREMENT METHOD

#### 9.2.1 Modulation Limit

- (1). Configure the EUT as shown in figure 1, adjust the audio input for 60% of rated system deviation at 1KHz using this level as a reference (0dB) and vary the input level from -20 to +20dB. Record the frequency deviation obtained as a function of the input level.
- (2). Repeat step 1 with input frequency changing to 300, 1000, 1500 and 3000Hz in sequence.

#### 9.2.2 Audio Frequency Response

- (1). Configure the EUT as shown in figure 1.
- (2). Adjust the audio input for 20% of rated system deviation at 1 KHz using this level as a reference (0 dB).
- (3). Vary the Audio frequency from 100 Hz to 10 KHz and record the frequency deviation.
- (4). Audio Frequency Response =  $20\log_{10}(\text{Deviation of test frequency}/\text{Deviation of 1 KHz reference})$ .

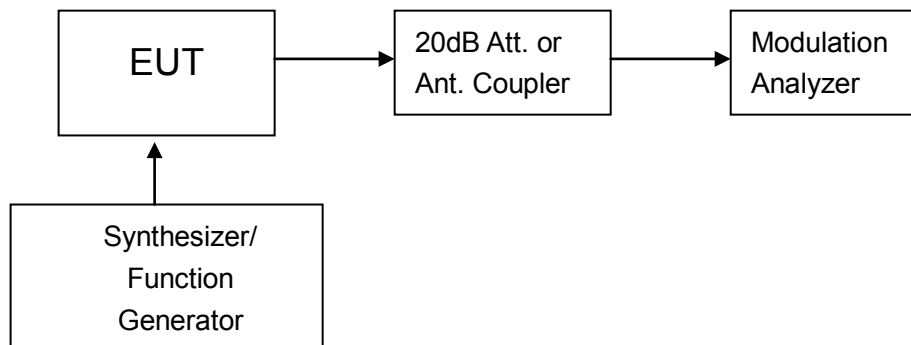

**Figure 1: Modulation characteristic measurement configuration**

### 9.3 MEASUREMENT INSTRUMENTS

NAME OF EQUIPMENT	MANUFACTURER	MODEL	SERIAL NUMBER	CAL. DATE
Modulation Analyzer	HP	8920B	N/A	2013-07-17

NOTE: 8920B can generate audio modulation frequency.

**9.4 MEASUREMENT RESULT**

**(a). Modulation Limit:**

**Middle Channel @ 12.5 KHz Channel Separations for VHF Band**

Modulation Level (dB)	Peak Freq. Deviation At 300 Hz	Peak Freq. Deviation At 1000 Hz	Peak Freq. Deviation At 1500 Hz	Peak Freq. Deviation At 3000 Hz
-20	0.27	0.75	0.82	0.87
-15	0.36	0.86	0.94	0.99
-10	0.44	1.22	1.29	1.35
-5	0.64	1.33	1.37	1.44
0	0.75	1.51	1.54	1.59
+5	0.87	1.72	1.73	1.83
+10	0.94	1.74	1.75	1.79
+15	0.82	1.68	1.73	1.75
+20	0.78	1.57	1.66	1.69

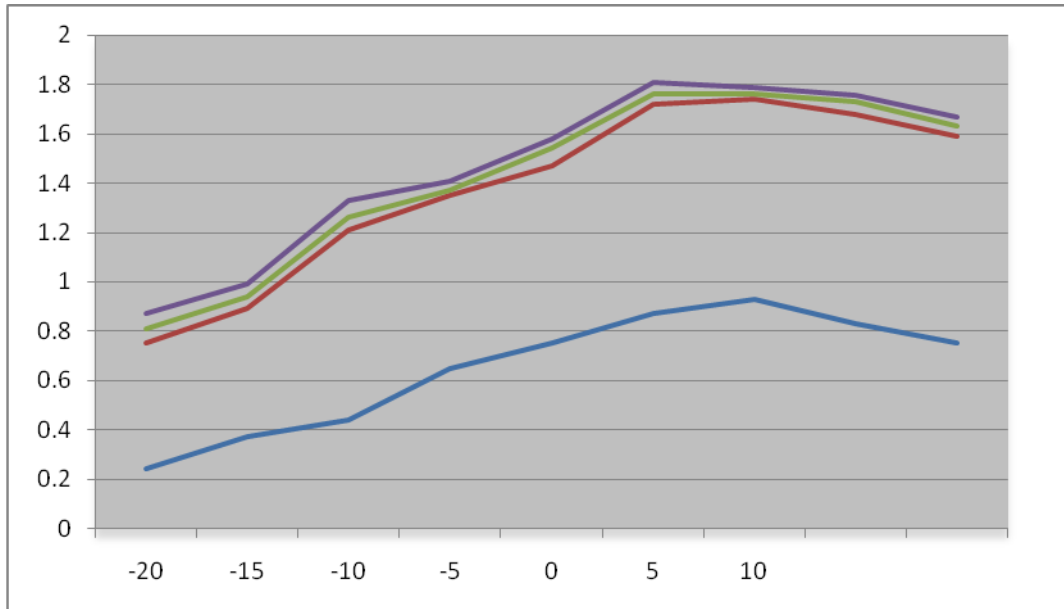

**Middle Channel @ 12.5 KHz Channel Separations for UHF Band**

Modulation Level (dB)	Peak Freq. Deviation At 300 Hz (KHz)	Peak Freq. Deviation At 1000 Hz (KHz)	Peak Freq. Deviation At 1500 Hz (KHz)	Peak Freq. Deviation At 3000 Hz (KHz)
-20	0.14	0.84	0.92	0.95
-15	0.16	0.93	0.94	0.98
-10	0.23	1.25	1.26	1.33
-5	0.33	1.35	1.37	1.44
0	0.36	1.50	1.54	1.59
5	0.45	1.77	1.77	1.81
10	0.42	1.724	1.76	1.79
15	0.35	1.68	1.72	1.75
20	0.25	1.60	1.63	1.68

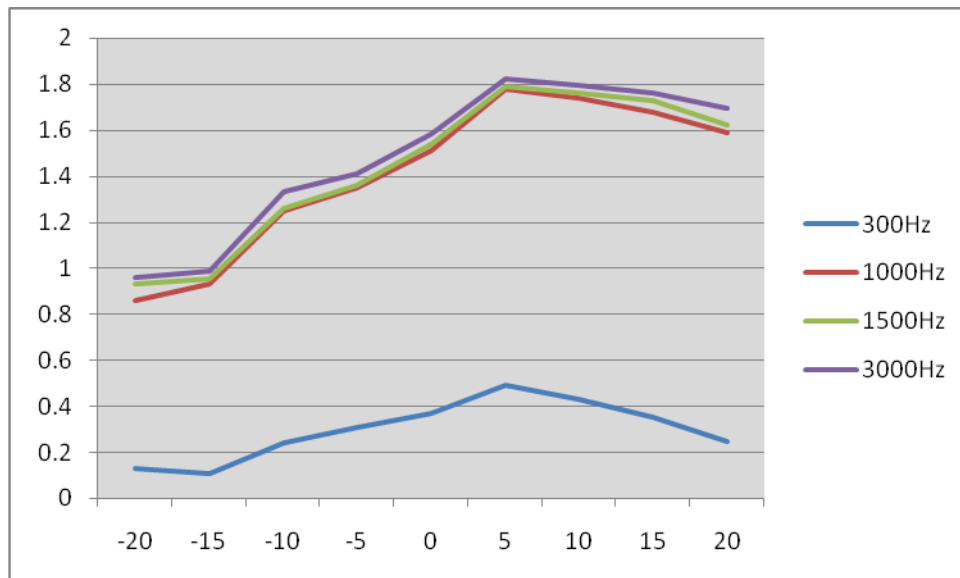

**(b). Audio Frequency Response:**

**12.5 KHz Middle Channel Separations for VHF Band**

Frequency (Hz)	Deviation (KHz)	Audio Frequency Response(dB)
100	--	--
200	--	--
300	0.13	-11.872536
400	0.22	-7.3029499
500	0.27	-5.5241282
600	0.33	-3.7811247
700	0.36	-3.0253535
800	0.41	-1.8957264
900	0.45	-1.0871532
1000	0.51	0
1200	0.52	0.16866335
1400	0.58	1.11715635
1600	0.65	2.10686361
1800	0.68	2.49877473
2000	0.73	3.11505368
2400	0.76	3.46486832
2500	0.78	3.69048853
2800	0.84	4.3341822
3000	0.87	4.63898153
3200	0.92	5.12435302
3600	0.95	5.40306858
4000	0.98	5.67311799
4500	0.78	3.69048853
5000	0.65	2.10686361
5500	0.59	1.26563671
6000	0.54	0.49647167
6500	0.04	-22.110204
7000	0.03	-24.608978
7500	0.01	-34.151404
9000	--	--
10000	--	--
14000	--	--
18000	--	--
20000	--	--
30000	--	--

**Frequency Response of Middle Channel**

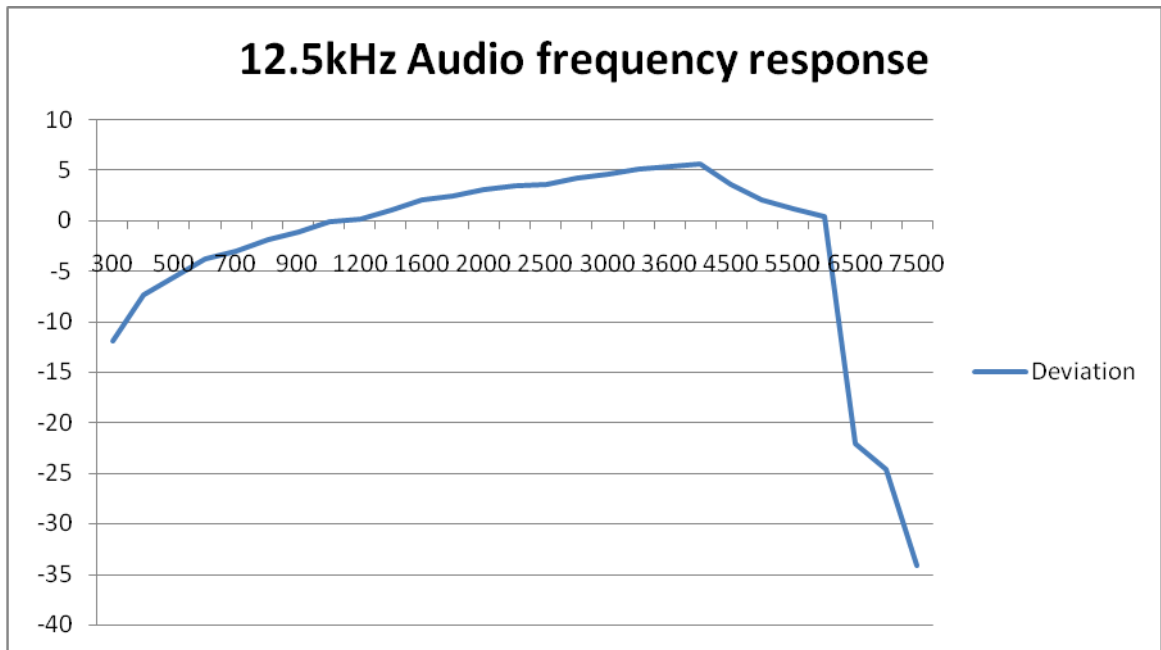

**12.5 KHz Middle Channel Separations (Worst) for UHF band**

Frequency (Hz)	Deviation (KHz)	Audio Frequency Response(dB)
100	--	--
200	--	--
300	0.14	-11.228843
400	0.17	-9.5424251
500	0.21	-7.7070176
600	0.22	-7.3029499
700	0.26	-5.8519366
800	0.32	-4.048404
900	0.43	-1.4820344
1000	0.5	-0.1720034
1200	0.55	0.65585027
1400	0.67	2.37009253
1600	0.79	3.8011383
1800	0.87	4.63898153
2000	0.96	5.49402114
2400	1.30	8.12746352
2500	1.41	8.83297873
2800	1.62	10.0388968
3000	1.74	10.6595814
3200	1.73	10.6095185
3600	1.54	9.59901089
4000	1.04	6.18926326
4500	0.824	4.16714071
5000	0.75	3.34982175
5500	0.41	-1.8957264
6000	0.13	-11.872536
6500	0.04	-22.110204
7000	0.02	-28.130804
7500	0.01	-34.151404
9000	--	--
10000	--	--
14000	--	--
18000	--	--
20000	--	--
30000	--	--

**Frequency Response of Middle Channel**

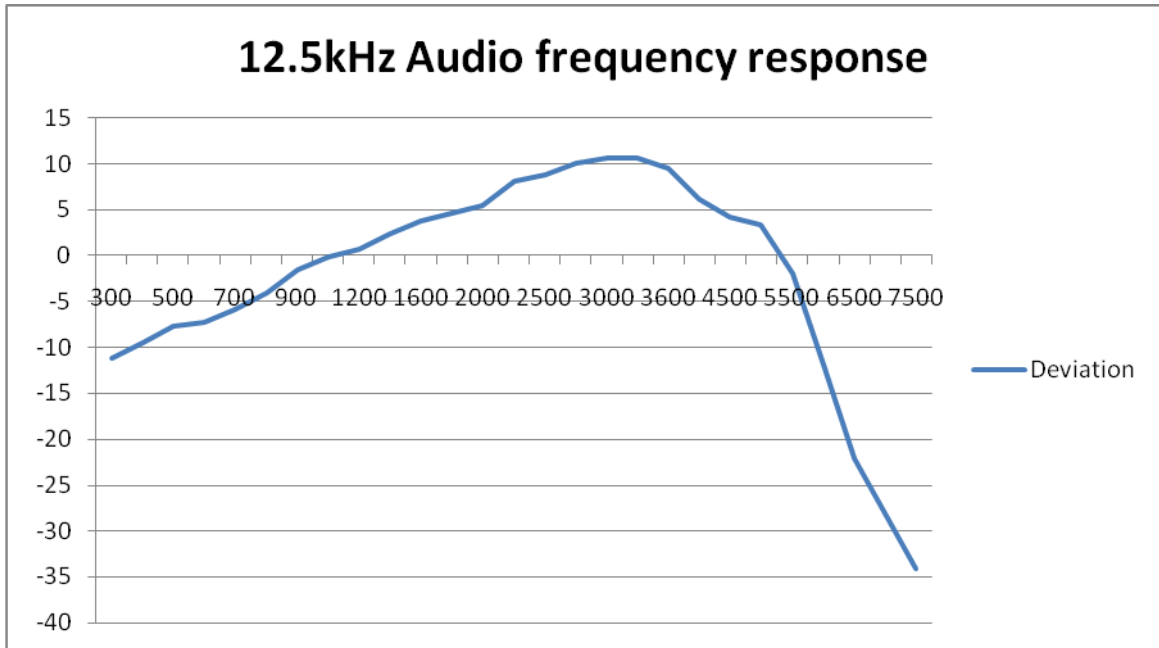

## 10. MAXIMUM TRANSMITTER POWER (CONDUCTED OUTPUT POWER) AND CONDUCTED SPURIOUS EMISSION

### 10.1 PROVISIONS APPLICABLE

Per FCC §2.1046 and §90.205: Maximum ERP is dependent upon the station's antenna HAAT and required service area.

### 10.2 TEST PROCEDURE

The RF output of Two-way Radio was connected to a spectrum analyzer through an appropriate attenuator.

The transmitter shall be modulated by a 2.5 KHz audio signal,

The level of the audio signal employed is 16 dB greater than that necessary to produce 50% of rated system deviation. Rated system deviation is 2.5 KHz (12.5 KHz channel spacing)

Measure and record the transmitter output power, using a measurement (resolution) bandwidth at least two to three times the occupied bandwidth for transmitters equipped to capture the true peak emission of the equipment under test.

### 10.3 TEST INSTRUMENTS

NAME OF EQUIPMENT	MANUFACTURER	MODEL	SERIAL NUMBER	CAL. DATE
SPECTRUM ANALYZER	AGILENT	E4440A	N/A	2013.07.17

### 10.4 TEST CONFIGURATION

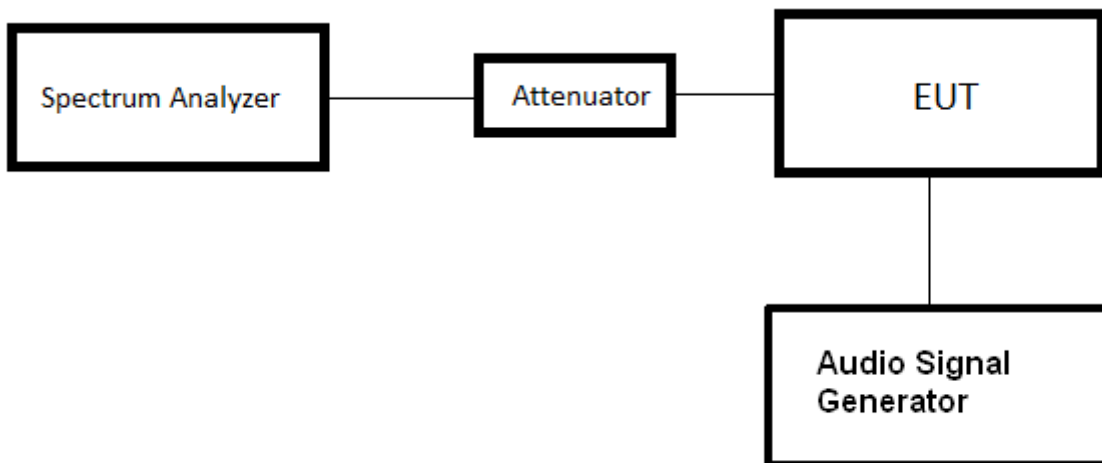



**10.5 TEST RESULT**

The maximum Conducted Power (CP) is  
5W for 12.5 KHz Channel Separation for VHF  
4W for 12.5 KHz Channel Separation for UHF

<b>Conducted Power Measurement Results</b>		
<b>Channel Separation</b>	<b>Channel</b>	<b>Measurement Result (dBm)</b>
		<b>For 36.98dBm(5W)</b>
12.5 KHz	Bottom(136.025MHz)	36.23
	Middle(152.225MHz)	36.45
	Top (173.975MHz)	35.98

<b>Conducted Power Measurement Results</b>		
<b>Channel Separation</b>	<b>Channel</b>	<b>Measurement Result (dBm)</b>
		<b>For 36.02dBm(4W)</b>
12.5 KHz	Bottom(400.025MHz)	35.64
	Middle(435.325MHz)	35.76
	Top (469.975MHz)	35.72

10.7 CONDUCT SPURIOUS PLOT

**Conducted Spurious Emission(worst) @ 152.225MHz (30MHz-1GHz)**

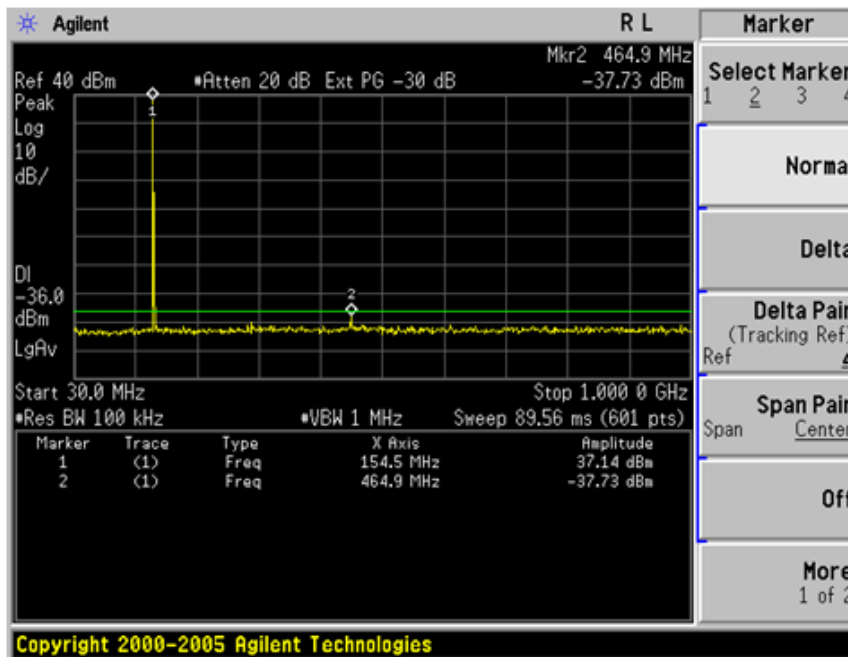

**Conduct Spurious Emission(worst) @ 152.225MHz (1GHz-12.75GHz)**

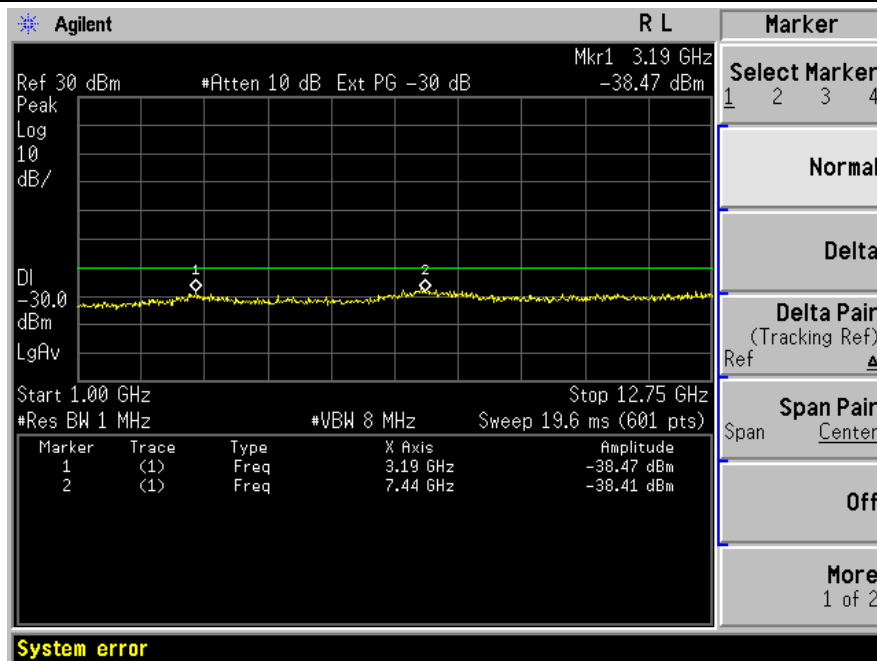

**Conducted Spurious Emission(worst) @ 435.325MHz (30MHz-1GHz)**

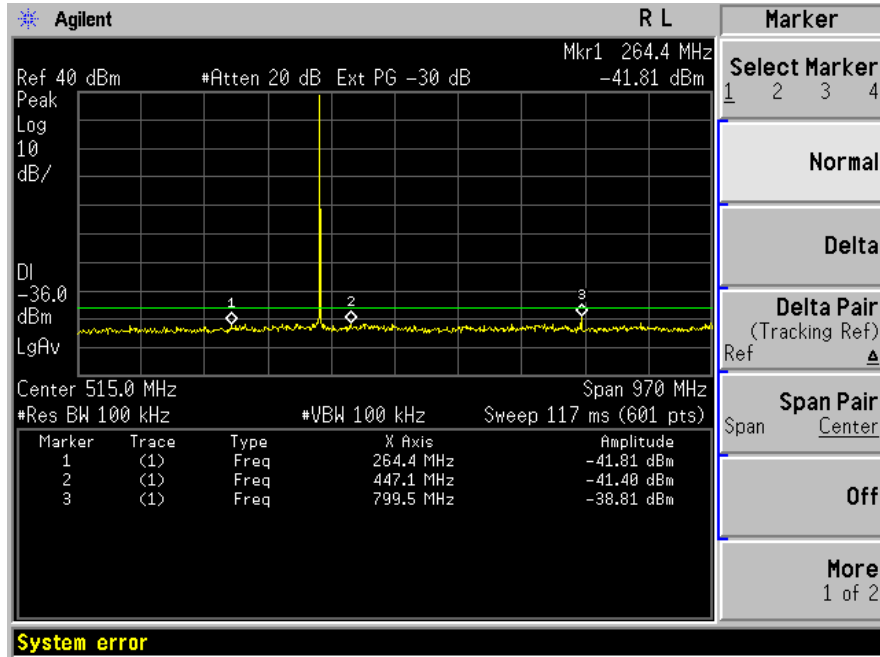

**Conduct Spurious Emission(worst) @ 435.325MHz (1GHz-12.75GHz)**

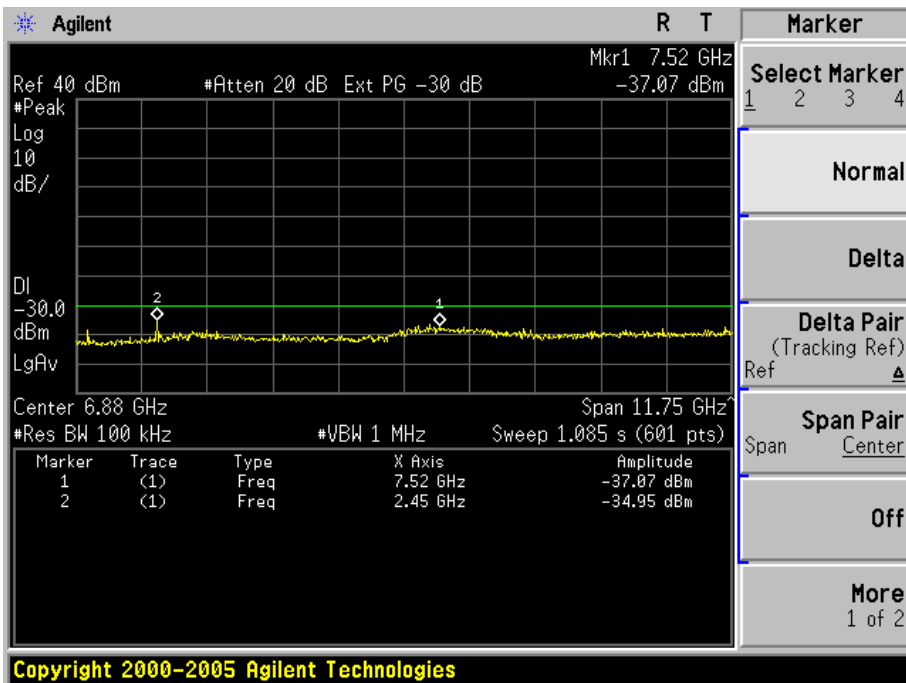

## 11. TRANSMITTER FREQUENCY BEHAVIOR

### 11.1 PROVISIONS APPLICABLE

Section 90.214

Time intervals <sup>1, 2</sup>	Maximum frequency difference <sup>3</sup>	All equipment	
		150 to 174 MHz	421 to 512 MHz
Transient Frequency Behavior for Equipment Designed to Operate on 25 kHz Channels			
t <sub>1</sub> <sup>4</sup> .....	± 25.0 kHz	5.0 ms	10.0 ms
t <sub>2</sub> .....	± 12.5 kHz	20.0 ms	25.0 ms
t <sub>3</sub> <sup>4</sup> .....	± 25.0 kHz	5.0 ms	10.0 ms
Transient Frequency Behavior for Equipment Designed to Operate on 12.5 kHz Channels			
t <sub>1</sub> <sup>4</sup> .....	± 12.5 kHz	5.0 ms	10.0 ms
t <sub>2</sub> .....	± 6.25 kHz	20.0 ms	25.0 ms
t <sub>3</sub> <sup>4</sup> .....	± 12.5 kHz	5.0 ms	10.0 ms
Transient Frequency Behavior for Equipment Designed to Operate on 6.25 kHz Channels			
t <sub>1</sub> <sup>4</sup> .....	± 6.25 kHz	5.0 ms	10.0 ms
t <sub>2</sub> .....	± 3.125 kHz	20.0 ms	25.0 ms
t <sub>3</sub> <sup>4</sup> .....	± 6.25 kHz	5.0 ms	10.0 ms

<sup>1</sup> t<sub>on</sub> is the instant when a 1 kHz test signal is completely suppressed, including any capture time due to phasing.

t<sub>1</sub> is the time period immediately following t<sub>on</sub>.

t<sub>2</sub> is the time period immediately following t<sub>1</sub>.

t<sub>3</sub> is the time period from the instant when the transmitter is turned off until t<sub>off</sub>.

t<sub>off</sub> is the instant when the 1 kHz test signal starts to rise.

<sup>2</sup> During the time from the end of t<sub>2</sub> to the beginning of t<sub>3</sub>, the frequency difference must not exceed the limits specified in §90.213.

<sup>3</sup> Difference between the actual transmitter frequency and the assigned transmitter frequency.

<sup>4</sup> If the transmitter carrier output power rating is 6 watts or less, the frequency difference during this time period may exceed the maximum frequency difference for this time period.

### 11.2 TEST METHOD

TIA/EIA-603 2.2.19

### 11.3 TEST INSTRUMENTS

NAME OF EQUIPMENT	MANUFACTURER	MODEL	SERIAL NUMBER	CAL. DATE
Signal Generator	R&S	SMT02	A0304261	2013.07.17
Storage Oscilloscope	Tektronix	TDS3052	B017447	2013.07.17

### 11.4 DESCRIBE LIMIT LINE OF TRANSMITTER FREQUENCY BEHAVIOR

**ton**: The switch-on instant  $t_{on}$  of a transmitter is defined by the condition when the output power, measured at the antenna terminal, exceeds 0,1 % of the full output power (-30 dBc).

**t1**: period of time starting at  $t_{on}$  and finishing according to above 11.1

**t2**: period of time starting at the end of  $t_1$  and finishing according to above 11.1

**toff**: switch-off instant defined by the condition when the output power falls below 0,1 % of the full output power (-30 dBc).

**t3**: period of time that finishing at  $t_{off}$  and starting according to above 11.1

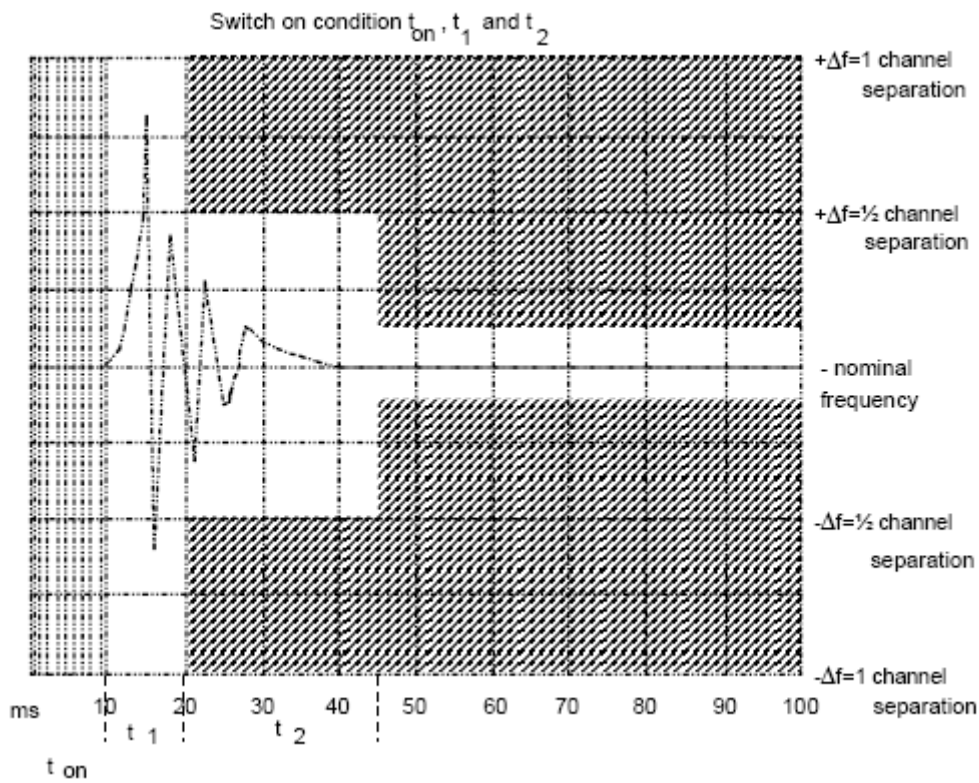

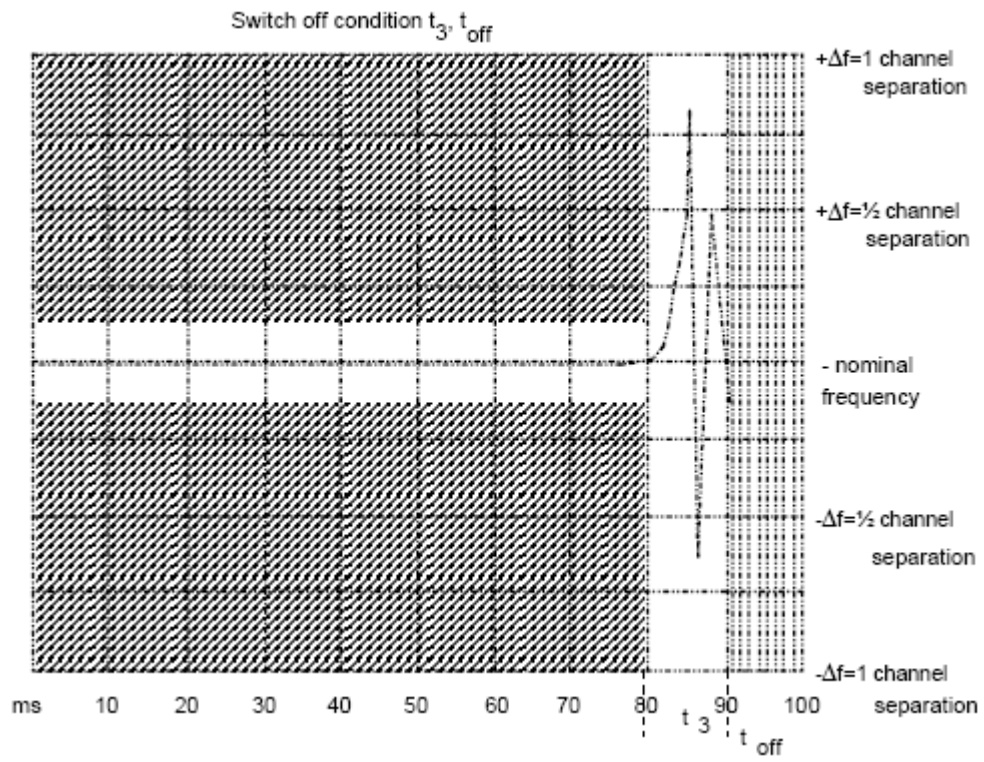

### 11.5 MEASURE RESULT

#### FOR VHF BAND

Transmitter Frequency Behaviour @ 12.5 KHz Channel Separation--Off to On

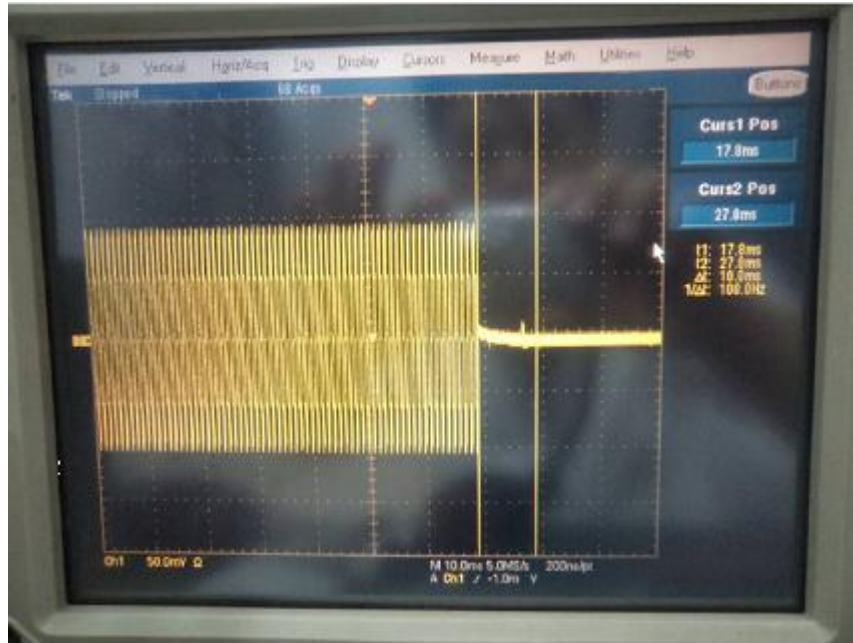

Transmitter Frequency Behaviour @ 12.5 KHz Channel Separation--On to Off

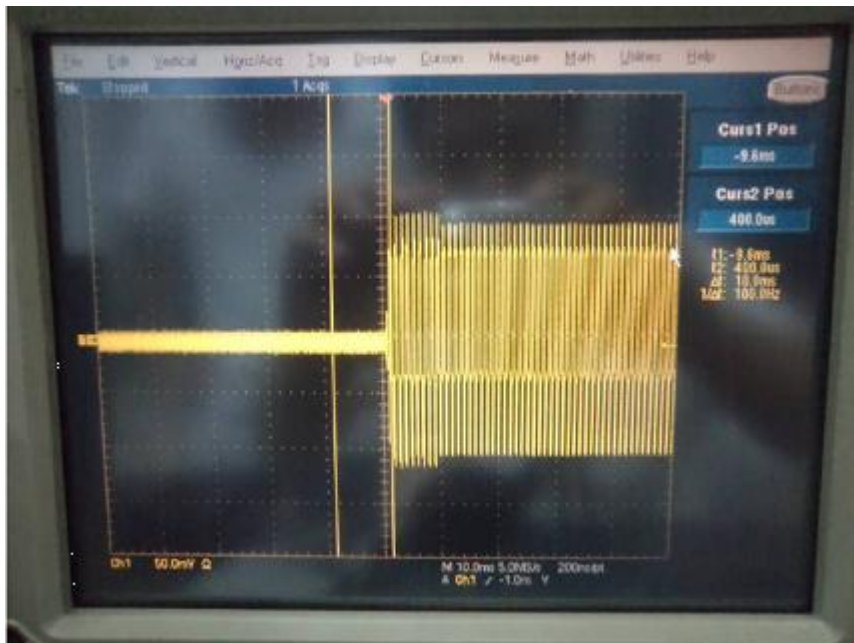

FOR UHF BAND

Transmitter Frequency Behaviour @ 12.5 KHz Channel Separation--Off to On

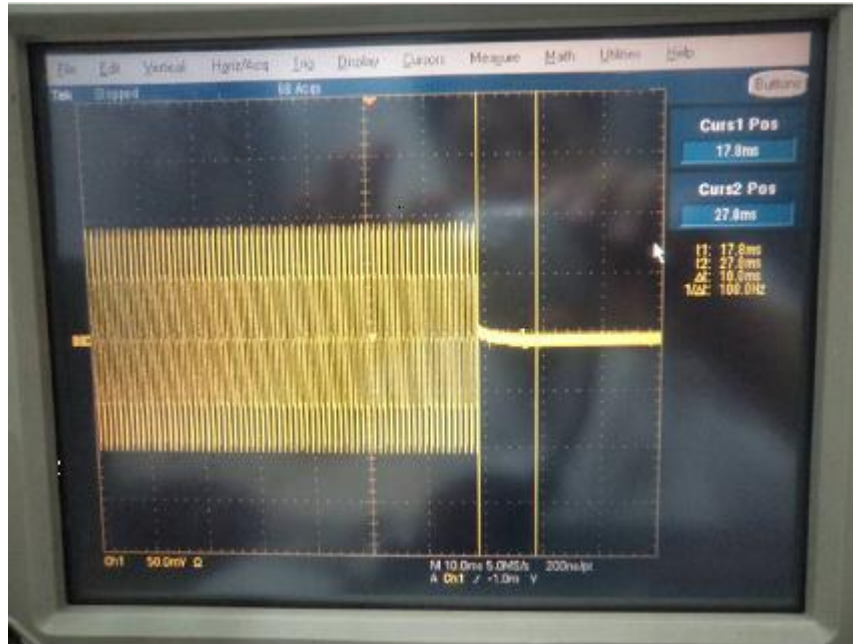

Transmitter Frequency Behaviour @ 12.5 KHz Channel Separation--Off to On

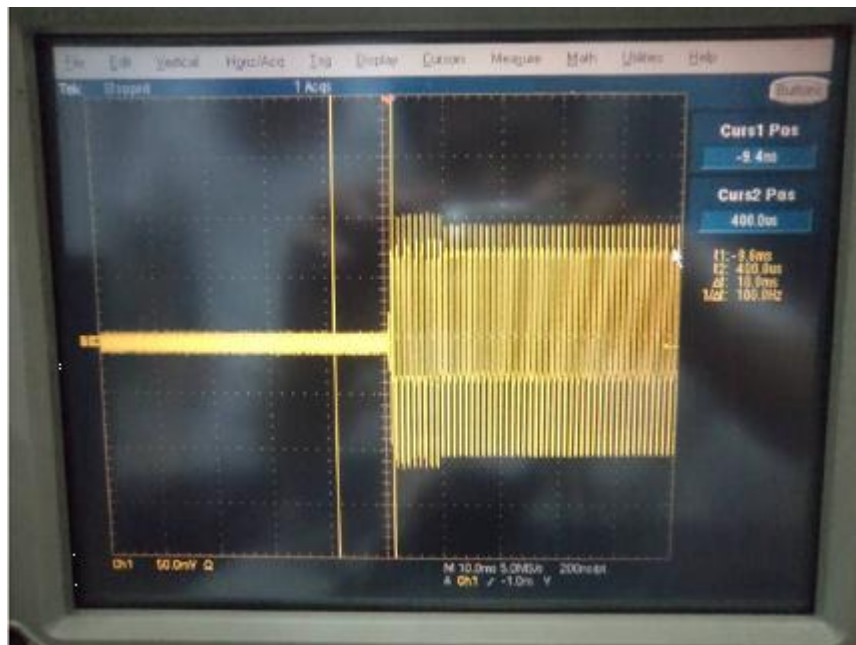



## 12. RADIATED EMISSION ON RECEIVING MODE

### 12.1 PROVISIONS APPLICABLE

FCC Part 15 Subpart B Section 15.109

### 12.2 TEST METHOD

ANSI C 63.4: 2003

### 12.3 TEST INSTRUMENTS

NAME OF EQUIPMENT	MANUFACTURER	MODEL	SERIAL NUMBER	CAL. DATE
SPECTRUM ANALYZER	AGILENT	E4440A	N/A	2013.07.17
TEST RECEIVER	R&S	ESCI	N/A	2013.07.17
LOOP ANTENNA	A.H.	SAS-562B	A0304220	2013.07.17
HORN ANT.	EM	EM-AH-10180	N/A	2013.07.17
BROADBAND ANT.	A.H.	SAS-521-4	A0304224	2013.07.17

**12.4 MEASURE RESULT (MEASURED AT 3M USING FCC PART15 B LIMITS)**  
**RADIATED EMISSION TEST RESULTS – HORIZONTAL**

**Radiated Emission Measurement**

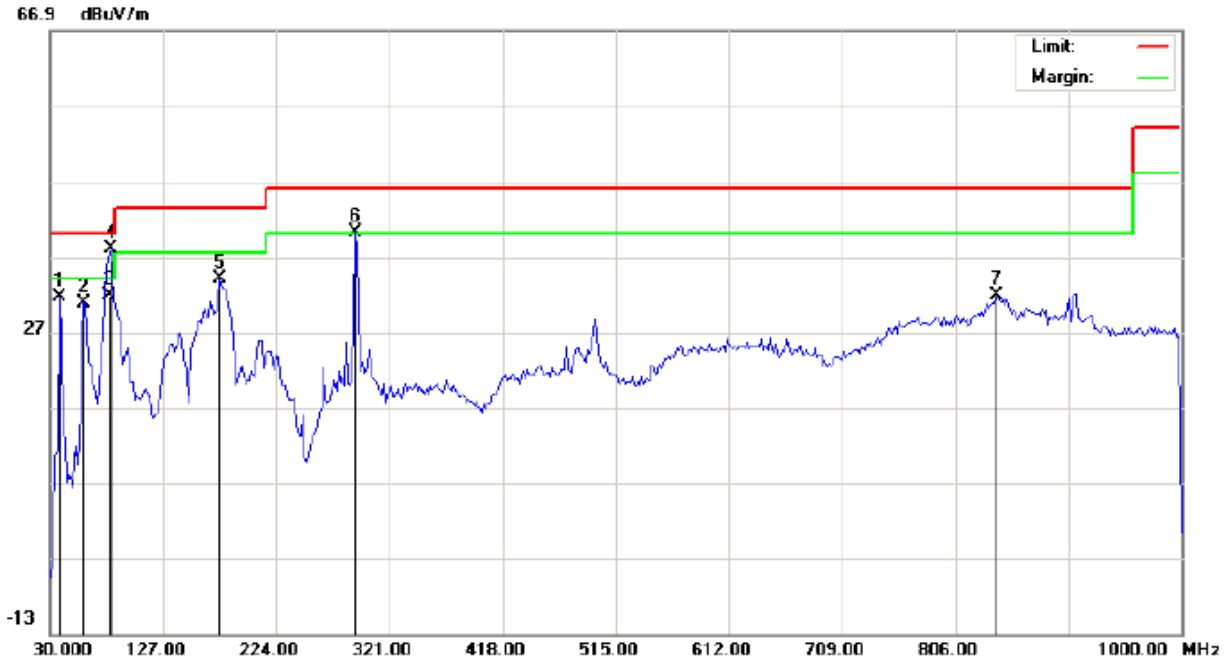

Site: site #1  
Limit: FCC Class B 3M Radiation  
EUT: TWO-way radio  
M/N: TH-UVF9  
Mode: Charging  
Note:

Polarization: *Horizontal*  
Power: AC 120V/60Hz  
Distance: 3m

Temperature: 26  
Humidity: 60 %

No.	Mk	Freq.	Reading	Factor	Measurement	Limit	Over	Detector	Antenna Height	Table Degree	Comment
		MHz	dBuV	dB/m	dBuV/m	dBuV/m	dB		cm	degree	
1		38.0833	22.69	8.98	31.67	40.00	-8.33	peak			
2		59.1000	27.27	3.63	30.90	40.00	-9.10	peak			
3		81.1608	19.38	12.34	31.72	40.00	-8.28	QP	100	0	
4	*	81.7333	25.44	12.57	38.01	40.00	-1.99	peak			
5		175.5000	22.47	11.61	34.08	43.50	-9.42	peak			
6	!	291.9000	23.14	17.08	40.22	46.00	-5.78	peak			
7		841.5667	0.60	31.17	31.77	46.00	-14.23	peak			

RADIATED EMISSION TEST RESULTS – VERTICAL

Radiated Emission Measurement

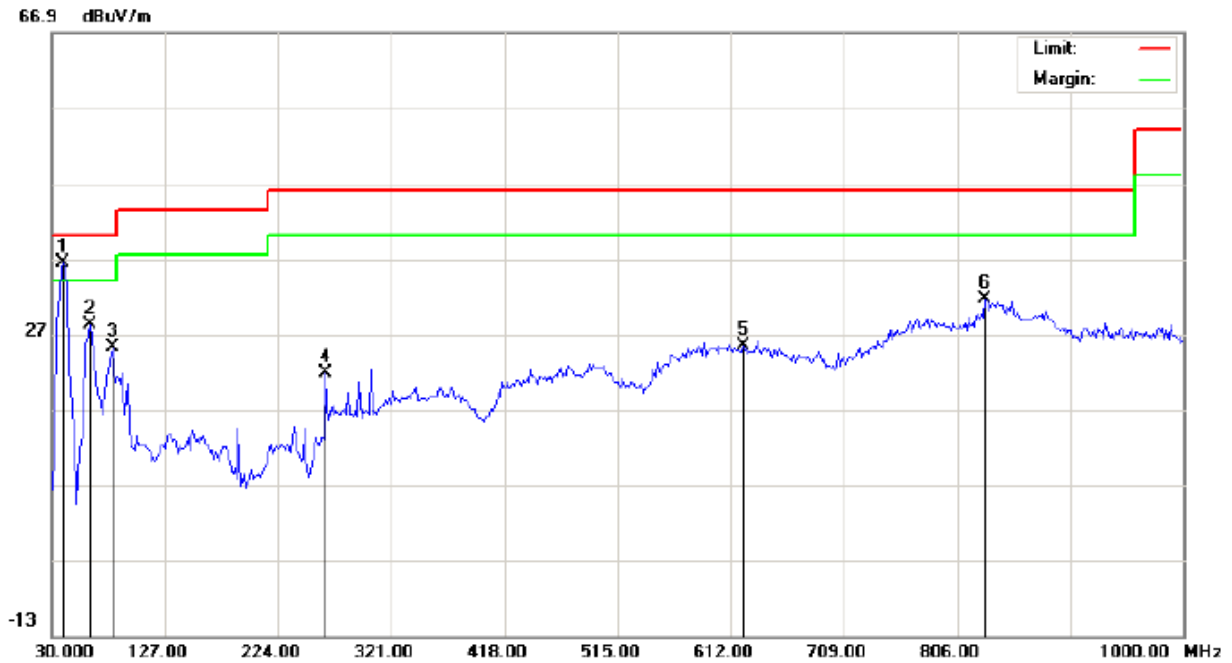

Site: site #1  
Limit: FCC Class B 3M Radiation  
EUT: TWO-way radio  
M/N: TH-UVF9  
Mode: Charging  
Note:

Polarization: *Vertical*  
Power: AC 120V/60Hz  
Distance: 3m

Temperature: 26  
Humidity: 60 %

No.	Mk	Freq.	Reading	Factor	Measurement	Limit	Over	Detector	Antenna	Table	Comment
		MHz	dBuV	dB/m	dBuV/m	dBuV/m	dB		Height	Degree	
									cm	degree	
1	*	39.7000	28.34	7.98	36.32	40.00	-3.68	peak			
2		62.3333	24.70	3.48	28.18	40.00	-11.82	peak			
3		81.7333	12.68	12.57	25.25	40.00	-14.75	peak			
4		264.4166	7.11	14.71	21.82	46.00	-24.18	peak			
5		623.3167	0.44	25.01	25.45	46.00	-20.55	peak			
6		830.2500	1.83	29.75	31.58	46.00	-14.42	peak			

Note: AC and DC have been performed test. And AC mode is worst and recorded in the test report.

## 13. Audio Low Pass Filter Response

### 13.1 LIMITS

**2.1047(a):** Voice modulated communication equipment. A curve or equivalent data showing the frequency response of the audio modulating circuit over a range of 100 to 5000 Hz shall be submitted. For equipment required to have an audio low-pass filter, a curve showing the frequency response of the filter or of all circuitry installed between the modulation limiter and the modulated stage shall be submitted.

**90.242(b)(8):** Recommended audio filter attenuation characteristics are given below:

Audio band	Minimum Attenuation Rel. to 1 KHz Attenuation
3 –20 KHz 20 – 30 KHz	$60 \log_{10}(f/3)$ dB where f is in KHz 50dB

### 13.2. METHOD OF MEASUREMENTS

The rated audio input signal was applied to the input of the audio low-pass filter (or of all modulation stages) using an audio oscillator, this input signal level and its corresponding output signal were then measured and recorded using the FFT Digital Spectrum Analyzer. Tests were repeated at different audio signal frequencies from 0 to 50 KHz.

### 13.3 TEST DATA

**12.5 KHz Channel Spacing, F3E, Frequency of All Modulation States**

Frequency (KHz)	Audio In (dBV)	Audio out (dBV)	Attenuation (Out_In) dB	Attenuation Rel. to 3 KHz (dB)	Recommended Attenuation (dB)
0.1	-75.79	-30.25	45.6	-36.7	
0.2	-75.79	-18.83	57.1	-25.5	
0.4	-75.79	-5.27	70.4	-12.0	
0.6	-75.79	0.24	76.1	-6.4	
0.8	-75.79	4.08	79.7	-2.6	
1.0	-75.79	6.67	82.6	0.0	
1.5	-75.79	8.74	84.3	2.1	
2.0	-75.79	8.54	84.4	1.9	
2.5	-75.79	7.12	82.9	0.5	
3.0	-75.79	5.33	81.2	-1.4	0
3.5	-75.79	2.02	77.8	-4.3	-4
4.0	-75.79	-2.62	73.2	-9.7	-7
4.5	-75.79	-8.41	67.5	-15.3	-11
5.0	-75.79	-14.05	61.7	-21.5	-13
6.0	-75.79	-22.68	53.2	-29.4	-18
7.0	-75.79	-30.62	45.4	-37.5	-22
8.0	-75.79	-38.95	36.7	-45.5	-26
9.0	-75.79	-60.00	15.8	-66.7	-29
10.0	-75.79	-60.00	15.8	-66.7	-31
12.0	-75.79	-60.00	15.8	-66.7	-36
14.0	-75.79	-60.00	15.8	-66.7	-40
16.0	-75.79	-60.00	15.8	-66.7	-44
18.0	-75.79	-60.00	15.8	-66.7	-47
20.0	-75.79	-60.00	15.8	-66.7	-50
25.0	-75.79	-60.00	15.8	-66.7	-50
30.0	-75.79	-60.00	15.8	-66.7	-50
35.0	-75.79	-60.00	15.8	-66.7	-50
40.0	-75.79	-60.00	15.8	-66.7	-50
45.0	-75.79	-60.00	15.8	-66.7	-50
50.0	-75.79	-60.00	15.8	-66.7	-50

**Note:** Due to the difficulty of measuring the Frequency Response of the internal low-pass filter, the Frequency Response of All Modulation States is performed to show the roll-off at 3 KHz in comparison with the recommended audio filter attenuation.

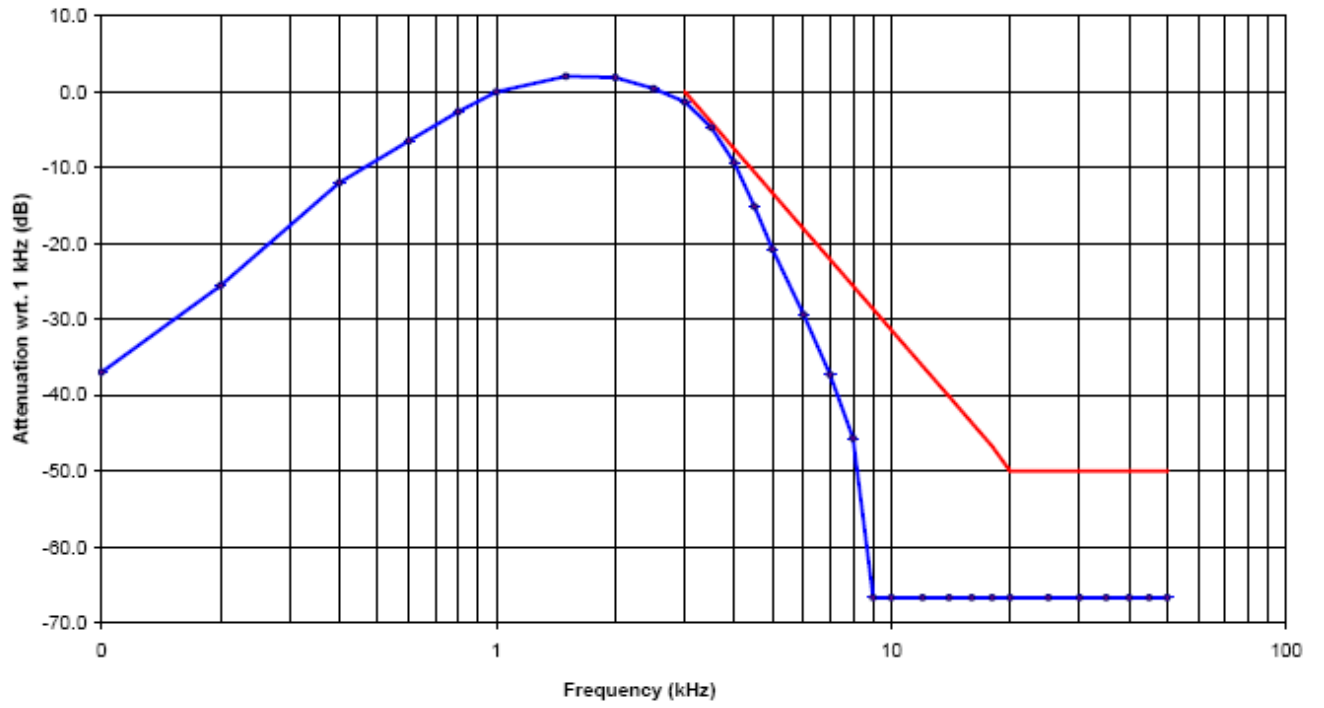

# **APPENDIX I**

## **PHOTOGRAPHS OF SETUP**

### CONDUCTED EMISSION TEST SETUP



### RADIATED TEST SETUP

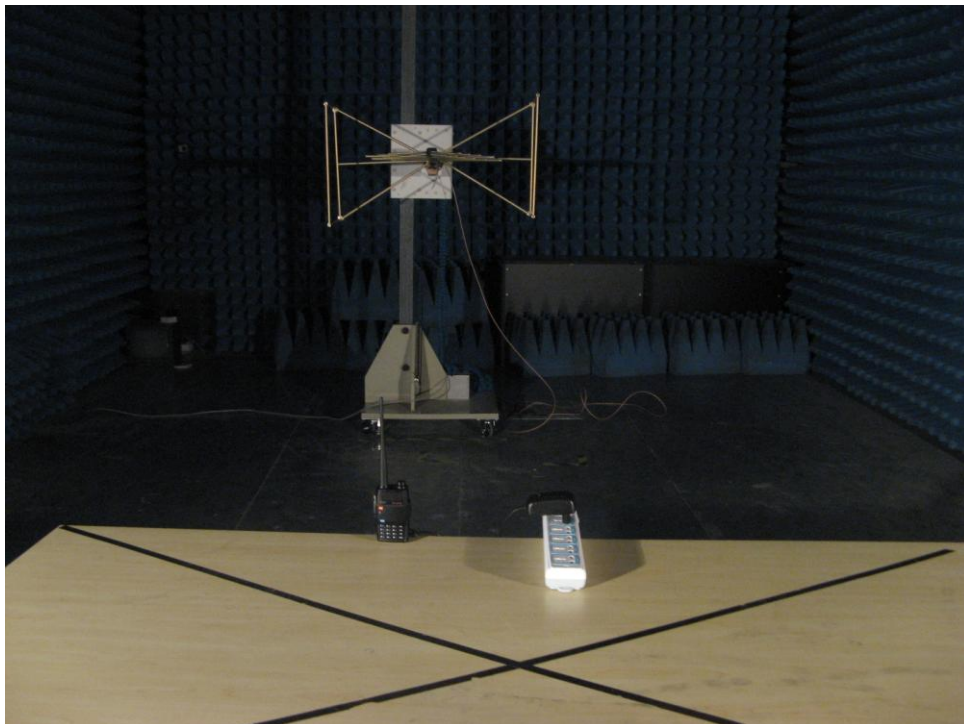



## **APPENDIX II**

### **EXTERNAL VIEW OF EUT**

TOTAL VIEW OF EUT



TOP VIEW OF EUT



BOTTOM VIEW OF EUT



FRONT VIEW OF EUT



BACK VIEW OF EUT



LEFT VIEW OF EUT



RIGHT VIEW OF EUT



OPEN VIEW OF EUT

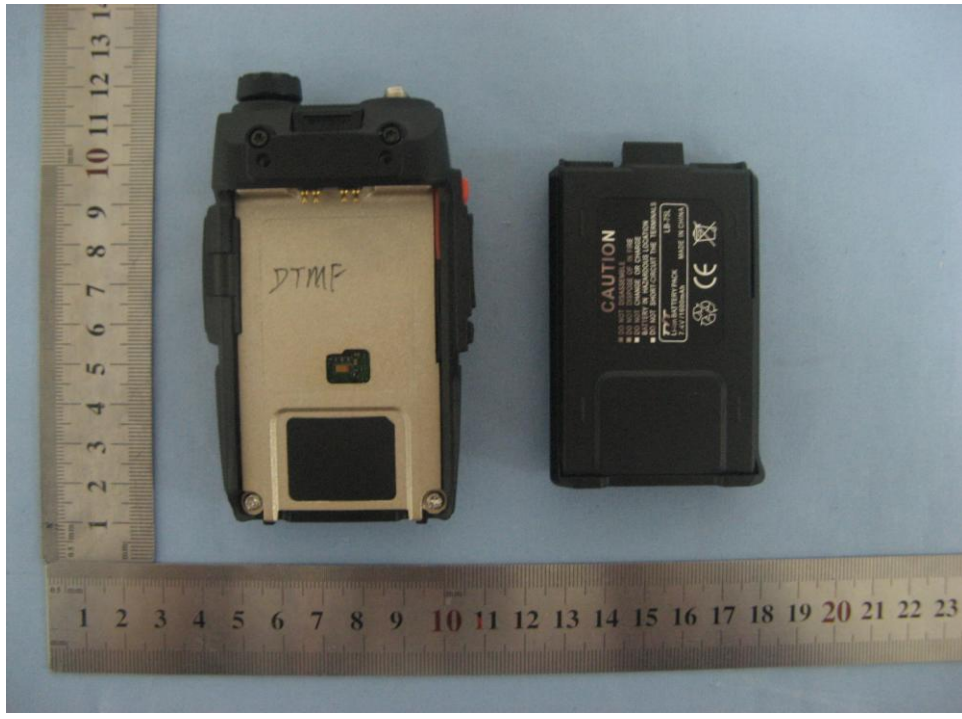

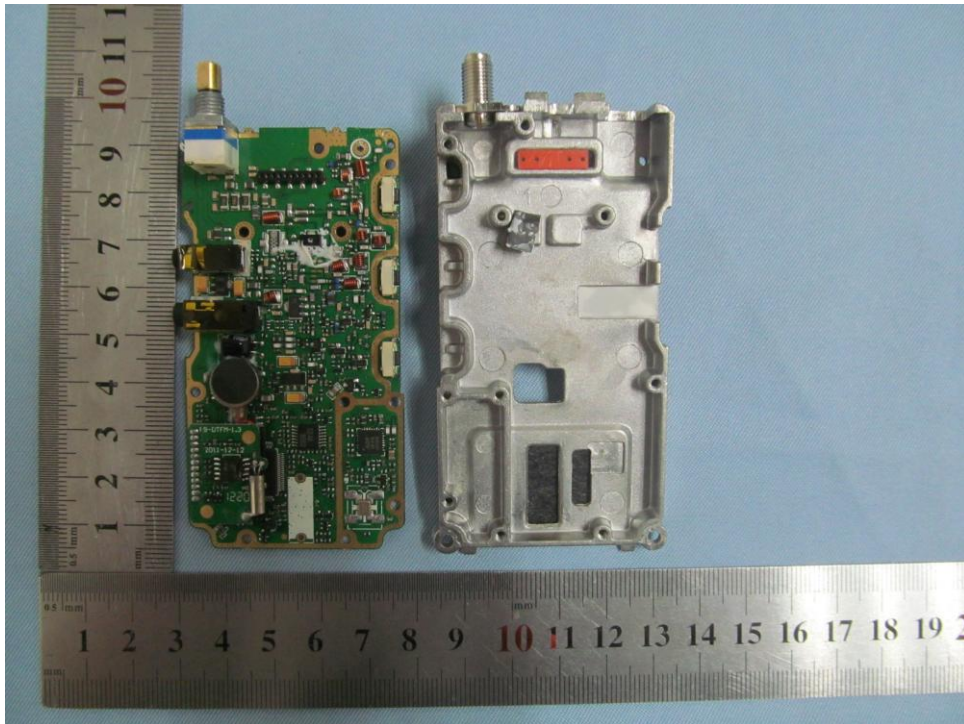

INTERNAL VIEW OF EUT - 1

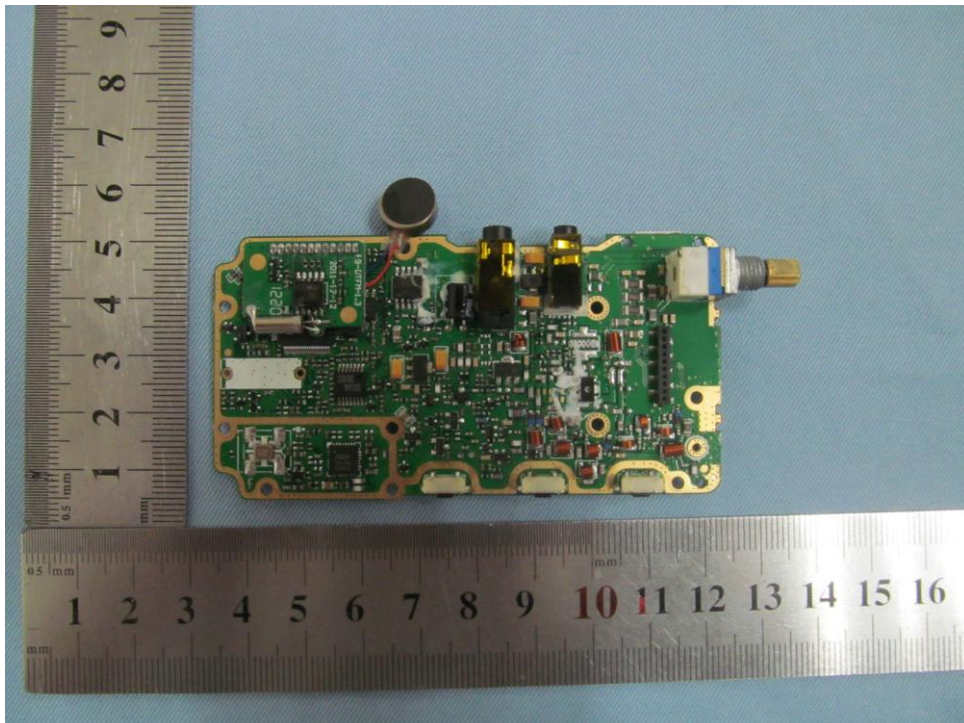

INTERNAL VIEW OF EUT - 2

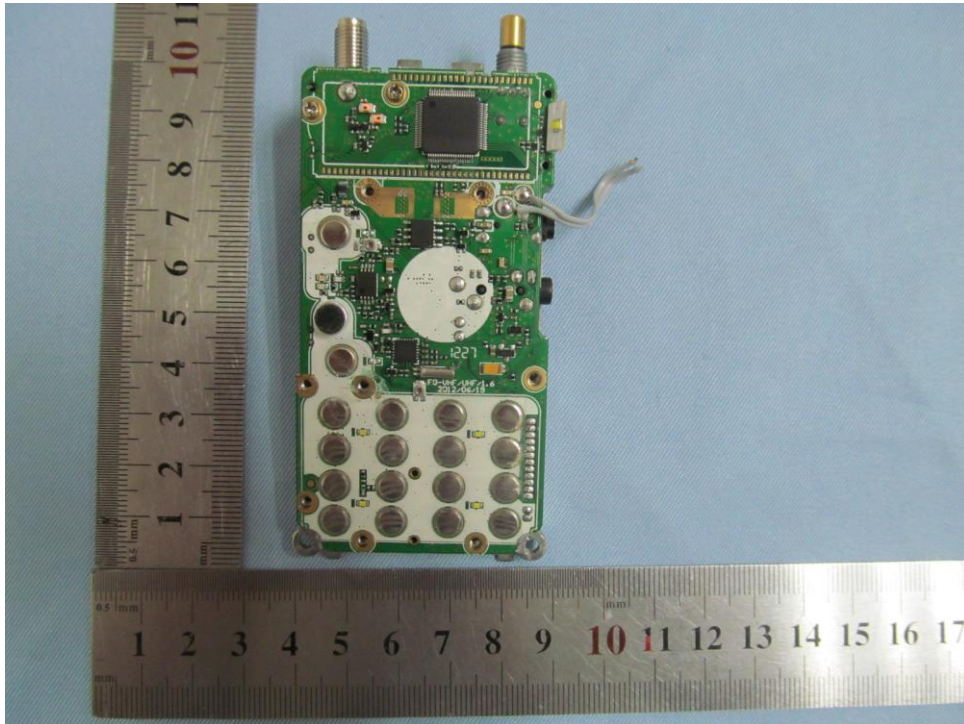

----END OF REPORT----