

PRINICS Instant Dock Printer

PD460, PD460B

User Guide

www.kodakphotoprinter.com



Safety Precautions

Denotes the possibility of serious injury or death

- Use only recommended power sources.
- Do not attempt to disassemble, alter, or apply heat to the product.
- Avoid dropping or subjecting the product to severe impacts.
- Do not touch the interior of the product if it has been dropped otherwise damaged.
- Do not use, place, or store the product in the following places.
 - Places with direct sunlight, places with a temperature higher than 40 °C (104 °F), places with high humidity or dust, and places with strong vibrations.
- Stop using the product immediately if it emits smoke, a strange smell, or otherwise behaves abnormally.
- Do not use organic solvents such as alcohol, benzene, or thinner to clean the product.
- Do not let the product come into contact with water or other liquids.
- Do not allow liquids or foreign objects to enter the product.
- Do not handle the power cord with wet hands.
- Keep out of reach of children.
- Keep the printer in a safe area to avoid people from tripping over the power cord.

Safety Precautions

- Please keep you away at least 20cm distance from printer when printing.
- Unplug the power cord when the product is not in use.
- Unplug the power cord periodically, and using a dry cloth, wipe away any dust or dirt that has collected on the plug, the exterior of the power outlet, and the surrounding area.
- Do not stick your hand or objects into the printer interior.
- Do not place heavy objects on top of the product.

Denotes the possibility of damage to the equipment.

- Do not touch the paper while it is printing. It will come in and out 4 times (yellow, magenta, cyan, laminating).
- Do not pull out the paper while it is printing.
- Do not place anything on top of the printer while in use.
- Use the latest app for optimal results. You may download the latest app through Google Play or Apple App Store.
- Never reuse paper. Reusing paper may cause paper jams or cause the ink sheet to adhere to the paper causing printer damage.
- Do not reuse ink cartridges.
- Do not unplug the printer while it is printing.

Package Contents

Before use, make sure the following items are included in the package. If anything is missing, contact the retailer where you purchased the printer.

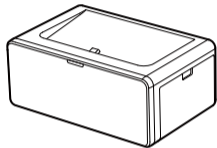

Instant Dock Printer
(D-460T)

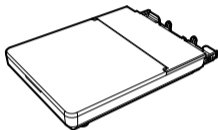

Paper Cassette



Power Adapter

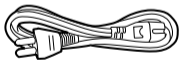

Power Cord

* Specifications or design may change without notice for product optimization.

Consumable (Separate Purchase)

Before printing, purchase an Ink Cartridge / Paper Set

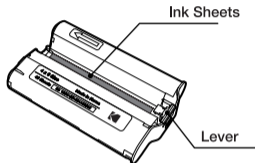

Ink Cartridge

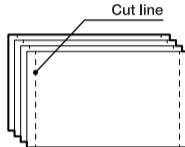

Photo Paper

Consumable Set

Model	Print Size	Paper Type	Print Sheets
ICRG 40	4 x 6 inch (100 x 150mm)	Print Paper	40
ICRG 80			80
ICRG 120			120

*Ink cartridge and paper are sold as a set, available for sale.

Installing Photo Printer Dock

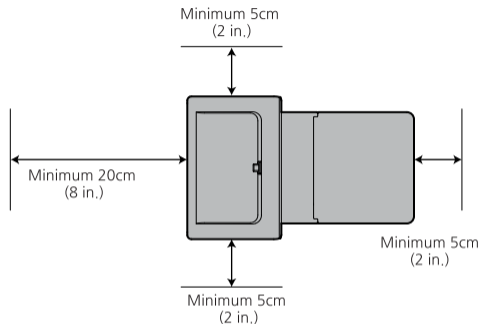

Choose the right place to put the Instant Dock Printer. Place the printer on a table or other flat, stable surface. Do not place the printer on an unstable or tilted surface.

- Leave a minimum of 5 cm (2 in.) of open space around the printer.
- Leave a minimum of 20 cm (8 in) in front of the printer.
- Make sure the power cord is not interfering with the area where the paper comes in and out.
- Avoid using the printer in dusty areas. It may damage the printer or cause a malfunction.

Inserting Cartridge

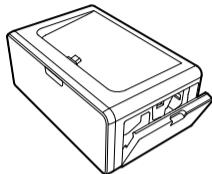

1. Open the cartridge cover.

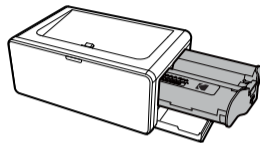

2. Insert the cartridge using the arrow specified until you hear the clicking sound.

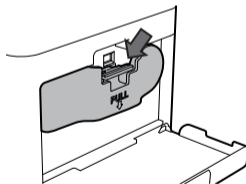

3. Press down and pull out the lever to exchange used cartridges.

- For accessories available for sale, photo paper is provided for the amount of ink cartridge and print number.
- When inserting the cartridge, do not touch the ink sheet with your hand.
- Do not reuse used cartridges. This may cause a product malfunction.

Inserting Paper Cassette

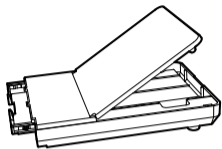

1. Open the cassette cover.

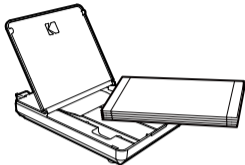

2. Insert the paper facing the shiny side up. You can insert up to 20 sheets. Inserting over 21 sheets may cause a malfunction. Avoid touching the coated paper with your hands as it may affect the photo quality.

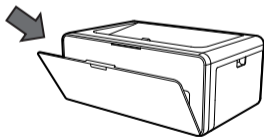

3. Open the printer's cassette cover.

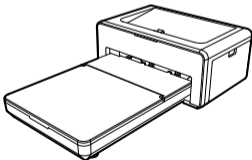

4. Insert the cassette until it clicks into place.

Installing the Application

1. iPhone, iPad and iPod



- 1) Go to the APP STORE in the device.
- 2) Search for "KODAK Instant Printer"
- 3) Install the application.

Instant Printer



2. Android Phones and Tablets



- 1) Go to the PLAY STORE in the device.
- 2) Search for "KODAK Instant Printer"
- 3) Install the application.

Instant Printer



Connecting to the Printer and Printing

Printing photos using a BLUETOOTH

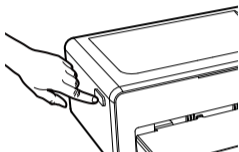

- 1) Turn on the printer by pressing the power button on the top left corner. Turn BLUETOOTH on in your smartphone.

Password
"12345678"

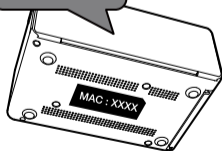

- 2) Go to BLUETOOTH setting in your smart phone and find "Kodak-Instant-XXXX". Printer name (XXXX) are variable 4 words. Password is "12345678".



- 3) App Launch.



- 4) Choose a photo. To start printing push the print button in the App.

* You can find your printer Model No. on the label at the bottom of printer.

Charge your Device

Charging your device

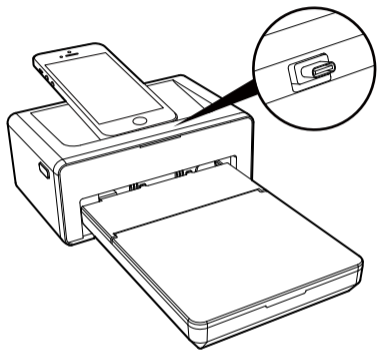

Docking to the printer will charge your device.

Power and LED Status Indicators

Power and LED status indicators

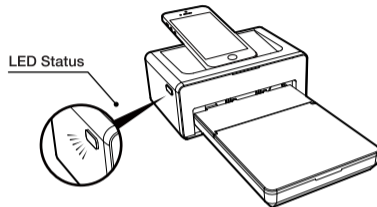

Status	LED
Power on	Yellow LED
Power off (2 seconds)	None
Printing	Yellow LED blinking
Firmware Update	Red LED blinking
No cartridge/Removing cartridge	Red LED blinking for 10 seconds then Yellow LED
No cassette/Removing cassette	Red LED blinking for 10 seconds then Yellow LED
No Paper	Red LED blinking for 10 seconds then Yellow LED
Error (Paper jam..etc)	Red LED blinking for 10 seconds then Yellow LED
Loading / Cooling	Yellow LED

Troubleshoot

Indication	Solution
Paper jam	- Turn the printer off and on. The printer will automatically eject the paper. If problem is not solved, please contact Customer Support.
Low resolution	- The resolution of the original photo may affect print quality. We recommend photo with 1280x2448 pixels and above.
Printer not printing	- Turn the printer off and on. - Check if the cartridge is inserted properly. - The printer will not print once it reaches a certain temperature. This is not a malfunction. Please wait until the printer cools down.
Unable to print from digital camera	- Check if your camera supports PictBridge in camera manual. - Check if your camera has enough battery.

Product Specification

Model	PD -460
Bluetooth	O
Docking	C-type Lightning Dock
Print Size	4 x 6 inch (100 x 148 mm)
Supported Image format	JPEG(Baseline), PNG
Cartridge	ICRG-40, ICRG-80, ICRG-120
Optimal printing conditions	Temperature : 15~35C / Humidity :Below 70% RH (35C)
Printing type	Dye Sublimation Thermal Transfer
Power	DC 24V 2.5A
Printer size	268.7 x 169 x 70(with Cassette) 109 x 169 x 70 (without Cassette)
Supported devices	Android Ver 4.0 and above / iOS Ver 6.0 and above

Part Name

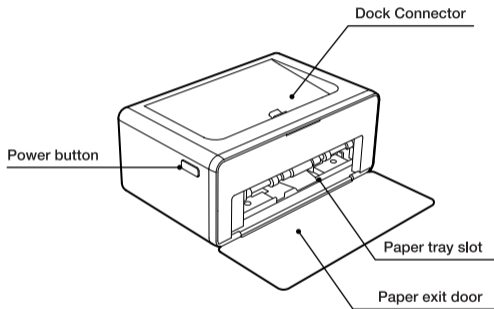

Part Name

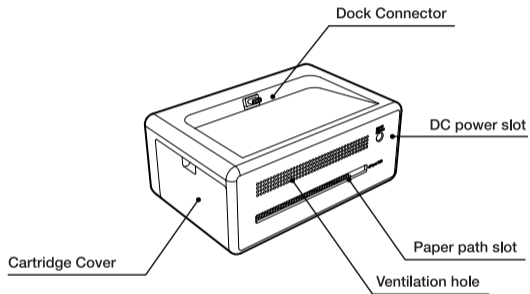

FCC REQUIREMENTS PART 15

Caution: Any changes or modifications in construction of this device which are not expressly approved by the responsible for compliance could void the user's authority to operate the

FCC Compliance Statement

This device complies with part 15 of the FCC rules. Operation is subject to the following two conditions: (1) This device may not cause harmful interference, and (2) this device must accept any interference received, including interference that may cause undesired operation.

This equipment has been tested and found to comply with the limits for a Class B Digital Device, pursuant to Part 15 of the FCC Rules. These limits are designed to this equipment generates, uses, and can radiate radio frequency energy and, if not installed and used in accordance with the instructions, may cause harmful interference to radio communications.

However, there is no guarantee that interference will not occur in a particular installation. If this equipment does cause harmful interference to radio or television reception, which can be determined by turning the radio or television off and on, the user is encouraged to try to correct interference by one or more of the following measures.

1. Reorient or relocate the receiving antenna.
2. Increase the separation between the equipment and receiver.
3. Connect the equipment into an outlet on another circuit.
4. Consult the dealer or an experienced radio/TV technician for help.

FCC Radiation Exposure Statement

This equipment complies with FCC radiation exposure limits set forth for an uncontrolled environment. This equipment should be installed and operated with minimum distance 20 cm between the radiator and your body. This transmitter must not be co-located or operating in conjunction with any other antenna or transmitter.

United States Representative

Company Name : E&S International Enterprises, Inc.
Contact Name : Rodney Rad
Address : 7801 Hayvenhurst Avenue Van Nuys, California 91406 - USA
Telephone Number : +1 818 702 2279
E-mail : rodney.rad@esintl.com

Made in Korea

©Prinics Co., LTD.

The Kodak trademark, logo and trade dress are used under license from Kodak.

