

ROK 101 007/1 Bluetooth Module

Description

ROK 101 007/1 is a short-range module for implementing Bluetooth functionality into various electronic devices. The module consists of three major parts that are mounted on a PCB; a baseband controller, a flash memory, and a radio that operates in the globally available 2.4-2.5 GHz free ISM band.

Both data and voice transmission is supported by the module. Communication between the module and the host controller is carried out using a high speed USB interface compliant with USB Specifications 1.1 or an UART/PCM interface. When using the USB interface, the module appears as a USB slave device and therefore requires no PC resources.

Key Features

- 0dBm Output Power
- Built-in shielding
- Separate supply rail for the I/O ports
- Internal crystal oscillator
- No need for a modulator input since the baseband signal is generated internally
- Supplementary USB signals for wake-up and detach control
- Multiple interface for different applications
 - UART for data
 - PCM for voice
 - USB for voice and data
- HCI firmware included
- Approved for global use (FCC,ETSI)
- Pre-certified Bluetooth 1.0A Module

Suggested Applications

- Portable computers
- Handheld devices
- Cameras
- Computer peripherals
- Mobile phone accessories
- Interface to the fixed line access network

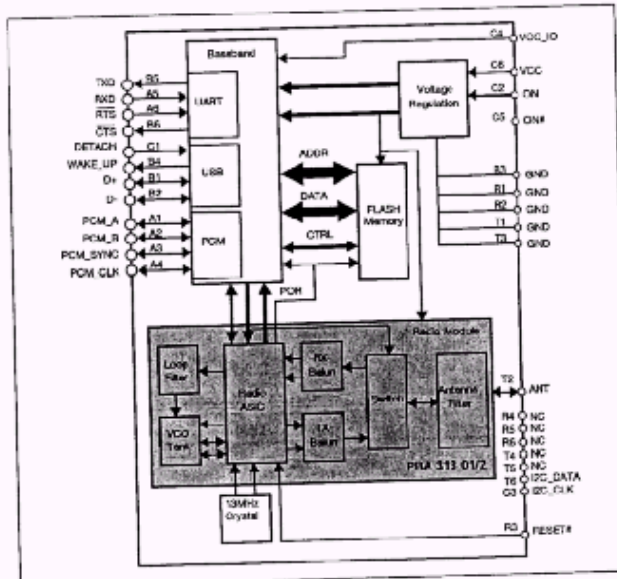

Figure 1. Block Diagram

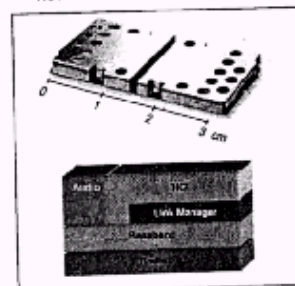

Figure 2. Actual size of the Ericsson Bluetooth Module, and also showing the HW and FW.

ROK 101 007/1 Bluetooth Module

Description

ROK 101 007/1 is a short-range module for implementing Bluetooth functionality into various electronic devices. The module consists of three major parts that are mounted on a PCB; a baseband controller, a flash memory, and a radio that operates in the globally available 2.4-2.5 GHz free ISM band.

Both data and voice transmission is supported by the module. Communication between the module and the host controller is carried out using a high speed USB interface compliant with USB Specifications 1.1 or an UART/PCM interface. When using the USB interface, the module appears as a USB slave device and therefore requires no PC resources.

Key Features

- 0dBm Output Power
- Built-in shielding
- Separate supply rail for the I/O ports
- Internal crystal oscillator
- No need for a modulator input since the baseband signal is generated internally
- Supplementary USB signals for wake-up and detach control
- Multiple interface for different applications
 - UART for data
 - PCM for voice
 - USB for voice and data
- HCI firmware included
- Approved for global use (FCC,ETSI)
- Pre-certified Bluetooth 1.0A Module

Suggested Applications

- Portable computers
- Handheld devices
- Cameras
- Computer peripherals
- Mobile phone accessories
- Interface to the fixed line access network

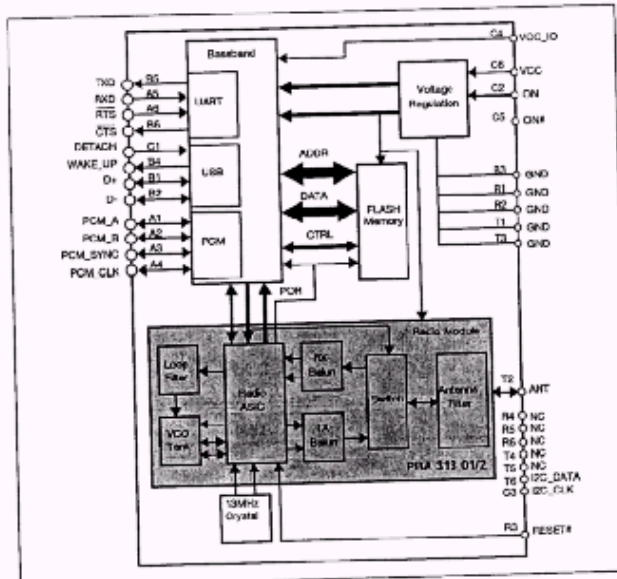

Figure 1. Block Diagram

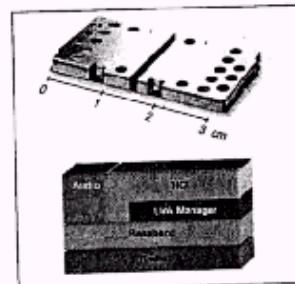

Figure 2. Actual size of the Ericsson Bluetooth Module, and also showing the HW and FW.

RF Specifications

Parameter	Condition	Symbol	Min	Typ	Max	Unit
General						
Frequency Range			2.402		2.495	GHz
Antenna load						Ω
Input/Output: VSWR				50		
Receive Performance with respect to 0.1% BER						
Dynamic range			-70		-20	dBm
C/I_{AWGN}				21		dB
$C/I_{co-channel}$				14		dB
C/I_{1MHz}				TBD		dB
C/I_{2MHz}				-40		dB
Blocking, $C/I_{100-110Hz}$				TBD		dB
Transmitter Performance						
TX power			-3		+4	dBm
TX carrier drift in 1 slot	See Figure 3				25	kHz
TX carrier drift in 3,5 slots	See Figure 3				40	kHz
SSB Phase noise	$\Delta f=0.5MHz$				-89	dBc/Hz
	$\Delta f=2.5MHz$				-121	dBc/Hz
Adjacent channel (1 MHz) power					-20	dBm
Spurious free dynamic range					+30	dB

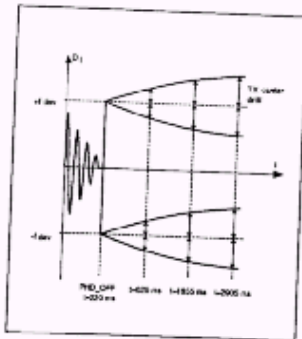

Figure 3. TX Carrier Drift

Pin Description

Pin	Pin Name	Type	Direction	Description
A1	PCM_A	CMOS	In/Out	PCM data, see note 5
A2	PCM_B	CMOS	In/Out	PCM data, see note 5
A3	PCM_SYNC	CMOS	In/Out	Sets the PCM data sampling rate, see note 5
A4	PCM_CLK	CMOS	In/Out	PCM clock that sets the PCM data rate, see note 5
A5	RXD	CMOS	Input	RX data from the UART, see note 5
A6	RTS	CMOS	Input	Flow control signal, Request To Send data from UART, see note 5
B1	D-	CMOS	In/Out	USB data pin, see note 4
B2	D+	CMOS	In/Out	USB data pin, see note 4
B3	GND	Power	Power	Signal ground
B4	WAKE_UP	CMOS	Output	Indicates that the module wants to be attached to the USB, active high
B5	TXD	CMOS	Output	TX data from the UART
B6	CTS	CMOS	Output	Flow control signal, Clear To Send data from UART
C1	DETACH	CMOS	Input	Indicates that the USB host wants to detach the module, active high, see note 5
C2	ON	Power	Input	When tied to V_{CC} , the module is enabled.
C3	I2C_CLK	CMOS	Output	I2C clock signal
C4	VCC_IO	Power	Power	External supply rail to the Input / Output ports
C5	ON#	-	-	This pin has been used for compatibility reasons and this signal is not connected on the Ericsson module.
C6	VCC	Power	Power	Supply Voltage
R1	GND	Power	Power	Signal ground
R2	GND	Power	Power	Signal ground
R3	RESET#	CMOS	Input	Active low reset, see note 6
R4	NC	-	-	Do not connect - Vendor test point
R5	NC	-	-	Do not connect - Vendor test point
R6	NC	-	-	Do not connect - Vendor test point
T1	GND	Power	Power	Signal Ground
T2	ANT	RF	In/Out	50 Ω Antenna connection
T3	GND	Power	Power	Signal Ground
T4	NC	Power	Power	Test point, internal voltage regulator - Do not connect
T5	NC	-	-	Do not connect - Vendor test point
T6	I2C_DATA	CMOS	Out	I2C data signal

Note: The CMOS buffers are low voltage TTL compatible signals.

Notes

- All inputs except ON.
- Standby is defined as only page scan (R2 state) is activated. [Inquiry scan is not activated].
- Module is turned off when ON is low and VCC_IO is turned off.
- To be compliant with the USB 1.1 specification, VCC_IO \geq 3.11V.
- 100k Ω pull-up resistors to V_{CC_IO} are used on the module. PCM signals direction is programmable
- RESET# signal must be fed from an open drain output with pull-up resistor.

Pin Description

Pin	Pin Name	Type	Direction	Description
A1	PCM_A	CMOS	In/Out	PCM data, see note 5
A2	PCM_B	CMOS	In/Out	PCM data, see note 5
A3	PCM_SYNC	CMOS	In/Out	Sets the PCM data sampling rate, see note 5
A4	PCM_CLK	CMOS	In/Out	PCM clock that sets the PCM data rate, see note 5
A5	RXD	CMOS	Input	RX data from the UART, see note 5
A6	RTS	CMOS	Input	Flow control signal, Request To Send data from UART, see note 5
B1	D-	CMOS	In/Out	USB data pin, see note 4
B2	D+	CMOS	In/Out	USB data pin, see note 4
B3	GND	Power	Power	Signal ground
B4	WAKE_UP	CMOS	Output	Indicates that the module wants to be attached to the USB, active high
B5	TXD	CMOS	Output	TX data from the UART
B6	CTS	CMOS	Output	Flow control signal, Clear To Send data from UART
C1	DETACH	CMOS	Input	Indicates that the USB host wants to detach the module, active high, see note 5
C2	ON	Power	Input	When tied to V_{CC} , the module is enabled.
C3	I2C_CLK	CMOS	Output	I2C clock signal
C4	VCC_IO	Power	Power	External supply rail to the Input / Output ports
C5	ON#	-	-	This pin has been used for compatibility reasons and this signal is not connected on the Ericsson module.
C6	VCC	Power	Power	Supply Voltage
R1	GND	Power	Power	Signal ground
R2	GND	Power	Power	Signal ground
R3	RESET#	CMOS	Input	Active low reset, see note 6
R4	NC	-	-	Do not connect - Vendor test point
R5	NC	-	-	Do not connect - Vendor test point
R6	NC	-	-	Do not connect - Vendor test point
T1	GND	Power	Power	Signal Ground
T2	ANT	RF	In/Out	50 Ω Antenna connection
T3	GND	Power	Power	Signal Ground
T4	NC	Power	Power	Test point, internal voltage regulator - Do not connect
T5	NC	-	-	Do not connect - Vendor test point
T6	I2C_DATA	CMOS	Out	I2C data signal

Note: The CMOS buffers are low voltage TTL compatible signals.

Notes

1. All inputs except ON.
2. Standby is defined as only page scan (R2 state) is activated. [Inquiry scan is not activated].
3. Module is turned off when ON is low and VCC_IO is turned off.
4. To be compliant with the USB 1.1 specification, VCC_IO \geq 3.11V.
5. 100k Ω pull-up resistors to V_{CC_IO} are used on the module. PCM signals direction is programmable
6. RESET# signal must be fed from an open drain output with pull-up resistor.

Pin Description

Pin	Pin Name	Type	Direction	Description
A1	PCM_A	CMOS	In/Out	PCM data, see note 5
A2	PCM_B	CMOS	In/Out	PCM data, see note 5
A3	PCM_SYNC	CMOS	In/Out	Sets the PCM data sampling rate, see note 5
A4	PCM_CLK	CMOS	In/Out	PCM clock that sets the PCM data rate, see note 5
A5	RXD	CMOS	Input	RX data from the UART, see note 5
A6	RTS	CMOS	Input	Flow control signal, Request To Send data from UART, see note 5
B1	D-	CMOS	In/Out	USB data pin, see note 4
B2	D+	CMOS	In/Out	USB data pin, see note 4
B3	GND	Power	Power	Signal ground
B4	WAKE_UP	CMOS	Output	Indicates that the module wants to be attached to the USB, active high
B5	TXD	CMOS	Output	TX data from the UART
B6	CTS	CMOS	Output	Flow control signal, Clear To Send data from UART
C1	DETACH	CMOS	Input	Indicates that the USB host wants to detach the module, active high, see note 5
C2	ON	Power	Input	When tied to V_{CC} , the module is enabled.
C3	I2C_CLK	CMOS	Output	I2C clock signal
C4	VCC_IO	Power	Power	External supply rail to the Input / Output ports
C5	ON#	-	-	This pin has been used for compatibility reasons and this signal is not connected on the Ericsson module.
C6	VCC	Power	Power	Supply Voltage
R1	GND	Power	Power	Signal ground
R2	GND	Power	Power	Signal ground
R3	RESET#	CMOS	Input	Active low reset, see note 6
R4	NC	-	-	Do not connect – Vendor test point
R5	NC	-	-	Do not connect – Vendor test point
R6	NC	-	-	Do not connect – Vendor test point
T1	GND	Power	Power	Signal Ground
T2	ANT	RF	In/Out	50 Ω Antenna connection
T3	GND	Power	Power	Signal Ground
T4	NC	Power	Power	Test point, internal voltage regulator - Do not connect
T5	NC	-	-	Do not connect – Vendor test point
T6	I2C_DATA	CMOS	Out	I2C data signal

Note: The CMOS buffers are low voltage TTL compatible signals.

Notes

1. All inputs except ON.
2. Standby is defined as only page scan (R2 state) is activated. [Inquiry scan is not activated].
3. Module is turned off when ON is low and VCC_IO is turned off.
4. To be compliant with the USB 1.1 specification, VCC_IO \geq 3.11V.
5. 100k Ω pull-up resistors to V_{CC_IO} are used on the module. PCM signals direction is programmable
6. RESET# signal must be fed from an open drain output with pull-up resistor.

Functional Description

The ROK 101 007/1 is a complete Bluetooth module that has been specified and designed according to the Bluetooth System v1.0A. Its implementation is based on a high-performance integrated radio transceiver (PBA 313 01 /2) working with a baseband controller, a flash memory and surrounding secondary components features low energy consumption for use in battery operated devices.

Block Diagram

ROK 101 007/1 has five major operational blocks. Figure 7 illustrates the interaction of the various blocks. The functionality of each block is as follows:

- Radio functionality is achieved by using the Bluetooth Radio, PBA 313 01 / 2. Six operational blocks are shown for the radio section and their operation is as follows:
 - VCO-tank is a part of the phase locked loop. The modulation is performed directly on the VCO. To ensure high performance the VCO-tank is laser trimmed.
 - Loop filter, filters the tuning voltage of the VCO-tank.
 - RX-balun handles transformation from unbalanced to balanced transmission.
 - TX-balun handles biasing of the output amplifier stage and transformation from balanced to unbalanced transmission.
 - Antenna switch directs the power either from the antenna filter to the receive ports or from the ASIC output ports to the antenna filter.
 - Antenna filter band-pass filters the radio signal.
- The baseband controller is an ARN7-Thumb based chip that controls the operation of the radio transceiver via one of the interface methods; USB or UART. Additionally, the baseband controller has a PCM Voice interface.
- A Flash memory is used together with the baseband controller. Please, refer also to the Firmware section.
- The power management block regulates and filters the supply voltage. V_{CC} is typically 3.3V and two regulated voltages are produced, 2.6V and 2.2V_{low}.
- An internal clock is mounted on the module. The clock frequency is 13MHz and is generated from a crystal oscillator that guarantees a timing accuracy within ± 20 ppm.

Bluetooth Module stack

The Host Controller Interface (HCI) handles the communication by the transport layer through the UART or USB interfaces with the host. The Baseband and radio provides a secure and reliable radio link for higher layers. The following sections describe the Bluetooth module stack in more detail. It is implemented in accordance with and complies with the Specification of the Bluetooth System v1.0A.

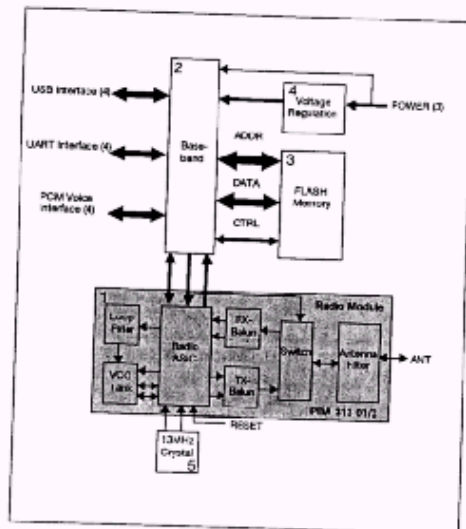

Figure 8. Simplified Block Diagram

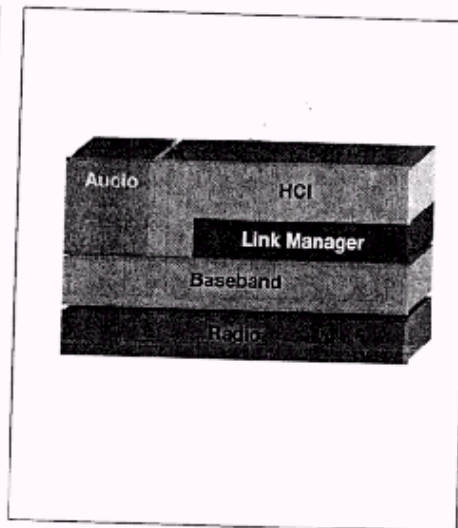

Figure 9. HW/FW parts included in the Ericsson Bluetooth module.

Functional Description

The ROK 101 007/1 is a complete Bluetooth module that has been specified and designed according to the Bluetooth System v1.0A. Its implementation is based on a high-performance integrated radio transceiver (PBA 313 01 /2) working with a baseband controller, a flash memory and surrounding secondary components features low energy consumption for use in battery operated devices.

Block Diagram

ROK 101 007/1 has five major operational blocks. Figure 7 illustrates the interaction of the various blocks. The functionality of each block is as follows:

- Radio functionality is achieved by using the Bluetooth Radio, PBA 313 01 / 2. Six operational blocks are shown for the radio section and their operation is as follows:
 - VCO-tank is a part of the phase locked loop. The modulation is performed directly on the VCO. To ensure high performance the VCO-tank is laser trimmed.

- Loop filter, filters the tuning voltage of the VCO-tank.
 - RX-balun handles transformation from unbalanced to balanced transmission.
 - TX-balun handles biasing of the output amplifier stage and transformation from balanced to unbalanced transmission.
 - Antenna switch directs the power either from the antenna filter to the receive ports or from the ASIC output ports to the antenna filter.
 - Antenna filter band-pass filters the radio signal.
- The baseband controller is an ARN7-Thumb based chip that controls the operation of the radio transceiver via one of the interface methods; USB or UART. Additionally, the baseband controller has a PCM Voice interface.
 - A Flash memory is used together with the baseband controller. Please, refer also to the Firmware section.

- The power management block regulates and filters the supply voltage. V_{CC} is typically 3.3V and two regulated voltages are produced, 2.6V and 2.2V_{low}.
- An internal clock is mounted on the module. The clock frequency is 13MHz and is generated from a crystal oscillator that guarantees a timing accuracy within ± 20 ppm.

Bluetooth Module stack

The Host Controller Interface (HCI) handles the communication by the transport layer through the UART or USB interfaces with the host. The Baseband and radio provides a secure and reliable radio link for higher layers. The following sections describe the Bluetooth module stack in more detail. It is implemented in accordance with and complies with the Specification of the Bluetooth System v1.0A.

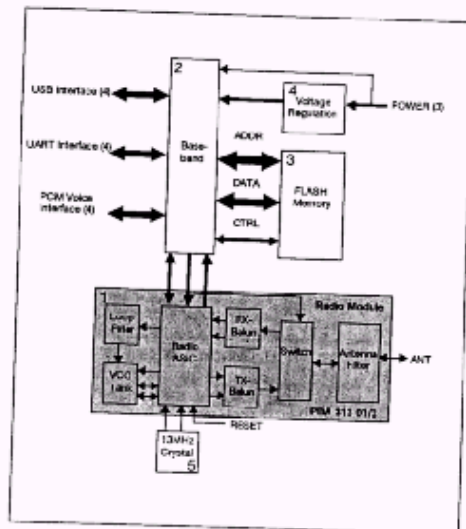

Figure 8. Simplified Block Diagram

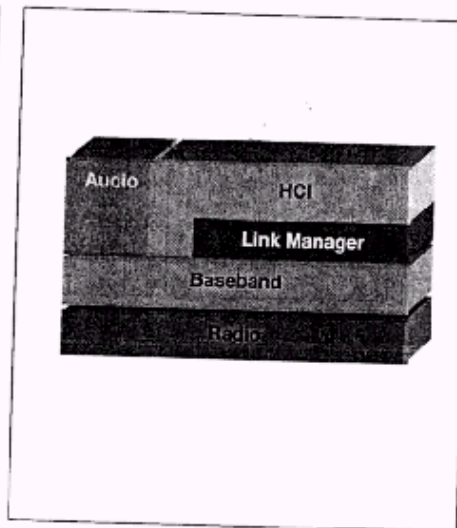

Figure 9. HW/FW parts included in the Ericsson Bluetooth module.

Host Control Interface (HCI)

The HCI provides a uniform command I/F to the Baseband and Link Manager and also to HW status registers.

There are three different types of HCI packets:

- HCI command packets – from host to Bluetooth module HCI.
- HCI event packets – from Bluetooth module HCI to host.
- HCI data packets – going both ways.

It is not necessary to make use of all different commands and events for an application, if the application is aimed at a pre-specified profile, the capabilities of such a profile is necessary to adjust to – see Specification of the Bluetooth System v1.0A Profiles.

Two different HW I/F and for actually communicating with HCI on the Bluetooth module are available.

- a) With the HCI UART Transport Layer on top of HCI, the module will communicate with a host through the UART I/F. The PCM I/F is also available for communicating voice.
- b) With the HCI USB Transport Layer on top of the HCI, the module will communicate with a host through the USB. Detach and Wake_up signals are also available for notebook implementations.

Please refer to the Specification of the Bluetooth System v1.0A part H:1-4 for in-depth information regarding the HCI and different transport layers

Module HW Interfaces

UART Interface

The UART implemented on the module is an industry standard 16C450 and supports the following baud rates: 300, 600, 900, 1200, 1800, 2400, 4800, 9600, 19200, 38400, 57600, 115200, 230400 and 460800 bits/s. 128 byte FIFOs are associated with the UART.

Four signals will be provided for the UART interface. Tx/D & Rx/D are used for data flow, and RTS & CTS can be used for flow control. The module is a DCE. Please refer to the Specification of the Bluetooth System v1.0A part H:4 regarding the HCI and UART transport layers.

PCM Voice Interface

The standard PCM interface has a sample rate of 8 kHz (PCM_SYNC). The PCM clock is variable between 200 kHz and 2.048 MHz. The PCM data can be linear PCM (13-16bit), μ -Law (8bit) or A-Law (8bit).

The PCM I/F can be either master or slave – providing or receiving the PCM_SYNC. Redirection of PCM_A and PCM_B can be accomplished as well.

Over the air the encoding is programmable to be CVSD, A-Law or μ -Law. Preferably the robust CVSD encoding should be used.

USB Interface

The module is a USB high-speed class device (12Mbps) that has the full functionality of a USB slave and is compliant to the USB 1.1 specification. Data transfer occurs on the bi-directional ports, D- & D+.

Additionally, there are two side band signals for a notebook application. Two side band signals Wake_up and Detach are used to control the state from which the notebook resumes. When the host is in a power down mode, Wake_up wakes the host up when the Bluetooth system receives an incoming connection. The host indicates that it is in Suspend mode by using the Detach signal.

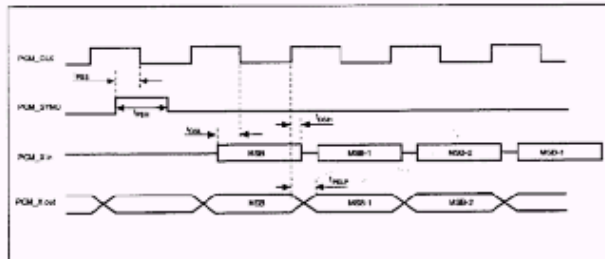

Figure 11. PCM timing

Name	Description	Min	Typ	Max	Unit
f _{pcmClk}	PCM data-transfer clock frequency 1	128	8	2048	kHz
f _{pcmSync}	PCM sample rate sync. frequency				kHz
t _{clh}	PCM_CLK high period		200		ns
t _{cll}	PCM_CLK low period		200		ns
t _{psu}	PCM_SYNC (setup) to PCM_CLK (fall)		100		ns
t _{psl}	PCM_SYNC pulse length		200		ns
t _{osl}	PCM_X in (setup) to PCM_CLK (fall)		100		ns
t _{osh}	PCM_X in (hold) from PCM_CLK (fall)		100		ns
t _{odlp}	PCM_X out valid from PCM_CLK (rise)		150		ns

Table 2. PCM parameters

I2C Interface

A master I2C I/F is available on the module. The control of the I2C pins are performed by Ericsson specific HCI commands available in the FW implementation – see Appendix C.

Antenna

The ANT pin should be connected to a 50Ω-antenna interface, thereby supporting the best signal strength performance. Ericsson Microelectronics can recommend application specific antennas – see Appendix C.

Power-up Sequence

There is no need for a power up sequence if VCC, ON and VCC_IO are tied together.

A power up sequence, if used, shall be applied accordingly: Connection of the supply rails, GND and then V_{CC}; then the ON signal should be

applied in order to initiate the internal regulators; and finally, the V_{CC-IO} supply rail can be activated.

The power-down sequence is similar to the power-up procedure but in the reverse format. Therefore, the disconnection of the signals shall be as follows: V_{CC-IO}, ON, V_{CC} and finally GND.

RESET#

The assignment of the RESET# input is to generate a reset signal to the complete Bluetooth module. During power-up the reset signal is set 'low' automatically so that power supply glitches are avoided. Therefore no reset input should be required after power-up.

When implementing an external RESET#, the signal should be fed from an open drain output with a pull-up resistor.

Power

There are three inputs to the Voltage Management section (V_{CC}, V_{CC-IO}, ON). V_{CC} is the supply voltage that is typically 3.3V.

A separate power supply rail (V_{CC-IO}) is provided for the I/O ports, UART, PCM and USB. To be compliant with the USB 1.1 specification, V_{CC-IO} ≥ 3.11V. V_{CC-IO} can either be connected to V_{CC} or to a dedicated supply rail, which is the same as the logical interface of the host.

Shielding / EMC Requirements

The module has its own RF shielding and is approved according to the standards by FCC and ETSI.

If the approval number is not visible on the outside when the module is utilized in the final product, an exterior label must state that there is a transmitter module inside the product.

Ground

Ground should be distributed with very low impedance as a ground plane. Connect all GND pins to the ground plane.

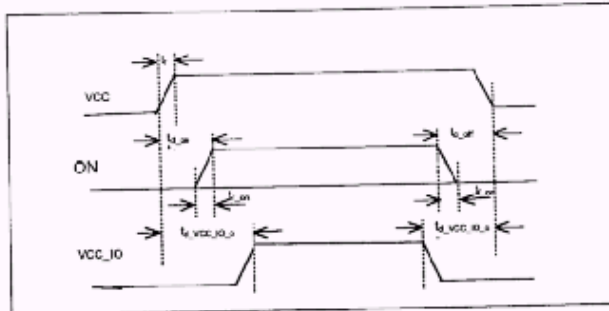

Figure 12. Power up sequence

Parameter	Min	Nom	Max	Unit
t ₁			1	ms
t _{ON}			60	µs
t _{OFF}			60	µs
t _{VCC,IO,ON}	t ₁			µs
t _{VCC,IO,OFF}	t _{ON}			µs
t _{VCC,IO,OFF}	t _{OFF}			µs

Table 3. Power up parameters

Assembly Guidelines

Solder Paste

The ROK 101 007/1 module is made for surface mounting and the SSP connection pads have been formed after printing eutectic Tin/Lead solder paste. The solder paste to use is not critical as long as this is a normal eutectic solder paste. A preferred solder paste height is 150µm.

Soldering Profile

It must be noted that the module should not be allowed to be hanging upside down in the re-flow operation. This means that the module has to be assembled on the side of the PCB that is soldered last.

The re-flow process should be a regular surface mount soldering profile (full convection strongly preferred); the ramp-up should not be higher than 2°C/s and with a peak temperature of 210-235°C during 20-60 seconds.

Pad Size

It is recommended that the pads on the PCB should have a diameter of 0.7-0.9 mm. The surface finish on the PCB pads should be Nickel/Gold or a flat Tin/Lead surface or OSP (Organic Surface Protection).

Information given in this data sheet is believed to be accurate and reliable. However no responsibility is assumed for the consequences of its use nor for any infringement of patents or other rights of third parties which may result from its use. No license is granted by implication or otherwise under any patent or patent rights of Ericsson Components. These products are sold only according to Ericsson Components' general conditions of sale, unless otherwise confirmed in writing. Specifications subject to change without notice.

Microelectronics
Ericsson Components AB
SE-164 81 Kista-Stockholm, Sweden
Telephone: +46 8 757 50 00
www.ericsson.com/micro

Placement

The placement machine should be able to recognize odd BGA combinations (all ball recognition preferred) and be able to pick the component asymmetrical. The module contains a flat pick-area of 10mm diameter minimum. The weight of the module is typically 2.8gr.

Storage

Keep the component in its dry pack when not yet using the reel. After removal from the dry pack ensure that the modules are soldered onto the PCB within 48 hours.

Marking

Every module is marked with the following information on the:

- Component designation: "ROK 101 007/1".
- Ericsson's name and logotype.
- Manufacturing code (place, year, week) and batch number.
- CE logotype
- Type approval RTA no. See manual

Ordering Information

Package	Part No.
30 SSP	ROK 101 007/1

Packaging

All devices will be delivered in a package protecting them from electrostatic discharges and mechanical shock. The package will be marked with the following information:

- Delivery address.
- Purchase order-number
- Type of goods and component designation.
- Ericsson's name and logotype.
- Date of manufacture and batch number.
- Number of components in the package.

Abbreviations

ASIC - Application Specific Integrated Circuit
BER - Bit Error Rate
CMOS - Complementary Metal Oxide Semiconductor
C/I - Carrier to Interference Ratio
DCE - Data Circuit terminating Equipment
HCI - Host Controller Interface
ISM - Industrial Scientific and Medical
PCB - Printed Circuit Board
PCM - Pulse Code Modulation
PDA - Personal Digital Assistant
Rx - Receive
SIG - Special Interest Group
SSP - Screen Solder Print
Tx - Transmit
UART - Universal Asynchronous Receiver Transmitter
USB - Universal Serial Bus
VCO - Voltage Controlled Oscillator

APPENDIX A

Getting Started

The ROK 101 007/1 Bluetooth module is easy to use when designing a Bluetooth application. However, there is a need for know-how in the Bluetooth System specification v1.0A as well as the Profile specification v1.0A when designing and end-customer product.

- Bluetooth module
- Know-how in Bluetooth specification regarding HCI commands
- Test board with UART/PCM or USB I/F
- Visual C++ for PC SW design
- Preferably HCIdriver, L2CAP, RFCOMM and SDP from Ericsson

The list above show some parts that would make designing convenient.

All information needed, regarding how to drive the HCI over UART is specified in part H4 of the Bluetooth System v1.0A further more part H1 and also Appendix IX with message charts is relevant.

Below follow an example of how to set up an ACL link between to Bluetooth modules by using the UART I/F and also a schematic of how to interface the module and control it by a host, normally a PC or microcontroller.

Principle schematic for UART inter- connect

The inter-connection to the level-shifter when designing a test-board could be according to the schematic below. (Figure A1.)

The Bluetooth module can be connected as a DCE/DTE and a modem/nullmodem cable could therefore be used in-between the test-board and the PC.

Setting up a Bluetooth point-to-point connection

The Host Controller Interface (HCI) in the module is a command I/F. The host presents commands to the HCI and receives events back from the HCI of the module. The module Link Manager provides link set up capability to the HCI.

- Host_B Bluetooth module is set in paging scan mode – listening for a Bluetooth device asking for a new connection
- Host_A Bluetooth module is set in paging mode asking for a connection to Host_B

This is accomplished by first setting up the connection between the Host and the module and thereafter creating the connection between the modules using HCI commands.

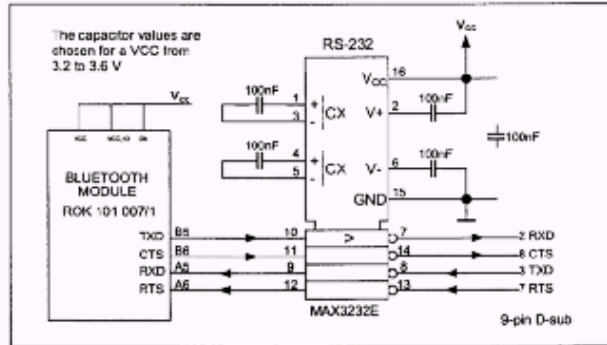

Figure A1. Bluetooth module connected as a DCE through level shifter

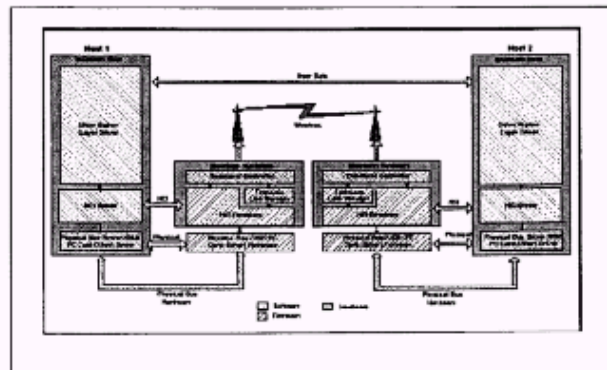

Figure A2. Bluetooth host to host communication

Host set-up via UART:

There are 4 different types of HCI-packets accepted on the UART I/F.

HCI packet type	HCI packet indicator
HCI command packet	0x01
HCI ACL data packet	0x02
HCI SCO data packet	0x03
HCI event packet	0x04

Table A1. HCI packets

The HCI packet indicator shall be sent immediately before the HCI packet. When the entire HCI packet has been received a new indicator should be expected.

The default speed setting is 57,6 kb/s and can be changed by sending a specified bit stream to the I/F - see Appendix C on how to change the speed setting of the UART.

When the speed set-up for the UART is made for both Host_A & B, the Command Packets can be sent and Event Packets received by the hosts. See HCI over UART in part H:4 of the Bluetooth System v1.0A for detailed information regarding parameters and protocol.

Soft Reset

First HCI command packet to send should be the RESET packet.

A Command_Complete_Event with a status parameter should be returned to the host.

Buffer information

Buffer information should be exchanged between the module and respective host by using HCI commands.

- **Read_Buffer_Size:** Providing the host with information on buffer size for ACL and SCO data packets for the module returned with a Command_Complete_Event packet. The host shall use this information for controlling the transmission
- **Host_Buffer_Size:** Providing the module with information on buffer size for ACL and SCO packets to the host.

It is the host that manages the data buffers of the Host Controller on the module.

Timers

It could be necessary to set important timers used by the module for time out handling. The timers are all set by writing to registers using HCI commands.

The default values can be checked in Specification of the Bluetooth System v1.0A part H:1 or by using Read_XXX_XXX commands.

Bluetooth Address

The hosts, using the HCI command Read_BD_ADDR will find the Bluetooth address of the module by the Command_Complete_Event with the BD_ADDR as a parameter.

By Remote_Name_Request, the BD_ADDR of the remote module can also be found.

Inquiry

The HCI command Inquiry with the parameters LAP, Inquiry_Length, and Num_Responses can also be used for collecting BD_ADDR of remote Bluetooth units.

Creating a Point-to-point connection**Page Scan mode**

To set a Bluetooth module in the mode for being able to connect to (Host_B), page scan mode, there are some settings that should be performed.

Command	OCF	Command parameters	Return parameters
HCI_Write_Scan_Enable	0x003	Scan_Enable	Scan

Table A2. HCI Write Scan Enable OCF code

The Write_Scan_Enable command with correct parameter (Scan_Enable=0x001A) will set the module in Page scan mode if the Command_Complete_Event is successful.

Furthermore the setting of authentication and encryption should be disabled (default) by using the:

- Write_Authentication_Enable
- Write_Encryption_Mode

The basic settings for getting into scan mode could be according to the below suggested script list.

- Read Buffer Size
- Set Event Filter
- Write Scan Enable: (Scan Enable: 0x03)
- Write Voice Setting: (Voice Channel Setting: 0x0060)
- Write Authentication Enable: (Authentication Enable: 0x00)
- Set Event Filter: (Connection Setup Filter: Connections from All Devices, Auto Accept: 0x02)
- Write Connection Accept Timeout: (Connection Accept Timeout: 0x2000)
- Write Page Timeout: (Page Timeout: 0x3000)

Page mode

The Create_Connection command is used to set-up a link to another Bluetooth device.

Command	CCP	Command parameters	Return parameters
HCI_Create_Connection	0x0005	BD_ADDR PktType Page_Scan_Mode Page_Scan_Offset	

Table A3. HCI Create Connection: CCP code

Create_Connection:
BD_ADDR: 0xYYYYYYYYYY,
Packet Type: 0x0008,
Page Scan Repetition Mode: 0x01,
Page Scan Mode: 0x00, Clock Offset: 0x0000

This command will cause the Link Manager to try to create a connection to the Bluetooth module with the appropriate BD_ADDR. The local Bluetooth module (Host_A) starts the paging process to set up a link to the page-scanning remote device (Host_B).

By LMP the negotiation between the two Bluetooth modules Link Managers (LM) the link set-up can be completed.

ACL link up and running

Host_A is the master of the point-to-point piconet and Host_B is slave. The unit starting the paging process is by definition the master. The link set-up is completed when the event Connection_Complete_Event is

returned to both Host_A and Host_B with the connection handle as one of the parameters and the status parameter 0x00 (success). When Bluetooth link is up and running the HCI data packets can be sent from host to host

The host must take care of generating the packages going from Host to Host Controller in the module over the UART I/F, in the same way the Host must arrange the packages received from the Host Controller.

Both sides need information on what kind of data is received, to be able to interpret the bit flow correctly.

For extensive information on setting up a Bluetooth link please refer to Bluetooth System v1.0A Appendix IX Message Sequence Charts

Adding an SCO link

When creating a voice connection using the PCM I/F, an ACL link must be up and running between the two devices, an SCO link can thereafter be added.

The control of the PCM I/F (FS, PCM_AVB and PCM_CLK) is handled by Ericsson specific HCI command – see Appendix C.

Driving SW

HCI- API

The Bluetooth module includes all HCI command capabilities according to Bluetooth System v1.0A. Furthermore, there is some Ericsson specific commands available for accessing HW registers and HW control – see Appendix C. SW for driving the module should be developed for the HCI interface.

There is source code SW available with Ericsson Bluetooth Developers Kit (EBDK), see Appendix B, which can be used for driving the module. This SW comes with the EBDK and has an HCI-API for application development on the HCI I/F.

Higher layer-API

Software (HCI driver, L2CAP, RFCOMM and SDP) are available in a generic, source code format, i.e. to be adapted to various operating systems.

- HCI driver – implements the HCI command driver used by the host
- L2CAP – handles protocol multiplexing, segmentation and re-assembly of packets
- RFCOMM – provides a serial port emulation over the L2CAP protocol
- SDP – Service Discovery Protocol provides information on the services available on a Bluetooth device

Additional SW for the application shall be developed for the actual application on top of the RFCOMM API. If the application is according to a SIG predefined profile, it should be implemented accordingly. New applications can be the driver of the specification of new profiles decided by the SIG – see Specification of the Bluetooth System v1.0 Profiles.

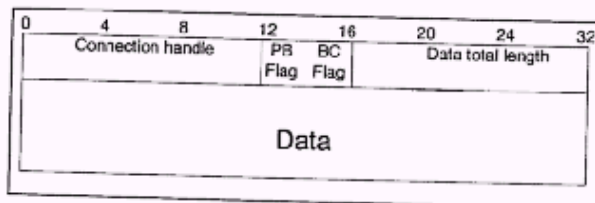

Table A4. ACL data packet

APPENDIX B

Development tools

Ericsson Bluetooth Development Kit (EBDK)

The easiest way of getting started is to use the Ericsson Bluetooth Developers Kit. It provides all parts necessary for developing applications for the Bluetooth module.

Available are:

- PC plug&play
- Demos using radio/baseband
- Macro capability
- C++ v5.0 Source code for use in applications
- HCDriver, L2CAP, SDP and RFCOMM for applications using UART communication
- Pins for electrical measurements
- Antennas

Development can easily take place on the EBDK platform and thereafter the implementation of the full Bluetooth capability can be setup by developed SW/HW and the Bluetooth module.

Software (HCDriver, L2CAP, RFCOMM and SDP) will be available in source code for PC.

- HCDriver – implements the HCI command driver used by the host
- L2CAP – handles protocol multiplexing, segmentation and re-assembly of packets
- RFCOMM – provides a serial port emulation over the L2CAP protocol
- SDP – Service Discovery Protocol provides information on the services available on a Bluetooth device

Technical support is available from the EBDK distributor. Please contact Ericsson Components for ordering and information regarding the EBDK and regarding extra daughter board with ROK 101 007/1 as add-on to the EBDK.

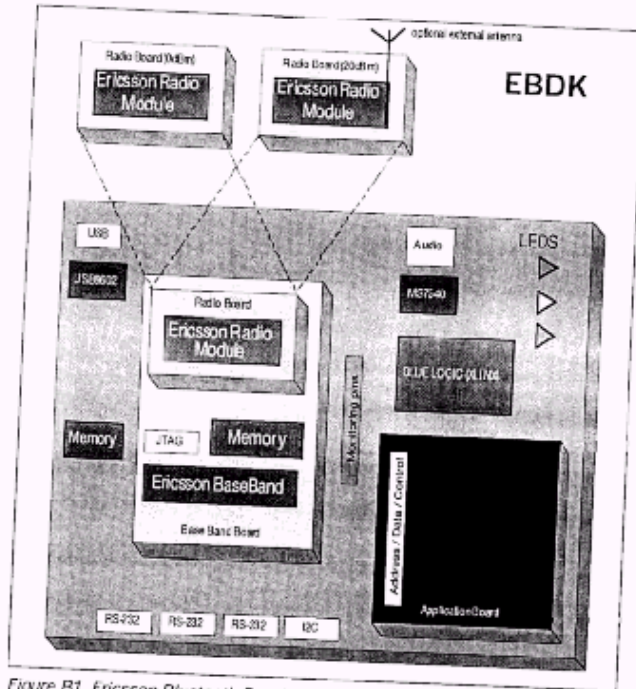

Figure B1. Ericsson Bluetooth Development Kit (EBDK)

Ericsson Bluetooth Starter Kit (EBSK)

A very small convenient kit, which preferably is used in point-to-multipoint configuration designs, based on the Bluetooth module ROK 101 007/1.

Please contact Ericsson Components for ordering and information regarding the Ericsson Bluetooth Starter Kit.

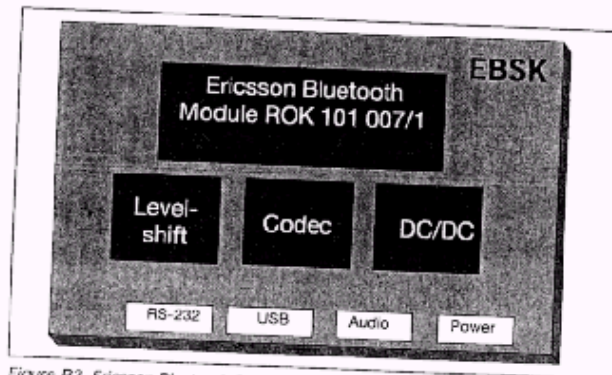

Figure B2. Ericsson Bluetooth Starter Kit (EBSK)

APPENDIX C

Bluetooth Information

This part will be updated and new information will be added continuously.

Radio

Fast Frequency hopping (1600 channel hops) with 79(23) channels available (2.402 to 2.480 GHz) and a symbol rate of 1Ms/s over the air exploits the maximum channel bandwidth in the unlicensed ISM band.

To sustain a high transfer rate in busy radio environment, the frequency hopping together with advanced coding techniques maximizes the throughput.

During Page and Inquiry the hopping frequency is risen to 3200 hops/s to enhance the time needed for connection set-up.

Modulation technique is a binary Gaussian Frequency Shift Keying GFSK, with a BT product of 0.5. The channel bandwidth is 1 MHz and the frequency deviation from the carrier frequency of the RF channel is between +/-140 to +/-175 kHz for representing a '1'/'0'.

Country	Frequency range	RF channels	
Europe & USA	2400-2483.5 MHz	$f = 2402 + k$ MHz	$k = 0 \dots 78$
Japan	2471-2497 MHz	$f = 2473 + k$ MHz	$k = 0 \dots 22$
Spain	2445-2475 MHz	$f = 2449 + k$ MHz	$k = 0 \dots 22$
France	2446.5-2483.5 MHz	$f = 2454 + k$ MHz	$k = 0 \dots 22$

Table C1. Frequency ranges used.

A rapid process is ongoing to harmonise Spanish, French and Japanese frequency ranges with the rest of the world.

Data and parameter formats

There are exceptions in the Bluetooth system for data and parameter formats – general rules below.

- All values are in Binary and Hexadecimal little Endian formats
- Negative values must use 2's complement format

- Array parameter notation is parameterA[], parameterB[],...
- All parameter values are sent/received in little Endian format. The least significant byte is sent first – unless noted otherwise.

HCI Opcodes

The Opcodes have been changed during the ongoing standardisation work. Below is the description on how to send opcodes to the module.

Below is the general HCI command packet format depicted as well as a byte order description.

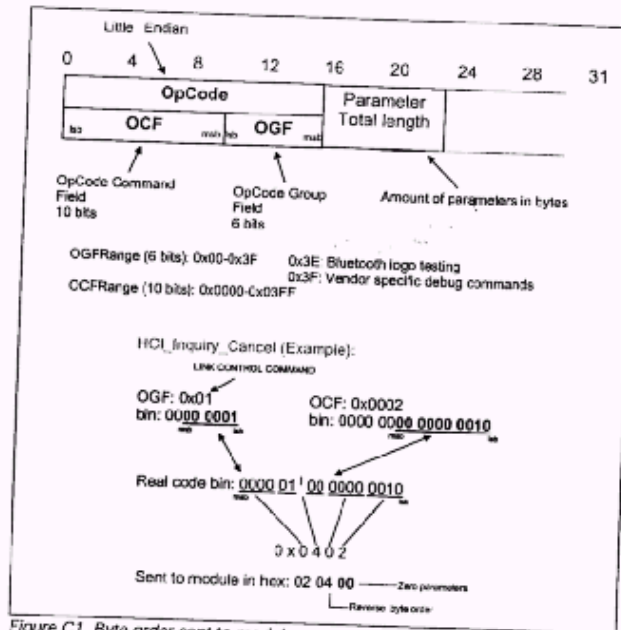

Figure C1. Byte order sent to module

UART speed setting

The baud rate is changed with an Ericsson specific HCI command. HCI_Ericsson_Sot_UART_Baud_Rate

The command has one parameter, baud rate - one byte long according to the table below. The op-code for the command is 0xfc07 - the last figure is due to a possible change.

Sending the command should be performed accordingly: 07 fc 01 yz, where yz is the chosen baud rate from the table.

The op-code is sent in reverse byte order. 01 is the parameter length, in this case one byte. Remember to add the HCI packet indicator.

Observe - When changing the baud rate for the module the host also has to change the baud rate.

Observe - Removing power to the module the baud rate will be reset to 57.6 kbps.

Observe - Two zeros are not printed in the beginning of the binary parameters below. The length of the parameter is 1 byte.

Ericsson specific HCI commands

By using the Ericsson specific HCI command there are a number of features available for the application design.

Contact Ericsson Components for a complete commands reference list.

UART speed	Parameter to send
460.8 kbps	00000
230.4 kbps	00001
115.2 kbps	00010
57.6 kbps	00011
28.8 kbps	00100
14.4 kbps	00101
7200 bps	00110
3600 bps	00111
1800 bps	01000
900 bps	01001
153.6 kbps	10000
76.8 kbps	10001
38.4 kbps	10010
19.2 kbps	10011
9600 bps	10100
4800 bps	10101
2400 bps	10110
1200 bps	10111
600 bps	11000
300 bps	11001

Table C2. UART speed setting parameter

Antennas

Antenna design is not specified and standardised in the to Bluetooth System v1.0A.

Many different types of antennas can and will be used. Application specific antennas suitable for production are expected to be a new market for antenna designs.

Ericsson Components have antennas for the EBDK and other development kits.

Contact Ericsson Components for information on antennas.

Contacting Ericsson Components

For further information regarding Bluetooth technology, components and development tools, please contact Ericsson Components:

Telephone:
 Scandinavia: +46 8 757 47 00
 Europe: +44 1793 488 300
 North America: +1 877 374 26 42
 Rest of World: +46 8 757 47 00

www.ericsson.se/microe