



EN		IT		FR		ES	
TECHNICAL SPECIFICATIONS		CARATTERISTICHE TECNICHE		CARACTÉRISTIQUES TECHNIQUES		CARACTERÍSTICAS TÉCNICAS	
Product type	Two-way receiver	Tipologia	Ricevitore bidirezionale	Typologie	Récepteur bidirectionnel	Tipo	Receptor bidireccional
Decoding	“LR”	Decodifica	“LR”	Décodage	«LR»	Decodificación	“LR”
Input impedance	50 Ω	Impedenza di ingresso	50 Ω	Impédance d'entrée	50 Ω	Impedancia de entrada	50 Ω
Reception frequency	OXILR: 433.75 MHz; OXILR/A: 915.75 MHz	Frequenza di ricezione	OXILR: 433,75 MHz; OXILR/A: 915,75 MHz	Fréquence de réception	OXILR : 433,75 MHz ; OXILR/A : 915,75 MHz	Frecuencia de recepción	OXILR: 433,75 MHz; OXILR/A: 915,75 MHz
Transmission frequency	OXILR: 433.75 MHz; OXILR/A: 915.75 MHz	Frequenza di trasmissione	OXILR: 433,75 MHz; OXILR/A: 915,75 MHz	Fréquence de transmission	OXILR : 433,75 MHz ; OXILR/A : 915,75 MHz	Frecuencia de transmisión	OXILR: 433,75 MHz; OXILR/A: 915,75 MHz
Outputs	4 (on “SM” plug-type connector)	Uscite	4 (su connettore “SM” ad innesto)	Sorties	4 (sur connecteur « SM » enfichable)	Salidas	4 (en conector “SM” con empalme)
Sensitivity	-120 dBm	Sensibilità	-120 dBm	Sensibilité	-120 dBm	Sensibilidad	-120 dBm
Absorption	50 mA (maximum)	Assorbimento	50 mA (massimo)	Absorption	50 mA (maximum)	Absorción	50 mA (máximo)
Radiated power (ERP)	< 10 mW (OXILR)	Potenza irradiata (ERP)	< 10 mW (OXILR)	Puissance irradiée (ERP)	< 10 mW (OXILR)	Potencia radiada (ERP)	< 10 mW (OXILR)
Dimensions (mm)	W 49,5; H 41,9; D 18	Dimensioni (mm)	L 49,5; H 41,9; P 18	Dimensions (mm)	L 49,5 ; H 41,9 ; P 18	Medidas (mm)	L 49,5; H 41,9; P 18
Weight (g)	22	Peso (g)	22	Poids (g)	22	Peso (g)	22
Operating temperature	-20 °C ... +55 °C	Temperatura di funzionamento	-20 °C ... +55 °C	Température de fonctionnement	-20 °C ... +55 °C	Temperatura de funcionamiento	-20 °C ... +55 °C

Radio receiver

ISO630A02MM_18-12-2019

- EN - Instructions for the fitter
- IT - Istruzioni per l'installatore
- FR - Instructions pour l'installateur
- ES - Instrucciones para el instalador
- DE - Anweisungen für den installateur
- PL - Instrukcje dla instalatora
- NL - Aanwijzingen bestemd voor de installateur
- RU - Инструкции и предупреждения по монтажу

For more detailed instructions visit the **Support section** on Niceforyou.com or **scan this QR code**.



Nice S.p.A.
Via Callalta, 1
31046 Oderzo TV Italy
info@niceforyou.com

www.niceforyou.com

Nice

DE		PL		NL		RU	
TECHNISCHE DATEN		PARAMETRY TECHNICZNE		TECHNISCHE KENMERKEN		ТЕХНИЧЕСКИЕ ХАРАКТЕРИСТИКИ	
Typ	Bidirektionaler Empfänger	Typologia	Odbiornik dwukierunkowy	Type	Bidirectionele ontvanger	Тип	Двусторонний приемник
Decodierung	„LR“	Odkodowanie	„LR“	Decodeert	“LR”	Кодировка	«LR»
Eingangsimpedanz	50 Ω	Impedancja wejścia	50 Ω	Ingangsimpedantie	50 Ω	Входной импеданс	50 Ом
Empfangsfrequenz	OXILR: 433,75 MHz; OXILR/A: 915,75 MHz	Częstotliwość odbioru	OXILR: 433,75 MHz; OXILR/A: 915,75 MHz	Ontvangstfrequentie	OXILR: 433,75 MHz; OXILR/A: 915,75 MHz	Частота приема	OXILR: 433,75 МГц; OXILR/A: 915,75 МГц
Sendefrequenz	OXILR: 433,75 MHz; OXILR/A: 915,75 MHz	Częstotliwość nadawania	OXILR: 433,75 MHz; OXILR/A: 915,75 MHz	Zendfrequentie	OXILR: 433,75 MHz; OXILR/A: 915,75 MHz	Частота передачи	OXILR: 433,75 МГц; OXILR/A: 915,75 МГц
Ausgänge	4 (am SM Steckverbinder)	Wyjścia	4 (na złączu „SM” wtykowym)	Uitgangen	4 (op SM-aansluitconnector)	Выходы	4 (на разъеме «SM»)
Empfindlichkeit	-120 dBm	Czułość	-120 dBm	Gevoeligheid	-120 dBm	Чувствительность	-120 дБм
Stromaufnahme	max. 50 mA	Pobór prądu	50 mA (maksymalnie)	Opgenomen stroom	50 mA (max.)	Потребляемый ток	50 mA (максимальный)
Sendeleistung (ERP)	< 10 mW (OXILR)	Moc wypromieniowana (ERP)	< 10 mW (OXILR)	Uitgestraald vermogen (ERP)	< 10 mW (OXILR)	Излучаемая мощность (ERP)	< 10 мВ (OXILR)
Abmessungen (mm)	L 49,5; H 41,9; P 18	Wymiary (mm)	L 49,5; H 41,9; P 18	Afmetingen (mm)	L 49,5; H 41,9; D 18	Размеры (мм)	L 49,5; H 41,9; P 18
Gewicht (g)	22	Masa (g)	22	Gewicht (g)	22	Вес (г)	22
Betriebstemperatur	-20 °C ... -55 °C	Temperatura robocza	-20 °C ... +55 °C	Bedrijfstemperatuur	-20 °C ... +55 °C	Рабочая температура	-20 °C ... +55 °C

⚠	EN	This manual is a summary of the installation, programming and operating phases of the receiver. The full instruction manual can be downloaded from the website www.niceforyou.com
⚠	IT	Questo manuale è una sintesi delle fasi d'installazione, programmazione e uso del ricevitore. Il manuale istruzioni completo è scaricabile dal sito www.niceforyou.com
⚠	FR	Ce manuel est une synthèse des phases d'installation, programmation et utilisation du récepteur. Le manuel d'instructions complet peut être téléchargé depuis le site www.niceforyou.com
⚠	ES	Este manual es una síntesis de las fases de instalación, programación y uso del receptor. El manual de instrucciones completo puede descargarse del sitio www.niceforyou.com

⚠	DE	Diese Anleitung bietet einen Überblick über die Schritte der Installation, Programmierung und Nutzung des Empfängers in Kurzform. Die vollständige Anleitung steht auf der Website www.niceforyou.com zum Download bereit.
⚠	PL	Niniejsza instrukcja jest streszczeniem faz montażu, programowania i użytkownika odbiornika. Kompletną instrukcję można pobrać na stronie www.niceforyou.com
⚠	NL	Deze handleiding in een samenvatting van de installatie-, programmerings- en gebruiksfases van de ontvanger. De volledige instructiehandleiding kan gedownload worden op de website www.niceforyou.com
⚠	RU	Данное руководство являет собой синтез фаз монтажа и пуска в работу согласно стандартно заданным значениям: полное руководство с инструкциями может быть загружена с веб-сайта www.niceforyou.com

• EN - SIMPLIFIED EU DECLARATION OF CONFORMITY

Hereby Nice S.p.A. declares that the radio equipment type OXILR is in compliance with Directive 2014/53/EU. The full text of the EU declaration of conformity is available at the following internet address: <https://www.niceforyou.com/en/support>

COMPLIANCE WITH THE FCC RULES (PART 15) AND WITH RSS-210 RULES

This device contains licence-exempt transmitter(s)/ receiver(s) that comply with Innovation, Science and Economic Development Canada's licence-exempt RSS(s); and with Part 15 of the FCC rules of the United States of America. Operation is subject to the following two conditions: (1) This device may not cause interference. (2) This device must accept any interference, including interference that may cause undesired operation of the device. Any changes or modifications made to this device, without the express permission of the manufacturer, may void the user's authority to operate this device.

WARNINGS

This device must be professionally installed. The only permitted antenna is a 17 cm whip included. Changeable antenna that must be professionally installed. For OXILR/A must not use the coaxial cable but connect the whip cable included.

• IT - DICHIARAZIONE DI CONFORMITÀ UE SEMPLIFICATA

Il fabbricante Nice S.p.A. dichiara che il tipo di apparecchiatura radio OXILR è conforme alla direttiva 2014/53/UE. Il testo completo della dichiarazione di conformità UE è disponibile al seguente indirizzo Internet: <https://www.niceforyou.com/it/supporto>

• DE - VEREINFACHTE EU-KONFORMITÄTS ERKLÄRUNG

Hiermit erklärt Nice S.p.A. dass der Funkanlagentyp OXILR der Richtlinie 2014/53/EU entspricht. Der vollständige Text der EU-Konformitätserklärung ist unter der folgenden Internetadresse verfügbar: <https://www.niceforyou.com/de/support>

• PL - UPROSZCZONA DEKLARACJA ZGODNOŚCI UE

Nice S.p.A. niniejszym oświadcza, że typ urządzenia radiowego OXILR jest zgodny z dyrektywą 2014/53/UE. Pełny tekst deklaracji zgodności UE jest dostępny pod następującym adresem internetowym: <https://www.niceforyou.com/en/support>

• NL - VEREENVOUDIGDE EU-CONFORMITEITSVERKLARING

Hierbij verklaar ik Nice S.p.A., dat het type radioapparatuur OXILR conform is met Richtlijn 2014/53/EU. De volledige tekst van de EU-conformiteitsverklaring kan worden geraadpleegd op het volgende internetadres: <https://www.niceforyou.com/en/support>

• FR - DÉCLARATION UE DE CONFORMITÉ SIMPLIFIÉE

Le soussigné Nice S.p.A. déclare que l'équipement radioélectrique du type OXILR est conforme à la directive 2014/53/UE. Le texte complet de la déclaration UE de conformité est disponible à l'adresse internet suivante: <https://www.niceforyou.com/fr/support>

CONFORMITÉ AUX NORMES CNR-210 ET AUX NORMES FCC (PARTIE 15)

L'émetteur/récepteur exempt de licence contenu dans le présent appareil est conforme aux CNR d'Innovation, Sciences et Développement économique Canada applicables aux appareils radio exempts de licence. L'exploitation est autorisée aux deux conditions suivantes : 1) L'appareil ne doit pas produire de brouillage; 2) L'appareil doit accepter tout brouillage radioélectrique subi, même si le brouillage est susceptible d'en compromettre le fonctionnement. Toutes les changements ou les modifications apportés à cet appareil, sans l'autorisation expresse du fabricant, pourrait annuler l'autorité de l'utilisateur à utiliser l'équipement.

AVERTISSEMENTS

Cet appareil doit être installé par des professionnels. La seule antenne autorisée est le câble de 17cm qui se trouve dans l'emballage du récepteur. Antenne amovible qui doit être installée par des professionnels. Pour le OXILR/A on ne doit pas utiliser le câble coaxial, mais le câble de 17cm qui se trouve dans l'emballage du récepteur.

• ES - DECLARACIÓN UE DE CONFORMIDAD SIMPLIFICADA

Por la presente Nice S.p.A. declara que el tipo de equipo radioeléctrico OXILR es conforme con la Directiva 2014/53/UE. El texto completo de la declaración UE de conformidad está disponible en la dirección Internet siguiente: <https://www.niceforyou.com/es/soporte>







CONFORMIDAD CON NORMAS RSS-210 Y CON NORMAS FCC (PARTE 15)

Este producto es cumple con las normas RSS-210 para la Industria de Canadá, aplicables a productos exentos de licencia de radio, y con las disposiciones establecidas en la parte 15 de las normas FCC de los Estados Unidos de América. El funcionamiento está sujeto a estas dos condiciones: (1) el producto no debe causar interferencias; (2) el producto debe aceptar cualquier interferencia recibida, incluidas posibles interferencias que podrían causar un funcionamiento no adecuado de el producto. Los cambios o modificaciones de este producto, sin la autorización expresa del fabricante, podrá invalidar la facultad del usuario para poner en funcionamiento este dispositivo.



• RU - УПРОЩЕННАЯ ДЕКЛАРАЦИЯ СООТВЕТСТВИЯ ЕС

Изготовитель Nice S.p.A. заявляет, что тип радиочастотного устройства OXILR соответствует положениям Директивы 2014/53/EU. Полный текст декларации соответствия EU доступен по следующему Интернет- адресу: <https://www.niceforyou.com/en/support>

	• EN - Disconnect power supply • IT - Togliere alimentazione elettrica • FR - Couper le courant • ES - Desconectar la alimentación eléctrica • DE - Die Stromversorgung unterbrechen • PL - Odłączyć zasilanie elektryczne • NL - Elektrische voeding onderbreken • RU - Отключите электропитание
	• EN - Restore power supply • IT - Dare alimentazione elettrica • FR - Redonner le courant • ES - Conectar la alimentación eléctrica • DE - Die Stromversorgung herstellen • PL - Włączyć zasilanie elektryczne • NL - Elektrische voeding inschakelen • RU - Подать электропитание
	• EN - (on the receiver) LED "B" STEADY LIT • IT - (sul ricevitore) led "B" ACCESO FISSO • FR - (sur le récepteur) led « B » ALLUMÉE FIXE • ES - (en el receptor) led "B" ENCENDIDO FIJO • DE - (am Empfänger) Led B LEUCHTET ANHALTEND • PL - (na odbiorniku) dioda „B” ŚWIECI STAŁYM ŚWIATŁEM • NL - (op de ontvanger) led "B" BRANDT PERMANENT • RU - (на приемнике) светодиод «B» ГОРИТ НЕПРЕРЫВНЫМ СВЕТОМ
	• EN - (on the receiver) LED "B" LONG FLASH • IT - (sul ricevitore) led "B" CON LAMPEGGIO LUNGO • FR - (sur le récepteur) led « B » avec CLIGNOTEMENT LONG • ES - (en el receptor) led "B" CON PARPADEO LARGO • DE - (am Empfänger) Led B mit LANGEM BLINKZEICHEN • PL - (na odbiorniku) dioda „B” Z DŁUGIM MIGANIEM • NL - (op de ontvanger) led "B" LANG KNIPPEREND • RU - (на приемнике) светодиод «B» МЕДЛЕННО МИГАЕТ
	• EN - (on the receiver) LED "B" QUICK FLASH • IT - (sul ricevitore) led "B" CON LAMPEGGIO VELOCE • FR - (sur le récepteur) led « B » avec CLIGNOTEMENT RAPIDE • ES - (en el receptor) led "B" CON PARPADEO RÁPIDO • DE - (am Empfänger) Led B mit KURZEM BLINKZEICHEN • PL - (na odbiorniku) dioda „B” Z SZYBKIM MIGANIEM • NL - (op de ontvanger) led "B" SNEL KNIPPEREND • RU - (на приемнике) светодиод «B» БЫСТРО МИГАЕТ
	• EN - (on the receiver) LED "B" OFF • IT - (sul ricevitore) led "B" SPENTO • FR - (sur le récepteur) led « B » ÉTEINTE • ES - (en el receptor) led "B" APAGADO • DE - (am Empfänger) Led B VERLÖSCHT • PL - (na odbiorniku) dioda „B” ZGASZONA • NL - (op de ontvanger) led "B" UIT • RU - (на приемнике) светодиод «B» НЕ ГОРИТ
	• EN - Wait ... • IT - Attendere ... • FR - Veuillez patienter... • ES - Esperar... • DE - Bitte warten ... • PL - Zaczekać ... • NL - Wachten ... • RU - Ожидайте...
	• EN - Perform the operation within 5 seconds ... • IT - Effettuare l'operazione entro 5 secondi ... • FR - Effectuer l'opération dans les 5 secondes... • ES - Realizar la operación en no más de 5 segundos ... • DE - Den Vorgang innerhalb von 5 Sekunden ausführen ... • PL - Wykonać działanie w ciągu 5 sekund ... • NL - De handling binnen 5 seconden uitvoeren ... • RU - Выполните данную операцию не позднее чем через 5 секунд ...
	• EN - Hold down key "A" of the receiver • IT - Mantenere premuto il tasto "A" del ricevitore • FR - Maintenir enfoncée la touche « A » du récepteur • ES - Mantener pulsada la tecla "A" del receptor • DE - Taste A des Empfängers gedrückt halten • PL - Przytrzymać wciśnięty przycisk „A” odbiornika • NL - De toets "A" van de ontvanger ingedrukt houden • RU - Нажмите и удерживайте нажатой кнопку «A» на приемнике

	• EN - Press and release key "A" of the receiver • IT - Premere e rilasciare il tasto "A" del ricevitore • FR - Appuyer et relâcher la touche « A » du récepteur • ES - Pulsar y soltar la tecla "A" del receptor • DE - Taste A des Empfängers drücken und loslassen • PL - Przycisnąć i zwolnić przycisk „A” odbiornika • NL - De toets "A" van de ontvanger indrukken en loslaten • RU - Нажмите и отпустите кнопку «A» на приемнике
	• EN - Release key "A" of the receiver • IT - Rilasciare il tasto "A" del ricevitore • FR - Relâcher la touche « A » du récepteur • ES - Soltar la tecla "A" del receptor • DE - Taste A des Empfängers loslassen • PL - Zwolnić przycisk „A” odbiornika • NL - De toets "A" van de ontvanger loslaten • RU - Отпустите кнопку «A» на приемнике
	• EN - Press and release the desired transmitter key • IT - Premere e rilasciare il tasto desiderato del trasmettitore • FR - Appuyer et relâcher la touche désirée de l'émetteur • ES - Pulsar y soltar la tecla deseada del transmisor • DE - Die betreffende Taste des Handsenders drücken und wieder loslassen • PL - Przycisnąć i zwolnić żądany przycisk nadajnika • NL - De gewenste toets van de zender indrukken en loslaten • RU - Нажмите и отпустите нужную кнопку на передатчике
	• EN - Hold down the desired transmitter key • IT - Mantenere premuto il tasto desiderato del trasmettitore • FR - Maintenir appuyée la touche désirée de l'émetteur • ES - Mantener pulsada la tecla deseada del transmisor • DE - Die betreffende Taste des Handsenders gedrückt halten • PL - Przytrzymać wciśnięty żądany przycisk nadajnika • NL - De gewenste toets van de zender ingedrukt houden • RU - Нажмите и удерживайте нажатой нужную кнопку на передатчике
	• EN - Release the desired transmitter key • IT - Rilasciare il tasto desiderato del trasmettitore • FR - Relâcher la touche désirée de l'émetteur • ES - Soltar la tecla deseada del transmisor • DE - Die betreffende Taste des Handsenders loslassen • PL - Zwolnić żądany przycisk nadajnika • NL - De gewenste toets van de zender loslaten • RU - Отпустите нужную кнопку на передатчике
	• EN - Read the control unit's instruction manual • IT - Leggere il manuale istruzioni della centrale di comando • FR - Lire le manuel d'instructions de la logique de commande • ES - Leer el manual de instrucciones de la central de mando • DE - Die Bedienungsanleitung der Steuerung lesen • PL - Przeczytać instrukcję centrali sterującej • NL - De instructiehandleiding van de besturingseenheid lezen • RU - Прочитайте руководство по эксплуатации пульта управления
	• EN - Observe when LED "B" emits signals • IT - Osservare quando il led "B" emette delle segnalazioni • FR - Observer quand la led « B » émet des signaux • ES - Observar en qué momento el led "B" emite señales de aviso • DE - Kontrollieren, wann Led B Blinksignale ausgibt • PL - Obserwować, kiedy dioda „B” wyemituje sygnalizację • NL - Observeren wanneer de led "B" signalen geeft • RU - Следите за сигнализацией, осуществляемой с помощью светодиода «B»

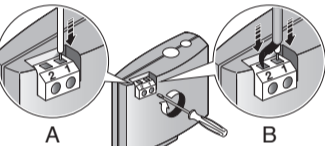
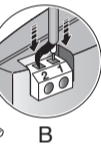
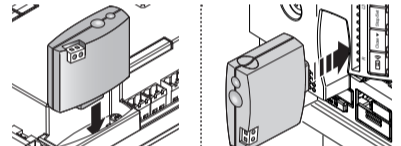
1 • EN - INSTALLATION AND CONNECTION • IT - INSTALLAZIONE E COLLEGAMENTI • FR - INSTALLATION ET RACCORDEMENTS • ES - INSTALACIÓN Y CONEXIONES • DE - INSTALLATION UND ANSCHLÜSSE • PL - MONTAŻ I PODŁĄCZENIA • NL - INSTALLATIE EN AANSLUITINGEN • RU - УСТАНОВКА И ПОДКЛЮЧЕНИЕ

				
• EN - A = antenna supplied - B = coaxial cable (alternatively) • IT - A = antenna in dotazione - B = cavo coassiale (in alternativa) • FR - A = antenne fournie - B = câble coaxial (autrement) • ES - A = antena suministrada - B = cable coaxial (o bien) • DE - A = beiliegende Antenne - B = Koaxialkabel (Falls) • PL - A = dołączoną antenę - B = kablem współosiowym (ewentualnie) • NL - A = meegeleverde antenne - B = coaxkabel (als alternatief) • RU - A = входящую в комплект поставки антенну - B = коаксиальным кабелем (в качестве альтернативного варианта)				















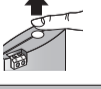

2 • EN - MEMORISATION IN "MODE 1" • IT - MEMORIZZAZIONE IN "MODO 1" • FR - MÉMORISATION EN « MODE 1 » • ES - MEMORIZACIÓN EN "MODO 1" • DE - SPEICHERN IN „MODUS 1“ • PL - WCZYTYWANIE W „TRYBIE 1” • NL - GEHEUGENOPSLAG IN "MODUS 1" • RU - СОХРАНЕНИЕ В ПАМЯТИ В «РЕЖИМЕ 1»

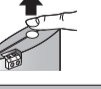

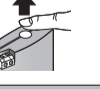

3 • EN - MEMORISATION IN "MODE 2" • IT - MEMORIZZAZIONE IN "MODO 2" • FR - MÉMORISATION EN « MODE 2 » • ES - MEMORIZACIÓN EN "MODO 2" • DE - SPEICHERN IN „MODUS 2“ • PL - WCZYTYWANIE W „TRYBIE 2” • NL - GEHEUGENOPSLAG IN "MODUS 2" • RU - СОХРАНЕНИЕ В ПАМЯТИ В «РЕЖИМЕ 2»

						
---	---	---	---	---	---	---

4 • EN - DELETING THE RECEIVER'S MEMORY (FULLY OR PARTIALLY) • IT - CANCELLAZIONE DELLA MEMORIA DEL RICEVITORE (TOTALE O PARZIALE) • FR - EFFACEMENT DE LA MÉMOIRE DU RÉCEPTEUR (TOTAL OU PARTIEL) • ES - BORRADO DE LA MEMORIA DEL RECEPTOR (TOTAL O PARCIAL) • DE - VOLLSTÄNDIGES ODER TEILWEISES LÖSCHEN DES EMPFÄNGERSPEICHERS • PL - KASOWANIE PAMIĘCI ODBIORNIKA (CAŁKOWITE LUB CZĘŚCIOWE) • NL - HET GEHEUGEN VAN DE ONTVANGER WISSEN (VOLLEDIG OF GEDEELTELIJK) • RU - ОЧИСТКА ПАМЯТИ ПРИЕМНИКА (ПОЛНАЯ ИЛИ ЧАСТИЧНАЯ)

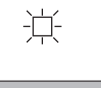
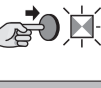
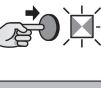
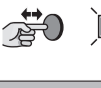
																
---	---	---	---	---	---	---	---	---	---	---	---	---	---	---	---	---

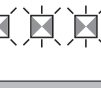
5 • EN - DELETING A SINGLE TRANSMITTER OR A SINGLE KEY FROM THE RECEIVER MEMORY • IT - CANCELLAZIONE DI UN SINGOLO TRASMETTITORE O DI UN SINGOLO TASTO DALLA MEMORIA DEL RICEVITORE • FR - EFFACEMENT D'UN SEUL ÉMETTEUR OU D'UNE SEULE TOUCHE DE LA MÉMOIRE DU RÉCEPTEUR • ES - BORRADO DE UN SOLO TRANSMISOR O DE UNA SOLA TECLA DE LA MEMORIA DEL RECEPTOR • DE - LÖSCHEN EINES HANDSENDERS ODER EINER TASTE AUS DEM SPEICHER DES EMPFÄNGERS • PL - KASOWANIE POJEDYNCZEGO NADAJNIKA LUB POJEDYNCZEGO PRZYCIŚKI Z PAMIĘCI ODBIORNIKA • NL - EEN ENKELE ZENDER OF EEN ENKELE TOETS UIT HET GEHEUGEN VAN DE ONTVANGER WISSEN • RU - УДАЛЕНИЕ ОДНОГО ПЕРЕДАТЧИКА ИЛИ ОДНОЙ КНОПКИ ИЗ ПАМЯТИ ПРИЕМНИКА

							
---	---	--	--	---	---	---	---