

FCC 47 CFR PART 15 SUBPART C

Product Type : Media Streamer
Applicant : Gigastone Corp.
Address : 12F, No. 480, Rueiguang Rd., Neihu Dist., Taipei 114, Taiwan
Trade Name : Gigastone
Model Number : A2-25DE
Test Specification : FCC 47 CFR PART 15 SUBPART C: Oct., 2012
ANSI C63.4-2009
Receive Date : Aug. 13, 2013
Test Period : Aug. 26 ~ Sep. 06, 2013
Issue Date : Sep. 13, 2013

Issue by

A Test Lab Techno Corp.
No. 140-1, Changan Street, Bade City,
Taoyuan County 334, Taiwan R.O.C.
Tel : +886-3-2710188 / Fax : +886-3-2710190



Taiwan Accreditation Foundation accreditation number: 1330

Note: This report shall not be reproduced except in full, without the written approval of A Test Lab Techno Corp. This document may be altered or revised by A Test Lab Techno Corp. personnel only, and shall be noted in the revision section of the document. The client should not use it to claim product endorsement by TAF, or any government agencies. The test results in the report only apply to the tested sample.

Revision History

Rev.	Issue Date	Revisions	Revised By
00	Sep. 13, 2013	Initial Issue	

Verification of Compliance

Issued Date: 09/13/2013

Product Type : Media Streamer
Applicant : Gigastone Corp.
Address : 12F, No. 480, Rueiguang Rd., Neihu Dist., Taipei 114, Taiwan
Trade Name : Gigastone
Model Number : A2-25DE
FCC ID : PLE-WD2502
EUT Rated Voltage : DC 5V, 1000mA
Test Voltage : 120 Vac / 60 Hz
Applicable Standard : FCC 47 CFR PART 15 SUBPART C: Oct., 2012
ANSI C63.4-2009

Test Result : Complied

Performing Lab. : A Test Lab Techno Corp.
No. 140-1, Changan Street, Bade City,
Taoyuan County 334, Taiwan R.O.C.
Tel : +886-3-2710188 / Fax : +886-3-2710190
Taiwan Accreditation Foundation accreditation number: 1330
<http://www.atl-lab.com.tw/e-index.htm>



The above equipment was tested by A Test Lab Techno Corp. The test data, data evaluation, test procedures, and equipment configurations shown in this report were made in accordance with the procedures given in ANSI C63.4: 2009 and the energy emitted by the sample tested as described in this report is in compliance with the requirements of FCC Rules Part 15.207, 15.209, 15.247 .

The test results of this report relate only to the tested sample identified in this report.

Approved By
(Manager)

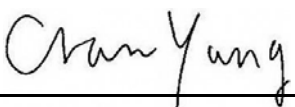
: 
(Cran Yang)

Reviewed By

(Testing Engineer)

: 
(Fly Lu)

TABLE OF CONTENTS

1	General Information	6
2	EUT Description	7
3	Test Methodology	8
3.1.	Mode of Operation.....	8
3.2.	EUT Exercise Software	8
3.3.	Configuration of Test System Details	9
3.4.	Test Site Environment	9
4	Conducted Emission Measurement	10
4.1.	Limit	10
4.2.	Test Instruments	10
4.3.	Test Setup.....	10
4.4.	Test Procedure	11
4.5.	Test Result.....	12
5	Radiated Emission Measurement.....	14
5.1.	Limit	14
5.2.	Test Instruments	14
5.3.	Setup	15
5.4.	Test Procedure	16
5.5.	Test Result.....	18
6	Maximum Conducted Output Power Measurement.....	25
6.1.	Limit	25
6.2.	Test Setup.....	25
6.3.	Test Instruments	25
6.4.	Test Procedure	25
6.5.	Test Result.....	26
7	6dB RF Bandwidth and 99 % Occupied Bandwidth Measurement	28
7.1.	Limit	28
7.2.	Test Setup.....	28
7.3.	Test Instruments	28
7.4.	Test Procedure	28
7.5.	Test Result.....	29
7.6.	Test Graphs	30
8	Maximum Power Density Measurement	34
8.1.	Limit	34
8.2.	Test Setup.....	34
8.3.	Test Instruments	34
8.4.	Test Procedure	34
8.5.	Test Result.....	35
8.6.	Test Graphs	36

9	Out of Band Conducted Emissions Measurement	40
9.1.	Limit	40
9.2.	Test Setup.....	40
9.3.	Test Instruments	40
9.4.	Test Procedure	40
9.5.	Test Graphs	41
10	Band Edges Measurement	53
10.1.	Limit	53
10.2.	Test Setup.....	53
10.3.	Test Instruments	53
10.4.	Test Procedure	54
10.5.	Test Result.....	55
11	Antenna Measurement.....	71
11.1.	Limit	71
11.2.	Antenna Connector Construction	71

1 General Information

1.1 Summary of Test Result

Standard		Item	Result	Remark
15.247	RSS-GEN			
15.207	7.2.2	AC Power Conducted Emission	PASS	-----
Standard		Item	Result	Remark
15.247	RSS-210			
15.247(d)	A8.5	Transmitter Radiated Emissions	PASS	-----
15.247(b)(3)	A8.4	Max. Output Power	PASS	-----
15.247(a)(2)	A8.2 (a)	6dB RF Bandwidth	PASS	-----
15.247(e)	A8.2 (b)	Power Spectral Density	PASS	-----
15.247(c)	A8.5	Out of Band Conducted Spurious Emission	PASS	-----
15.247(d)	A8.5	Band Edge Measurement	PASS	-----
15.247(c)	A8.5	Occupied Bandwidth Measurement	PASS	-----
15.203	-	Antenna Requirement	PASS	-----

The test results of this report relate only to the tested sample(s) identified in this report. Manufacturer or whom it may concern should recognize the pass or fail of the test result.

1.2 Measurement Uncertainty

Item	Frequency Range		Uncertainty (dB)
AC Power Conducted Emission	9kHz ~ 30MHz		± 2.020
Radiated Emissions	30MHz ~ 230MHz	Horizontal	± 3.960
		Vertical	± 3.570
	230MHz ~1000MHz	Horizontal	± 3.960
		Vertical	± 3.570
	1000MHz ~ 18000MHz	Horizontal	± 3.072
		Vertical	± 3.028
	18000MHz ~ 40000MHz	Horizontal	± 3.622
		Vertical	± 3.506

2 EUT Description

Product Type	Media Streamer
Trade Name	Gigastone
Model No.	A2-25DE
Applicant	Gigastone Corp. 12F, No. 480, Rueiguang Rd., Neihu Dist., Taipei 114, Taiwan
Manufacturer	Gigastone Corp. 12F, No. 480, Rueiguang Rd., Neihu Dist., Taipei 114, Taiwan
FCC ID	PLE-WD2502
Frequency Range	IEEE 802.11b / 802.11g / 802.11n 2.4GHz 20MHz: 2412 ~ 2462 MHz IEEE 802.11n 2.4GHz 40MHz: 2422 ~ 2452 MHz
Modulation Type	IEEE 802.11b:DSSS IEEE 802.11g:DSSS + OFDM IEEE 802.11n 2.4GHz 20MHz: OFDM IEEE 802.11n 2.4GHz 40MHz: OFDM
Antenna Type	Print chip antenna
Antenna Gain	1.0 dBi
RF Output Power	IEEE 802.11b: 0.031 W / 14.85 dBm IEEE 802.11g: 0.094 W / 19.74 dBm IEEE 802.11n 2.4GHz 20MHz: 0.101 W / 20.04 dBm IEEE 802.11n 2.4GHz 40MHz: 0.105 W / 20.23 dBm
99 % Occupied Bandwidth	IEEE 802.11b: 13.84 MHz IEEE 802.11g: 16.59 MHz IEEE 802.11n 2.4GHz 20MHz: 17.76 MHz IEEE 802.11n 2.4GHz 40MHz: 36.19 MHz
Emission Designator	IEEE 802.11b: 13M8G1D IEEE 802.11g: 16M6G1D IEEE 802.11n 2.4GHz 20MHz: 17M7G1D IEEE 802.11n 2.4GHz 40MHz: 36M2G1D

3 Test Methodology

3.1. Mode of Operation

Decision of Test ATL has verified the construction and function in typical operation. All the test modes were carried out with the EUT in normal operation, which was shown in this test report and defined as:

Test Mode
Mode 1: Normal Operation Mode
Mode 2: IEEE 802.11b Link Mode
Mode 3: IEEE 802.11g Link Mode
Mode 4: IEEE 802.11n 2.4GHz 20MHz Link Mode
Mode 5: IEEE 802.11n 2.4GHz 40MHz Link Mode

Software used to control the EUT for staying in continuous transmitting mode was programmed.

After verification, all tests were carried out with the worst case test modes as shown below except radiated spurious emission below 1GHz and power line conducted emissions below 30MHz, which worst case was in normal link mode only.

IEEE 802.11b mode:

Channel Low (2412MHz), Channel Mid (2437MHz) and Channel High (2462MHz) with 1Mbps data rate were chosen for full testing.

IEEE 802.11g mode:

Channel Low (2412MHz), Channel Mid (2437MHz) and Channel High (2462MHz) with 6Mbps data rate were chosen for full testing.

IEEE 802.11n 2.4GHz 20MHz mode:

Channel Low (2412MHz), Channel Mid (2437MHz) and Channel High (2462MHz) with 6.5Mbps data rate were chosen for full testing.

IEEE 802.11n 2.4GHz 40MHz mode:

Channel Low (2422MHz), Channel Mid (2437MHz) and Channel High (2452MHz) with 13.5Mbps data rate were chosen for full testing.

3.2. EUT Exercise Software

1. Setup the EUT shown on 3.3.
2. Turn on the power of all equipment.
3. Turn on Wi-Fi function link to AP.
4. EUT run test program.

3.3. Configuration of Test System Details

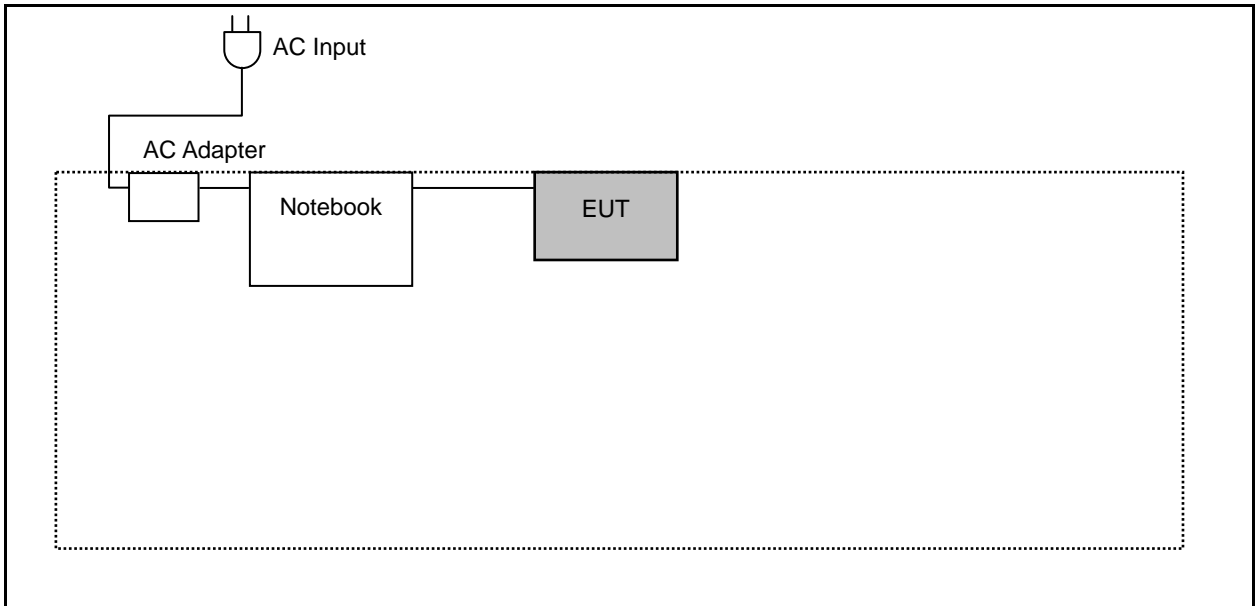

3.4. Test Site Environment

Items	Required (IEC 68-1)	Actual
Temperature (°C)	15-35	26
Humidity (%RH)	25-75	60
Barometric pressure (mbar)	860-1060	950

4 Conducted Emission Measurement

4.1. Limit

Frequency (MHz)	Quasi-peak	Average
0.15 - 0.5	66 to 56	56 to 46
0.50 - 5.0	56	46
5.0 - 30.0	60	50

4.2. Test Instruments

Describe	Manufacturer	Model Number	Serial Number	Cal. Date	Remark
Test Receiver	R&S	ESCI	100367	06/06/2013	(1)
LISN	R&S	ENV216	101040	03/04/2013	(1)
LISN	R&S	ENV216	101041	03/04/2013	(1)
Test Site	ATL	TE02	TE02	N.C.R.	-----

Remark: (1) Calibration period 1 year. (2) Calibration period 2 years. (3) Calibration period 3 years.

Note: N.C.R. = No Calibration Request.

4.3. Test Setup

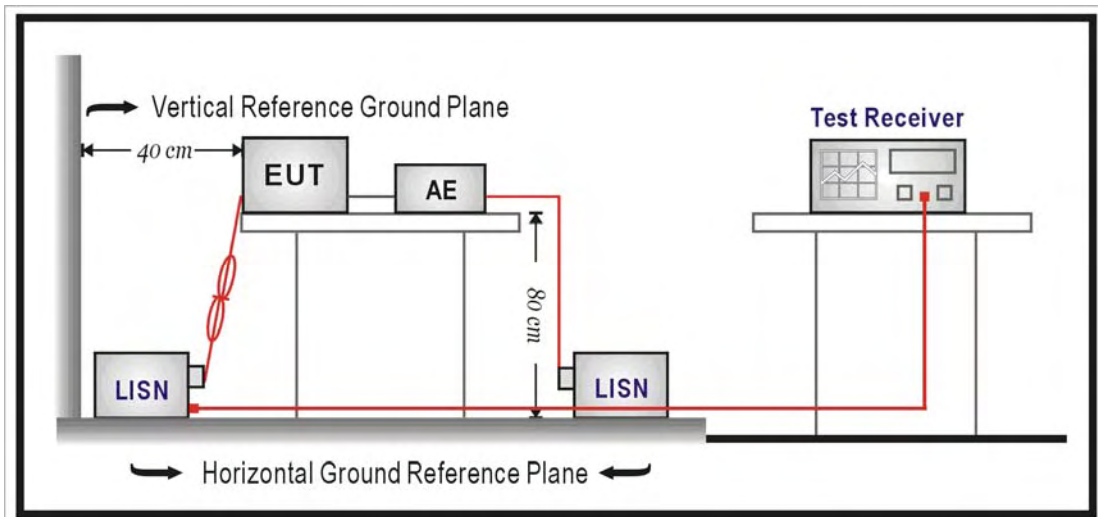

4.4. Test Procedure

The power line conducted emission measurements were performed in a shielded enclosure. The EUT was assembled on a wooden table which is 80 centimeters high, was placed 40 centimeters from the back wall and at least 1 meter from the sidewall.

Power was fed to the EUT from the public utility power grid through a line filter and EMCO Model 3162/2 SH Line Impedance Stabilization Networks (LISN). The LISN housing, measuring instrumentation case, ground plane, etc., were electrically bonded together at the same RF potential. The Spectrum analyzer was connected to the AC line through an isolation transformer. The 50-ohm output of the LISN was connected to the spectrum analyzer directly. Conducted emission levels were in the CISPR quasi-peak detection mode. The analyzer's 6 dB bandwidth was set to 9 KHz. No post-detector video filter was used.

The spectrum was scanned from 150 KHz to 30 MHz. The physical arrangement of the test system and associated cabling was varied (within the scope of arrangements likely to be encountered in actual use) to determine the effect on the unit's emanations in amplitude and frequency. All spurious emission frequencies were observed. The highest emission amplitudes relative to the appropriate limit were measured and have been recorded in paragraph 4.1.

4.5. Test Result

Standard:	FCC Part 15C	Line:	L1
Test item:	Conducted Emission	Power:	AC 120V/60Hz
Model Number:	A2-25DE	Temp.(°C)/Hum.(%RH):	26(°C)/60%RH
Mode:	1	Date:	08/26/2013
		Test By:	Fly Lu
Description:			

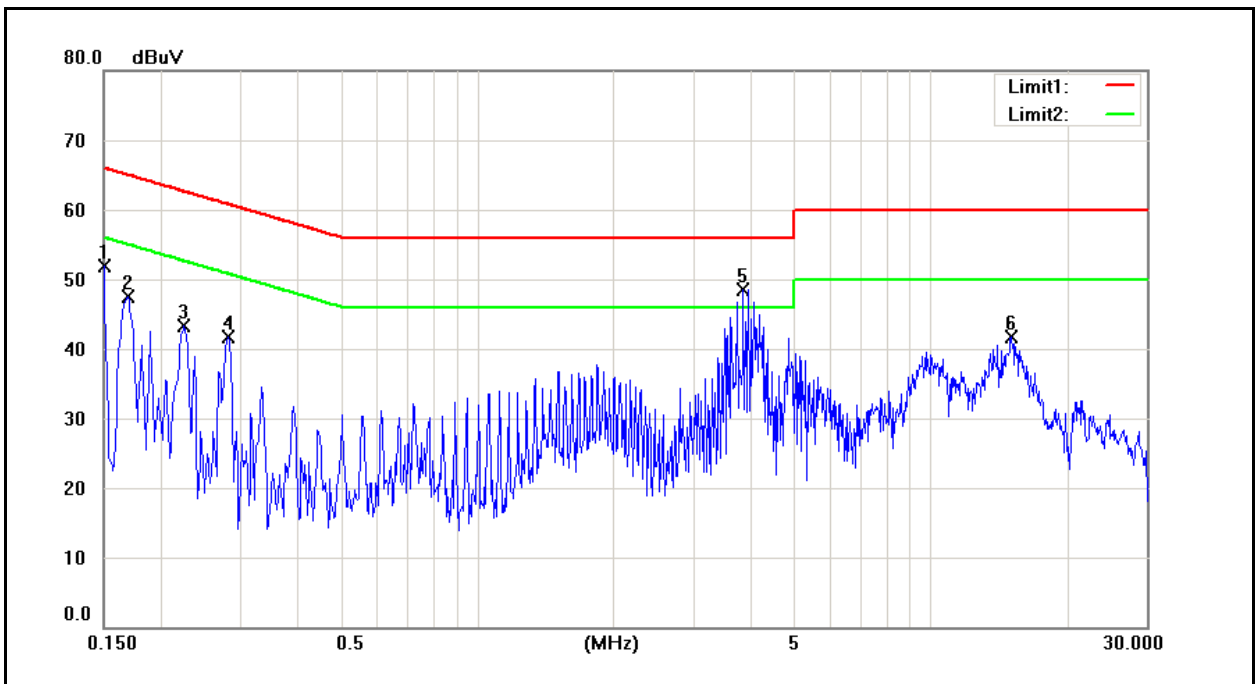

No.	Frequency (MHz)	QP reading (dBuV)	AVG reading (dBuV)	Correction factor (dB)	QP result (dBuV)	AVG result (dBuV)	QP limit (dBuV)	AVG limit (dBuV)	QP margin (dB)	AVG margin (dB)	Remark
1	0.1500	32.38	10.08	9.62	42.00	19.70	66.00	56.00	-24.00	-36.30	Pass
2	0.1700	41.01	28.89	9.62	50.63	38.51	64.96	54.96	-14.33	-16.45	Pass
3	0.2260	31.80	26.53	9.62	41.42	36.15	62.60	52.60	-21.18	-16.45	Pass
4	0.2820	30.56	20.65	9.62	40.18	30.27	60.76	50.76	-20.58	-20.49	Pass
5	3.8620	35.94	23.08	9.71	45.65	32.79	56.00	46.00	-10.35	-13.21	Pass
6	15.0660	24.97	14.50	9.86	34.83	24.36	60.00	50.00	-25.17	-25.64	Pass

Standard:	FCC Part 15C	Line:	N
Test item:	Conducted Emission	Power:	AC 120V/60Hz
Model Number:	A2-25DE	Temp.(°C)/Hum.(%RH):	26(°C)/60%RH
Mode:	1	Date:	08/26/2013
		Test By:	Fly Lu
Description:			

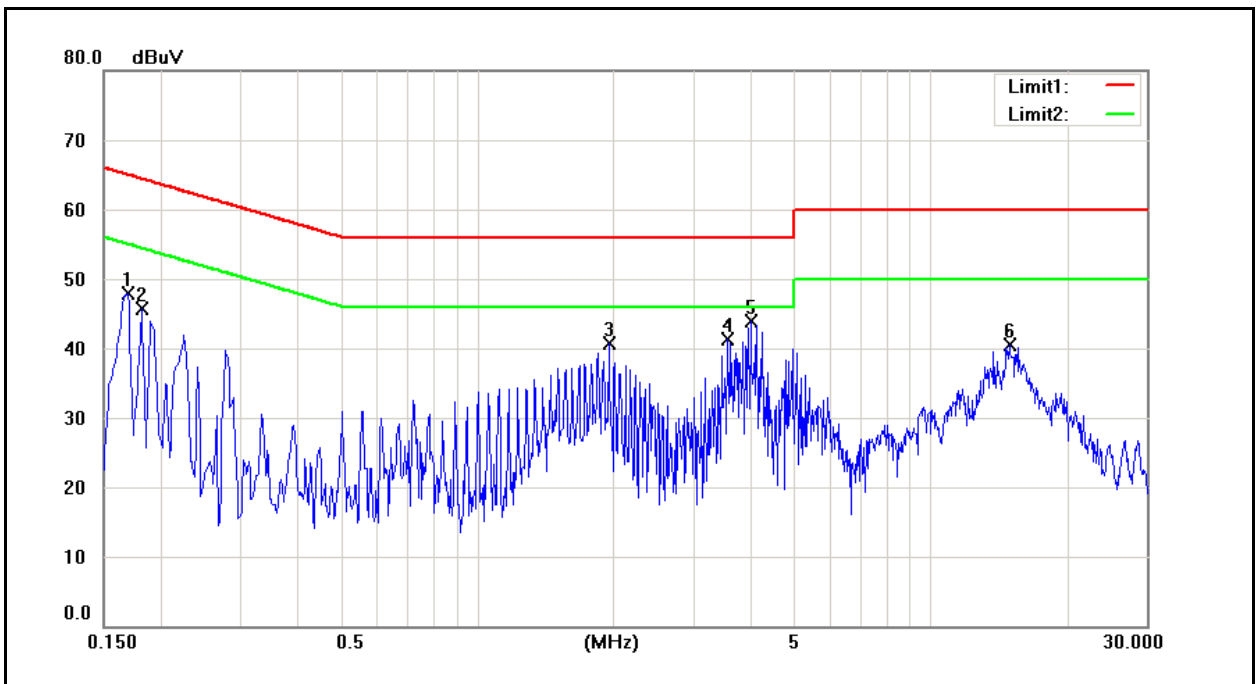

No.	Frequency (MHz)	QP reading (dBuV)	AVG reading (dBuV)	Correction factor (dB)	QP result (dBuV)	AVG result (dBuV)	QP limit (dBuV)	AVG limit (dBuV)	QP margin (dB)	AVG margin (dB)	Remark
1	0.1700	38.95	28.20	9.63	48.58	37.83	64.96	54.96	-16.38	-17.13	Pass
2	0.1820	27.16	7.19	9.63	36.79	16.82	64.39	54.39	-27.60	-37.57	Pass
3	1.9580	27.57	24.44	9.70	37.27	34.14	56.00	46.00	-18.73	-11.86	Pass
4	3.5780	27.56	16.75	9.73	37.29	26.48	56.00	46.00	-18.71	-19.52	Pass
5	4.0260	31.95	20.46	9.70	41.65	30.16	56.00	46.00	-14.35	-15.84	Pass
6	14.9660	19.98	7.88	9.93	29.91	17.81	60.00	50.00	-30.09	-32.19	Pass

5 Radiated Emission Measurement

5.1. Limit

According to §15.209(a), except as provided elsewhere in this subpart, the emissions from an intentional radiator shall not exceed the field strength levels specified in the following table:

Frequency (MHz)	Field Strength ($\mu\text{V}/\text{m}$ at meter)	Measurement Distance (meters)
0.009 – 0.490	2400 / F (kHz)	300
0.490 – 1.705	24000 / F (kHz)	30
1.705 – 30.0	30	30
30 - 88	100**	3
88-216	150**	3
216-960	200**	3
Above 960	500	3

** Except as provided in paragraph (g), fundamental emissions from intentional radiators operating under this Section shall not be located in the frequency bands 54-72 MHz, 76-88 MHz, 174-216 MHz or 470-806 MHz. However, operation within these frequency bands is permitted under other sections of this Part, e.g., Sections 15.231 and 15.241.

5.2. Test Instruments

3 Meter Chamber					
Equipment	Manufacturer	Model Number	Serial Number	Cal. Date	Remark
RF Pre-selector	Agilent	N9039A	MY46520256	01/21/2013	(1)
Spectrum Analyzer	Agilent	E4446A	MY46180578	01/21/2013	(1)
Pre Amplifier	Agilent	8449B	3008A02237	02/21/2013	(1)
Pre Amplifier	Agilent	8447D	2944A10961	02/21/2013	(1)
Broadband Antenna (30MHz~1GHz)	SCHWARZBECK MESS-ELEKTRONIK	VULB9163	9163-270	07/16/2013	(1)
Horn Antenna (1~18GHz)	SCHWARZBECK MESS-ELEKTRONIK	BBHA9120D	9120D-550	06/10/2013	(1)
Horn Antenna (18~40GHz)	SCHWARZBECK MESS-ELEKTRONIK	BBHA9170	9170-320	06/13/2013	(1)
Loop Antenna	COM-POWER CORPORATION	AL-130	121014	08/14/2012	(3)
Test Site	ATL	TE01	888001	08/28/2012	(1)

Remark: (1) Calibration period 1 year. (2) Calibration period 2 years. (3) Calibration period 3 years.

Note: N.C.R. = No Calibration Request.

5.3. Setup

Below 1GHz

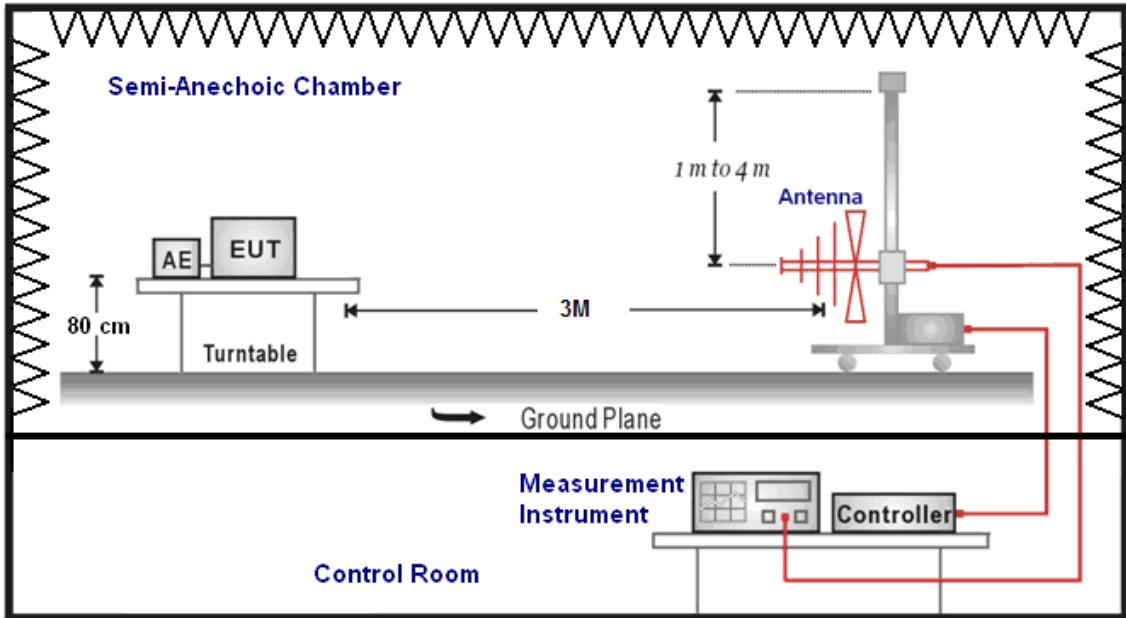

Above 1GHz

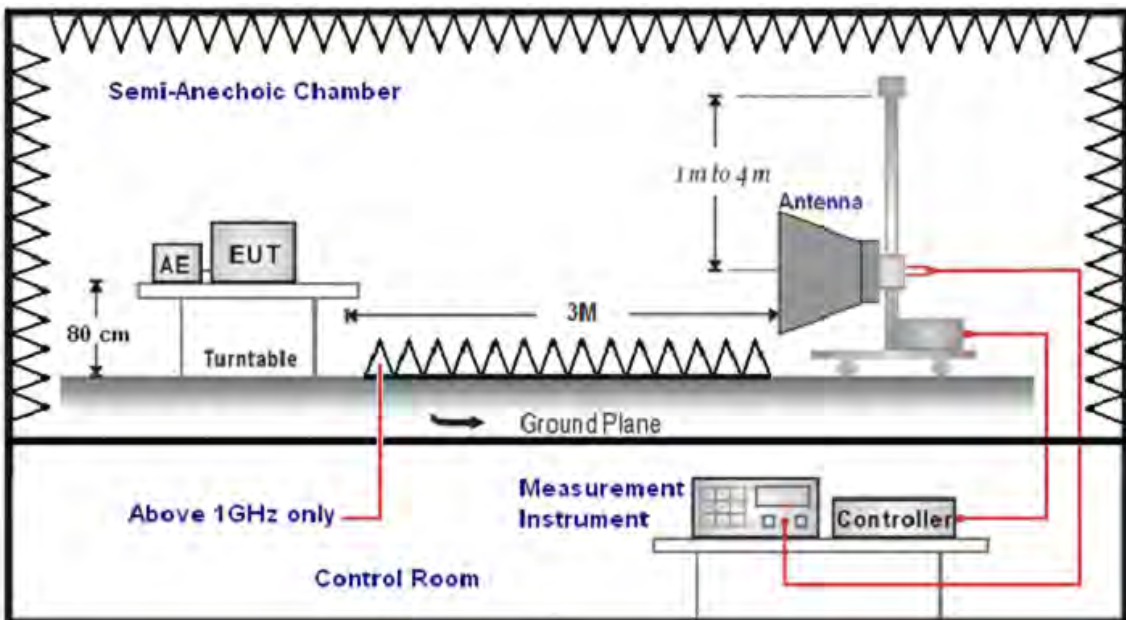

5.4. Test Procedure

Final radiation measurements were made on a three-meter, Semi Anechoic Chamber. The EUT system was placed on a nonconductive turntable which is 0.8 meters height, top surface 1.0 x 1.5 meter. The spectrum was examined from 250 MHz to 2.5 GHz in order to cover the whole spectrum below 10th harmonic which could generate from the EUT. During the test, EUT was set to transmit continuously & Measurements spectrum range from 9 kHz to 26.5 GHz is investigated.

For measurements below 1 GHz the resolution bandwidth is set to 100 kHz for peak detection measurements or 120 kHz for quasi-peak detection measurements. Peak detection is used unless otherwise noted as quasi-peak.

For measurements above 1 GHz the resolution bandwidth is set to 1 MHz, and then the video bandwidth is set to 1 MHz for peak measurements and 10 Hz for average measurements.

A nonconductive material surrounded the EUT to supporting the EUT for standing on three orthogonal planes. At each condition, the EUT was rotated 360 degrees, and the antenna was raised and lowered from one to four meters to find the maximum emission levels. Measurements were taken using both horizontal and vertical antenna polarization.

SCHWARZBECK MESS-ELEKTRONIK Biconilog Antenna (mode VULB9163) at 3 Meter and the SCHWARZBECK Double Ridged Guide Antenna (model BBHA9120D&9170) was used in frequencies 1 – 26.5 GHz at a distance of 1 meter. All test results were extrapolated to equivalent signal at 3 meters utilizing an inverse linear distance extrapolation Factor (20dB/decade).

For testing above 1GHz, the emission level of the EUT in peak mode was 20dB lower than average limit (that means the emission level in peak mode also complies with the limit in average mode), then testing will be stopped and peak values of EUT will be reported, otherwise, the emissions will be measured in average mode again and reported.

Appropriate preamplifiers were used for improving sensitivity and precautions were taken to avoid overloading or desensitizing the spectrum analyzer. No post – detector video filters were used in the test.

The spectrum analyzer's 6 dB bandwidth was set to 1 MHz, and the analyzer was operated in the peak detection mode, for frequencies both below and up 1 GHz. The average levels were obtained by subtracting the duty cycle correction factor from the peak readings.

The following procedures were used to convert the emission levels measured in decibels referenced to 1 microvolt (dBuV) into field intensity in micro volts pre meter (uV/m).

The actual field intensity in decibels referenced to 1 microvolt in to field intensity in micro volts per meter (dBuV/m).

The actual field intensity in referenced to 1 microvolt per meter (dBuV/m) is determined by algebraically adding the measured reading in dBuV, the antenna factor (dB), and cable loss (dB) and Subtracting the gain of preamplifier (dB) is auto calculate in spectrum analyzer.

(1) $\text{Amplitude (dBuV/m)} = \text{FI (dBuV)} + \text{AF (dBuV)} + \text{CL (dBuV)} - \text{Gain (dB)}$

FI= Reading of the field intensity.

AF= Antenna factor.

CL= Cable loss.

P.S Amplitude is auto calculate in spectrum analyzer.

(2) $\text{Actual Amplitude (dBuV/m)} = \text{Amplitude (dBuV)} - \text{Dis(dB)}$

The FCC specified emission limits were calculated according the EUT operating frequency and by following linear interpolation equations:

(a) For fundamental frequency : Transmitter Output < +30dBm

(b) For spurious frequency : Spurious emission limits = fundamental emission limit /10

Data of measurement within this frequency range without mark in the table above means the reading of emissions are attenuated more than 20dB below the permissible limits or the field strength is too small to be measured.

5.5. Test Result

Below 1GHz

Standard:	FCC Part 15C	Test Distance:	3m
Test item:	Radiated Emission	Power:	AC 120V/60Hz
Model Number:	A2-25DE	Temp.(°C)/Hum.(%RH):	26(°C)/60%RH
Mode:	1	Date:	08/24/2013
		Test By:	Fly Lu

Frequency (MHz)	Reading (dBuV)	Correct Factor (dB/m)	Result (dBuV/m)	Limit (dBuV/m)	Margin (dB)	Remark	Ant.Polar. H / V
121.5000	38.70	-16.23	22.47	43.50	-21.03	QP	H
215.0000	42.39	-13.66	28.73	43.50	-14.77	QP	H
300.0000	38.05	-10.53	27.52	46.00	-18.48	QP	H
501.0000	40.52	-6.79	33.73	46.00	-12.27	QP	H
587.0000	37.81	-5.43	32.38	46.00	-13.62	QP	H
799.5000	38.00	-1.55	36.45	46.00	-9.55	QP	H
215.0000	50.89	-13.66	37.23	43.50	-6.27	QP	V
300.0000	48.30	-10.53	37.77	46.00	-8.23	QP	V
398.5000	42.70	-8.60	34.10	46.00	-11.90	QP	V
530.0000	32.64	-6.64	26.00	46.00	-20.00	QP	V
644.5000	33.74	-4.16	29.58	46.00	-16.42	QP	V
799.5000	38.32	-1.55	36.77	46.00	-9.23	QP	V

Note: No emission found between lowest internal used/generated frequency to 30MHz (9kHz~30MHz).

Above 1GHz

Standard:	FCC Part 15C			Test Distance:	3m		
Test item:	Radiated Emission			Power:	AC 120V/60Hz		
Model Number:	A2-25DE			Temp.(°C)/Hum.(%RH):	26(°C)/60%RH		
Mode:	2			Date:	08/23/2013		
Frequency:	2412MHz			Test By:	Fly Lu		
Frequency (MHz)	Reading (dBuV)	Correct Factor (dB/m)	Result (dBuV/m)	Limit (dBuV/m)	Margin (dB)	Remark	Ant.Polar. H / V
2946.000	36.55	5.76	42.31	74.00	-31.69	peak	H
4577.000	34.73	11.07	45.80	74.00	-28.20	peak	H
6222.000	32.76	16.56	49.32	74.00	-24.68	peak	H
2869.000	35.91	5.57	41.48	74.00	-32.52	peak	V
4591.000	35.35	11.11	46.46	74.00	-27.54	peak	V
6355.000	32.51	16.97	49.48	74.00	-24.52	peak	V

Standard:	FCC Part 15C			Test Distance:	3m		
Test item:	Radiated Emission			Power:	AC 120V/60Hz		
Model Number:	A2-25DE			Temp.(°C)/Hum.(%RH):	26(°C)/60%RH		
Mode:	2			Date:	08/23/2013		
Frequency:	2437MHz			Test By:	Fly Lu		
Frequency (MHz)	Reading (dBuV)	Correct Factor (dB/m)	Result (dBuV/m)	Limit (dBuV/m)	Margin (dB)	Remark	Ant.Polar. H / V
2890.000	36.09	5.63	41.72	74.00	-32.28	peak	H
4591.000	35.10	11.11	46.21	74.00	-27.79	peak	H
6306.000	33.63	16.82	50.45	74.00	-23.55	peak	H
2967.000	37.58	5.82	43.40	74.00	-30.60	peak	V
4542.000	36.26	10.99	47.25	74.00	-26.75	peak	V
6166.000	34.58	16.39	50.97	74.00	-23.03	peak	V

Standard:	FCC Part 15C		Test Distance:	3m			
Test item:	Radiated Emission		Power:	AC 120V/60Hz			
Model Number:	A2-25DE		Temp.(°C)/Hum.(%RH):	26(°C)/60%RH			
Mode:	2		Date:	08/23/2013			
Frequency:	2462MHz		Test By:	Fly Lu			
Frequency (MHz)	Reading (dBuV)	Correct Factor (dB/m)	Result (dBuV/m)	Limit (dBuV/m)	Margin (dB)	Remark	Ant.Polar. H / V
2883.000	36.06	5.61	41.67	74.00	-32.33	peak	H
4549.000	34.56	11.01	45.57	74.00	-28.43	peak	H
6383.000	33.50	17.06	50.56	74.00	-23.44	peak	H
3037.000	36.43	5.99	42.42	74.00	-31.58	peak	V
4577.000	35.46	11.07	46.53	74.00	-27.47	peak	V
6355.000	33.66	16.97	50.63	74.00	-23.37	peak	V

Standard:	FCC Part 15C		Test Distance:	3m			
Test item:	Radiated Emission		Power:	AC 120V/60Hz			
Model Number:	A2-25DE		Temp.(°C)/Hum.(%RH):	26(°C)/60%RH			
Mode:	3		Date:	08/23/2013			
Frequency:	2412MHz		Test By:	Fly Lu			
Frequency (MHz)	Reading (dBuV)	Correct Factor (dB/m)	Result (dBuV/m)	Limit (dBuV/m)	Margin (dB)	Remark	Ant.Polar. H / V
2939.000	36.28	5.75	42.03	74.00	-31.97	peak	H
4563.000	34.29	11.05	45.34	74.00	-28.66	peak	H
6327.000	33.82	16.88	50.70	74.00	-23.30	peak	H
2925.000	36.02	5.72	41.74	74.00	-32.26	peak	V
4577.000	35.12	11.07	46.19	74.00	-27.81	peak	V
6306.000	33.82	16.82	50.64	74.00	-23.36	peak	V

Standard:	FCC Part 15C		Test Distance:	3m			
Test item:	Radiated Emission		Power:	AC 120V/60Hz			
Model Number:	A2-25DE		Temp.(°C)/Hum.(%RH):	26(°C)/60%RH			
Mode:	3		Date:	08/23/2013			
Frequency:	2437MHz		Test By:	Fly Lu			
Frequency (MHz)	Reading (dBuV)	Correct Factor (dB/m)	Result (dBuV/m)	Limit (dBuV/m)	Margin (dB)	Remark	Ant.Polar. H / V
2911.000	36.29	5.68	41.97	74.00	-32.03	peak	H
4570.000	34.61	11.06	45.67	74.00	-28.33	peak	H
6229.000	33.25	16.58	49.83	74.00	-24.17	peak	H
3037.000	36.38	5.99	42.37	74.00	-31.63	peak	V
4577.000	35.46	11.07	46.53	74.00	-27.47	peak	V
6250.000	32.54	16.64	49.18	74.00	-24.82	peak	V

Standard:	FCC Part 15C		Test Distance:	3m			
Test item:	Radiated Emission		Power:	AC 120V/60Hz			
Model Number:	A2-25DE		Temp.(°C)/Hum.(%RH):	26(°C)/60%RH			
Mode:	3		Date:	08/23/2013			
Frequency:	2462MHz		Test By:	Fly Lu			
Frequency (MHz)	Reading (dBuV)	Correct Factor (dB/m)	Result (dBuV/m)	Limit (dBuV/m)	Margin (dB)	Remark	Ant.Polar. H / V
2939.000	35.41	5.75	41.16	74.00	-32.84	peak	H
4598.000	34.86	11.14	46.00	74.00	-28.00	peak	H
6250.000	32.95	16.64	49.59	74.00	-24.41	peak	H
2981.000	36.23	5.86	42.09	74.00	-31.91	peak	V
4591.000	35.08	11.11	46.19	74.00	-27.81	peak	V
6243.000	32.69	16.63	49.32	74.00	-24.68	peak	V

Standard:	FCC Part 15C		Test Distance:	3m			
Test item:	Radiated Emission		Power:	AC 120V/60Hz			
Model Number:	A2-25DE		Temp.(°C)/Hum.(%RH):	26(°C)/60%RH			
Mode:	4		Date:	08/23/2013			
Frequency:	2412MHz		Test By:	Fly Lu			
Frequency (MHz)	Reading (dBuV)	Correct Factor (dB/m)	Result (dBuV/m)	Limit (dBuV/m)	Margin (dB)	Remark	Ant.Polar. H / V
3051.000	36.74	6.02	42.76	74.00	-31.24	peak	H
4563.000	34.70	11.05	45.75	74.00	-28.25	peak	H
6355.000	33.23	16.97	50.20	74.00	-23.80	peak	H
2995.000	36.92	5.90	42.82	74.00	-31.18	peak	V
4549.000	34.61	11.01	45.62	74.00	-28.38	peak	V
6397.000	33.42	17.10	50.52	74.00	-23.48	peak	V

Standard:	FCC Part 15C		Test Distance:	3m			
Test item:	Radiated Emission		Power:	AC 120V/60Hz			
Model Number:	A2-25DE		Temp.(°C)/Hum.(%RH):	26(°C)/60%RH			
Mode:	4		Date:	08/23/2013			
Frequency:	2437MHz		Test By:	Fly Lu			
Frequency (MHz)	Reading (dBuV)	Correct Factor (dB/m)	Result (dBuV/m)	Limit (dBuV/m)	Margin (dB)	Remark	Ant.Polar. H / V
3107.000	36.82	6.14	42.96	74.00	-31.04	peak	H
4577.000	35.57	11.07	46.64	74.00	-27.36	peak	H
6257.000	32.23	16.66	48.89	74.00	-25.11	peak	H
2953.000	36.48	5.79	42.27	74.00	-31.73	peak	V
4570.000	35.32	11.06	46.38	74.00	-27.62	peak	V
6362.000	32.39	16.99	49.38	74.00	-24.62	peak	V

Standard:	FCC Part 15C		Test Distance:	3m			
Test item:	Radiated Emission		Power:	AC 120V/60Hz			
Model Number:	A2-25DE		Temp.(°C)/Hum.(%RH):	26(°C)/60%RH			
Mode:	4		Date:	08/23/2013			
Frequency:	2462MHz		Test By:	Fly Lu			
Frequency (MHz)	Reading (dBuV)	Correct Factor (dB/m)	Result (dBuV/m)	Limit (dBuV/m)	Margin (dB)	Remark	Ant.Polar. H / V
2946.000	36.18	5.76	41.94	74.00	-32.06	peak	H
4549.000	34.72	11.01	45.73	74.00	-28.27	peak	H
6341.000	32.67	16.92	49.59	74.00	-24.41	peak	H
2946.000	36.04	5.76	41.80	74.00	-32.20	peak	V
4563.000	34.12	11.05	45.17	74.00	-28.83	peak	V
6229.000	32.09	16.58	48.67	74.00	-25.33	peak	V

Standard:	FCC Part 15C		Test Distance:	3m			
Test item:	Radiated Emission		Power:	AC 120V/60Hz			
Model Number:	A2-25DE		Temp.(°C)/Hum.(%RH):	26(°C)/60%RH			
Mode:	5		Date:	08/23/2013			
Frequency:	2422MHz		Test By:	Fly Lu			
Frequency (MHz)	Reading (dBuV)	Correct Factor (dB/m)	Result (dBuV/m)	Limit (dBuV/m)	Margin (dB)	Remark	Ant.Polar. H / V
2953.000	36.34	5.79	42.13	74.00	-31.87	peak	H
4549.000	34.08	11.01	45.09	74.00	-28.91	peak	H
6369.000	32.73	17.00	49.73	74.00	-24.27	peak	H
2939.000	36.48	5.75	42.23	74.00	-31.77	peak	V
4570.000	34.96	11.06	46.02	74.00	-27.98	peak	V
6425.000	33.80	17.18	50.98	74.00	-23.02	peak	V

Standard:	FCC Part 15C		Test Distance:	3m			
Test item:	Radiated Emission		Power:	AC 120V/60Hz			
Model Number:	A2-25DE		Temp.(°C)/Hum.(%RH):	26(°C)/60%RH			
Mode:	5		Date:	08/23/2013			
Frequency:	2437MHz		Test By:	Fly Lu			
Frequency (MHz)	Reading (dBuV)	Correct Factor (dB/m)	Result (dBuV/m)	Limit (dBuV/m)	Margin (dB)	Remark	Ant.Polar. H / V
2967.000	36.33	5.82	42.15	74.00	-31.85	peak	H
4563.000	34.91	11.05	45.96	74.00	-28.04	peak	H
6341.000	33.68	16.92	50.60	74.00	-23.40	peak	H
2939.000	36.20	5.75	41.95	74.00	-32.05	peak	V
4570.000	35.84	11.06	46.90	74.00	-27.10	peak	V
6383.000	33.49	17.06	50.55	74.00	-23.45	peak	V

Standard:	FCC Part 15C		Test Distance:	3m			
Test item:	Radiated Emission		Power:	AC 120V/60Hz			
Model Number:	A2-25DE		Temp.(°C)/Hum.(%RH):	26(°C)/60%RH			
Mode:	5		Date:	08/23/2013			
Frequency:	2452MHz		Test By:	Fly Lu			
Frequency (MHz)	Reading (dBuV)	Correct Factor (dB/m)	Result (dBuV/m)	Limit (dBuV/m)	Margin (dB)	Remark	Ant.Polar. H / V
2953.000	36.49	5.79	42.28	74.00	-31.72	peak	H
4563.000	35.02	11.05	46.07	74.00	-27.93	peak	H
6383.000	33.06	17.06	50.12	74.00	-23.88	peak	H
2953.000	38.00	5.79	43.79	74.00	-30.21	peak	V
4563.000	34.75	11.05	45.80	74.00	-28.20	peak	V
6243.000	31.71	16.63	48.34	74.00	-25.66	peak	V

6 Maximum Conducted Output Power Measurement

6.1. Limit

For systems using digital modulation in the 2400-2483.5MHz, the limit for peak output power is 30dBm.

6.2. Test Setup

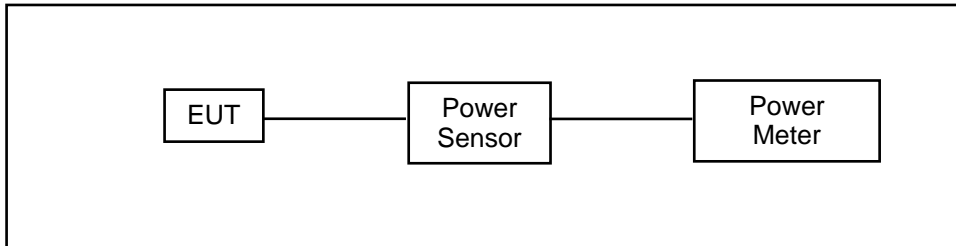

6.3. Test Instruments

Equipment	Manufacturer	Model Number	Serial Number	Cal. Date	Remark
Single Channel PK Power Sensor	Agilent	N1911A	MY45101619	12/19/2012	(1)
Wideband Power Meter	Agilent	N1921A	MY45241957	12/19/2012	(1)
Test Site	ATL	TE05	TE05	N.C.R.	-----

Remark: (1) Calibration period 1 year. (2) Calibration period 2 years. (3) Calibration period 3 years.

Note: N.C.R. = No Calibration Request.

6.4. Test Procedure

The tests below are run with the EUT's transmitter set at high power in TX mode. The EUT is needed to force selection of output power level and channel number. While testing, EUT was set to transmit continuously. Remove the Subjective device's antenna and connect the RF output port to power sensor. The maximum peak output power shall not exceed 1 watt.

Use a direct connection between the antenna port of transmitter and the power sensor, for prevent the power sensor input attenuation 40-50 dB. Set the RBW Bandwidth of the emission or use a channel power meter mode.

For antennas with gains of 6 dBi or less, maximum allowed transmitter output is 1 watt (+30 dBm). For antennas with gains greater than 6 dBi, transmitter output level must be decreased by an amount equal to $(\text{GAIN} - 6)/3$ dBm.

The antenna port of the EUT was connected to the input of a power sensor. Power was read directly and cable loss correction was added to the reading to obtain power at the EUT antenna terminals.

6.5. Test Result

Model Number	A2-25DE					
Test Item	Maximum Conducted Output Power					
Test Mode	Mode 2: IEEE 802.11b Link Mode					
Date of Test	08/23/2013			Test Site	TE05	
Frequency (MHz)	Data Rate	Average Power		Peak Power		Limit (dBm)
		(dBm)	(W)	(dBm)	(W)	
2412	1M	11.77	0.015	14.69	0.029	< 30
2437		11.46	0.014	14.13	0.026	< 30
2462		12.02	0.016	14.85	0.031	< 30
2437	2M	11.42	0.014	14.05	0.025	< 30
2437	5.5M	11.41	0.014	14.02	0.025	< 30
2437	11M	11.38	0.014	13.91	0.025	< 30

Model Number	A2-25DE					
Test Item	Maximum Conducted Output Power					
Test Mode	Mode 3: IEEE 802.11g Link Mode					
Date of Test	08/23/2013			Test Site	TE05	
Frequency (MHz)	Data Rate	Average Power		Peak Power		Limit (dBm)
		(dBm)	(W)	(dBm)	(W)	
2412	6M	11.19	0.013	19.61	0.091	< 30
2437		11.42	0.014	19.74	0.094	< 30
2462		11.25	0.013	19.19	0.083	< 30
2437	9M	11.39	0.014	19.56	0.090	< 30
2437	12M	11.36	0.014	19.41	0.087	< 30
2437	18M	11.33	0.014	19.37	0.086	< 30
2437	24M	11.32	0.014	19.35	0.086	< 30
2437	36M	11.30	0.013	19.28	0.085	< 30
2437	48M	11.28	0.013	19.11	0.081	< 30
2437	54M	11.29	0.013	19.08	0.081	< 30

Model Number	A2-25DE					
Test Item	Maximum Conducted Output Power					
Test Mode	Mode 4: IEEE 802.11n 2.4GHz 20MHz Link Mode					
Date of Test	08/23/2013			Test Site	TE05	
Frequency (MHz)	Data Rate	Average Power		Peak Power		Limit (dBm)
		(dBm)	(W)	(dBm)	(W)	
2412	6.5M	11.52	0.014	20.04	0.101	< 30
2437		11.42	0.014	19.61	0.091	< 30
2462		11.25	0.013	19.14	0.082	< 30
2412	13M	11.40	0.014	19.42	0.087	< 30
2437	19.5M	11.37	0.014	19.32	0.086	< 30
2437	26M	11.35	0.014	19.26	0.084	< 30
2437	39M	11.32	0.014	19.12	0.082	< 30
2437	52M	11.30	0.013	19.01	0.080	< 30
2437	58.5M	11.29	0.013	18.96	0.079	< 30
2462	65M	11.27	0.013	18.87	0.077	< 30

Model Number	A2-25DE					
Test Item	Maximum Conducted Output Power					
Test Mode	Mode 5: IEEE 802.11n 2.4GHz 40MHz Link Mode					
Date of Test	08/23/2013			Test Site	TE05	
Frequency (MHz)	Data Rate	Average Power		Peak Power		Limit (dBm)
		(dBm)	(W)	(dBm)	(W)	
2422	13.5M	11.09	0.013	19.68	0.093	< 30
2437		11.44	0.014	20.23	0.105	< 30
2452		10.91	0.012	19.46	0.088	< 30
2422	27M	11.42	0.014	20.12	0.103	< 30
2437	40.5M	11.41	0.014	20.10	0.102	< 30
2437	54M	11.39	0.014	19.97	0.099	< 30
2437	81M	11.36	0.014	19.82	0.096	< 30
2437	108M	11.33	0.014	19.73	0.094	< 30
2437	121.5M	11.31	0.014	19.65	0.092	< 30
2452	135M	11.32	0.014	19.69	0.093	< 30

7 6dB RF Bandwidth and 99 % Occupied Bandwidth Measurement

7.1. Limit

6dB RF Bandwidth: Systems using digital modulation techniques may operate in the 2400–2483.5 MHz bands. The minimum 6 dB band-width shall be at least 500 kHz.

99 % Occupied Bandwidth: N/A

7.2. Test Setup

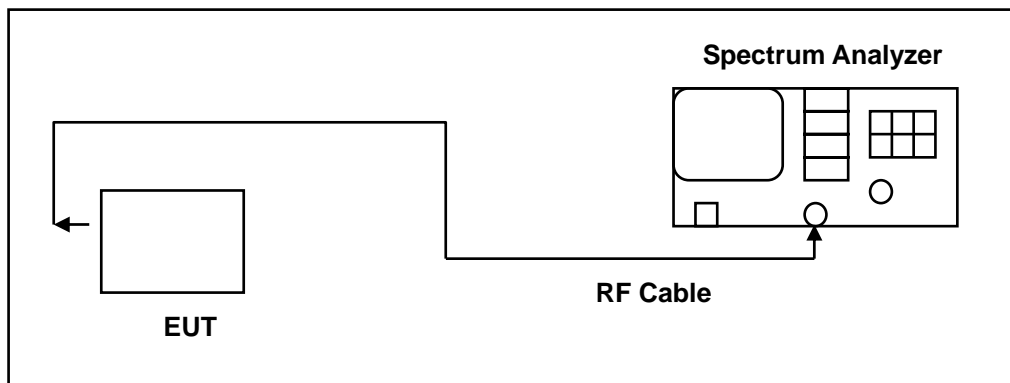

7.3. Test Instruments

Equipment	Manufacturer	Model Number	Serial Number	Cal. Date	Remark
Spectrum Analyzer	Agilent	E4445A	MY45300744	12/19/2012	(2)
Test Site	ATL	TE05	TE05	N.C.R.	-----

dRemark: (1) Calibration period 1 year. (2) Calibration period 2 years. (3) Calibration period 3 years.

Note: N.C.R. = No Calibration Request.

7.4. Test Procedure

The EUT was setup to ANSI C63.4, 2009; tested to DTS test procedure of Oct 2012 KDB558074 for compliance to FCC 47CFR 15.247 requirements.

6dB RF Bandwidth: The antenna port of the EUT was connected to the input of a spectrum analyzer. Analyzer RES BW was set to 100 kHz. For each RF output channel investigated, the spectrum analyzer center frequency was set to the channel carrier. A peak output reading was taken, a DISPLAY line was drawn 6 dB lower than peak level. The 6 dB bandwidth was determined from where the channel output spectrum intersected the display line.

The test was performed at 3 channels (Channel low, middle, high)

99 % Occupied Bandwidth: The transmitter shall be operated at its maximum carrier power measured under normal test conditions.

The span of the analyzer shall be set to capture all products of the modulation process, including the emission skirts. The resolution bandwidth shall be set to as close to 1% of the selected span as is possible without being below 1%. The video bandwidth shall be set to 3 times the resolution bandwidth. Video averaging is not permitted. Where practical, a sampling detector shall be used since a peak or, peak hold, may produce a wider bandwidth than actual. The trace data points are recovered and are directly summed in linear terms. The recovered amplitude data points, beginning at the lowest frequency, are placed in a running sum until 0.5% of the total is reached and that frequency recorded. The process is repeated for the highest frequency data points. This frequency is recorded.

7.5. Test Result

Model Number	A2-25DE		
Test Item	6dB RF Bandwidth and 99 % Occupied Bandwidth		
Test Mode	Mode 2: IEEE 802.11b Link Mode		
Date of Test	08/28/2013	Test Site	TE05
Frequency (MHz)	6dB RF Bandwidth (MHz)	99 % Occupied Bandwidth (MHz)	6dB RF Bandwidth Limit (MHz)
2412	10.141	13.8406	> 0.500
2437	10.107	13.7863	> 0.500
2462	10.086	13.6652	> 0.500

Model Number	A2-25DE		
Test Item	6dB RF Bandwidth and 99 % Occupied Bandwidth		
Test Mode	Mode 3: IEEE 802.11g Link Mode		
Date of Test	08/28/2013	Test Site	TE05
Frequency (MHz)	6dB RF Bandwidth (MHz)	99 % Occupied Bandwidth (MHz)	6dB RF Bandwidth Limit (MHz)
2412	16.594	16.5434	> 0.500
2437	16.518	16.5555	> 0.500
2462	16.565	16.5926	> 0.500

Model Number	A2-25DE		
Test Item	6dB RF Bandwidth and 99 % Occupied Bandwidth		
Test Mode	Mode 4: IEEE 802.11n 2.4GHz 20MHz Link Mode		
Date of Test	08/28/2013	Test Site	TE05
Frequency (MHz)	6dB RF Bandwidth (MHz)	99 % Occupied Bandwidth (MHz)	6dB RF Bandwidth Limit (MHz)
2412	17.853	17.7403	> 0.500
2437	17.817	17.7223	> 0.500
2462	17.842	17.7560	> 0.500

Model Number	A2-25DE		
Test Item	6dB RF Bandwidth and 99 % Occupied Bandwidth		
Test Mode	Mode 5: IEEE 802.11n 2.4GHz 40MHz Link Mode		
Date of Test	08/28/2013	Test Site	TE05
Frequency (MHz)	6dB RF Bandwidth (MHz)	99 % Occupied Bandwidth (MHz)	6dB RF Bandwidth Limit (MHz)
2422	36.564	36.1896	> 0.500
2437	36.532	36.1807	> 0.500
2452	36.506	36.1605	> 0.500

7.6. Test Graphs

Mode 2: IEEE 802.11b Link Mode	
2412	<p>Agilent R T</p> <p>Ch Freq 2.412 GHz Trig Free</p> <p>Occupied Bandwidth</p> <p>Ref 10 dBm #Atten 15 dB</p> <p>#Peak Log 10 dB/Offset 10.4 dB</p> <p>Center 2.412 GHz Span 30 MHz</p> <p>#Res BW 100 kHz #VBW 300 kHz Sweep 4 ms (401 pts)</p> <p>Occupied Bandwidth 13.8406 MHz</p> <p>Occ BW % Pwr 99.00 % x dB -6.00 dB</p> <p>Transmit Freq Error -37.377 kHz</p> <p>x dB Bandwidth 10.141 MHz</p> <p>Freq/Channel</p> <p>Center Freq 2.41200000 GHz</p> <p>Start Freq 2.39700000 GHz</p> <p>Stop Freq 2.42700000 GHz</p> <p>CF Step 3.00000000 MHz Auto Man</p> <p>Freq Offset 0.00000000 Hz</p> <p>Signal Track On Off</p>
2437	<p>Agilent R T</p> <p>Ch Freq 2.437 GHz Trig Free</p> <p>Occupied Bandwidth</p> <p>Ref 10 dBm #Atten 15 dB</p> <p>#Peak Log 10 dB/Offset 10.4 dB</p> <p>Center 2.437 GHz Span 30 MHz</p> <p>#Res BW 100 kHz #VBW 300 kHz Sweep 4 ms (401 pts)</p> <p>Occupied Bandwidth 13.7863 MHz</p> <p>Occ BW % Pwr 99.00 % x dB -6.00 dB</p> <p>Transmit Freq Error -43.697 kHz</p> <p>x dB Bandwidth 10.107 MHz</p> <p>Freq/Channel</p> <p>Center Freq 2.43700000 GHz</p> <p>Start Freq 2.42200000 GHz</p> <p>Stop Freq 2.45200000 GHz</p> <p>CF Step 3.00000000 MHz Auto Man</p> <p>Freq Offset 0.00000000 Hz</p> <p>Signal Track On Off</p>
2462	<p>Agilent R T</p> <p>Ch Freq 2.462 GHz Trig Free</p> <p>Occupied Bandwidth</p> <p>Ref 10 dBm #Atten 15 dB</p> <p>#Peak Log 10 dB/Offset 10.4 dB</p> <p>Center 2.462 GHz Span 30 MHz</p> <p>#Res BW 100 kHz #VBW 300 kHz Sweep 4 ms (401 pts)</p> <p>Occupied Bandwidth 13.6652 MHz</p> <p>Occ BW % Pwr 99.00 % x dB -6.00 dB</p> <p>Transmit Freq Error -63.855 kHz</p> <p>x dB Bandwidth 10.086 MHz</p> <p>Freq/Channel</p> <p>Center Freq 2.46200000 GHz</p> <p>Start Freq 2.44700000 GHz</p> <p>Stop Freq 2.47700000 GHz</p> <p>CF Step 3.00000000 MHz Auto Man</p> <p>Freq Offset 0.00000000 Hz</p> <p>Signal Track On Off</p>

Mode 3: IEEE 802.11g Link Mode

<p>2412</p>	<p>Agilent R T</p> <p>Ch Freq 2.412 GHz Trig Free</p> <p>Occupied Bandwidth</p> <p>Ref 10 dBm #Atten 15 dB</p> <p>#Peak Log 10 dB/Offst 10.4 dB</p> <p>Center 2.412 GHz Span 30 MHz #Res BW 100 kHz #VBW 300 kHz Sweep 4 ms (401 pts)</p> <p>Occupied Bandwidth 16.5434 MHz</p> <p>Occ BW % Pwr 99.00 % x dB -6.00 dB</p> <p>Transmit Freq Error -16.534 kHz x dB Bandwidth 16.594 MHz</p> <p>Freq/Channel Center Freq 2.41200000 GHz Start Freq 2.39700000 GHz Stop Freq 2.42700000 GHz CF Step 3.00000000 MHz Auto Man Freq Offset 0.00000000 Hz Signal Track On Off</p>
<p>2437</p>	<p>Agilent R T</p> <p>Ch Freq 2.437 GHz Trig Free</p> <p>Occupied Bandwidth</p> <p>Ref 10 dBm #Atten 15 dB</p> <p>#Peak Log 10 dB/Offst 10.4 dB</p> <p>Center 2.437 GHz Span 30 MHz #Res BW 100 kHz #VBW 300 kHz Sweep 4 ms (401 pts)</p> <p>Occupied Bandwidth 16.5555 MHz</p> <p>Occ BW % Pwr 99.00 % x dB -6.00 dB</p> <p>Transmit Freq Error -39.444 kHz x dB Bandwidth 16.518 MHz</p> <p>Freq/Channel Center Freq 2.43700000 GHz Start Freq 2.42200000 GHz Stop Freq 2.45200000 GHz CF Step 3.00000000 MHz Auto Man Freq Offset 0.00000000 Hz Signal Track On Off</p>
<p>2462</p>	<p>Agilent R T</p> <p>Ch Freq 2.462 GHz Trig Free</p> <p>Occupied Bandwidth</p> <p>Ref 10 dBm #Atten 15 dB</p> <p>#Peak Log 10 dB/Offst 10.4 dB</p> <p>Center 2.462 GHz Span 30 MHz #Res BW 100 kHz #VBW 300 kHz Sweep 4 ms (401 pts)</p> <p>Occupied Bandwidth 16.5926 MHz</p> <p>Occ BW % Pwr 99.00 % x dB -6.00 dB</p> <p>Transmit Freq Error -54.634 kHz x dB Bandwidth 16.565 MHz</p> <p>Freq/Channel Center Freq 2.46200000 GHz Start Freq 2.44700000 GHz Stop Freq 2.47700000 GHz CF Step 3.00000000 MHz Auto Man Freq Offset 0.00000000 Hz Signal Track On Off</p>

Mode 4: IEEE 802.11n 2.4GHz 20MHz Link Mode

<p>2412</p>	<p>Agilent R T</p> <p>Ch Freq 2.412 GHz Trig Free</p> <p>Occupied Bandwidth</p> <p>Ref 10 dBm #Atten 15 dB</p> <p>#Peak Log 10 dB/Offset 10.4 dB</p> <p>Center 2.412 GHz Span 30 MHz #Res BW 100 kHz #VBW 300 kHz Sweep 4 ms (401 pts)</p> <p>Occupied Bandwidth Occ BW % Pwr 99.00 % 17.7403 MHz x dB -6.00 dB</p> <p>Transmit Freq Error -2.221 kHz x dB Bandwidth 17.853 MHz</p> <p>Freq/Channel Center Freq 2.41200000 GHz Start Freq 2.39700000 GHz Stop Freq 2.42700000 GHz CF Step 3.00000000 MHz Auto Man Freq Offset 0.00000000 Hz Signal Track On Off</p>
<p>2437</p>	<p>Agilent R T</p> <p>Ch Freq 2.437 GHz Trig Free</p> <p>Occupied Bandwidth</p> <p>Ref 10 dBm #Atten 15 dB</p> <p>#Peak Log 10 dB/Offset 10.4 dB</p> <p>Center 2.437 GHz Span 30 MHz #Res BW 100 kHz #VBW 300 kHz Sweep 4 ms (401 pts)</p> <p>Occupied Bandwidth Occ BW % Pwr 99.00 % 17.7223 MHz x dB -6.00 dB</p> <p>Transmit Freq Error -23.604 kHz x dB Bandwidth 17.817 MHz</p> <p>Freq/Channel Center Freq 2.43700000 GHz Start Freq 2.42200000 GHz Stop Freq 2.45200000 GHz CF Step 3.00000000 MHz Auto Man Freq Offset 0.00000000 Hz Signal Track On Off</p>
<p>2462</p>	<p>Agilent R T</p> <p>Ch Freq 2.462 GHz Trig Free</p> <p>Occupied Bandwidth</p> <p>Ref 10 dBm #Atten 15 dB</p> <p>#Peak Log 10 dB/Offset 10.4 dB</p> <p>Center 2.462 GHz Span 30 MHz #Res BW 100 kHz #VBW 300 kHz Sweep 4 ms (401 pts)</p> <p>Occupied Bandwidth Occ BW % Pwr 99.00 % 17.7560 MHz x dB -6.00 dB</p> <p>Transmit Freq Error -32.503 kHz x dB Bandwidth 17.842 MHz</p> <p>Freq/Channel Center Freq 2.46200000 GHz Start Freq 2.44700000 GHz Stop Freq 2.47700000 GHz CF Step 3.00000000 MHz Auto Man Freq Offset 0.00000000 Hz Signal Track On Off</p>

Mode 5: IEEE 802.11n 2.4GHz 40MHz Link Mode

<p>2422</p>	<p>Agilent R T</p> <p>Ch Freq 2.422 GHz Trig Free</p> <p>Occupied Bandwidth</p> <p>Ref 10 dBm #Atten 15 dB</p> <p>#Peak Log 10 dB/Offset 10.4 dB</p> <p>Center 2.422 GHz Span 50 MHz</p> <p>#Res BW 100 kHz #VBW 300 kHz Sweep 5.18 ms (401 pts)</p> <p>Occupied Bandwidth 36.1896 MHz</p> <p>Occ BW % Pwr 99.00 % x dB -6.00 dB</p> <p>Transmit Freq Error -34.817 kHz</p> <p>x dB Bandwidth 36.564 MHz</p> <p>Freq/Channel</p> <p>Center Freq 2.42200000 GHz</p> <p>Start Freq 2.39700000 GHz</p> <p>Stop Freq 2.44700000 GHz</p> <p>CF Step 5.00000000 MHz Auto Man</p> <p>Freq Offset 0.00000000 Hz</p> <p>Signal Track On Off</p>
<p>2437</p>	<p>Agilent R T</p> <p>Ch Freq 2.437 GHz Trig Free</p> <p>Occupied Bandwidth</p> <p>Ref 10 dBm #Atten 15 dB</p> <p>#Peak Log 10 dB/Offset 10.4 dB</p> <p>Center 2.437 GHz Span 50 MHz</p> <p>#Res BW 100 kHz #VBW 300 kHz Sweep 5.18 ms (401 pts)</p> <p>Occupied Bandwidth 36.1807 MHz</p> <p>Occ BW % Pwr 99.00 % x dB -6.00 dB</p> <p>Transmit Freq Error -44.773 kHz</p> <p>x dB Bandwidth 36.532 MHz</p> <p>Freq/Channel</p> <p>Center Freq 2.43700000 GHz</p> <p>Start Freq 2.41200000 GHz</p> <p>Stop Freq 2.46200000 GHz</p> <p>CF Step 5.00000000 MHz Auto Man</p> <p>Freq Offset 0.00000000 Hz</p> <p>Signal Track On Off</p>
<p>2452</p>	<p>Agilent R T</p> <p>Ch Freq 2.452 GHz Trig Free</p> <p>Occupied Bandwidth</p> <p>Ref 10 dBm #Atten 15 dB</p> <p>#Peak Log 10 dB/Offset 10.4 dB</p> <p>Center 2.452 GHz Span 50 MHz</p> <p>#Res BW 100 kHz #VBW 300 kHz Sweep 5.18 ms (401 pts)</p> <p>Occupied Bandwidth 36.1605 MHz</p> <p>Occ BW % Pwr 99.00 % x dB -6.00 dB</p> <p>Transmit Freq Error -56.327 kHz</p> <p>x dB Bandwidth 36.506 MHz</p> <p>Freq/Channel</p> <p>Center Freq 2.45200000 GHz</p> <p>Start Freq 2.42700000 GHz</p> <p>Stop Freq 2.47700000 GHz</p> <p>CF Step 5.00000000 MHz Auto Man</p> <p>Freq Offset 0.00000000 Hz</p> <p>Signal Track On Off</p>

8 Maximum Power Density Measurement

8.1. Limit

For digitally modulated systems, the power spectral density conducted from the intentional radiator to the antenna shall not be greater than 8 dBm in any 3 kHz band during any time interval of continuous transmission.

8.2. Test Setup

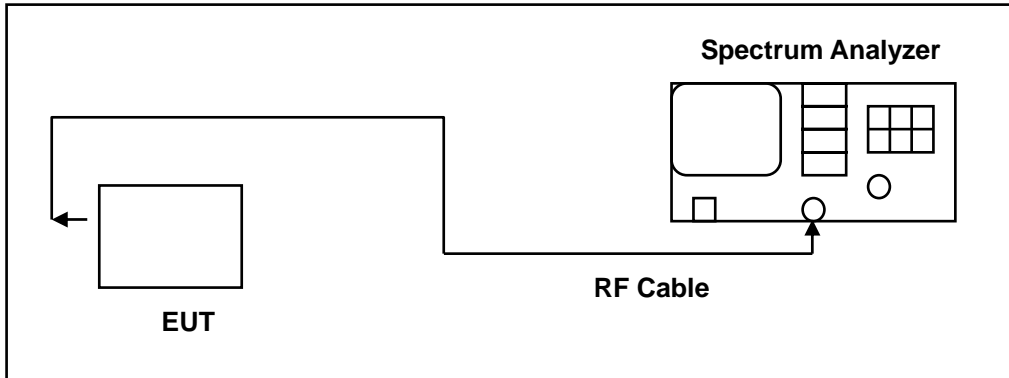

8.3. Test Instruments

Equipment	Manufacturer	Model Number	Serial Number	Cal. Date	Remark
Spectrum Analyzer	Agilent	E4445A	MY45300744	12/19/2012	(2)
Test Site	ATL	TE05	TE05	N.C.R.	-----

Remark: (1) Calibration period 1 year. (2) Calibration period 2 years. (3) Calibration period 3 years.

Note: N.C.R. = No Calibration Request.

8.4. Test Procedure

The EUT was setup to ANSI C63.4, 2009; tested to DTS test procedure of KDB558074D01 for compliance to FCC 47CFR 15.247 requirements.

1. Set analyzer center frequency to DTS channel center frequency.
2. Set the span to 1.5 times the DTS bandwidth.
3. Set the RBW to: $3 \text{ kHz} \leq \text{RBW} \leq 100 \text{ kHz}$.
4. Set the VBW ≥ 3 RBW.
5. Detector = peak.
6. Sweep time = auto couple.
7. Trace mode = max hold.
8. Allow trace to fully stabilize.
9. Use the peak marker function to determine the maximum amplitude level within the RBW.
10. If measured value exceeds limit, reduce RBW (no less than 3 kHz) and repeat.

8.5. Test Result

Model Number	A2-25DE		
Test Item	Maximum Power Density		
Test Mode	Mode 2: IEEE 802.11b Link Mode		
Date of Test	09/06/2013	Test Site	TE05
Frequency (MHz)	Reading (dBm/3KHz)		Limit (dBm)
2412	-9.646		< 8
2437	-7.864		< 8
2462	-9.674		< 8

Model Number	A2-25DE		
Test Item	Maximum Power Density		
Test Mode	Mode 3: IEEE 802.11g Link Mode		
Date of Test	09/06/2013	Test Site	TE05
Frequency (MHz)	Reading (dBm/3KHz)		Limit (dBm)
2412	-10.69		< 8
2437	-10.44		< 8
2462	-11.24		< 8

Model Number	A2-25DE		
Test Item	Maximum Power Density		
Test Mode	Mode 4: IEEE 802.11n 2.4GHz 20MHz Link Mode		
Date of Test	09/06/2013	Test Site	TE05
Frequency (MHz)	Reading (dBm/3KHz)		Limit (dBm)
2412	-12.27		< 8
2437	-9.85		< 8
2462	-10.47		< 8

Model Number	A2-25DE		
Test Item	Maximum Power Density		
Test Mode	Mode 5: IEEE 802.11n 2.4GHz 40MHz Link Mode		
Date of Test	09/06/2013	Test Site	TE05
Frequency (MHz)	Reading (dBm/3KHz)		Limit (dBm)
2422	-16.51		< 8
2437	-15.16		< 8
2452	-14.69		< 8

8.6. Test Graphs

Mode 2: IEEE 802.11b Link Mode	
2412	<p>Agilent R T Ref 10 dBm #Atten 15 dB Mkr1 2.40964 GHz Peak 9.646 dBm Log 10 dB/ Offset 10.4 dB DI 8.0 dBm M1 S2 S3 FC AA Center 2.412 GHz Span 16 MHz #Res BW 3 kHz #VBW 10 kHz Sweep 1.83 s (401 pts)</p> <p>Freq/Channel Center Freq 2.41200000 GHz Start Freq 2.40400000 GHz Stop Freq 2.42000000 GHz CF Step 1.60000000 MHz Auto Man Freq Offset 0.00000000 Hz Signal Track On Off</p>
2437	<p>Agilent R T Ref 10 dBm #Atten 15 dB Mkr1 2.43528 GHz Peak 7.864 dBm Log 10 dB/ Offset 10.4 dB DI 8.0 dBm M1 S2 S3 FC AA Center 2.437 GHz Span 16 MHz #Res BW 3 kHz #VBW 10 kHz Sweep 1.83 s (401 pts)</p> <p>Freq/Channel Center Freq 2.43700000 GHz Start Freq 2.42900000 GHz Stop Freq 2.44500000 GHz CF Step 1.60000000 MHz Auto Man Freq Offset 0.00000000 Hz Signal Track On Off</p>
2462	<p>Agilent R T Ref 10 dBm #Atten 15 dB Mkr1 2.46124 GHz Peak 9.674 dBm Log 10 dB/ Offset 10.4 dB DI 8.0 dBm M1 S2 S3 FC AA Center 2.462 GHz Span 16 MHz #Res BW 3 kHz #VBW 10 kHz Sweep 1.83 s (401 pts)</p> <p>Freq/Channel Center Freq 2.46200000 GHz Start Freq 2.45400000 GHz Stop Freq 2.47000000 GHz CF Step 1.60000000 MHz Auto Man Freq Offset 0.00000000 Hz Signal Track On Off</p>

Mode 3: IEEE 802.11g Link Mode

2412	<p>Agilent R T Ref 10 dBm #Atten 15 dB Mkr1 2.41886 GHz Peak Log 10 dB/Offset 10.4 dB DI 8.0 dBm M1 S2 S3 FC AA Center 2.412 GHz Span 28 MHz #Res BW 3 kHz #VBW 10 kHz Sweep 3.202 s (401 pts)</p> <p>Freq/Channel Center Freq 2.41200000 GHz Start Freq 2.39800000 GHz Stop Freq 2.42600000 GHz CF Step 2.80000000 MHz Auto Man Freq Offset 0.00000000 Hz Signal Track On Off</p>
2437	<p>Agilent R T Ref 10 dBm #Atten 15 dB Mkr1 2.44015 GHz Peak Log 10 dB/Offset 10.4 dB DI 8.0 dBm M1 S2 S3 FC AA Center 2.437 GHz Span 28 MHz #Res BW 3 kHz #VBW 10 kHz Sweep 3.202 s (401 pts)</p> <p>Freq/Channel Center Freq 2.43700000 GHz Start Freq 2.42300000 GHz Stop Freq 2.45100000 GHz CF Step 2.80000000 MHz Auto Man Freq Offset 0.00000000 Hz Signal Track On Off</p>
2462	<p>Agilent R T Ref 10 dBm #Atten 15 dB Mkr1 2.46039 GHz Peak Log 10 dB/Offset 10.4 dB DI 8.0 dBm M1 S2 S3 FC AA Center 2.462 GHz Span 28 MHz #Res BW 3 kHz #VBW 10 kHz Sweep 3.202 s (401 pts)</p> <p>Freq/Channel Center Freq 2.46200000 GHz Start Freq 2.44800000 GHz Stop Freq 2.47600000 GHz CF Step 2.80000000 MHz Auto Man Freq Offset 0.00000000 Hz Signal Track On Off</p>

Mode 4: IEEE 802.11n 2.4GHz 20MHz Link Mode

<p>2412</p>	<p>Agilent R T</p> <p>Ref 10 dBm #Atten 15 dB Mkr1 2.40577 GHz -12.27 dBm</p> <p>Peak Log 10 dB/Offset 10.4 dB DI 8.0 dBm</p> <p>M1 S2 S3 FC AA</p> <p>Center 2.412 GHz Span 28 MHz #Res BW 3 kHz #VBW 10 kHz Sweep 3.202 s (401 pts)</p> <p>Freq/Channel</p> <p>Center Freq 2.41200000 GHz</p> <p>Start Freq 2.39800000 GHz</p> <p>Stop Freq 2.42600000 GHz</p> <p>CF Step 2.80000000 MHz Auto Man</p> <p>Freq Offset 0.00000000 Hz</p> <p>Signal Track On Off</p>
<p>2437</p>	<p>Agilent R T</p> <p>Ref 10 dBm #Atten 15 dB Mkr1 2.43609 GHz -9.85 dBm</p> <p>Peak Log 10 dB/Offset 10.4 dB DI 8.0 dBm</p> <p>M1 S2 S3 FC AA</p> <p>Center 2.437 GHz Span 28 MHz #Res BW 3 kHz #VBW 10 kHz Sweep 3.202 s (401 pts)</p> <p>Freq/Channel</p> <p>Center Freq 2.43700000 GHz</p> <p>Start Freq 2.42300000 GHz</p> <p>Stop Freq 2.45100000 GHz</p> <p>CF Step 2.80000000 MHz Auto Man</p> <p>Freq Offset 0.00000000 Hz</p> <p>Signal Track On Off</p>
<p>2462</p>	<p>Agilent R T</p> <p>Ref 10 dBm #Atten 15 dB Mkr1 2.45577 GHz -10.47 dBm</p> <p>Peak Log 10 dB/Offset 10.4 dB DI 8.0 dBm</p> <p>M1 S2 S3 FC AA</p> <p>Center 2.462 GHz Span 28 MHz #Res BW 3 kHz #VBW 10 kHz Sweep 3.202 s (401 pts)</p> <p>Freq/Channel</p> <p>Center Freq 2.46200000 GHz</p> <p>Start Freq 2.44800000 GHz</p> <p>Stop Freq 2.47600000 GHz</p> <p>CF Step 2.80000000 MHz Auto Man</p> <p>Freq Offset 0.00000000 Hz</p> <p>Signal Track On Off</p>

Mode 5: IEEE 802.11n 2.4GHz 40MHz Link Mode

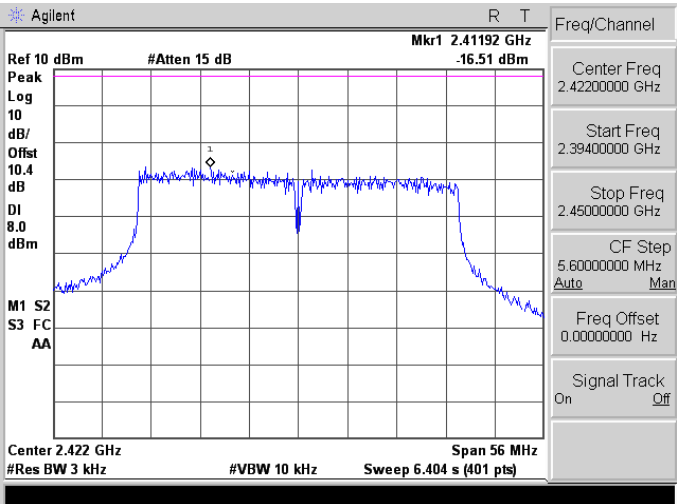
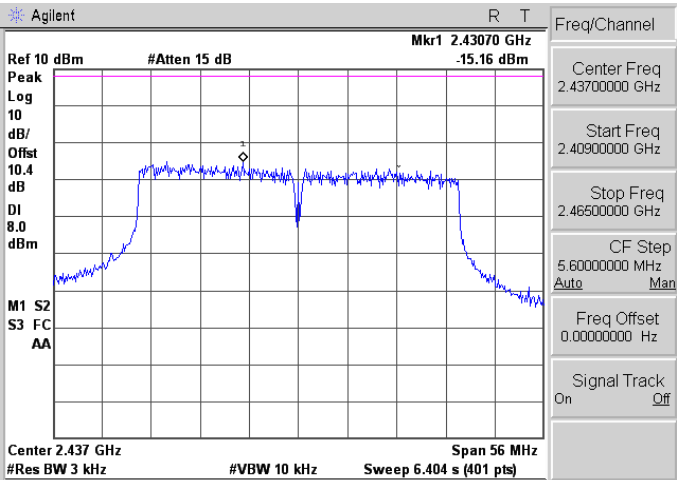
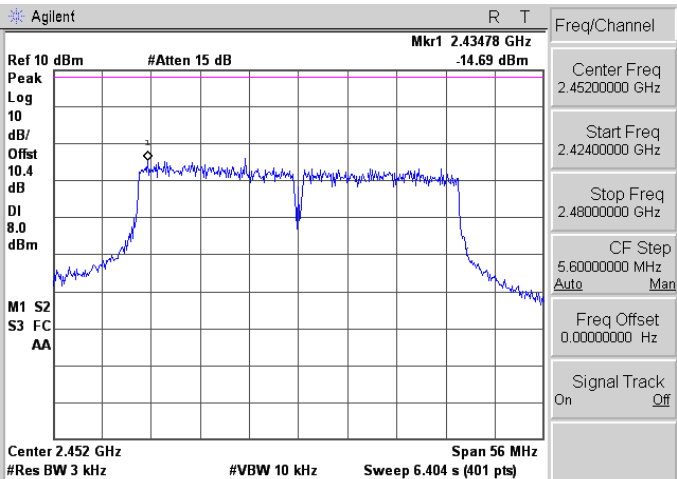
2422	 <p>Agilent R T Mkr1 2.4192 GHz -16.51 dBm Ref 10 dBm #Atten 15 dB Peak Log 10 dB/Offset 10.4 dB DI 8.0 dBm M1 S2 S3 FC AA Center 2.422 GHz Span 56 MHz #Res BW 3 kHz #VBW 10 kHz Sweep 6.404 s (401 pts)</p> <p>Freq/Channel Center Freq 2.42200000 GHz Start Freq 2.39400000 GHz Stop Freq 2.45000000 GHz CF Step 5.60000000 MHz Auto Man Freq Offset 0.00000000 Hz Signal Track On Off</p>
2437	 <p>Agilent R T Mkr1 2.43070 GHz -15.16 dBm Ref 10 dBm #Atten 15 dB Peak Log 10 dB/Offset 10.4 dB DI 8.0 dBm M1 S2 S3 FC AA Center 2.437 GHz Span 56 MHz #Res BW 3 kHz #VBW 10 kHz Sweep 6.404 s (401 pts)</p> <p>Freq/Channel Center Freq 2.43700000 GHz Start Freq 2.40900000 GHz Stop Freq 2.46500000 GHz CF Step 5.60000000 MHz Auto Man Freq Offset 0.00000000 Hz Signal Track On Off</p>
2452	 <p>Agilent R T Mkr1 2.43478 GHz -14.69 dBm Ref 10 dBm #Atten 15 dB Peak Log 10 dB/Offset 10.4 dB DI 8.0 dBm M1 S2 S3 FC AA Center 2.452 GHz Span 56 MHz #Res BW 3 kHz #VBW 10 kHz Sweep 6.404 s (401 pts)</p> <p>Freq/Channel Center Freq 2.45200000 GHz Start Freq 2.42400000 GHz Stop Freq 2.48000000 GHz CF Step 5.60000000 MHz Auto Man Freq Offset 0.00000000 Hz Signal Track On Off</p>

9 Out of Band Conducted Emissions Measurement

9.1. Limit

In any 100 kHz bandwidth outside the frequency band in which the spread spectrum or digitally modulated intentional radiator is operating, the radio frequency power that is produced by the intentional radiator shall be at least 20 dB below that in the 100 kHz bandwidth within the band that contains the highest level of the desired power

9.2. Test Setup

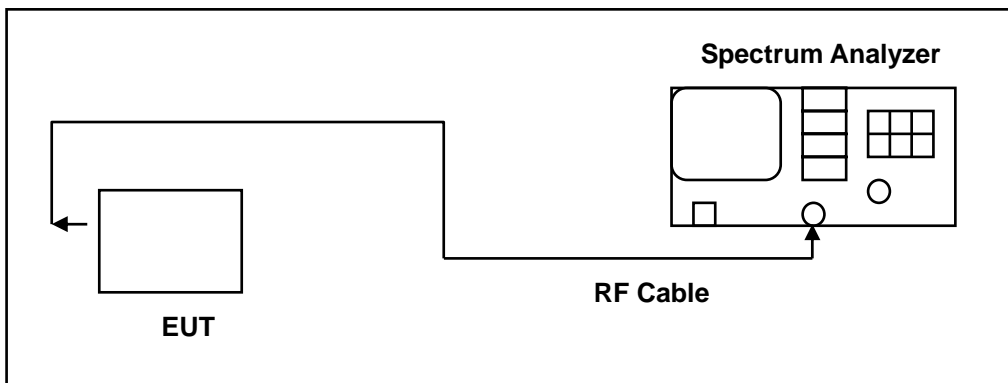

9.3. Test Instruments

Equipment	Manufacturer	Model Number	Serial Number	Cal. Date	Remark
Spectrum Analyzer	Agilent	E4445A	MY45300744	12/19/2012	(2)
Spectrum Analyzer	Agilent	E4408B	MY45107753	07/11/2013	(1)
Test Site	ATL	TE05	TE05	N.C.R.	-----

Remark: (1) Calibration period 1 year. (2) Calibration period 2 years. (3) Calibration period 3 years.

Note: N.C.R. = No Calibration Request.

9.4. Test Procedure

In any 100 kHz bandwidth outside the EUT pass band, the RF power produced by the modulation products of the spreading sequence, the information sequence, and the carrier frequency shall be at least 20 dB below that of the maximum in-band 100 kHz emission, antenna output of the EUT was coupled directly to spectrum analyzer; if an external attenuator and/or cable was used, these losses are compensated for with the analyzer OFFSET function.

All other types of emissions from the EUT shall meet the general limits for radiated frequencies outside the pass band.

The test was performed at 3 channels (Channel 1, 6, 11)

9.5. Test Graphs

Reference level

Mode 2: IEEE 802.11b Link Mode	
2412	<p>Agilent R T</p> <p>Ref 10 dBm #Atten 15 dB Mkr1 2.41248 GHz 2.371 dBm</p> <p>Peak Log 10 dB/Offset 10.4 dB</p> <p>M1 S2 S3 FC AA</p> <p>Center 2.412 GHz Span 16 MHz #Res BW 100 kHz #VBW 300 kHz Sweep 4 ms (401 pts)</p> <p>Freq/Channel</p> <p>Center Freq 2.41200000 GHz</p> <p>Start Freq 2.40400000 GHz</p> <p>Stop Freq 2.42000000 GHz</p> <p>CF Step 1.60000000 MHz Auto Man</p> <p>Freq Offset 0.00000000 Hz</p> <p>Signal Track On Off</p>
2437	<p>Agilent R T</p> <p>Ref 10 dBm #Atten 15 dB Mkr1 2.43800 GHz 4.404 dBm</p> <p>Peak Log 10 dB/Offset 10.4 dB</p> <p>M1 S2 S3 FC AA</p> <p>Center 2.437 GHz Span 16 MHz #Res BW 100 kHz #VBW 300 kHz Sweep 4 ms (401 pts)</p> <p>Freq/Channel</p> <p>Center Freq 2.43700000 GHz</p> <p>Start Freq 2.42900000 GHz</p> <p>Stop Freq 2.44500000 GHz</p> <p>CF Step 1.60000000 MHz Auto Man</p> <p>Freq Offset 0.00000000 Hz</p> <p>Signal Track On Off</p>
2462	<p>Agilent R T</p> <p>Ref 10 dBm #Atten 15 dB Mkr1 2.46048 GHz 3.801 dBm</p> <p>Peak Log 10 dB/Offset 10.4 dB</p> <p>M1 S2 S3 FC AA</p> <p>Center 2.462 GHz Span 16 MHz #Res BW 100 kHz #VBW 300 kHz Sweep 4 ms (401 pts)</p> <p>Freq/Channel</p> <p>Center Freq 2.46200000 GHz</p> <p>Start Freq 2.45400000 GHz</p> <p>Stop Freq 2.47000000 GHz</p> <p>CF Step 1.60000000 MHz Auto Man</p> <p>Freq Offset 0.00000000 Hz</p> <p>Signal Track On Off</p>

Mode 3: IEEE 802.11g Link Mode

2412	<p>Agilent R T</p> <p>Ref 10 dBm #Atten 15 dB Mkr1 2.40801 GHz -1.324 dBm</p> <p>Peak Log 10 dB/Offset 10.4 dB</p> <p>M1 S2 S3 FC AA</p> <p>Center 2.412 GHz Span 28 MHz #Res BW 100 kHz #VBW 300 kHz Sweep 4 ms (401 pts)</p> <p>Freq/Channel Center Freq 2.41200000 GHz Start Freq 2.39800000 GHz Stop Freq 2.42600000 GHz CF Step 2.80000000 MHz Auto Man Freq Offset 0.00000000 Hz Signal Track On Off</p>
2437	<p>Agilent R T</p> <p>Ref 10 dBm #Atten 15 dB Mkr1 2.43154 GHz 1.217 dBm</p> <p>Peak Log 10 dB/Offset 10.4 dB</p> <p>M1 S2 S3 FC AA</p> <p>Center 2.437 GHz Span 28 MHz #Res BW 100 kHz #VBW 300 kHz Sweep 4 ms (401 pts)</p> <p>Freq/Channel Center Freq 2.43700000 GHz Start Freq 2.42300000 GHz Stop Freq 2.45100000 GHz CF Step 2.80000000 MHz Auto Man Freq Offset 0.00000000 Hz Signal Track On Off</p>
2462	<p>Agilent R T</p> <p>Ref 10 dBm #Atten 15 dB Mkr1 2.45549 GHz 0.052 dBm</p> <p>Peak Log 10 dB/Offset 10.4 dB</p> <p>M1 S2 S3 FC AA</p> <p>Center 2.462 GHz Span 28 MHz #Res BW 100 kHz #VBW 300 kHz Sweep 4 ms (401 pts)</p> <p>Freq/Channel Center Freq 2.46200000 GHz Start Freq 2.44800000 GHz Stop Freq 2.47600000 GHz CF Step 2.80000000 MHz Auto Man Freq Offset 0.00000000 Hz Signal Track On Off</p>

Mode 4: IEEE 802.11n 2.4GHz 20MHz Link Mode

<p>2412</p>	
<p>2437</p>	
<p>2462</p>	

Mode 5: IEEE 802.11n 2.4GHz 40MHz Link Mode

<p>2422</p>	<p>Agilent R T</p> <p>Ref 10 dBm #Atten 15 dB Mkr1 2.40982 GHz 4.485 dBm</p> <p>Peak Log dB/Offst 10.4 dB</p> <p>M1 S2 S3 FC AA</p> <p>Center 2.422 GHz Span 56 MHz #Res BW 100 kHz #VBW 300 kHz Sweep 5.802 ms (401 pts)</p> <p>Freq/Channel</p> <p>Center Freq 2.42200000 GHz</p> <p>Start Freq 2.39400000 GHz</p> <p>Stop Freq 2.45000000 GHz</p> <p>CF Step 5.60000000 MHz Auto Man</p> <p>Freq Offset 0.00000000 Hz</p> <p>Signal Track On Off</p>
<p>2437</p>	<p>Agilent R T</p> <p>Ref 10 dBm #Atten 15 dB Mkr1 2.42244 GHz 2.917 dBm</p> <p>Peak Log dB/Offst 10.4 dB</p> <p>M1 S2 S3 FC AA</p> <p>Center 2.437 GHz Span 56 MHz #Res BW 100 kHz #VBW 300 kHz Sweep 5.802 ms (401 pts)</p> <p>Freq/Channel</p> <p>Center Freq 2.43700000 GHz</p> <p>Start Freq 2.40900000 GHz</p> <p>Stop Freq 2.46500000 GHz</p> <p>CF Step 5.60000000 MHz Auto Man</p> <p>Freq Offset 0.00000000 Hz</p> <p>Signal Track On Off</p>
<p>2452</p>	<p>Agilent R T</p> <p>Ref 10 dBm #Atten 15 dB Mkr1 2.43674 GHz 2.503 dBm</p> <p>Peak Log dB/Offst 10.4 dB</p> <p>M1 S2 S3 FC AA</p> <p>Center 2.452 GHz Span 56 MHz #Res BW 100 kHz #VBW 300 kHz Sweep 5.802 ms (401 pts)</p> <p>Freq/Channel</p> <p>Center Freq 2.45200000 GHz</p> <p>Start Freq 2.42400000 GHz</p> <p>Stop Freq 2.48000000 GHz</p> <p>CF Step 5.60000000 MHz Auto Man</p> <p>Freq Offset 0.00000000 Hz</p> <p>Signal Track On Off</p>

Out of Band Conducted Emissions

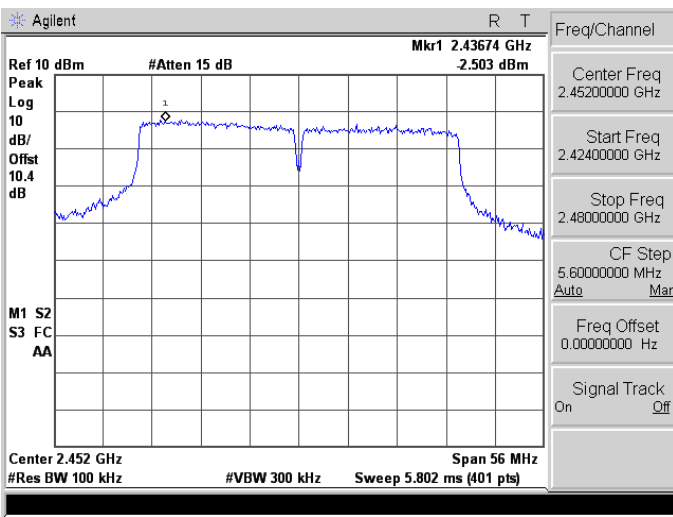
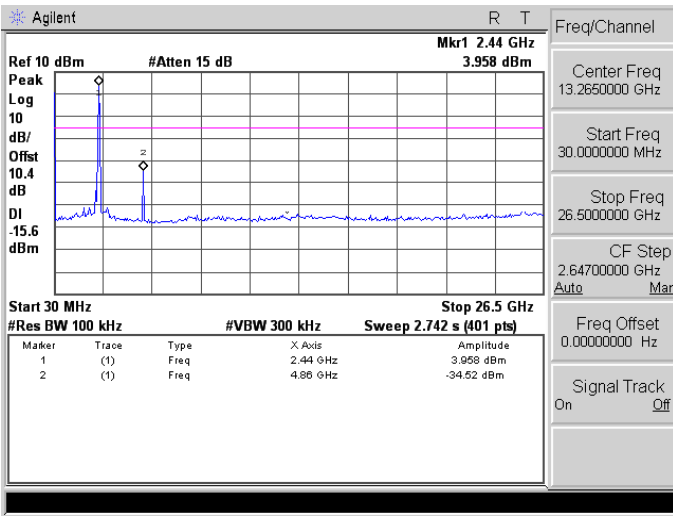
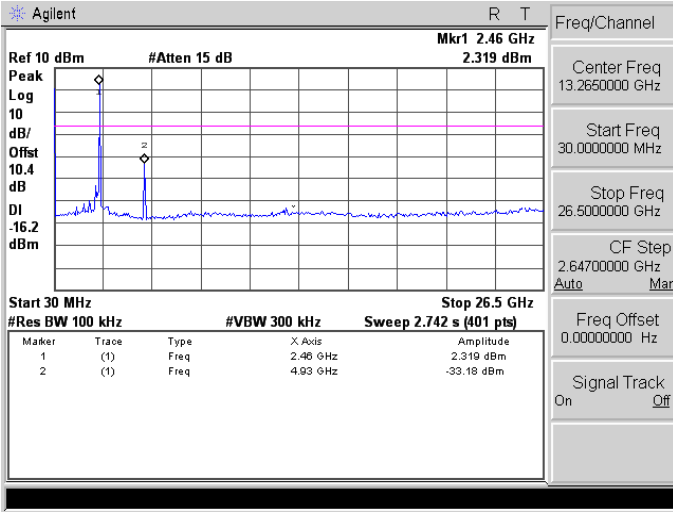
Mode 2: IEEE 802.11b Link Mode																
2412	 <p>Agilent R T Freq/Channel</p> <p>Ref 10 dBm #Atten 15 dB Mkr1 2.43674 GHz 2.503 dBm</p> <p>Center Freq 2.4520000 GHz</p> <p>Start Freq 2.4240000 GHz</p> <p>Stop Freq 2.4800000 GHz</p> <p>CF Step 5.6000000 MHz Auto Man</p> <p>Freq Offset 0.0000000 Hz</p> <p>Signal Track On Off</p> <p>Center 2.452 GHz Span 56 MHz</p> <p>#Res BW 100 kHz #VBW 300 kHz Sweep 5.802 ms (401 pts)</p>															
2437	 <p>Agilent R T Freq/Channel</p> <p>Ref 10 dBm #Atten 15 dB Mkr1 2.44 GHz 3.958 dBm</p> <p>Center Freq 13.2650000 GHz</p> <p>Start Freq 30.0000000 MHz</p> <p>Stop Freq 26.5000000 GHz</p> <p>CF Step 2.64700000 GHz Auto Man</p> <p>Freq Offset 0.0000000 Hz</p> <p>Signal Track On Off</p> <p>Start 30 MHz Stop 26.5 GHz</p> <p>#Res BW 100 kHz #VBW 300 kHz Sweep 2.742 s (401 pts)</p> <table border="1"> <thead> <tr> <th>Marker</th> <th>Trace</th> <th>Type</th> <th>X Axis</th> <th>Amplitude</th> </tr> </thead> <tbody> <tr> <td>1</td> <td>(1)</td> <td>Freq</td> <td>2.44 GHz</td> <td>3.958 dBm</td> </tr> <tr> <td>2</td> <td>(1)</td> <td>Freq</td> <td>4.88 GHz</td> <td>-34.52 dBm</td> </tr> </tbody> </table>	Marker	Trace	Type	X Axis	Amplitude	1	(1)	Freq	2.44 GHz	3.958 dBm	2	(1)	Freq	4.88 GHz	-34.52 dBm
Marker	Trace	Type	X Axis	Amplitude												
1	(1)	Freq	2.44 GHz	3.958 dBm												
2	(1)	Freq	4.88 GHz	-34.52 dBm												
2462	 <p>Agilent R T Freq/Channel</p> <p>Ref 10 dBm #Atten 15 dB Mkr1 2.46 GHz 2.319 dBm</p> <p>Center Freq 13.2650000 GHz</p> <p>Start Freq 30.0000000 MHz</p> <p>Stop Freq 26.5000000 GHz</p> <p>CF Step 2.64700000 GHz Auto Man</p> <p>Freq Offset 0.0000000 Hz</p> <p>Signal Track On Off</p> <p>Start 30 MHz Stop 26.5 GHz</p> <p>#Res BW 100 kHz #VBW 300 kHz Sweep 2.742 s (401 pts)</p> <table border="1"> <thead> <tr> <th>Marker</th> <th>Trace</th> <th>Type</th> <th>X Axis</th> <th>Amplitude</th> </tr> </thead> <tbody> <tr> <td>1</td> <td>(1)</td> <td>Freq</td> <td>2.46 GHz</td> <td>2.319 dBm</td> </tr> <tr> <td>2</td> <td>(1)</td> <td>Freq</td> <td>4.93 GHz</td> <td>-33.18 dBm</td> </tr> </tbody> </table>	Marker	Trace	Type	X Axis	Amplitude	1	(1)	Freq	2.46 GHz	2.319 dBm	2	(1)	Freq	4.93 GHz	-33.18 dBm
Marker	Trace	Type	X Axis	Amplitude												
1	(1)	Freq	2.46 GHz	2.319 dBm												
2	(1)	Freq	4.93 GHz	-33.18 dBm												

Mode 3: IEEE 802.11g Link Mode

2412	<p>Agilent R T</p> <p>Ref 10 dBm #Atten 15 dB Mkr1 2.41 GHz -1.915 dBm</p> <p>Peak Log 10 dB/Offset 10.4 dB DI -21.3 dBm</p> <p>Start 30 MHz Stop 26.5 GHz</p> <p>#Res BW 100 kHz #VBW 300 kHz Sweep 2.742 s (401 pts)</p> <table border="1"> <thead> <tr> <th>Marker</th> <th>Trace</th> <th>Type</th> <th>X Axis</th> <th>Amplitude</th> </tr> </thead> <tbody> <tr> <td>1</td> <td>(1)</td> <td>Freq</td> <td>2.41 GHz</td> <td>-1.915 dBm</td> </tr> <tr> <td>2</td> <td>(1)</td> <td>Freq</td> <td>4.79 GHz</td> <td>-50.65 dBm</td> </tr> </tbody> </table> <p>Freq/Channel: Center Freq 13.2650000 GHz, Start Freq 30.0000000 MHz, Stop Freq 26.5000000 GHz, CF Step 2.64700000 GHz, Freq Offset 0.00000000 Hz, Signal Track On Off</p>	Marker	Trace	Type	X Axis	Amplitude	1	(1)	Freq	2.41 GHz	-1.915 dBm	2	(1)	Freq	4.79 GHz	-50.65 dBm
Marker	Trace	Type	X Axis	Amplitude												
1	(1)	Freq	2.41 GHz	-1.915 dBm												
2	(1)	Freq	4.79 GHz	-50.65 dBm												
2437	<p>Agilent R T</p> <p>Ref 10 dBm #Atten 15 dB Mkr1 2.44 GHz 0.35 dBm</p> <p>Peak Log 10 dB/Offset 10.4 dB DI -18.8 dBm</p> <p>Start 30 MHz Stop 26.5 GHz</p> <p>#Res BW 100 kHz #VBW 300 kHz Sweep 2.742 s (401 pts)</p> <table border="1"> <thead> <tr> <th>Marker</th> <th>Trace</th> <th>Type</th> <th>X Axis</th> <th>Amplitude</th> </tr> </thead> <tbody> <tr> <td>1</td> <td>(1)</td> <td>Freq</td> <td>2.44 GHz</td> <td>0.35 dBm</td> </tr> <tr> <td>2</td> <td>(1)</td> <td>Freq</td> <td>4.86 GHz</td> <td>-40.59 dBm</td> </tr> </tbody> </table> <p>Freq/Channel: Center Freq 13.2650000 GHz, Start Freq 30.0000000 MHz, Stop Freq 26.5000000 GHz, CF Step 2.64700000 GHz, Freq Offset 0.00000000 Hz, Signal Track On Off</p>	Marker	Trace	Type	X Axis	Amplitude	1	(1)	Freq	2.44 GHz	0.35 dBm	2	(1)	Freq	4.86 GHz	-40.59 dBm
Marker	Trace	Type	X Axis	Amplitude												
1	(1)	Freq	2.44 GHz	0.35 dBm												
2	(1)	Freq	4.86 GHz	-40.59 dBm												
2462	<p>Agilent R T</p> <p>Ref 10 dBm #Atten 15 dB Mkr1 2.46 GHz -0.694 dBm</p> <p>Peak Log 10 dB/Offset 10.4 dB DI -19.5 dBm</p> <p>Start 30 MHz Stop 26.5 GHz</p> <p>#Res BW 100 kHz #VBW 300 kHz Sweep 2.742 s (401 pts)</p> <table border="1"> <thead> <tr> <th>Marker</th> <th>Trace</th> <th>Type</th> <th>X Axis</th> <th>Amplitude</th> </tr> </thead> <tbody> <tr> <td>1</td> <td>(1)</td> <td>Freq</td> <td>2.46 GHz</td> <td>-0.694 dBm</td> </tr> <tr> <td>2</td> <td>(1)</td> <td>Freq</td> <td>4.93 GHz</td> <td>-38.74 dBm</td> </tr> </tbody> </table> <p>Freq/Channel: Center Freq 13.2650000 GHz, Start Freq 30.0000000 MHz, Stop Freq 26.5000000 GHz, CF Step 2.64700000 GHz, Freq Offset 0.00000000 Hz, Signal Track On Off</p>	Marker	Trace	Type	X Axis	Amplitude	1	(1)	Freq	2.46 GHz	-0.694 dBm	2	(1)	Freq	4.93 GHz	-38.74 dBm
Marker	Trace	Type	X Axis	Amplitude												
1	(1)	Freq	2.46 GHz	-0.694 dBm												
2	(1)	Freq	4.93 GHz	-38.74 dBm												

Mode 4: IEEE 802.11n 2.4GHz 20MHz Link Mode

<p>2412</p>	<p>Agilent R T</p> <p>Ref 10 dBm #Atten 15 dB Mkr1 2.41 GHz 2.052 dBm</p> <p>Peak Log 10 dB/Offst 10.4 dB DI -21.6 dBm</p> <p>Start 30 MHz Stop 26.5 GHz</p> <p>#Res BW 100 kHz #VBW 300 kHz Sweep 2.742 s (401 pts)</p> <table border="1"> <thead> <tr> <th>Marker</th> <th>Trace</th> <th>Type</th> <th>X Axis</th> <th>Amplitude</th> </tr> </thead> <tbody> <tr> <td>1</td> <td>(1)</td> <td>Freq</td> <td>2.41 GHz</td> <td>-2.052 dBm</td> </tr> <tr> <td>2</td> <td>(1)</td> <td>Freq</td> <td>4.79 GHz</td> <td>-52.11 dBm</td> </tr> </tbody> </table> <p>Freq/Channel</p> <p>Center Freq 13.2650000 GHz</p> <p>Start Freq 30.0000000 MHz</p> <p>Stop Freq 26.5000000 GHz</p> <p>CF Step 2.64700000 GHz Auto Man</p> <p>Freq Offset 0.00000000 Hz</p> <p>Signal Track On Off</p>	Marker	Trace	Type	X Axis	Amplitude	1	(1)	Freq	2.41 GHz	-2.052 dBm	2	(1)	Freq	4.79 GHz	-52.11 dBm
Marker	Trace	Type	X Axis	Amplitude												
1	(1)	Freq	2.41 GHz	-2.052 dBm												
2	(1)	Freq	4.79 GHz	-52.11 dBm												
<p>2437</p>	<p>Agilent R T</p> <p>Ref 10 dBm #Atten 15 dB Mkr1 2.44 GHz 0.13 dBm</p> <p>Peak Log 10 dB/Offst 10.4 dB DI -18.9 dBm</p> <p>Start 30 MHz Stop 26.5 GHz</p> <p>#Res BW 100 kHz #VBW 300 kHz Sweep 2.742 s (401 pts)</p> <table border="1"> <thead> <tr> <th>Marker</th> <th>Trace</th> <th>Type</th> <th>X Axis</th> <th>Amplitude</th> </tr> </thead> <tbody> <tr> <td>1</td> <td>(1)</td> <td>Freq</td> <td>2.44 GHz</td> <td>0.13 dBm</td> </tr> <tr> <td>2</td> <td>(1)</td> <td>Freq</td> <td>4.86 GHz</td> <td>-41.41 dBm</td> </tr> </tbody> </table> <p>Freq/Channel</p> <p>Center Freq 13.2650000 GHz</p> <p>Start Freq 30.0000000 MHz</p> <p>Stop Freq 26.5000000 GHz</p> <p>CF Step 2.64700000 GHz Auto Man</p> <p>Freq Offset 0.00000000 Hz</p> <p>Signal Track On Off</p>	Marker	Trace	Type	X Axis	Amplitude	1	(1)	Freq	2.44 GHz	0.13 dBm	2	(1)	Freq	4.86 GHz	-41.41 dBm
Marker	Trace	Type	X Axis	Amplitude												
1	(1)	Freq	2.44 GHz	0.13 dBm												
2	(1)	Freq	4.86 GHz	-41.41 dBm												
<p>2462</p>	<p>Agilent R T</p> <p>Ref 10 dBm #Atten 15 dB Mkr1 2.46 GHz -1.166 dBm</p> <p>Peak Log 10 dB/Offst 10.4 dB DI -20.5 dBm</p> <p>Start 30 MHz Stop 26.5 GHz</p> <p>#Res BW 100 kHz #VBW 300 kHz Sweep 2.742 s (401 pts)</p> <table border="1"> <thead> <tr> <th>Marker</th> <th>Trace</th> <th>Type</th> <th>X Axis</th> <th>Amplitude</th> </tr> </thead> <tbody> <tr> <td>1</td> <td>(1)</td> <td>Freq</td> <td>2.46 GHz</td> <td>-1.166 dBm</td> </tr> <tr> <td>2</td> <td>(1)</td> <td>Freq</td> <td>4.93 GHz</td> <td>-38.75 dBm</td> </tr> </tbody> </table> <p>Freq/Channel</p> <p>Center Freq 13.2650000 GHz</p> <p>Start Freq 30.0000000 MHz</p> <p>Stop Freq 26.5000000 GHz</p> <p>CF Step 2.64700000 GHz Auto Man</p> <p>Freq Offset 0.00000000 Hz</p> <p>Signal Track On Off</p>	Marker	Trace	Type	X Axis	Amplitude	1	(1)	Freq	2.46 GHz	-1.166 dBm	2	(1)	Freq	4.93 GHz	-38.75 dBm
Marker	Trace	Type	X Axis	Amplitude												
1	(1)	Freq	2.46 GHz	-1.166 dBm												
2	(1)	Freq	4.93 GHz	-38.75 dBm												

Mode 5: IEEE 802.11n 2.4GHz 40MHz Link Mode

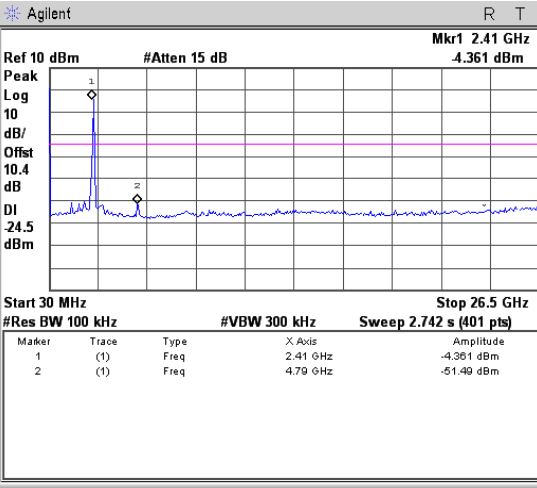
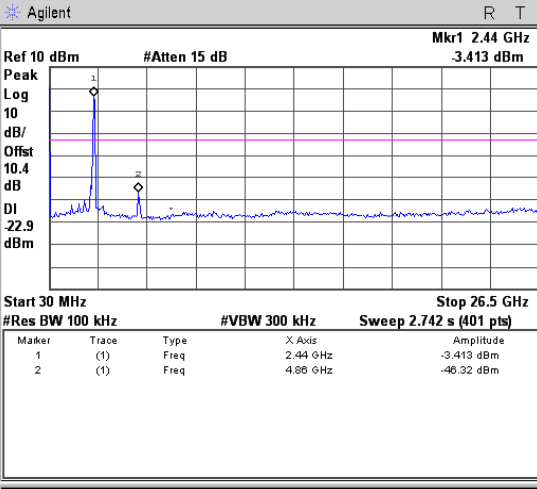
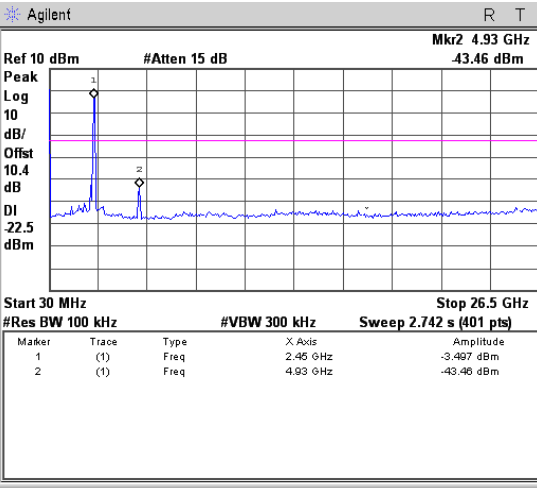
<p>2422</p>	 <p>Agilent R T</p> <p>Ref 10 dBm #Atten 15 dB Mkr1 2.41 GHz 4.361 dBm</p> <p>Peak Log 10 dB/Offset 10.4 dB DI -24.5 dBm</p> <p>Start 30 MHz Stop 26.5 GHz</p> <p>#Res BW 100 kHz #VBW 300 kHz Sweep 2.742 s (401 pts)</p> <table border="1"> <thead> <tr> <th>Marker</th> <th>Trace</th> <th>Type</th> <th>X Axis</th> <th>Amplitude</th> </tr> </thead> <tbody> <tr> <td>1</td> <td>(1)</td> <td>Freq</td> <td>2.41 GHz</td> <td>-4.361 dBm</td> </tr> <tr> <td>2</td> <td>(1)</td> <td>Freq</td> <td>4.79 GHz</td> <td>-51.99 dBm</td> </tr> </tbody> </table> <p>Freq/Channel</p> <p>Center Freq 13.2650000 GHz</p> <p>Start Freq 30.0000000 MHz</p> <p>Stop Freq 26.5000000 GHz</p> <p>CF Step 2.64700000 GHz Auto Man</p> <p>Freq Offset 0.00000000 Hz</p> <p>Signal Track On Off</p>	Marker	Trace	Type	X Axis	Amplitude	1	(1)	Freq	2.41 GHz	-4.361 dBm	2	(1)	Freq	4.79 GHz	-51.99 dBm
Marker	Trace	Type	X Axis	Amplitude												
1	(1)	Freq	2.41 GHz	-4.361 dBm												
2	(1)	Freq	4.79 GHz	-51.99 dBm												
<p>2437</p>	 <p>Agilent R T</p> <p>Ref 10 dBm #Atten 15 dB Mkr1 2.44 GHz 3.413 dBm</p> <p>Peak Log 10 dB/Offset 10.4 dB DI -22.9 dBm</p> <p>Start 30 MHz Stop 26.5 GHz</p> <p>#Res BW 100 kHz #VBW 300 kHz Sweep 2.742 s (401 pts)</p> <table border="1"> <thead> <tr> <th>Marker</th> <th>Trace</th> <th>Type</th> <th>X Axis</th> <th>Amplitude</th> </tr> </thead> <tbody> <tr> <td>1</td> <td>(1)</td> <td>Freq</td> <td>2.44 GHz</td> <td>-3.413 dBm</td> </tr> <tr> <td>2</td> <td>(1)</td> <td>Freq</td> <td>4.86 GHz</td> <td>-46.32 dBm</td> </tr> </tbody> </table> <p>Freq/Channel</p> <p>Center Freq 13.2650000 GHz</p> <p>Start Freq 30.0000000 MHz</p> <p>Stop Freq 26.5000000 GHz</p> <p>CF Step 2.64700000 GHz Auto Man</p> <p>Freq Offset 0.00000000 Hz</p> <p>Signal Track On Off</p>	Marker	Trace	Type	X Axis	Amplitude	1	(1)	Freq	2.44 GHz	-3.413 dBm	2	(1)	Freq	4.86 GHz	-46.32 dBm
Marker	Trace	Type	X Axis	Amplitude												
1	(1)	Freq	2.44 GHz	-3.413 dBm												
2	(1)	Freq	4.86 GHz	-46.32 dBm												
<p>2452</p>	 <p>Agilent R T</p> <p>Ref 10 dBm #Atten 15 dB Mkr2 4.93 GHz 43.46 dBm</p> <p>Peak Log 10 dB/Offset 10.4 dB DI -22.5 dBm</p> <p>Start 30 MHz Stop 26.5 GHz</p> <p>#Res BW 100 kHz #VBW 300 kHz Sweep 2.742 s (401 pts)</p> <table border="1"> <thead> <tr> <th>Marker</th> <th>Trace</th> <th>Type</th> <th>X Axis</th> <th>Amplitude</th> </tr> </thead> <tbody> <tr> <td>1</td> <td>(1)</td> <td>Freq</td> <td>2.45 GHz</td> <td>-3.497 dBm</td> </tr> <tr> <td>2</td> <td>(1)</td> <td>Freq</td> <td>4.93 GHz</td> <td>-43.46 dBm</td> </tr> </tbody> </table> <p>Freq/Channel</p> <p>Center Freq 13.2650000 GHz</p> <p>Start Freq 30.0000000 MHz</p> <p>Stop Freq 26.5000000 GHz</p> <p>CF Step 2.64700000 GHz Auto Man</p> <p>Freq Offset 0.00000000 Hz</p> <p>Signal Track On Off</p>	Marker	Trace	Type	X Axis	Amplitude	1	(1)	Freq	2.45 GHz	-3.497 dBm	2	(1)	Freq	4.93 GHz	-43.46 dBm
Marker	Trace	Type	X Axis	Amplitude												
1	(1)	Freq	2.45 GHz	-3.497 dBm												
2	(1)	Freq	4.93 GHz	-43.46 dBm												

Conducted Band Edge

Mode 2: IEEE 802.11b Link Mode

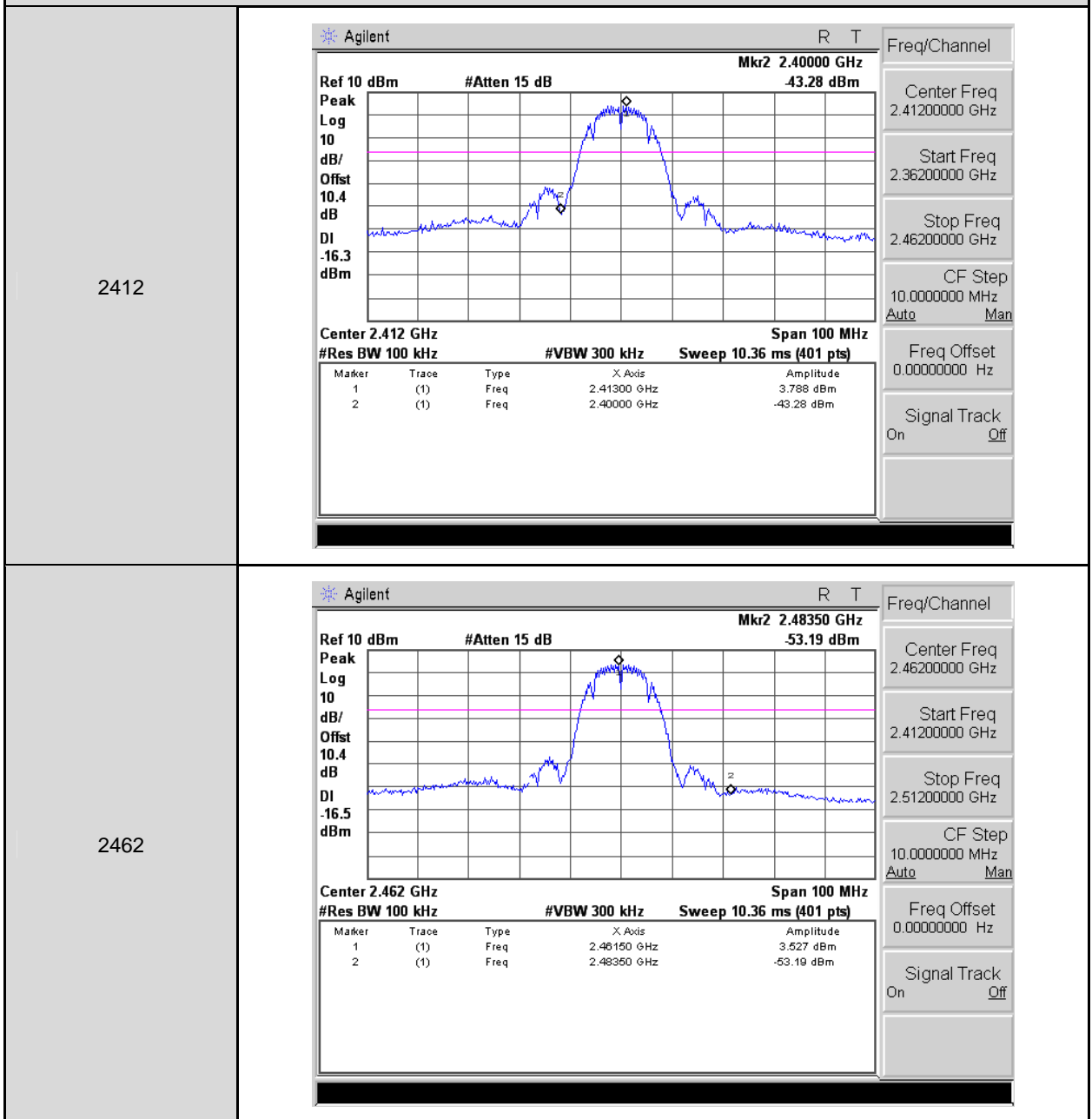

Mode 3: IEEE 802.11g Link Mode

2412

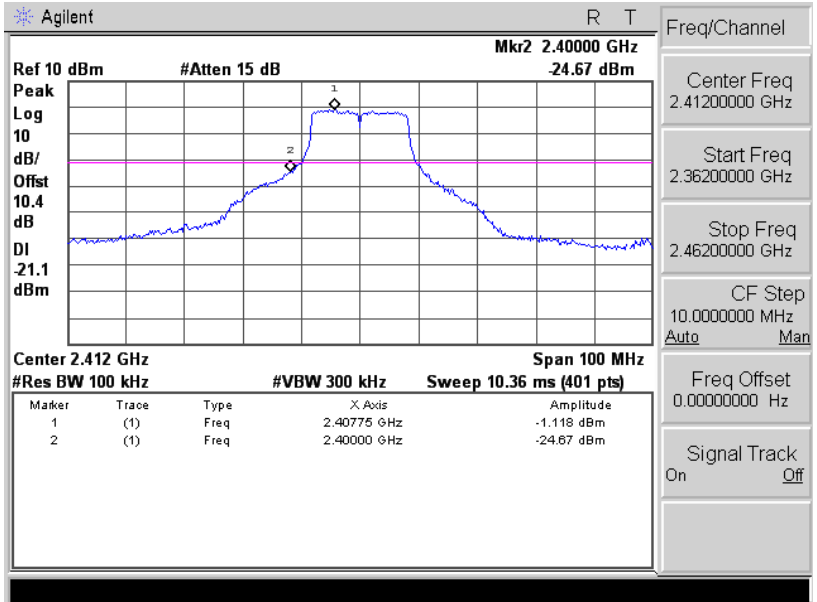

2462

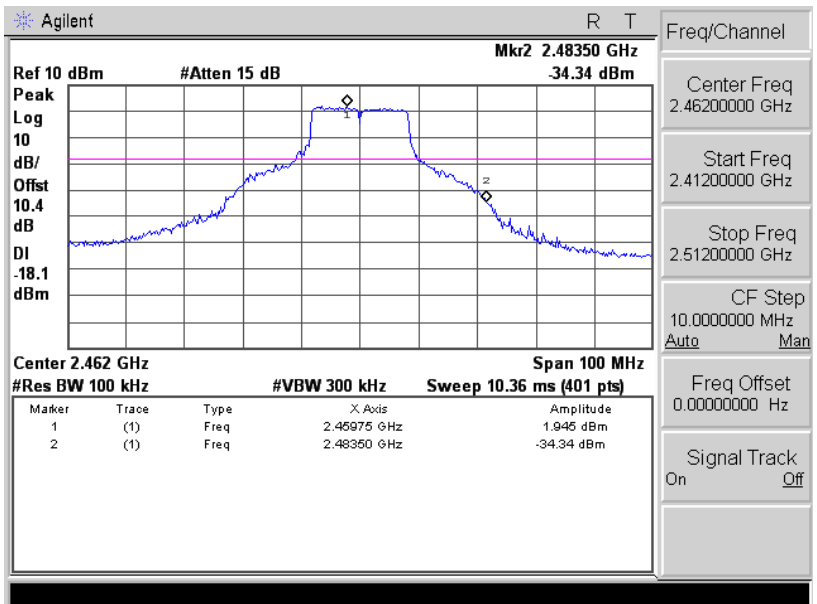

Mode 4: IEEE 802.11n 2.4GHz 20MHz Link Mode

2412

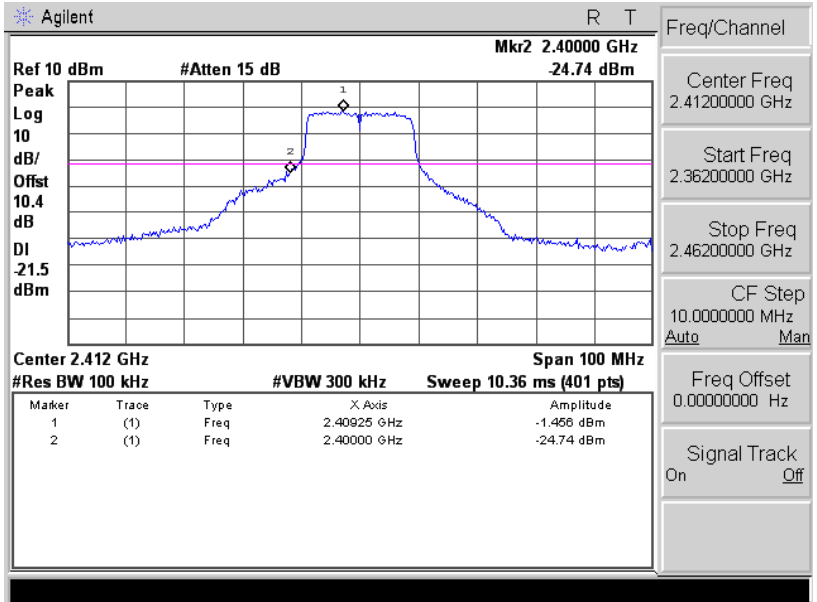

2462

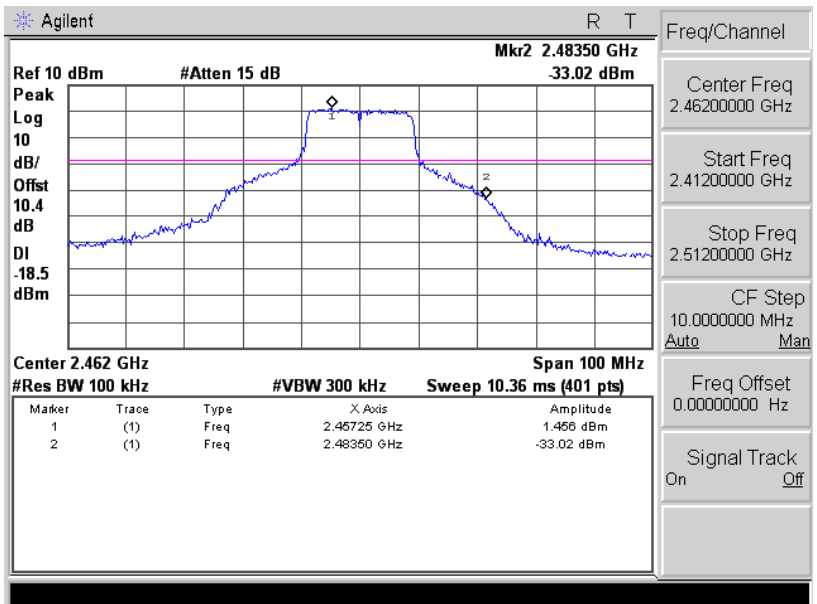

Mode 5: IEEE 802.11n 2.4GHz 40MHz Link Mode

2422

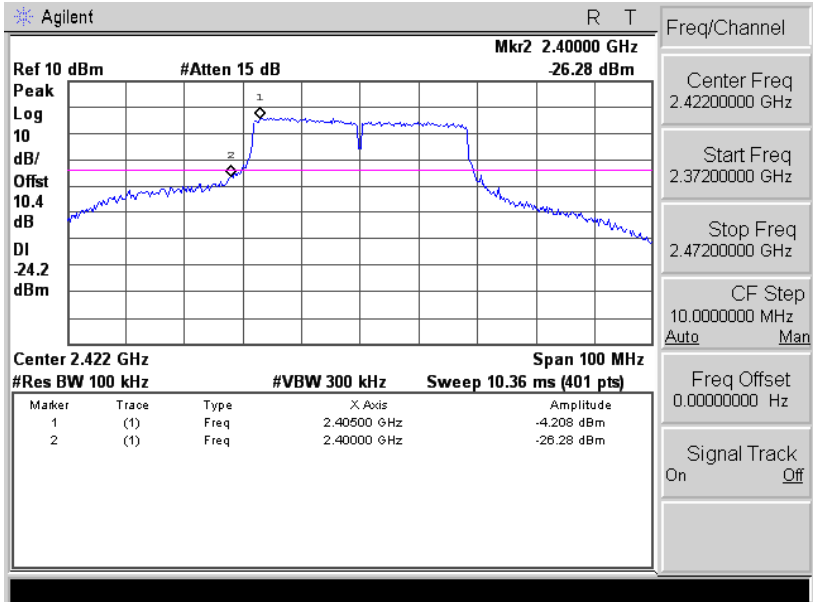

2452

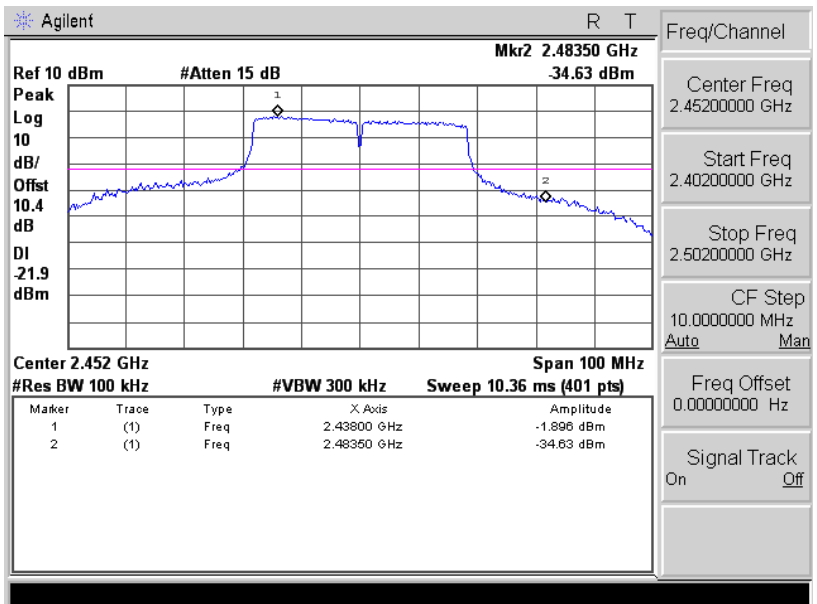

10 Band Edges Measurement

10.1.Limit

In any 100 kHz bandwidth outside the intentional radiation frequency band, the radio frequency power shall be at least 20 dB below the highest level of the radiated power. In addition, radiated emissions which fall in the restricted bands must also comply with the radiated emission limits.

10.2.Test Setup

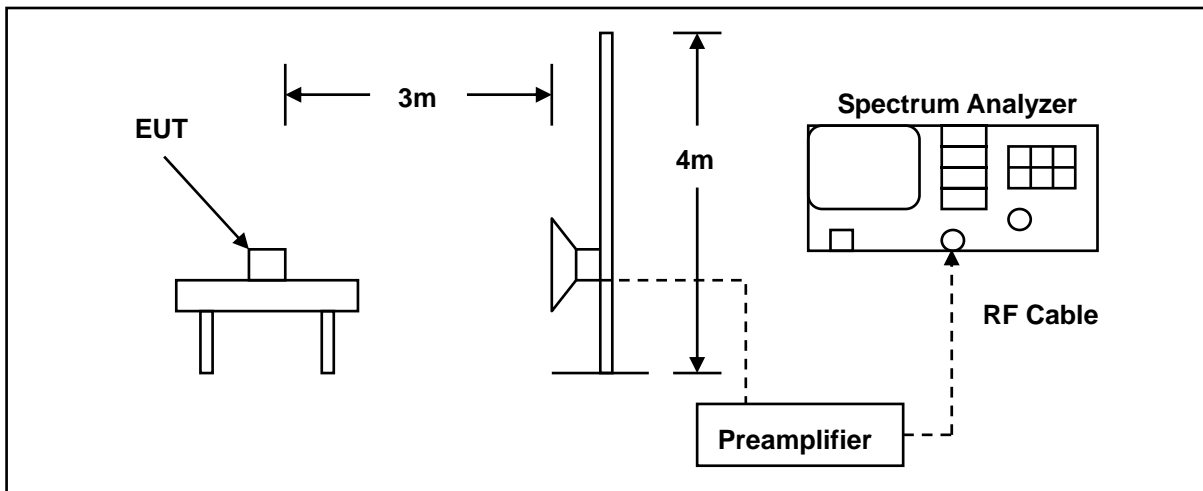

10.3.Test Instruments

3 Meter Chamber					
Equipment	Manufacturer	Model Number	Serial Number	Cal. Date	Remark
RF Pre-selector	Agilent	N9039A	MY46520256	01/21/2013	(1)
Spectrum Analyzer	Agilent	E4446A	MY46180578	01/21/2013	(1)
Pre Amplifier	Agilent	8449B	3008A02237	02/21/2013	(1)
Pre Amplifier	Agilent	8447D	2944A10961	02/21/2013	(1)
Horn Antenna (1~18GHz)	SCHWARZBECK MESS-ELEKTRONIK	BBHA9120D	9120D-550	06/10/2013	(1)
Test Site	ATL	TE01	888001	08/28/2012	(1)

Remark: (1) Calibration period 1 year. (2) Calibration period 2 years. (3) Calibration period 3 years.

Note: N.C.R. = No Calibration Request.

10.4. Test Procedure

The EUT was setup to ANSI C63.4, 2009; tested to DTS test procedure of Oct 2012 KDB558074 for compliance to FCC 47CFR 15.247 requirements.

The emissions on the harmonics frequencies, the limits, and the margin of compliance are presented. These tests were made when the transmitter was in full radiated power. The additional test was performed to show compliance with the requirement at the band-edge frequency 2483.5 MHz and up to 2500 MHz and at 2390.0 MHz.

The transmitter was configured with the worst case antenna and setup to transmit at the highest channel. Then the field strength was measured at 2483.5 MHz.

The transmitter was then configured with the worst case antenna and setup to transmit at the lowest channel. Then the field strength was measured at 2390.0 MHz. These tests were performed at 4 different bit rates.

For measurements the resolution bandwidth is set to 1 MHz, and then the video bandwidth is set to 1 MHz for peak measurements and 10 Hz for average measurements.

10.5. Test Result

Standard:	FCC Part 15C	Test Distance:	3m
Test item:	Radiated Emission	Power:	AC 120V/60Hz
Model Number:	A2-25DE	Temp.(°C)/Hum.(%RH):	26(°C)/60%RH
Mode:	2	Date:	08/23/2013
Frequency:	2412 MHz	Test By:	Fly Lu
Ant.Polar.:	Horizontal		

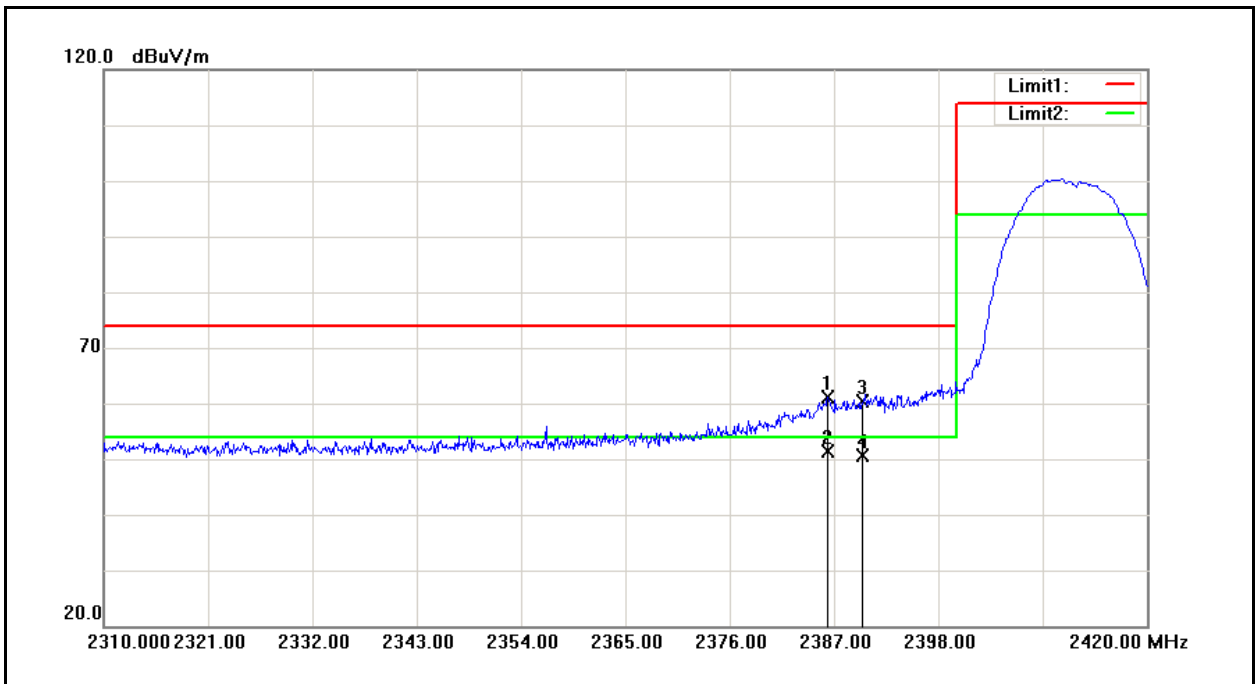

No.	Frequency (MHz)	Reading (dBuV)	Correct Factor (dB/m)	Result (dBuV/m)	Limit (dBuV/m)	Margin (dB)	Remark
1	2386.340	57.29	3.86	61.15	74.00	-12.85	peak
2	2386.340	47.55	3.86	51.41	54.00	-2.59	AVG
3	2390.000	56.58	3.88	60.46	74.00	-13.54	peak
4	2390.000	46.82	3.88	50.70	54.00	-3.30	AVG

Standard:	FCC Part 15C	Test Distance:	3m
Test item:	Radiated Emission	Power:	AC 120V/60Hz
Model Number:	A2-25DE	Temp.(°C)/Hum.(%RH):	26(°C)/60%RH
Mode:	2	Date:	08/23/2013
Frequency:	2412 MHz	Test By:	Fly Lu
Ant.Polar.:	Vertical		

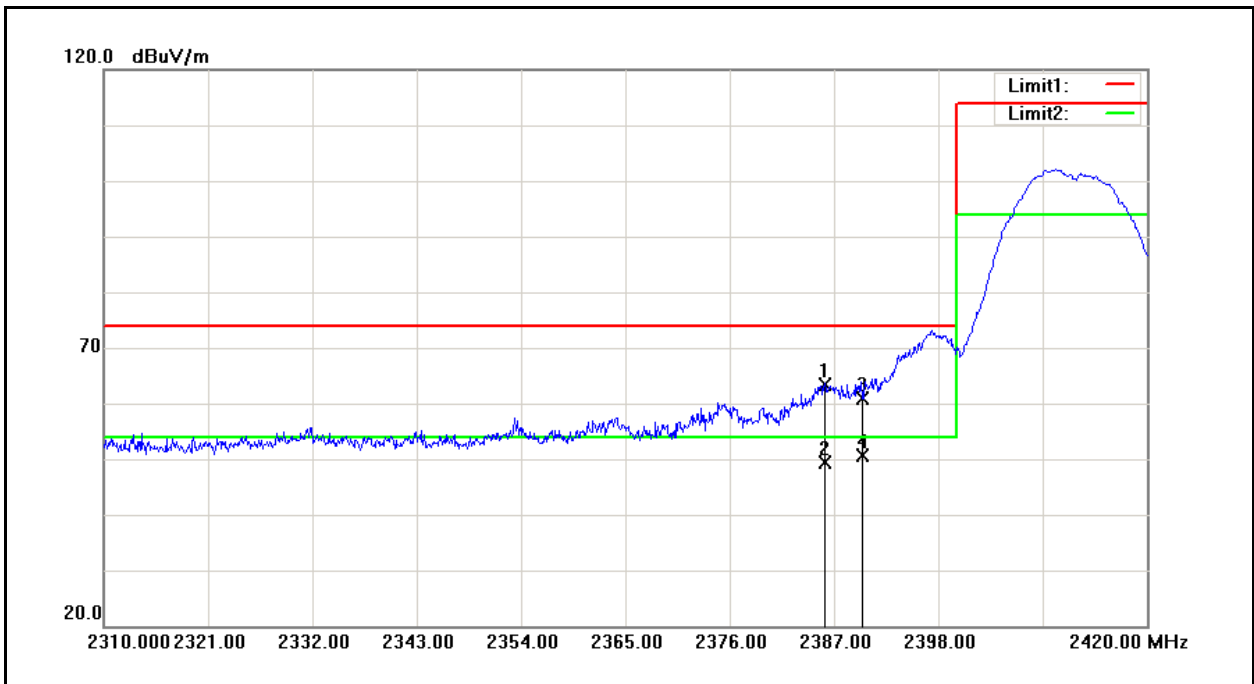

No.	Frequency (MHz)	Reading (dBuV)	Correct Factor (dB/m)	Result (dBuV/m)	Limit (dBuV/m)	Margin (dB)	Remark
1	2386.010	59.65	3.85	63.50	74.00	-10.50	peak
2	2386.010	45.59	3.85	49.44	54.00	-4.56	AVG
3	2390.000	57.02	3.88	60.90	74.00	-13.10	peak
4	2390.000	46.71	3.88	50.59	54.00	-3.41	AVG

Standard:	FCC Part 15C	Test Distance:	3m
Test item:	Radiated Emission	Power:	AC 120V/60Hz
Model Number:	A2-25DE	Temp.(°C)/Hum.(%RH):	26(°C)/60%RH
Mode:	2	Date:	08/23/2013
Frequency:	2462 MHz	Test By:	Fly Lu
Ant.Polar.:	Horizontal		

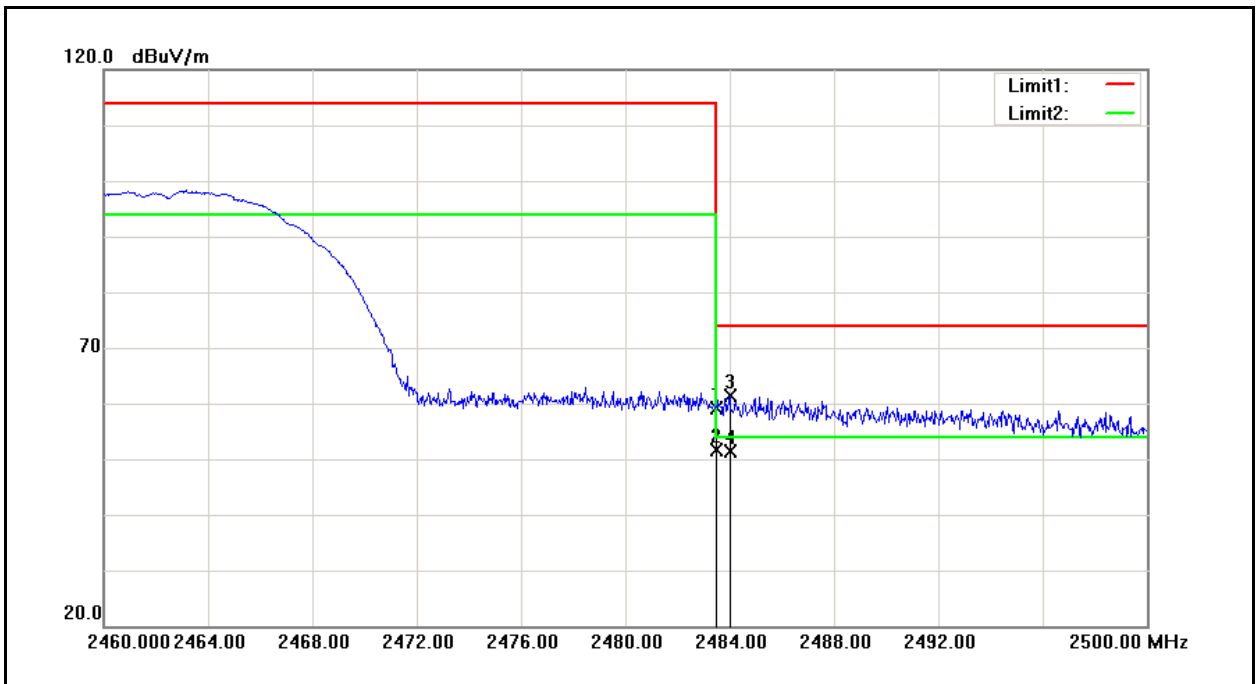

No.	Frequency (MHz)	Reading (dBuV)	Correct Factor (dB/m)	Result (dBuV/m)	Limit (dBuV/m)	Margin (dB)	Remark
1	2483.500	54.69	4.50	59.19	74.00	-14.81	peak
2	2483.500	47.10	4.50	51.60	54.00	-2.40	AVG
3	2484.000	56.90	4.51	61.41	74.00	-12.59	peak
4	2484.000	46.94	4.51	51.45	54.00	-2.55	AVG

Standard:	FCC Part 15C	Test Distance:	3m
Test item:	Radiated Emission	Power:	AC 120V/60Hz
Model Number:	A2-25DE	Temp.(°C)/Hum.(%RH):	26(°C)/60%RH
Mode:	2	Date:	08/23/2013
Frequency:	2462 MHz	Test By:	Fly Lu
Ant.Polar.:	Vertical		

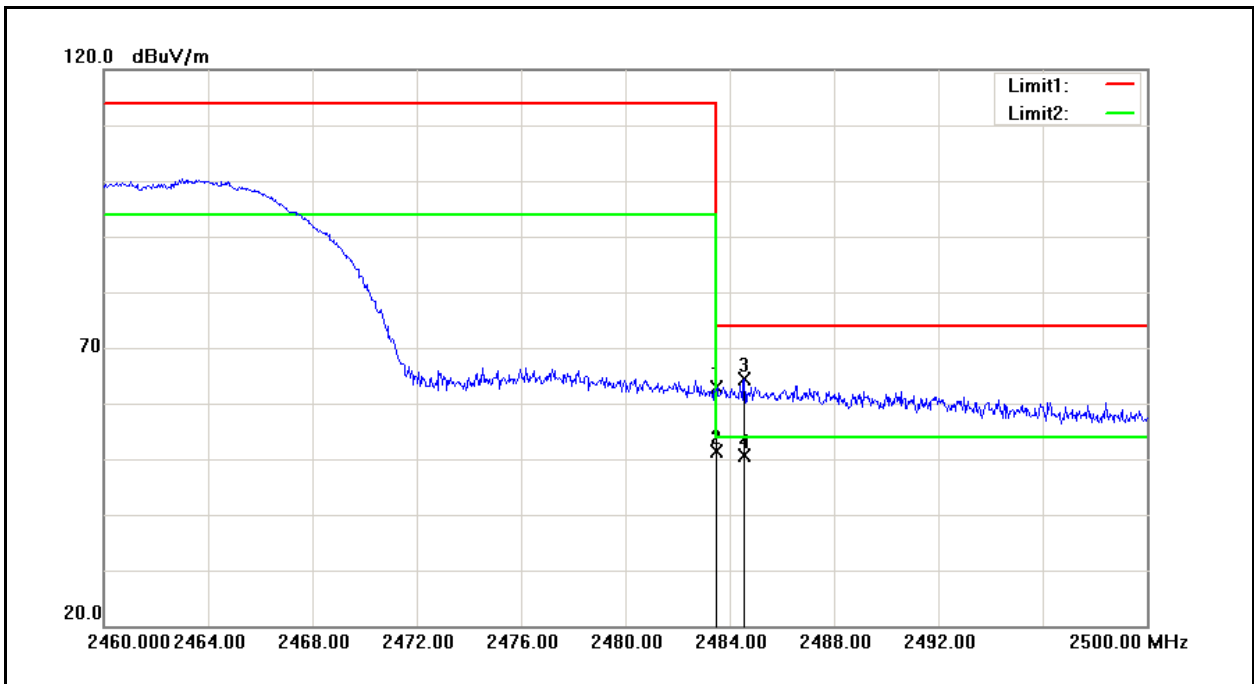

No.	Frequency (MHz)	Reading (dBuV)	Correct Factor (dB/m)	Result (dBuV/m)	Limit (dBuV/m)	Margin (dB)	Remark
1	2483.500	58.42	4.50	62.92	74.00	-11.08	peak
2	2483.500	46.94	4.50	51.44	54.00	-2.56	AVG
3	2484.560	59.83	4.51	64.34	74.00	-9.66	peak
4	2484.560	46.11	4.51	50.62	54.00	-3.38	AVG

Standard:	FCC Part 15C	Test Distance:	3m
Test item:	Radiated Emission	Power:	AC 120V/60Hz
Model Number:	A2-25DE	Temp.(°C)/Hum.(%RH):	26(°C)/60%RH
Mode:	3	Date:	08/23/2013
Frequency:	2412 MHz	Test By:	Fly Lu
Ant.Polar.:	Horizontal		

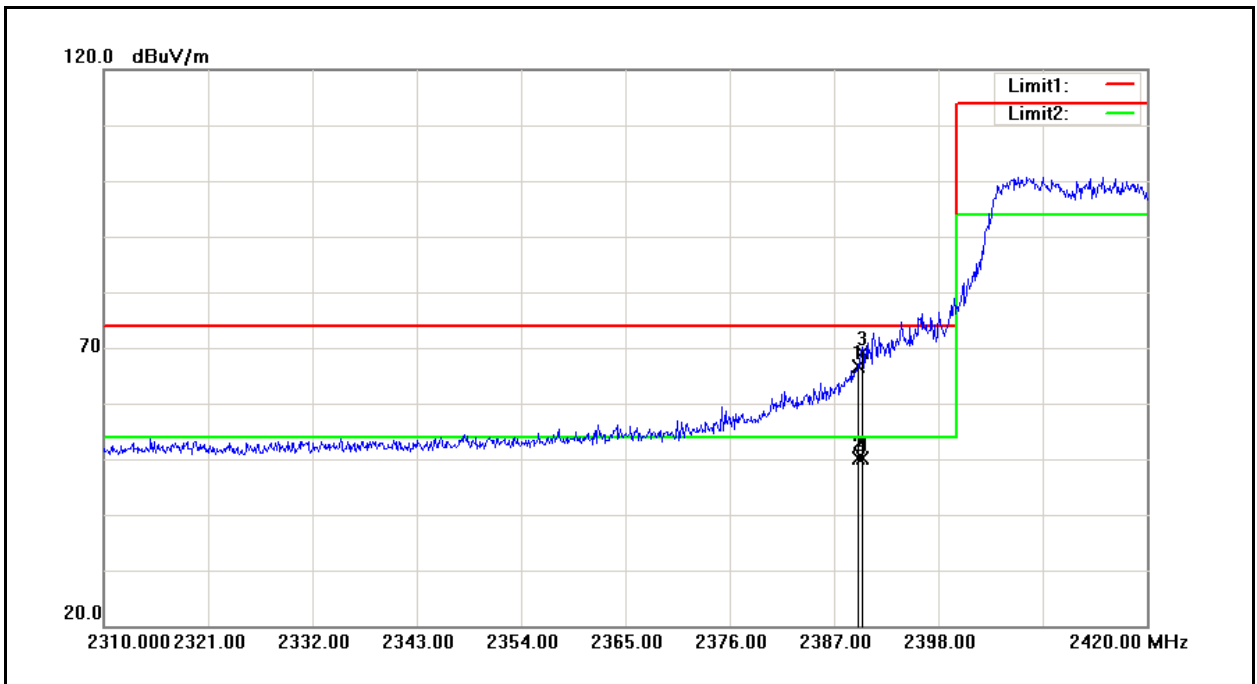

No.	Frequency (MHz)	Reading (dBuV)	Correct Factor (dB/m)	Result (dBuV/m)	Limit (dBuV/m)	Margin (dB)	Remark
1	2389.530	62.84	3.88	66.72	74.00	-7.28	peak
2	2389.530	46.18	3.88	50.06	54.00	-3.94	AVG
3	2390.000	65.35	3.88	69.23	74.00	-4.77	peak
4	2390.000	46.24	3.88	50.12	54.00	-3.88	AVG

Standard:	FCC Part 15C	Test Distance:	3m
Test item:	Radiated Emission	Power:	AC 120V/60Hz
Model Number:	A2-25DE	Temp.(°C)/Hum.(%RH):	26(°C)/60%RH
Mode:	3	Date:	08/23/2013
Frequency:	2412 MHz	Test By:	Fly Lu
Ant.Polar.:	Vertical		

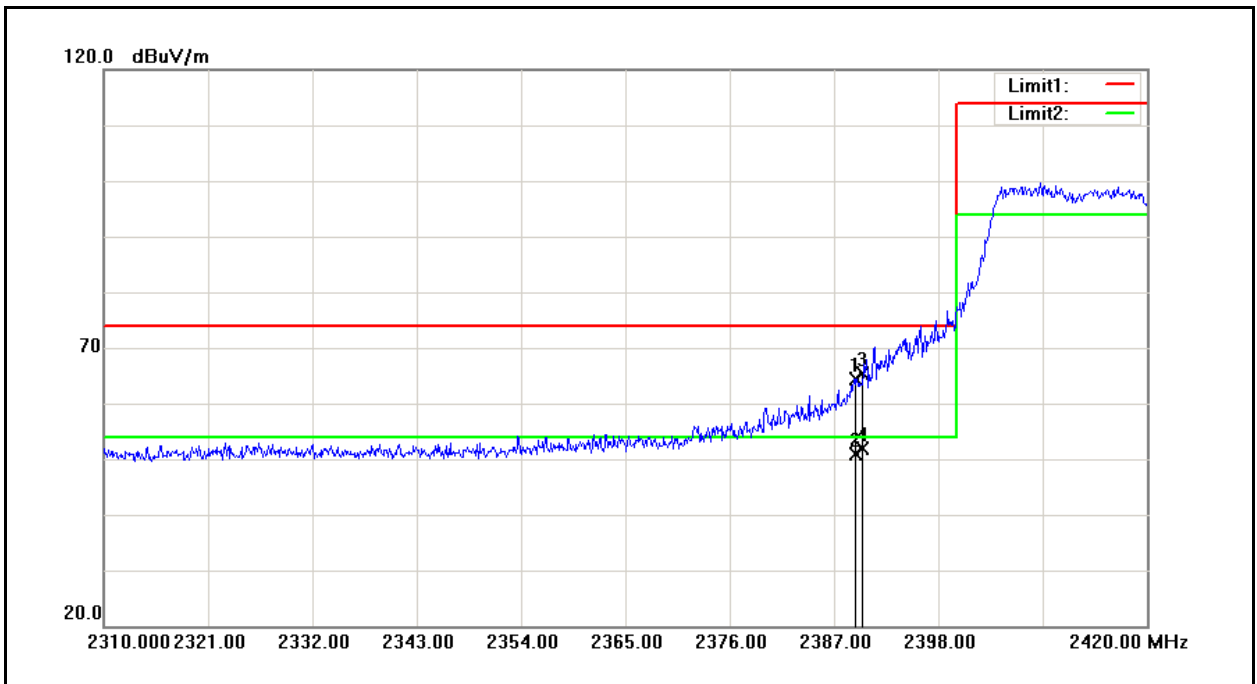

No.	Frequency (MHz)	Reading (dBuV)	Correct Factor (dB/m)	Result (dBuV/m)	Limit (dBuV/m)	Margin (dB)	Remark
1	2389.310	60.51	3.88	64.39	74.00	-9.61	peak
2	2389.310	47.00	3.88	50.88	54.00	-3.12	AVG
3	2390.000	61.39	3.88	65.27	74.00	-8.73	peak
4	2390.000	48.02	3.88	51.90	54.00	-2.10	AVG

Standard:	FCC Part 15C	Test Distance:	3m
Test item:	Radiated Emission	Power:	AC 120V/60Hz
Model Number:	A2-25DE	Temp.(°C)/Hum.(%RH):	26(°C)/60%RH
Mode:	3	Date:	08/23/2013
Frequency:	2462 MHz	Test By:	Fly Lu
Ant.Polar.:	Horizontal		

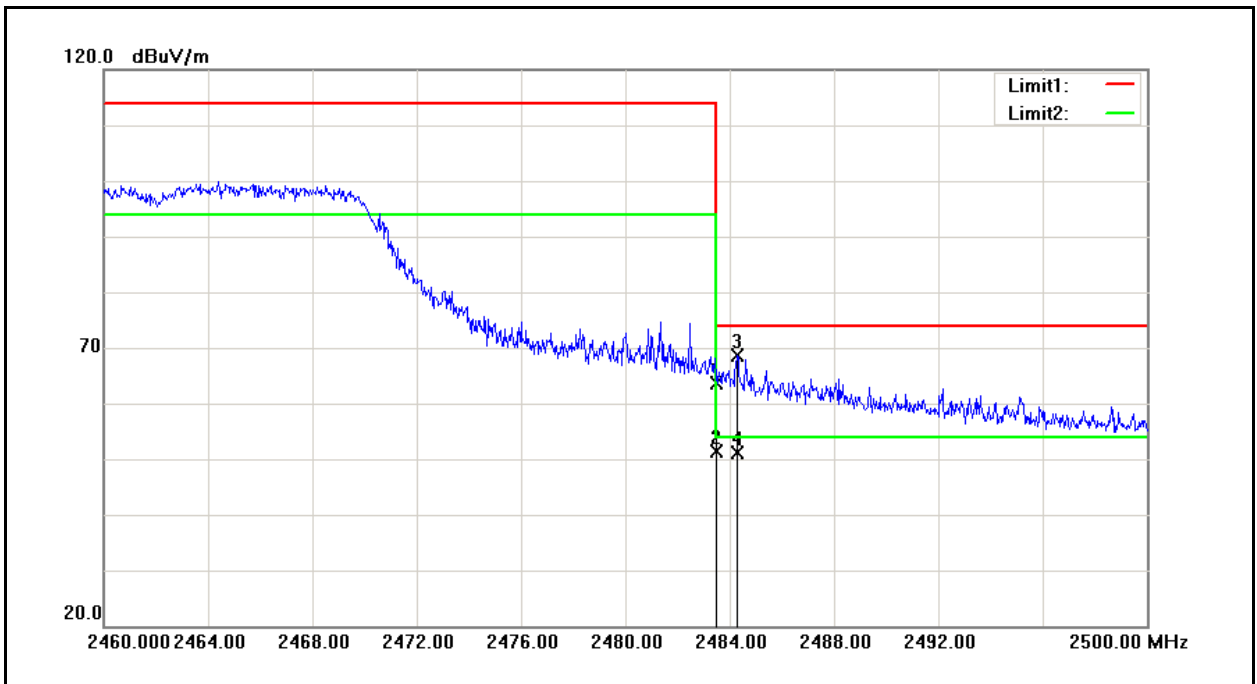

No.	Frequency (MHz)	Reading (dBuV)	Correct Factor (dB/m)	Result (dBuV/m)	Limit (dBuV/m)	Margin (dB)	Remark
1	2483.500	59.01	4.50	63.51	74.00	-10.49	peak
2	2483.500	46.86	4.50	51.36	54.00	-2.64	AVG
3	2484.280	64.11	4.51	68.62	74.00	-5.38	peak
4	2484.280	46.58	4.51	51.09	54.00	-2.91	AVG

Standard:	FCC Part 15C	Test Distance:	3m
Test item:	Radiated Emission	Power:	AC 120V/60Hz
Model Number:	A2-25DE	Temp.(°C)/Hum.(%RH):	26(°C)/60%RH
Mode:	3	Date:	08/23/2013
Frequency:	2462 MHz	Test By:	Fly Lu
Ant.Polar.:	Vertical		

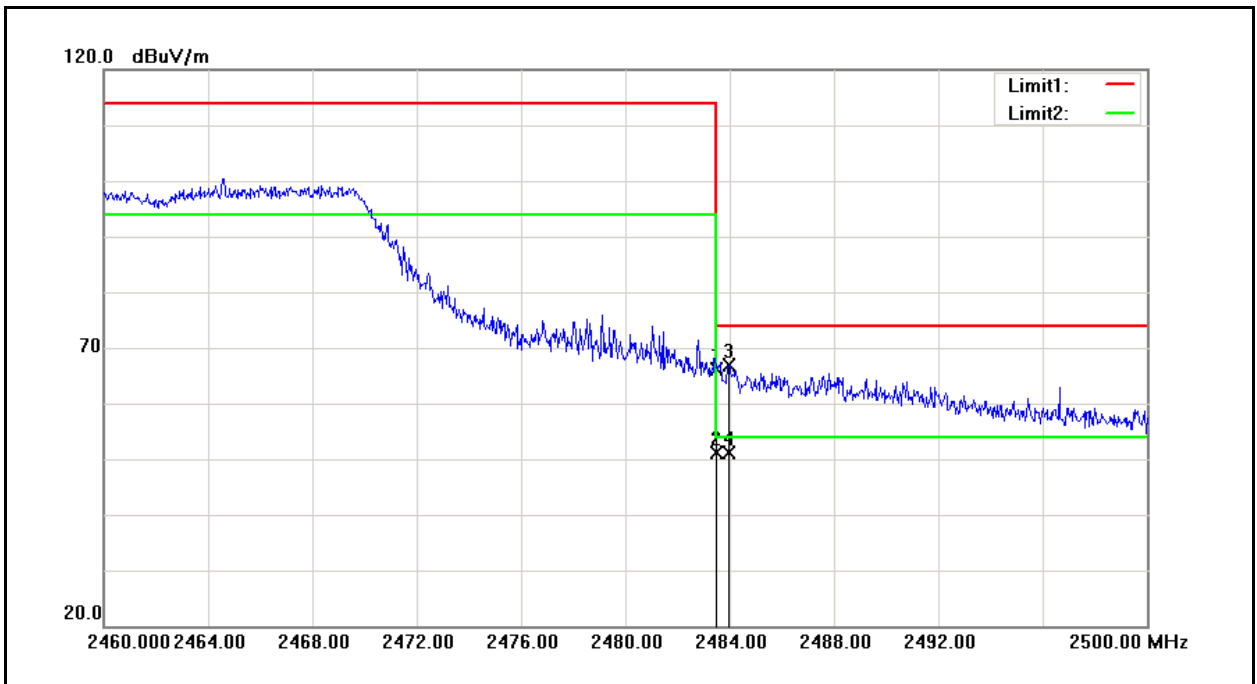

No.	Frequency (MHz)	Reading (dBuV)	Correct Factor (dB/m)	Result (dBuV/m)	Limit (dBuV/m)	Margin (dB)	Remark
1	2483.500	61.72	4.50	66.22	74.00	-7.78	peak
2	2483.500	46.63	4.50	51.13	54.00	-2.87	AVG
3	2483.960	62.43	4.51	66.94	74.00	-7.06	peak
4	2483.960	46.51	4.51	51.02	54.00	-2.98	AVG

Standard:	FCC Part 15C	Test Distance:	3m
Test item:	Radiated Emission	Power:	AC 120V/60Hz
Model Number:	A2-25DE	Temp.(°C)/Hum.(%RH):	26(°C)/60%RH
Mode:	4	Date:	08/23/2013
Frequency:	2412 MHz	Test By:	Fly Lu
Ant.Polar.:	Horizontal		

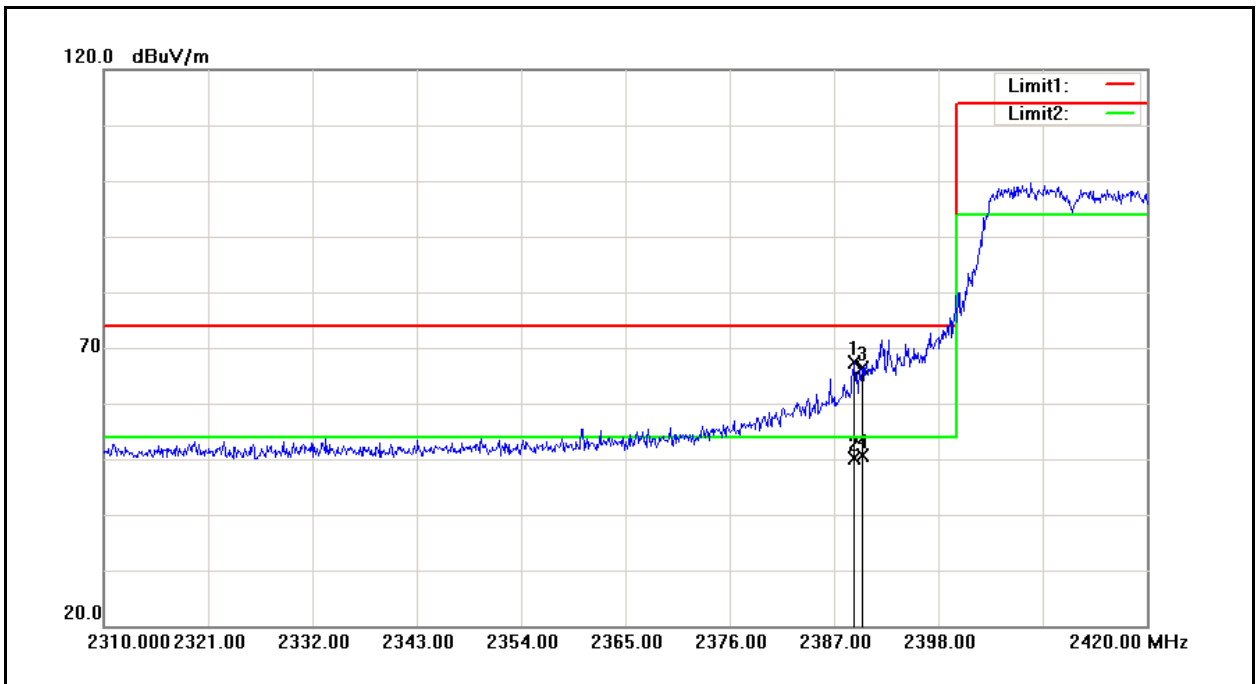

No.	Frequency (MHz)	Reading (dBuV)	Correct Factor (dB/m)	Result (dBuV/m)	Limit (dBuV/m)	Margin (dB)	Remark
1	2389.090	63.55	3.88	67.43	74.00	-6.57	peak
2	2389.090	46.28	3.88	50.16	54.00	-3.84	AVG
3	2390.000	62.41	3.88	66.29	74.00	-7.71	peak
4	2390.000	46.67	3.88	50.55	54.00	-3.45	AVG

Standard:	FCC Part 15C	Test Distance:	3m
Test item:	Radiated Emission	Power:	AC 120V/60Hz
Model Number:	A2-25DE	Temp.(°C)/Hum.(%RH):	26(°C)/60%RH
Mode:	4	Date:	08/23/2013
Frequency:	2412 MHz	Test By:	Fly Lu
Ant.Polar.:	Vertical		

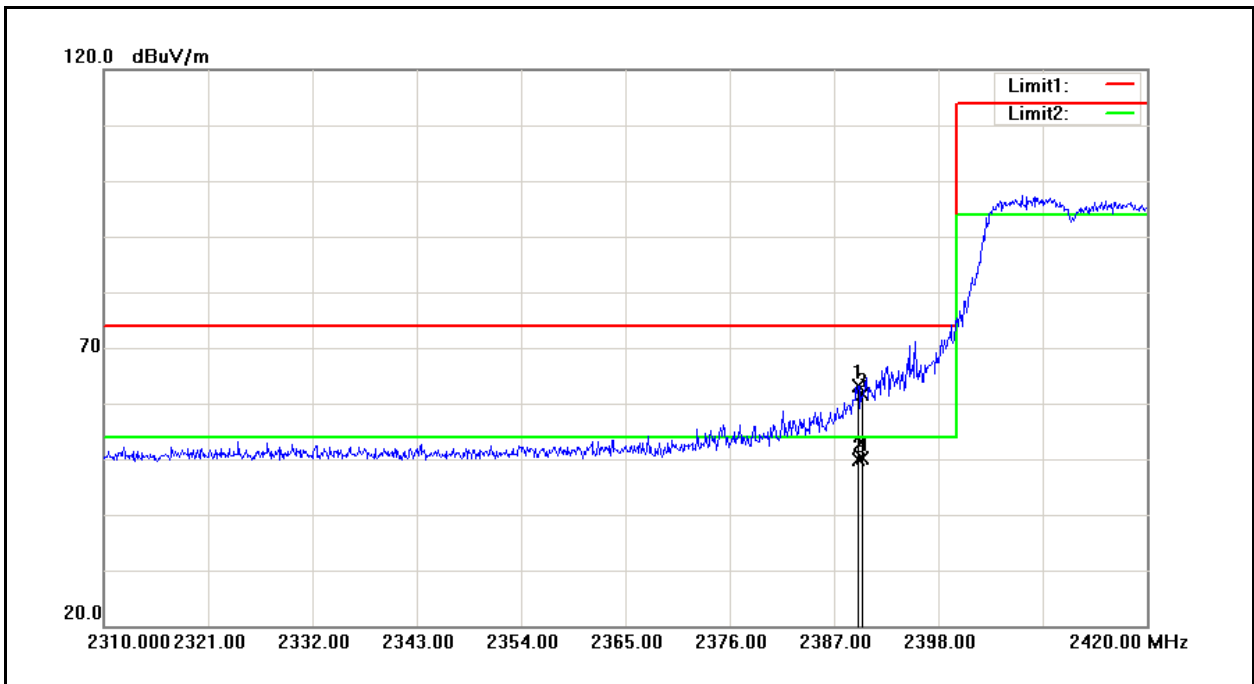

No.	Frequency (MHz)	Reading (dBuV)	Correct Factor (dB/m)	Result (dBuV/m)	Limit (dBuV/m)	Margin (dB)	Remark
1	2389.530	59.30	3.88	63.18	74.00	-10.82	peak
2	2389.530	45.88	3.88	49.76	54.00	-4.24	AVG
3	2390.000	57.76	3.88	61.64	74.00	-12.36	peak
4	2390.000	46.36	3.88	50.24	54.00	-3.76	AVG

Standard:	FCC Part 15C	Test Distance:	3m
Test item:	Radiated Emission	Power:	AC 120V/60Hz
Model Number:	A2-25DE	Temp.(°C)/Hum.(%RH):	26(°C)/60%RH
Mode:	4	Date:	08/23/2013
Frequency:	2462 MHz	Test By:	Fly Lu
Ant.Polar.:	Horizontal		

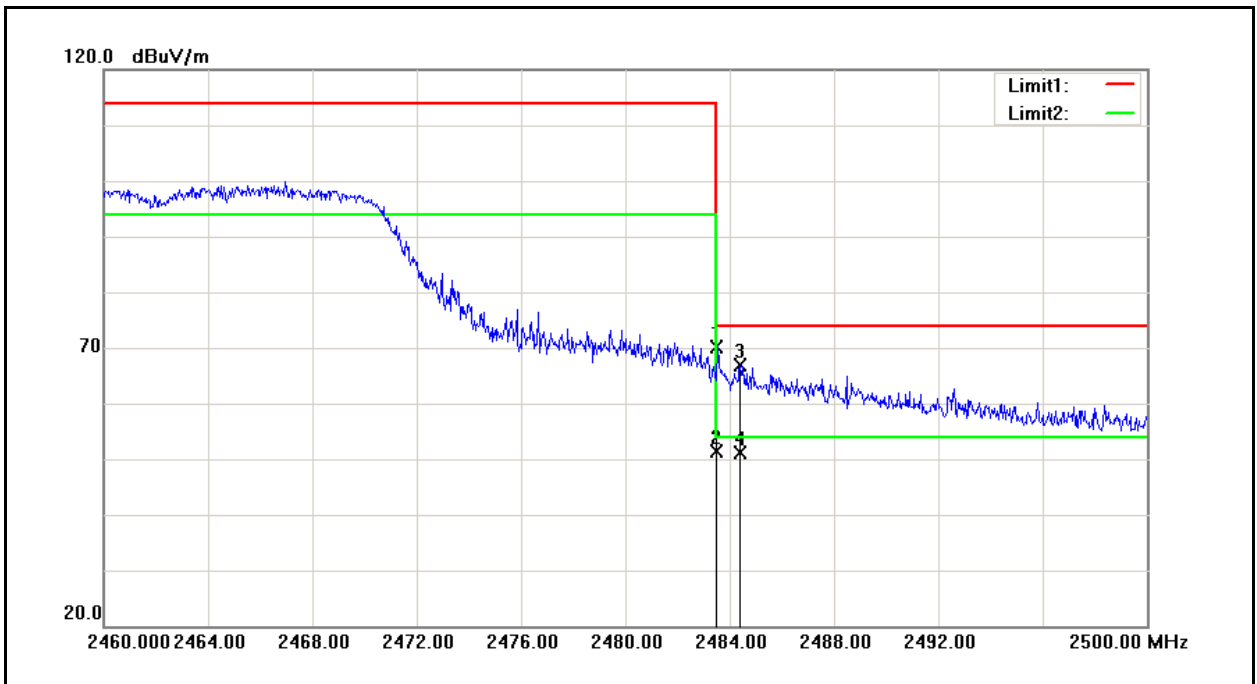

No.	Frequency (MHz)	Reading (dBuV)	Correct Factor (dB/m)	Result (dBuV/m)	Limit (dBuV/m)	Margin (dB)	Remark
1	2483.500	65.62	4.50	70.12	74.00	-3.88	peak
2	2483.500	46.93	4.50	51.43	54.00	-2.57	AVG
3	2484.400	62.47	4.51	66.98	74.00	-7.02	peak
4	2484.400	46.60	4.51	51.11	54.00	-2.89	AVG

Standard:	FCC Part 15C	Test Distance:	3m
Test item:	Radiated Emission	Power:	AC 120V/60Hz
Model Number:	A2-25DE	Temp.(°C)/Hum.(%RH):	26(°C)/60%RH
Mode:	4	Date:	08/23/2013
Frequency:	2462 MHz	Test By:	Fly Lu
Ant.Polar.:	Vertical		

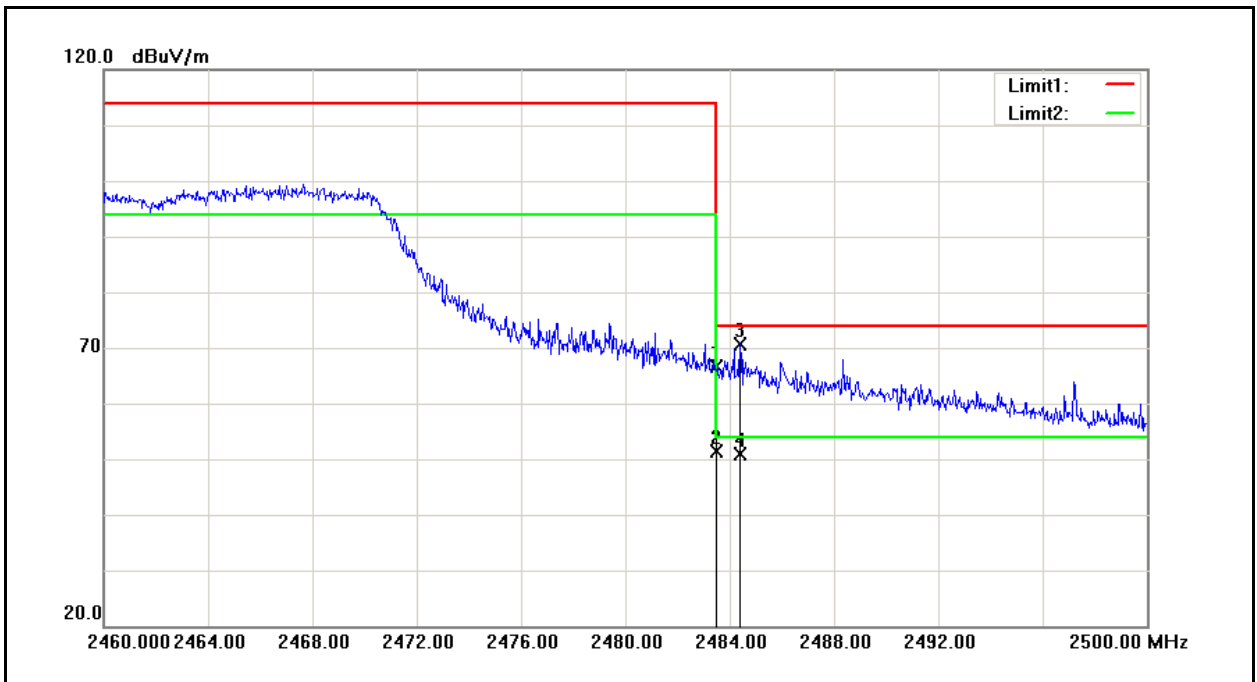

No.	Frequency (MHz)	Reading (dBuV)	Correct Factor (dB/m)	Result (dBuV/m)	Limit (dBuV/m)	Margin (dB)	Remark
1	2483.500	62.25	4.50	66.75	74.00	-7.25	peak
2	2483.500	46.79	4.50	51.29	54.00	-2.71	AVG
3	2484.400	66.24	4.51	70.75	74.00	-3.25	peak
4	2484.400	46.46	4.51	50.97	54.00	-3.03	AVG

Standard:	FCC Part 15C	Test Distance:	3m
Test item:	Radiated Emission	Power:	AC 120V/60Hz
Model Number:	A2-25DE	Temp.(°C)/Hum.(%RH):	26(°C)/60%RH
Mode:	5	Date:	08/23/2013
Frequency:	2422 MHz	Test By:	Fly Lu
Ant.Polar.:	Horizontal		

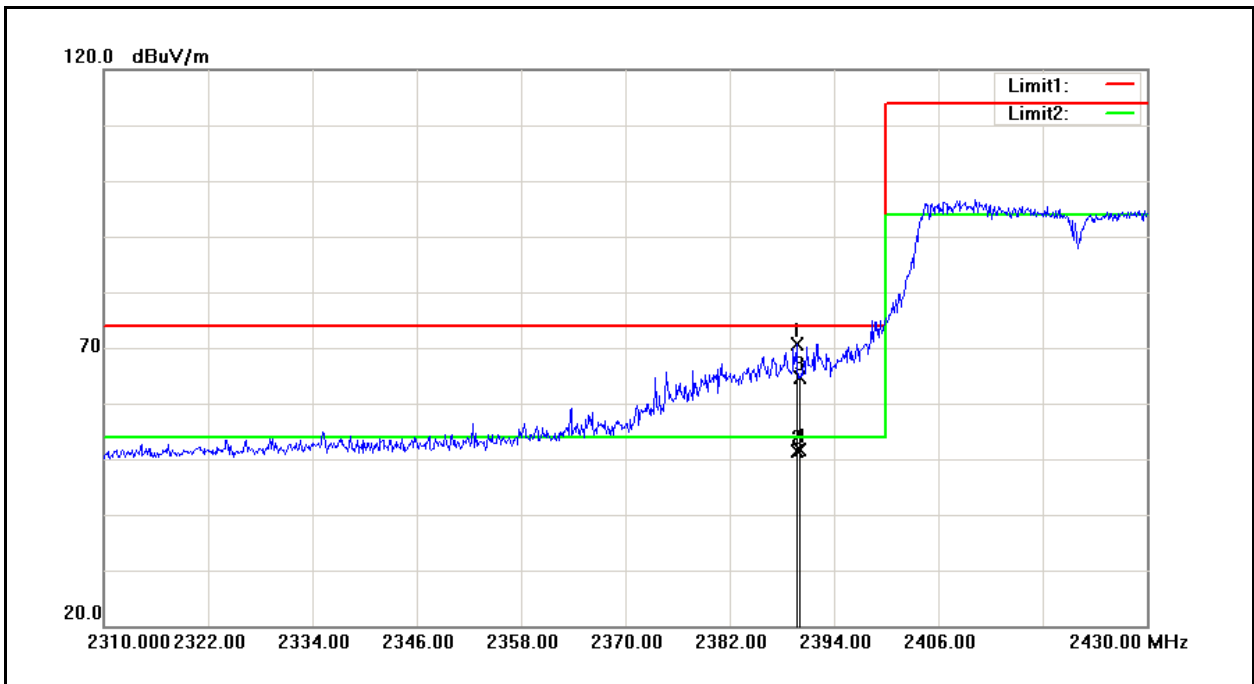

No.	Frequency (MHz)	Reading (dBuV)	Correct Factor (dB/m)	Result (dBuV/m)	Limit (dBuV/m)	Margin (dB)	Remark
1	2389.680	66.65	3.88	70.53	74.00	-3.47	peak
2	2389.680	47.59	3.88	51.47	54.00	-2.53	AVG
3	2390.000	60.70	3.88	64.58	74.00	-9.42	peak
4	2390.000	47.72	3.88	51.60	54.00	-2.40	AVG

Standard:	FCC Part 15C	Test Distance:	3m
Test item:	Radiated Emission	Power:	AC 120V/60Hz
Model Number:	A2-25DE	Temp.(°C)/Hum.(%RH):	26(°C)/60%RH
Mode:	5	Date:	08/23/2013
Frequency:	2422 MHz	Test By:	Fly Lu
Ant.Polar.:	Vertical		

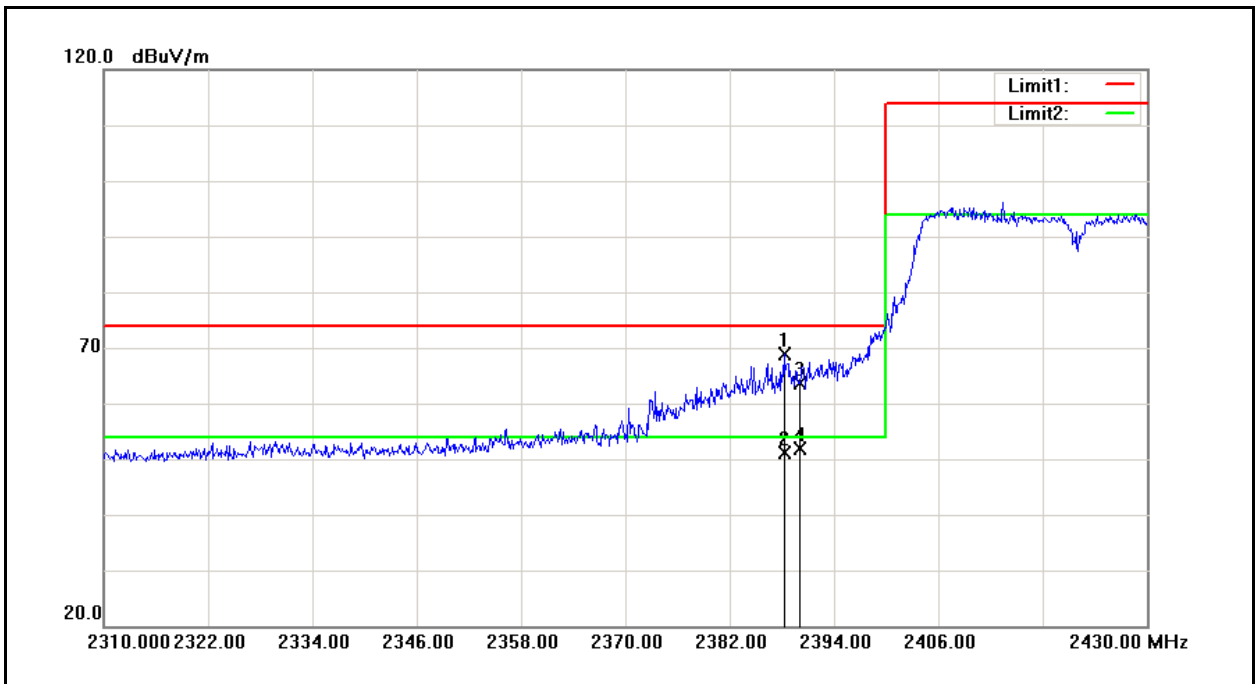

No.	Frequency (MHz)	Reading (dBuV)	Correct Factor (dB/m)	Result (dBuV/m)	Limit (dBuV/m)	Margin (dB)	Remark
1	2388.240	64.96	3.86	68.82	74.00	-5.18	peak
2	2388.240	47.37	3.86	51.23	54.00	-2.77	AVG
3	2390.000	59.68	3.88	63.56	74.00	-10.44	peak
4	2390.000	47.90	3.88	51.78	54.00	-2.22	AVG

Standard:	FCC Part 15C	Test Distance:	3m
Test item:	Radiated Emission	Power:	AC 120V/60Hz
Model Number:	A2-25DE	Temp.(°C)/Hum.(%RH):	26(°C)/60%RH
Mode:	5	Date:	08/23/2013
Frequency:	2452 MHz	Test By:	Fly Lu
Ant.Polar.:	Horizontal		

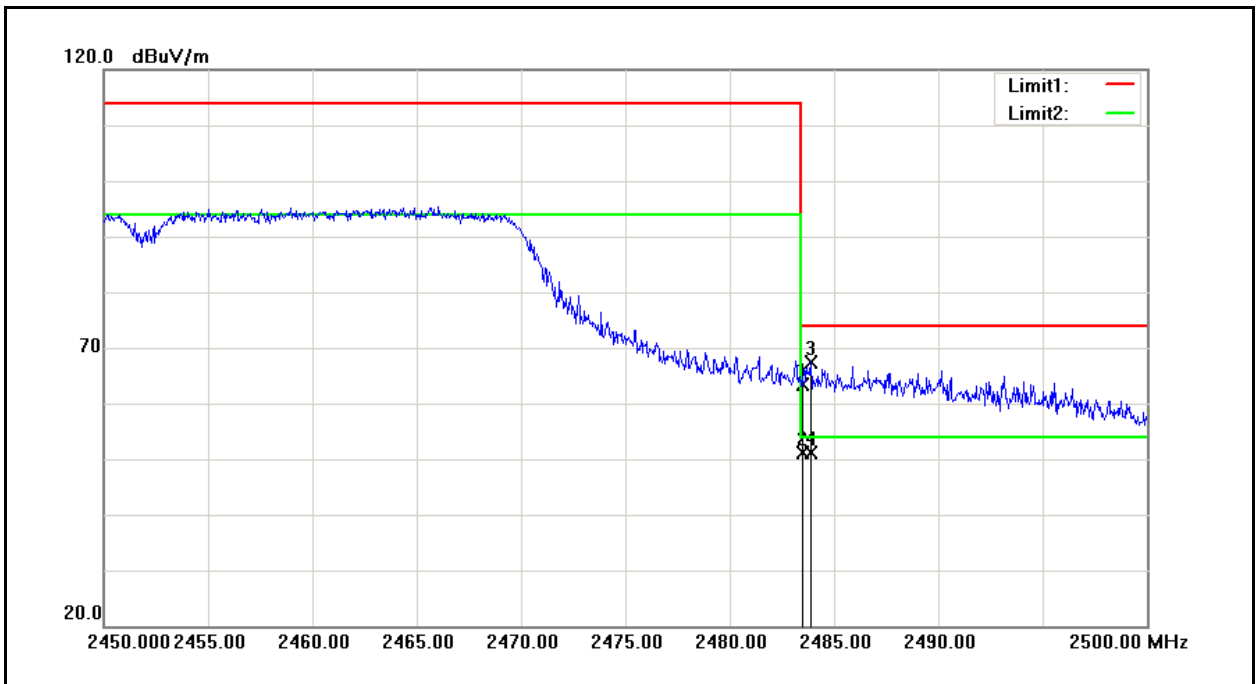

No.	Frequency (MHz)	Reading (dBuV)	Correct Factor (dB/m)	Result (dBuV/m)	Limit (dBuV/m)	Margin (dB)	Remark
1	2483.500	58.95	4.50	63.45	74.00	-10.55	peak
2	2483.500	46.70	4.50	51.20	54.00	-2.80	AVG
3	2483.900	62.78	4.51	67.29	74.00	-6.71	peak
4	2483.900	46.59	4.51	51.10	54.00	-2.90	AVG

Standard:	FCC Part 15C	Test Distance:	3m
Test item:	Radiated Emission	Power:	AC 120V/60Hz
Model Number:	A2-25DE	Temp.(°C)/Hum.(%RH):	26(°C)/60%RH
Mode:	5	Date:	08/23/2013
Frequency:	2452 MHz	Test By:	Fly Lu
Ant.Polar.:	Vertical		

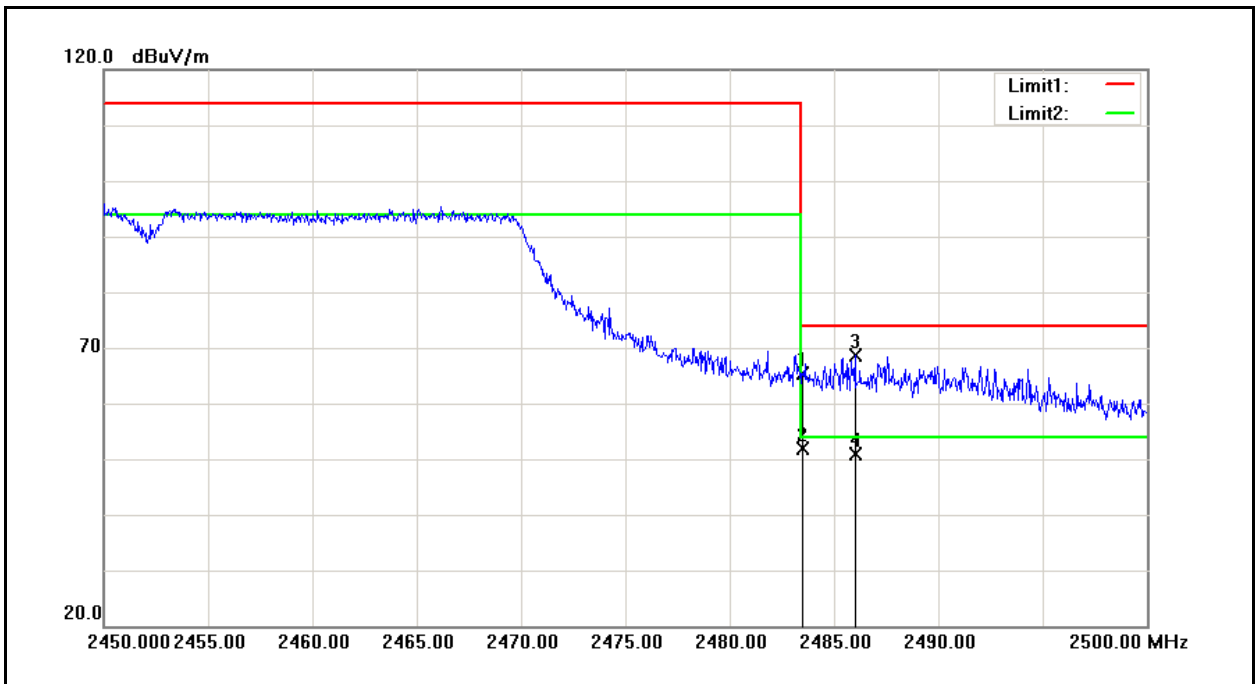

No.	Frequency (MHz)	Reading (dBuV)	Correct Factor (dB/m)	Result (dBuV/m)	Limit (dBuV/m)	Margin (dB)	Remark
1	2483.500	60.80	4.50	65.30	74.00	-8.70	peak
2	2483.500	47.32	4.50	51.82	54.00	-2.18	AVG
3	2486.000	64.04	4.52	68.56	74.00	-5.44	peak
4	2486.000	46.36	4.52	50.88	54.00	-3.12	AVG

11 Antenna Measurement

11.1.Limit

For intentional device, according to 15.203, an intentional radiator shall be designed to ensure that no antenna other than that furnished by the responsible party shall be used with the device.

And According to 15.247 (b), if transmitting antennas of directional gain greater than 6 dBi are used, the power shall be reduced by the amount in dB that the directional gain of the antenna exceeds 6dBi.

11.2.Antenna Connector Construction

The antenna used in this product is Print chip antenna. And the maximum Gain of this antenna is only 1.0 dBi.