

2496–2690 MHz BTS-MX
100-240 VAC
REGULATORY & ID Label
Non-RoHS BTS-MX
RoHS label

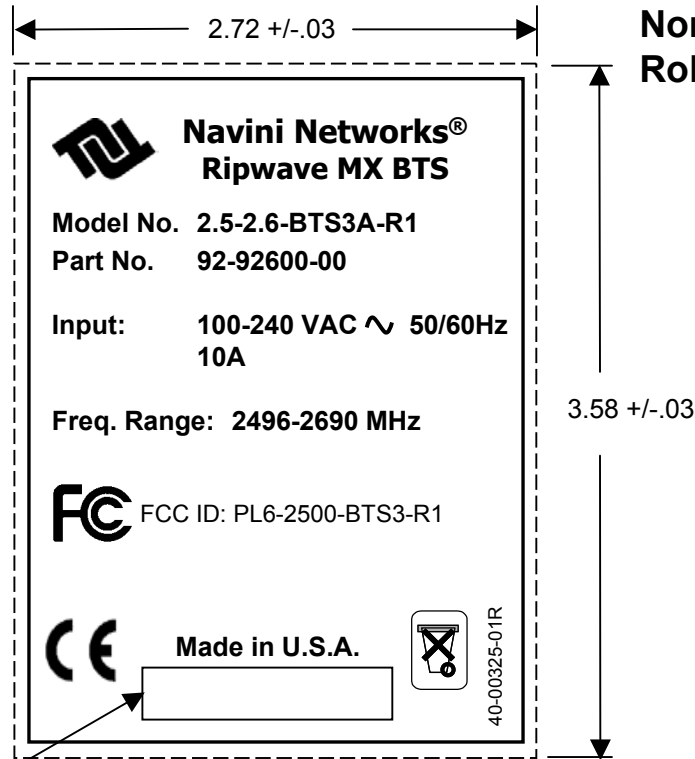

CLEAR WINDOW FOR NAVINI BAR CODE
(1.5000 X .375, SIZE OF LABEL)

Part No. 40-00325-01R

Description: **LABEL: Regulatory & I.D. for: BTS, RFS, FILTER (All Freq.)**
 Document Ref: **Original is 67-00333-00 Rev. B, May 10, 2006**

Proprietary Information: The information contained in this document is the property of Navini Networks. Except as specifically authorized in writing by Navini Networks, the holder of this document shall keep all information contained herein confidential and shall protect same in whole or in part from disclosure and dissemination to all third parties. © 2006 Navini Networks

2496–2690 MHz BTS-MX
100-240 VAC
REGULATORY & ID Label
RoHS BTS-MX
RoHS label

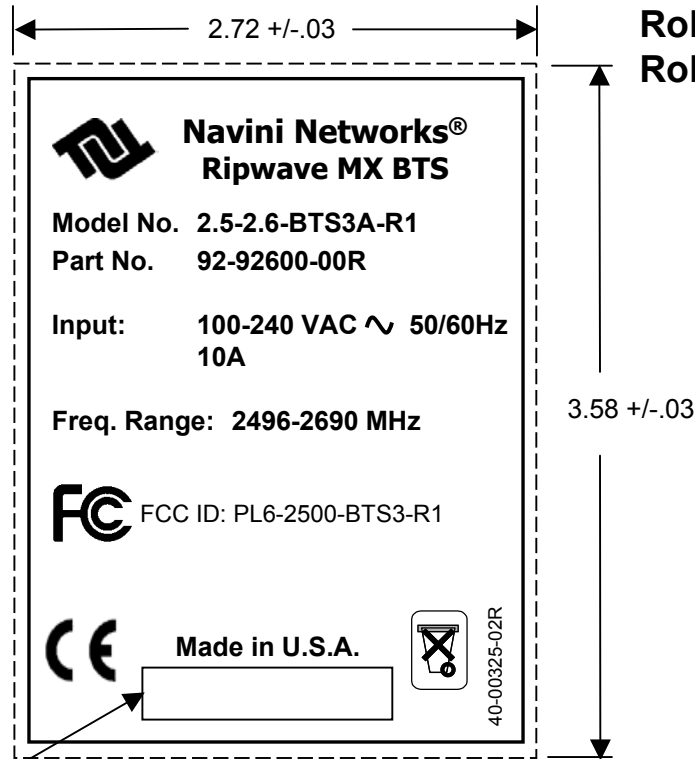

Part No. 40-00325-02R

Description: **LABEL: Regulatory & I.D. for: BTS, RFS, FILTER (All Freq.)**
 Document Ref: **Original is 67-00333-00 Rev. B, May 10, 2006**

Proprietary Information: The information contained in this document is the property of Navini Networks. Except as specifically authorized in writing by Navini Networks, the holder of this document shall keep all information contained herein confidential and shall protect same in whole or in part from disclosure and dissemination to all third parties. © 2006 Navini Networks

2496–2690 MHz BTS-MX
+ 24 VDC
REGULATORY & ID Label
Non-RoHS BTS-MX
RoHS label

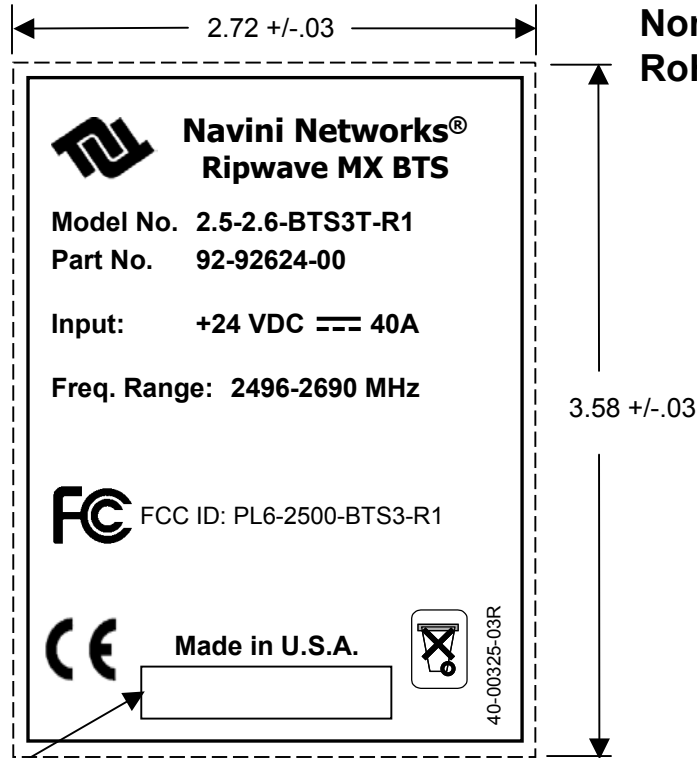

CLEAR WINDOW FOR NAVINI BAR CODE
 (1.5000 X .375, SIZE OF LABEL)

Part No. 40-00325-03R

Description: **LABEL: Regulatory & I.D. for: BTS, RFS, FILTER (All Freq.)**
 Document Ref: **Original is 67-00333-00 Rev. B, May 10, 2006**

Proprietary Information: The information contained in this document is the property of Navini Networks. Except as specifically authorized in writing by Navini Networks, the holder of this document shall keep all information contained herein confidential and shall protect same in whole or in part from disclosure and dissemination to all third parties. © 2006 Navini Networks

2496–2690 MHz BTS-MX
+ 24 VDC
REGULATORY & ID Label
RoHS BTS-MX
RoHS label

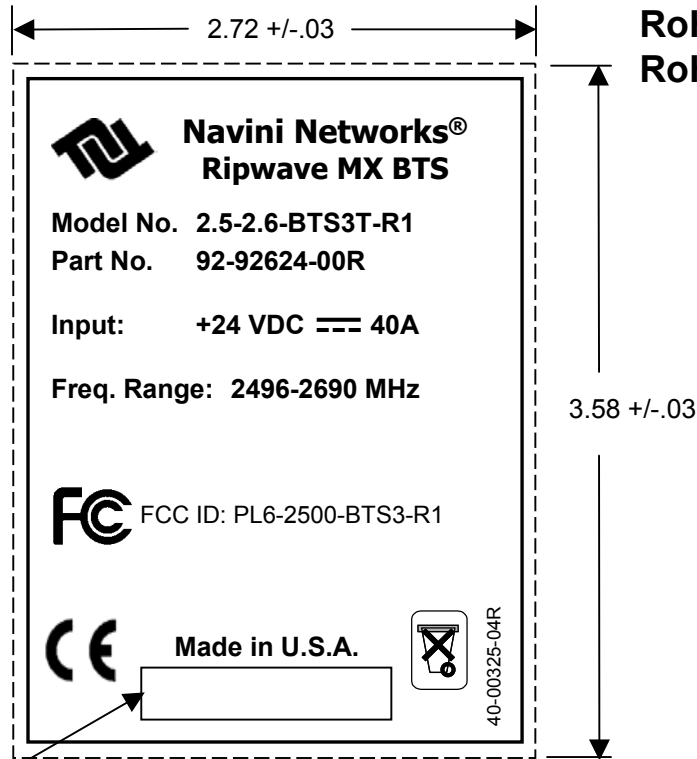

CLEAR WINDOW FOR NAVINI BAR CODE
 (1.5000 X .375, SIZE OF LABEL)

Part No. 40-00325-04R

Description: **LABEL: Regulatory & I.D. for: BTS, RFS, FILTER (All Freq.)**
 Document Ref: **Original is 67-00333-00 Rev. B, May 10, 2006**

Proprietary Information: The information contained in this document is the property of Navini Networks. Except as specifically authorized in writing by Navini Networks, the holder of this document shall keep all information contained herein confidential and shall protect same in whole or in part from disclosure and dissemination to all third parties. © 2006 Navini Networks

2496–2690 MHz BTS-MX
– 48 VDC
REGULATORY & ID Label
Non-RoHS BTS-MX
RoHS label

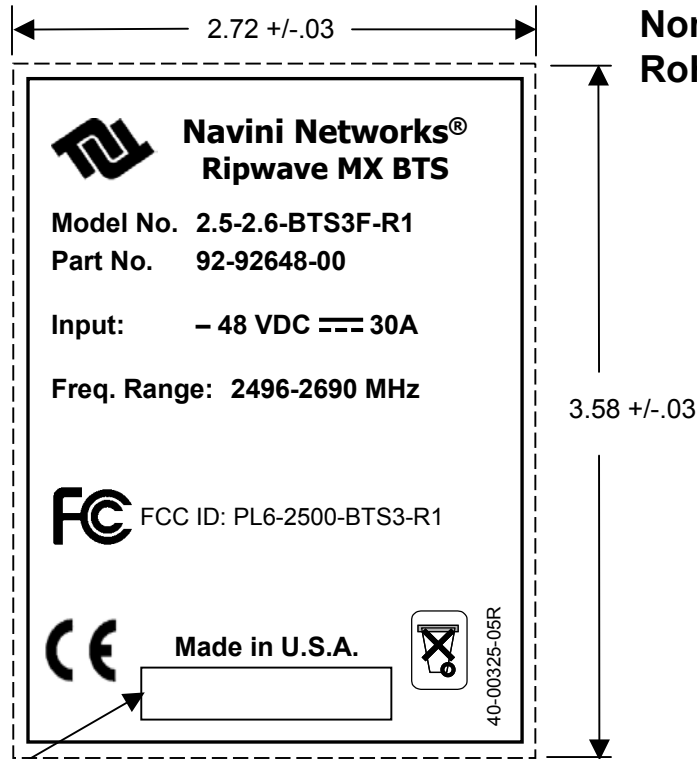

CLEAR WINDOW FOR NAVINI BAR CODE
 (1.5000 X .375, SIZE OF LABEL)

Part No. 40-00325-05R

Description: **LABEL: Regulatory & I.D. for: BTS, RFS, FILTER (All Freq.)**
 Document Ref: **Original is 67-00333-00 Rev. B, May 10, 2006**

Proprietary Information: The information contained in this document is the property of Navini Networks. Except as specifically authorized in writing by Navini Networks, the holder of this document shall keep all information contained herein confidential and shall protect same in whole or in part from disclosure and dissemination to all third parties. © 2006 Navini Networks

2496–2690 MHz BTS-MX
– 48 VDC
REGULATORY & ID Label
RoHS BTS-MX
RoHS label

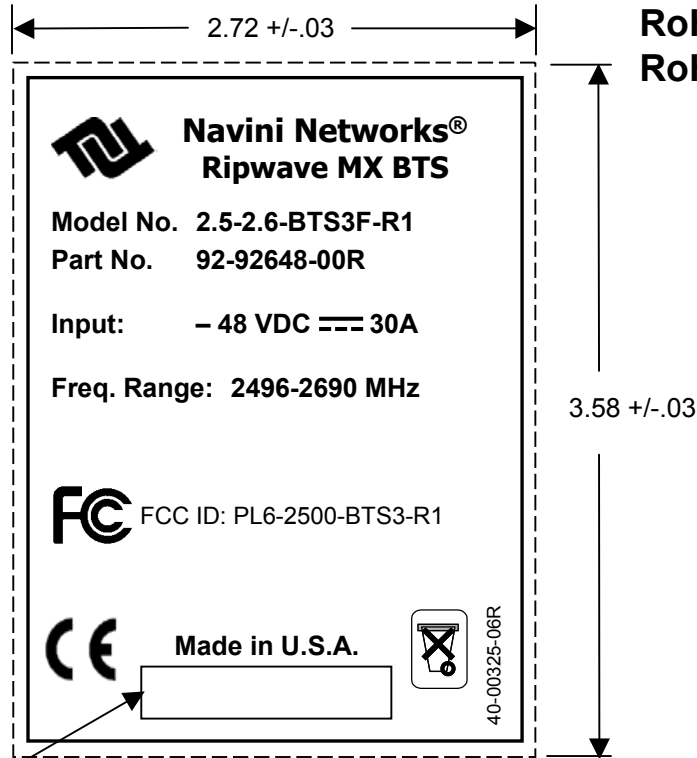

CLEAR WINDOW FOR NAVINI BAR CODE
 (1.5000 X .375, SIZE OF LABEL)

Part No. 40-00325-06R

Description: **LABEL: Regulatory & I.D. for: BTS, RFS, FILTER (All Freq.)**
 Document Ref: **Original is 67-00333-00 Rev. B, May 10, 2006**

Proprietary Information: The information contained in this document is the property of Navini Networks. Except as specifically authorized in writing by Navini Networks, the holder of this document shall keep all information contained herein confidential and shall protect same in whole or in part from disclosure and dissemination to all third parties. © 2006 Navini Networks

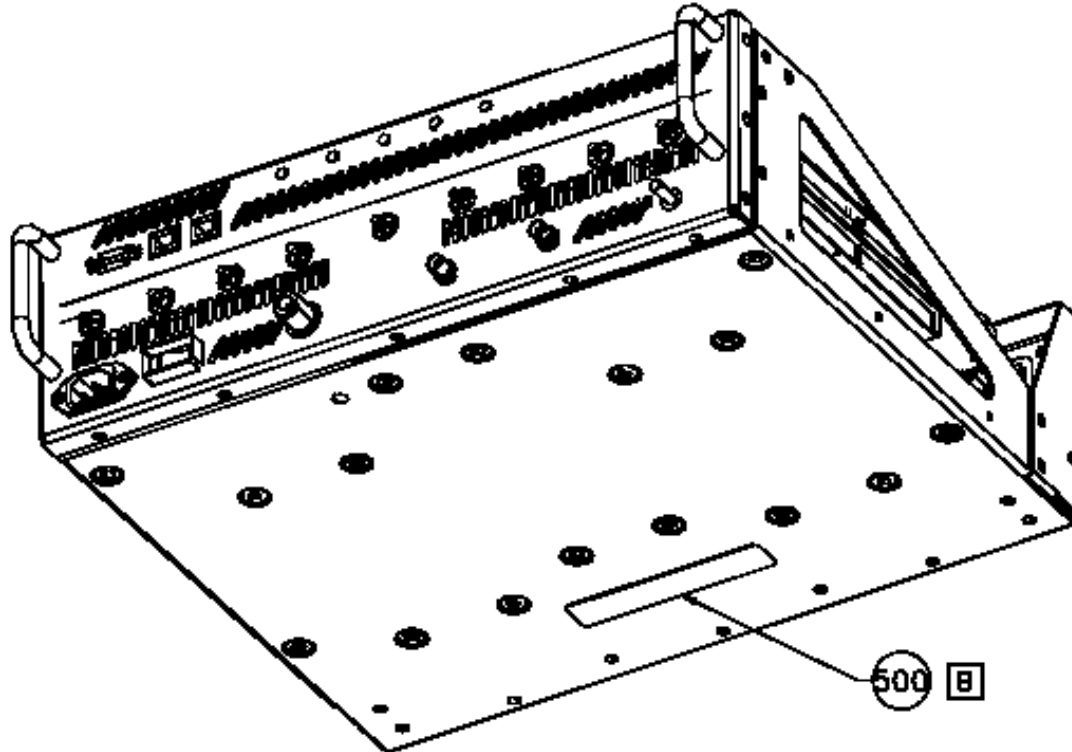

Description: **LABEL: Regulatory & I.D. for: BTS, RFS, FILTER (All Freq.)**
Document Ref: **Original is 67-00333-00 Rev. B, May 10, 2006**