

MEASUREMENT REPORT

of

2.4 GHz Wireless device

Applicant : The Linksys Group Inc.
Model No. : NWR04B
EUT : Network Everywhere Wireless Cable/DSL Router
FCC ID : PKW- NWR04B
Report No. : R0315529

Tested by :

Training Research Co., Ltd.

TEL : 886-2-26461146

FAX : 886-2-26461778

No. 15, Lane 530, Pa-Lian RD., Sec. 1, Hsichih City, Taipei Hsien, Taiwan, R.O.C.

CERTIFICATION

We here by verify that:

The test data, data evaluation, test procedures and equipment configurations shown in this report were made mainly in accordance with the procedures given in ANSI C63.4 (1992) as a reference. All test were conducted by *Training Research Co., Ltd.*, 255 Nanyang Street, Shijr, Taipei Hsien 221, Taiwan, R.O.C. Also, we attest to the accuracy of each.

We further submit that the energy emitted by the sample EUT tested as described in the report is in compliance with the technical requirements set forth in the FCC Rules Part 15 Subpart C Section 15.247.

Applicant : The Linksys Group Inc.
Applicant address : 17401 Armstrong Ave., Irvine CA 92614, U.S.A..
EUT : Network Everywhere Wireless Cable/DSL Router
Model No. : NWR04B
FCC ID : PKW- NWR04B
Report No. : R0315529
Test Date : December 12, 2002

Prepared by:



Eric Lee

Approved by:



Jacob Lin

Tested by :

Training Research Co., Ltd.

TEL: 886-2-26461146

FAX: 886-2-26461778

No. 15, Lane 530, Pa-Lian RD., Sec. 1, Hsichih City, Taipei Hsien, Taiwan, R.O.C.

Report No.: R0315529

Training Research Co., Ltd., TEL: 886-2-26461146, Fax: 886-2-26461778

Tables of Contents

I. GENERAL	5
1.1 Introduction	5
1.2 Description of EUT	5
1.3 Description of Support Equipment	6
1.4 Configuration of System Under Test	9
1.5 Verify the Frequency and Channel	13
1.6 Test Procedure	14
1.7 Location of the Test Site	14
1.8 General Test Condition	14
II. Section 15.101(a) : Equipment Authorization of Unintentional Radiators	15
III. Section 15.203 : Antenna Requirement	16
IV. Section 15.207 : Power Line Conducted Emissions for AC Powered Units	17
4.1 Test Condition & Setup	17
4.2 List of Test Instruments	17
4.3 Test Configuration	18
4.4 Test Result of Conducted Emissions	19
V. Section 15.247(a) : Technical Description of the EUT	20
VI. Section 15.247(a)(2) : Bandwidth for Direct Sequence System	21
6.1 Test Condition & Setup	21
6.2 Test Instruments Configuration	21
6.3 List of Test Instruments	21
6.4 Test Result of Bandwidth	22
VII. Section 15.247(b) : Power Output	26
7.1 Test Condition & Setup	26
7.2 List of Test Instruments	27
7.3 Test Result	27

VIII. Section 15.247(c) : Spurious Emissions (Radiated) 28

- 8.1 Test Condition & Setup 28
- 8.2 List of Test Instruments 29
- 8.3 Test Instruments Configuration 30
- 8.4 Test Result of Spurious Radiated Emissions 32
- 8.5 Test Result of Bandedge..... 35

IX. Section 15.247(d) : Power Spectral Density 38

- 9.1 Test Condition & Setup 38
- 9.2 Test Instruments Configuration 38
- 9.3 List of Test Instruments 38
- 9.4 Test Result of Power Spectral Density 39

Appendix A: Set Up Procedure 45

Appendix B: Antenna Specification 46

. GENERAL

1.1 Introduction

The following measurement report is submitted on behalf of applicant in support that the *cable gateway* certification in accordance with Part 2 Subpart J and Part 15 Subpart A/B/C of the Commission's Rules and Regulations.

1.2 Description of EUT

EUT : Network Everywhere Wireless Cable/DSL Router
Model No. : NWR04B
Granted FCC ID : PKW- NWR04B
Frequency Range : 2.412 GHz ~ 2.462GHz
Support Channel : 11 Channels
Modulation Skill : BPSK, QPSK, CCK
Power Type : By the Power adaptor
M/N: AW10-05-U
I/P: 100-240Vac, 50-60Hz, MAX 0.5A
O/P: +5Vdc, 2.0A
Power Cable : 150cm long, non-shielded.

1.3 Description of Support Equipment

In order to construct the minimum testing, following equipment were used as the support units.

PC : **HP Brio 85xx 6/350**
Model No. : D6928A
Serial No. : SG91801432
FCC ID : Doc Approved
Power type : 100 ~ 230VAC / 50 ~ 60Hz, 5A, Switching
Power cord : Non-shielded, 2.33m long, Plastic, No ferrite core

Monitor : **HP 15' Color Monitor**
Model No. : D2827A
Serial No. : KR91161719
FCC ID : C5F7NFCMC1518X
Power type : 110 ~ 240 VAC / 50 ~ 60 Hz, Switching
Power cord : Shielded, 1.83m long, No ferrite core
Data cable : Shielded, 1.46m long, with two ferrite cores

Keyboard : **HP**
Model No. : SK-2501K
Serial No. : MR80700789
FCC ID : GYUR38SK
Power type : By PC
Data cable : Shielded, 1.73m long, with ferrite core

Mouse : **HP**
Model No. : M-S34
Serial No. : LZB90714106
FCC ID : DZL211029
Power type : By PC
Power cord : Non-shielded, 1.88m long, No ferrite core

Wireless PC Card: **LINKSYS**
Model No. : WPC11 ver.3
FCC ID : PKW-WPC11-V3
Canada Code : 3839A12075

Printer : **HP**
Model No. : C2642A
Serial No. : SG69A196GV
FCC ID :B94C2642X
Power type : 220 VAC, 50Hz
Power cord : Non-shielded, 2m long, no ferrite core
Data cable : Shielded, 1.84m (1.7m) long, no ferrite core

USB Joystick : **Rockfire**
Model No. : QF-337uv
Serial No. : 10600545
FCC ID : CE Approval
Power type : Powered by PC
Power cable : Shielded, 1.8m long, No ferrite bead data cable

USB Mouse : **Logitech Wheel Mouse**
Model No. : M-BJ-58
Serial No. : LN20901985
FCC ID : Doc Approved
Power type : By PC
Power cord : Non-shielded, 1.88m long, No ferrite core

PC : **HP Vectra VE**
Model No. : D6970A
Serial No. : SG53000707
FCC ID :Doc Approved
Power type : 100 ~ 230VAC / 50 ~ 60Hz, 5A, Switching
Power cord : Non-shielded, 2.30m long, Plastic, No ferrite core

LAN Card : **D-Link**
Model No. : DFE-530TX
Serial No. : 0050BAE32FF3, 0050BAE3158B
FCC ID : N/A, DoC Approved

Notebook PC : **ASUSTek Computer**
Model No. : AB00F
Serial No. : 24NP016361
FCC ID : DoC Approved
BSMI : 41016012
Power type : 100 ~ 240VAC, 1A 50/60 Hz, Switching

**Adaptor of
Notebook** : **LITE-ON Electronics, Inc.**
Model No. : PA-1530-01
Serial No. : 00151184
FCC ID : Doc Approved
Power cable : Non-shielded, 1.72m length, Plastic hood, No ferrite core
(Between power adaptor and AC power source)
Power cable : Shielded, 1.48m length, Plastic hood, with ferrite core
(Between power adaptor and notebook)

1.4 Configuration of System Under Test

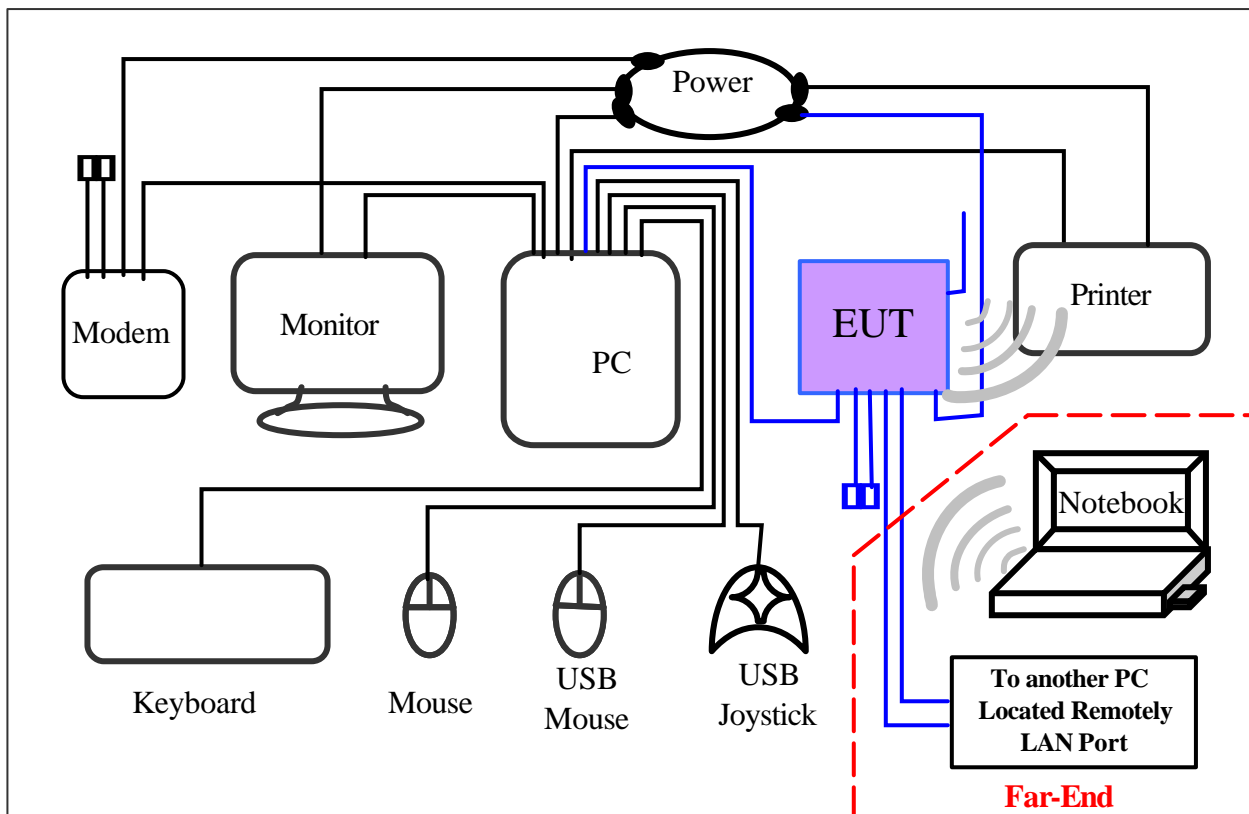

(Conduction and Radiation for unintentional test)

The setting up procedure was in Appendix A.

Connections of PC:

- *Serial Port --- via a 110cm shielded RS-232 cable to modem.
- *Monitor Port --- a monitor with 1.5m length data cable.
- *Keyboard port --- a keyboard with 1.50m length data cable.
- *Mouse port --- a mouse with 1.50m length data cable.
- *USB port A --- a mouse with 1.88m long, shielded and no ferrite bead data cable.
- *USB port B --- a joystick with 1.80m long, shielded and no ferrite bead data cable.
- *Printer port --- a printer with 1.80m length data cable.

(Each port on notebook is connected with suitable device)

Connections of EUT:

Network Everywhere Wireless Cable/DSL Router:

- *Internet port --- via a 1.5m long, non-shielded, no ferrite core, RJ45 cable to the LAN port of PC.
- *UTP port 1, 4 --- via a 5.0m long, non-shielded, no ferrite core, RJ45 cable to the LAN port of PC Located Remotely .
- *UTP port 2, 3 --- via a 1.5m long, non-shielded, no ferrite core, RJ45 cable that terminated with 100ohm.
- *Power jack --- with a power adaptor.

Power adaptor:

- M/N: AW10-05-U
- I/P: 100-240Vac, 50-60Hz, MAX 0.5A
- O/P: +5Vdc, 2.0A
- *Power cable of adaptor x 1 --- 150cm long, non-shielded

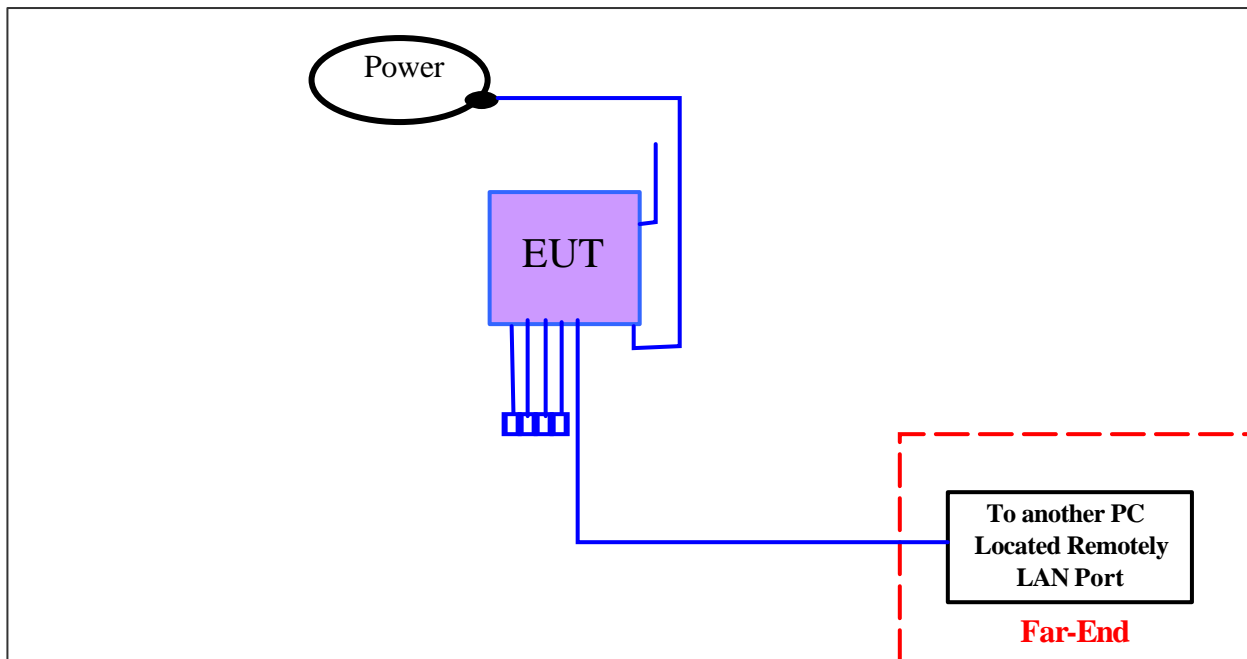

(Conduction & Radiation of intentional test)

The setting up procedure was recorded in Appendix A.

Connections of EUT:

Network Everywhere Wireless Cable/DSL Router:

- *UTP port 1~ 3, internet port --- via a 1.5m long, non-shielded, no ferrite core, RJ45 cable that terminated with 100ohm.
- *UTP port 4 --- via a 5.0m long, non-shielded, no ferrite core, RJ45 cable to the LAN port of Notebook Located Remotely .
- *Power jack --- with a power adaptor.

Power adaptor:

M/N: AW10-05-U

I/P: 100-240Vac, 50-60Hz, MAX 0.5A

O/P: +5Vdc, 2.0A

*Power cable of adaptor x 1 --- 150cm long, non-shielded

1.5 Verify the Frequency and Channel

Channel	Frequency (GHz)
1	2.412
2	2.417
3	2.422
4	2.427
5	2.432
6	2.437
7	2.442
8	2.447
9	2.452
10	2.457
11	2.462

Note:

1. This is for confirming that all frequencies are in 2.412GHz to 2.462GHz.
2. Section 15.31(m): Measurements on intentional radiators or receivers shall be performed at three frequencies for operating frequency range over 10 MHz.
(The locations of these frequencies one near the top, one near the middle and one near the bottom.)
3. After test, the EUT operating frequencies are in 2.412GHz to 2.462GHz. So all the items as followed in testing report are need to test these three frequencies:
Top: Channel – 1; Middle: Channel – 6; Bottom: Channel – 11.

1.6 Test Procedure

All measurements contained in this report were performed mainly according to the techniques described in ANSI C63.4 (1992) and the pre-setup was written on Appendix A, the detail setup was written on each test item.

1.7 Location of the Test Site

The radiated emissions measurements (above 1GHz) required by the rules were performed on the **three-meter, Anechoic Chamber (Registration Number: 93906)** maintained by *Training Research Co., Ltd.* 1F, No. 255 Nanyang Street, Shijr, Taipei Hsien 221, Taiwan, R.O.C. Complete description and measurement data have been placed on file with the commission. The conducted power line emissions tests and radiated emissions measurements below 1 GHz were performed in an OATS located at Pa-Lian His-chih Training Research Co., Ltd.

No. 15, Lane 530, Pa-Lian RD., Sec. 1, Hsichih City, Taipei Hsien, Taiwan, R.O.C. (Registration No.: 91035) *Training Research Co., Ltd.* is listed by the FCC as a facility available to do measurement work for others on a contract basis.

1.8 General Test Condition

The conditions under which the EUT operates were varied to determine their effect on the equipment's emission characteristics. The final configuration of the test system and the mode of operation used during these tests were chosen as that which produced the highest emission levels. However, only those conditions, which the EUT was considered likely to encounter in normal use were investigated.

In test, they were set in high power and continuously transmitting mode that controlled by computer. The ch01, ch06 and ch11 of EUT were all tested. The setting up procedure is recorded on Appendix A.

II. Section 15.101(a): Equipment authorization of unintentional radiators

The EUT equipped with an Internet interface and should be operated with the computer. It was categorized to *Class B personal computers and peripherals* as cannot be operated stand-alone. The authorization requires Certification and the items required such as Sect.15.107 (Conducted limits) and Sect.15.109 (Radiated emission limits) is same as Sect.15.207 and 15.247(C) we'd performed respectively. So in this test report we have "unintentional" and "intentional" setup and test. The "intentional test" was making the RF device to transmit continuously. The "unintentional test" was making the EUT as a usual status. (See Appendix A setup)

III. Section 15.203: Antenna requirement

The EUT has an integrated antenna permanently attached on the PCB. In addition, there is no external antenna or connector employed. The antenna requirement stated in Sect.15.203 is inapplicable to this EUT.

The antenna specification listed in the Appendix B of the test report.

IV. Section 15.207: Power Line Conducted Emissions for AC Powered Units

4.1 Test Condition & Setup

The EUT was assembled on a wooden table, which is 80 centimeters high, was placed 40 centimeters from the back wall and at least 1 meter from the sidewall.

Power was fed to the EUT from the public utility power grid through a line filter and Line Impedance Stabilization Networks (LISNs). The LISN housing, measuring instrumentation case, ground plane, etc., were electrically bonded together at the same RF potential. The Spectrum analyzer (or EMI receiver) was connected to the AC line through an isolation transformer. The 50-ohm output of the LISN was connected to the spectrum analyzer directly. Conducted emission levels were in the CISPER quasi-peak detection mode. The analyzer's 6 dB bandwidth was set to 9 KHz. No post-detector video filter was used.

The spectrum was scanned from 150 KHz to 30 MHz. The physical arrangement of the test system and associated cabling was varied (within the scope of arrangements likely to be encountered in actual use) to determine the effect on the unit's emanations in amplitude and frequency. All spurious emission frequencies were observed.

There are two test conditions applied in this test item, the test procedure description as the following:

1. EUT transmit only: (intentional test)
 Using the LAN card install in Notebook and use software to control the EUT. Then making access to the mode of continuous transmission and setting the testing channel. Three channels were tested, one in the top (CH01), one in the middle (CH06) and the other in bottom (CH11). The CH 1 was the worst case which was recorded.

2. EUT as a class B peripheral, see Appendix A.

Above, the 110V/230V were tested individually.

4.2 List of Test Instruments

Instrument Name	Model No.	Brand	Serial No.	Last time	Next time
Receiver	SCR3102	SCHAFFNER	012	03/29/02	03/28/03
LISN (EUT)	3825/2	EMCO	9411-2284	06/17/02	06/16/03
LISN (Support E.)	3825/2	EMCO	9210-2007	05/31/02	05/31/03
Preamplifier	EQ3-006	TRC	-----	05/15/02	05/15/03
			-		
Line switch box	EQ3-007	TRC	-----	05/15/02	05/15/03
			-		

The level of confidence of 95% , the uncertainty of measurement of conducted emission is ± 2.02 dB .

4.3 Test configuration

Conducted Emissions Test Placement of Unintentional



Conducted Emissions Test Placement of Intentional



4.4 Test Result of Conducted Emissions

Conducted emissions Test Result

Temperature: 19°C Humidity: 59% Power: 110.0V Power Frequency: 60.0Hz

Report No: R03ET528

Test Mode: intentional-CH1

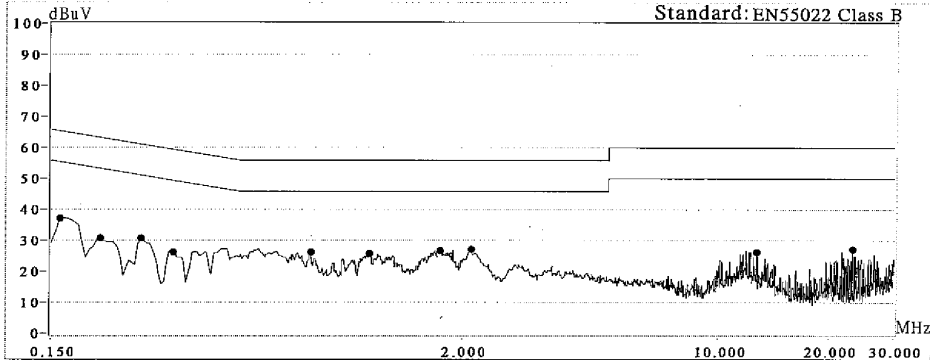

Freq(MHz)	QP	QP_Limit	QP_Margin	AVG	AVG_Limit	AVG_Margin	CF	L1/L2	Peak	Margin
0.159	***	65.74	***	***	55.74	***	6.72	L1	37.32	-18.42
0.206	***	64.40	***	***	54.40	***	6.80	L1	30.73	-23.67
0.266	***	62.69	***	***	52.69	***	6.80	L1	30.77	-21.92
0.326	***	60.97	***	***	50.97	***	6.80	L1	26.56	-24.41
0.774	***	56.00	***	***	46.00	***	6.80	L1	26.17	-19.83
1.126	***	56.00	***	***	46.00	***	6.80	L1	25.86	-20.14
1.741	***	56.00	***	***	46.00	***	6.80	L1	26.83	-19.17
2.120	***	56.00	***	***	46.00	***	6.81	L1	27.11	-18.89
12.750	***	60.00	***	***	50.00	***	7.14	L1	26.37	-23.63
23.130	***	60.00	***	***	50.00	***	7.56	L1	27.42	-22.58

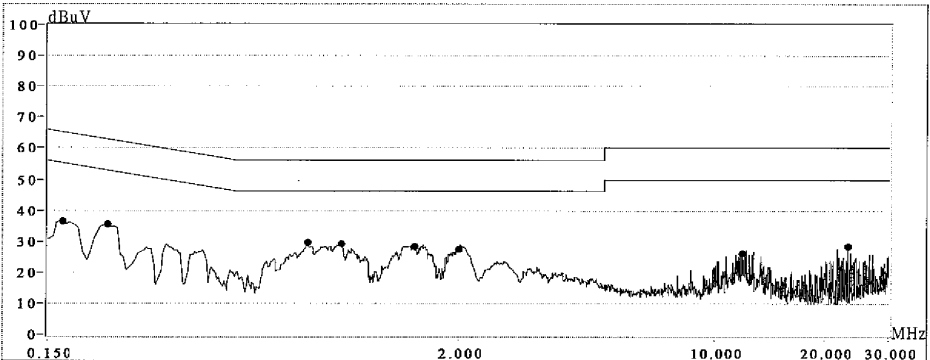

Freq(MHz)	QP	QP_Limit	QP_Margin	AVG	AVG_Limit	AVG_Margin	CF	L1/L2	Peak	Margin
0.164	***	65.60	***	***	55.60	***	6.73	L2	36.59	-19.01
0.219	***	64.03	***	***	54.03	***	6.80	L2	35.70	-18.33
0.774	***	56.00	***	***	46.00	***	6.80	L2	29.94	-16.06
0.955	***	56.00	***	***	46.00	***	6.80	L2	29.42	-16.58
1.519	***	56.00	***	***	46.00	***	6.80	L2	28.31	-17.69
2.000	***	56.00	***	***	46.00	***	6.80	L2	27.80	-18.20
11.900	***	60.00	***	***	50.00	***	7.16	L2	26.41	-23.59
23.130	***	60.00	***	***	50.00	***	7.56	L2	28.53	-21.47

碩訊科技股份有限公司 Test date: 2002-12-12 at 16:57 by JASON

Conducted emissions Test Result

Temperature: 19°C Humidity: 59% Power: 230.0V Power Frequency: 50.0Hz

Report No: R03ET528

Test Mode: intentional-CH1

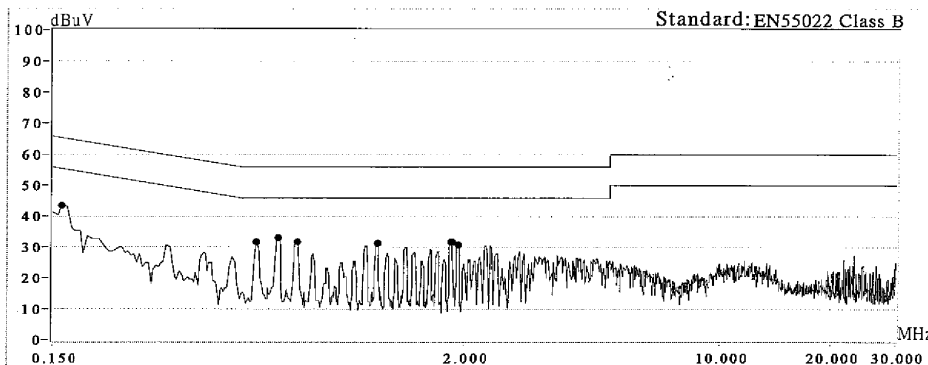

Freq(MHz)	QP	QP_Limit	QP_Margin	AVG	AVG_Limit	AVG_Margin	CF	L1/L2	Peak	Margin
0.159	** **	65.74	** **	** **	55.74	** **	6.72	L1	43.44	-12.30
0.543	** **	56.00	** **	** **	46.00	** **	6.80	L1	31.69	-14.31
0.622	** **	56.00	** **	** **	46.00	** **	6.80	L1	33.40	-12.60
0.700	** **	56.00	** **	** **	46.00	** **	6.80	L1	31.86	-14.14
1.168	** **	56.00	** **	** **	46.00	** **	6.80	L1	31.55	-14.45
1.843	** **	56.00	** **	** **	46.00	** **	6.80	L1	31.67	-14.33
1.857	** **	56.00	** **	** **	46.00	** **	6.80	L1	31.65	-14.35
1.931	** **	56.00	** **	** **	46.00	** **	6.80	L1	31.05	-14.95

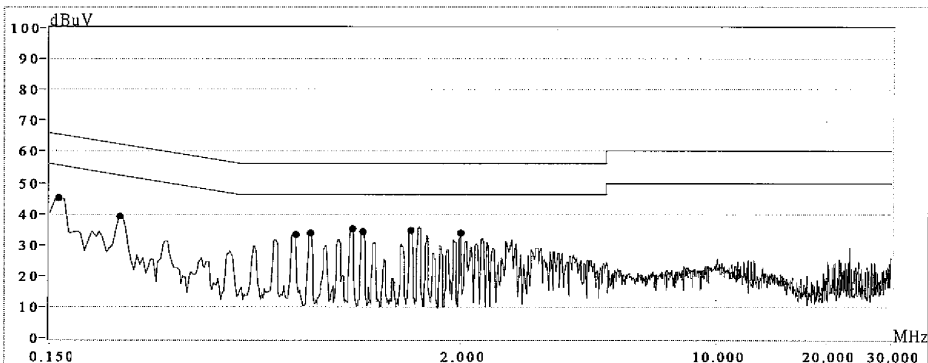

Freq(MHz)	QP	QP_Limit	QP_Margin	AVG	AVG_Limit	AVG_Margin	CF	L1/L2	Peak	Margin
0.159	** **	65.74	** **	** **	55.74	** **	6.72	L2	45.43	-10.31
0.233	** **	63.63	** **	** **	53.63	** **	6.80	L2	39.56	-14.07
0.705	** **	56.00	** **	** **	46.00	** **	6.80	L2	33.52	-12.48
0.774	** **	56.00	** **	** **	46.00	** **	6.80	L2	33.80	-12.20
1.010	** **	56.00	** **	** **	46.00	** **	6.80	L2	35.20	-10.80
1.084	** **	56.00	** **	** **	46.00	** **	6.80	L2	34.49	-11.51
1.473	** **	56.00	** **	** **	46.00	** **	6.80	L2	34.71	-11.29
2.000	** **	56.00	** **	** **	46.00	** **	6.80	L2	33.77	-12.23

碩訊科技股份有限公司 Test date: 2002-12-12 at 17:16 by JASON

Conducted emissions Test Result

Temperature °C Humidity % Power V Power Frequency Hz

Report No. R03ET528

Test Mode: unintentional-100M

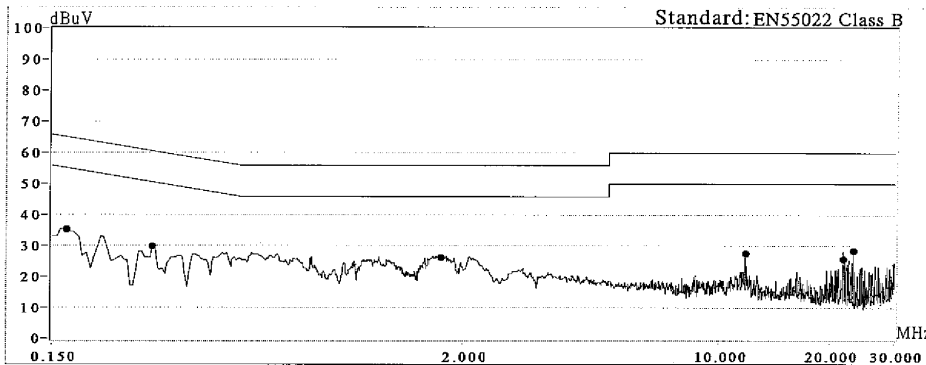

Freq(MHz)	QP	QP_Limit	QP_Margin	AVG	AVG_Limit	AVG_Margin	CF	L1/L2	Peak	Margin
0.164	***	65.60	***	***	55.60	***	6.73	L1	35.61	-19.99
0.284	***	62.17	***	***	52.17	***	6.80	L1	30.07	-22.10
1.741	***	56.00	***	***	46.00	***	6.80	L1	26.31	-19.69
11.850	***	60.00	***	***	50.00	***	7.16	L1	27.95	-22.05
21.650	***	60.00	***	***	50.00	***	7.43	L1	26.06	-23.94
23.150	***	60.00	***	***	50.00	***	7.56	L1	28.71	-21.29

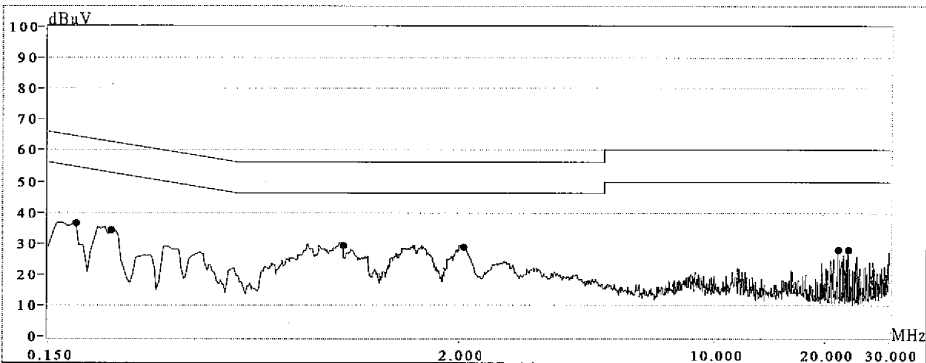

Freq(MHz)	QP	QP_Limit	QP_Margin	AVG	AVG_Limit	AVG_Margin	CF	L1/L2	Peak	Margin
0.178	***	65.20	***	***	55.20	***	6.76	L2	36.88	-18.32
0.224	***	63.89	***	***	53.89	***	6.80	L2	34.49	-19.40
0.964	***	56.00	***	***	46.00	***	6.80	L2	29.35	-16.65
2.060	***	56.00	***	***	46.00	***	6.81	L2	28.94	-17.06
21.680	***	60.00	***	***	50.00	***	7.43	L2	27.91	-22.09
23.130	***	60.00	***	***	50.00	***	7.56	L2	28.08	-21.92

碩訊科技股份有限公司 Test date: 2002-12-12 at 17:03 by JASON

Conducted emissions Test Result

Temperature °C Humidity % Power V Power Frequency Hz

Report No. R03ET528

Test Mode: unintentional-100M

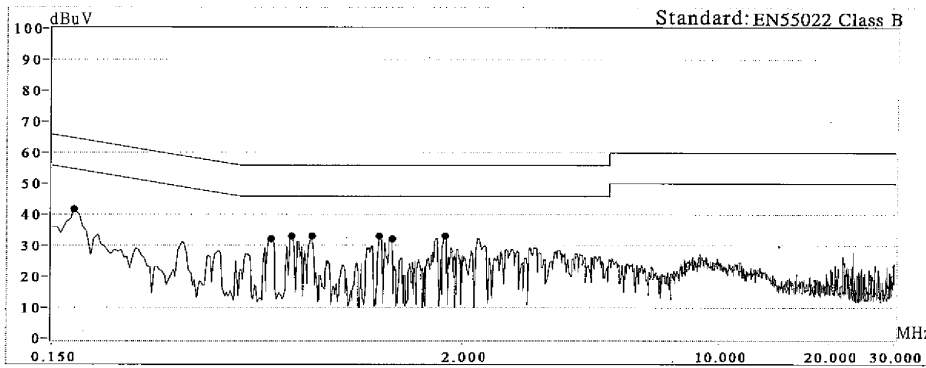

Freq(MHz)	QP	QP_Limit	QP_Margin	AVG	AVG_Limit	AVG_Margin	CF	L1/L2	Peak	Margin
0.173	** ** *	65.34	** ** *	** ** *	55.34	** ** *	6.75	L1	41.88	-13.47
0.599	** ** *	56.00	** ** *	** ** *	46.00	** ** *	6.80	L1	32.46	-13.54
0.682	** ** *	56.00	** ** *	** ** *	46.00	** ** *	6.80	L1	33.33	-12.67
0.774	** ** *	56.00	** ** *	** ** *	46.00	** ** *	6.80	L1	32.96	-13.04
1.191	** ** *	56.00	** ** *	** ** *	46.00	** ** *	6.80	L1	33.31	-12.69
1.288	** ** *	56.00	** ** *	** ** *	46.00	** ** *	6.80	L1	32.48	-13.52
1.792	** ** *	56.00	** ** *	** ** *	46.00	** ** *	6.80	L1	32.98	-13.02
1.801	** ** *	56.00	** ** *	** ** *	46.00	** ** *	6.80	L1	33.12	-12.88

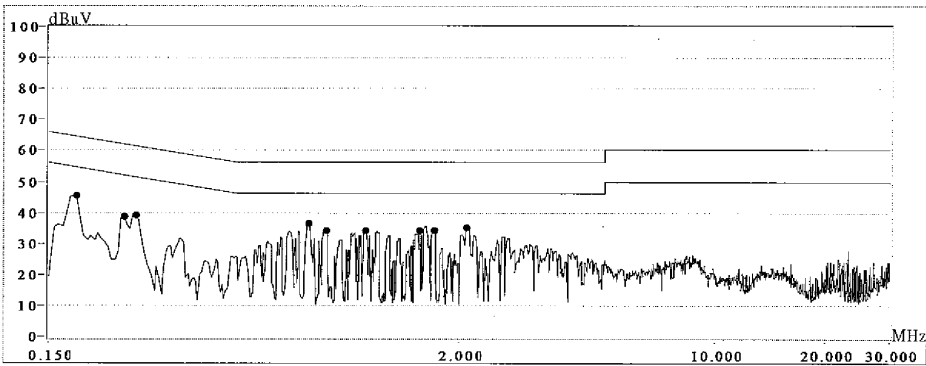

Freq(MHz)	QP	QP_Limit	QP_Margin	AVG	AVG_Limit	AVG_Margin	CF	L1/L2	Peak	Margin
0.178	** ** *	65.20	** ** *	** ** *	55.20	** ** *	6.76	L2	45.54	-9.66
0.243	** ** *	63.34	** ** *	** ** *	53.34	** ** *	6.80	L2	39.04	-14.30
0.261	** ** *	62.83	** ** *	** ** *	52.83	** ** *	6.80	L2	39.21	-13.62
0.774	** ** *	56.00	** ** *	** ** *	46.00	** ** *	6.80	L2	36.59	-9.41
0.867	** ** *	56.00	** ** *	** ** *	46.00	** ** *	6.80	L2	34.49	-11.51
1.112	** ** *	56.00	** ** *	** ** *	46.00	** ** *	6.80	L2	34.40	-11.60
1.570	** ** *	56.00	** ** *	** ** *	46.00	** ** *	6.80	L2	34.31	-11.69
1.713	** ** *	56.00	** ** *	** ** *	46.00	** ** *	6.80	L2	34.54	-11.46
2.100	** ** *	56.00	** ** *	** ** *	46.00	** ** *	6.81	L2	35.43	-10.57

碩訊科技股份有限公司 Test date: 2002-12-12 at 17:07 by JASON

V. Section 15.247 (a): Technical description of the EUT

Based on the Section 2.1, *Direct Sequence System* is a spread spectrum system in which the carrier has been modulated by a high speed spreading code and an information data stream. The high speed code sequence dominates the “modulating function” and is the direct cause of the wide spreading of the transmitted signal. In the Exhibit H, operational description demonstrates the operation principles of the Baseband processor employed by the EUT, shows that which is a complete DSSS baseband processor and meets the definition of the Direct sequence spread spectrum system.

VI. Section 15.247(a)(2): Bandwidth for Direct Sequence System.

6.1 Test Condition & Setup

The transmitter bandwidth measurements were performed by the contact manner. The EUT was set to transmit continuously, also various channels were investigated to find the maximum occupied bandwidth.. The output of the EUT was connected to the spectrum analyzer. The bandwidth of the fundamental frequency is observed by the spectrum analyzer with 100kHz RBW and 100kHz VBW.

6.2 Test Instruments Configuration

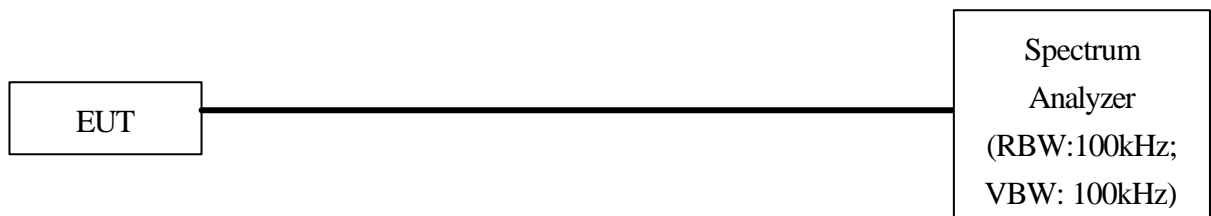

Test Configuration of Bandwidth for Direct Sequence System

P.S.: Notebook computer to control the EUT at maximal power output and channel Number and set antenna kit

6.3 List of Test Instruments

Instrument Name	Model No.	Brand	Serial No.	Last time	Next time
Spectrum Analyzer	8592A	H P	3003AD1401	01/02/02	01/01/03

6.4 Test Result of Bandwidth

Bandwidth of Channel 1

Bandwidth : 9.90 MHz

The min. 6 dB BW at least : 500 KHz

Bandwidth of Channel 6

Bandwidth : 9.40 MHz

The min. 6 dB BW at least : 500 KHz

Bandwidth of Channel 11

Bandwidth : 10.67 MHz

The min. 6 dB BW at least : 500 KHz

Note:

1. The data in the above table are summarizing the following attachment spectrum analyzer hard copy. According to the guidance, we'd made the measurement with the spectrum analyzer's resolution bandwidth (RBW)= $100kHz$ and set the $span \gg RBW$. The results show the measured 6dB bandwidth comply with the minimum 500kHz requirement.
2. The attachments show these on the following pages.

Bandwidth of Channel 1: 9.90 MHz



Bandwidth of Channel 6: 9.40 MHz

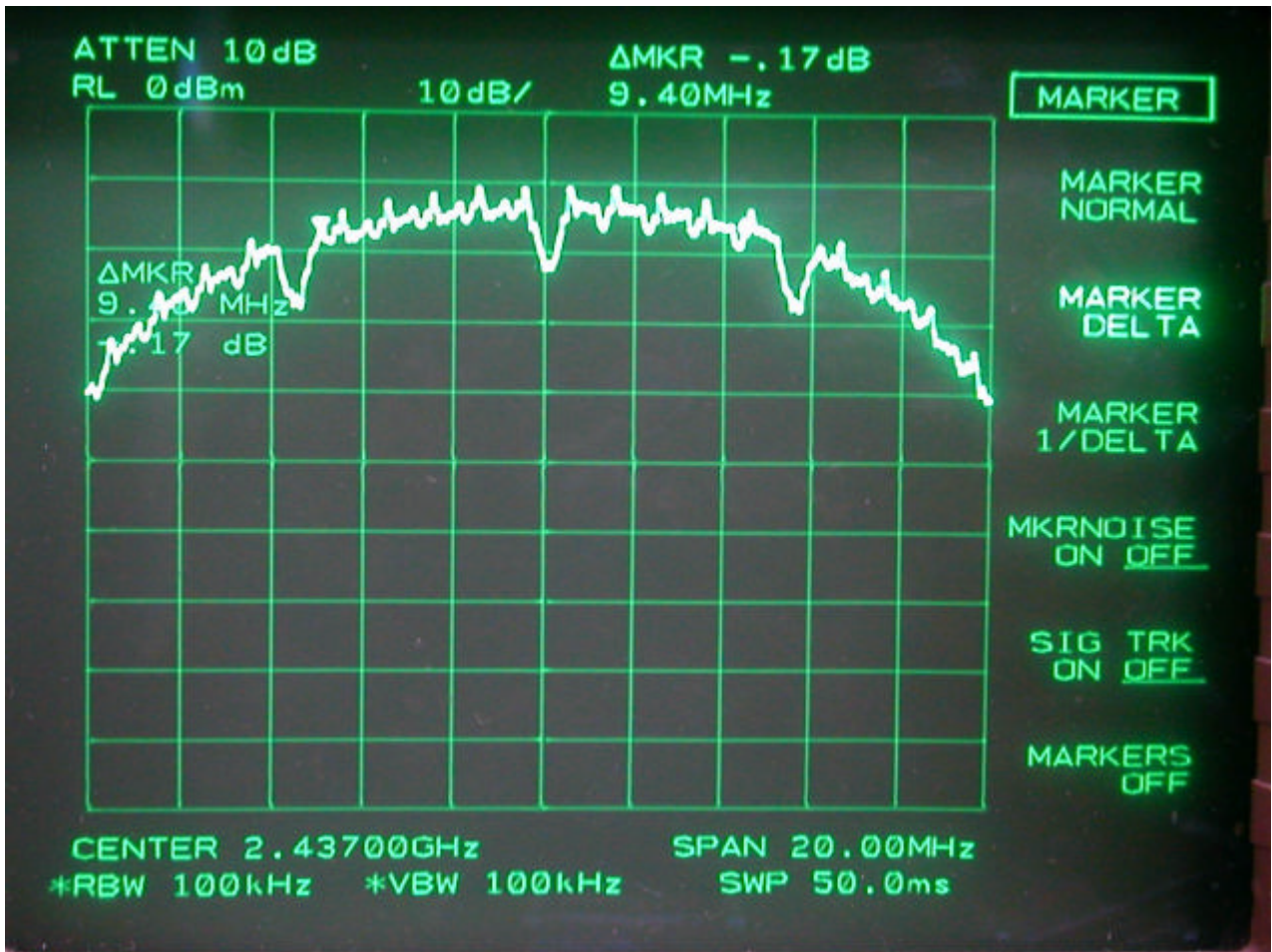

Bandwidth of Channel 11: 10.67 MHz



VII. Section 15.247(b): Power Output

7.1 Test Condition & Setup

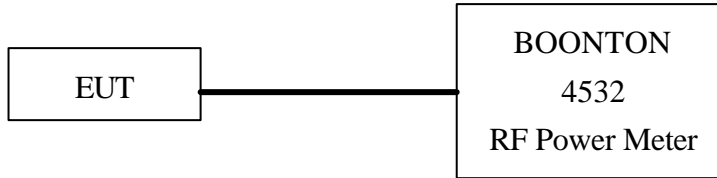

1. The output of the transmitter is connected to the BOONTON RF Power Meter.
2. The calibration is performed before every tests. The values of the output power of the EUT will shown in the dBm directly are the transmitter output peak power. Recording as follows.

7.2 List of Test Instruments

Instrument Name	Model No.	Brand	Serial No.
RF Power Meter	4532	BOONTON	117501

7.3 Test Result

Formula:
 Signal generator + |Cable loss| = Output peak power

Channel	Signal Generator	Cable Loss	DTS Limit	Output peak power	
	dBm	dBm	mW	dBm	mW
CH 1	15.439	0.7	100	16.139	41.10
CH 6	14.822	0.7	100	15.522	35.66
CH 11	15.612	0.7	100	16.312	42.77

Note:

The limit is vary according to the equipment class, listed below:

1. Digital Transmission System (DTS): 100mW
2. Spread Spectrum Transmitter (DSS): 1W

VIII. Section 15.247 (C): Spurious Emissions (Radiated)

8.1 Test Condition & Setup

We'd performed the test by the *radiated emission* skill: The EUT was placed in an anechoic chamber, and set the EUT transmitting continuously and scanned at 3-meter distance to determine its emission characteristics. The physical arrangement of the EUT was varied (within the scope of arrangements likely to be encountered in actual use) to determine the effect on the unit's emanations in amplitude, directivity, and frequency. The exact system configuration, which produced the highest emissions was noted so it could be reproduced later during the final tests. For the measurement above 1GHz, according to the guidance we'd set the spectrum analyzer's 6dB bandwidth RBW to 1MHz.

This was done to ensure that the final measurements would demonstrate the worst-case interference potential of the EUT.

Final radiation measurements (below 1 GHz) was made at an OATS. The EUT system was placed on a nonconductive turntable, which is 0.8 meters height, top surface 1.0 x 1.5 meter.

The receiver was examined from 30 MHz to 1000 MHz using the Receiver (SCHAFFNER) and Bi-Log antenna (Model No.: CBL6141A). Above 1 GHz test was using the Hewlett Packard 8564E Spectrum Analyzer, EMCO Horn Antenna (Model 3115) for 1G ~ 18GHz.

At each frequency, the EUT was rotated 360 degrees, and the antenna was raised and lowered from one to four meters to find the maximum emission levels. Measurements were taken using both horizontal and vertical antenna polarization.

Appropriate preamplifiers were used for improving sensitivity and precautions were taken to avoid overloading or desensitizing the spectrum analyzer. The receiver's 6dB bandwidth was set to 120KHz and the QP data recorded, the spectrum analyzer's 6 dB bandwidth was set to 1 MHz (spectrum was examined from 1GHz to 18GHz) and the analyzer was operated in the maximum hold mode. There is a test condition apply in this test item, the test procedure description as the following:

Making access to the mode of continuous transmission by the software in the computer via the LAN port. Three channels were tested, one in the top (CH01), one in the middle (CH06) and the other in bottom (CH11).

With the transmitter operating from a AC source and using the internal of EUT, radiates spurious emissions falling within the restricted bands of 15.209 were measured at operating frequencies corresponding to upper, middle and bottom channels in the 2400 ~ 2483.5 MHz band.

The actual field intensity in decibels referenced to 1 microvolt per meter (dBµV/m) is determined by algebraically adding the measured reading in dBµV, the antenna factor (dB), and cable loss (dB) at the appropriate frequency. Since the EUT was set to transmit continuously, no *duty cycle* is present.

For frequency between 30MHz to 1000MHz

$$F_{Ia} \text{ (dBuV/m)} = F_{Ir} \text{ (dBµV)} - \text{Correction Factors}$$

F_{Ia} : Actual Field Intensity

F_{Ir} : Reading of the Field Intensity

$$\text{Correction Factors} = \text{Antenna Factor} + \text{Cable Loss} - \text{Amplifier Gain}$$

For frequency between 1 GHz to 18 GHz

$$F_{Ia} \text{ (dBµV/m)} = F_{Ir} \text{ (dBµV)} + \text{Correction Factor}$$

F_{Ia} : Actual Field Intensity

F_{Ir} : Reading of the Field Intensity

$$\text{Correction Factors} = \text{Antenna Factor} + \text{Cable Loss} - \text{Amplifier Gain}$$

The setting up procedure is recorded on Appendix A.

8.2 List of Test Instruments

<u>Instrument Name</u>	<u>Model No.</u>	<u>Brand</u>	<u>Serial No.</u>	<u>Last time</u>	<u>Next time</u>
Receiver	SCR3102	SCHAFFNER	012	03/29/02	03/28/03
Antenna	CBL6141A	SCHAFFNER	4188	11/29/02	11/29/03
Open test side (Antenna, Amplify, cable calibrated together)				05/16/02	05/15/03
Spectrum Analyzer	8564E	HP	US36433002	11/03/02	11/03/03
Microwave	83051A	HP	3232A00347	08/01/02	08/01/03
Preamplifier					
Horn Antenna	3115	EMCO	9704 – 5178	12/27/01	12/27/02

The level of confidence of 95% , the uncertainty of measurement of radiated emission is ± 3.44dB .

8.3 Test Instruments Configuration



Front View of the Test Configuration of **Unintentional**



Rear View of the Test Configuration **Unintentional**



Front View of the Test Configuration of **Intentional**



Rear View of the Test Configuration **Intentional**

8.4 Test Result of Spurious Radiated Emissions

Worst case : Intentional test (CH1)

The highest peak values of radiated emissions from the EUT at various antenna heights, antenna polarizations, EUT orientation, etc. are recorded on the following. (the unintentional test also has been verified which was better)

Test Conditions:

Testing room : Temperature : 20 ° C Humidity : 62 % RH

Testing site : Temperature : 20 ° C Humidity : 62 % RH

Table 1 Radiated Emissions for 30MHz 1GHz [Horizontal]

Radiated Emission				Correction Factors (dB)	Corrected Amplitude (dB?V/m)	FCC Class B (3 m)	
Frequency (MHz)	Amplitude (dB?V/m)	Ant. H. (m)	Table ()			Limit (dB?V/m)	Margin (dB)
36.1388	31.66	2.50	76	1.96	33.62	40.00	-6.38
40.0025	30.58	2.50	250	-0.90	29.68	40.00	-10.32
44.0000	26.58	3.98	349	-2.18	24.40	40.00	-15.60
125.0050	32.99	3.98	61	-4.70	28.29	43.52	-15.23
250.0188	36.27	2.50	312	-1.80	34.47	46.02	-11.55
375.0275	26.30	0.97	236	3.15	29.45	46.02	-16.57
500.0338	34.06	0.97	123	6.80	40.86	46.02	-5.16

Note:

1. Margin = Amplitude – limit, *if margin is minus means under limit.*
2. Corrected Amplitude = Reading Amplitude + Correction Factors
3. Correction factor = Antenna factor + (Cable Loss – Amplitude gain)

Emissions above 1GHz, they are all under the limits more than 20dB in Test Site (including the restricted Band).

Table 2 Radiated Emissions For 30MHz 1GHz [Vertical]

Radiated Emission				Correction Factors (dB)	Corrected Amplitude (dB? V/m)	FCC Class B (3 m)	
Frequency (MHz)	Amplitude (dB? V/m)	Ant. H. (m)	Table ()			Limit (dB? V/m)	Margin (dB)
31.4388	31.16	2.50	17	4.30	35.46	40.00	-4.54
39.9963	32.95	2.50	352	-0.90	32.05	40.00	-7.95
125.0063	35.39	2.50	280	-4.70	30.69	43.52	-12.83
250.0200	38.87	1.01	100	-1.80	37.07	46.02	-8.95
500.0375	31.42	1.01	161	6.80	38.22	46.02	-7.80

Note:

1. Margin = Amplitude – limit, *if margin is minus means under limit.*
2. Corrected Amplitude = Reading Amplitude + Correction Factors
3. Correction factor = Antenna factor + (Cable Loss – Amplitude gain)

Emissions above 1GHz, they are all under the limits more than 20dB in Test Site (including the restricted Band).

8.5 Test Result of the Bandedge

If any 100 kHz bandwidth outside these frequency bands, the radio frequency power that is produced by the modulation products of the spreading sequence, the information sequence and the carrier frequency shall be either *at least 20 dB below that in any 100 kHz bandwidth within the band that contains the highest level of the desired power or shall not exceed the general levels specified in § 15.209(a)*,

We perform this section by the *conducted* manner, the RBW is set to 100kHz and VBW>RBW. We'd made the observation *up to 10th harmonics and the criterion is all the harmonic/spurious emissions must be 20dB below the highest emission level measured*. If the emissions fall in the restricted bands stated in the Part 15.205(a) must also *comply with the radiated emission limits specified in Part 15.209(a)*.

The following pages show our observations referring to the channel 1 and 11 respectively.

Test Condition & Setup: same as 8.1

Channel 1

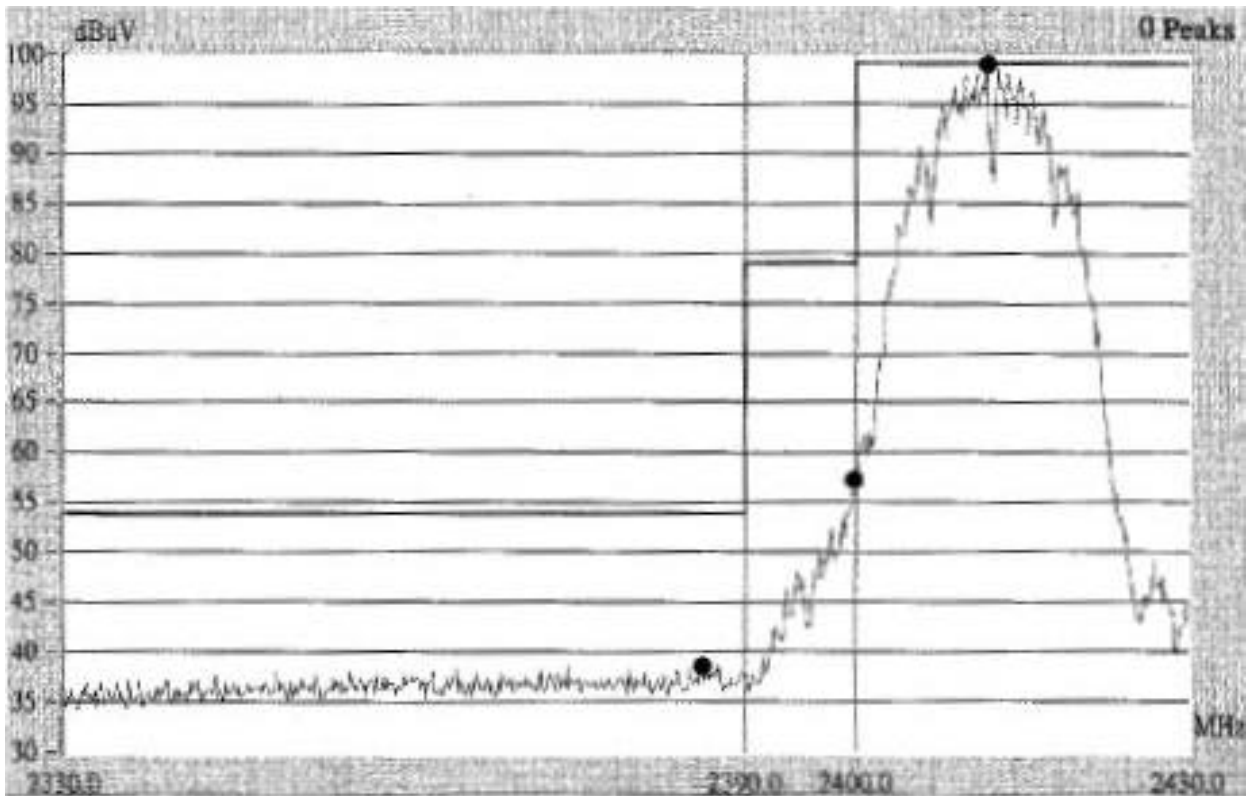

This is the hard copy of our bandedge measurement generated by our bandedge testing program. The picture shown above is the bandedge of channel 1.

1. The lobe right by the fundamental side is already 20dB below the highest emission level.
2. The emissions recorded in the restricted band (<2400MHz) is do comply with the Part 15.209(a) – under the limited line marked in red color.

Channel 11

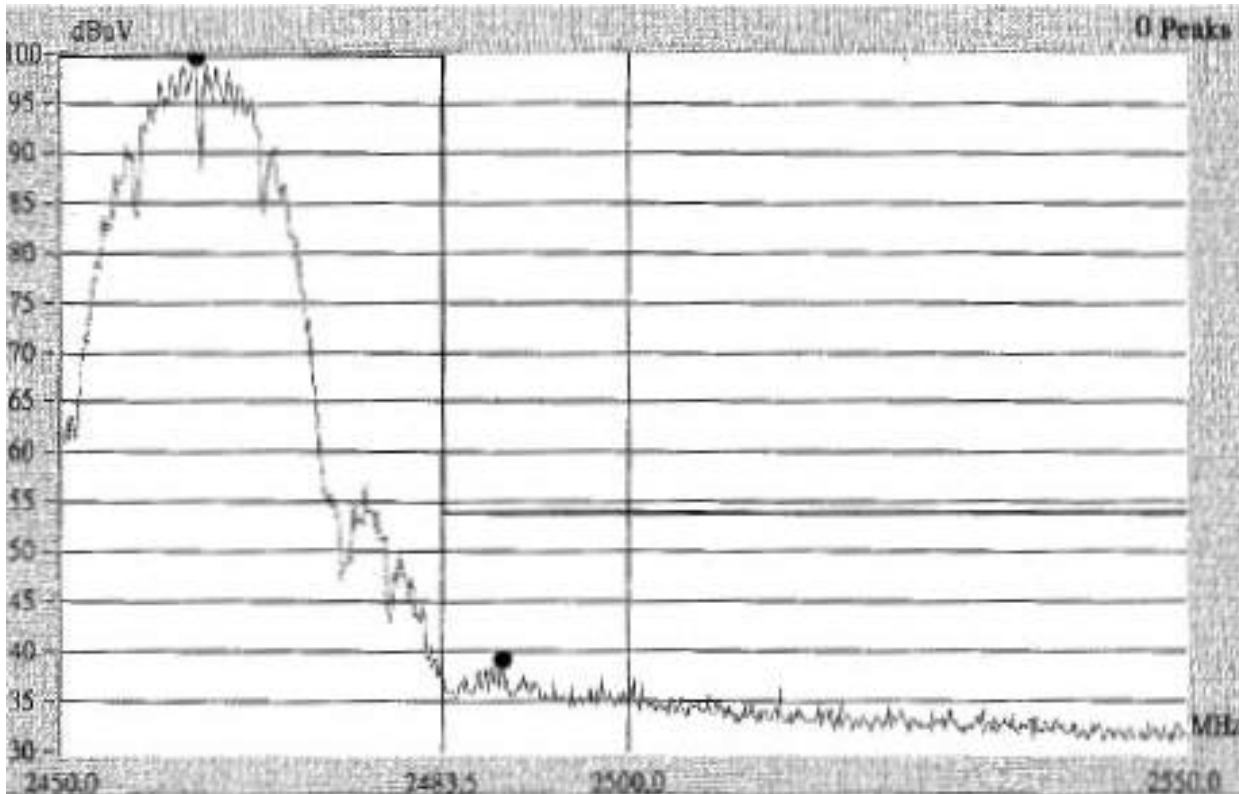

This is the hard copy of our bandedge measurement generated by our bandedge testing program. The picture shown above is the bandedge of channel 11.

1. The lobe right by the fundamental side is already 20dB below the highest emission level.
2. The emissions recorded in the restricted band ($>2483.5\text{MHz}$) is do comply with the Part 15.209(a) – under the limited line marked in red color.

IX. Section 15.247(d): Power Spectral Density

9.1 Test Condition & Setup

The tests below are running with the EUT transmitter set at high power in TDD mode . The EUT is needed to force selection of output power level and channel number. While testing, the EUT was set to transmit continuously and to be tested by the contact manner with the spectrum analyzer.

The attachments below show our observation.

9.2 Test Instruments Configuration

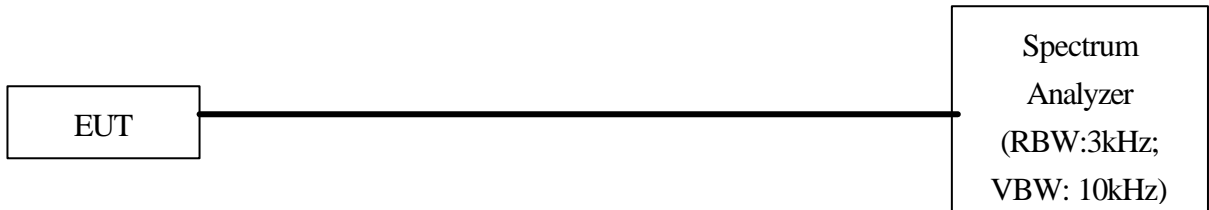

Test Configuration of Power Spectral Density

P.S.: Notebook computer to control the EUT at maximal power output and channel Number and set antenna kit

9.3 List of Test Instruments

Instrument Name	Model No.	Brand	Serial No.	Last time	Next time
Spectrum Analyzer	8594EM	H P	3619A00198	06/04/02	06/04/03

9.4 Test Result of Power spectral density

The following table shows a summary of the test results of the Power Spectral Density.

<i>Channel</i>	<i>Frequency (GHz)</i>	<i>Ppr (dBm)</i>	<i>Cable Loss (dB)</i>	<i>Ppq (dBm)</i>	<i>Limit (dB)</i>	<i>Margin (dB)</i>
CH 01	2.4126	-8.50	1.80	-6.70	8.00	-14.70
CH 06	2.4364	-9.17	1.85	-7.32	8.00	-15.32
CH 11	2.4614	-8.00	1.93	-6.07	8.00	-14.07

Note:

1. The attachment follow by this page and there is no page number.
2. Ppr: spectrum read power density (using peak search mode),
 Ppq: actual peak power density in the spread spectrum band.
3. $Ppq = Ppr + |Cable Loss|$

Channel 01

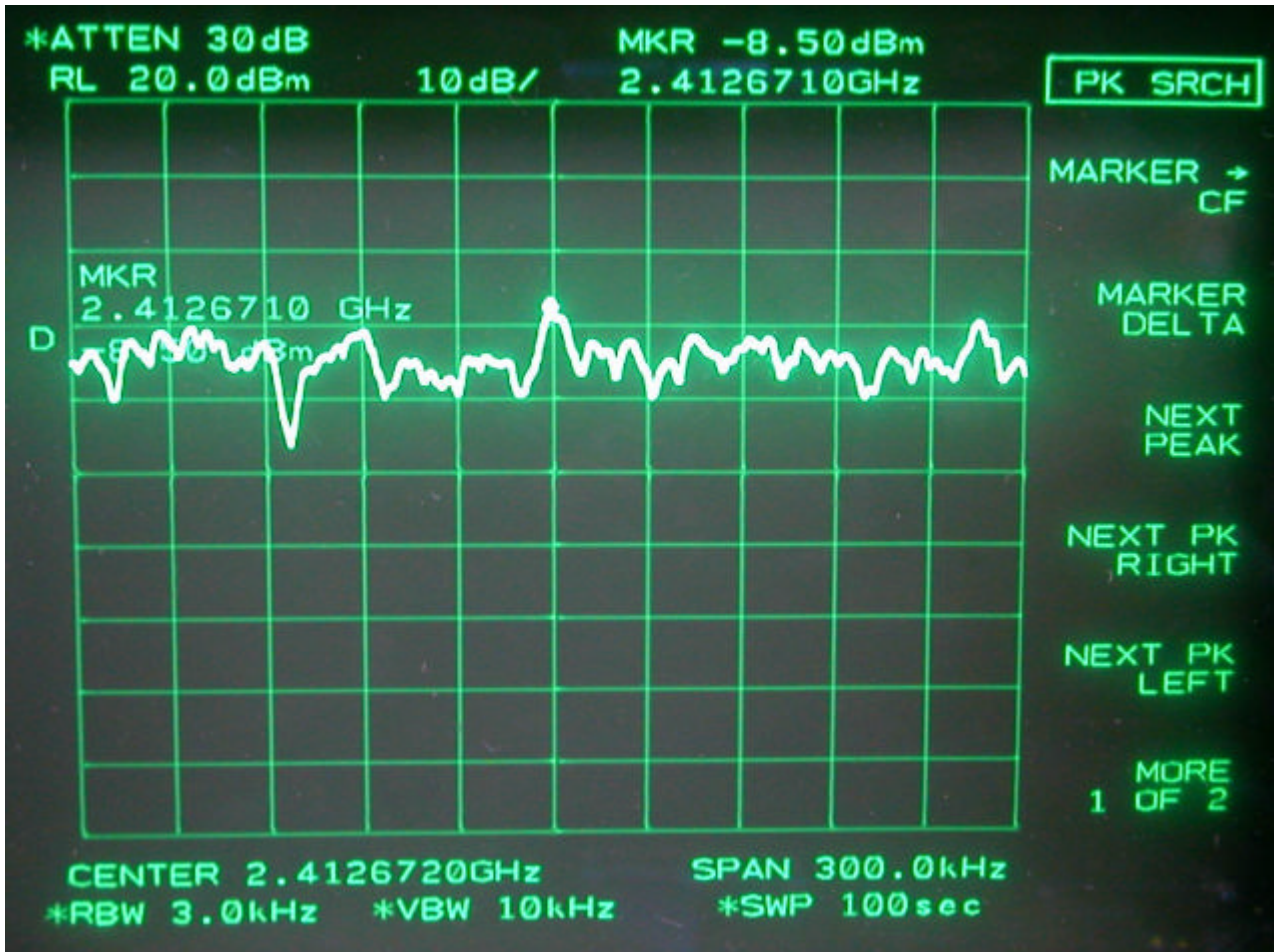

Channel 06

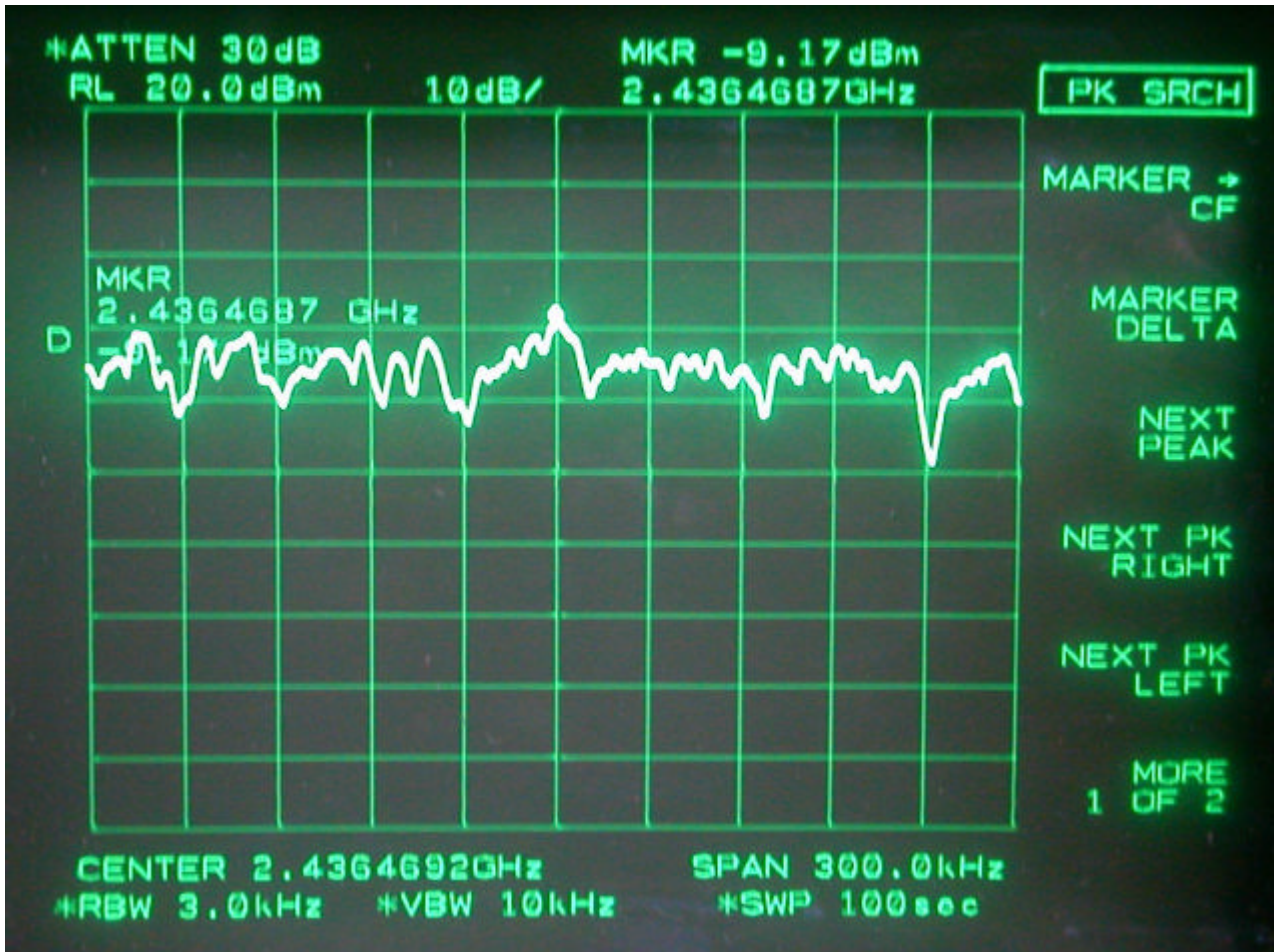

Channel 11

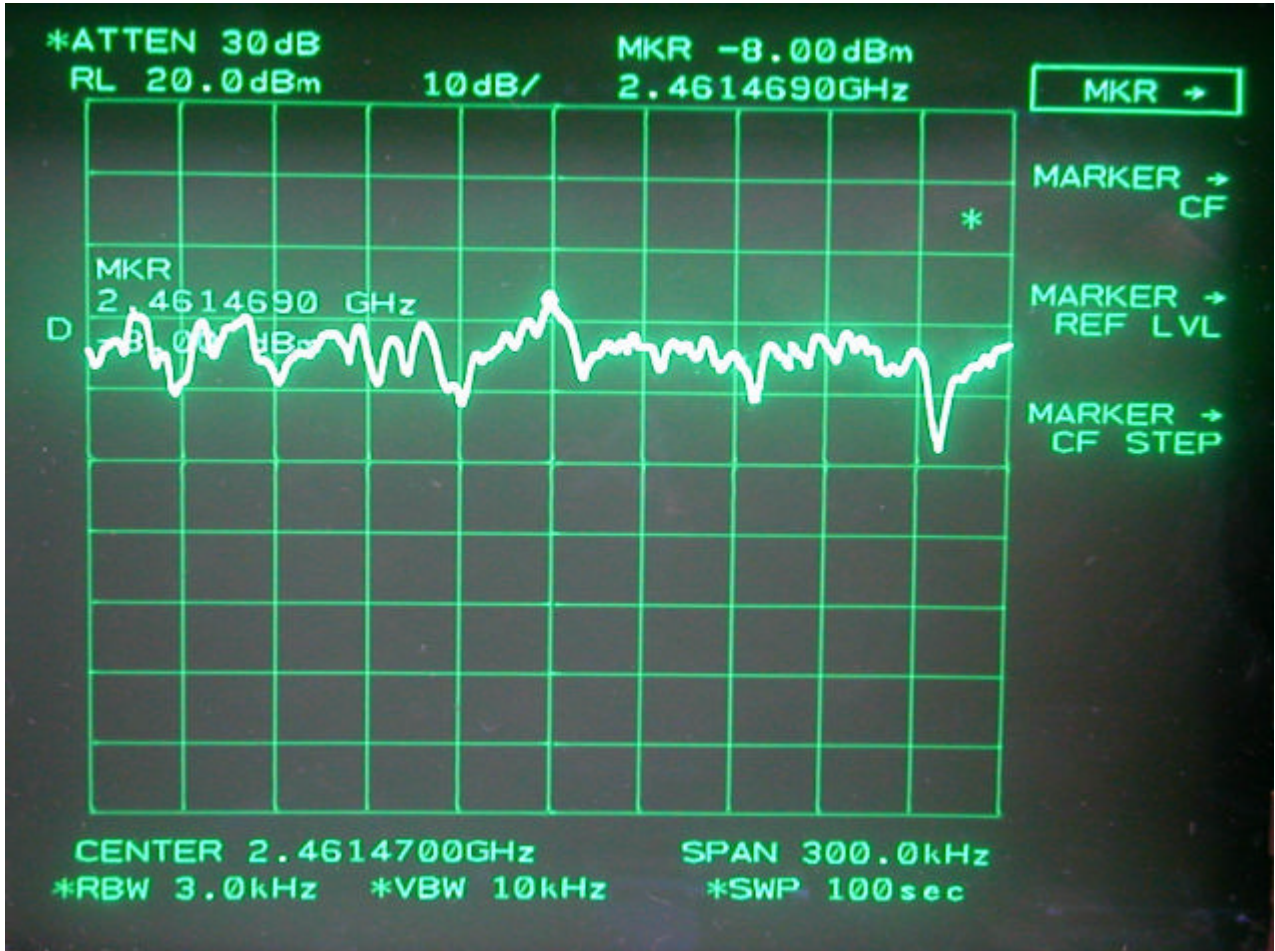

Appendix A

Setting up Procedure

<A> Intentional test set up

1. Connect the EUT with the notebook computer through the LAN port. Using the LAN port of Notebook Computer and software to control the wireless gateway.
2. Use the software provided by the manufacturer and operated in the windows to control the EUT's continuous transmission.
3. Then making access to the mode of continuous transmission and set the testing channel.
4. The conducted and Radiated spurious emissions were recorded only the worst cases data.

** Unintentional test set up**

1. The internet port connected to the PC nearby and the LAN ports 1, 4 connected to the PC located remotely. Set the PC transmitting and receiving data with 10M and 100M respectively. (100M test data recorded)
2. The internet port to ping the internet.
3. The LAN port 2, 3 connected with the dummy load.
4. There was a Notebook which was with a PCMCIA WLAN Card located remotely to keep to communicate with the EUT.

Appendix B

Antenna Specification

ELECTRICAL SPECIFICATIONS

Frequency	2400 ~ 2500MHz
Gain	2dBi
VSWR	1:2.0 MAX.
Impedance	50Ohm
Polarization	Liner, Vertical
Cable type	ϕ 1.13 mm
Cable length	75mm
Connector	Strip end 3-1-1

List of pictures



COPE 1
P/N: RT-05005-L150



Option: Plastic Adaptor
P/N: RT-05005-PA