

**DECLARATION OF COMPLIANCE  
SAR EVALUATION**

**Test Lab**

**CELLTECH RESEARCH INC.**  
Testing and Engineering Lab  
1955 Moss Court  
Kelowna, B.C.  
Canada V1Y 9L3  
Phone: 250-448-7047  
Fax: 250-448-7046  
e-mail: [info@celltechlabs.com](mailto:info@celltechlabs.com)  
web site: [www.celltechlabs.com](http://www.celltechlabs.com)

**Applicant Information**

**THE LINKSYS GROUP INC.**  
17401 Armstrong Avenue  
Irvine, CA 92614

<b>FCC Rule Part(s):</b>	<b>§2.1093</b>
<b>Test Procedure(s):</b>	<b>FCC OET Bulletin 65, Supplement C (01-01)</b>
<b>Device Classification:</b>	<b>Part 15 Spread Spectrum Transmitter (DSS)</b>
<b>FCC ID:</b>	<b>PKW-NWP11B</b>
<b>Model(s):</b>	<b>NWP11B</b>
<b>EUT Type:</b>	<b>DSSS Wireless Notebook Adapter for Laptop PC</b>
<b>Tx Frequency Range:</b>	<b>2412 - 2462 MHz</b>
<b>Conducted Power Tested:</b>	<b>17.99 dBm (2412 MHz)</b>
	<b>17.54 dBm (2437 MHz)</b>
	<b>16.87 dBm (2462 MHz)</b>
<b>Antenna Type:</b>	<b>Internal</b>
<b>Power Supply:</b>	<b>from host Laptop PC</b>
<b>Max. SAR Measured:</b>	<b>0.989 W/kg</b>

Celltech Research Inc. declares under its sole responsibility that this device was found to be in compliance with the Specific Absorption Rate (SAR) RF exposure requirements specified in FCC §2.1093 and was tested in accordance with the measurement standards and procedures specified in FCC OET Bulletin 65, Supplement C, Edition 01-01 (General Population / Uncontrolled Exposure).

I attest to the accuracy of data. All measurements were performed by me or were made under my supervision and are correct to the best of my knowledge and belief. I assume full responsibility for the completeness of these measurements and vouch for the qualifications of all persons taking them.

This test report shall not be reproduced partially, or in full, without the prior written approval of Celltech Research Inc. The results and statements contained in this report pertain only to the device(s) evaluated.



**Russell Pipe**  
Senior Compliance Technologist  
Celltech Research Inc.



<b>TABLE OF CONTENTS</b>		
<b>1.0</b>	<b>INTRODUCTION.....</b>	<b>3</b>
<b>2.0</b>	<b>DESCRIPTION OF EUT.....</b>	<b>3</b>
<b>3.0</b>	<b>SAR MEASUREMENT SYSTEM .....</b>	<b>4</b>
<b>4.0</b>	<b>MEASUREMENT SUMMARY.....</b>	<b>5</b>
<b>5.0</b>	<b>DETAILS OF SAR EVALUATION.....</b>	<b>6</b>
<b>6.0</b>	<b>EVALUATION PROCEDURES.....</b>	<b>7</b>
<b>7.0</b>	<b>SYSTEM VALIDATION.....</b>	<b>8</b>
<b>8.0</b>	<b>EQUIVALENT TISSUES.....</b>	<b>9</b>
<b>9.0</b>	<b>SAR LIMITS.....</b>	<b>9</b>
<b>10.0</b>	<b>SYSTEM SPECIFICATIONS.....</b>	<b>10</b>
<b>11.0</b>	<b>PROBE SPECIFICATION.....</b>	<b>11</b>
<b>12.0</b>	<b>SAM PHANTOM.....</b>	<b>11</b>
<b>13.0</b>	<b>DEVICE HOLDER.....</b>	<b>11</b>
<b>14.0</b>	<b>TEST EQUIPMENT LIST.....</b>	<b>12</b>
<b>15.0</b>	<b>MEASUREMENT UNCERTAINTIES.....</b>	<b>13</b>
<b>16.0</b>	<b>REFERENCES.....</b>	<b>14</b>
	<b>APPENDIX A - SAR MEASUREMENT DATA.....</b>	<b>15</b>
	<b>APPENDIX B - SYSTEM VALIDATION.....</b>	<b>16</b>
	<b>APPENDIX C - DIPOLE CALIBRATION.....</b>	<b>17</b>
	<b>APPENDIX D - PROBE CALIBRATION.....</b>	<b>18</b>
	<b>APPENDIX E - MEASURED FLUID DIELECTRIC PARAMETERS.....</b>	<b>19</b>
	<b>APPENDIX F - SAM PHANTOM CERTIFICATE OF CONFORMITY.....</b>	<b>20</b>
	<b>APPENDIX G - SAR TEST SETUP &amp; EUT PHOTOGRAPHS.....</b>	<b>21</b>

## 1.0 INTRODUCTION

This measurement report demonstrates that THE LINKSYS GROUP INC. Model: NWP11B DSSS Wireless Notebook Adapter (for Laptop PC) FCC ID: PKW-NWP11B complies with the RF exposure requirements specified in FCC 47 CFR §2.1093 (see reference [1]). The test procedures described in FCC OET Bulletin 65, Supplement C, Edition 01-01 (see Reference [2]) were employed. A description of the product, operating configuration, detailed summary of the test results, methodology and procedures used in the evaluation, equipment used, and the various provisions of the rules are included within this test report.

## 2.0 DESCRIPTION of Equipment Under Test (EUT)

<b>FCC Rule Part(s)</b>	47 CFR §2.1093
<b>FCC Test Procedure</b>	OET Bulletin 65, Supplement C (01-01)
<b>FCC Device Classification</b>	Part 15 Spread Spectrum Transmitter (DSS)
<b>Device Type</b>	DSSS Wireless Notebook Adapter (for Laptop PC)
<b>FCC ID</b>	PKW-NWP11B
<b>Model(s)</b>	NWP11B
<b>Serial No.</b>	Pre-production
<b>Tx Frequency Range</b>	2412 - 2462 MHz
<b>RF Conducted Power Tested</b>	17.99 dBm (2412 MHz) 17.54 dBm (2437 MHz) 16.87 dBm (2462 MHz)
<b>Antenna Type</b>	Internal
<b>Power Supply</b>	from host Laptop PC

### 3.0 SAR MEASUREMENT SYSTEM

Celltech Research SAR measurement facility utilizes the Dosimetric Assessment System (DASY™) manufactured by Schmid & Partner Engineering AG (SPEAG™) of Zurich, Switzerland. The DASY system is comprised of the robot controller, computer, near-field probe, probe alignment sensor, specific anthropomorphic mannequin (SAM) phantom, and various planar phantoms for brain or body SAR evaluations. The robot is a six-axis industrial robot performing precise movements to position the probe to the location (points) of maximum electromagnetic field (EMF). A cell controller system contains the power supply, robot controller, teach pendant (Joystick), and remote control, is used to drive the robot motors. The Staubli robot is connected to the cell controller to allow software manipulation of the robot. A data acquisition electronic (DAE) circuit performs the signal amplification, signal multiplexing, AD-conversion, offset measurements, mechanical surface detection, collision detection, etc. is connected to the Electro-optical coupler (EOC). The EOC performs the conversion from the optical into digital electric signal of the DAE and transfers data to the PC plug-in card. The DAE3 utilizes a highly sensitive electrometer-grade preamplifier with auto-zeroing, a channel and gain-switching multiplexer, a fast 16-bit AD-converter and a command decoder and control logic unit. Transmission to the PC-card is accomplished through an optical downlink for data and status information and an optical uplink for commands and clock lines. The mechanical probe-mounting device includes two different sensor systems for frontal and sidewise probe contacts. They are also used for mechanical surface detection and probe collision detection. The robot uses its own controller with a built in VME-bus computer.



DASY3 SAR Measurement System with SAM phantom

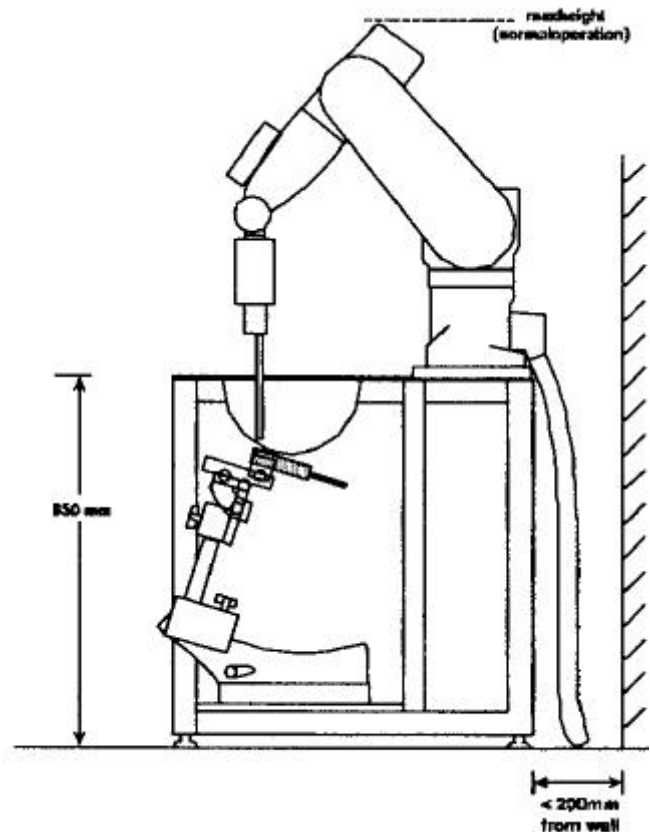

Figure 1. DASY3 Compact Version - Side View

## 4.0 MEASUREMENT SUMMARY

The measurement results were obtained with the EUT tested in the conditions described in this report. Detailed measurement data and plots showing the maximum SAR location of the EUT are reported in Appendix A.

<b>BODY SAR MEASUREMENT RESULTS</b>									
Freq. (MHz)	Channel	Mode	Conducted Power (dBm)		Phantom Section	Host Laptop PCMCIA Slot	Host Laptop Position to Planar Phantom	Separation Distance (cm)	Measured SAR 1g (W/kg)
			Before	After					
2412	Low	DSSS	17.99	17.84	Planar	Top	Keyboard Side	0.0	0.653
2437	Mid	DSSS	17.54	17.42	Planar	Top	Keyboard Side	0.0	0.675
2462	High	DSSS	16.87	16.82	Planar	Top	Keyboard Side	0.0	0.665
2412	Low	DSSS	17.99	17.90	Planar	Bottom	Bottom Side	0.0	0.989
2437	Mid	DSSS	17.54	17.39	Planar	Bottom	Bottom Side	0.0	0.892
2462	High	DSSS	16.87	16.75	Planar	Bottom	Bottom Side	0.0	0.941
2412	Low	DSSS	17.99	17.91	Planar	Bottom	Left Side	1.5	0.401
2437	Mid	DSSS	17.54	17.50	Planar	Bottom	Left Side	1.5	0.375
2462	High	DSSS	16.87	16.74	Planar	Bottom	Left Side	1.5	0.344
<b>ANSI / IEEE C95.1 1992 - SAFETY LIMIT</b> <b>BODY: 1.6 W/kg (averaged over 1 gram)</b> <b>Spatial Peak - Uncontrolled Exposure / General Population</b>									
<b>Test Date(s)</b>	<b>09/13/02</b>		<b>Relative Humidity</b>		<b>42 %</b>				
<b>Measured Mixture Type</b>	<b>2450MHz Muscle</b>		<b>Atmospheric Pressure</b>		<b>101.5 kPa</b>				
<b>Dielectric Constant <math>\epsilon_r</math></b>	<b>Target</b>	<b>Measured</b>	<b>Ambient Temperature</b>		<b>23.9 °C</b>				
	<b>52.7 ±10%</b>	<b>51.1</b>	<b>Fluid Temperature</b>		<b>22.7 °C</b>				
<b>Conductivity <math>\sigma</math> (mho/m)</b>	<b>Target</b>	<b>Measured</b>	<b>Fluid Depth</b>		<b>≥ 15 cm</b>				
	<b>1.95 ±10%</b>	<b>2.01</b>	<b><math>\rho</math> (Kg/m<sup>3</sup>)</b>		<b>1000</b>				

## 5.0 DETAILS OF SAR EVALUATION

THE LINKSYS GROUP INC. Model: NWP11B DSSS Wireless Notebook Adapter (for Laptop PC) FCC ID: PKW-NWP11B was found to be compliant for localized Specific Absorption Rate based on the following test provisions and conditions described below. The detailed test setup photographs are shown in Appendix G.

1. The EUT was tested for body SAR in the top PCMCIA slot of the host Laptop PC (Fujitsu Lifebook E Series). The keyboard side of the Laptop PC was placed parallel to, and touching, the outer surface of the planar phantom.
2. The EUT was tested for body SAR in the bottom PCMCIA slot of the host Laptop PC (Fujitsu Lifebook E Series). The bottom side of the Laptop PC was placed parallel to, and touching, the outer surface of the planar phantom.
3. The EUT was tested for body SAR with the left-hand keyboard side of the host Laptop PC (Fujitsu Lifebook E Series) and antenna end of the EUT placed perpendicular to the planar phantom. The EUT was in the bottom slot of the host Laptop PC (Fujitsu Lifebook E Series). A 1.5 cm separation distance was maintained between the outer tip of the EUT (antenna end) and the outer surface of the planar phantom.
4. The EUT was operated for an appropriate period prior to the evaluation in order to minimize power drift.
5. The conducted power levels were measured before and after each test according to the procedures described in FCC §2.1046. If the conducted power level varied more than 5% from the initial power level, then the EUT was retested. Any unusual anomalies over the course of the test also warranted a re-evaluation.
6. The device was placed into test mode (DSSS Constant Transmit) at maximum power and controlled via internal software from the host Laptop PC.
7. The location of the maximum spatial SAR distribution (Hot Spot) was determined relative to the device and its antenna.
8. The EUT was tested with a fully charged battery in the host Laptop PC.

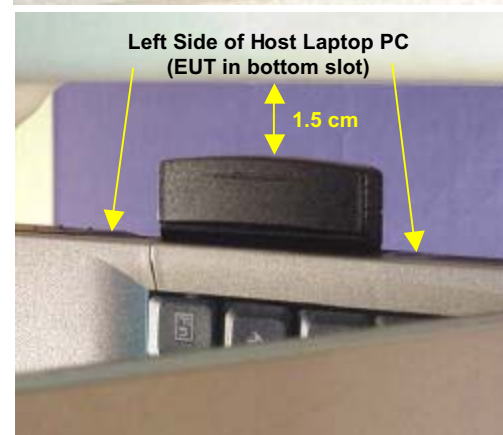
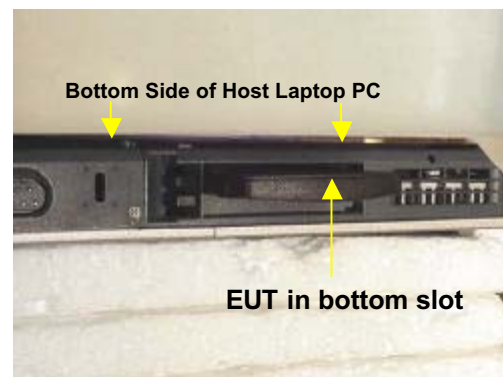
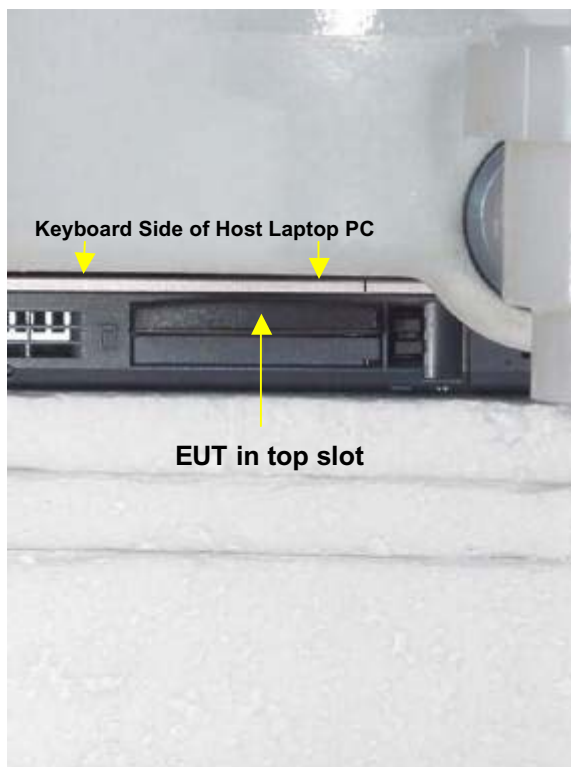



## 6.0 EVALUATION PROCEDURES

- a. (i) The evaluation was performed in the applicable area of the phantom depending on the type of device being tested. For devices held to the ear during normal operation, both the left and right ear positions were evaluated in accordance with FCC OET Bulletin 65, Supplement C (Edition 01-01) using the SAM phantom.
  - (ii) For body-worn and face-held devices a planar phantom was used.
- b. The SAR was determined by a pre-defined procedure within the DASY3 software. Upon completion of a reference and optical surface check, the exposed region of the phantom was scanned near the inner surface with a grid spacing of 20mm x 20mm.
- c. A 5x5x7 matrix was performed around the greatest spatial SAR distribution found during the area scan of the applicable exposed region. SAR values were then calculated using a 3-D spline interpolation algorithm and averaged over spatial volumes of 1 and 10 grams.
- d. Due to the dimensions of the host Laptop PC a stack of low-density, low-loss dielectric foamed polystyrene was used in place of the device holder for this evaluation.

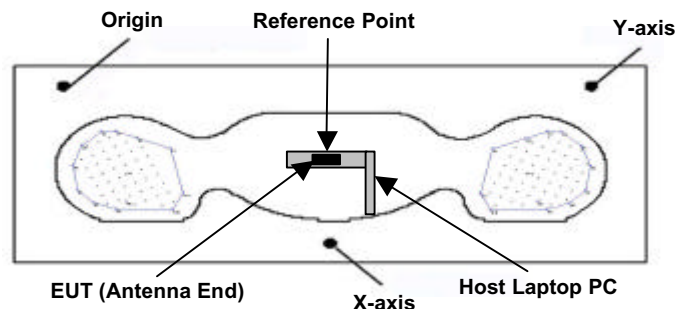

Figure 2. Phantom Reference Point & EUT Positioning  
 Left Side of Laptop PC - EUT Antenna Side

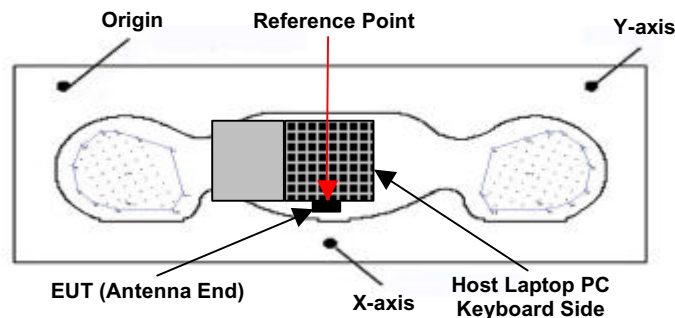

Figure 3. Phantom Reference Point & EUT Positioning  
 Keyboard Side of Laptop PC

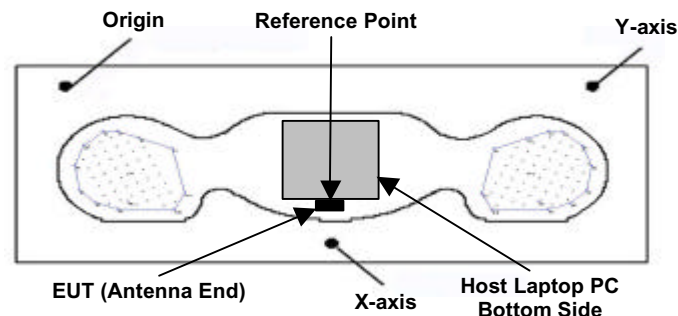

Figure 4. Phantom Reference Point & EUT Positioning  
 Bottom Side of Laptop PC

## 7.0 SYSTEM VALIDATION

Prior to the assessment the system was verified in the planar section of the SAM phantom with a 2450MHz dipole (see Appendix C for detailed dipole calibration procedures). The fluids were verified using an 85070C Dielectric Probe Kit and an 8753E Network Analyzer (see Appendix E for printout of measured fluid dielectric parameters). A forward power of 250 mW was applied to the dipole and system was verified to a tolerance of  $\pm 10\%$  (see Appendix B for system validation test plot).

SYSTEM VALIDATION											
Test Date	Equiv. Tissue	SAR 1g (W/kg)		Dielectric Constant $\epsilon_r$		Conductivity $\sigma$ (mho/m)		$\rho$ (Kg/m <sup>3</sup> )	Ambient Temp.	Fluid Temp.	Fluid Depth
		Target	Measured	Target	Measured	Target	Measured				
09/13/02	2450MHz (Brain)	14.2	15.5	39.2 $\pm 10\%$	36.7	1.80 $\pm 10\%$	1.88	1000	23.9 °C	22.7 °C	$\geq 15$ cm

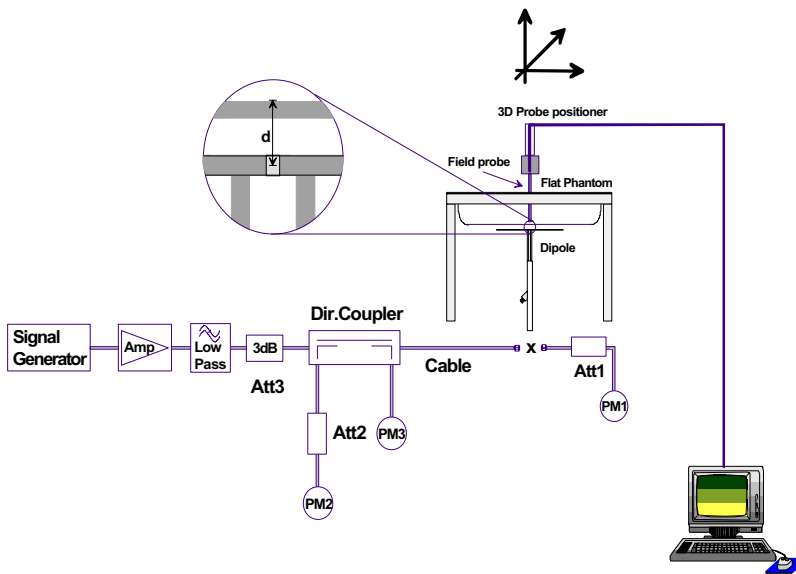

Figure 5. System Validation Setup Diagram



2450MHz Dipole Validation Setup



## 8.0 EQUIVALENT TISSUES

The 2450MHz brain and body mixtures consist of Glycol-monobutyl, water, and salt (body mixture only). The fluid was prepared according to standardized procedures and measured for dielectric parameters (permittivity and conductivity).

TISSUE MIXTURES		
INGREDIENT	2450MHz Brain Mixture (System Validation)	2450MHz Body Mixture (EUT Evaluation)
Water	55.20 %	69.95 %
Glycol Monobutyl	44.80 %	30.00 %
Salt	-	0.05 %

## 9.0 SAR SAFETY LIMITS

EXPOSURE LIMITS	SAR (W/Kg)	
	(General Population / Uncontrolled Exposure Environment)	(Occupational / Controlled Exposure Environment)
Spatial Average (averaged over the whole body)	0.08	0.4
Spatial Peak (averaged over any 1 g of tissue)	1.60	8.0
Spatial Peak (hands/wrists/feet/ankles averaged over 10 g)	4.0	20.0

**Notes:**

1. Uncontrolled environments are defined as locations where there is potential exposure of individuals who have no knowledge or control of their potential exposure.
2. Controlled environments are defined as locations where there is potential exposure of individuals who have knowledge of their potential exposure and can exercise control over their exposure.

---

## 10.0 ROBOT SYSTEM SPECIFICATIONS

### Specifications

**POSITIONER:** Stäubli Unimation Corp. Robot Model: RX60L  
**Repeatability:** 0.02 mm  
**No. of axis:** 6

### Data Acquisition Electronic (DAE) System

#### Cell Controller

**Processor:** Pentium III  
**Clock Speed:** 450 MHz  
**Operating System:** Windows NT  
**Data Card:** DASY3 PC-Board

#### Data Converter

**Features:** Signal Amplifier, multiplexer, A/D converter, and control logic  
**Software:** DASY3 software  
**Connecting Lines:** Optical downlink for data and status info.  
Optical uplink for commands and clock

### PC Interface Card

**Function:** 24 bit (64 MHz) DSP for real time processing  
Link to DAE3  
16-bit A/D converter for surface detection system  
serial link to robot  
direct emergency stop output for robot

### E-Field Probe

**Model:** ET3DV6  
**Serial No.:** 1387  
**Construction:** Triangular core fiber optic detection system  
**Frequency:** 10 MHz to 6 GHz  
**Linearity:**  $\pm 0.2$  dB (30 MHz to 3 GHz)

### Phantom

**Type:** SAM V4.0C  
**Shell Material:** Fiberglass  
**Thickness:** 2.0  $\pm$  0.1 mm  
**Volume:** Approx. 20 liters

## 11.0 PROBE SPECIFICATION (ET3DV6)

Construction:	Symmetrical design with triangular core Built-in shielding against static charges PEEK enclosure material (resistant to organic solvents, e.g. glycol)
Calibration:	In air from 10 MHz to 2.5 GHz In brain simulating tissue at frequencies of 900 MHz and 1.8 GHz (accuracy $\pm 8\%$ )
Frequency:	10 MHz to >6 GHz; Linearity: $\pm 0.2$ dB (30 MHz to 3 GHz)
Directivity:	$\pm 0.2$ dB in brain tissue (rotation around probe axis) $\pm 0.4$ dB in brain tissue (rotation normal to probe axis)
Dynam. Rnge:	5 $\mu$ W/g to >100 mW/g; Linearity: $\pm 0.2$ dB
Srfce. Detect.	$\pm 0.2$ mm repeatability in air and clear liquids over diffuse reflecting surfaces
Dimensions:	Overall length: 330 mm Tip length: 16 mm Body diameter: 12 mm Tip diameter: 6.8 mm Distance from probe tip to dipole centers: 2.7 mm
Application:	General dosimetry up to 3 GHz Compliance tests of mobile phone



ET3DV6 E-Field Probe

## 12.0 SAM PHANTOM V4.0C

The SAM phantom V4.0C is a fiberglass shell phantom with a 2.0 mm shell thickness for left and right head and flat planar area integrated in a wooden table. The shape of the fiberglass shell corresponds to the phantom defined by SCC34-SC2. The device holder positions are adjusted to the standard measurement positions in the three sections.



SAM Phantom

## 13.0 DEVICE HOLDER

The DASY3 device holder has two scales for device rotation (with respect to the body axis) and the device inclination (with respect to the line between the ear openings). The plane between the ear openings and the mouth tip has a rotation angle of  $65^\circ$ . The bottom plate contains three pair of bolts for locking the device holder. The device holder positions are adjusted to the standard measurement positions in the three sections.



Device Holder

## 14.0 TEST EQUIPMENT LIST

<b>SAR MEASUREMENT SYSTEM</b>		
<b>EQUIPMENT</b>	<b>SERIAL NO.</b>	<b>CALIBRATION DATE</b>
<b>DASY3 System</b> -Robot -ET3DV6 E-Field Probe -300MHz Validation Dipole -450MHz Validation Dipole -900MHz Validation Dipole -1800MHz Validation Dipole -2450MHz Validation Dipole -SAM Phantom V4.0C -Small Planar Phantom -Large Planar Phantom	599396-01 1387 135 136 054 247 150 N/A N/A N/A	N/A Feb 2002 Oct 2001 Oct 2001 June 2001 June 2001 Oct 2001 N/A N/A N/A
<b>85070C Dielectric Probe Kit</b>	N/A	N/A
<b>Gigatronics 8652A Power Meter</b> -Power Sensor 80701A -Power Sensor 80701A	1835272 1833535 1833542	Feb 2002 Feb 2002 Mar 2002
<b>E4408B Spectrum Analyzer</b>	US39240170	Nov 2001
<b>8594E Spectrum Analyzer</b>	3543A02721	Feb 2002
<b>8753E Network Analyzer</b>	US38433013	Feb 2002
<b>8648D Signal Generator</b>	3847A00611	Feb 2002
<b>5S1G4 Amplifier Research Power Amplifier</b>	26235	N/A

## 15.0 MEASUREMENT UNCERTAINTIES

Error Description	Uncertainty Value ±%	Probability Distribution	Divisor	$C_i$ 1g	Standard Uncertainty ±% (1g)	$v_i$ or $v_{eff}$
<b>Measurement System</b>						
Probe calibration	± 4.8	Normal	1	1	± 4.8	∞
Axial isotropy of the probe	± 4.7	Rectangular	√3	(1- $C_p$ )	± 1.9	∞
Spherical isotropy of the probe	± 9.6	Rectangular	√3	( $C_p$ )	± 3.9	∞
Spatial resolution	± 0.0	Rectangular	√3	1	± 0.0	∞
Boundary effects	± 5.5	Rectangular	√3	1	± 3.2	∞
Probe linearity	± 4.7	Rectangular	√3	1	± 2.7	∞
Detection limit	± 1.0	Rectangular	√3	1	± 0.6	∞
Readout electronics	± 1.0	Normal	1	1	± 1.0	∞
Response time	± 0.8	Rectangular	√3	1	± 0.5	∞
Integration time	± 1.4	Rectangular	√3	1	± 0.8	∞
RF ambient conditions	± 3.0	Rectangular	√3	1	± 1.7	∞
Mech. constraints of robot	± 0.4	Rectangular	√3	1	± 0.2	∞
Probe positioning	± 2.9	Rectangular	√3	1	± 1.7	∞
Extrapolation & integration	± 3.9	Rectangular	√3	1	± 2.3	∞
<b>Test Sample Related</b>						
Device positioning	± 6.0	Normal	√3	1	± 6.7	12
Device holder uncertainty	± 5.0	Normal	√3	1	± 5.9	8
Power drift	± 5.0	Rectangular	√3		± 2.9	∞
<b>Phantom and Setup</b>						
Phantom uncertainty	± 4.0	Rectangular	√3	1	± 2.3	∞
Liquid conductivity (target)	± 5.0	Rectangular	√3	0.6	± 1.7	∞
Liquid conductivity (measured)	± 10.0	Rectangular	√3	0.6	± 3.5	∞
Liquid permittivity (target)	± 5.0	Rectangular	√3	0.6	± 1.7	∞
Liquid permittivity (measured)	± 5.0	Rectangular	√3	0.6	± 1.7	∞
<b>Combined Standard Uncertainty</b>					<b>± 13.7</b>	
<b>Expanded Uncertainty (k=2)</b>					<b>± 27.5</b>	

Measurement Uncertainty Table in accordance with IEEE Std 1528 (Draft - see Reference [3])

## 16.0 REFERENCES

- [1] Federal Communications Commission, "Radiofrequency radiation exposure evaluation: portable devices", Rule Part 47 CFR §2.1093: 1999.
- [2] Federal Communications Commission, "Evaluating Compliance with FCC Guidelines for Human Exposure to Radio frequency Electromagnetic Fields", OET Bulletin 65, Supplement C (Edition 01-01), FCC, Washington, D.C.: June 2001.
- [3] IEEE Standards Coordinating Committee 34, Std 1528-200X, "DRAFT Recommended Practice for Determining the Spatial-Peak Specific Absorption Rate (SAR) in the Human Body Due to Wireless Communications Devices: Experimental Techniques".



## APPENDIX A - SAR MEASUREMENT DATA

# The Linksys Group Inc. FCC ID: PKW-NWP11B

SAM Phantom; Flat Section; Position: (90°, 180°)  
Probe: ET3DV6 - SN1387; ConvF(4.30,4.30,4.30); Crest factor: 1.0  
2450 MHz Muscle:  $\sigma = 2.01 \text{ mho/m}$ ,  $\epsilon_r = 51.1$ ,  $\rho = 1.00 \text{ g/cm}^3$   
Coarse: Dx = 15.0, Dy = 15.0, Dz = 10.0  
Cube 5x5x7; Powerdrift: -0.18 dB  
SAR (1g): 0.653 mW/g, SAR (10g): 0.372 mW/g

Body SAR - Keyboard Side of Laptop PC - EUT in Top PCMCIA Slot  
0.0 cm Separation Distance (Laptop Keyboard to Phantom)  
NWP11B DSSS Wireless Notebook Adapter for Laptop PC  
DSSS Mode (Constant Transmit)  
Low Channel [2412 MHz]  
Conducted Power: 17.99 dBm  
Ambient Temp: 23.9°C; Fluid Temp: 22.7°C  
Date Tested: September 13, 2002

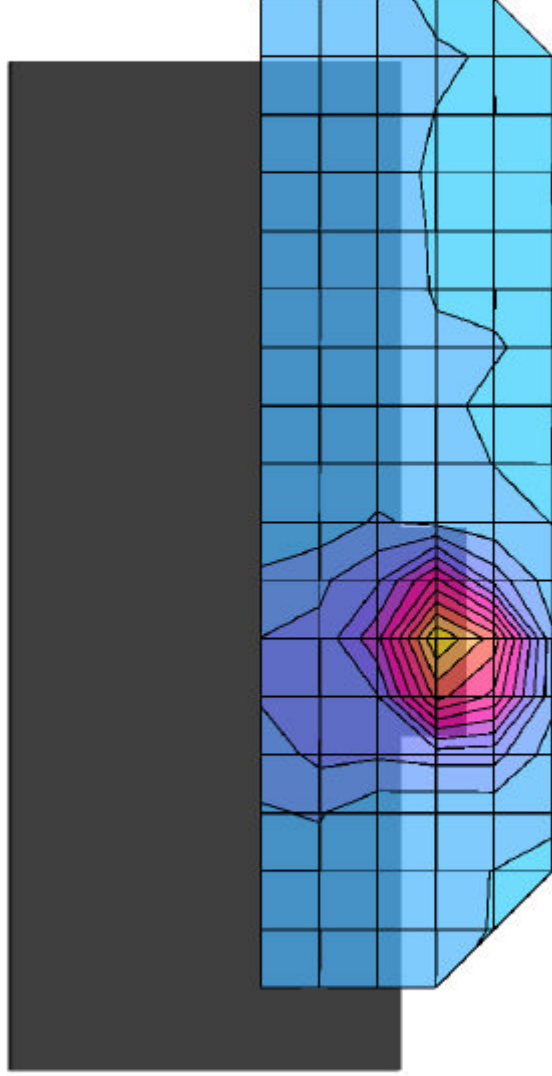

# The Linksys Group Inc. FCC ID: PKW-NWP11B

SAM Phantom; Flat Section; Position: (90°, 180°)  
Probe: ET3DV6 - SN1387; ConvF(4.30,4.30,4.30); Crest factor: 1.0  
2450 MHz Muscle:  $\sigma = 2.01 \text{ mho/m}$ ,  $\epsilon_r = 51.1$ ,  $\rho = 1.00 \text{ g/cm}^3$   
Coarse: Dx = 15.0, Dy = 15.0, Dz = 10.0  
Cube 5x5x7; Powerdrift: -0.15 dB  
SAR (1g): 0.675 mW/g, SAR (10g): 0.373 mW/g

Body SAR - Keyboard Side of Laptop PC - EUT in Top PCMCIA Slot  
0.0 cm Separation Distance (Laptop Keyboard to Phantom)  
NWP11B DSSS Wireless Notebook Adapter for Laptop PC  
DSSS Mode (Constant Transmit)  
Mid Channel [2437 MHz]  
Conducted Power: 17.54 dBm  
Ambient Temp: 23.9°C; Fluid Temp: 22.7°C  
Date Tested: September 13, 2002

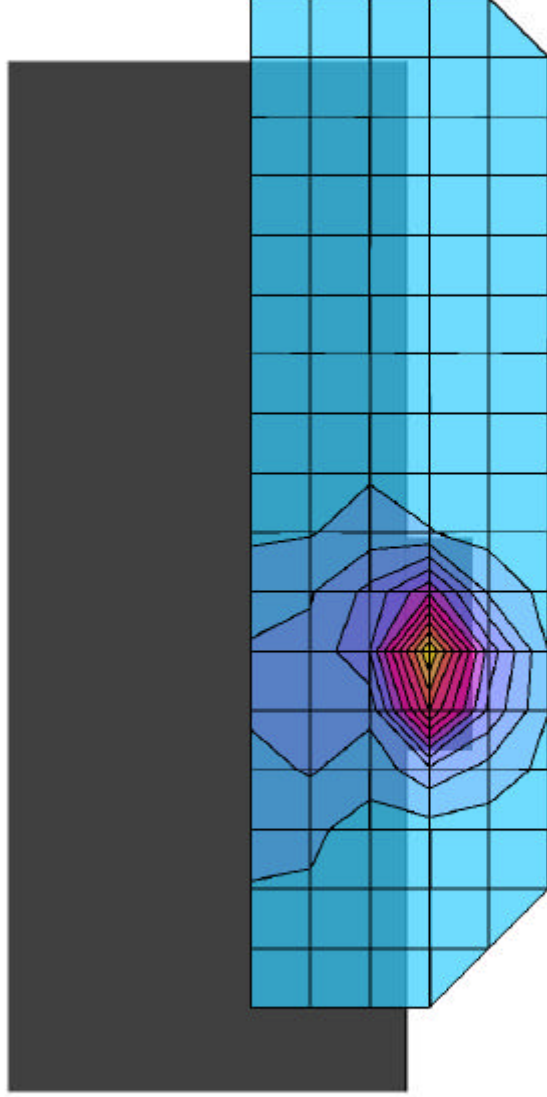

# The Linksys Group Inc. FCC ID: PKW-NWP11B

SAM Phantom; Flat Section; Position: (90°, 180°)  
Probe: ET3DV6 - SN1387; ConvF(4.30,4.30,4.30); Crest factor: 1.0  
2450 MHz Muscle:  $\sigma = 2.01 \text{ mho/m}$ ,  $\epsilon_r = 51.1$ ,  $\rho = 1.00 \text{ g/cm}^3$   
Coarse: Dx = 15.0, Dy = 15.0, Dz = 10.0  
Cube 5x5x7; Powerdrift: -0.08 dB  
SAR (1g): 0.665 mW/g, SAR (10g): 0.375 mW/g

Body SAR - Keyboard Side of Laptop PC - EUT in Top PCMCIA Slot  
0.0 cm Separation Distance (Laptop Keyboard to Phantom)  
NWP11B DSSS Wireless Notebook Adapter for Laptop PC  
DSSS Mode (Constant Transmit)  
High Channel [2462 MHz]  
Conducted Power: 16.87 dBm  
Ambient Temp: 23.9°C; Fluid Temp: 22.7°C  
Date Tested: September 13, 2002

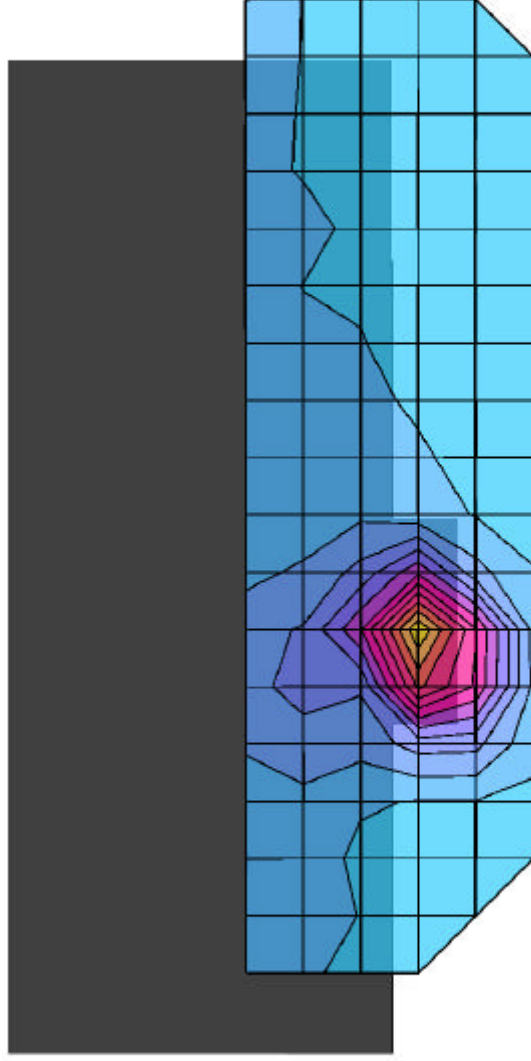

# The Linksys Group Inc. FCC ID: PKW-NWP11B

SAM Phantom; Flat Section; Position: (90°, 180°)  
Probe: ET3DV6 - SN1387; ConvF(4.30,4.30,4.30); Crest factor: 1.0  
2450 MHz Muscle:  $\sigma = 2.01 \text{ mho/m}$ ,  $\epsilon_r = 51.1$ ,  $\rho = 1.00 \text{ g/cm}^3$   
Coarse: Dx = 15.0, Dy = 15.0, Dz = 10.0  
Cube 5x5x7; Powerdrift: -0.13 dB  
SAR (1g): 0.989 mW/g, SAR (10g): 0.549 mW/g

Body SAR - Bottom of Laptop PC - EUT in Bottom PCMCIA Slot  
0.0 cm Separation Distance (Bottom of Laptop to Phantom)  
NWP11B DSSS Wireless Notebook Adapter for Laptop PC  
DSSS Mode (Constant Transmit)  
Low Channel [2412 MHz]  
Conducted Power: 17.99 dBm  
Ambient Temp: 23.9°C; Fluid Temp: 22.7°C  
Date Tested: September 13, 2002

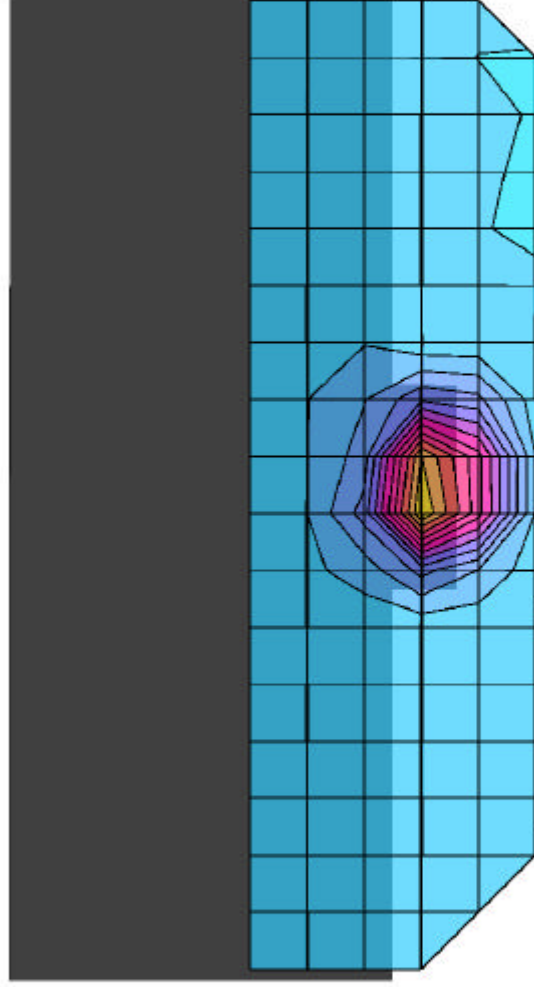

# The Linksys Group Inc. FCC ID: PKW-NWP11B

SAM Phantom; Flat Section

Probe: ET3DV6 - SN1387; ConvF(4.30,4.30,4.30); Crest factor: 1.0  
2450 MHz Muscle:  $\sigma = 2.01 \text{ mho/m}$   $\epsilon_r = 51.1$   $\rho = 1.00 \text{ g/cm}^3$

## Z-Axis Extrapolation at Peak SAR Location

Body SAR - Bottom of Laptop PC - EUT in Bottom PCMCIA Slot  
0.0 cm Separation Distance (Bottom of Laptop to Phantom)  
NWP11B DSSS Wireless Notebook Adapter for Laptop PC  
DSSS Mode (Constant Transmit)

Low Channel [2412 MHz]

Conducted Power: 17.99 dBm

Ambient Temp: 23.9°C; Fluid Temp: 22.7°C

Date Tested: September 13, 2002

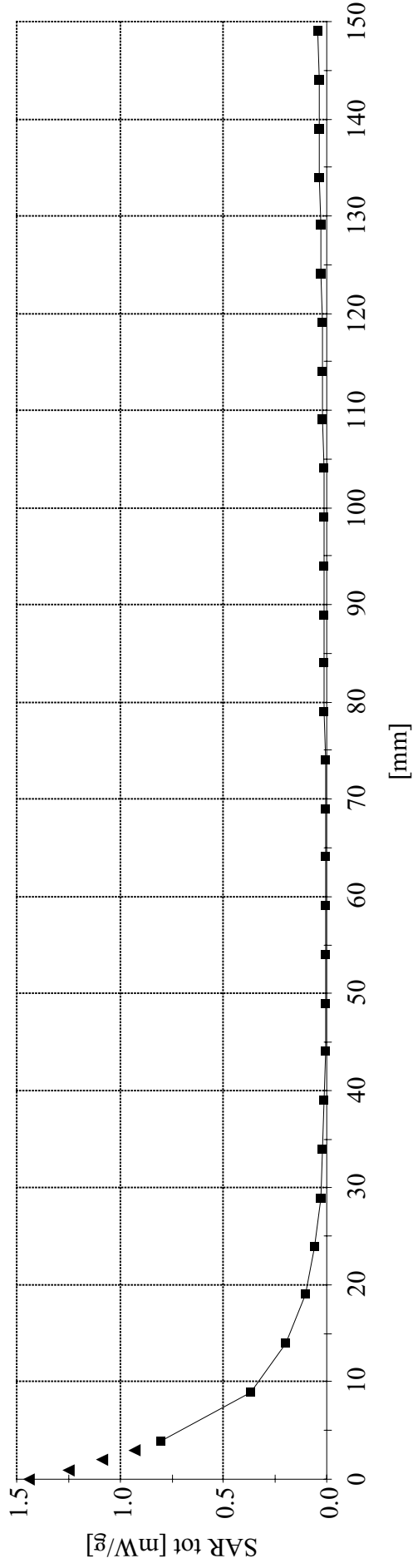



# The Linksys Group Inc. FCC ID: PKW-NWP11B

SAM Phantom; Flat Section; Position: (90°, 180°)  
Probe: ET3DV6 - SN1387; ConvF(4.30,4.30,4.30); Crest factor: 1.0  
2450 MHz Muscle:  $\sigma = 2.01 \text{ mho/m}$ ,  $\epsilon_r = 51.1$ ,  $\rho = 1.00 \text{ g/cm}^3$   
Coarse: Dx = 15.0, Dy = 15.0, Dz = 10.0  
Cube 5x5x7; Powerdrift: -0.18 dB  
SAR (1g): 0.892 mW/g, SAR (10g): 0.506 mW/g

Body SAR - Bottom of Laptop PC - EUT in Bottom PCMCIA Slot  
0.0 cm Separation Distance (Bottom of Laptop to Phantom)  
NWP11B DSSS Wireless Notebook Adapter for Laptop PC  
DSSS Mode (Constant Transmit)  
Mid Channel [2437 MHz]  
Conducted Power: 17.54 dBm  
Ambient Temp: 23.9°C; Fluid Temp: 22.7°C  
Date Tested: September 13, 2002

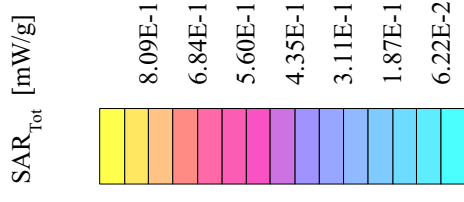
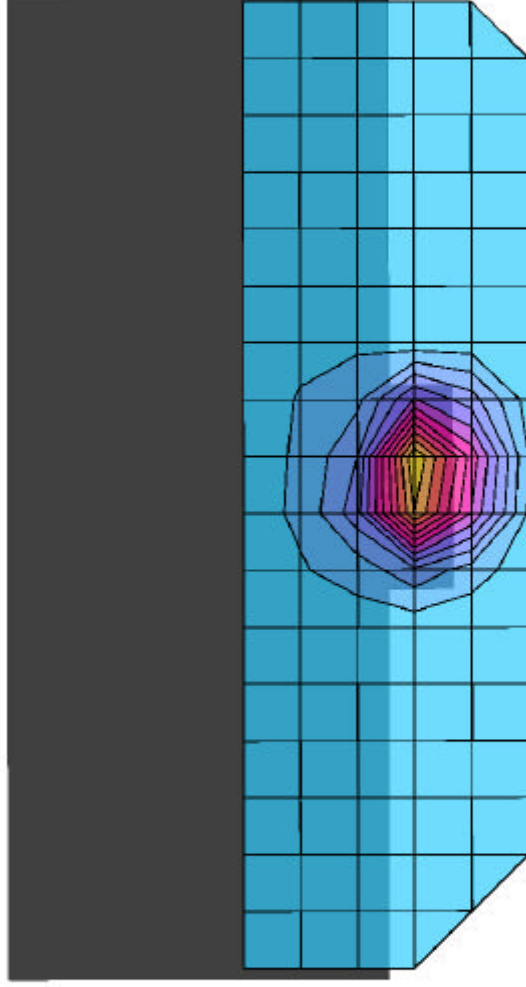

# The Linksys Group Inc. FCC ID: PKW-NWP11B

SAM Phantom; Flat Section; Position: (90°, 180°)  
Probe: ET3DV6 - SN1387; ConvF(4.30,4.30,4.30); Crest factor: 1.0  
2450 MHz Muscle:  $\sigma = 2.01 \text{ mho/m}$ ,  $\epsilon_r = 51.1$ ,  $\rho = 1.00 \text{ g/cm}^3$   
Coarse: Dx = 15.0, Dy = 15.0, Dz = 10.0  
Cube 5x5x7; Powerdrift: -0.15 dB  
SAR (1g): 0.941 mW/g, SAR (10g): 0.526 mW/g

Body SAR - Bottom of Laptop PC - EUT in Bottom PCMCIA Slot  
0.0 cm Separation Distance (Bottom of Laptop to Phantom)  
NWP11B DSSS Wireless Notebook Adapter for Laptop PC  
DSSS Mode (Constant Transmit)  
High Channel [2462 MHz]  
Conducted Power: 16.87 dBm  
Ambient Temp: 23.9°C; Fluid Temp: 22.7°C  
Date Tested: September 13, 2002

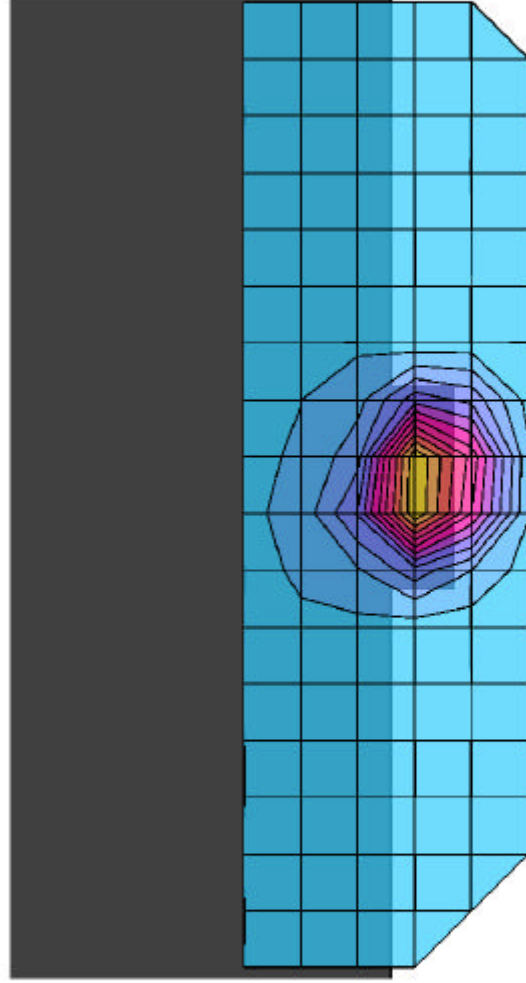

# The Linksys Group Inc. FCC ID: PKW-NWP11B

SAM Phantom; Flat Section; Position: (180°,180°)  
Probe: ET3DV6 - SN1387; ConvF(4.30,4.30,4.30); Crest factor: 1.0  
2450 MHz Muscle:  $\sigma = 2.01 \text{ mho/m}$ ,  $\epsilon_r = 51.1$ ,  $\rho = 1.00 \text{ g/cm}^3$   
Coarse: Dx = 15.0, Dy = 15.0, Dz = 10.0  
Cube 5x5x7; Powerdrift: -0.12 dB  
SAR (1g): 0.401 mW/g, SAR (10g): 0.214 mW/g

Body SAR - Left Side of Laptop PC - EUT in Bottom PCMCIA Slot  
1.5 cm Separation Distance (EUT Antenna to Phantom)  
NWP11B DSSS Wireless Notebook Adapter for Laptop PC  
DSSS Mode (Constant Transmit)  
Low Channel [2412 MHz]  
Conducted Power: 17.99 dBm  
Ambient Temp: 23.9°C; Fluid Temp: 22.7°C  
Date Tested: September 13, 2002

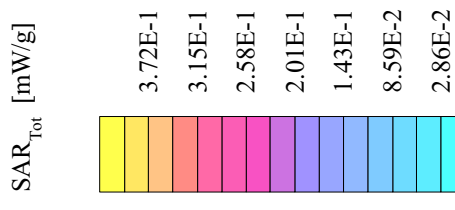
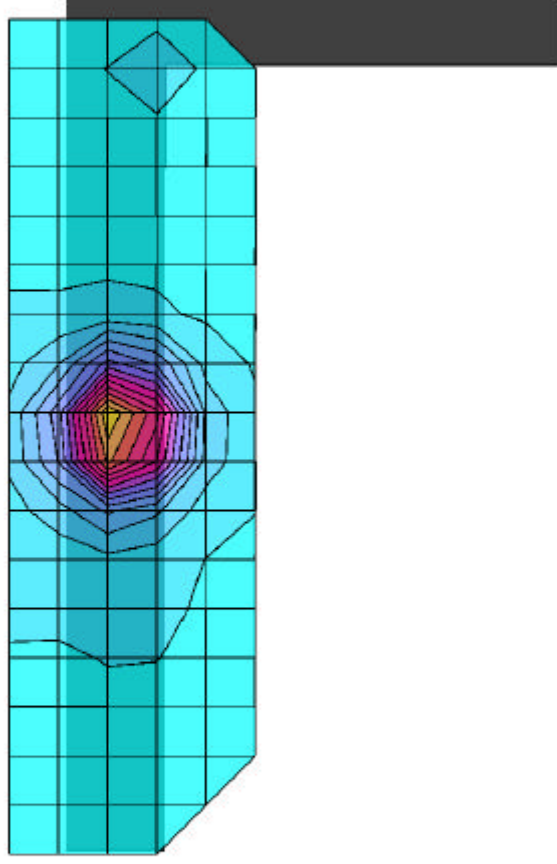

# The Linksys Group Inc. FCC ID: PKW-NWP11B

SAM Phantom; Flat Section; Position: (180°,180°)  
Probe: ET3DV6 - SN1387; ConvF(4.30,4.30,4.30); Crest factor: 1.0  
2450 MHz Muscle:  $\sigma = 2.01 \text{ mho/m}$ ,  $\epsilon_r = 51.1$ ,  $\rho = 1.00 \text{ g/cm}^3$   
Coarse: Dx = 15.0, Dy = 15.0, Dz = 10.0  
Cube 5x5x7; Powerdrift: -0.08 dB  
SAR (1g): 0.375 mW/g, SAR (10g): 0.204 mW/g

Body SAR - Left Side of Laptop PC - EUT in Bottom PCMCIA Slot  
1.5 cm Separation Distance (EUT Antenna to Phantom)  
NWP11B DSSS Wireless Notebook Adapter for Laptop PC  
DSSS Mode (Constant Transmit)  
Mid Channel [2437 MHz]  
Conducted Power: 17.54 dBm  
Ambient Temp: 23.9°C; Fluid Temp: 22.7°C  
Date Tested: September 13, 2002

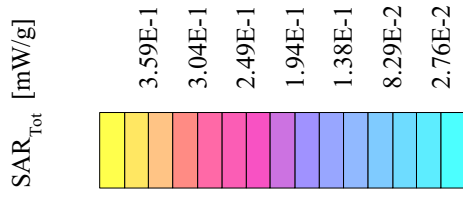
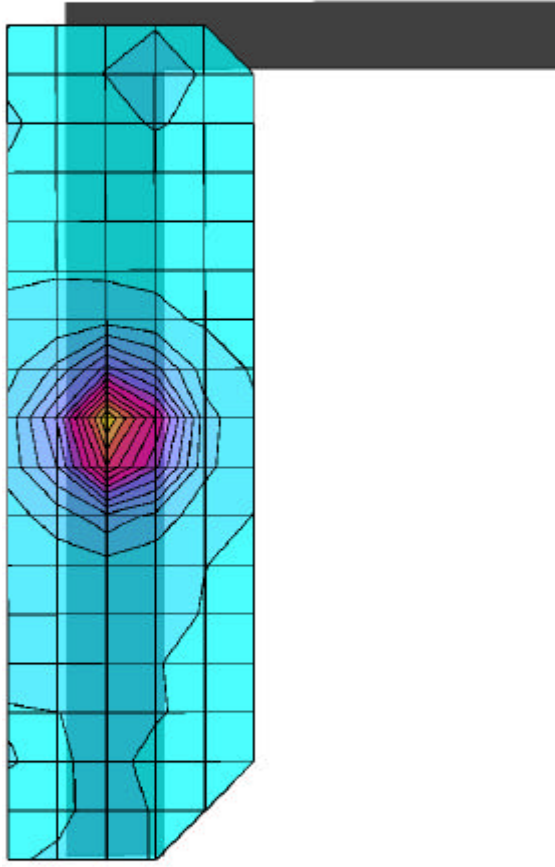

# The Linksys Group Inc. FCC ID: PKW-NWP11B

SAM Phantom; Flat Section; Position: (180°,180°)  
Probe: ET3DV6 - SN1387; ConvF(4.30,4.30,4.30); Crest factor: 1.0  
2450 MHz Muscle:  $\sigma = 2.01 \text{ mho/m}$ ,  $\epsilon_r = 51.1$ ,  $\rho = 1.00 \text{ g/cm}^3$   
Coarse: Dx = 15.0, Dy = 15.0, Dz = 10.0  
Cube 5x5x7; Powerdrift: -0.16 dB  
SAR (1g): 0.344 mW/g, SAR (10g): 0.187 mW/g

Body SAR - Left Side of Laptop PC - EUT in Bottom PCMCIA Slot  
1.5 cm Separation Distance (EUT Antenna to Phantom)  
NWP11B DSSS Wireless Notebook Adapter for Laptop PC  
DSSS Mode (Constant Transmit)  
High Channel [2462 MHz]  
Conducted Power: 16.87 dBm  
Ambient Temp: 23.9°C; Fluid Temp: 22.7°C  
Date Tested: September 13, 2002

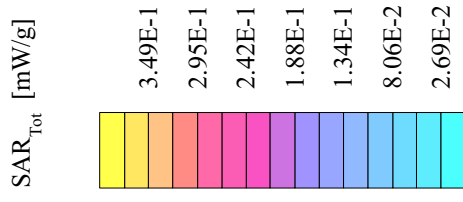
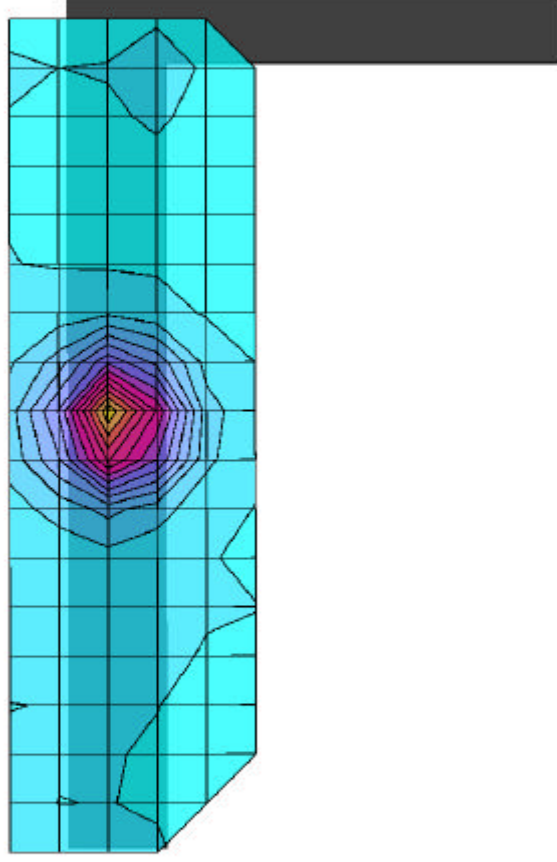

## **APPENDIX B - SYSTEM VALIDATION**



# Dipole 2450MHz

SAM Phantom; Flat Section

Probe: ET3DV6 - SNI387; ConvF(4.70,4.70,4.70); Crest factor: 1.0; 2450 MHz Brain:  $\sigma = 1.88$  mho/m  $\epsilon_r = 36.7$   $\rho = 1.00$  g/cm<sup>3</sup>

Cube 5x5x7; Peak: 33.4 mW/g, SAR (1g): 15.5 mW/g, SAR (10g): 6.99 mW/g, (Worst-case extrapolation)

Penetration depth: 6.1 (5.8, 6.7) [mm]; Ambient Temp: 23.9°C; Fluid Temp: 22.7°C

Powerdrift: -0.03 dB

Conducted Power: 250mW

Validation Date: September 13, 2002

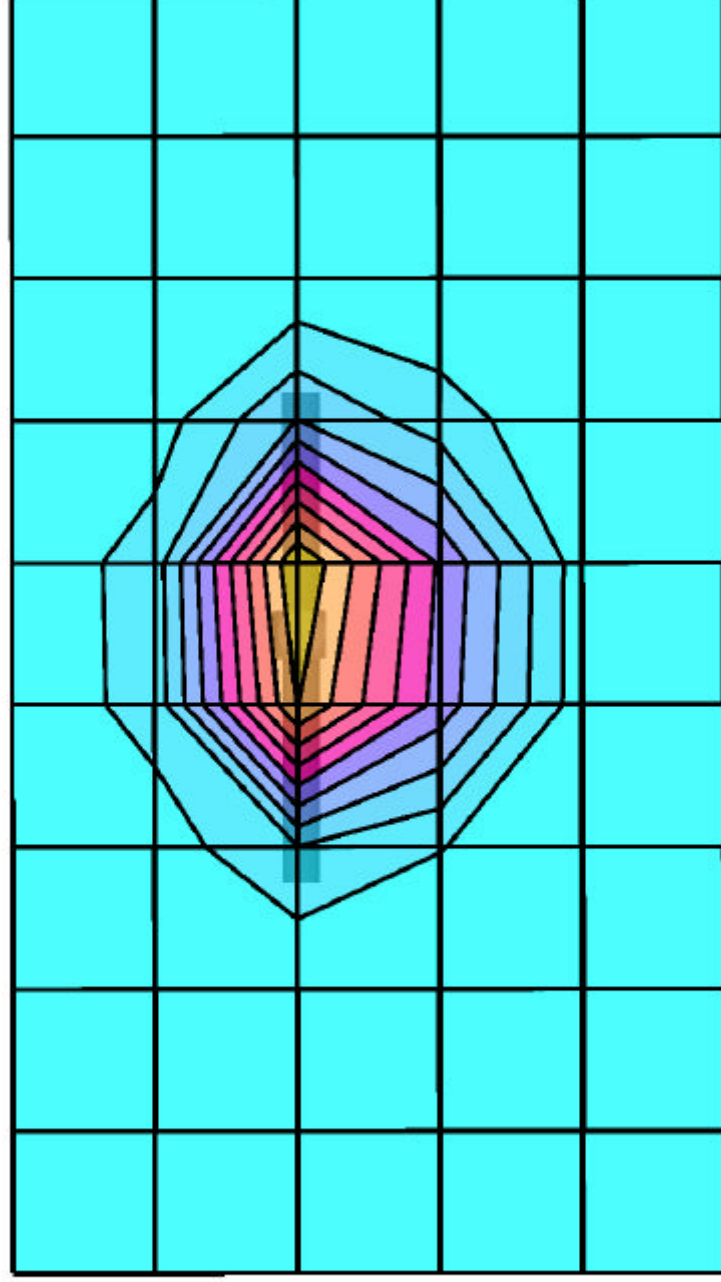

SAR<sub>tot</sub> [mW/g]



## APPENDIX C - DIPOLE CALIBRATION

## 2450MHz SYSTEM VALIDATION DIPOLE

Type:

2450MHz Validation Dipole

Serial Number:

150

Place of Calibration:

Celltech Research Inc.

Date of Calibration:

October 24, 2001

Celltech Research Inc. hereby certifies that this device has been calibrated on the date indicated above.

Calibrated by:



Approved by:

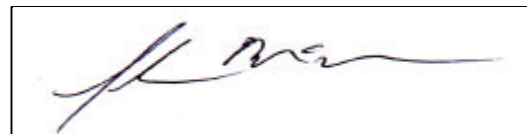

## 1. Dipole Construction & Electrical Characteristics

The validation dipole was constructed in accordance with the IEEE Std "Recommended Practice for Determining the Spatial-Peak Specific Absorption Rate (SAR) in the Human Body Due to Wireless Communications Devices: Experimental Techniques". The electrical properties were measured using an HP 8753E Network Analyzer. The network analyzer was calibrated to the validation dipole N-type connector feed point using an HP85032E Type N calibration kit. The dipole was placed parallel to a planar phantom at a separation distance of 10.0mm from the simulating fluid using a loss-less dielectric spacer. The measured input impedance is:

Feed point impedance at 2450MHz	$\text{Re}\{Z\} = 49.268\Omega$ $\text{Im}\{Z\} = 0.4121\Omega$
Return Loss at 2450MHz	-40.897dB

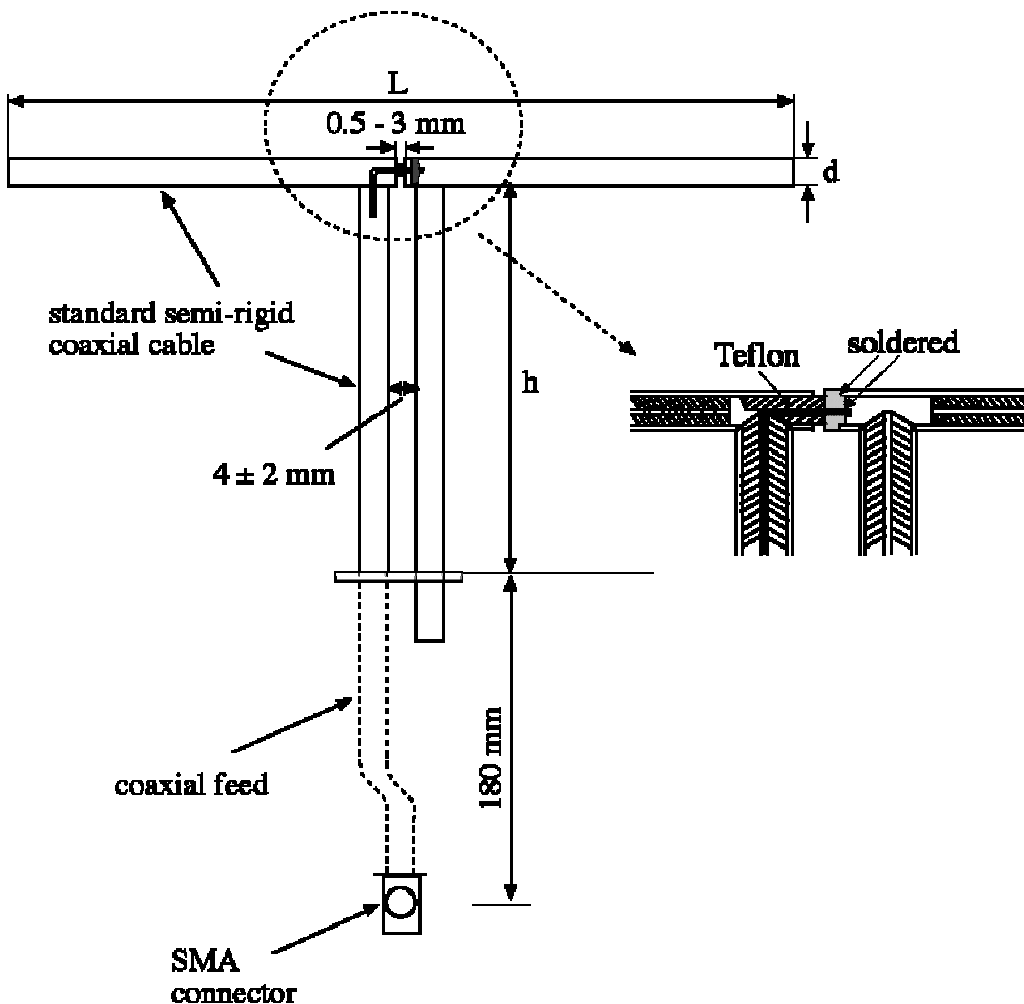

9 Nov 2001 09:52:05

CH1 S11 LOG 10 dB/REF 0 dB 1:-40.897 dB 2:450.000 000 MHz

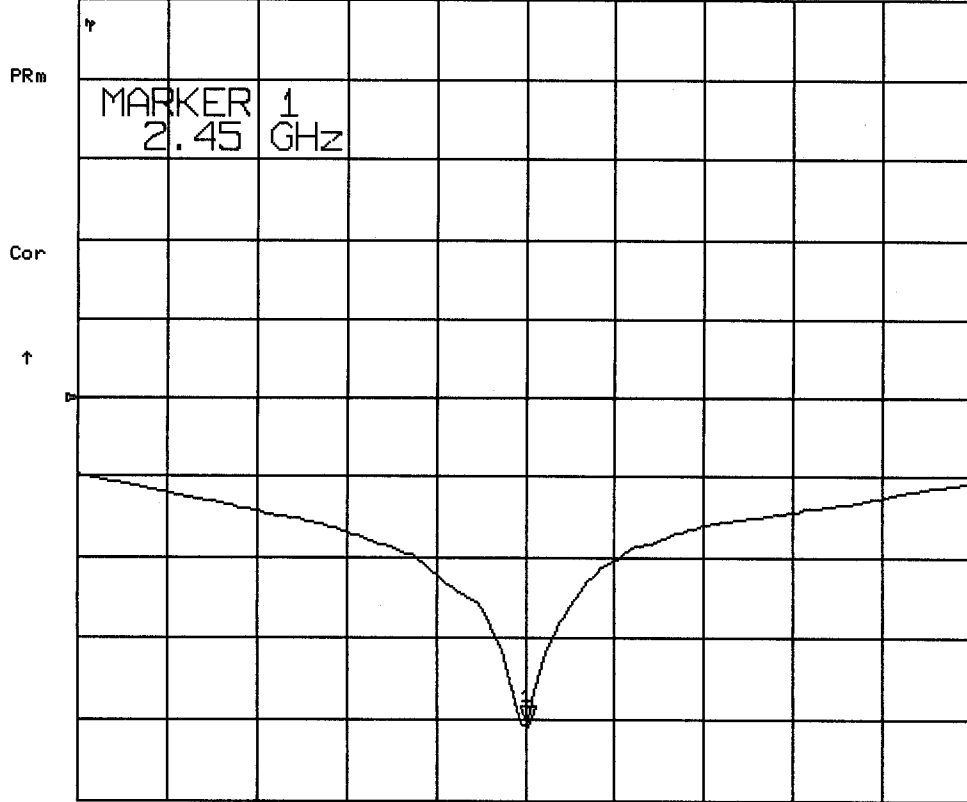

START 2 250.000 000 MHz

STOP 2 650.000 000 MHz

9 Nov 2001 09:52:18

CH1 S11 1 U FS 1: 49.268  $\Omega$  0.4121  $\Omega$  26.771 pH 2 450.000 000 MHz

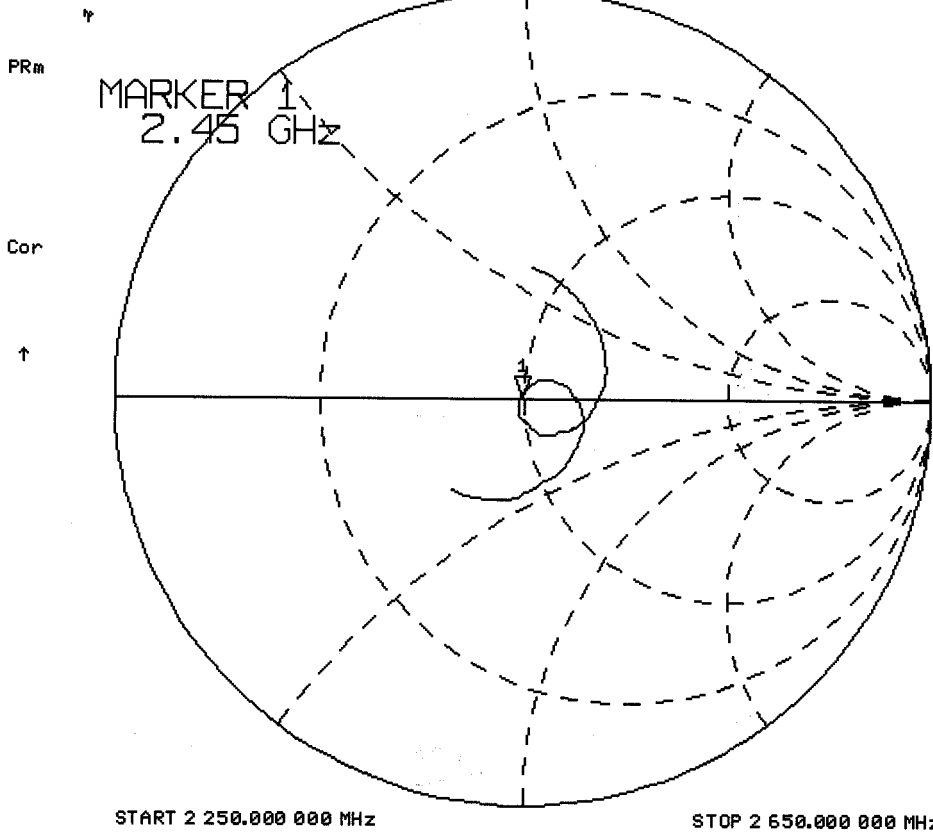

## Validation Dipole Dimensions

Frequency (MHz)	L (mm)	h (mm)	d (mm)
300	420.0	250.0	6.2
450	288.0	167.0	6.2
835	161.0	89.8	3.6
900	149.0	83.3	3.6
1450	89.1	51.7	3.6
1800	72.0	41.7	3.6
1900	68.0	39.5	3.6
2000	64.5	37.5	3.6
2450	51.8	30.6	3.6
3000	41.5	25.0	3.6

## 2. Validation Phantom

The validation phantom is the SAM (Specific Anthropomorphic Mannequin) phantom manufactured by Schmid & Partner Engineering AG. The SAM phantom is a Fiberglass shell integrated in a wooden table. The shape of the shell corresponds to the phantom defined by SCC34-SC2. It enables the dosimetric evaluation of left and right hand phone usage as well as body mounted usage at the flat phantom region. A cover prevents evaporation of the liquid. Reference markings on the phantom allow the complete setup of all predefined phantom positions and measurement grids by manually teaching three points in the robot.

**Shell Thickness:**  $2 \pm 0.1$  mm  
**Filling Volume:** Approx. 20 liters  
**Dimensions:** 50 cm (W) x 100 cm (L)

# SAM Twin-Phantom

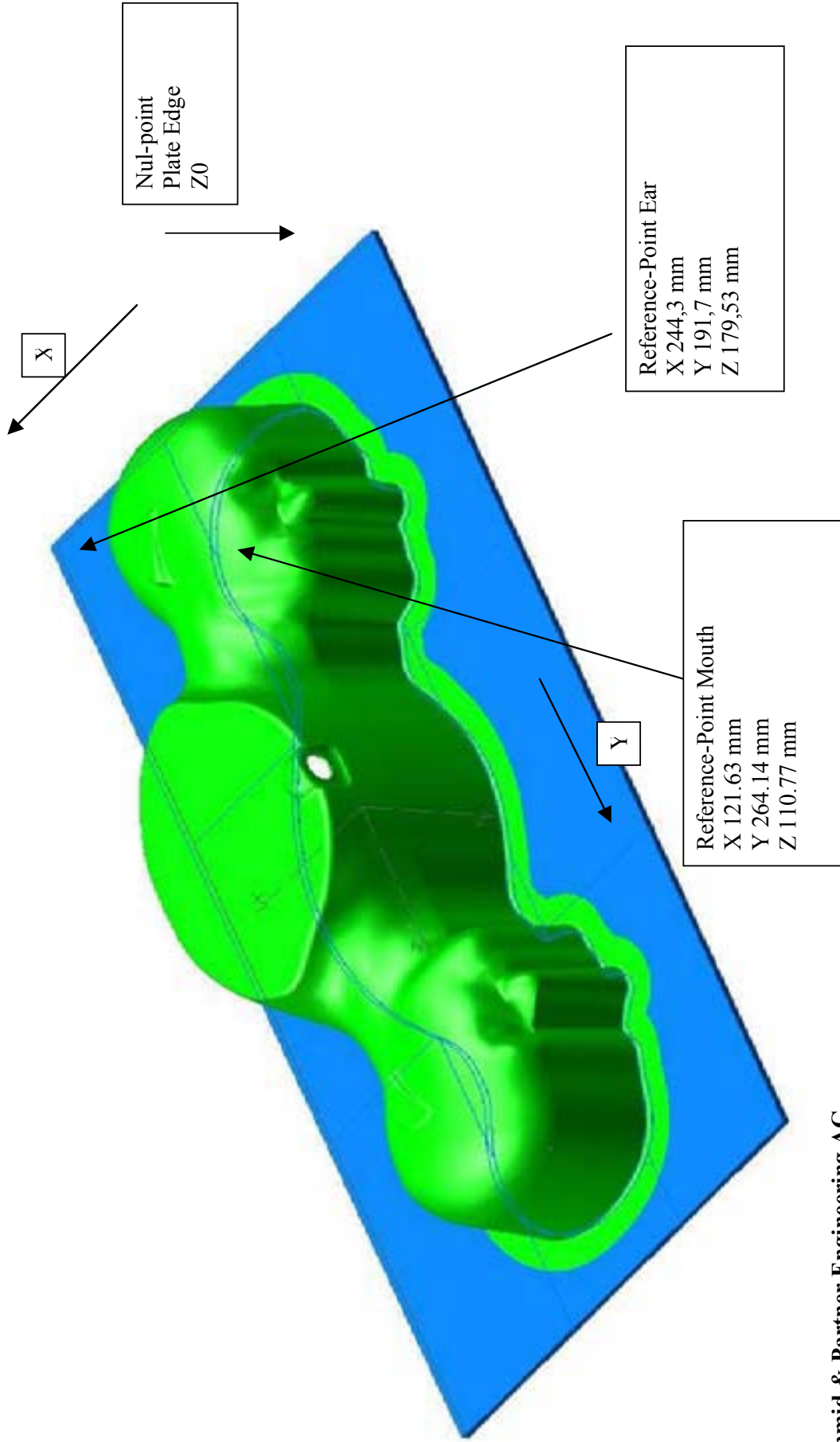



## 2450MHz Dipole Calibration



## 2450MHz Dipole Calibration



### **3. Measurement Conditions**

The planar phantom was filled with brain simulating tissue having the following electrical parameters at 2450MHz:

Relative Permittivity:	39.2	± 5%
Conductivity:	1.80 mho/m	± 5%
Temperature:	23.1°C	

The 2450MHz simulating tissue consists of the following ingredients:

<b>Ingredient</b>	<b>Percentage by weight</b>
Water	55.20 %
Glycol Monobutyl	44.80 %
Target Dielectric Parameters at 22°C	$\epsilon_r = 39.2$ $\sigma = 1.80 \text{ S/m}$

#### 4. SAR Measurement

The SAR measurement was performed with the E-field probe in mechanical detection mode only. The setup and determination of the forward power into the dipole was performed using the following procedures.

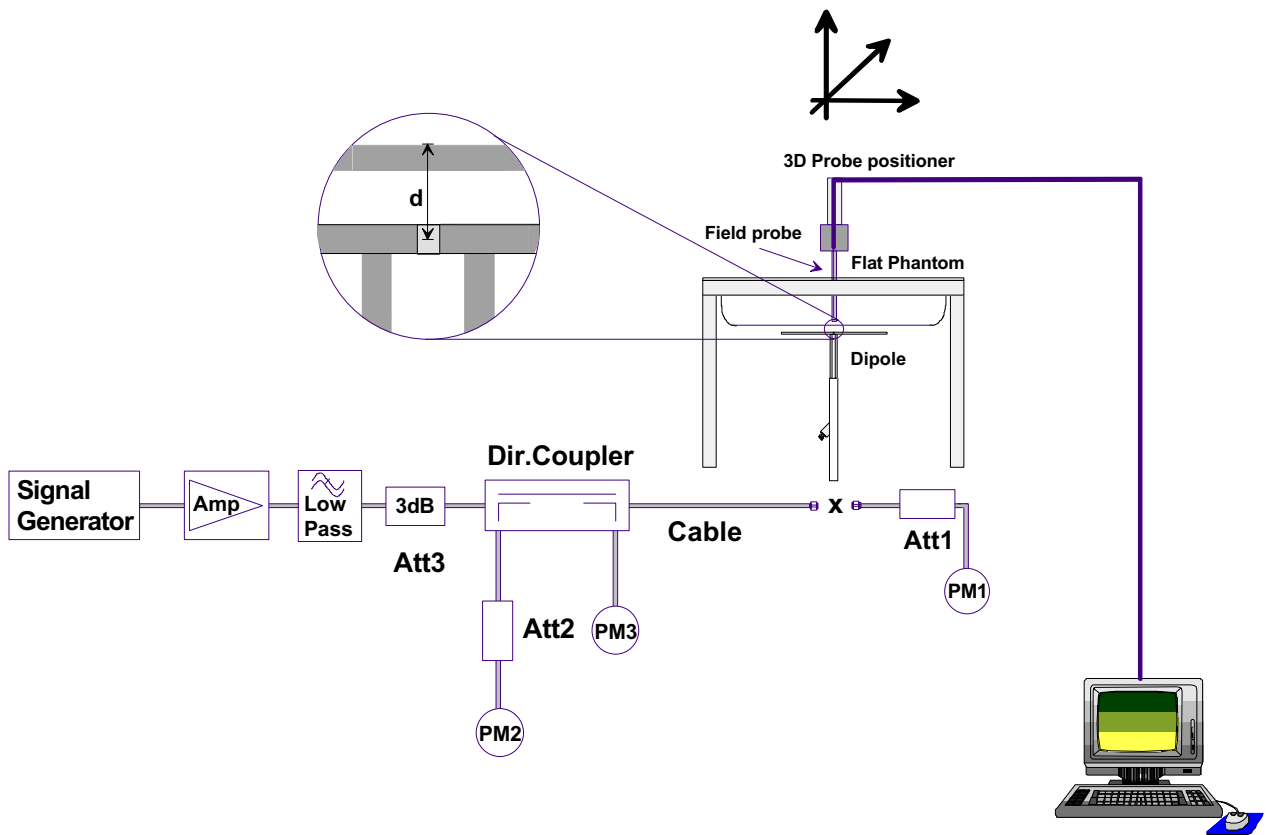

First, the power meter PM1 (including attenuator Att1) is connected to the cable to measure the forward power at the location of the dipole connector (X). The signal generator is adjusted for the desired forward power at the dipole connector (taking into account the attenuation of Att1) as read by power meter PM2. After connecting the cable to the dipole, the signal generator is readjusted for the same reading at power meter PM2. If the signal generator does not allow adjustment in 0.01dB steps, the remaining difference at PM2 must be taken into consideration. PM3 records the reflected power from the dipole to ensure that the value is not changed from the previous value. The reflected power should be 20dB below the forward power.

Ten SAR measurements were performed in order to achieve repeatability and to establish an average target value.

### Validation Dipole SAR Test Results

Validation Measurement	SAR @ 0.25W Input averaged over 1g	SAR @ 1W Input averaged over 1g	SAR @ 0.25W Input averaged over 10g	SAR @ 1W Input averaged over 10g	Peak SAR @ 0.25W Input
Test 1	14.2	56.80	6.33	25.32	30.5
Test 2	14.3	57.20	6.34	25.36	30.8
Test 3	14.2	56.80	6.33	25.32	30.4
Test 4	14.1	56.40	6.32	25.28	30.1
Test 5	14.3	57.20	6.33	25.32	30.7
Test 6	14.0	56.00	6.31	25.24	30.0
Test 7	14.2	56.80	6.33	25.32	30.4
Test 8	14.2	56.80	6.33	25.32	30.5
Test 9	14.4	57.60	6.34	25.36	30.8
Test10	14.2	56.80	6.32	25.28	30.4
Average Value	14.21	56.84	6.32	25.31	30.46

The results have been normalized to 1W (forward power) into the dipole.

Averaged over 1cm (1g) of tissue: 56.84 mW/g

Averaged over 10cm (10g) of tissue: 25.31 mW/g

# Dipole 2450MHz

SAM Phantom; Flat Section

Probe: ET3DV6 - SNI1590; ConvF(4.93,4.93,4.93); Crest factor: 1.0; 2450 MHz Brain:  $\sigma = 1.80$  mho/m  $\epsilon_r = 39.2$   $\rho = 1.00$  g/cm<sup>3</sup>

Cube 5x5x7: Peak: 30.5 mW/g, SAR (1g): 14.2 mW/g, SAR (10g): 6.33 mW/g, (Worst-case extrapolation)

Penetration depth: 6.2 (5.9, 7.0) [mm]; Ambient Temp: 21.5°C; Fluid Temp: 23.1°C

Powerdrift: 0.03 dB

Calibration Date: October 24, 2001

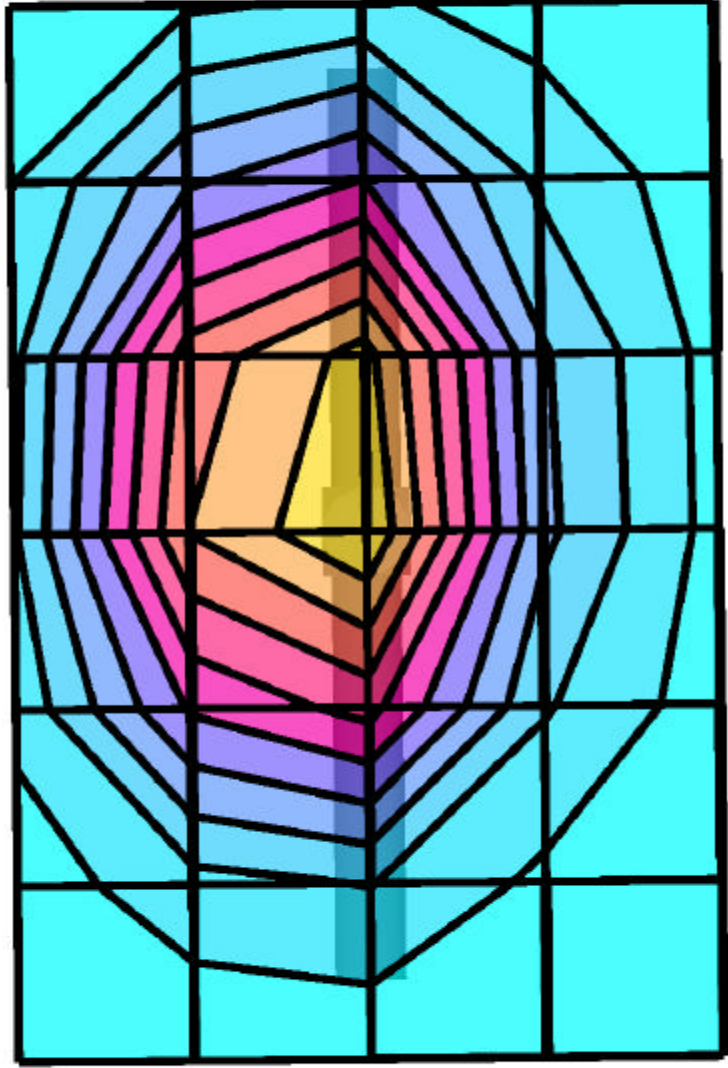

## APPENDIX D - PROBE CALIBRATION

# Schmid & Partner Engineering AG

Zeughausstrasse 43, 8004 Zurich, Switzerland, Phone +41 1 245 97 00, Fax +41 1 245 97 79

## Calibration Certificate

### Dosimetric E-Field Probe

Type:

**ET3DV6**

Serial Number:

**1387**

Place of Calibration:

**Zurich**

Date of Calibration:

**February 22, 2002**

Calibration Interval:

**12 months**

Schmid & Partner Engineering AG hereby certifies, that this device has been calibrated on the date indicated above. The calibration was performed in accordance with specifications and procedures of Schmid & Partner Engineering AG.

Wherever applicable, the standards used in the calibration process are traceable to international standards. In all other cases the standards of the Laboratory for EMF and Microwave Electronics at the Swiss Federal Institute of Technology (ETH) in Zurich, Switzerland have been applied.

Calibrated by:

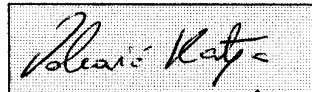

Approved by:





# Probe ET3DV6

SN:1387

Manufactured:	September 21, 1999
Last calibration:	September 22, 1999
Recalibrated:	February 22, 2002

Calibrated for System DASY3

## DASY3 - Parameters of Probe: ET3DV6 SN:1387

### Sensitivity in Free Space

NormX	<b>1.58</b> $\mu\text{V}/(\text{V}/\text{m})^2$
NormY	<b>1.67</b> $\mu\text{V}/(\text{V}/\text{m})^2$
NormZ	<b>1.67</b> $\mu\text{V}/(\text{V}/\text{m})^2$

### Diode Compression

DCP X	<b>97</b>	mV
DCP Y	<b>97</b>	mV
DCP Z	<b>97</b>	mV

### Sensitivity in Tissue Simulating Liquid

Head	<b>900 MHz</b>	$\epsilon_r = 41.5 \pm 5\%$	$\sigma = 0.97 \pm 5\%$ mho/m
Head	<b>835 MHz</b>	$\epsilon_r = 41.5 \pm 5\%$	$\sigma = 0.90 \pm 5\%$ mho/m
	ConvF X	<b>6.6</b> $\pm 9.5\%$ (k=2)	Boundary effect:
	ConvF Y	<b>6.6</b> $\pm 9.5\%$ (k=2)	Alpha <b>0.40</b>
	ConvF Z	<b>6.6</b> $\pm 9.5\%$ (k=2)	Depth <b>2.38</b>
Head	<b>1800 MHz</b>	$\epsilon_r = 40.0 \pm 5\%$	$\sigma = 1.40 \pm 5\%$ mho/m
Head	<b>1900 MHz</b>	$\epsilon_r = 40.0 \pm 5\%$	$\sigma = 1.40 \pm 5\%$ mho/m
	ConvF X	<b>5.4</b> $\pm 9.5\%$ (k=2)	Boundary effect:
	ConvF Y	<b>5.4</b> $\pm 9.5\%$ (k=2)	Alpha <b>0.57</b>
	ConvF Z	<b>5.4</b> $\pm 9.5\%$ (k=2)	Depth <b>2.18</b>

### Boundary Effect

Head	<b>900 MHz</b>	<b>Typical SAR gradient: 5 % per mm</b>	
	Probe Tip to Boundary	<b>1 mm</b>	<b>2 mm</b>
	SAR <sub>be</sub> [%] Without Correction Algorithm	9.7	5.4
	SAR <sub>be</sub> [%] With Correction Algorithm	0.3	0.6
Head	<b>1800 MHz</b>	<b>Typical SAR gradient: 10 % per mm</b>	
	Probe Tip to Boundary	<b>1 mm</b>	<b>2 mm</b>
	SAR <sub>be</sub> [%] Without Correction Algorithm	11.5	7.3
	SAR <sub>be</sub> [%] With Correction Algorithm	0.1	0.3

### Sensor Offset

Probe Tip to Sensor Center	<b>2.7</b>	mm
Optical Surface Detection	<b>1.3 <math>\pm</math> 0.2</b>	mm

### Receiving Pattern ( $\phi$ , $\theta = 0^\circ$ )

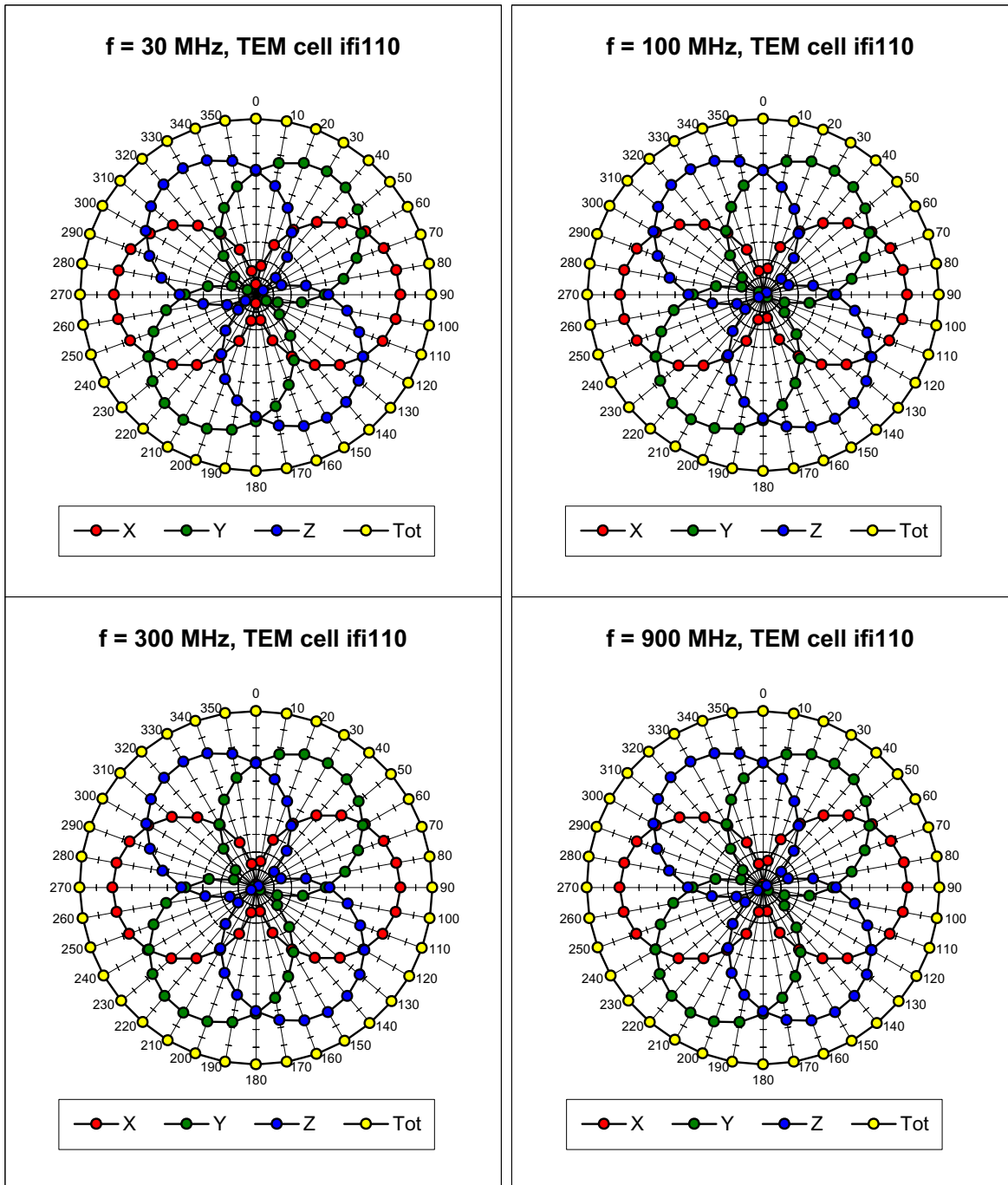

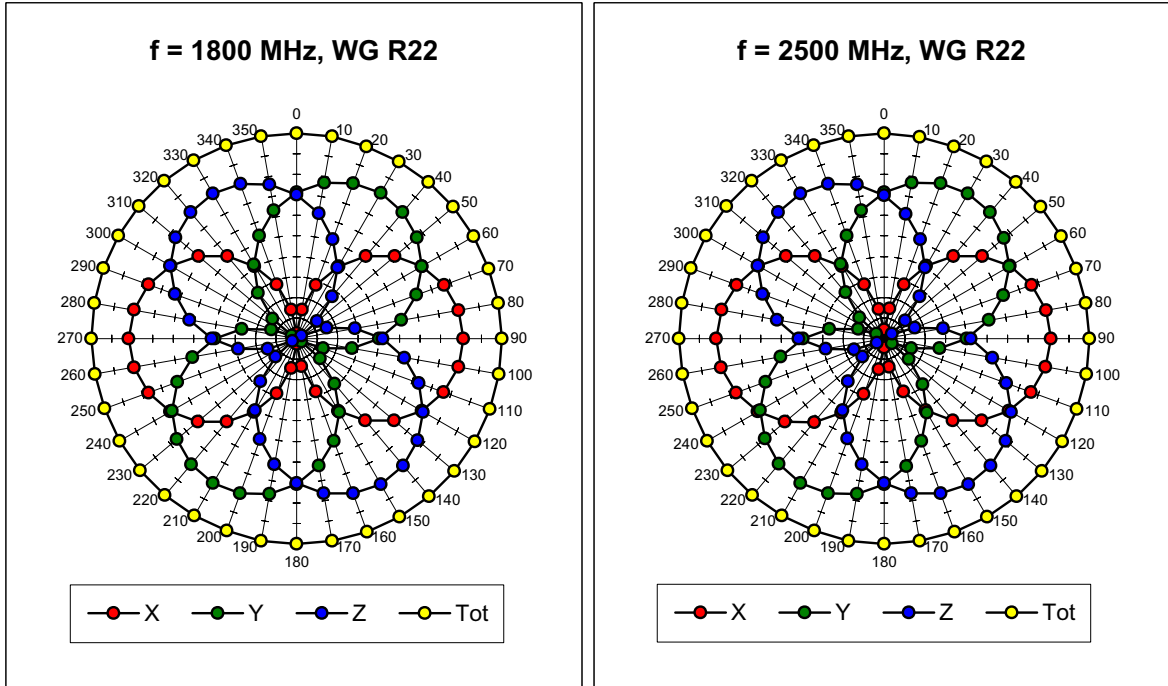

### Isotropy Error ( $\phi$ ), $\theta = 0^\circ$

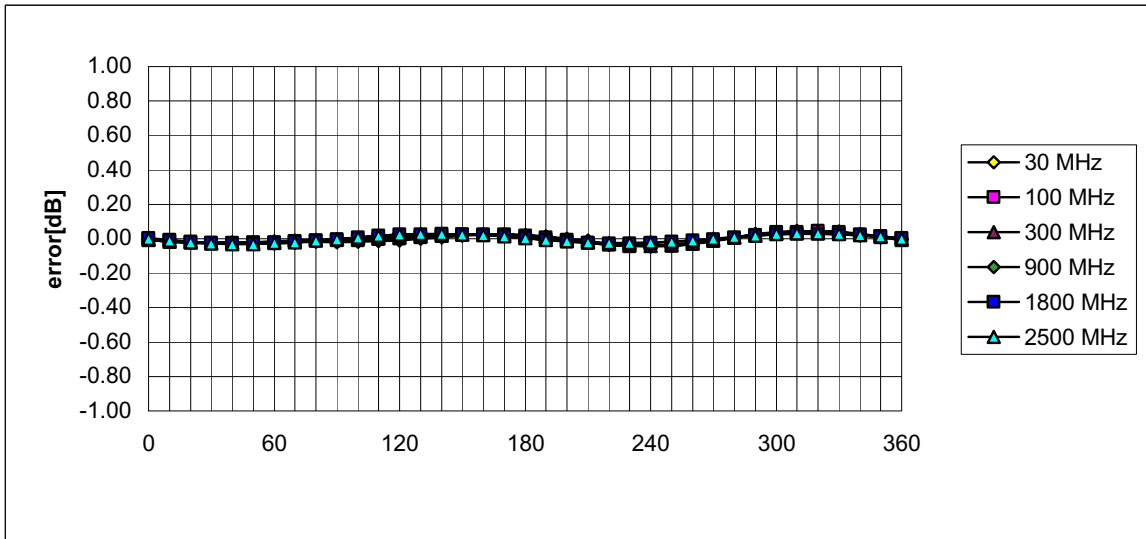

# Frequency Response of E-Field

( TEM-Cell:ifi110, Waveguide R22)

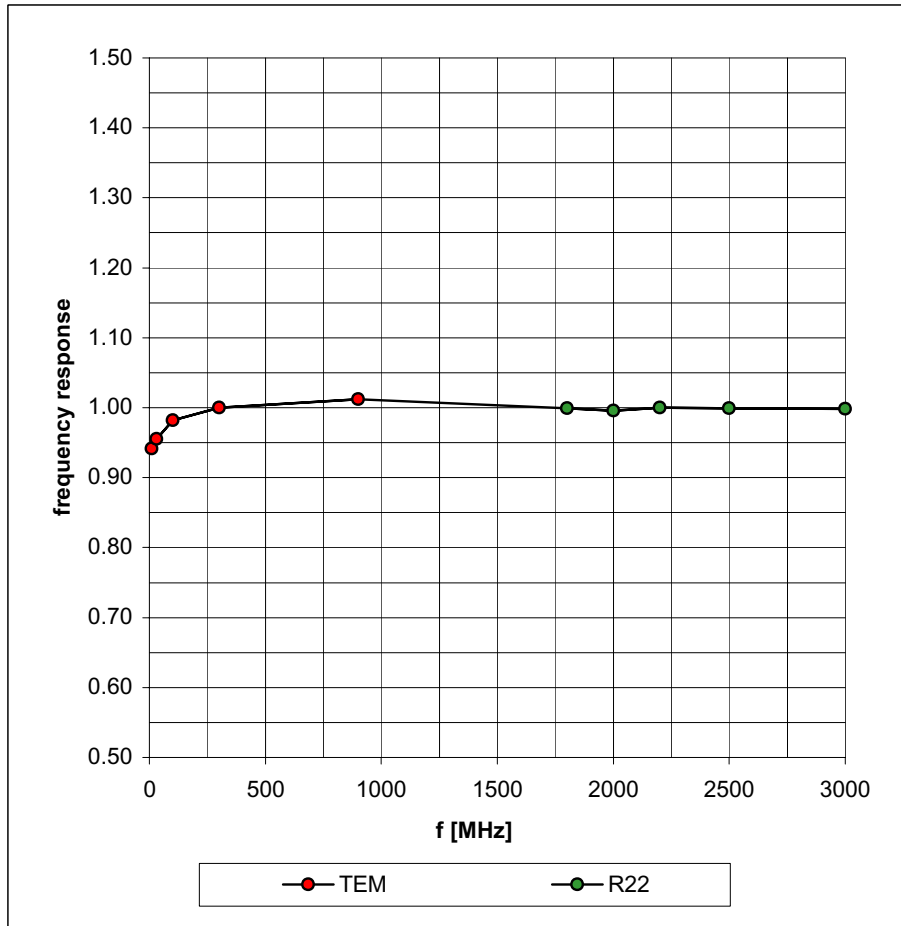

### Dynamic Range f(SAR<sub>brain</sub>) ( Waveguide R22 )

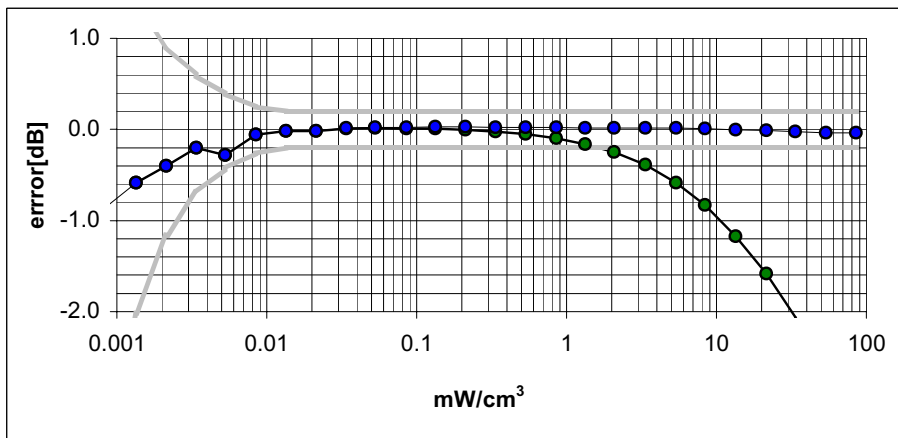
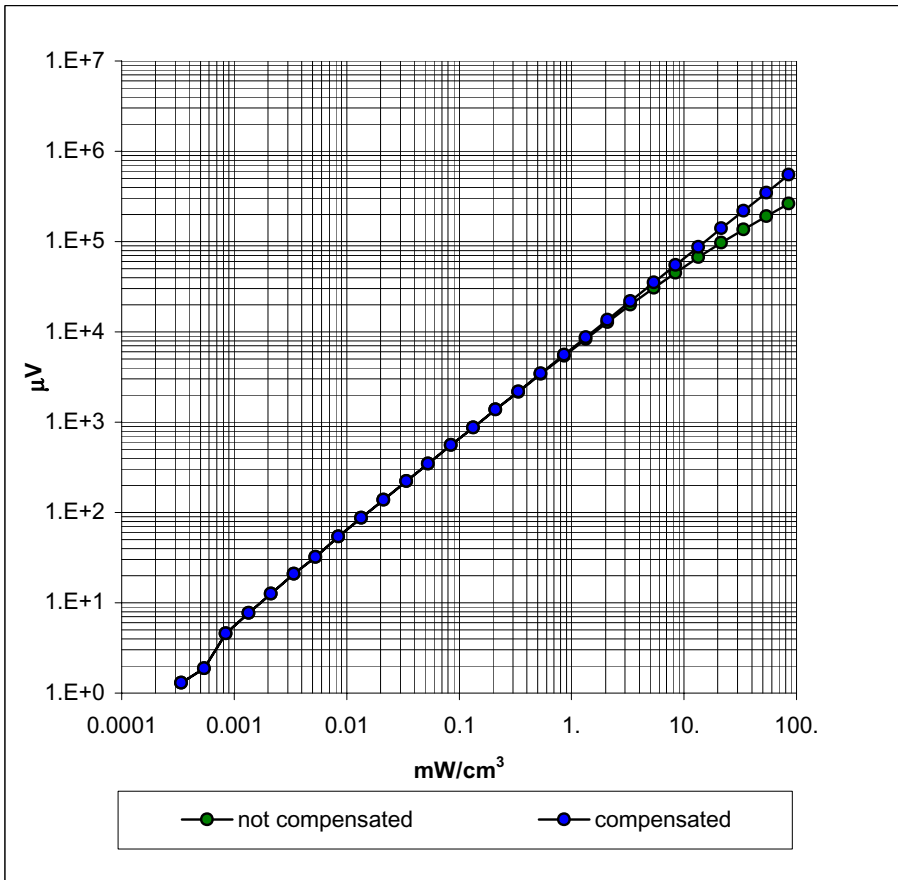

# Conversion Factor Assessment

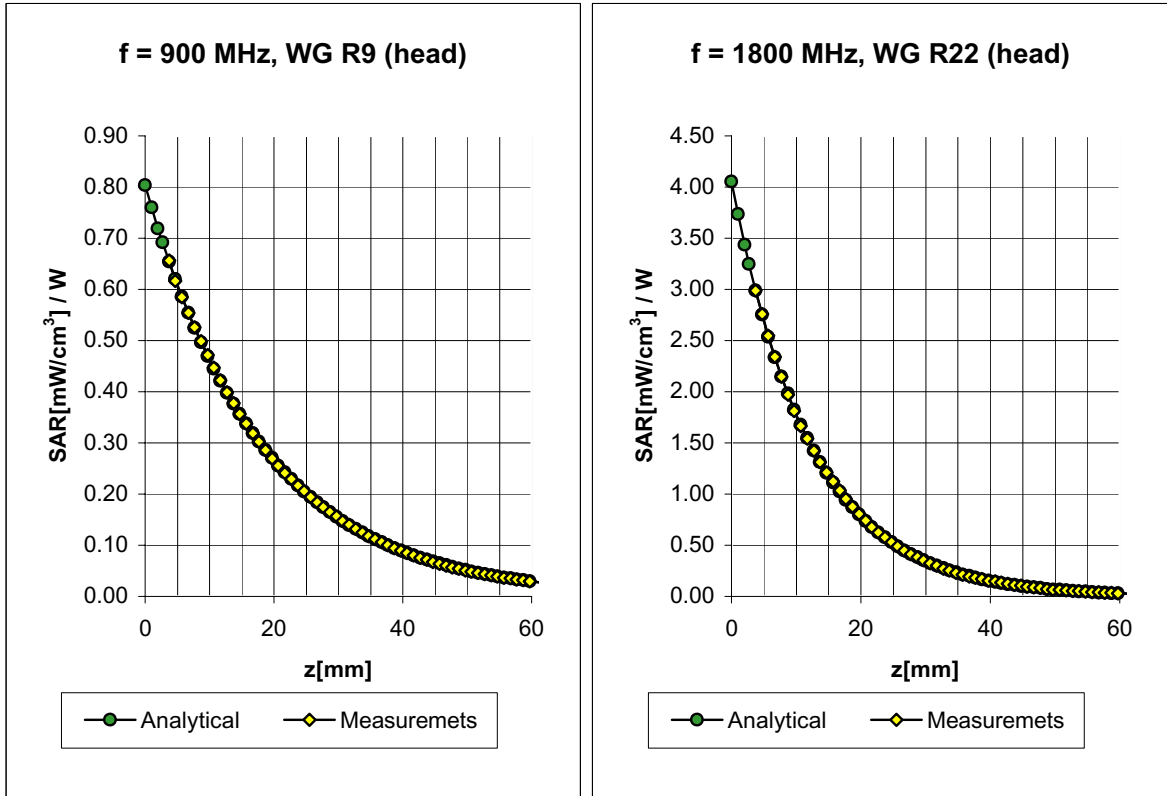

Head	<b>900 MHz</b>	$\epsilon_r = 41.5 \pm 5\%$	$\sigma = 0.97 \pm 5\% \text{ mho/m}$
Head	<b>835 MHz</b>	$\epsilon_r = 41.5 \pm 5\%$	$\sigma = 0.90 \pm 5\% \text{ mho/m}$
	ConvF X	<b>6.6</b> $\pm 9.5\%$ (k=2)	Boundary effect:
	ConvF Y	<b>6.6</b> $\pm 9.5\%$ (k=2)	Alpha <b>0.40</b>
	ConvF Z	<b>6.6</b> $\pm 9.5\%$ (k=2)	Depth <b>2.38</b>
Head	<b>1800 MHz</b>	$\epsilon_r = 40.0 \pm 5\%$	$\sigma = 1.40 \pm 5\% \text{ mho/m}$
Head	<b>1900 MHz</b>	$\epsilon_r = 40.0 \pm 5\%$	$\sigma = 1.40 \pm 5\% \text{ mho/m}$
	ConvF X	<b>5.4</b> $\pm 9.5\%$ (k=2)	Boundary effect:
	ConvF Y	<b>5.4</b> $\pm 9.5\%$ (k=2)	Alpha <b>0.57</b>
	ConvF Z	<b>5.4</b> $\pm 9.5\%$ (k=2)	Depth <b>2.18</b>

ET3DV6 SN:1387

February 22, 2002

# Conversion Factor Assessment

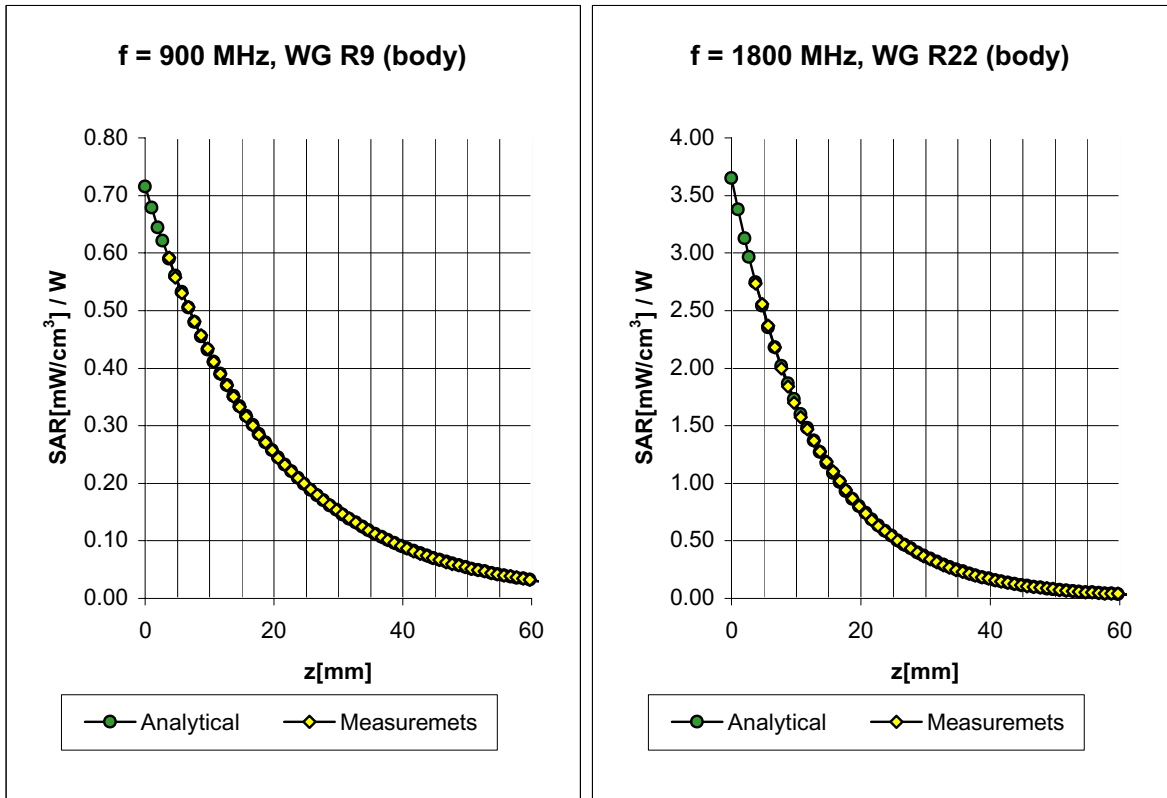

<b>Body</b>	<b>900 MHz</b>	$\epsilon_r = 55.0 \pm 5\%$	$\sigma = 1.05 \pm 5\% \text{ mho/m}$
<b>Body</b>	<b>835 MHz</b>	$\epsilon_r = 55.2 \pm 5\%$	$\sigma = 0.97 \pm 5\% \text{ mho/m}$
	ConvF X	<b>6.3</b> $\pm 9.5\%$ (k=2)	Boundary effect:
	ConvF Y	<b>6.3</b> $\pm 9.5\%$ (k=2)	Alpha <b>0.42</b>
	ConvF Z	<b>6.3</b> $\pm 9.5\%$ (k=2)	Depth <b>2.44</b>
<b>Body</b>	<b>1800 MHz</b>	$\epsilon_r = 53.3 \pm 5\%$	$\sigma = 1.52 \pm 5\% \text{ mho/m}$
<b>Body</b>	<b>1900 MHz</b>	$\epsilon_r = 53.3 \pm 5\%$	$\sigma = 1.52 \pm 5\% \text{ mho/m}$
	ConvF X	<b>5.0</b> $\pm 9.5\%$ (k=2)	Boundary effect:
	ConvF Y	<b>5.0</b> $\pm 9.5\%$ (k=2)	Alpha <b>0.76</b>
	ConvF Z	<b>5.0</b> $\pm 9.5\%$ (k=2)	Depth <b>2.01</b>

ET3DV6 SN:1387

February 22, 2002



# Deviation from Isotropy in HSL

Error ( $\theta, \phi$ ),  $f = 900$  MHz

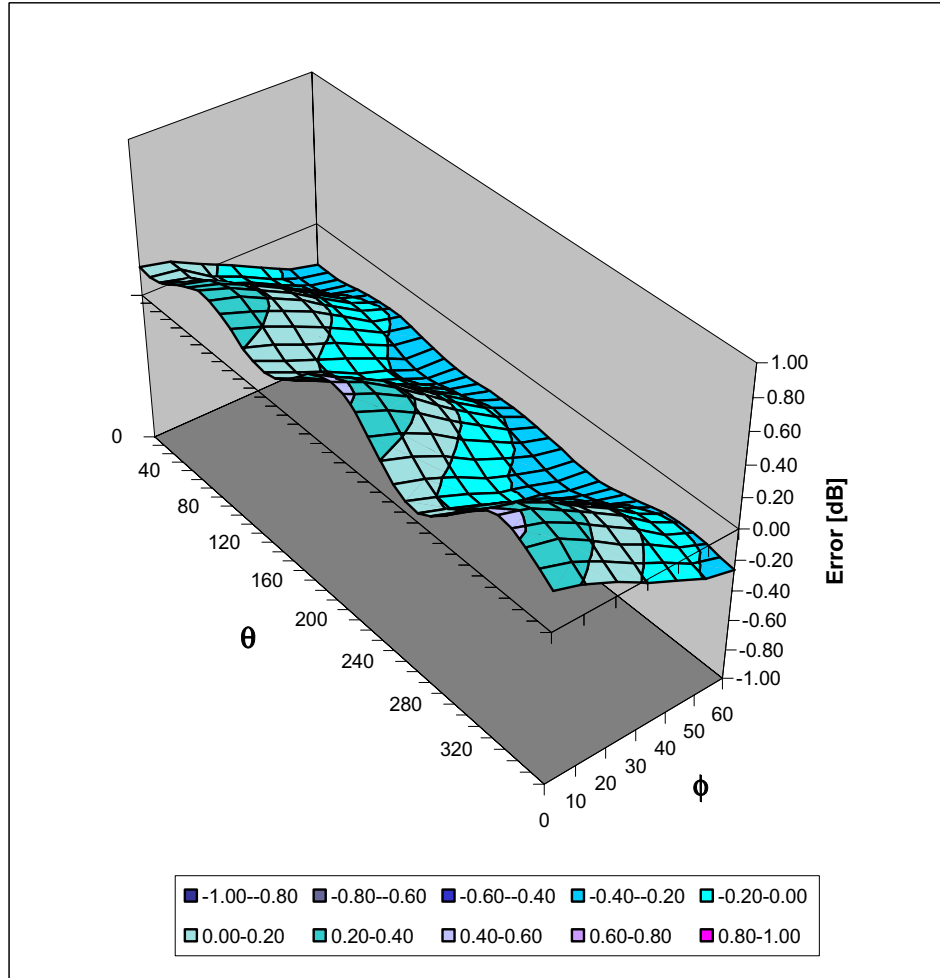

## Additional Conversion Factors for Dosimetric E-Field Probe

Type:

**ET3DV6**

Serial Number:

**1387**

Place of Assessment:

**Zurich**

Date of Assessment:

**February 25, 2002**

Probe Calibration Date:

**February 22, 2002**

Schmid & Partner Engineering AG hereby certifies that conversion factor(s) of this probe have been evaluated on the date indicated above. The assessment was performed using the FDTD numerical code SEMCAD of Schmid & Partner Engineering AG. Since the evaluation is coupled with measured conversion factors, it has to be recalculated yearly, i.e., following the re-calibration schedule of the probe. The uncertainty of the numerical assessment is based on the extrapolation from measured value at 900 MHz or at 1800 MHz.

Assessed by:



## Dosimetric E-Field Probe ET3DV6 SN:1387

Conversion Factor ( $\pm$  standard deviation)

150 MHz	ConvF	$9.2 \pm 8\%$	$\epsilon_r = 52.3$ $\sigma = 0.76 \text{ mho/m}$ (head tissue)
300 MHz	ConvF	$8.0 \pm 8\%$	$\epsilon_r = 45.3$ $\sigma = 0.87 \text{ mho/m}$ (head tissue)
450 MHz	ConvF	$7.3 \pm 8\%$	$\epsilon_r = 43.5$ $\sigma = 0.87 \text{ mho/m}$ (head tissue)
2450 MHz	ConvF	$4.7 \pm 8\%$	$\epsilon_r = 39.2$ $\sigma = 1.80 \text{ mho/m}$ (head tissue)
150 MHz	ConvF	$8.8 \pm 8\%$	$\epsilon_r = 61.9$ $\sigma = 0.80 \text{ mho/m}$ (body tissue)
450 MHz	ConvF	$7.7 \pm 8\%$	$\epsilon_r = 56.7$ $\sigma = 0.94 \text{ mho/m}$ (body tissue)
2450 MHz	ConvF	$4.3 \pm 8\%$	$\epsilon_r = 52.7$ $\sigma = 1.95 \text{ mho/m}$ (body tissue)

## **APPENDIX E - MEASURED FLUID DIELECTRIC PARAMETERS**

# 2450MHz System Validation

## Measured Fluid Dielectric Parameters (Brain)

September 13, 2002

Frequency	$\epsilon'$	$\epsilon''$
2.350000000 GHz	37.1388	13.4743
2.360000000 GHz	37.1055	13.5165
2.370000000 GHz	37.0555	13.5498
2.380000000 GHz	37.0264	13.5809
2.390000000 GHz	36.9872	13.6012
2.400000000 GHz	36.9402	13.6277
2.410000000 GHz	36.8792	13.6384
2.420000000 GHz	36.8197	13.6914
2.430000000 GHz	36.7782	13.7145
2.440000000 GHz	36.7281	13.7393
2.450000000 GHz	36.6921	13.7775
2.460000000 GHz	36.6473	13.8068
2.470000000 GHz	36.6011	13.8535
2.480000000 GHz	36.5780	13.8742
2.490000000 GHz	36.5347	13.8952
2.500000000 GHz	36.4816	13.9029
2.510000000 GHz	36.4389	13.9027
2.520000000 GHz	36.3819	13.9436
2.530000000 GHz	36.3184	13.9686
2.540000000 GHz	36.2583	13.9968
2.550000000 GHz	36.2240	14.0363

# 2450MHz EUT Evaluation (Body)

## Measured Fluid Dielectric Parameters (Muscle)

September 13, 2002

Frequency	$\epsilon'$	$\epsilon''$
2.350000000 GHz	51.4448	14.4028
2.355000000 GHz	51.4251	14.4203
2.360000000 GHz	51.4191	14.4435
2.365000000 GHz	51.3882	14.4598
2.370000000 GHz	51.3746	14.4849
2.375000000 GHz	51.3570	14.4936
2.380000000 GHz	51.3400	14.5087
2.385000000 GHz	51.3101	14.5246
2.390000000 GHz	51.2879	14.5283
2.395000000 GHz	51.2803	14.5508
2.400000000 GHz	51.2512	14.5664
2.405000000 GHz	51.2255	14.5816
2.410000000 GHz	51.1916	14.5924
2.415000000 GHz	51.1762	14.6067
2.420000000 GHz	51.1634	14.6323
2.425000000 GHz	51.1430	14.6632
2.430000000 GHz	51.1192	14.6877
2.435000000 GHz	51.1079	14.7014
2.440000000 GHz	51.1108	14.7271
2.445000000 GHz	51.0831	14.7320
2.450000000 GHz	51.0605	14.7593
2.455000000 GHz	51.0580	14.7915
2.460000000 GHz	51.0386	14.8118
2.465000000 GHz	51.0200	14.8385
2.470000000 GHz	51.0055	14.8533
2.475000000 GHz	51.0018	14.8770
2.480000000 GHz	50.9751	14.8959
2.485000000 GHz	50.9546	14.9077
2.490000000 GHz	50.9255	14.9299
2.495000000 GHz	50.9101	14.9395
2.500000000 GHz	50.8801	14.9454
2.505000000 GHz	50.8566	14.9685
2.510000000 GHz	50.8316	14.9901
2.515000000 GHz	50.8109	15.0209

## **APPENDIX F - SAM PHANTOM CERTIFICATE OF CONFORMITY**

# Schmid & Partner Engineering AG

Zeughausstrasse 43, 8004 Zurich, Switzerland, Phone +41 1 245 97 00, Fax +41 1 245 97 79

## Certificate of conformity / First Article Inspection

Item	SAM Twin Phantom V4.0
Type No	QD 000 P40 BA
Series No	TP-1002 and higher
Manufacturer / Origin	Untersee Composites Hauptstr. 69 CH-8559 Fruthwilen Switzerland

### Tests

The series production process used allows the limitation to test of first articles. Complete tests were made on the pre-series Type No. QD 000 P40 AA, Serial No. TP-1001 and on the series first article Type No. QD 000 P40 BA, Serial No. TP-1006. Certain parameters have been retested using further series units (called samples).

Test	Requirement	Details	Units tested
Shape	Compliance with the geometry according to the CAD model.	IT'IS CAD File (*)	First article, Samples
Material thickness	Compliant with the requirements according to the standards	2mm +/- 0.2mm in specific areas	First article, Samples
Material parameters	Dielectric parameters for required frequencies	200 MHz – 3 GHz Relative permittivity < 5 Loss tangent < 0.05.	Material sample TP 104-5
Material resistivity	The material has been tested to be compatible with the liquids defined in the standards	Liquid type HSL 1800 and others according to the standard.	Pre-series, First article

### Standards

- [1] CENELEC EN 50361
- [2] IEEE P1528-200x draft 6.5
- [3] IEC PT 62209 draft 0.9

(\*) The IT'IS CAD file is derived from [2] and is also within the tolerance requirements of the shapes of [1] and [3].

### Conformity

Based on the sample tests above, we certify that this item is in compliance with the uncertainty requirements of SAR measurements specified in standard [1] and draft standards [2] and [3].

Date 18.11.2001

Signature / Stamp



**Schmid & Partner  
Engineering AG**



Zeughausstrasse 43, CH-8004 Zurich  
Tel. +41 1 245 97 00, Fax +41 1 245 97 79



## **APPENDIX G - SAR TEST SETUP & EUT PHOTOGRAPHS**

**BODY SAR TEST SETUP PHOTOGRAPHS**  
Keyboard Side of Host Laptop PC - EUT in Top PCMCIA Slot  
0.0cm Separation Distance between Laptop PC & Planar Phantom

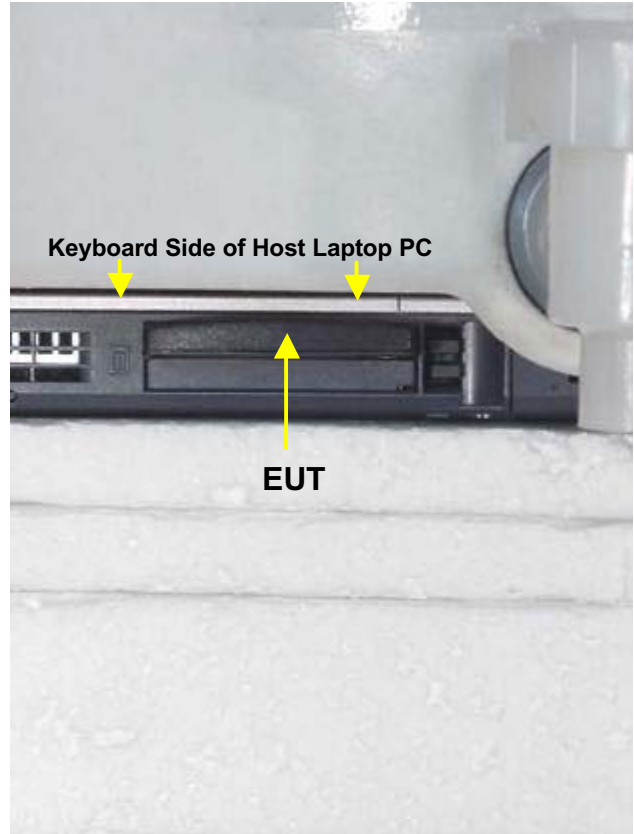

**BODY SAR TEST SETUP PHOTOGRAPHS**  
**Bottom Side of Host Laptop PC - EUT in Bottom PCMCIA Slot**  
**0.0cm Separation Distance between Laptop PC & Planar Phantom**

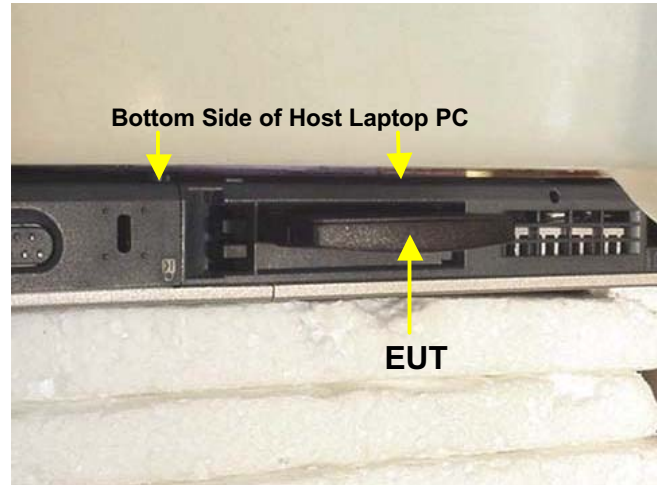

**BODY SAR TEST SETUP PHOTOGRAPHS**  
Left Side of Host Laptop PC - Antenna Side of EUT - EUT in Bottom PCMCIA Slot  
1.5cm Separation Distance between EUT & Planar Phantom

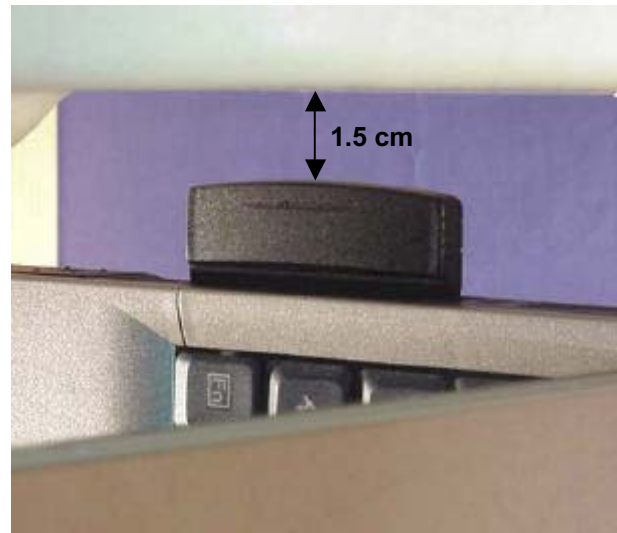

**EUT PHOTOGRAPHS**  
DSSS Wireless Notebook Adapter

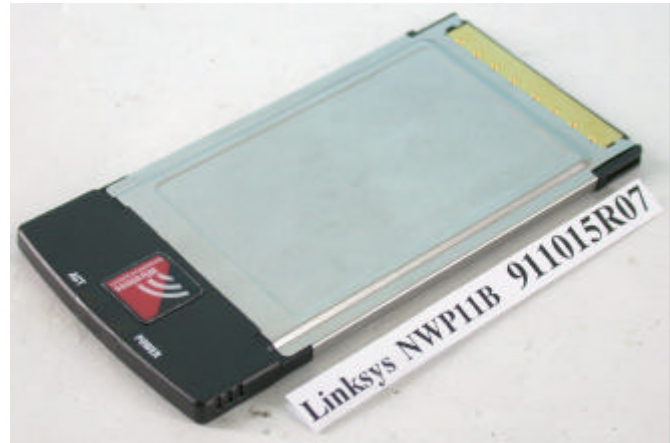
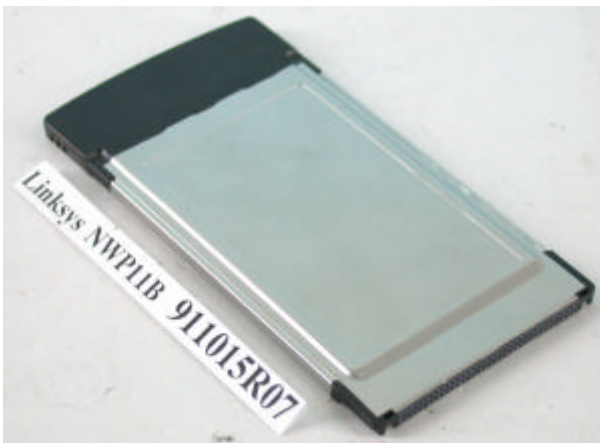



**EUT PHOTOGRAPHS**  
with Host Laptop PC



**Fujitsu Lifebook E Series Laptop PC**



**Fujitsu Lifebook E Series Laptop PC**



**EUT in Top Slot of Host Laptop PC**



**EUT in Bottom Slot of Host Laptop PC**