

Report No.: B16W00042-FCC-RF

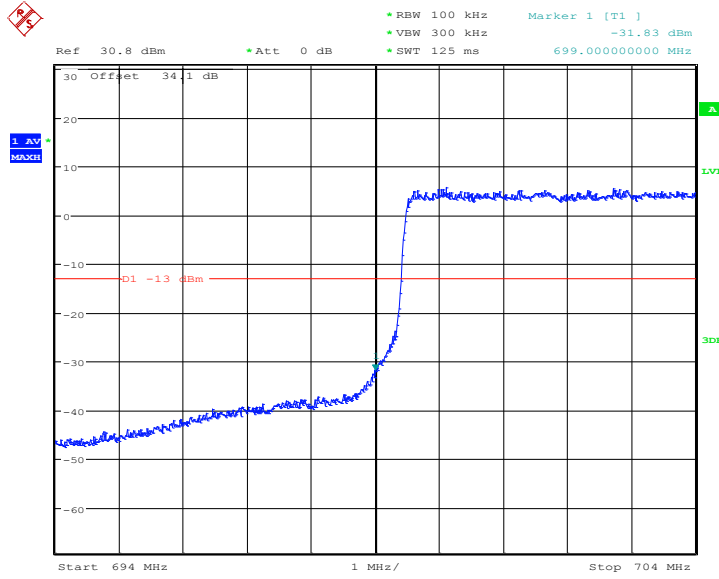

Date: 18.MAR.2016 15:58:12

LTE Band12, 10MHz bandwidth, QPSK,(50,0) Mode , Below 699MHz

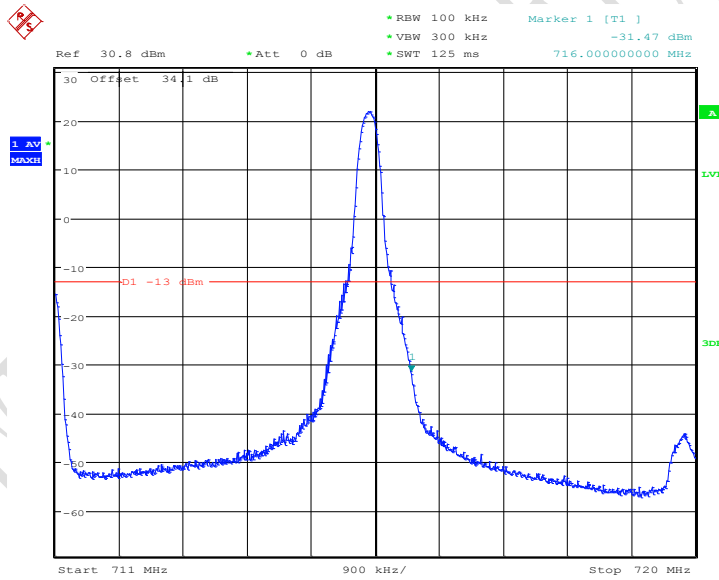

Date: 18.MAR.2016 15:59:09

LTE Band12, 10MHz bandwidth, QPSK,(1,50) Mode, Above 716MHz

Report No.: B16W00042-FCC-RF

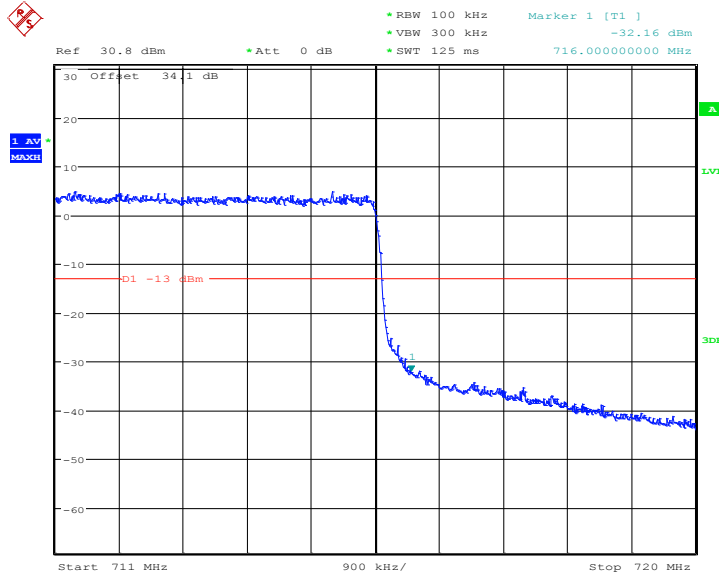

Date: 18.MAR.2016 16:00:07

LTE Band12, 10MHz bandwidth, QPSK,(50,0) Mode, Above 716MHz

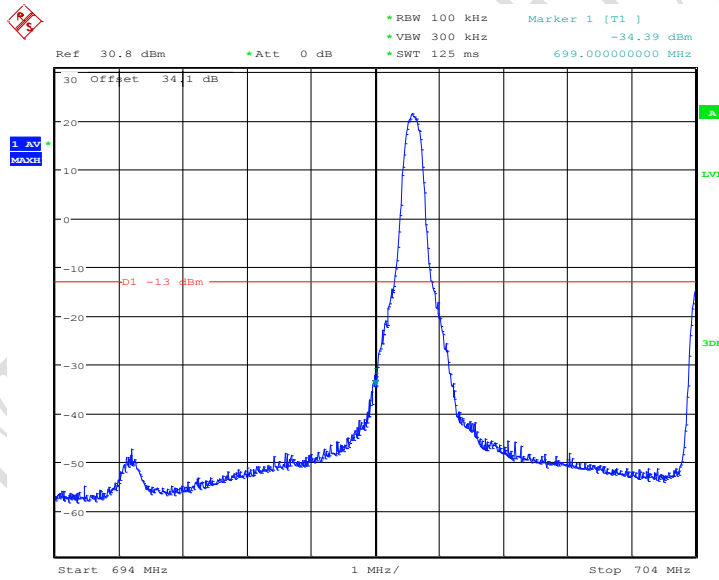

Date: 18.MAR.2016 15:57:28

LTE Band12, 10MHz bandwidth, 16QAM,(1,0) Mode , Below 699MHz

Report No.: B16W00042-FCC-RF

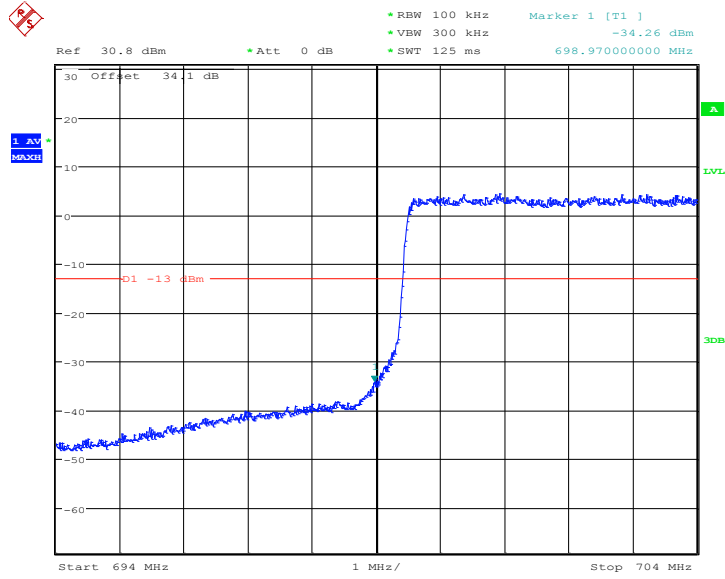

Date: 18.MAR.2016 15:57:53

LTE Band12, 10MHz bandwidth, 16QAM,(50,0) Mode , Below 699MHz

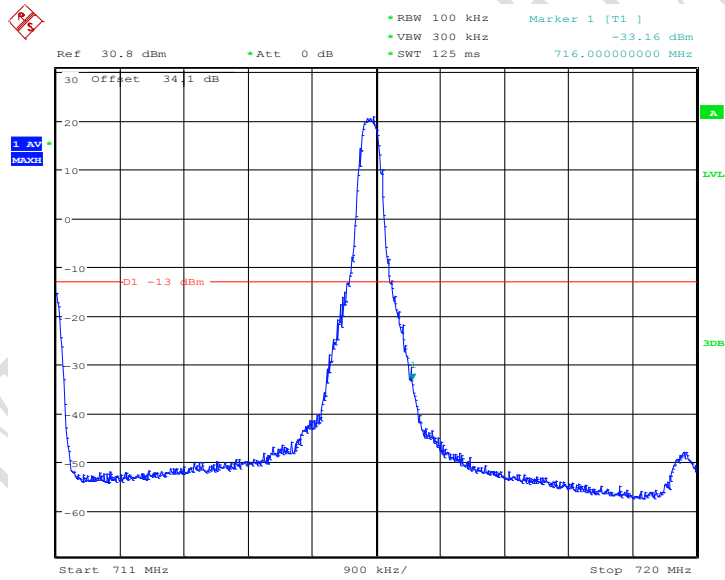

Date: 18.MAR.2016 15:59:26

LTE Band12, 10MHz bandwidth, 16QAM,(1,50) Mode, Above 716MHz

Report No.: B16W00042-FCC-RF

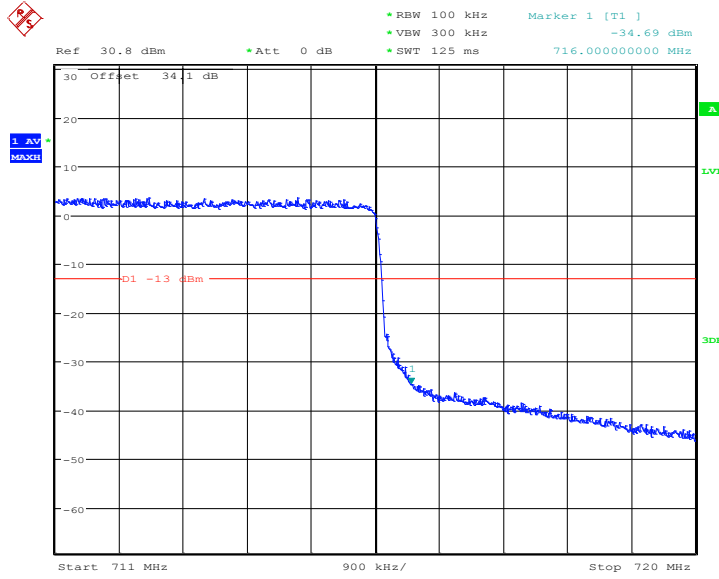

Date: 18.MAR.2016 15:59:50

LTE Band12, 10MHz bandwidth, 16QAM,(50,0) Mode, Above 716MHz

5.5.12 LTE B25 Band Edge Results

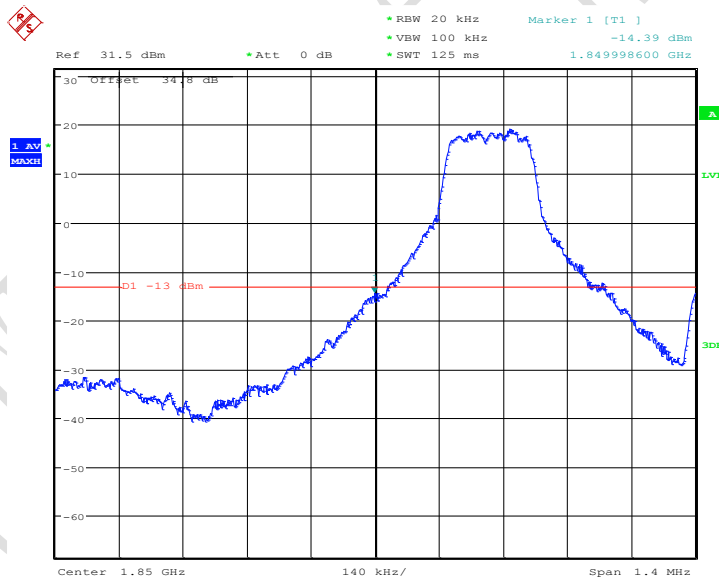

Date: 18.MAR.2016 16:03:45

LTE Band25, 1.4MHz bandwidth, QPSK,(1,0) Mode , Below 1850MHz

Report No.: B16W00042-FCC-RF

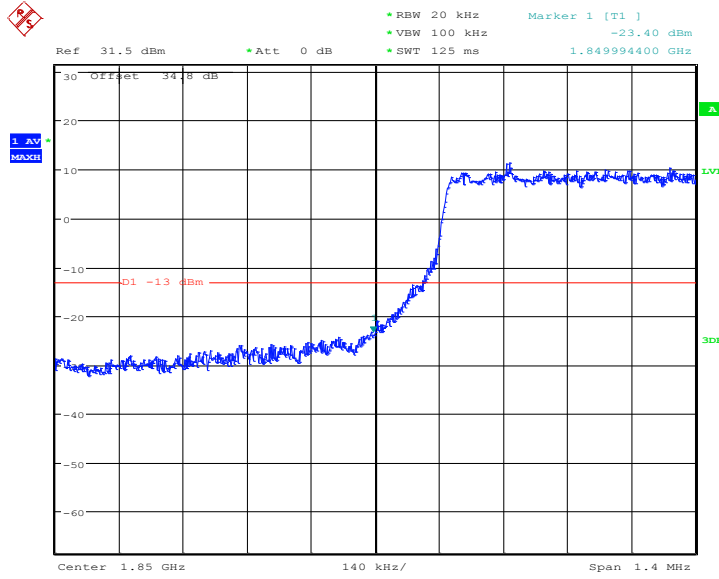

Date: 18.MAR.2016 16:04:59

LTE Band25, 1.4MHz bandwidth, QPSK,(6,0) Mode , Below 1850MHz

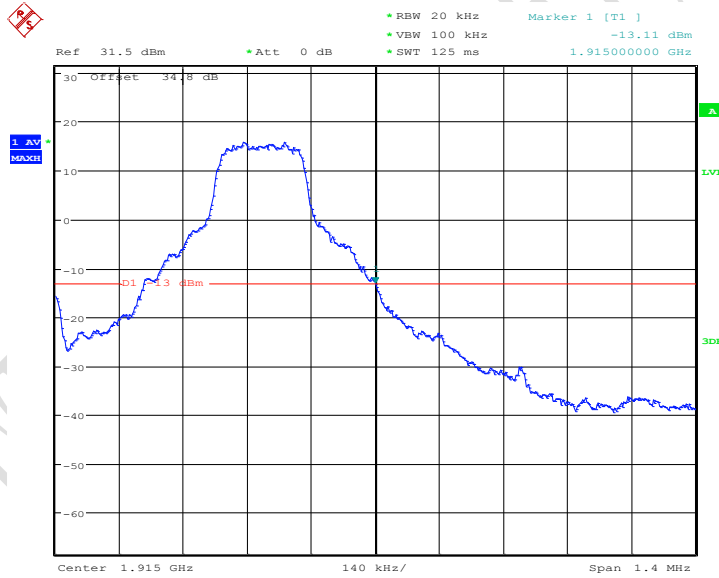

Date: 18.MAR.2016 16:08:07

LTE Band25, 1.4MHz bandwidth, QPSK,(1,6) Mode, Above 1915MHz

Report No.: B16W00042-FCC-RF

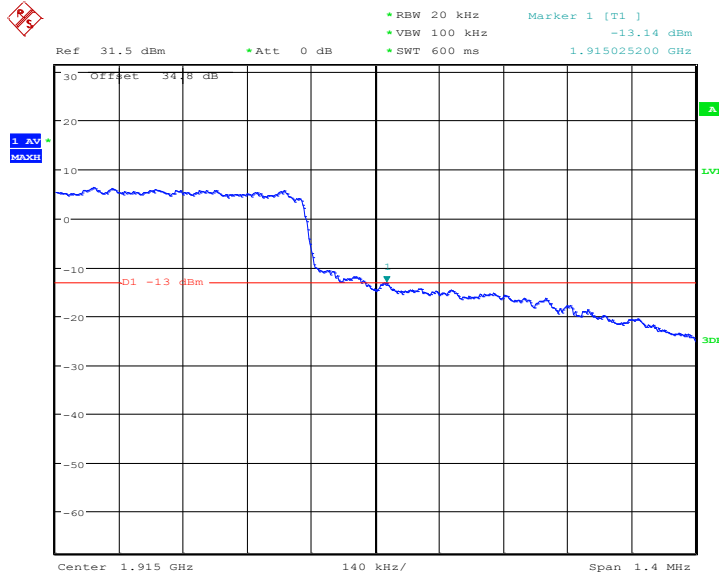

Date: 18.MAR.2016 16:12:18

LTE Band25, 1.4MHz bandwidth, QPSK,(6,0) Mode, Above 1915MHz

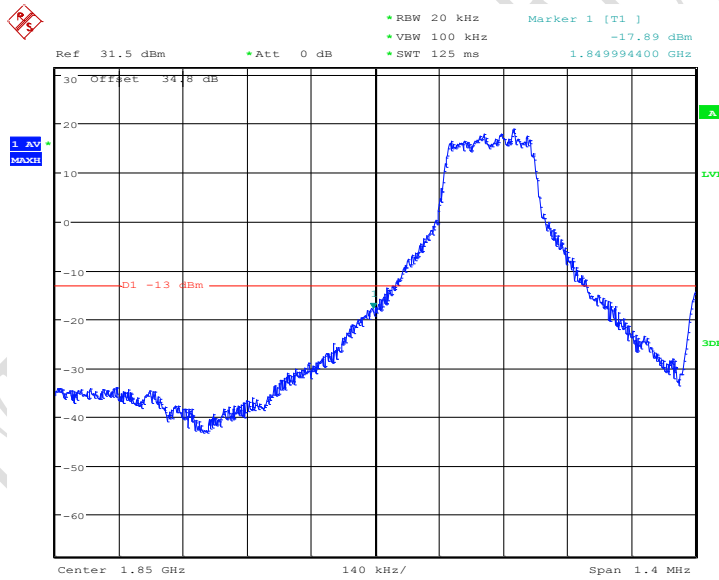

Date: 18.MAR.2016 16:04:10

LTE Band25, 1.4MHz bandwidth, 16QAM,(1,0) Mode, Below 1850MHz

Report No.: B16W00042-FCC-RF

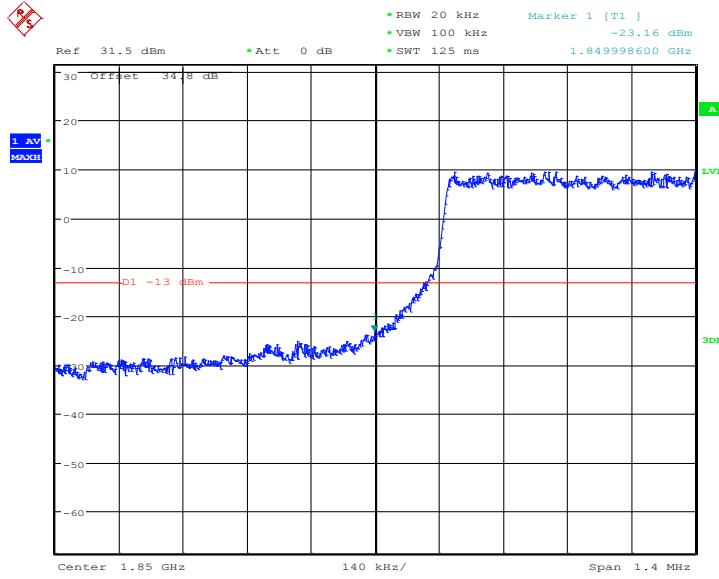

Date: 18.MAR.2016 16:04:40

LTE Band25, 1.4MHz bandwidth, 16QAM,(6,0) Mode , Below 1850MHz

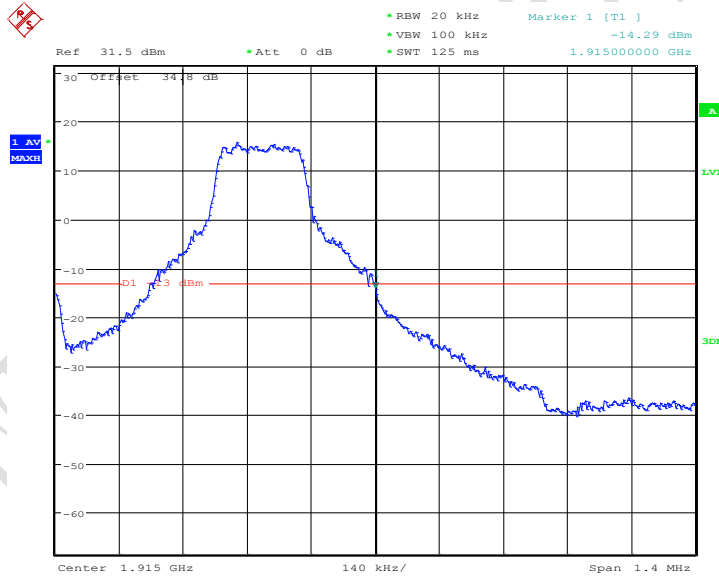

Date: 18.MAR.2016 16:08:46

LTE Band25, 1.4MHz bandwidth, 16QAM,(1,6) Mode , Above 1915MHz

Report No.: B16W00042-FCC-RF

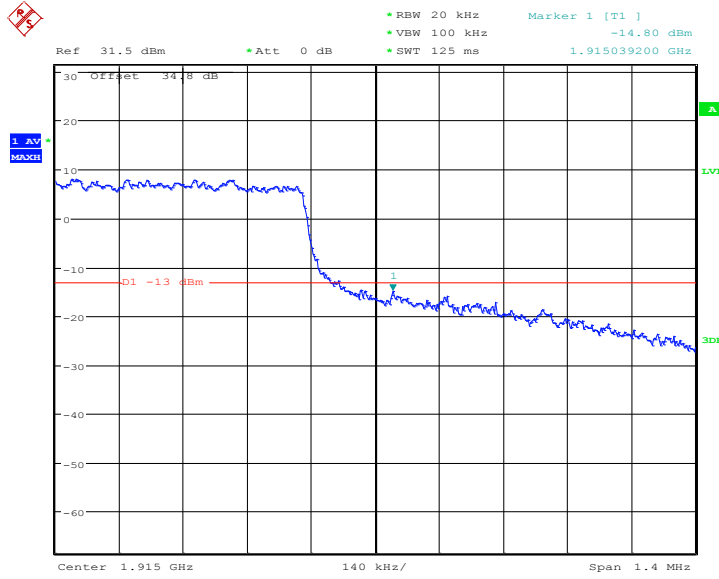

Date: 18.MAR.2016 16:09:32

LTE Band25, 1.4MHz bandwidth, 16QAM,(6,0) Mode, Above 1915MHz

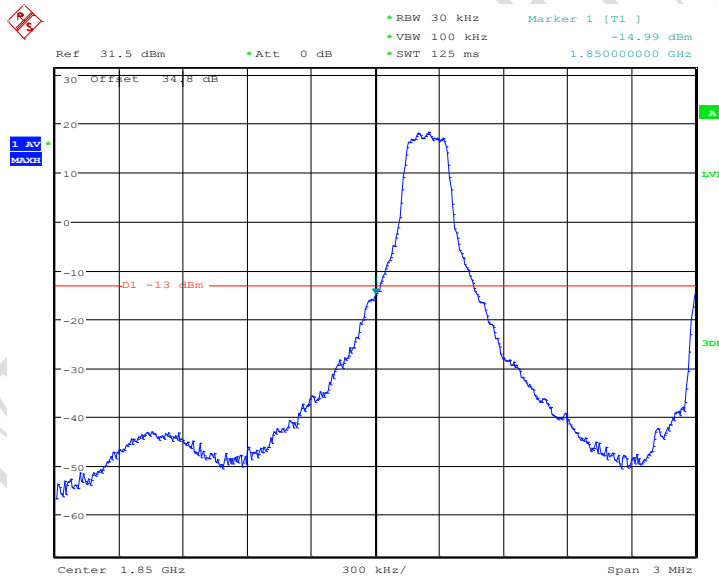

Date: 18.MAR.2016 16:16:27

LTE Band25, 3MHz bandwidth, QPSK,(1,0) Mode , Below 1850MHz

Report No.: B16W00042-FCC-RF

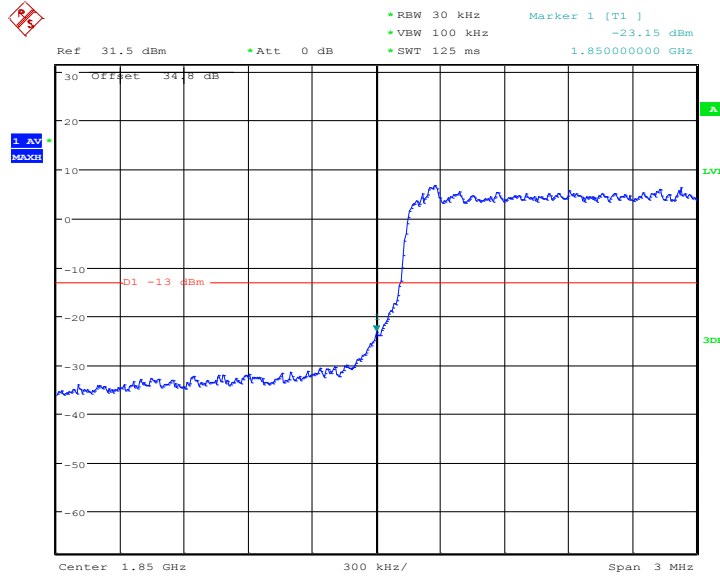

Date: 18.MAR.2016 16:17:19

LTE Band25, 3MHz bandwidth, QPSK,(15,0) Mode , Below 1850MHz

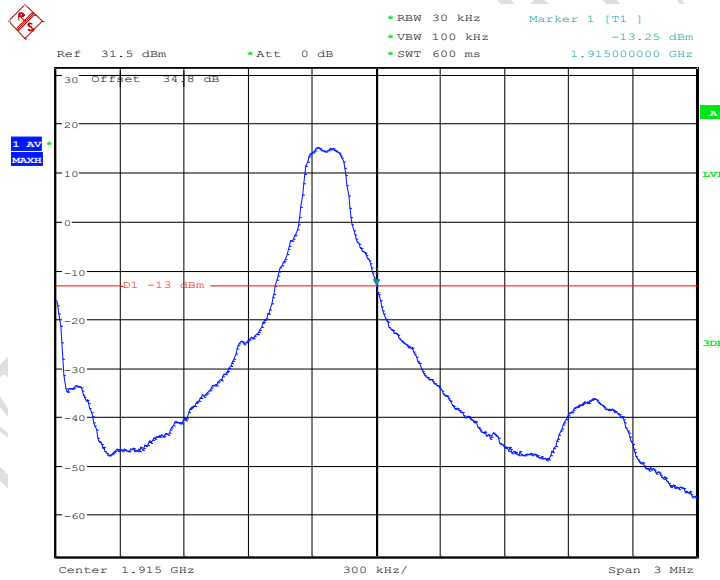

Date: 18.MAR.2016 16:18:45

LTE Band25, 3MHz bandwidth, QPSK,(1,15) Mode, Above 1915MHz

Report No.: B16W00042-FCC-RF

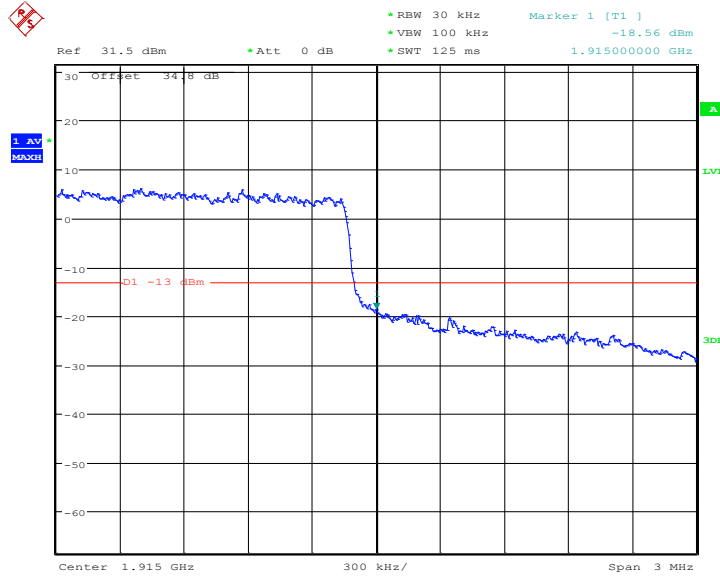

Date: 18.MAR.2016 16:20:06

LTE Band25, 3MHz bandwidth, QPSK,(15,0) Mode, Above 1915MHz

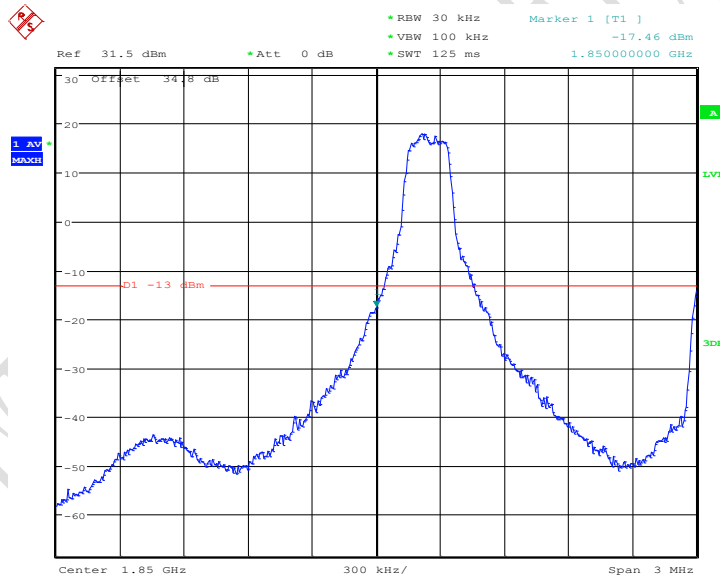

Date: 18.MAR.2016 16:16:45

LTE Band25, 3MHz bandwidth, 16QAM,(1,0) Mode, Below 1850MHz

Report No.: B16W00042-FCC-RF

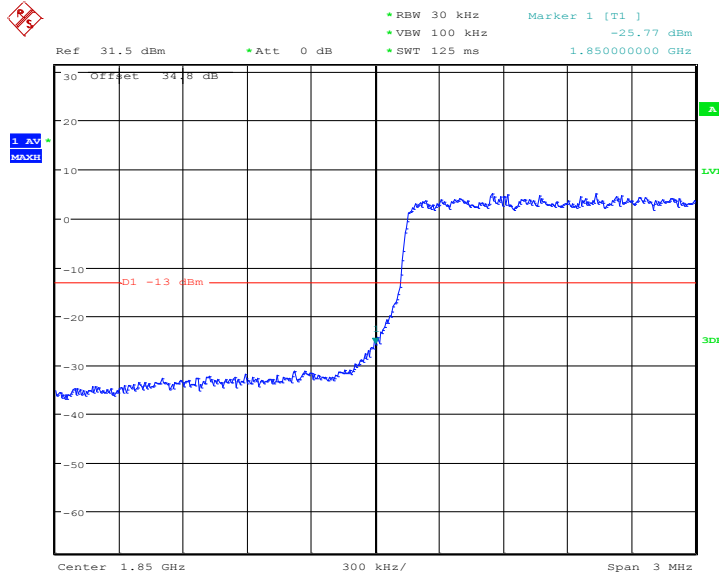

Date: 18.MAR.2016 16:17:02

LTE Band25, 3MHz bandwidth, 16QAM,(15,0) Mode , Below 1850MHz

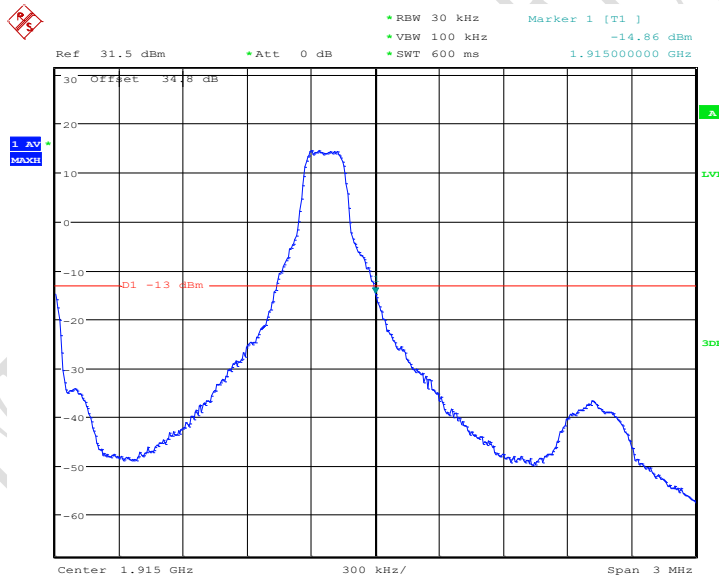

Date: 18.MAR.2016 16:19:17

LTE Band25, 3MHz bandwidth, 16QAM,(1,15) Mode, Above 1915MHz

Report No.: B16W00042-FCC-RF

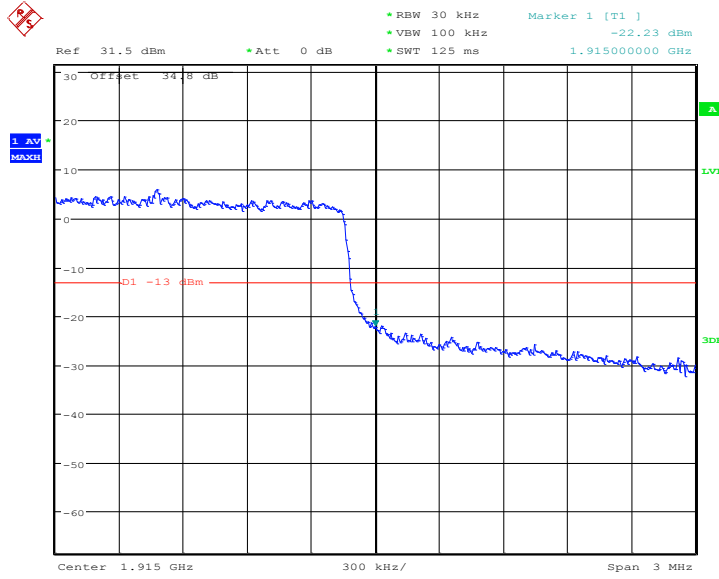

Date: 18.MAR.2016 16:19:42

LTE Band25, 3MHz bandwidth, 16QAM,(15,0) Mode, Above 1915MHz

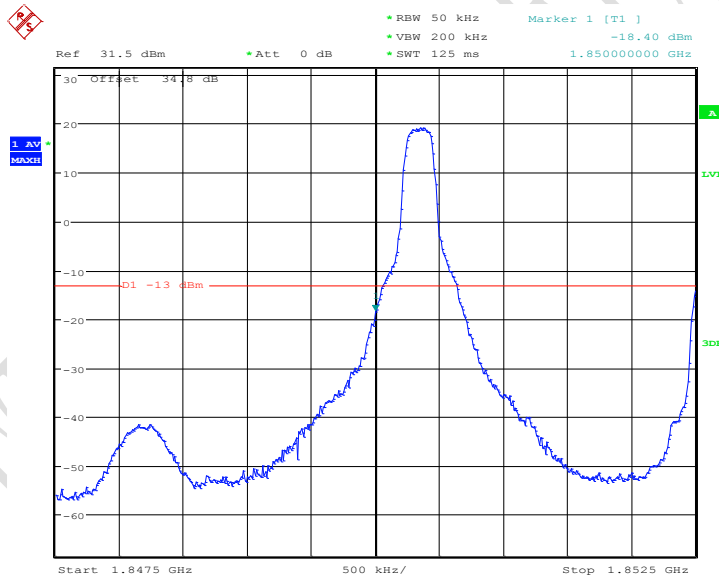

Date: 18.MAR.2016 16:22:01

LTE Band25, 5MHz bandwidth, QPSK,(1,0) Mode, Below 1850MHz

Report No.: B16W00042-FCC-RF

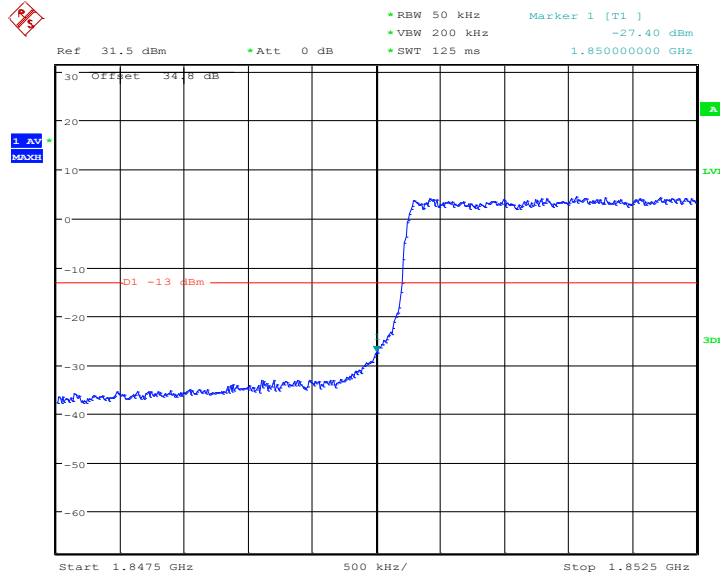

Date: 18.MAR.2016 16:23:00

LTE Band25, 5MHz bandwidth, QPSK,(25,0) Mode , Below 1850MHz

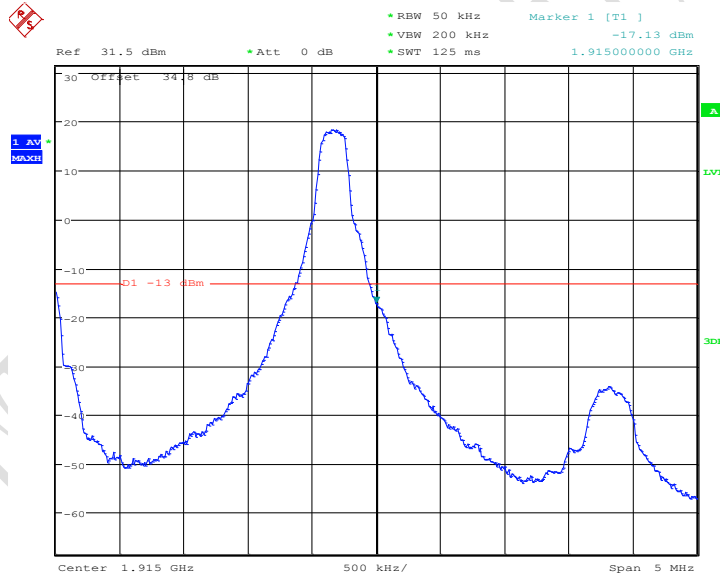

Date: 18.MAR.2016 16:25:43

LTE Band25, 5MHz bandwidth, QPSK,(1,25) Mode, Above 1915MHz

Report No.: B16W00042-FCC-RF

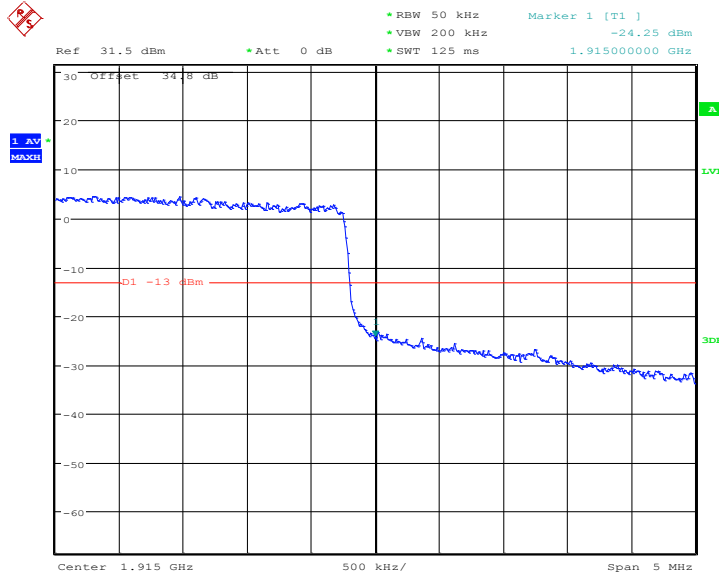

Date: 18.MAR.2016 16:26:27

LTE Band25, 5MHz bandwidth, QPSK,(25,0) Mode, Above 1915MHz

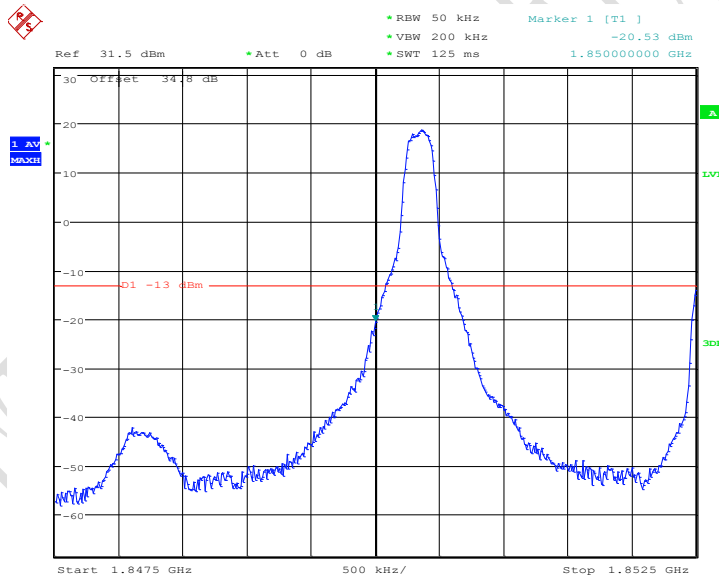

Date: 18.MAR.2016 16:22:24

LTE Band25, 5MHz bandwidth, 16QAM,(1,0) Mode, Below 1850MHz

Report No.: B16W00042-FCC-RF

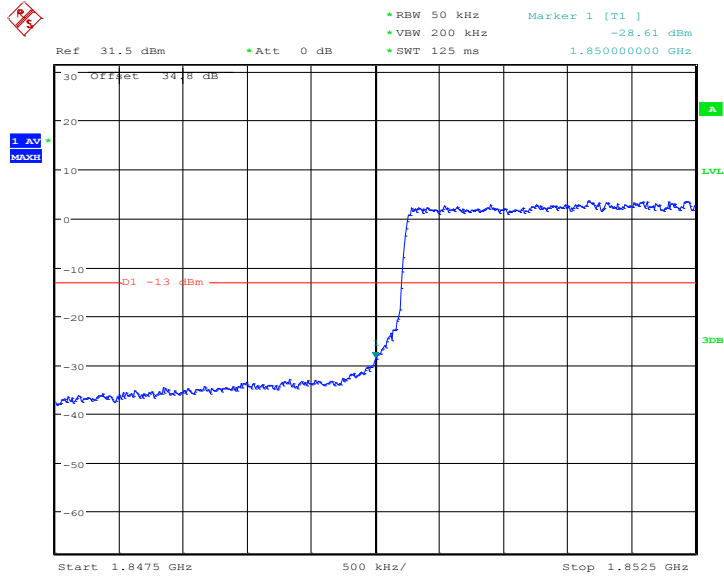

Date: 18.MAR.2016 16:22:45

LTE Band25, 5MHz bandwidth, 16QAM,(25,0) Mode , Below 1850MHz

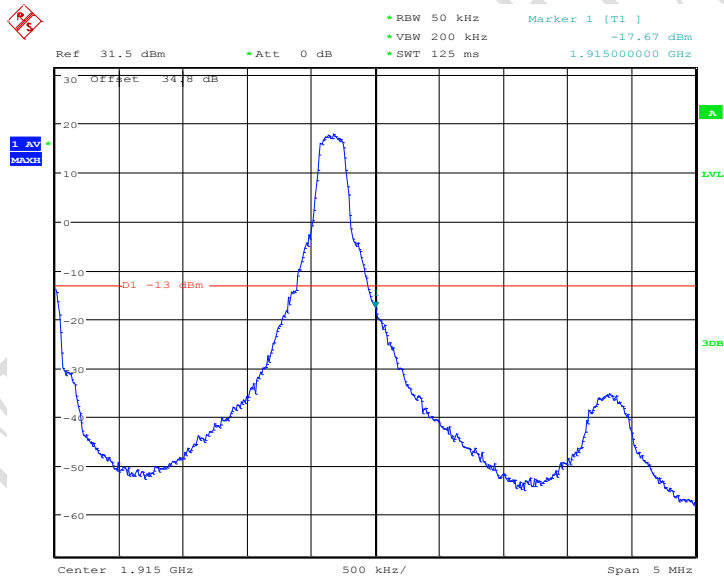

Date: 18.MAR.2016 16:25:57

LTE Band25, 5MHz bandwidth, 16QAM,(1,25) Mode, Above 1915MHz

Report No.: B16W00042-FCC-RF

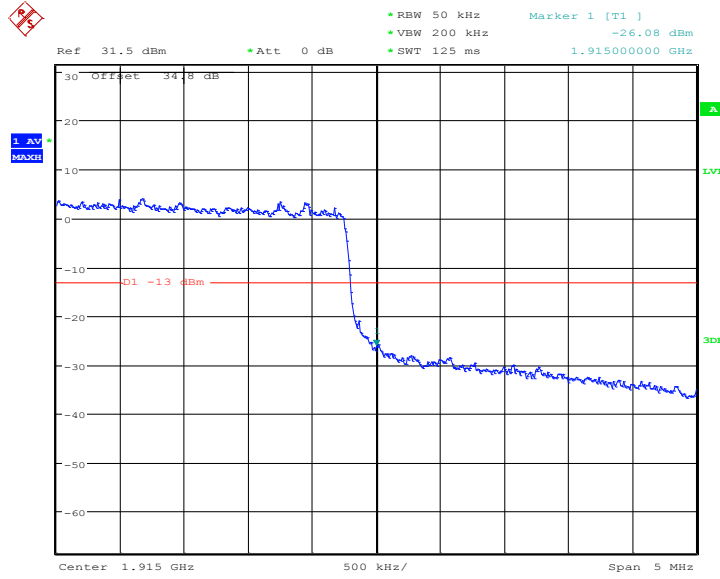

Date: 18.MAR.2016 16:26:12

LTE Band25, 5MHz bandwidth, 16QAM,(25,0) Mode, Above 1915MHz

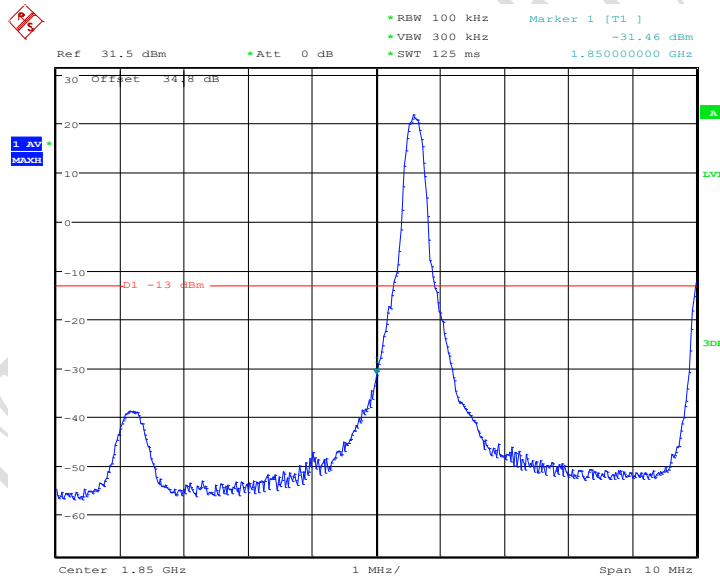

Date: 18.MAR.2016 16:27:58

LTE Band25, 10MHz bandwidth, QPSK,(1,0) Mode, Below 1850MHz

Report No.: B16W00042-FCC-RF

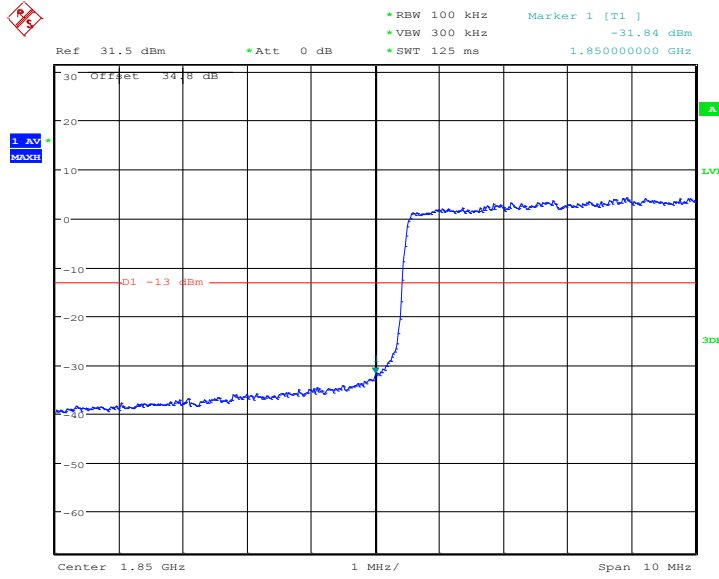

Date: 18.MAR.2016 16:28:46

LTE Band25, 10MHz bandwidth, QPSK,(50,0) Mode , Below 1850MHz

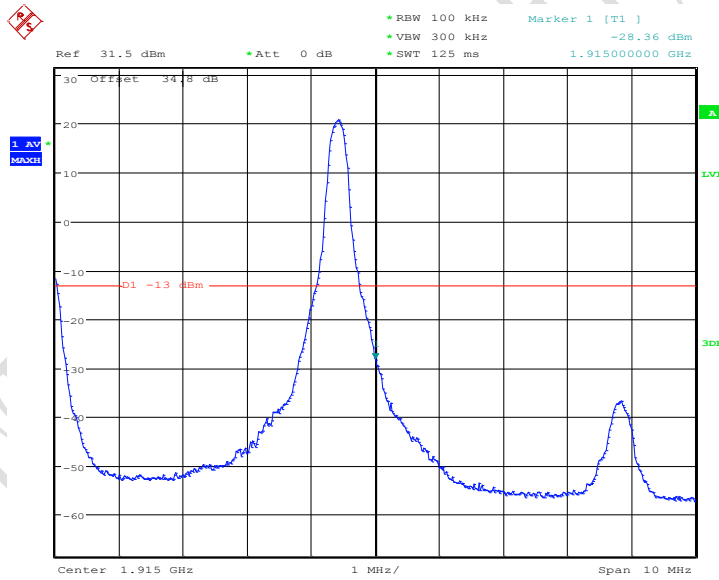

Date: 18.MAR.2016 16:29:57

LTE Band25, 10MHz bandwidth, QPSK,(1,50) Mode, Above 1915MHz

Report No.: B16W00042-FCC-RF

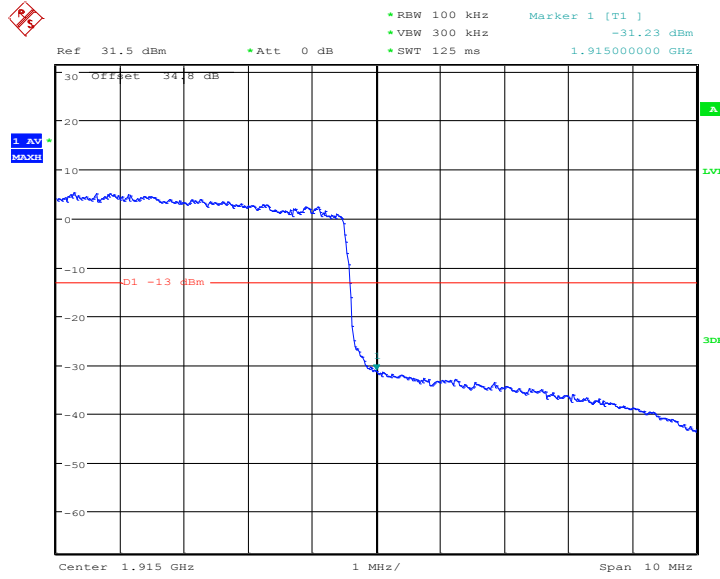

Date: 18.MAR.2016 16:30:38

LTE Band25, 10MHz bandwidth, QPSK,(50,0) Mode, Above 1915MHz

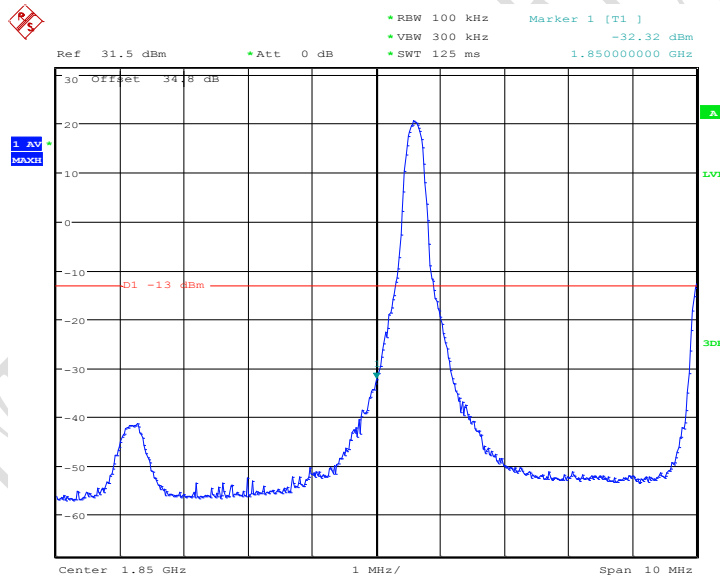

Date: 18.MAR.2016 16:28:17

LTE Band25, 10MHz bandwidth, 16QAM,(1,0) Mode, Below 1850MHz

Report No.: B16W00042-FCC-RF

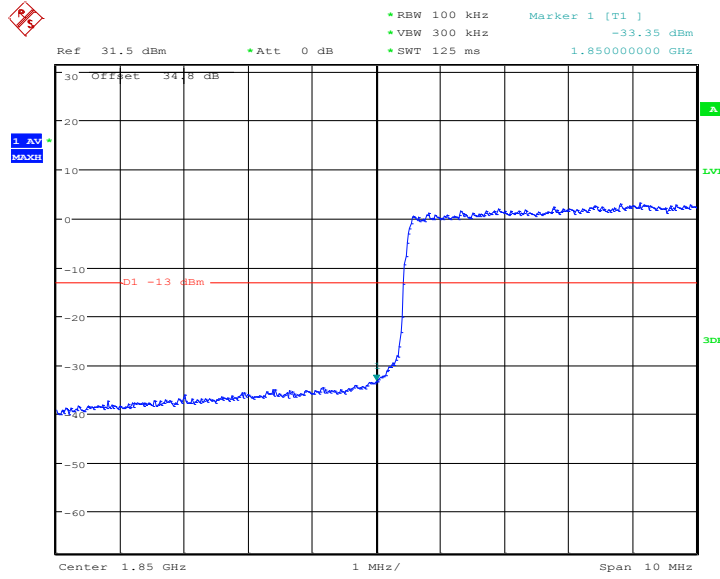

Date: 18.MAR.2016 16:28:33

LTE Band25, 10MHz bandwidth, 16QAM,(50,0) Mode , Below 185MHz

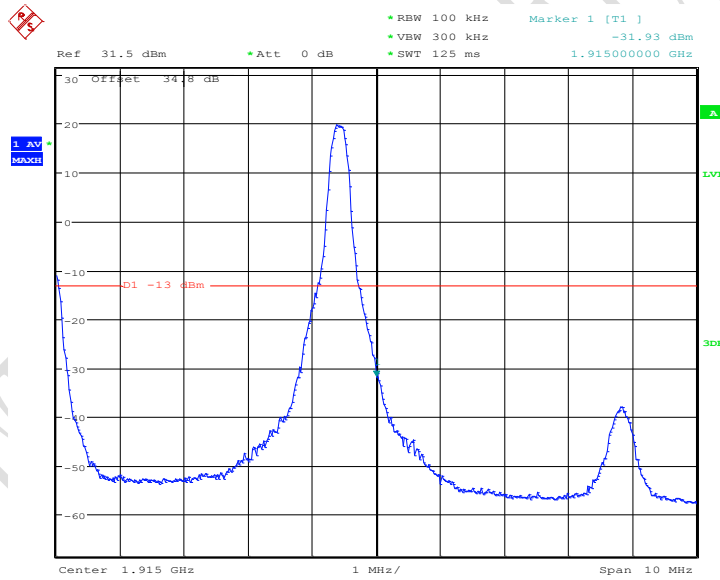

Date: 18.MAR.2016 16:30:10

LTE Band25, 10MHz bandwidth, 16QAM,(1,50) Mode , Above 1915MHz

Report No.: B16W00042-FCC-RF

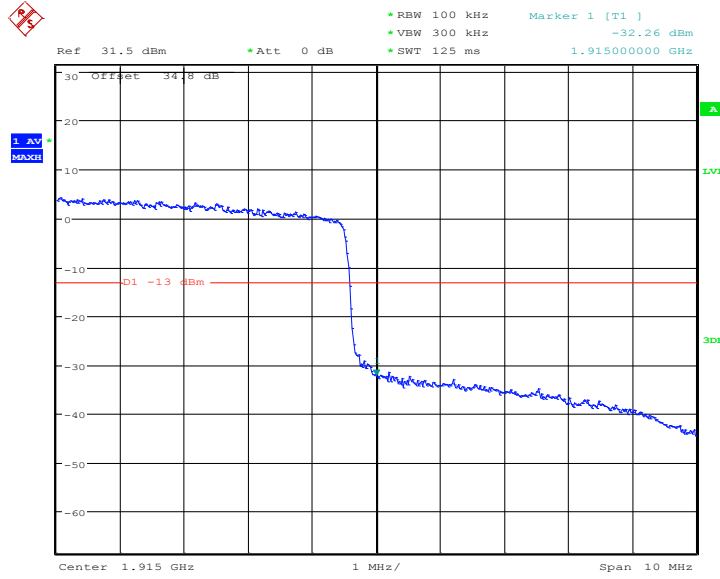

Date: 18.MAR.2016 16:30:25

LTE Band25, 10MHz bandwidth, 16QAM,(50,0) Mode, Above 1915MHz

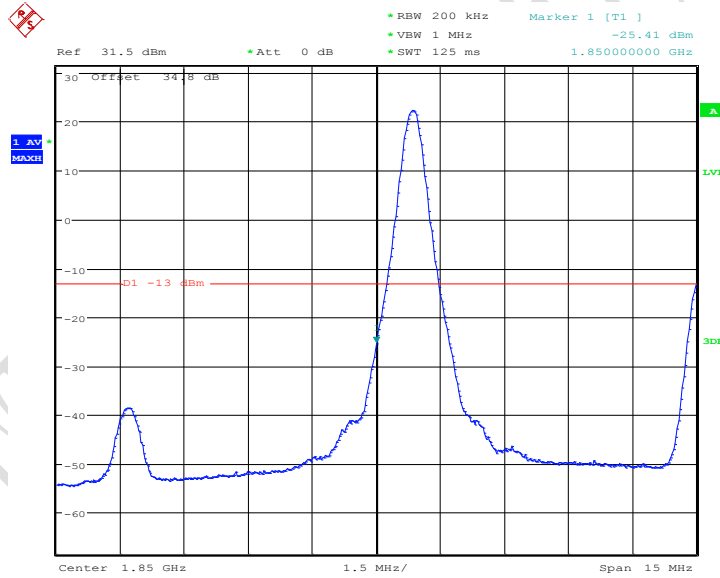

Date: 18.MAR.2016 16:32:33

LTE Band25, 15MHz bandwidth, QPSK,(1,0) Mode , Below 1850MHz

Report No.: B16W00042-FCC-RF

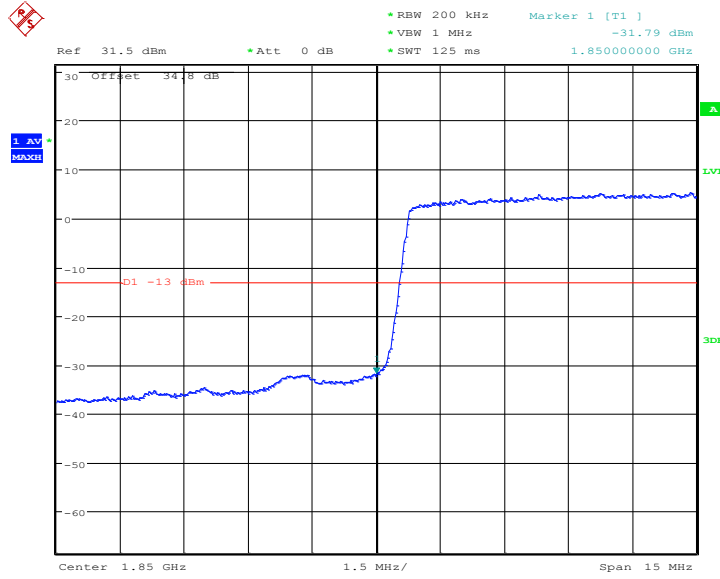

Date: 18.MAR.2016 16:33:14

LTE Band25, 15MHz bandwidth, QPSK,(75,0) Mode , Below 1850MHz

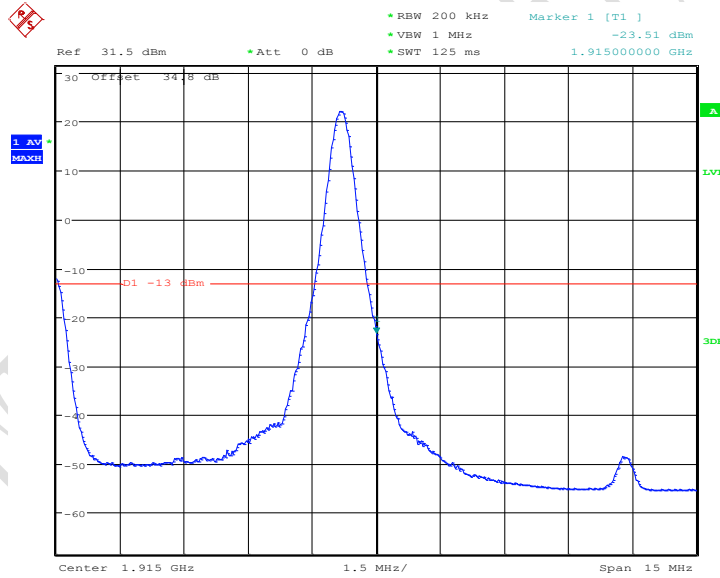

Date: 18.MAR.2016 16:34:03

LTE Band25, 15MHz bandwidth, QPSK,(1,75) Mode, Above 1915MHz

Report No.: B16W00042-FCC-RF

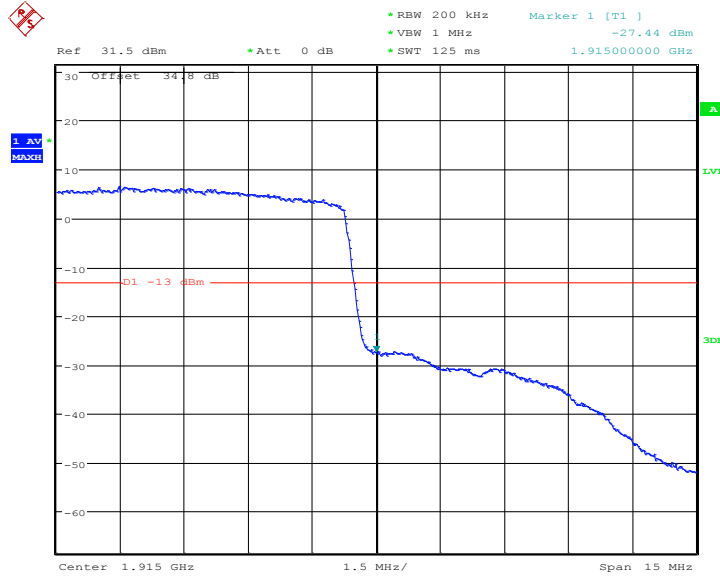

Date: 18.MAR.2016 16:34:45

LTE Band25, 15MHz bandwidth, QPSK,(75,0) Mode, Above 1915MHz

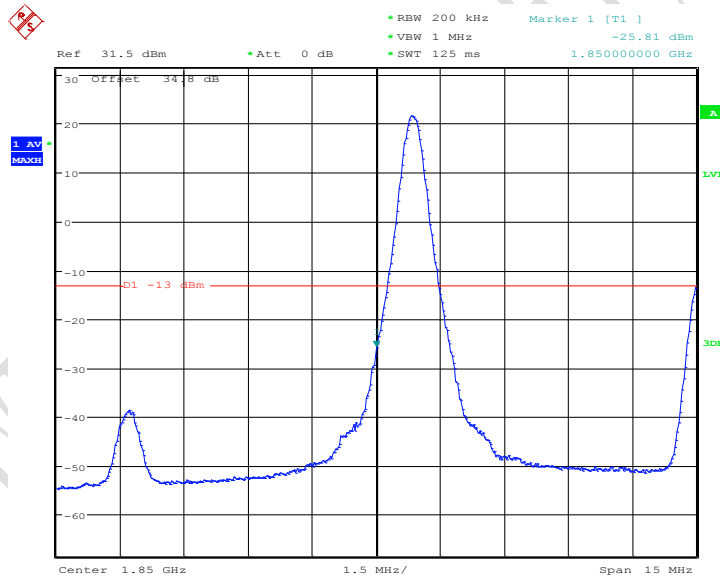

Date: 18.MAR.2016 16:32:46

LTE Band25, 15MHz bandwidth, 16QAM,(1,0) Mode, Below 1850MHz

Report No.: B16W00042-FCC-RF

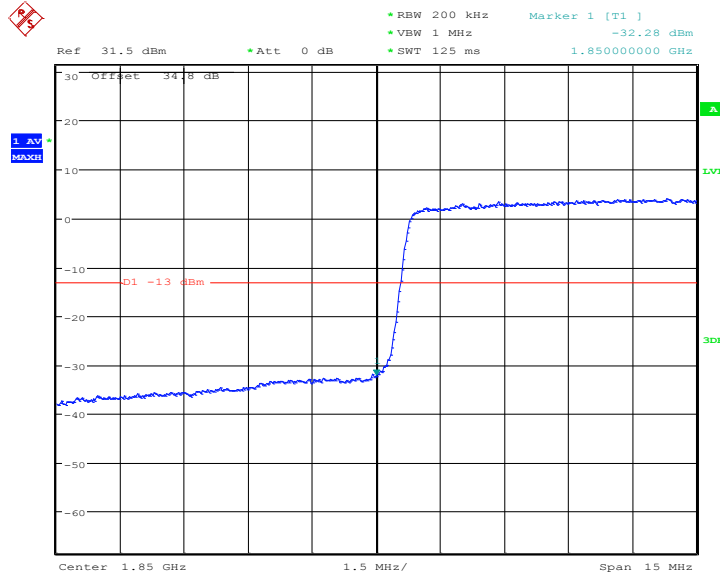

Date: 18.MAR.2016 16:33:02

LTE Band25, 15MHz bandwidth, 16QAM,(75,0) Mode , Below 1850MHz

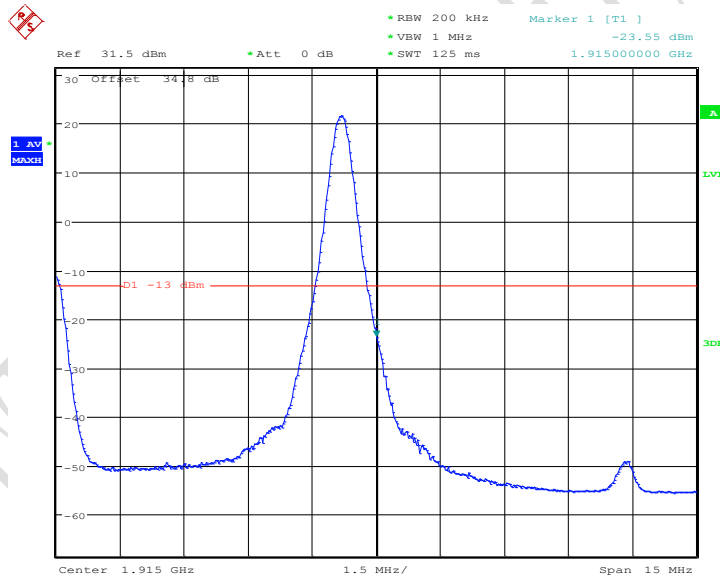

Date: 18.MAR.2016 16:34:20

LTE Band25, 15MHz bandwidth, 16QAM,(1,75) Mode, Above 1915MHz

Report No.: B16W00042-FCC-RF

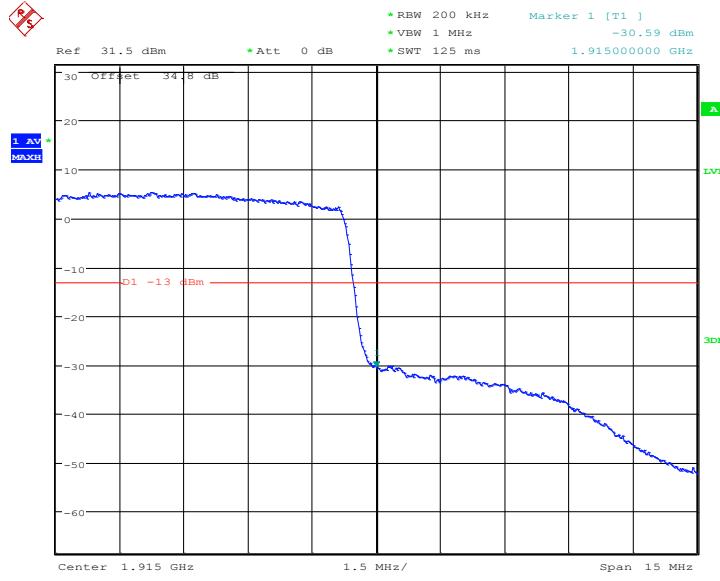

Date: 18.MAR.2016 16:34:33

LTE Band25, 15MHz bandwidth, 16QAM,(75,0) Mode, Above 1915MHz

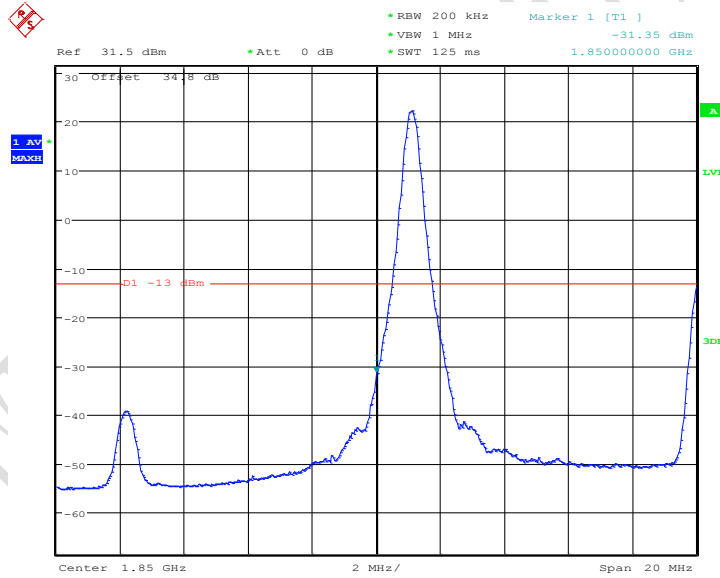

Date: 18.MAR.2016 16:36:09

LTE Band25, 20MHz bandwidth, QPSK,(1,0) Mode , Below 1850MHz

Report No.: B16W00042-FCC-RF

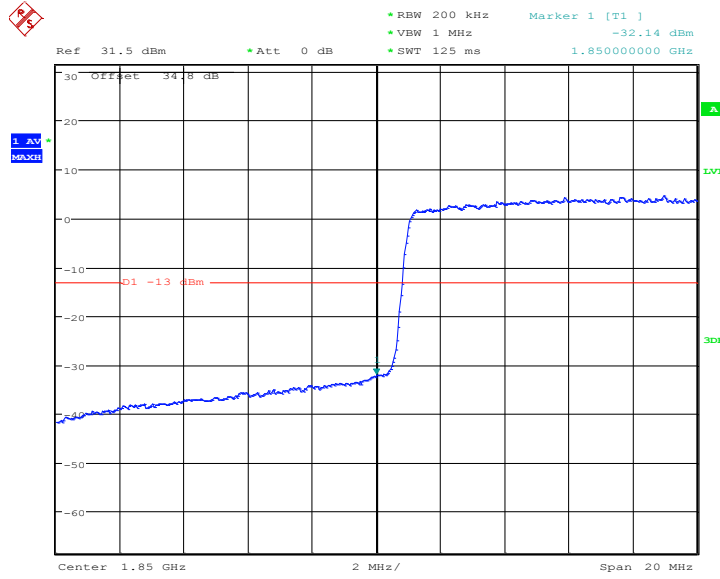

Date: 18.MAR.2016 16:36:45

LTE Band25, 20MHz bandwidth, QPSK,(100,0) Mode , Below 1850MHz

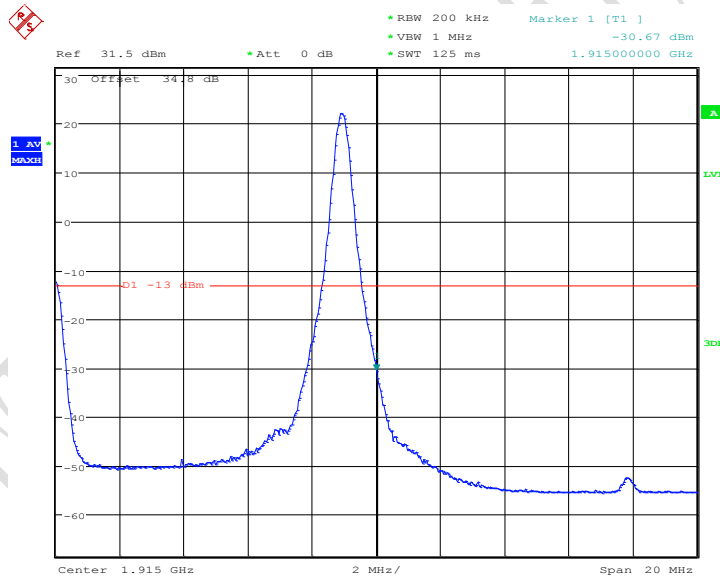

Date: 18.MAR.2016 16:37:41

LTE Band25, 20MHz bandwidth, QPSK,(1,100) Mode , Above 1915MHz

Report No.: B16W00042-FCC-RF

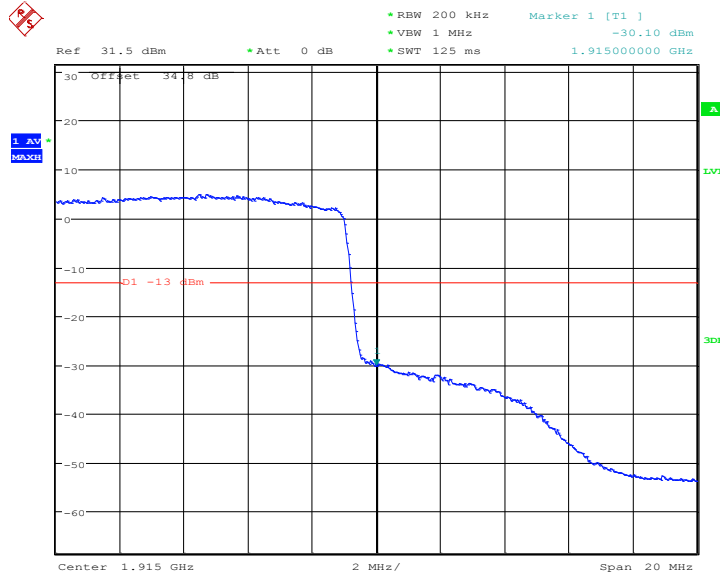

Date: 18.MAR.2016 16:38:19

LTE Band25, 20MHz bandwidth, QPSK,(100,0) Mode, Above 1915MHz

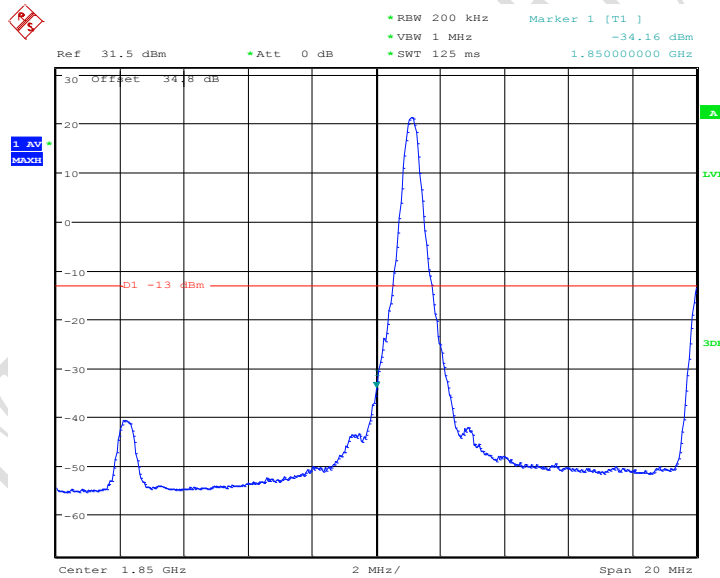

Date: 18.MAR.2016 16:36:20

LTE Band25, 20MHz bandwidth, 16QAM,(1,0) Mode , Below 1850MHz

Report No.: B16W00042-FCC-RF

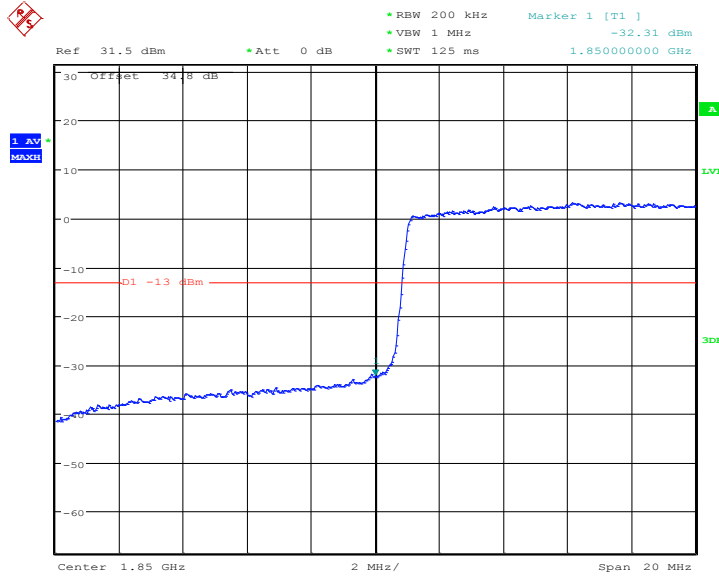

Date: 18.MAR.2016 16:36:34

LTE Band25, 20MHz bandwidth, 16QAM,(100,0) Mode , Below 1850MHz

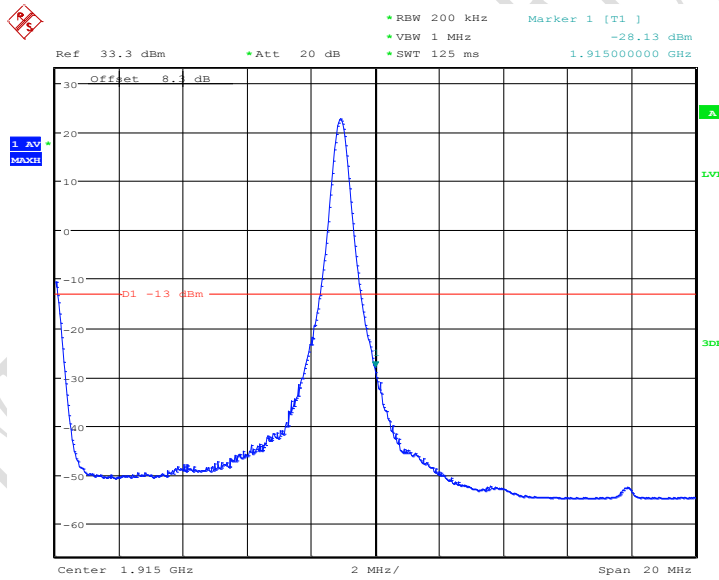

Date: 24.MAR.2016 14:05:21

LTE Band25, 20MHz bandwidth, 16QAM,(1,100) Mode, Above 1915MHz

Report No.: B16W00042-FCC-RF

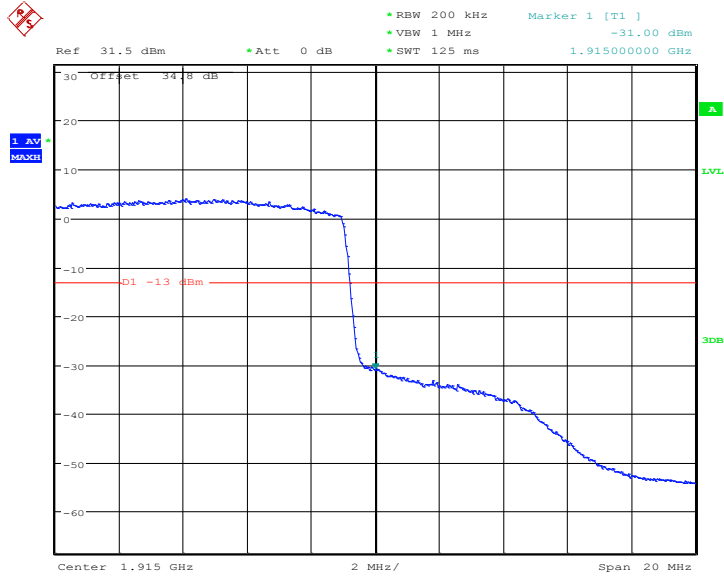

Date: 18.MAR.2016 16:38:08

LTE Band25, 20MHz bandwidth, 16QAM,100,0) Mode, Above 1915MHz

CITL TEST REPORT

5.5.13 LTE B26 Band Edge Results

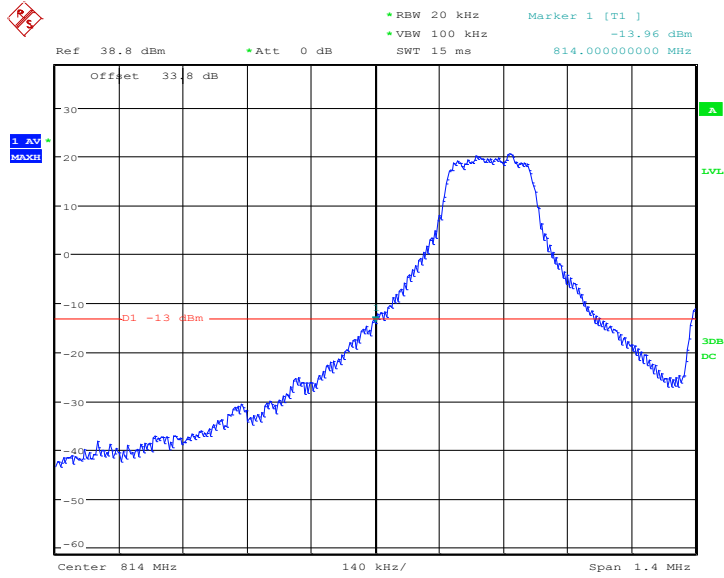

Date: 23.MAR.2016 20:38:44

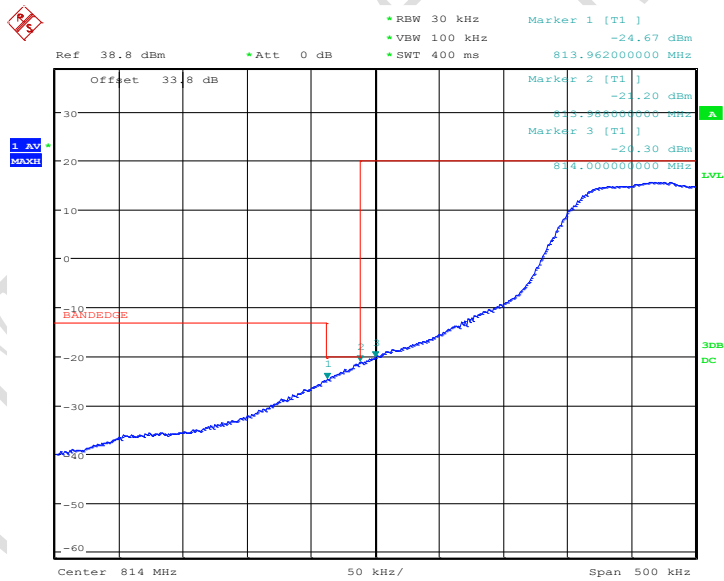

Date: 23.MAR.2016 21:08:34

LTE Band26, 1.4MHz bandwidth, QPSK,(1,0) Mode , Below 814MHz

Report No.: B16W00042-FCC-RF

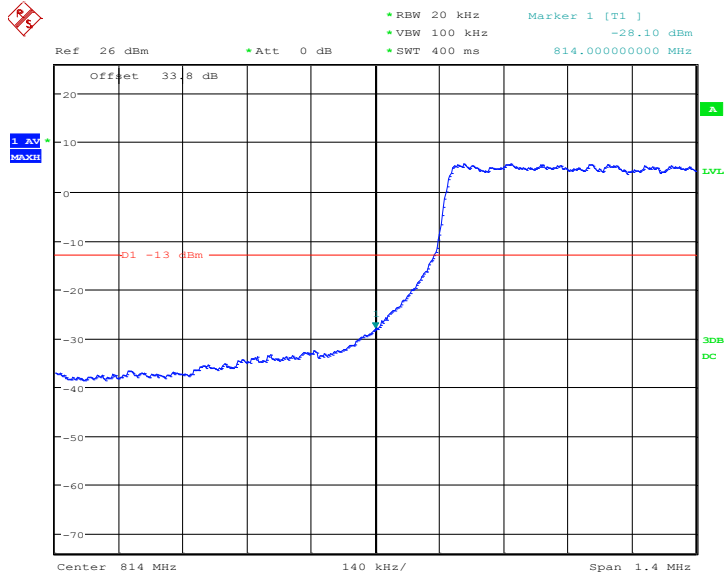

Date: 23.MAR.2016 21:10:42

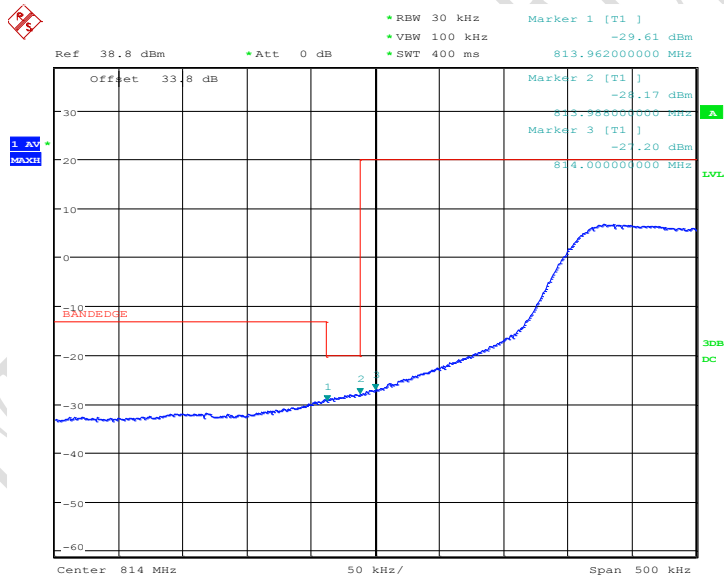

Date: 23.MAR.2016 21:09:18

LTE Band26, 1.4MHz bandwidth, QPSK,(6,0) Mode , Below 814MHz

Report No.: B16W00042-FCC-RF

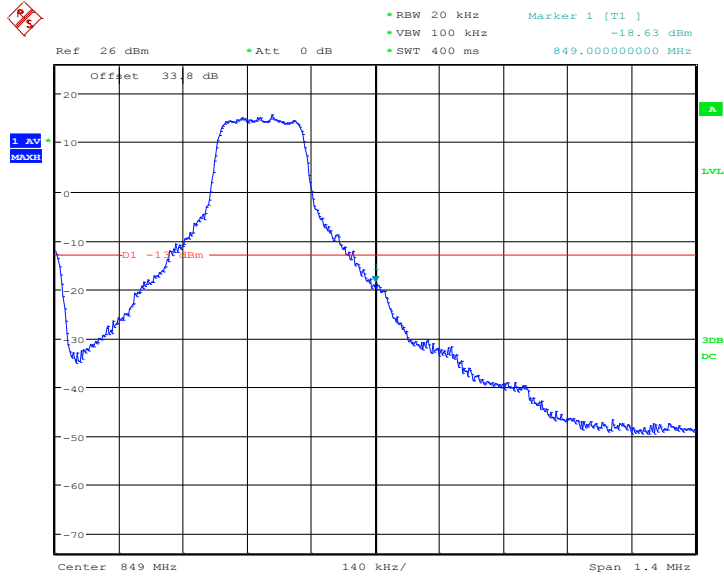

Date: 23.MAR.2016 21:12:35

LTE Band26, 1.4MHz bandwidth, QPSK,(1,6) Mode, Above 849MHz

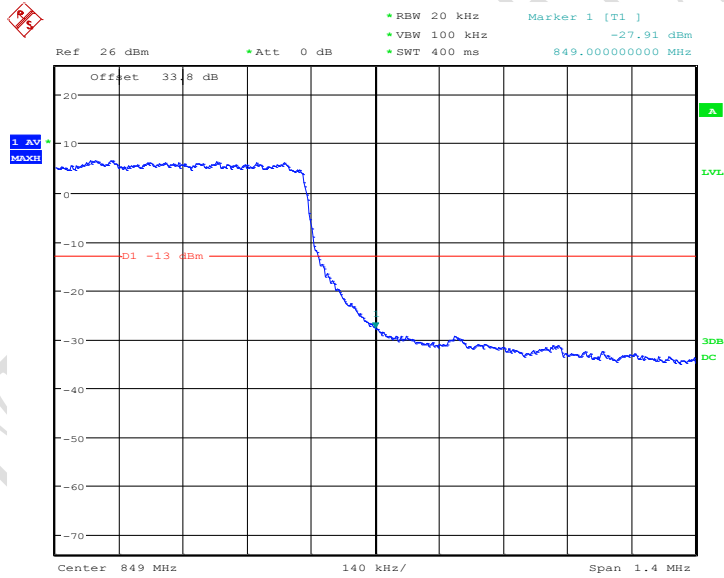

Date: 23.MAR.2016 21:14:06

LTE Band26, 1.4MHz bandwidth, QPSK,(6,0) Mode, Above 849MHz

Report No.: B16W00042-FCC-RF

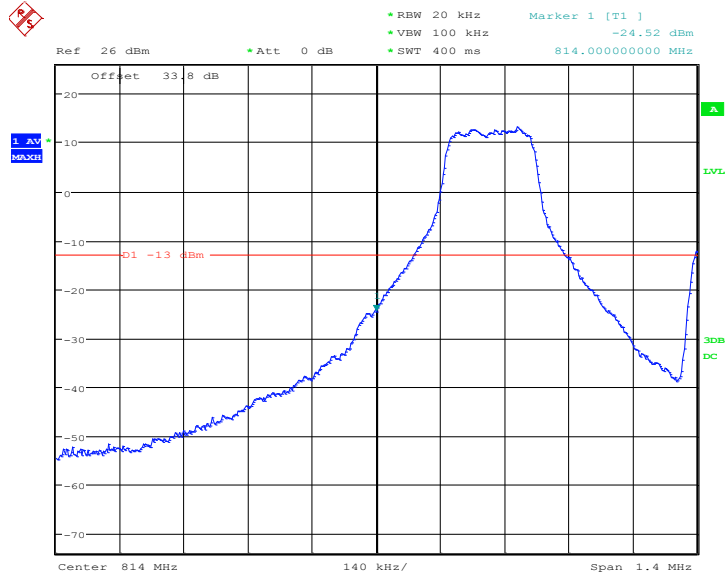

Date: 23.MAR.2016 21:14:58

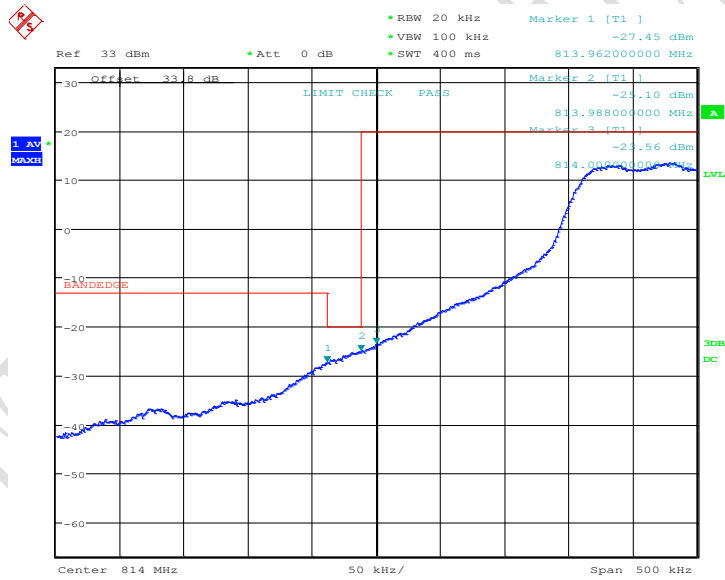

Date: 23.MAR.2016 21:40:13

LTE Band26, 1.4MHz bandwidth, 16QAM,(1,0) Mode , Below 814MHz

Report No.: B16W00042-FCC-RF

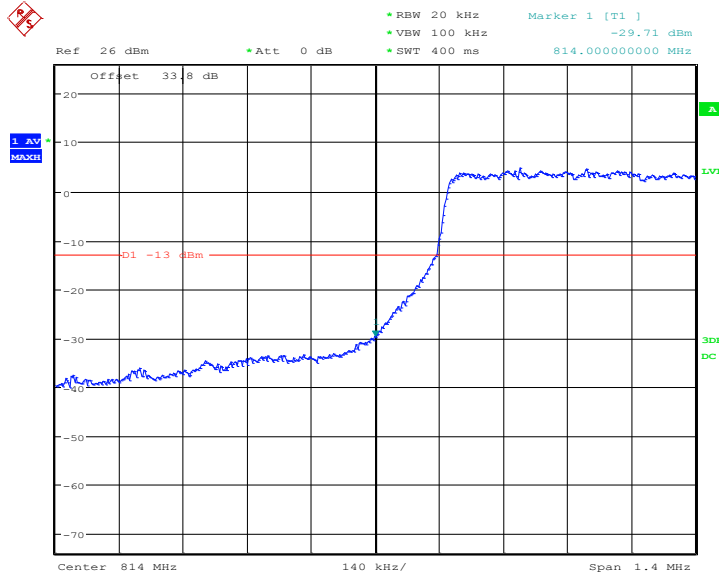

Date: 23.MAR.2016 21:15:12

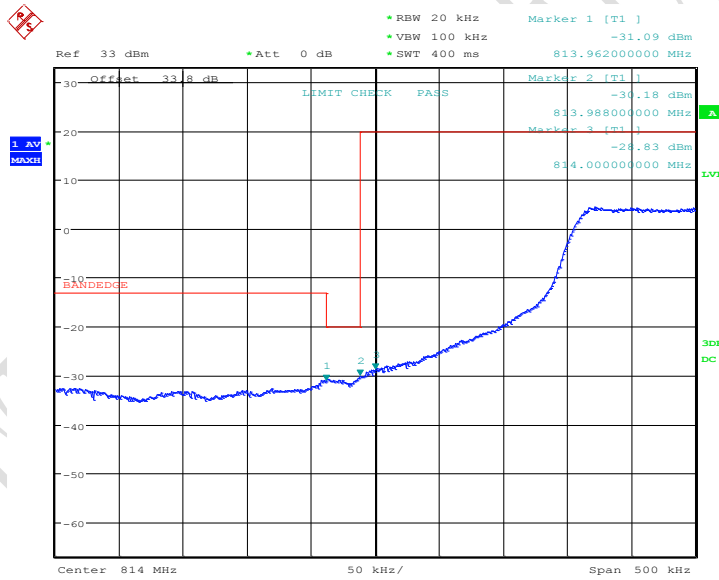

Date: 23.MAR.2016 21:40:41

LTE Band26, 1.4MHz bandwidth, 16QAM,(6,0) Mode , Below 814MHz

Report No.: B16W00042-FCC-RF

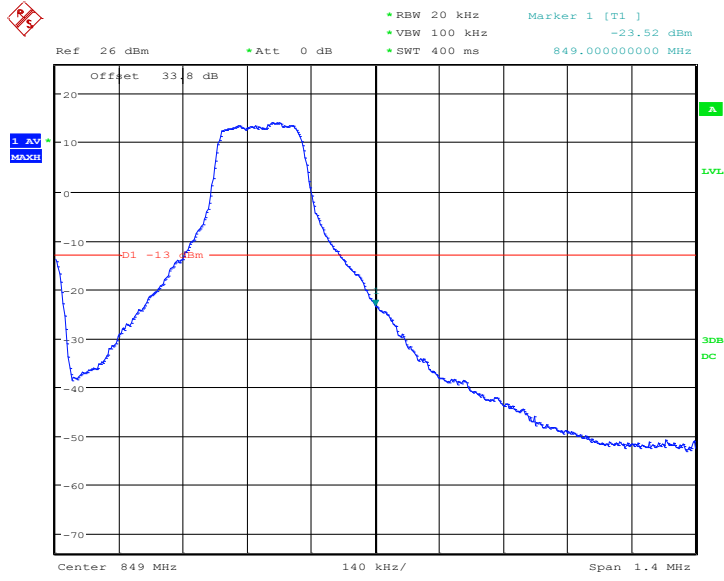

Date: 23.MAR.2016 21:13:26

LTE Band26, 1.4MHz bandwidth, 16QAM,(1,6) Mode, Above 849MHz

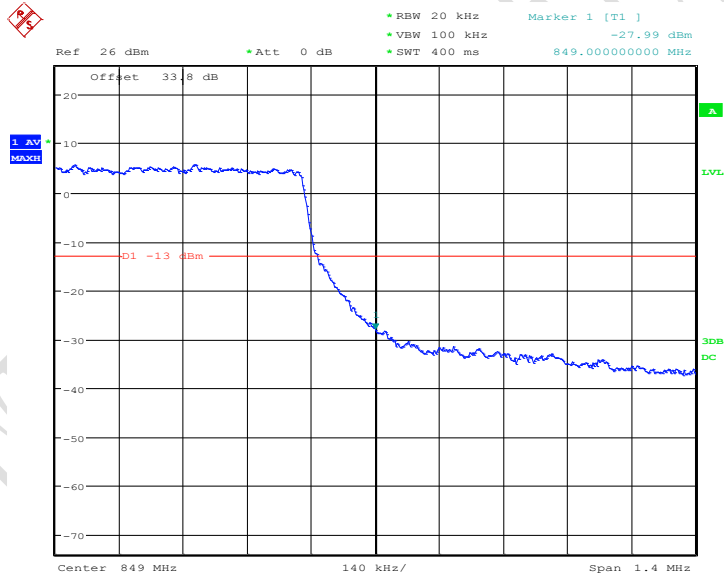

Date: 23.MAR.2016 21:13:48

LTE Band26, 1.4MHz bandwidth, 16QAM,(6,0) Mode, Above 849MHz

Report No.: B16W00042-FCC-RF

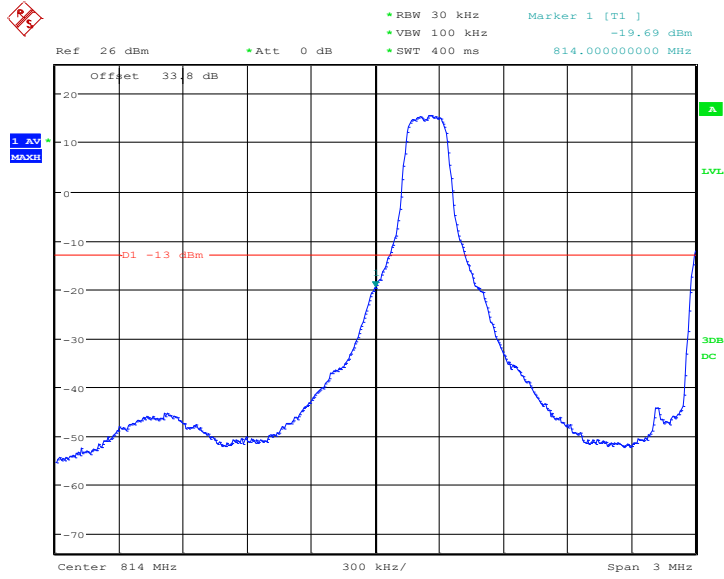

Date: 23.MAR.2016 21:19:20

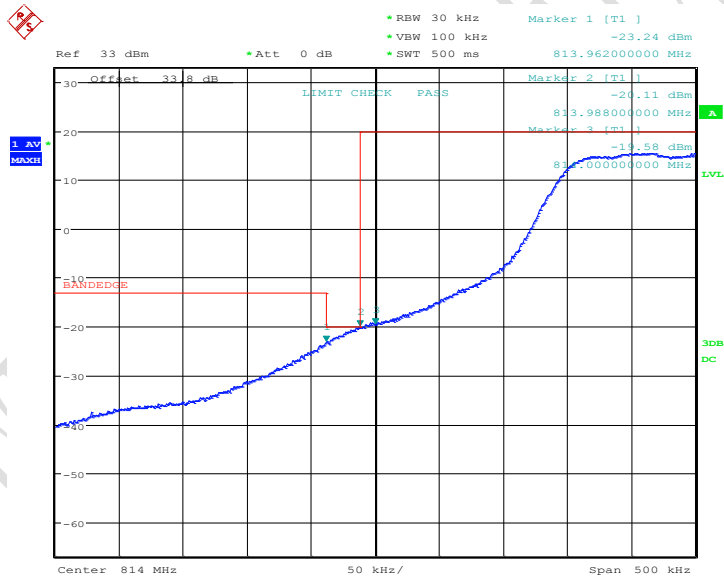

Date: 23.MAR.2016 21:42:47

LTE Band26, 3MHz bandwidth, QPSK,(1,0) Mode , Below 814MHz

Report No.: B16W00042-FCC-RF

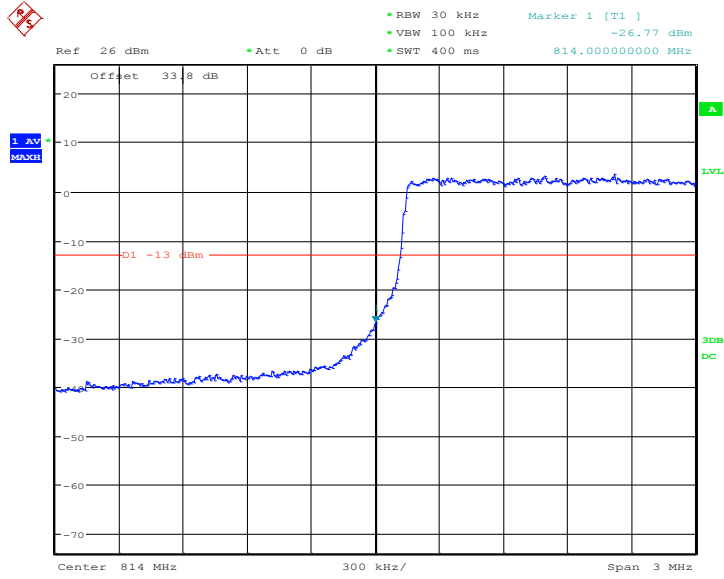

Date: 23.MAR.2016 21:19:36

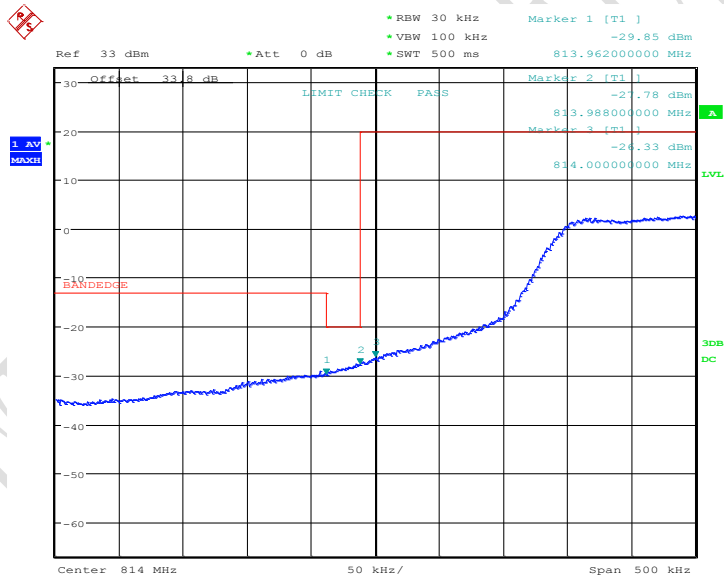

Date: 23.MAR.2016 21:43:08

LTE Band26, 3MHz bandwidth, QPSK,(15,0) Mode , Below 814MHz

Report No.: B16W00042-FCC-RF

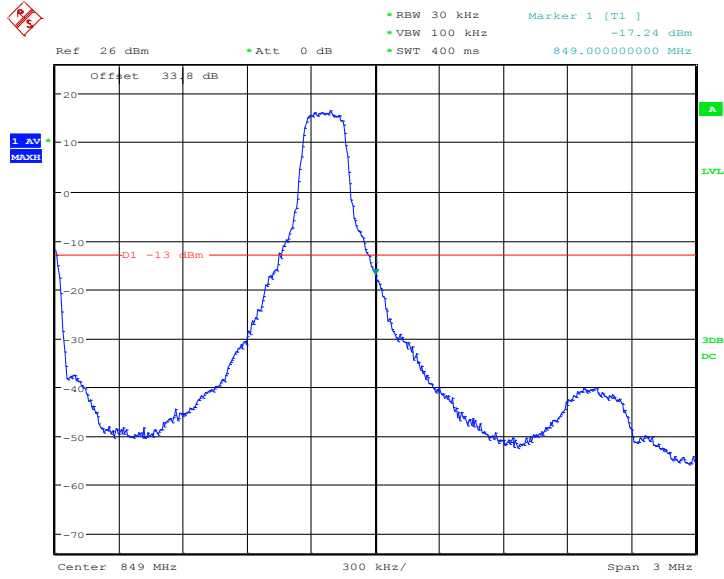

Date: 23.MAR.2016 21:22:00

LTE Band26, 3MHz bandwidth, QPSK,(1,15) Mode, Above 849MHz

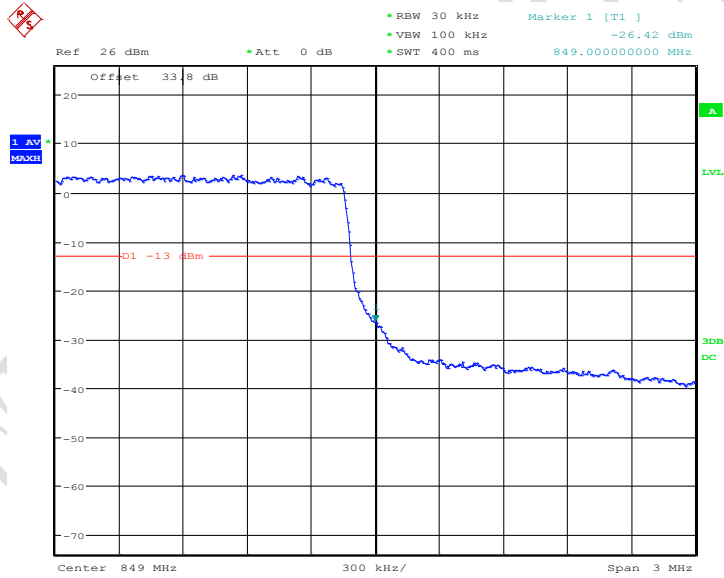

Date: 23.MAR.2016 21:21:45

LTE Band26, 3MHz bandwidth, QPSK,(15,0) Mode, Above 849MHz

Report No.: B16W00042-FCC-RF

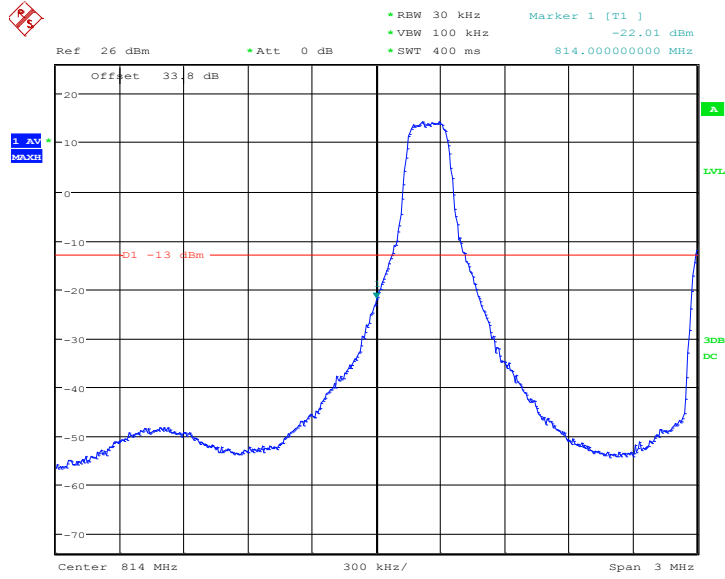

Date: 23.MAR.2016 21:20:13

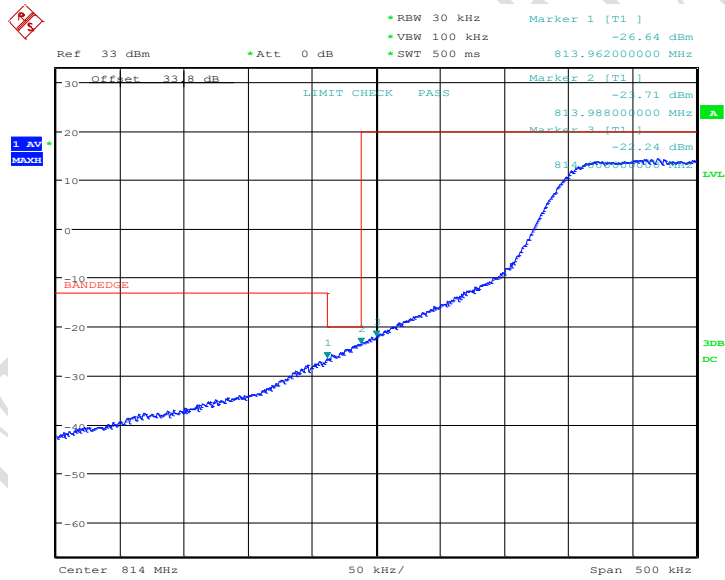

Date: 23.MAR.2016 21:43:49

LTE Band26, 3MHz bandwidth, 16QAM,(1,0) Mode , Below 814MHz

Report No.: B16W00042-FCC-RF

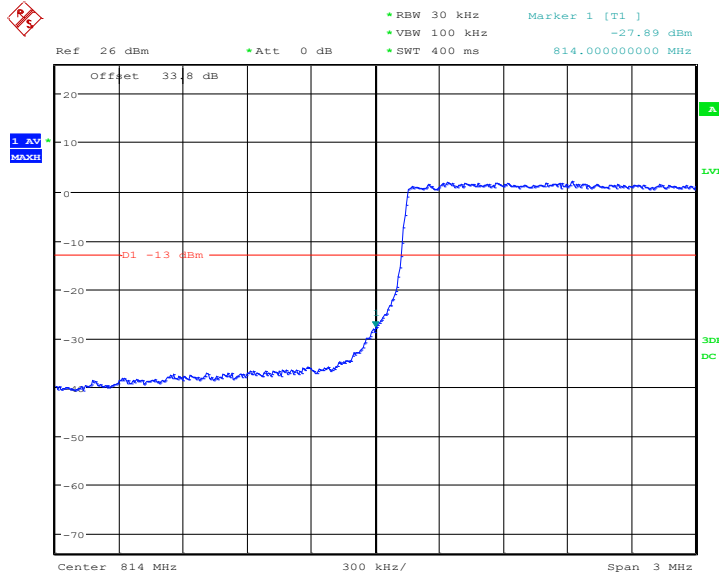

Date: 23.MAR.2016 21:19:59

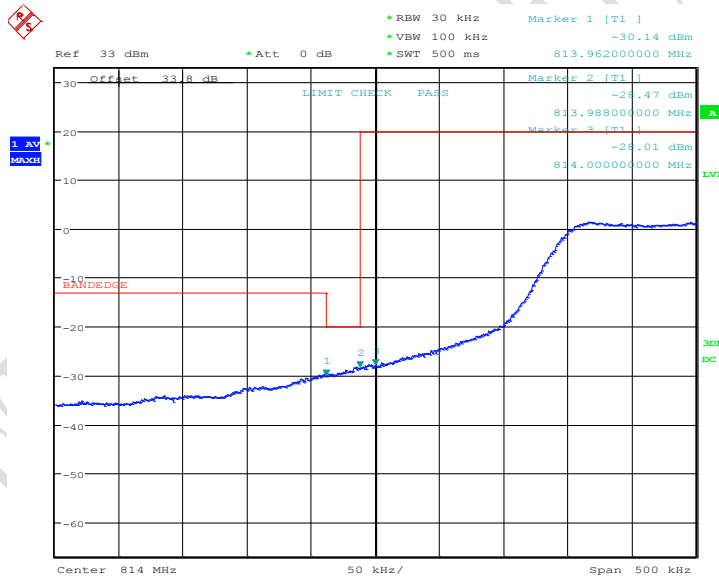

Date: 23.MAR.2016 21:43:29

LTE Band26, 3MHz bandwidth, 16QAM,(15,0) Mode , Below 814MHz

Report No.: B16W00042-FCC-RF

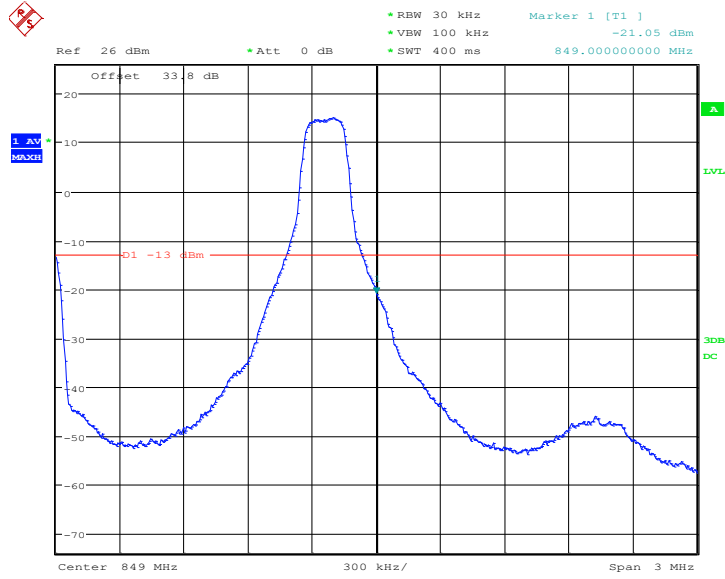

Date: 23.MAR.2016 21:21:14

LTE Band26, 3MHz bandwidth, 16QAM,(1,15) Mode, Above 849MHz

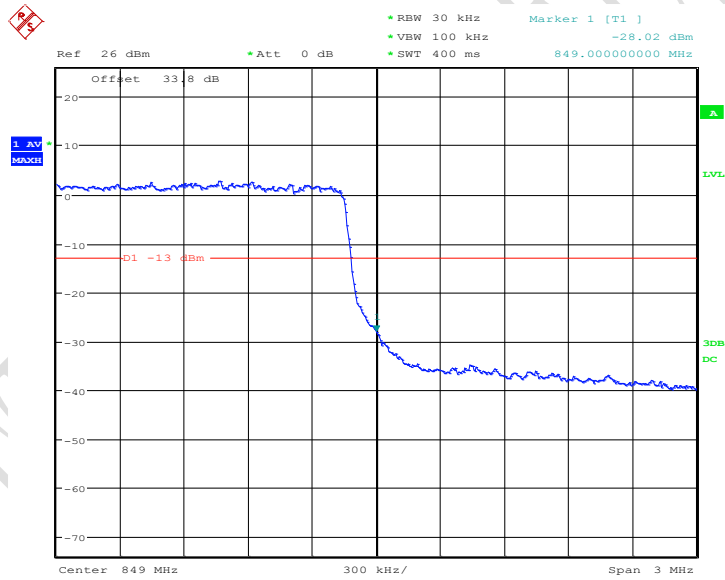

Date: 23.MAR.2016 21:21:28

LTE Band26, 3MHz bandwidth, 16QAM,(15,0) Mode, Above 849MHz

Report No.: B16W00042-FCC-RF

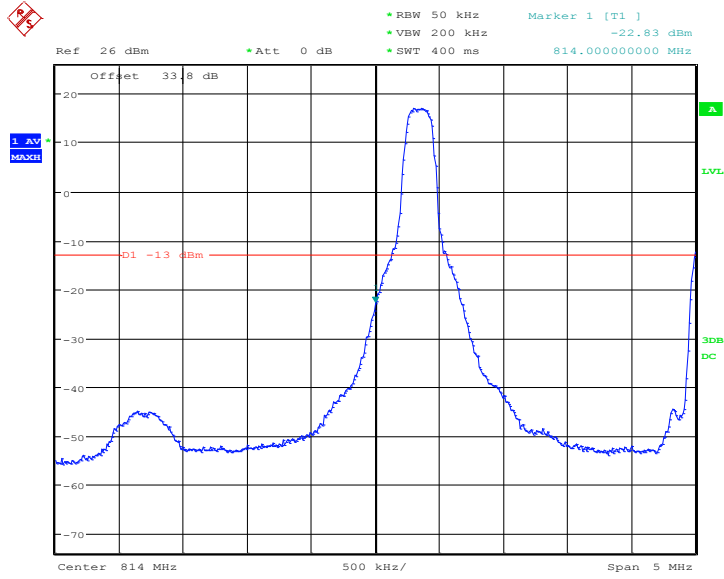

Date: 23.MAR.2016 21:23:54

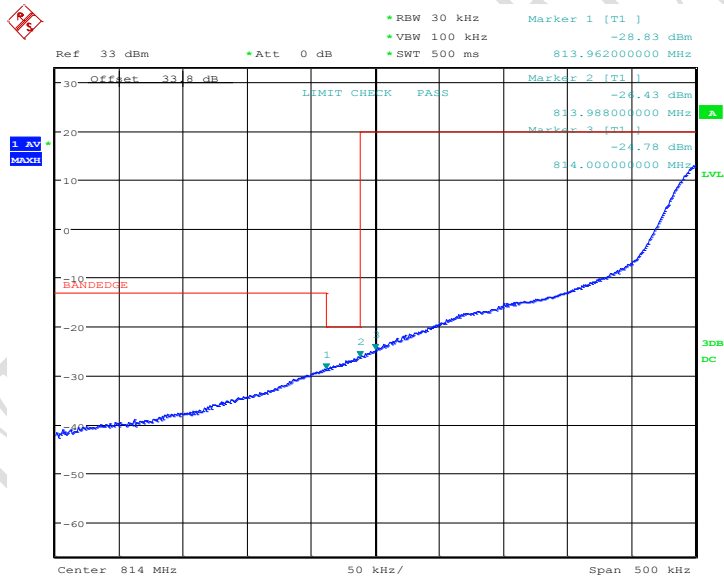

Date: 23.MAR.2016 21:46:07

LTE Band26, 5MHz bandwidth, QPSK,(1,0) Mode , Below 814MHz

Report No.: B16W00042-FCC-RF

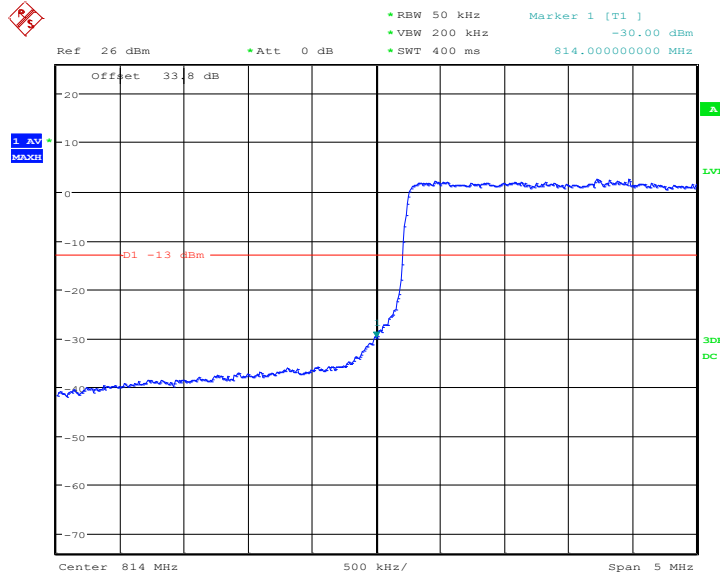

Date: 23.MAR.2016 21:24:08

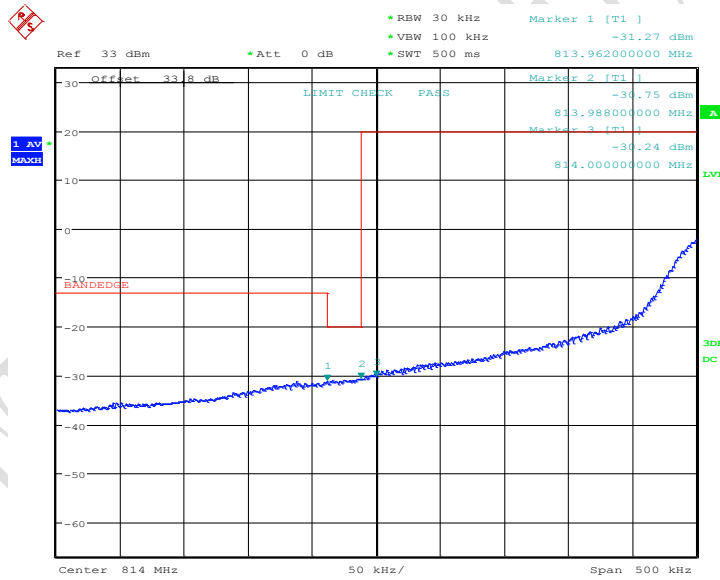

Date: 23.MAR.2016 21:46:33

LTE Band26, 5MHz bandwidth, QPSK,(25,0) Mode , Below 814MHz

Report No.: B16W00042-FCC-RF

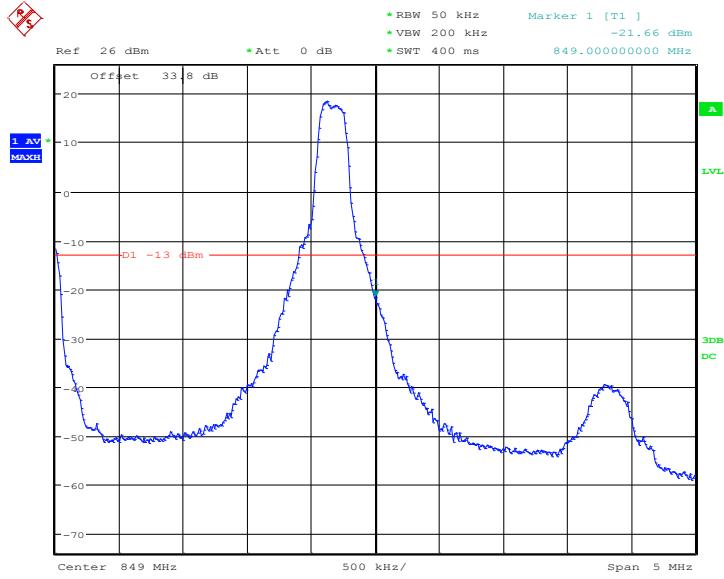

Date: 23.MAR.2016 21:26:56

LTE Band26, 5MHz bandwidth, QPSK,(1,25) Mode, Above 849MHz

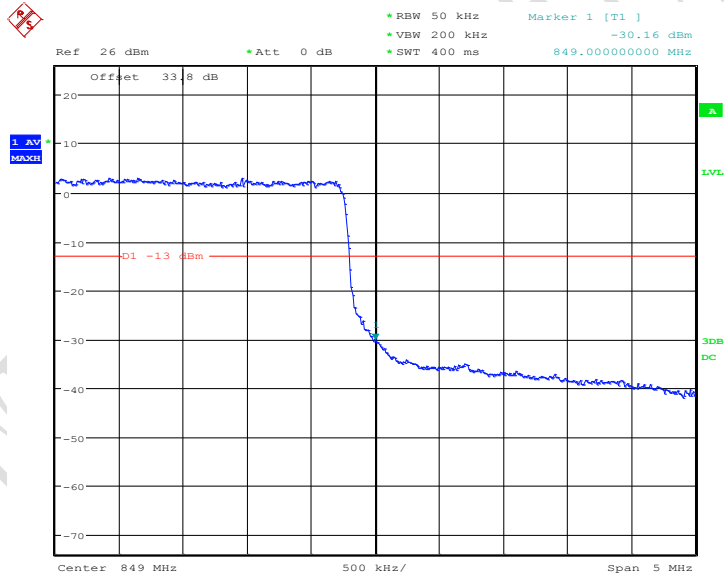

Date: 23.MAR.2016 21:26:37

LTE Band26, 5MHz bandwidth, QPSK,(25,0) Mode, Above 849MHz

Report No.: B16W00042-FCC-RF

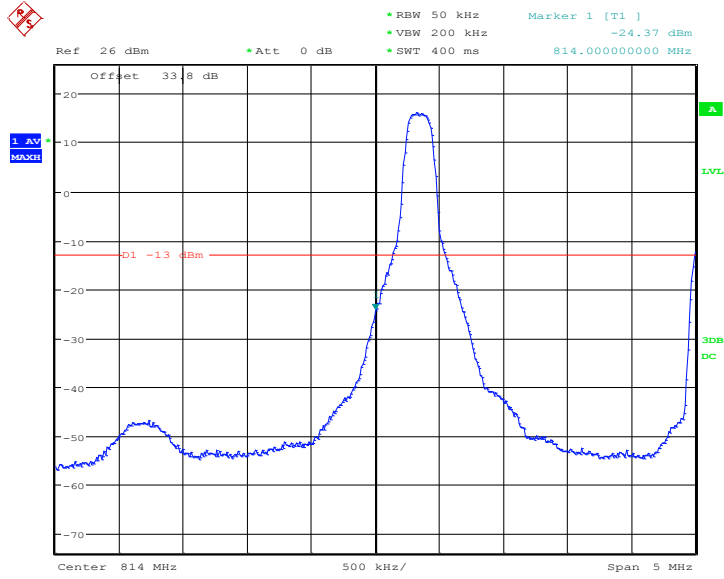

Date: 23.MAR.2016 21:24:37

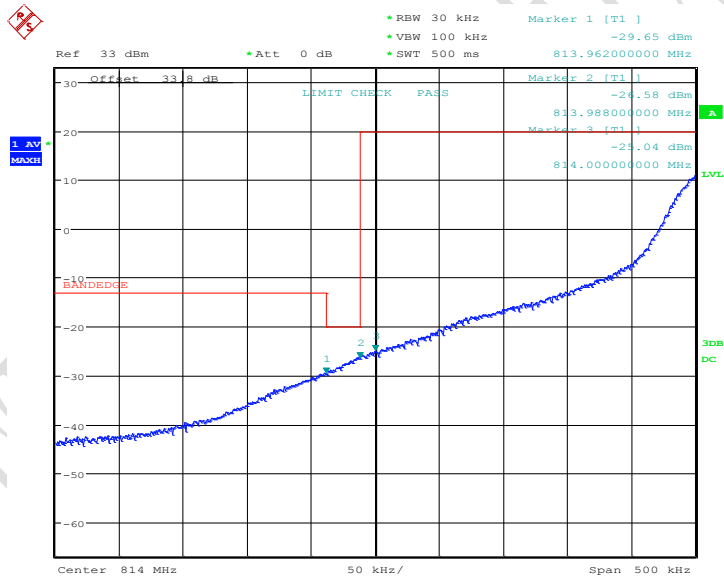

Date: 23.MAR.2016 21:47:21

LTE Band26, 5MHz bandwidth, 16QAM,(1,0) Mode , Below 814MHz

Report No.: B16W00042-FCC-RF

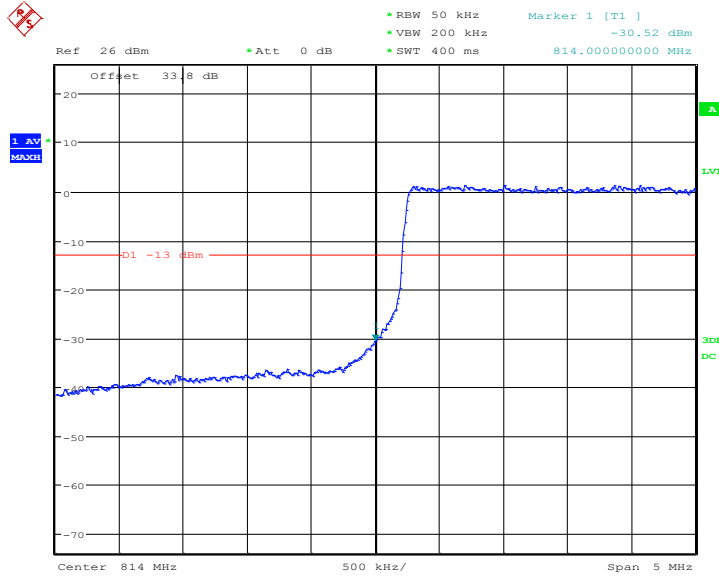

Date: 23.MAR.2016 21:24:22

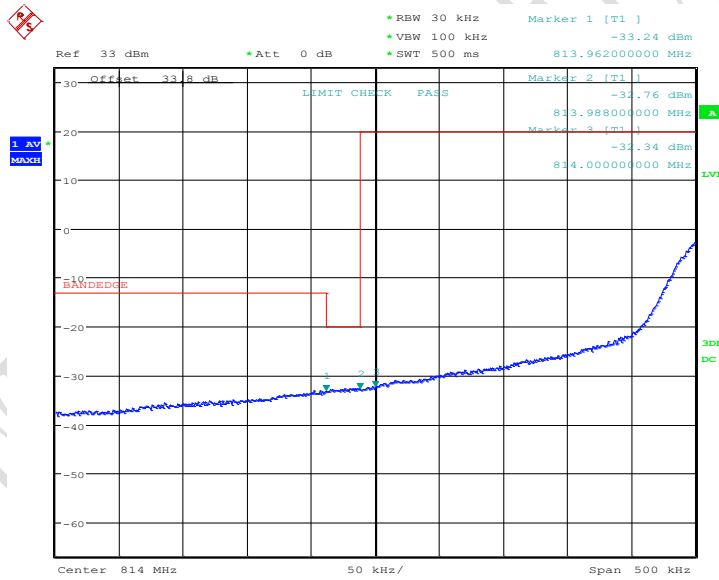

Date: 23.MAR.2016 21:46:55

LTE Band26, 5MHz bandwidth, 16QAM,(25,0) Mode , Below 814MHz

Report No.: B16W00042-FCC-RF

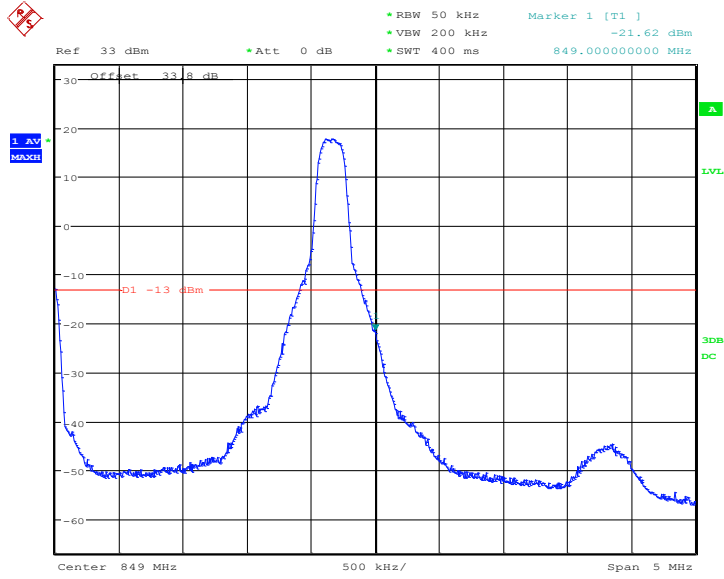

Date: 23.MAR.2016 22:01:26

LTE Band26, 5MHz bandwidth, 16QAM,(1,25) Mode, Above 849MHz

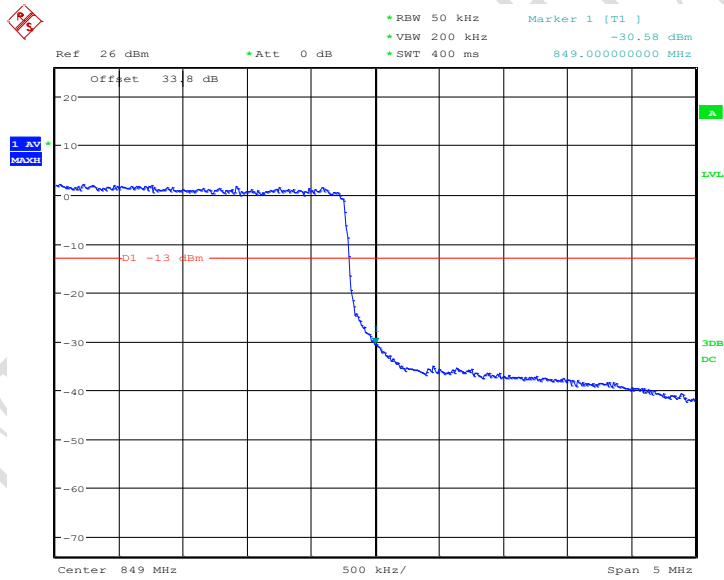

Date: 23.MAR.2016 21:26:21

LTE Band26, 5MHz bandwidth, 16QAM,(25,0) Mode, Above 849MHz

Report No.: B16W00042-FCC-RF

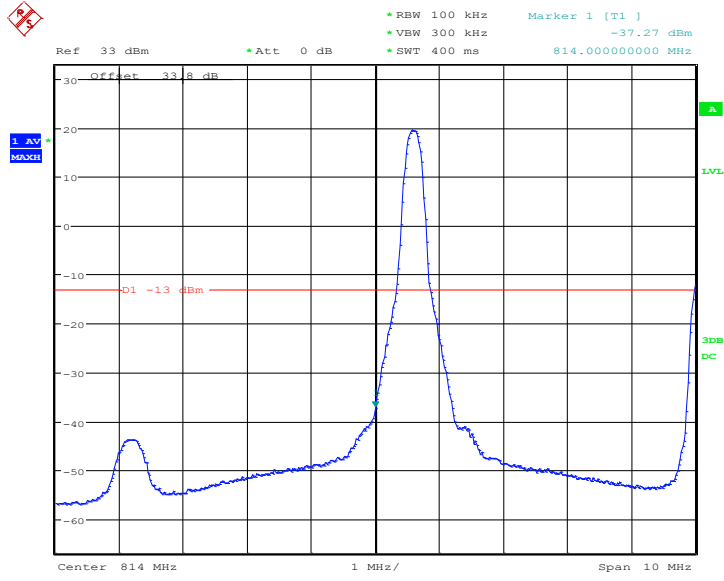

Date: 23.MAR.2016 21:30:01

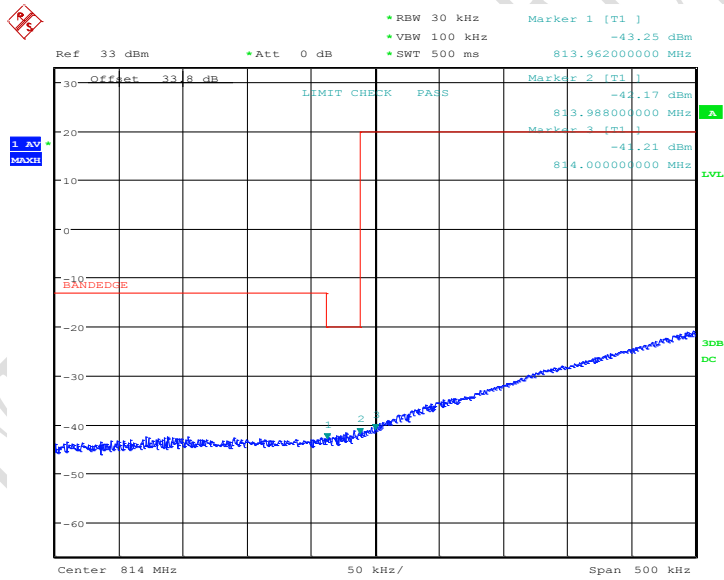

Date: 23.MAR.2016 21:48:28

LTE Band26, 10MHz bandwidth, QPSK,(1,0) Mode , Below 814MHz

Report No.: B16W00042-FCC-RF

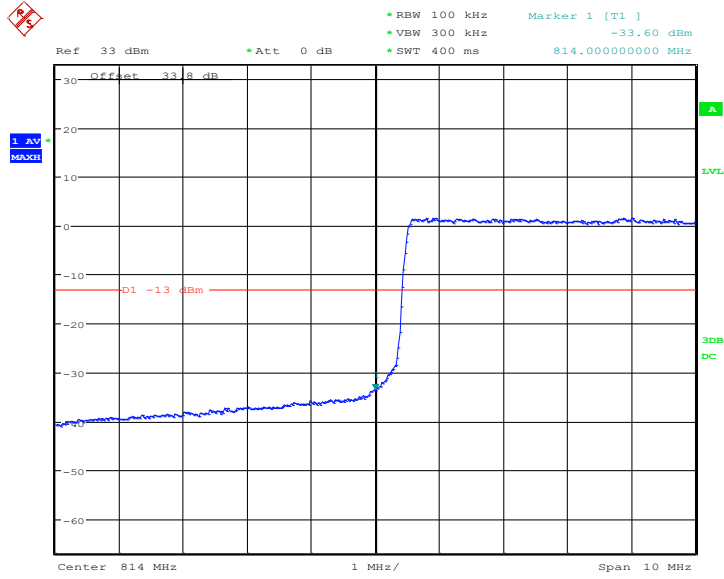

Date: 23.MAR.2016 21:30:12

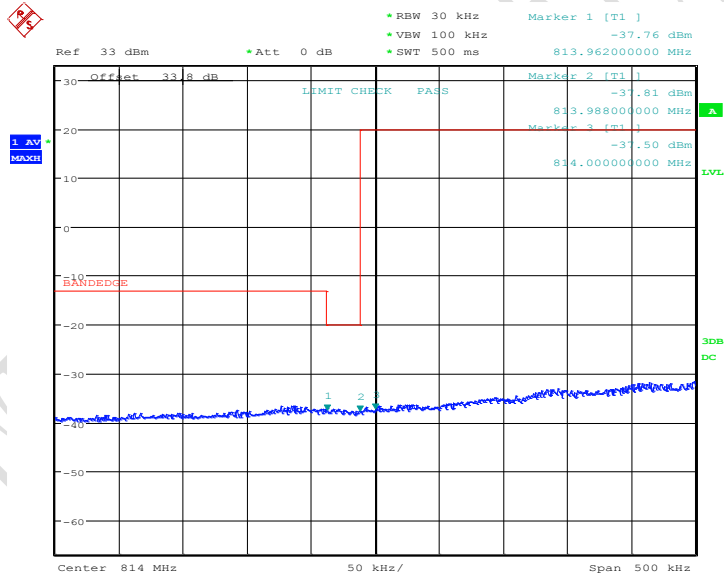

Date: 23.MAR.2016 21:49:02

LTE Band26, 10MHz bandwidth, QPSK,(50,0) Mode , Below 814MHz

Report No.: B16W00042-FCC-RF

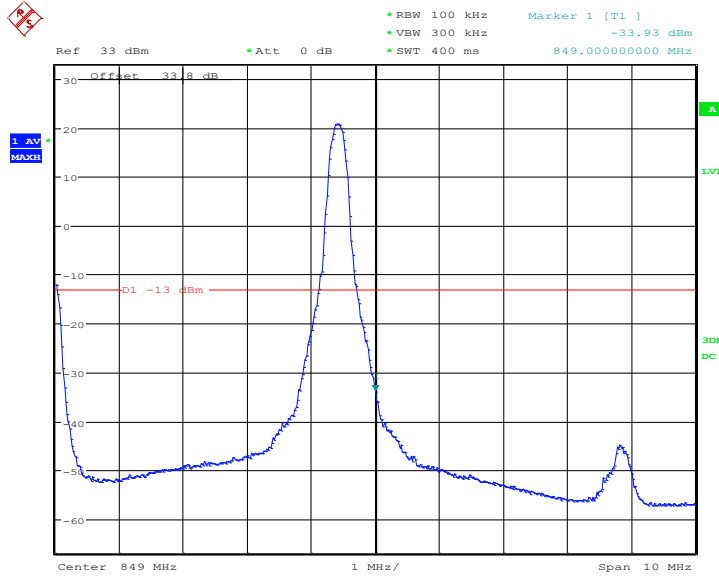

Date: 23.MAR.2016 21:28:36

LTE Band26, 10MHz bandwidth, QPSK,(1,50) Mode, Above 849MHz

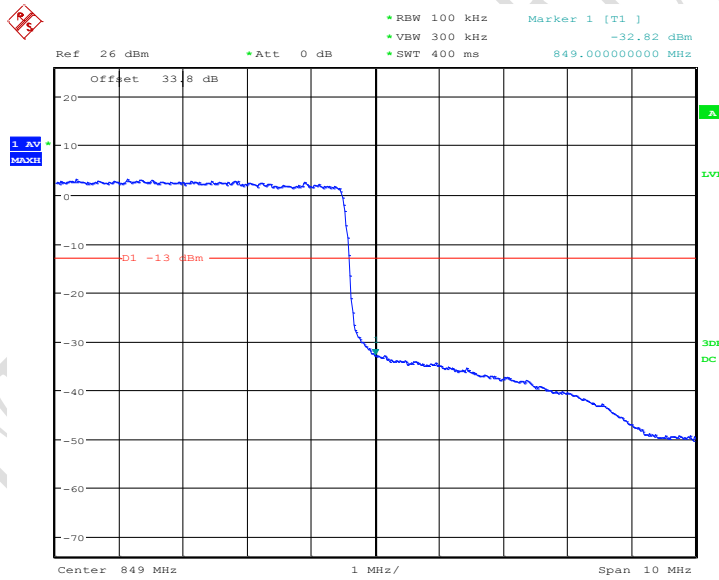

Date: 23.MAR.2016 21:28:13

LTE Band26, 10MHz bandwidth, QPSK,(50,0) Mode, Above 849MHz

Report No.: B16W00042-FCC-RF

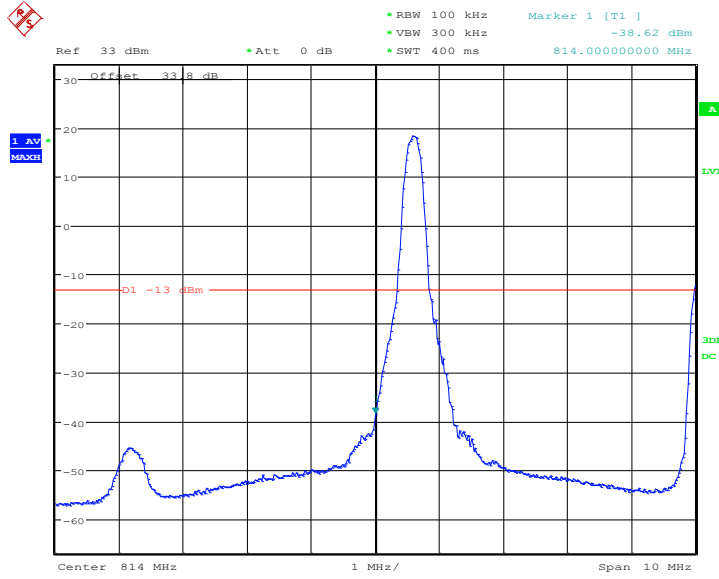

Date: 23.MAR.2016 21:29:46

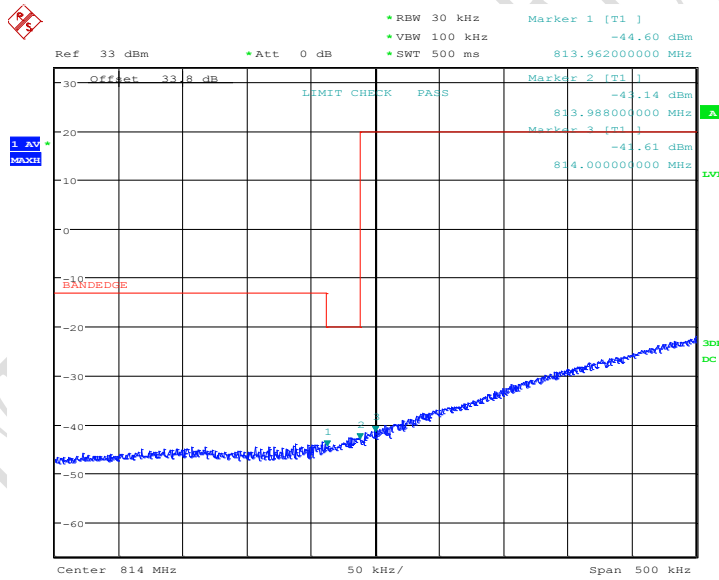

Date: 23.MAR.2016 21:52:05

LTE Band26, 10MHz bandwidth, 16QAM,(1,0) Mode , Below 814MHz

Report No.: B16W00042-FCC-RF

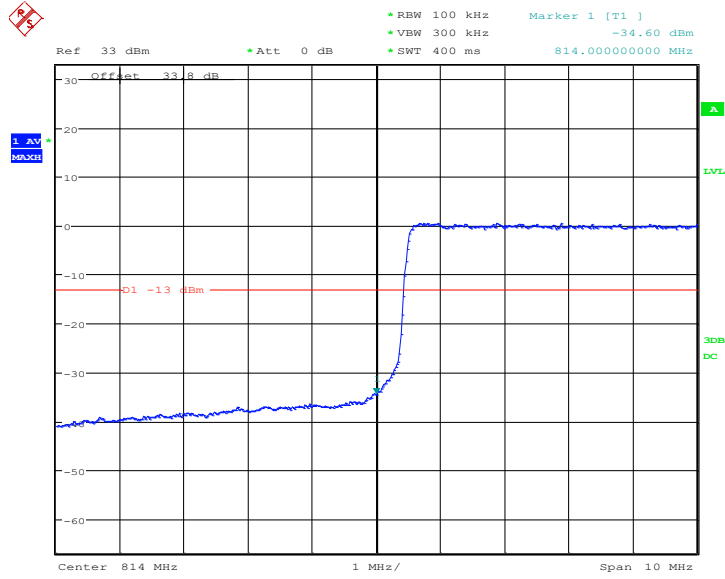

Date: 23.MAR.2016 21:29:35

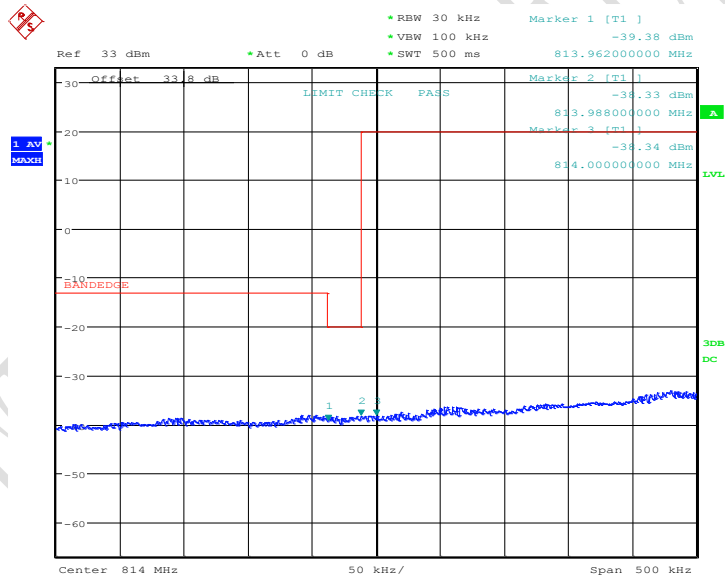

Date: 23.MAR.2016 21:49:27

LTE Band26, 10MHz bandwidth, 16QAM,(50,0) Mode , Below 814MHz

Report No.: B16W00042-FCC-RF

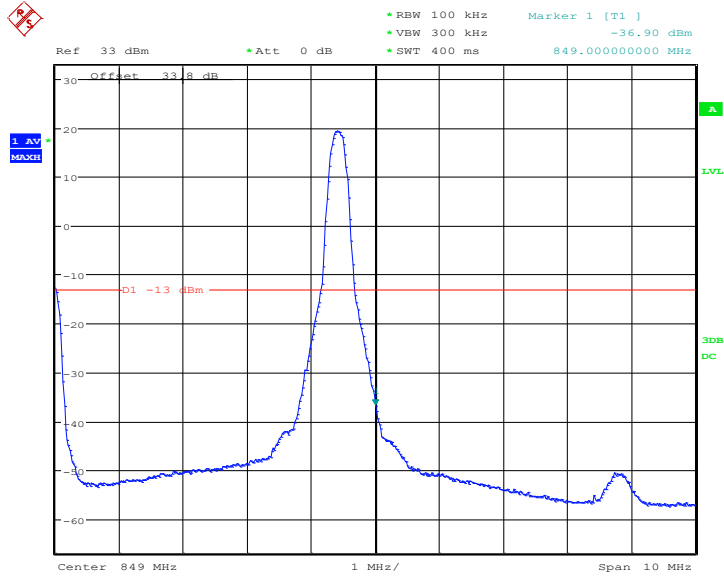

Date: 23.MAR.2016 21:28:50

LTE Band26, 10MHz bandwidth, 16QAM,(1,50) Mode, Above 849MHz

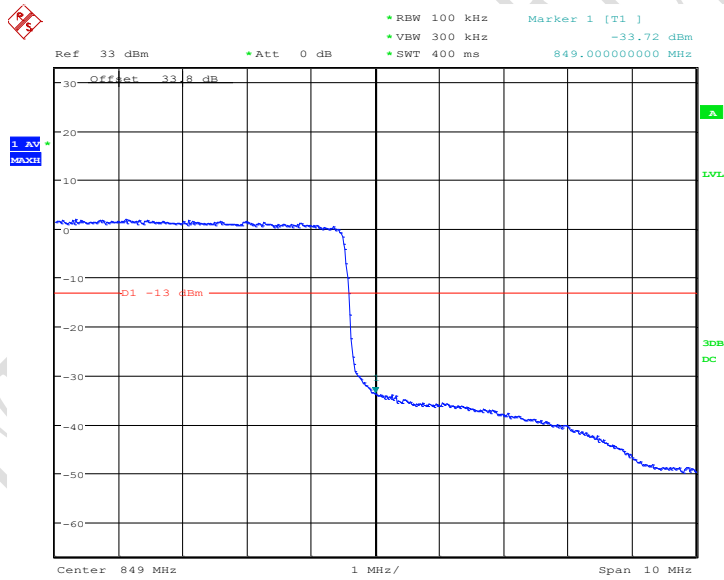

Date: 23.MAR.2016 21:29:02

LTE Band26, 10MHz bandwidth, 16QAM,(50,0) Mode, Above 849MHz

Report No.: B16W00042-FCC-RF

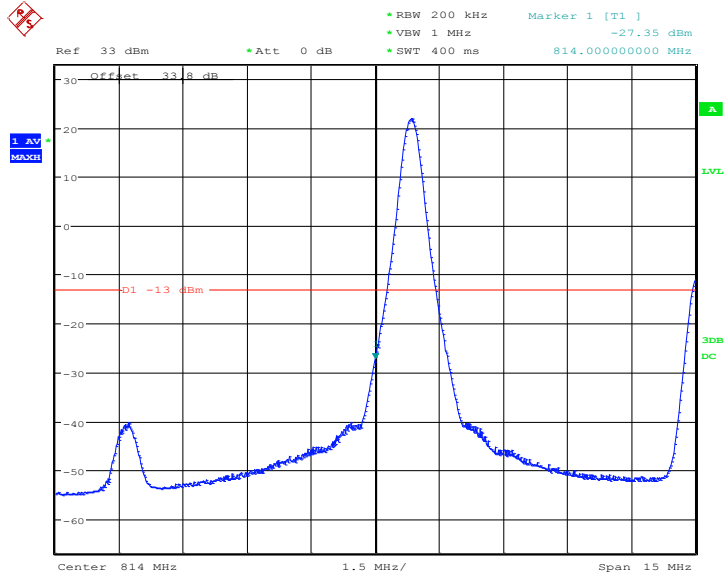

Date: 23.MAR.2016 21:32:11

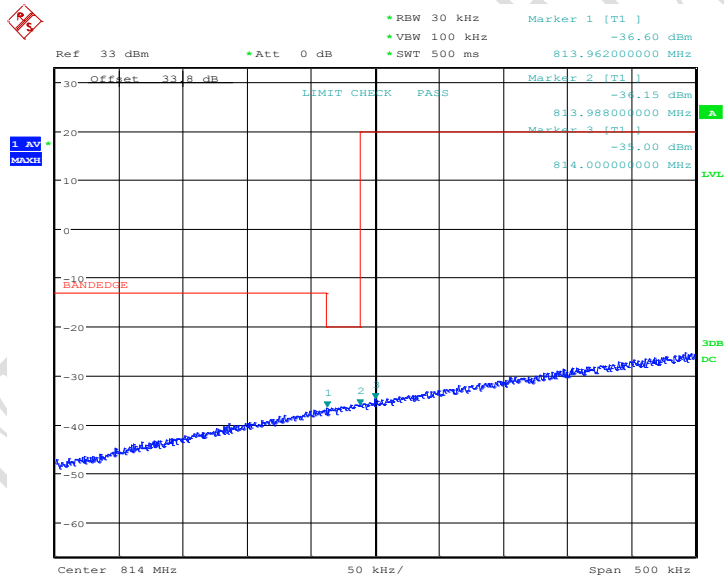

Date: 23.MAR.2016 21:54:37

LTE Band26, 15MHz bandwidth, QPSK,(1,0) Mode , Below 814MHz

Report No.: B16W00042-FCC-RF

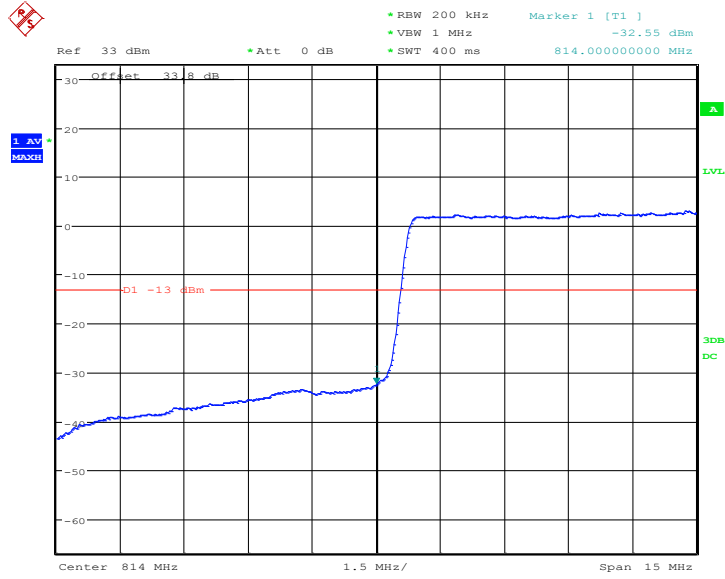

Date: 23.MAR.2016 21:31:24

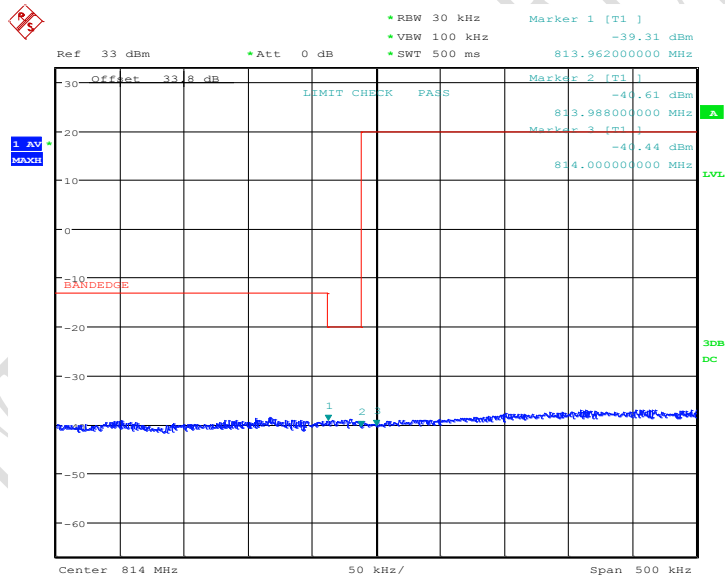

Date: 23.MAR.2016 21:54:18

LTE Band26, 15MHz bandwidth, QPSK,(75,0) Mode , Below 814MHz

Report No.: B16W00042-FCC-RF

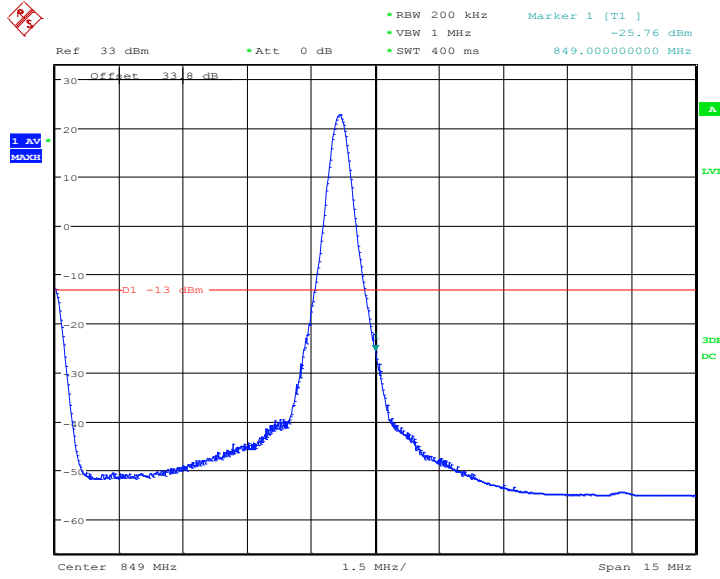

Date: 23.MAR.2016 21:33:43

LTE Band26, 15MHz bandwidth, QPSK,(1,75) Mode, Above 849MHz

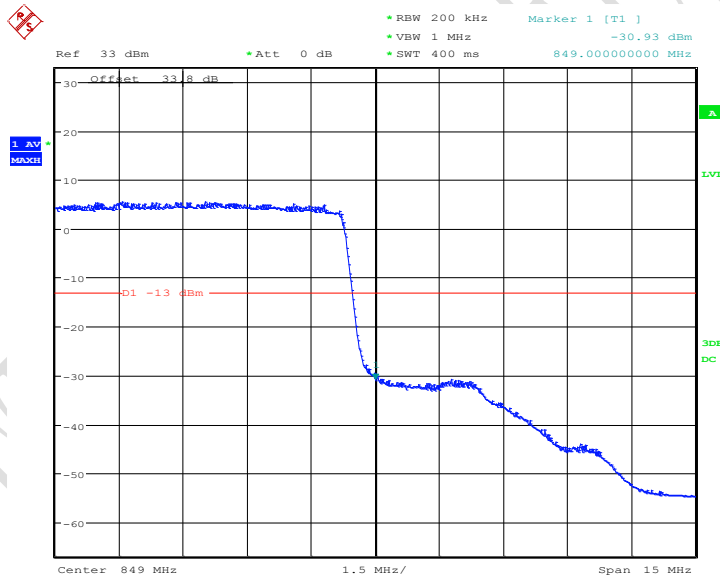

Date: 23.MAR.2016 21:33:33

LTE Band26, 15MHz bandwidth, QPSK,(75,0) Mode, Above 849MHz

Report No.: B16W00042-FCC-RF

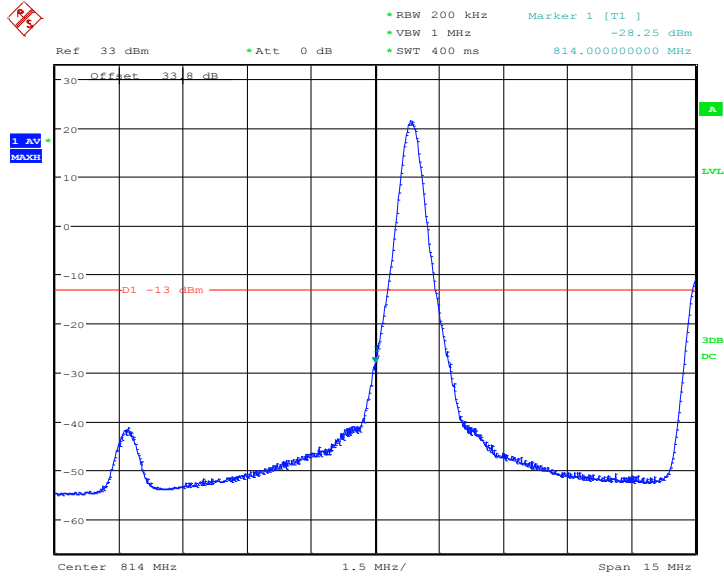

Date: 23.MAR.2016 21:32:28

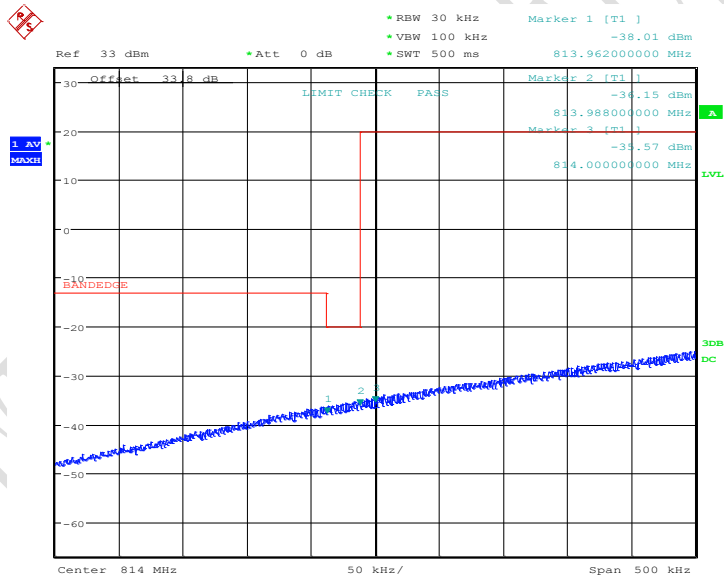

Date: 23.MAR.2016 21:53:43

LTE Band26, 15MHz bandwidth, 16QAM,(1,0) Mode , Below 814MHz

Report No.: B16W00042-FCC-RF

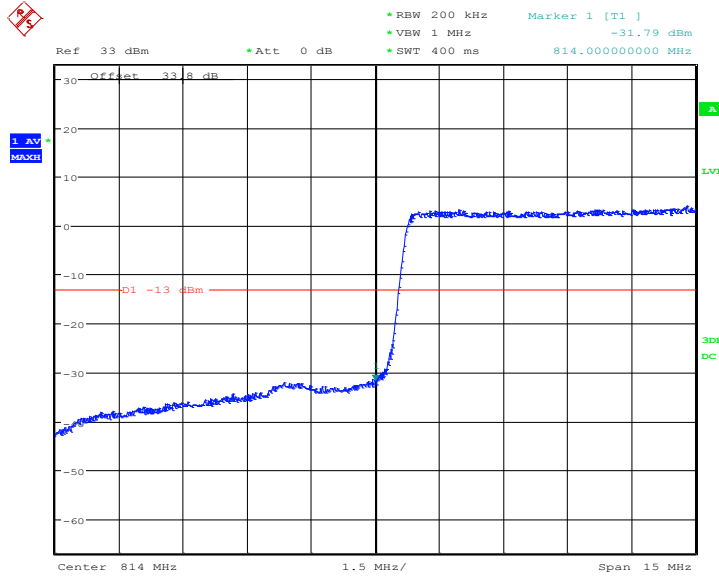

Date: 23.MAR.2016 21:32:43

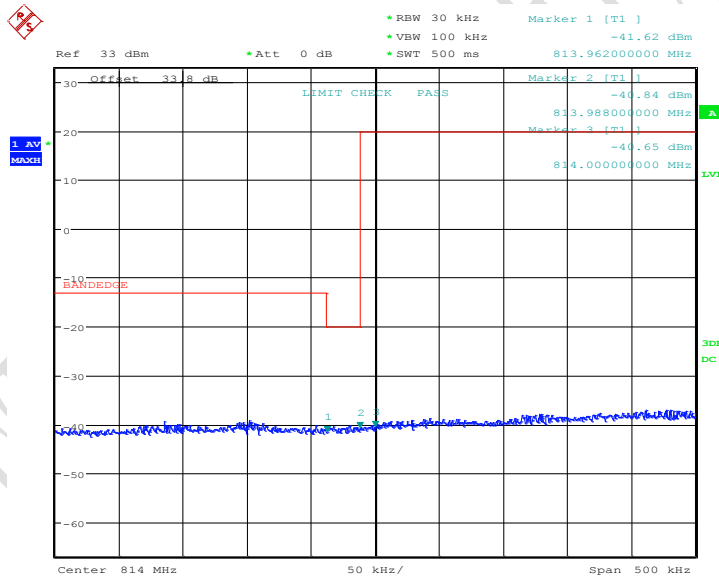

Date: 23.MAR.2016 21:54:01

LTE Band26, 15MHz bandwidth, 16QAM,(75,0) Mode , Below 814MHz

Report No.: B16W00042-FCC-RF

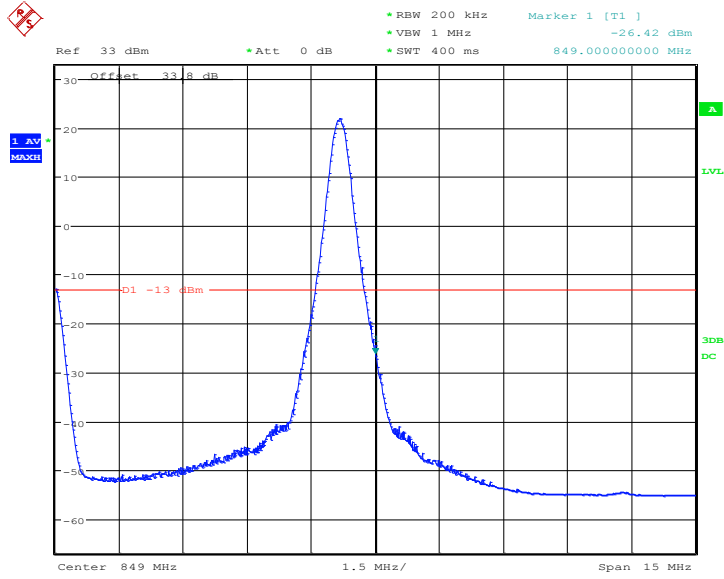

Date: 23.MAR.2016 21:33:58

LTE Band26, 15MHz bandwidth, 16QAM,(1,75) Mode, Above 849MHz

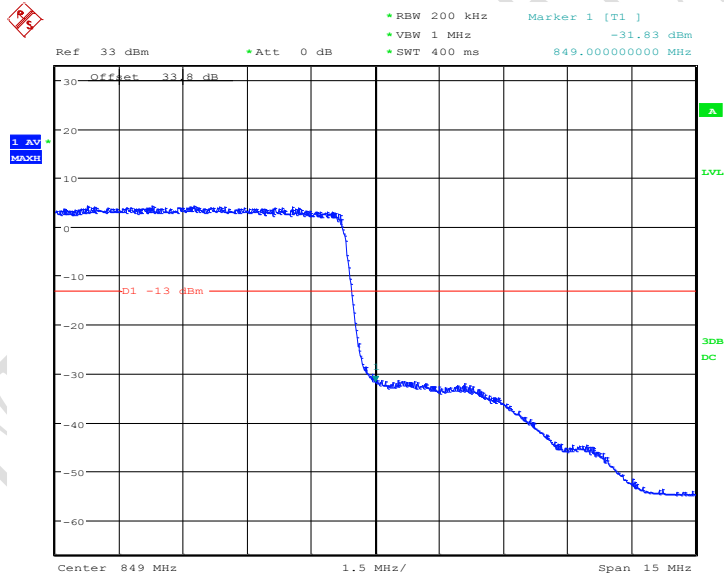

Date: 23.MAR.2016 21:34:08

LTE Band26, 15MHz bandwidth, 16QAM,(75,0) Mode, Above 849MH

5.6 Frequency Stability over Temperature Variation

Specifications:	FCC Part 2.1055, 22.355, 24.235, 27.54, 90.213 RSS-130 4.3, RSS-132 4.3, RSS-133 6.3, RSS-199 4.3
DUT Serial Number:	S1/2: 356207070002119 S3/3: 356207071234562
Test conditions:	Ambient Temperature:15°C-35°C Relative Humidity:30%-60% Air pressure: 86-106kPa
Test Results:	--

Limit	
Frequency deviation [ppm]	±2.5

Test Setup

The EUT was placed in a temperature chamber, demonstrated as figure T. The Wireless Telecommunications Test Set was used to set the Tx channel and power level, modulate the TX signal with different bit patterns and measure the frequency of Tx.

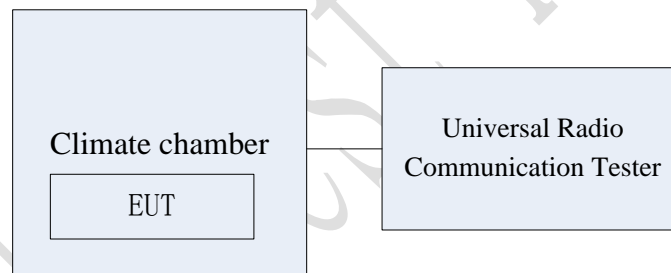

Test Method

- 1、 The EUT was turned off and placed in the temperature chamber.
- 2、 The temperature of the chamber was set to -30°C and allowed to stabilize.
- 3、 The EUT temperature was allowed to stabilize for 45 minutes.
- 4、 The EUT was turned on and set to transmit with Wireless Telecommunications Test Set.
- 5、 The maximum transmit frequency deviation during one minute period was measured by Wireless Communications Test Set.
- 6、 The steps 3-5 were repeated for -30°C,-20°C, -10°C, 0°C, 10°C, 20°C, 30°C, 40°C and 50°C.

5.6.1 WCDMA Band Frequency Stability over Temperature Variation Results

Band	Offset	Temperature[°C]								
		-30	-20	-10	0	10	20	30	40	50
2	Hz	-12.06	-10.02	-3.12	-3.60	-4.58	-4.06	-4.42	-3.83	-4.41
	ppm	-0.0064	-0.0053	-0.0016	-0.0019	-0.0024	-0.0021	-0.0023	-0.0020	-0.0023
4	Hz	15.21	-12.04	9.59	13.48	14.70	14.42	15.51	15.38	14.61
	ppm	0.0087	-0.0069	0.0055	0.0077	0.0084	0.0083	0.0089	0.0088	0.0084
5	Hz	-2.48	1.97	3.12	3.45	7.81	7.00	3.73	5.76	3.80
	ppm	-0.0029	0.0023	0.0037	0.0041	0.0093	0.0083	0.0044	0.0068	0.0045

5.6.2 CDMA Band Frequency Stability over Temperature Variation Results

Band	Offset	Temperature[°C]								
		-30	-20	-10	0	10	20	30	40	50
BC0	Hz	-14.28	-16.26	-12.08	-10.91	-14.79	-10.40	-12.96	-12.01	0.39
	ppm	-0.0170	-0.0194	-0.0144	-0.0130	-0.0176	-0.0124	-0.0154	-0.0143	0.0004
BC1	Hz	12.52	11.57	13.84	8.42	10.18	9.38	18.75	8.94	13.18
	ppm	0.0066	0.0061	0.0073	0.0044	0.0054	0.0049	0.0099	0.0047	0.0070
BC10	Hz	-14.87	-25.42	-12.23	-8.57	-10.62	-6.88	-7.03	-7.76	-8.28
	ppm	-0.0181	-0.0310	-0.0149	-0.0104	-0.0129	-0.0083	-0.0085	-0.0094	-0.0100

5.6.3 LTE Band Frequency Stability over Temperature Variation Results

Band	Offset	Temperature[°C]								
		-30	-20	-10	0	10	20	30	40	50
4	Hz	9.74	9.47	11.36	7.47	8.10	8.71	9.84	8.84	7.60
	ppm	0.0056	0.0050	0.0060	0.0039	0.0043	0.0046	0.0052	0.0046	0.0040
12	Hz	-8.61	13.17	15.42	9.56	-14.20	10.23	-11.39	9.31	-6.31
	ppm	-0.0121	0.0186	0.0217	0.0135	-0.0200	0.0144	-0.0160	0.0131	-0.0089
25	Hz	8.97	14.95	-16.94	-17.27	-17.32	-16.75	-17.97	-16.06	-15.11
	ppm	0.0047	0.0079	-0.0089	-0.0091	-0.0092	-0.0088	-0.0095	-0.0085	-0.0080
26	Hz	-5.38	-5.02	-6.38	-4.49	-5.39	-5.89	-3.39	-6.09	-6.24
	ppm	-0.0064	-0.0060	-0.0076	-0.0053	-0.0064	-0.0070	-0.0040	-0.0073	-0.0075

5.7 Frequency Stability over Voltage Variation

Specifications:	FCC Part 2.1055, 22.355, 24.235, 27.54, 90.213 RSS-130 4.3, RSS-132 4.3, RSS-133 6.3, RSS-199 4.3
DUT Serial Number:	S3/3: 356207071234562
Test conditions:	Ambient Temperature:15°C-35°C Relative Humidity:30%-60% Air pressure: 86-106kPa
Test Results:	--

Limit	
Frequency deviation [ppm]	±2.5

Test Setup

The EUT was placed in a shielding chamber and powered by an adjustable power supply, demonstrated as figure V. A Wireless Telecommunications Test Set was used to set the TX channel and power level, modulate the TX signal with different bit patterns and measure the frequency of TX.

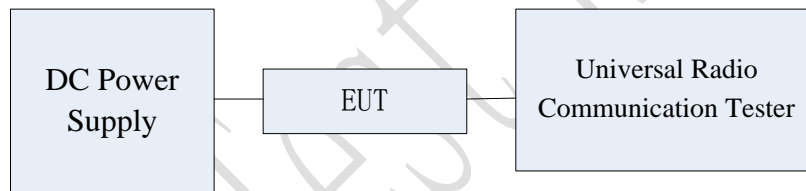

Test Method

The EUT was powered by the adjustable power supply. The frequency stability is measured by the Wireless Telecommunications Test Set.

5.7.1 WCDMA Band Frequency Stability over Voltage Variation Results

Test data:

Band	Offset	Voltage (V)		
		3.4	3.7	4.3
2	Hz	-12.13	-10.04	-9.96
	ppm	-0.0064	-0.0053	-0.0052
4	Hz	-6.69	-6.97	-6.84
	ppm	-0.0038	-0.0040	-0.0039
5	Hz	1.99	-2.55	1.95
	ppm	0.0023	-0.0030	0.0023

5.7.2 CDMA Band Frequency Stability over Voltage Variation Results

Test data:

Band	Offset	Voltage (V)		
		3.4	3.7	4.3
BC0	Hz	-13.48	-11.65	-18.75
	ppm	-0.0161	-0.0139	-0.0224
BC1	Hz	12.52	13.77	13.26
	ppm	0.0066	0.0073	0.0070
BC10	Hz	-9.96	-10.69	-12.01
	ppm	-0.0121	-0.0130	-0.0146

5.7.3 LTE Band Frequency Stability over Voltage Variation Results

Test data:

Band	Offset	Voltage (V)		
		3.4	3.7	4.3
4	Hz	6.87	5.92	6.38
	ppm	0.0039	0.0034	0.0036
12	Hz	-2.68	2.50	-4.19
	ppm	-0.0037	0.0035	-0.0059
25	Hz	-12.75	-16.77	-19.00
	ppm	-0.0067	-0.0089	-0.0100
26	Hz	-2.62	-4.18	-6.77
	ppm	-0.0031	-0.0050	-0.0081

5.8 Peak to Average Ratio

Specifications:	FCC Part 24.232, 27.50, RSS-130 4.4
DUT Serial Number:	S1/2: 356207070002119 S3/3: 356207071234562
Test conditions:	Ambient Temperature:15°C-35°C Relative Humidity:30%-60% Air pressure: 86-106kPa
Test Results:	--

Limit

The EUT meets the requirement of having a peak to average ratio of less than 13dB.

Test Setup

During the test, the EUT was controlled via the Wireless Communications Test Set to ensure max power transmission and proper modulation and measured by spectrum analyzer.

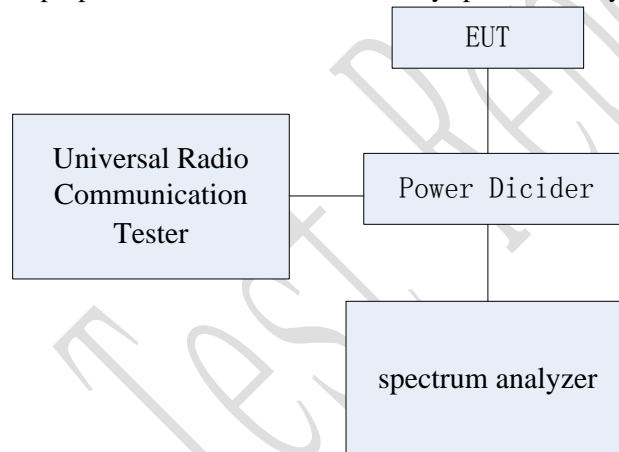

Test Method

The transmitter output was connected to a CMW500 through a coaxial RF cable and directional coupler, and configured to operate at maximum power. The peak to average ratio was measured at the required operating frequencies in each band on the Spectrum Analyzer.

5.8.1 WCDMA B2 Peak to Average Ratio Results

Frequency (MHz)	EUT channel No.	Modulation	Peak to Average Ratio
1880	9400	QPSK	3.51

5.8.2 WCDMA B4 Peak to Average Ratio Results

Frequency (MHz)	EUT channel No.	Modulation	Peak to Average Ratio
1732.4	1412	QPSK	3.48

5.8.3 WCDMA B5 Peak to Average Ratio Results

Frequency (MHz)	EUT channel No.	Modulation	Peak to Average Ratio
836.4	4182	QPSK	3.88

5.8.4 CDMA BC0 Peak to Average Ratio Results

Frequency (MHz)	EUT channel No.	Modulation	Peak to Average Ratio
836.52	384	RC1(OQPSK)	5.10
		RC3(HPSK)	4.73

5.8.5 CDMA BC1 Peak to Average Ratio Results

Frequency (MHz)	EUT channel No.	Modulation	Peak to Average Ratio
1880.00	600	RC1(OQPSK)	4.06
		RC3(HPSK)	3.76

5.8.6 CDMA BC10 Peak to Average Ratio Results

Frequency (MHz)	EUT channel No.	Modulation	Peak to Average Ratio
820.00	560	RC1(OQPSK)	5.35
		RC3(HPSK)	4.82

5.8.7 LTE B4 Peak to Average Ratio Results

Frequency (MHz)	EUT channel No.	bandwidth	Modulation	Peak to Average Ratio
1732.5MHz	20175	10MHz	QPSK	6.67
			16QAM	7.50

5.8.8 LTE B12 Peak to Average Ratio Results

Frequency (MHz)	EUT channel No.	bandwidth	Modulation	Peak to Average Ratio
707.5MHz	23095	10MHz	QPSK	6.86
			16QAM	7.54

5.8.9 LTE B25 Peak to Average Ratio Results

Frequency (MHz)	EUT channel No.	bandwidth	Modulation	Peak to Average Ratio
1882.5MHz	26365	10MHz	QPSK	6.37
			16QAM	7.34

5.8.10 LTE B26 Peak to Average Ratio Results

Frequency (MHz)	EUT channel No.	bandwidth	Modulation	Peak to Average Ratio
831.5MHz	26865	10MHz	QPSK	7.31
			16QAM	8.02

Graphical for Peak to Average Ratio Results

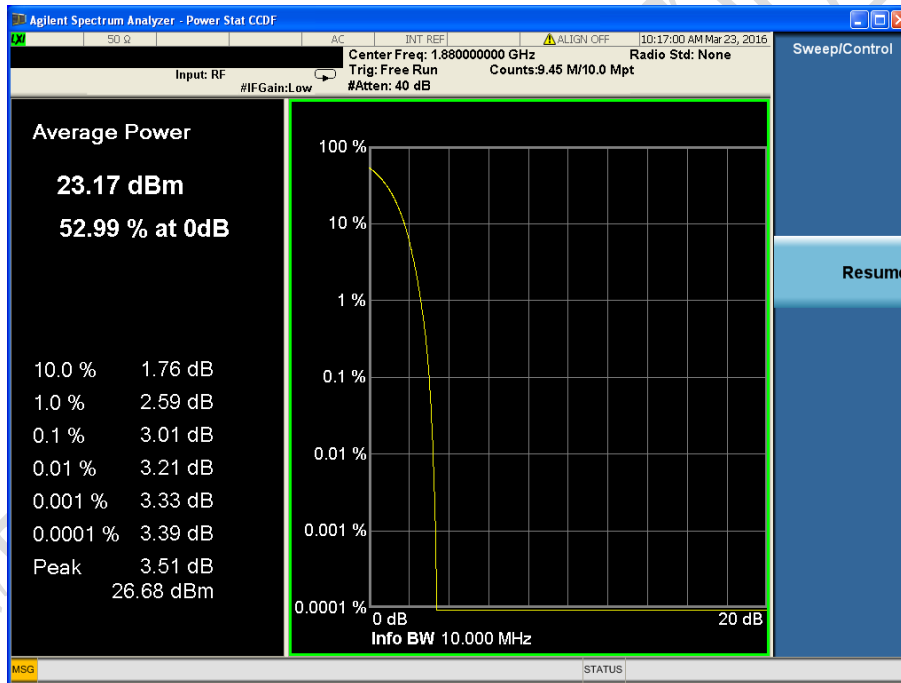

WCDMA Band2, QPSK

Report No.: B16W00042-FCC-RF

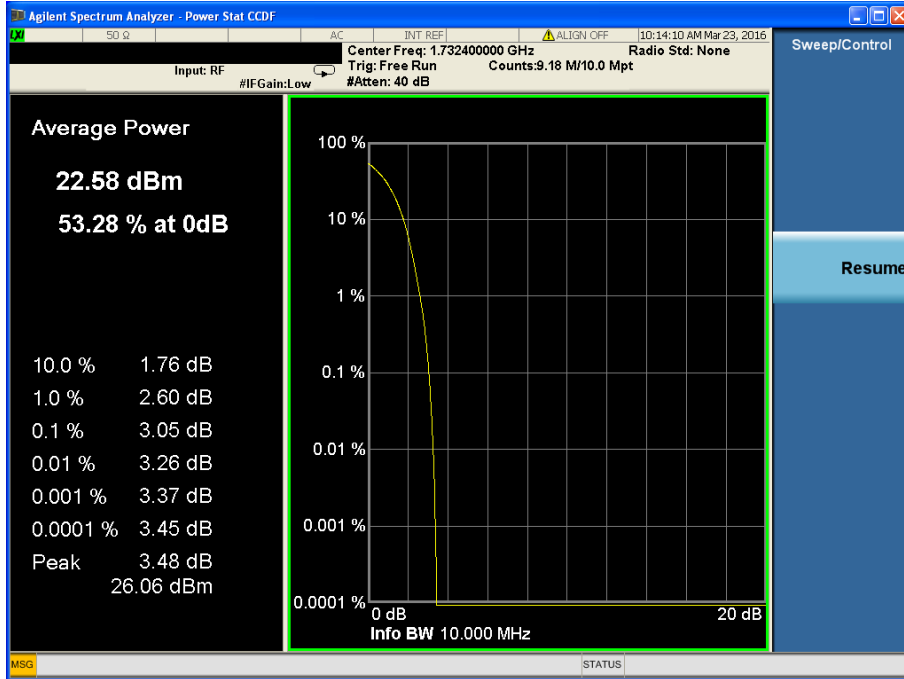

WCDMA Band4, QPSK

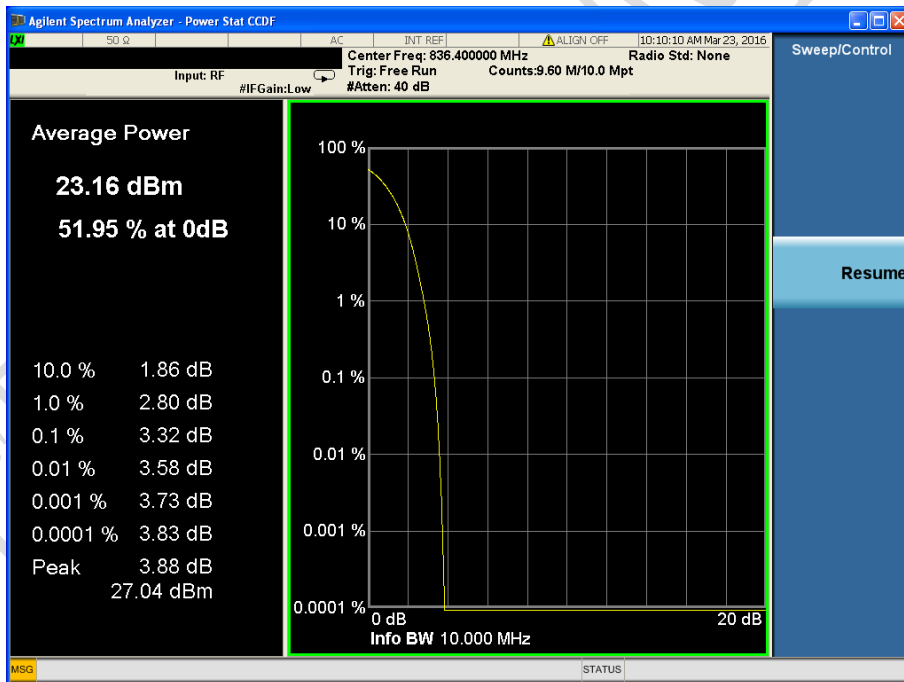

WCDMA Band5, QPSK

Report No.: B16W00042-FCC-RF

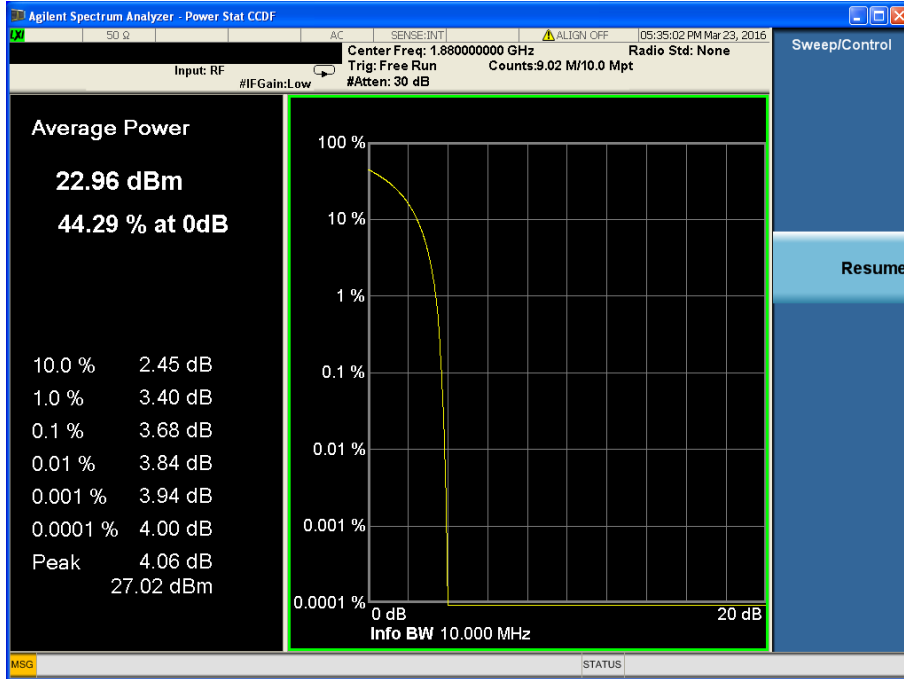

CDMA BC0, RC1(OQPSK)

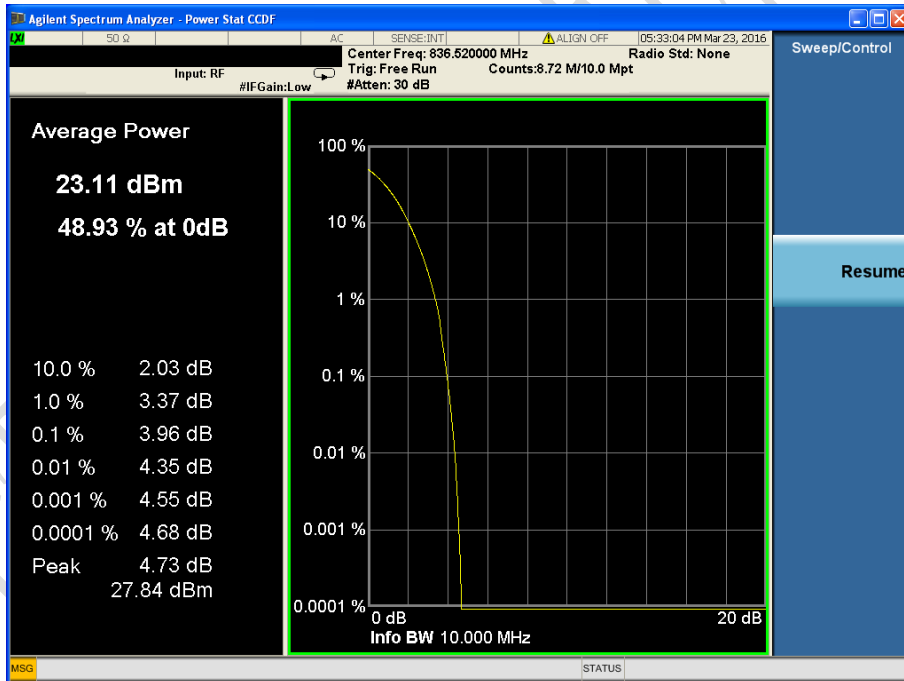

CDMA BC0, RC3(HPSK)

Report No.: B16W00042-FCC-RF

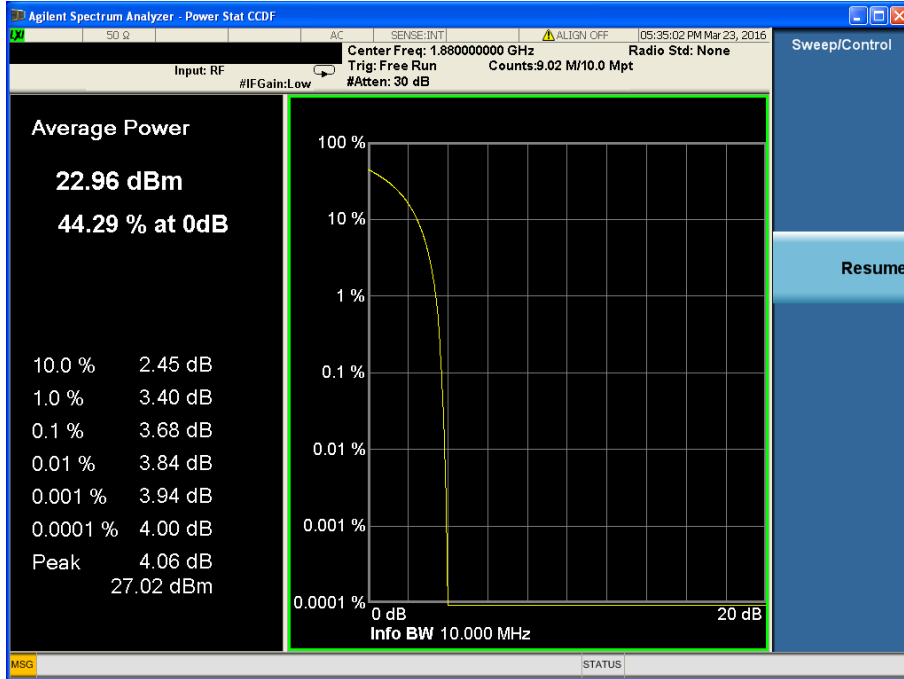

CDMA BC1, RC1(OQPSK)

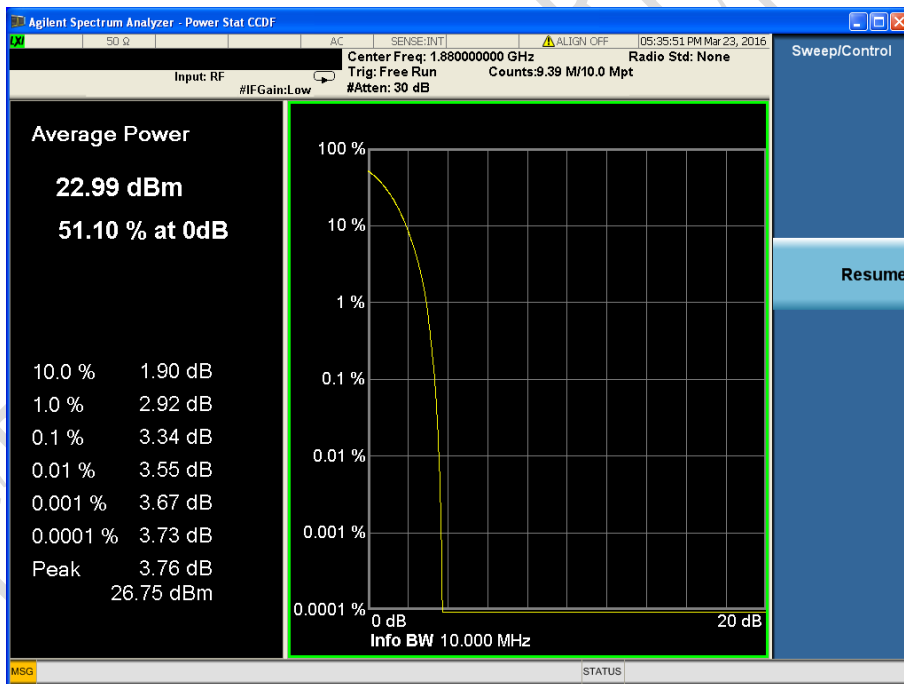

CDMA BC1, RC3(HPSK)

Report No.: B16W00042-FCC-RF

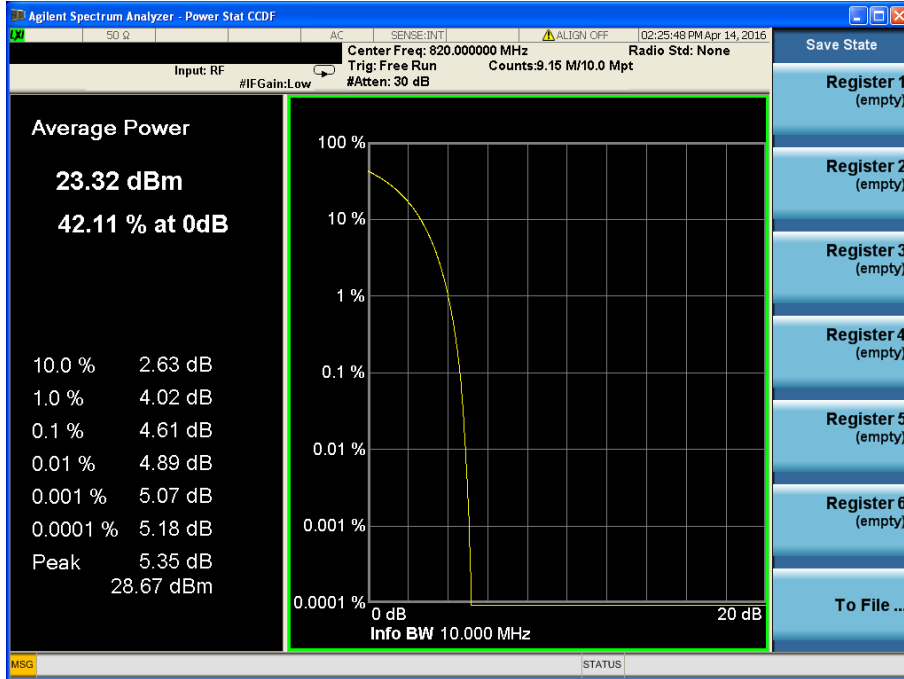

CDMA BC10, RC1(OQPSK)

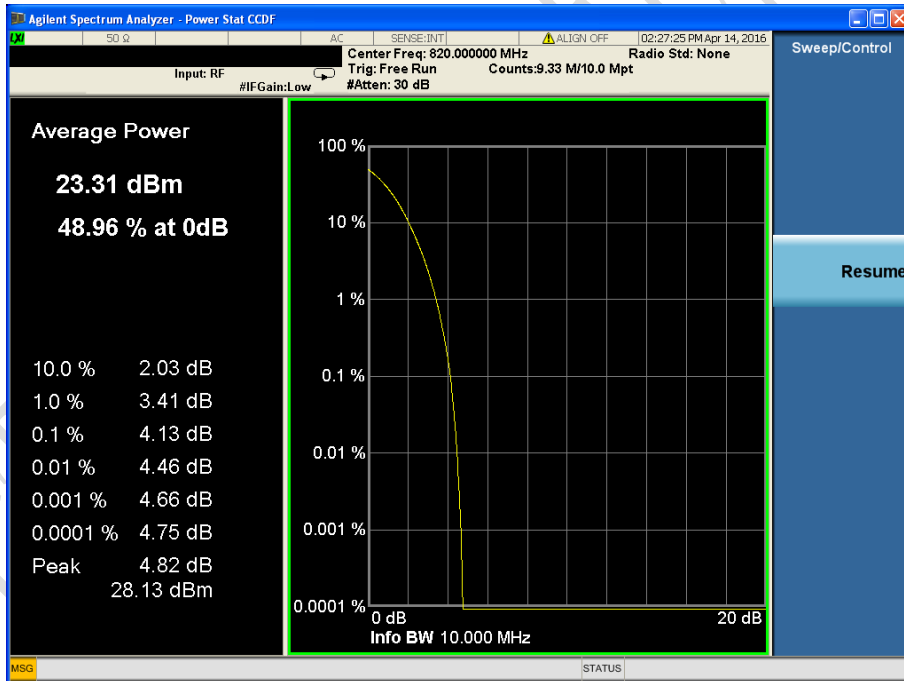

CDMA BC10, RC3(HPSK)

Report No.: B16W00042-FCC-RF

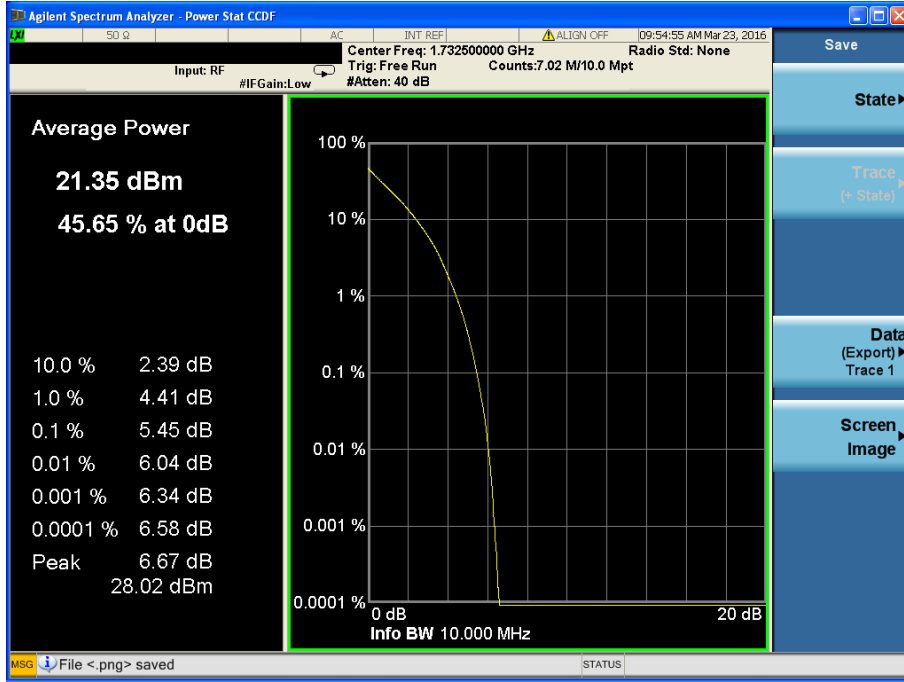

LTE Band4, QPSK

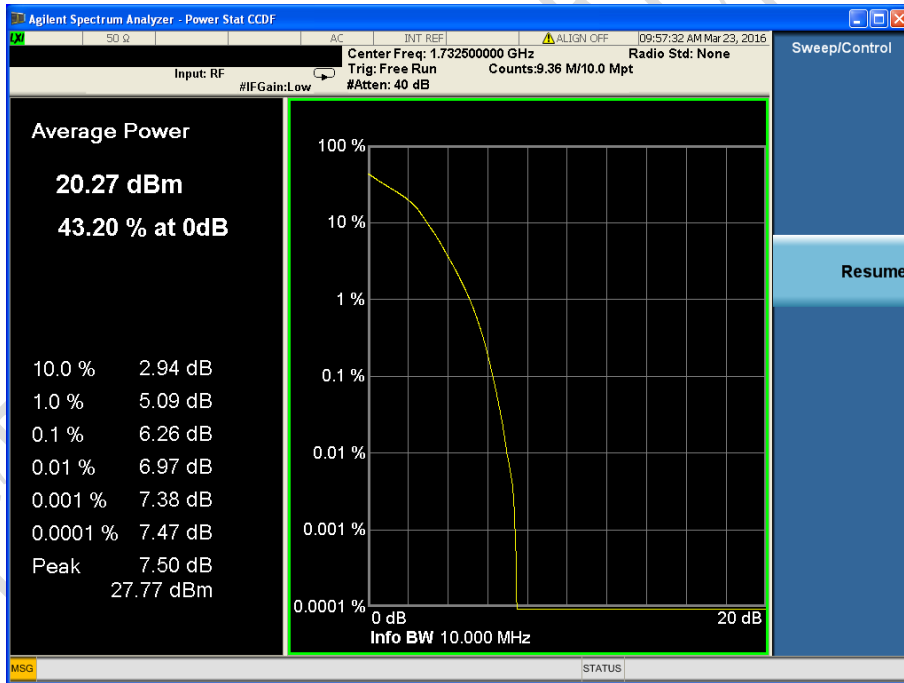

LTE Band4, 16QAM

Report No.: B16W00042-FCC-RF

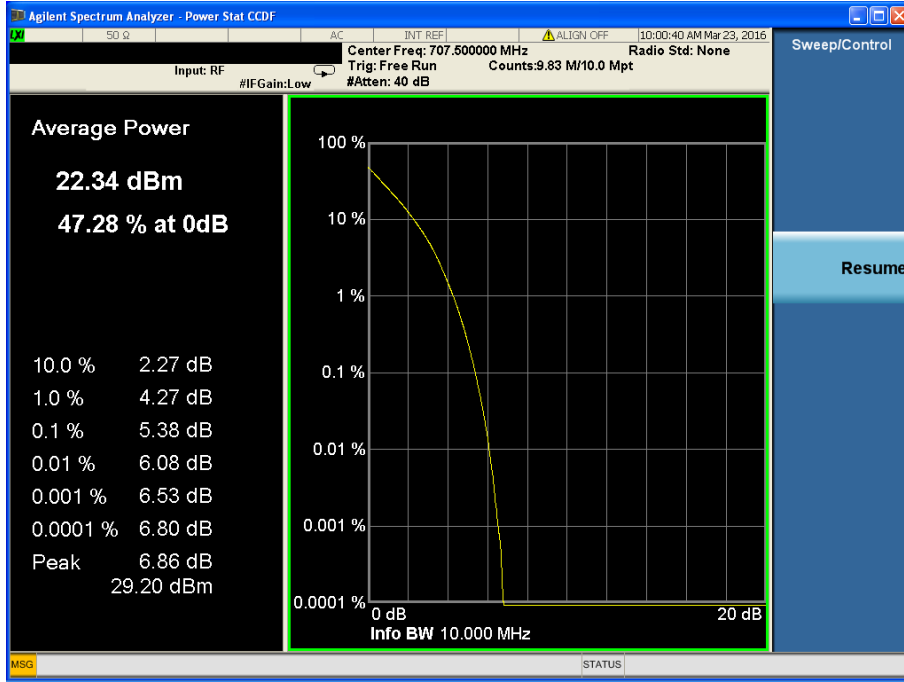

LTE Band12, QPSK

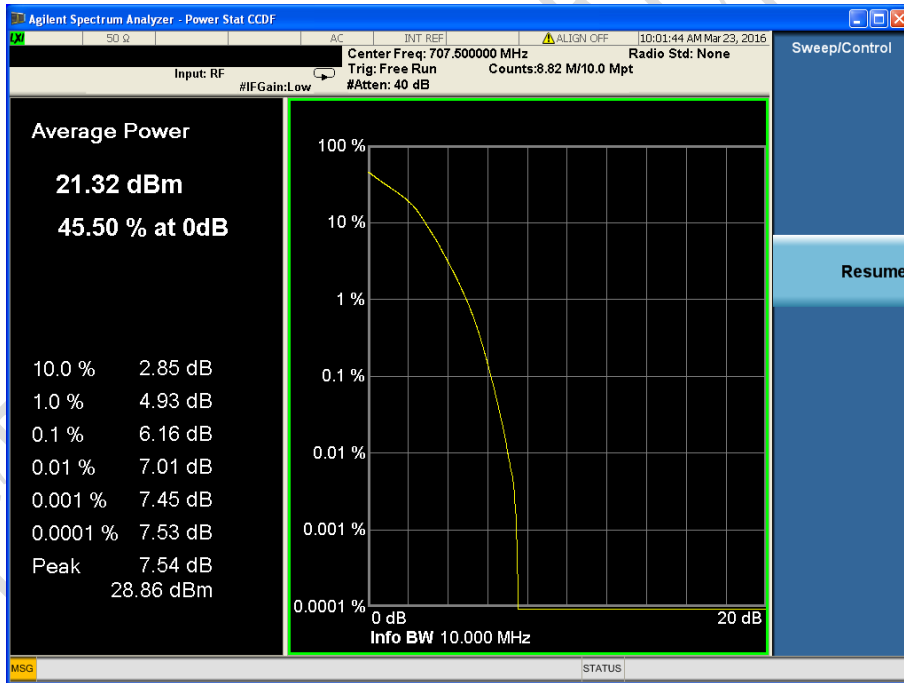

LTE Band12, 16QAM

Report No.: B16W00042-FCC-RF

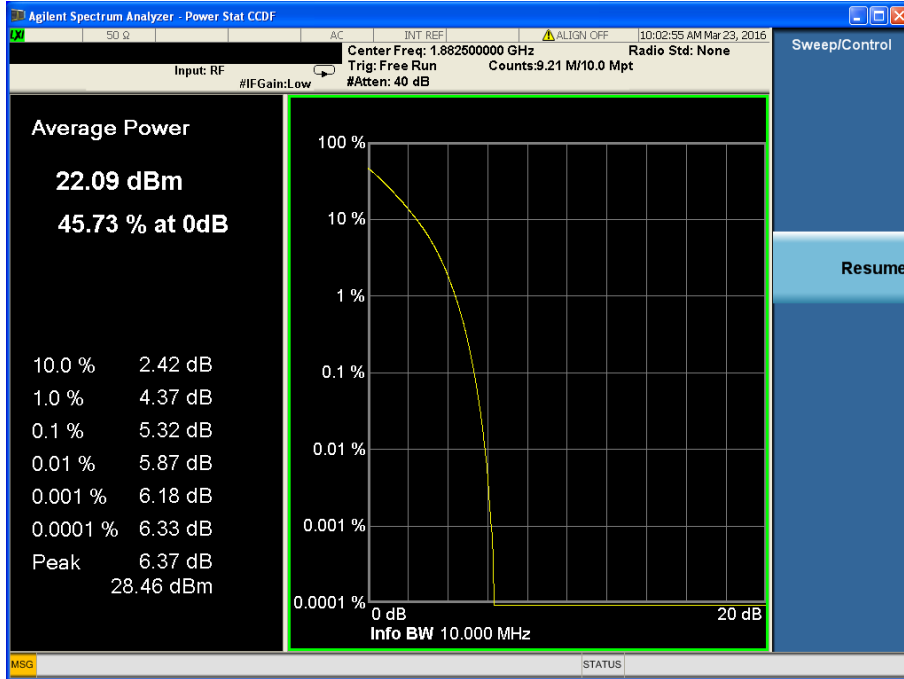

LTE Band25, QPSK

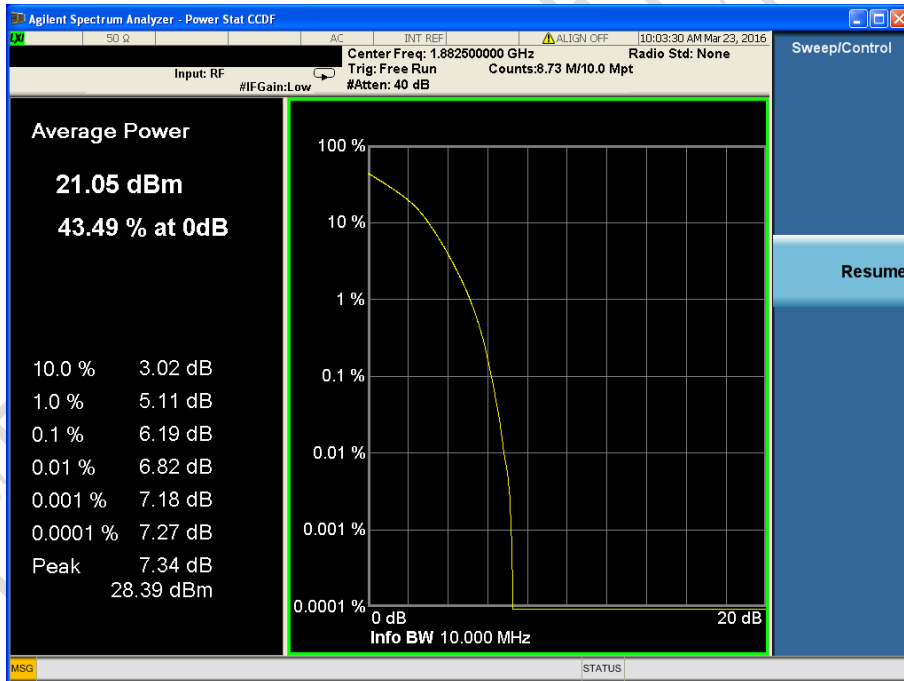

LTE Band25, 16QAM

Report No.: B16W00042-FCC-RF

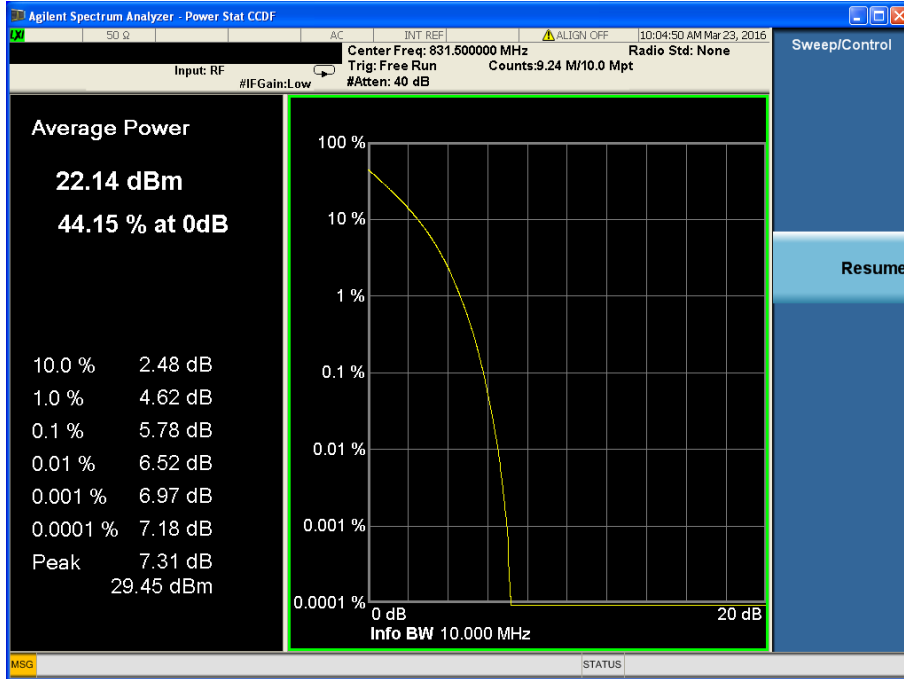

LTE Band26, QPSK

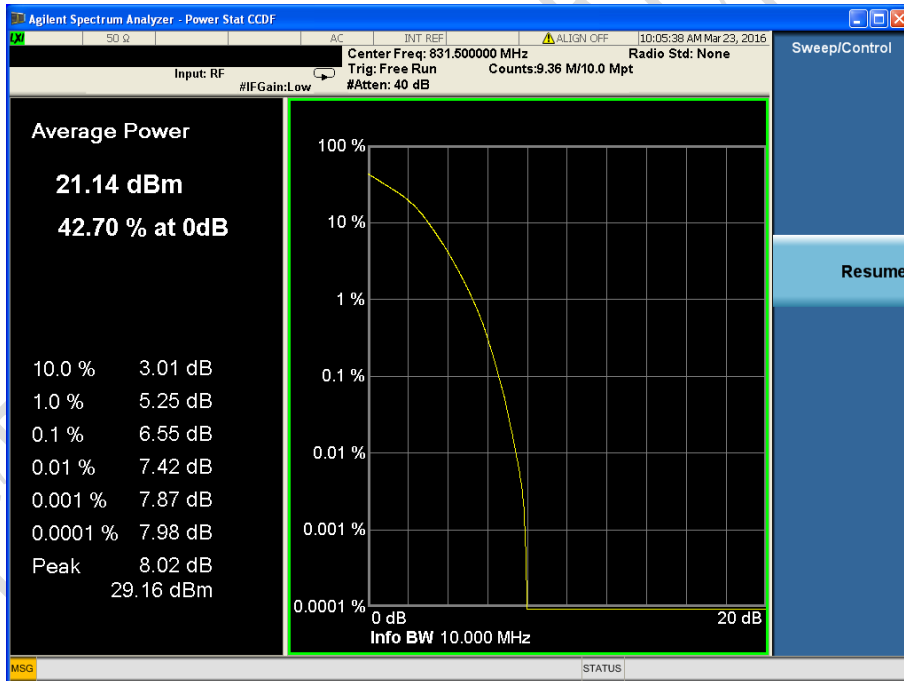

LTE Band26, 16QAM

Annex A EUT Photos

See the document "WP7504-External Photos".

See the document "WP7504-Internal Photos".

CTTL Test Report

Report No.: B16W00042-FCC-RF

ANNEX B Deviations from Prescribed Test Methods

No deviation from Prescribed Test Methods.

End Of Report

CITL Test Report