

DigiCore Technology (Pty) Ltd

P.O. Box 68270
Highveld Park, 0169
South Africa
+27(0)12 450 2222



Ctrack NX35 Technical Manual

DCT-MAN-296

CONFIG CONTROLLED

This document is the confidential proprietary information of DigiCore Technology (Pty) Ltd. Copyright in and ownership of this entire document and its contents rests with DigiCore Technology (Pty) Ltd. No portion of or extract from this document may be reproduced, quoted or utilised for any purpose whatsoever without the prior written consent of DigiCore Technology (Pty) Ltd.

APPROVAL			
Revision	05		
Date	03 October 2017		
Author	Gerhard Botha		
Reviewers	Dirk Meintjies		
Approved by	Jaco le Roux		



	DigiCore Technology (Pty) Ltd P.O. Box 68270, Highveld Park 0169, South Africa	Manual
	Ctrack NX35 Technical Manual	DCT-MAN-296

TABLE OF CONTENTS

1.	INTRODUCTION	7
1.1.	Purpose of Document.....	7
1.2.	Applicable Documents	7
1.3.	NX35 Usage	7
2.	SYSTEM OVERVIEW.....	8
2.1.	Hardware Sub-systems	8
2.2.	High-level System Overview	9
2.3.	Block Diagram	10
2.4.	Identification and Options.....	11
3.	EXTERNAL INTERFACES.....	12
3.1.	Wiring Connections and Connectors.....	12
3.2.	Signal Description – Main/Secondary Connector.....	15
3.3.	Environmental	16
3.4.	Power	16
3.5.	Mechanical.....	17
3.6.	LEDS.....	17
3.7.	GNSS	18
3.8.	Cellular	18
3.8.1.	Option 1 - u-blox SARA-G350 Cellular Module	19
3.8.2.	Option 2 - u-blox LISA-U200 Cellular Module	19
3.8.3.	Option 3 - u-blox TOBY-L200 Cellular Module.....	19
3.8.4.	Option 4 - u-blox LISA-C200 Cellular Module	20
3.9.	Bluetooth®.....	20
4.	INTERNAL COMPONENTS	21
4.1.	Accelerometer	21
4.2.	On-Board Memory.....	21
4.3.	SIM Card Interface.....	21
4.4.	Watchdog.....	21

	DigiCore Technology (Pty) Ltd P.O. Box 68270, Highveld Park 0169, South Africa	Manual
	Ctrack NX35 Technical Manual	DCT-MAN-296

4.5. Internal Battery 21

5. REGULATORY COMPLIANCE STATEMENTS 22

5.1. Federal communications Commission (FCC) Notice 22

5.2. Innovation Science and Economic Development (ISED) Notice 22

5.3. FCC & ISED RF Exposure Guidance Statement..... 22

INDEX OF FIGURES

FIGURE 1 - BLOCK DIAGRAM 10

FIGURE 2 - MAIN HARNESS 12

FIGURE 3 – MAIN CONNECTOR SIGNALS 13

FIGURE 4 - SECONDARY HARNESS 14

FIGURE 5 – SECONDARY CONNECTOR SIGNALS 15

FIGURE 6 - NX35 PICTURE 17

	DigiCore Technology (Pty) Ltd P.O. Box 68270, Highveld Park 0169, South Africa	Manual
	Ctrack NX35 Technical Manual	DCT-MAN-296

DOCUMENT HISTORY

Date	Author	Revision	Description of Change(s)
23 June 2017	G Botha	01	First release
16 March 2017	G Botha	02	Add usage par 1.3 Add labels par 1.4
23 June 2017	G. Botha	03	Remove labels until final labels become available
28 September 2017	G. Botha R. Olmos	04	Add CDMA options Remove "GSM" and replace with "Cellular" Correct u-Blox Radio Module Models Listings Update Power Rating Information Add Regulatory Compliance Statements (Section 5.0) Add Block diagram. Change GPS to GNSS
03 October 2017	G. Botha	05	Change internal battery specification

	<p>DigiCore Technology (Pty) Ltd P.O. Box 68270, Highveld Park 0169, South Africa</p>	<p>Manual</p>
	<p>Ctrack NX35 Technical Manual</p>	<p>DCT-MAN-296</p>

<h2>DISCLAIMER</h2>

Information provided in this manual is intended to be accurate and reliable. However, the DigiCore Group and its employees assume no responsibility for its use, nor for any infringements of rights of third parties which might result from its use.

If this document is marked as **Config Controlled** and distributed via software, the signatures for preparing and release are archived by DigiCore's Configuration Department. The responsibility is on the reader to ensure he has the latest revision of this document.

	DigiCore Technology (Pty) Ltd P.O. Box 68270, Highveld Park 0169, South Africa	Manual
	Ctrack NX35 Technical Manual	DCT-MAN-296

ABBREVIATIONS AND DEFINITIONS

The following words, expressions and abbreviations shall herein before and hereafter have the meanings ascribed to them unless inconsistent with the meaning of the requirement:

DEFINITIONS

	Direct current symbol (IEC 60417-5031 (2002-10))
GNSS	Global Navigation Satellite System – includes GPS, GLONASS, Galileo or BeiDou systems

	DigiCore Technology (Pty) Ltd P.O. Box 68270, Highveld Park 0169, South Africa	Manual
	Ctrack NX35 Technical Manual	DCT-MAN-296

1. INTRODUCTION

1.1. PURPOSE OF DOCUMENT

This document provides technical detail of the Ctrack NX35 product platform.

1.2. APPLICABLE DOCUMENTS

All referenced documents mentioned below can be requested from digicore_config@ctrack.co.za.

Document Number	Document Title
DCT-PDS-023	Ctrack NX35 Product Specification
DCT-MAN-300	Ctrack NX35 Installation Manual

1.3. NX35 USAGE

The NX35 device is designed to accurately track position and other data of vehicles or assets and report this data to a data center. The NX35 is used to gather information relevant to fleet management services, to plot a vehicle position on a map and also follow the route taken by a vehicle during a journey. The position and speed of the vehicle is sampled using GNSS (Global Navigation Satellite System) and reported through a Cellular Modem data link with industry standard communication protocols. There are more device to vehicle interfaces available like digital I/O, analog inputs, pulse input, and other intelligent interfaces like serial and CAN J1939 to increase the data content about the vehicle. There are also interfaces to identify the driver of the vehicle to enable more fleet management functions and an internal accelerometer provides data for detecting how the vehicle is being driven, also known as driver behavior functions, as well as other vehicle movement detection.

There are on-board resources like processor, memory and hardware watchdog. An internal battery provides power to the unit for a few hours when external power is lost. The device is fixed to a vehicle or asset during installation.

	DigiCore Technology (Pty) Ltd P.O. Box 68270, Highveld Park 0169, South Africa	Manual
	Ctrack NX35 Technical Manual	DCT-MAN-296

2. SYSTEM OVERVIEW

2.1. HARDWARE SUB-SYSTEMS

- Load-dump and overvoltage protection
- Power supply and back-up battery charger
- Internal back-up battery
- GSM Cellular Option with SIM card (2nd optional SIM holder).
- CDMA Cellular Option with no SIM holder.
- GPS Module with external antenna and internal antenna fallback
- Interfaces
 - Discrete Inputs/Outputs
 - Analogue Input
 - Dallas One-wire interface
 - Serial (RS232)
 - Pulse input
 - CAN – J1939
 - Bluetooth
- Watchdog
- Real-time clock with battery back-up
- 3-axis Accelerometer
- RAM and Data flash
- Processor

	DigiCore Technology (Pty) Ltd P.O. Box 68270, Highveld Park 0169, South Africa	Manual
	Ctrack NX35 Technical Manual	DCT-MAN-296

2.2. HIGH-LEVEL SYSTEM OVERVIEW

- The NX35 hardware platform can be used for the Ctrack fleet products (Fleet Light, Assist and Solo)
- Uses state of the art 32-bit microprocessor technology and flash device for non-volatile storage.
- Latest Cellular-GPRS/SMS Cellular Modem with internal antenna for communication. Provision is made to populate a 2G, 3G, or 4G Cellular Modem.
- GNSS with external antenna and antenna tamper technology for accurate position and online/offline assisted GPS. Provision is made for fall-back to an internal antenna.
- A 3-axis Accelerometer for movement detection, harsh driving events and severe G-force vehicle manoeuvres for accident detection.
- Daily Health Checks
- Digital inputs and outputs. One input can be used for pulse detection.
- Combination input for panic and business/private trip detection.
- Analogue input
- Buzzer and immobilisation outputs.
- One wire driver identification input.
- Power supply input with internal back-up battery.
- Power down modes to save battery power
- External interfaces for installation, maintenance and other peripherals (e.g. driver behaviour indicator).
- Internal Bluetooth interface.
- Extra slot for future product expansion.

2.3. BLOCK DIAGRAM

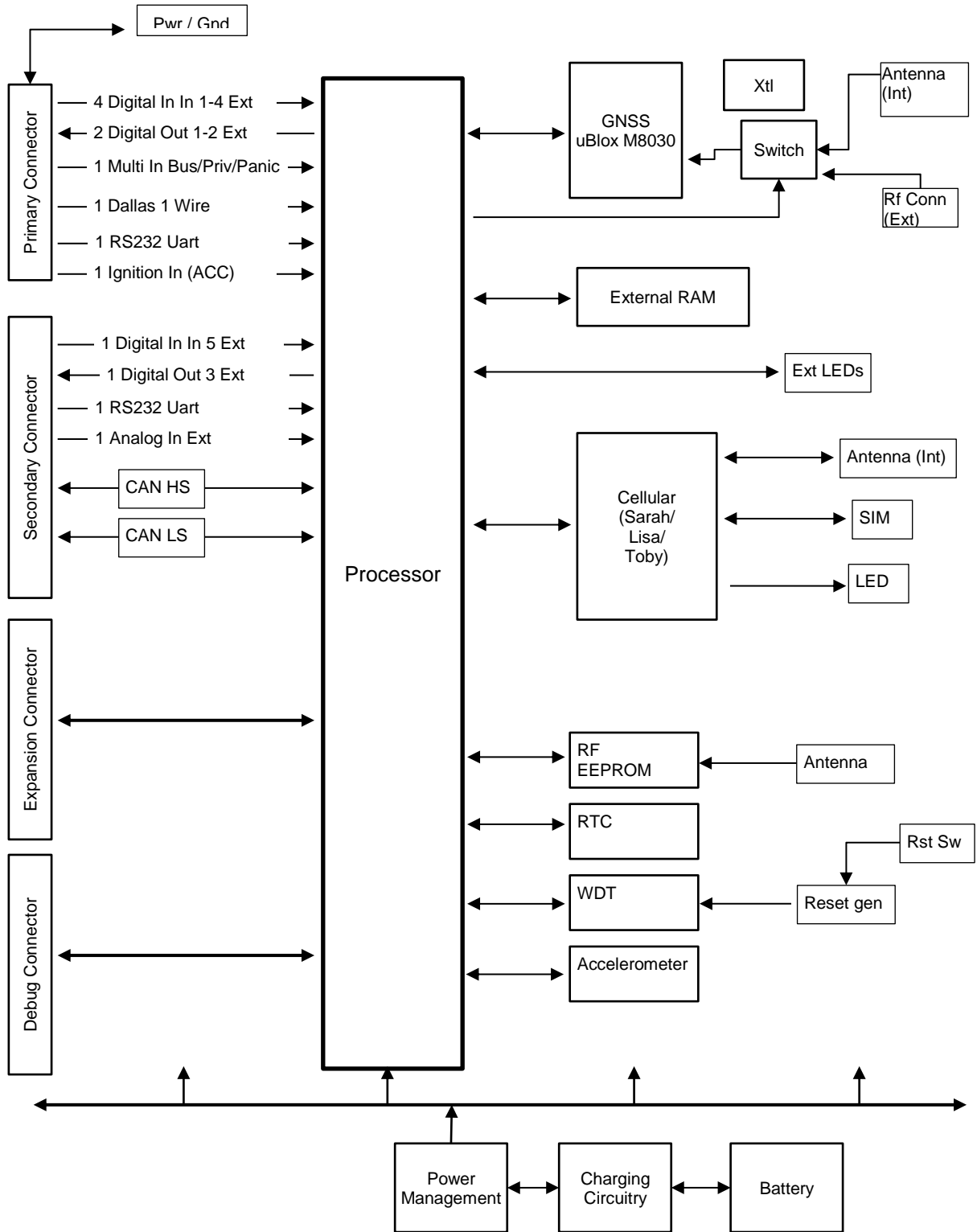



FIGURE 1 - BLOCK DIAGRAM

	DigiCore Technology (Pty) Ltd P.O. Box 68270, Highveld Park 0169, South Africa	Manual
	Ctrack NX35 Technical Manual	DCT-MAN-296

2.4. IDENTIFICATION AND OPTIONS

Model Number	Integrated Cellular Radio Module
NX35-G350	SARA-G350 Cellular Modem (2G)
NX35-U200	LISA-U200 Cellular Modem (3G)
NX35-L200	TOBY-L200 Cellular Modem (LTE)
NX35-C200	LISA-C200 Cellular Modem (CDMA)

3. EXTERNAL INTERFACES

3.1. WIRING CONNECTIONS AND CONNECTORS

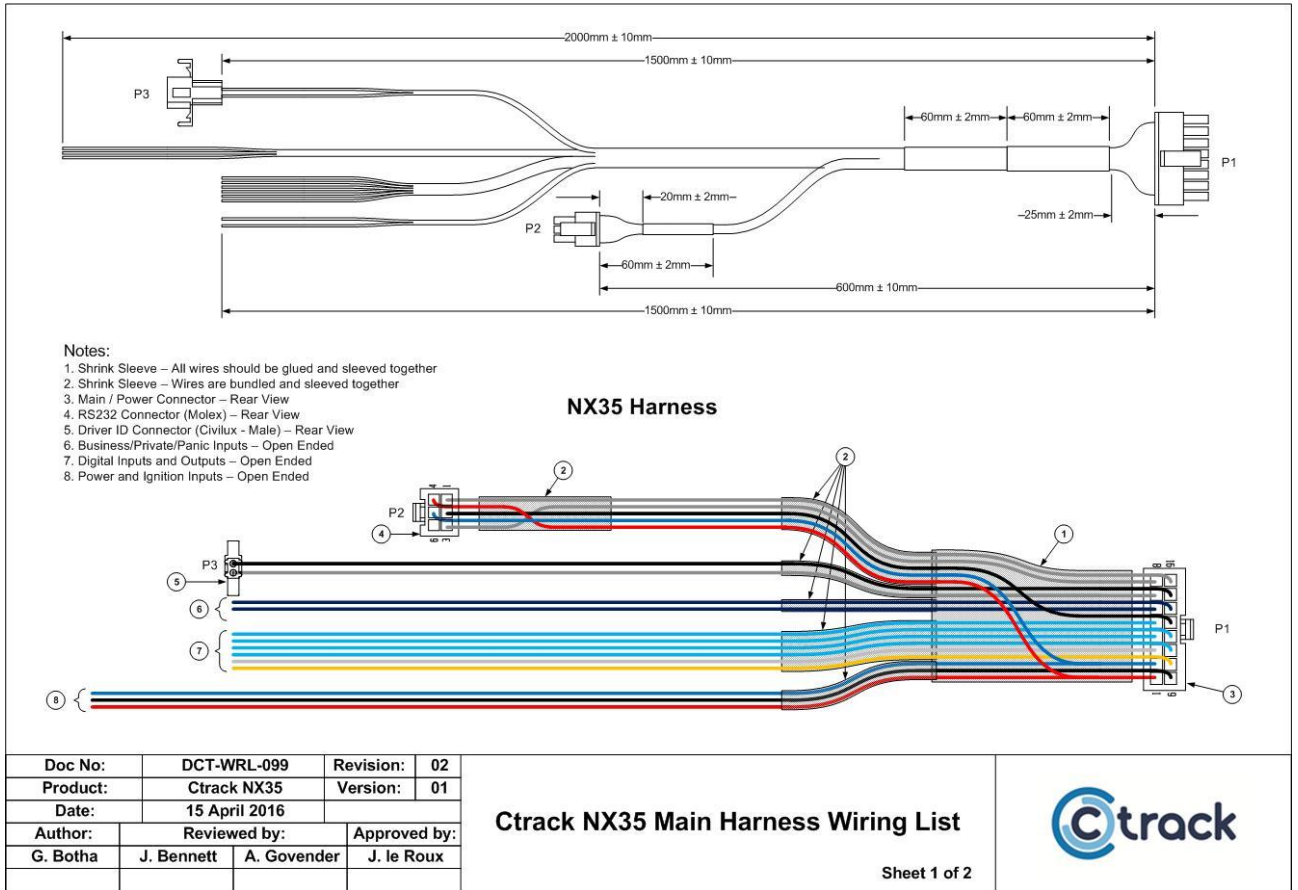

FIGURE 2 - MAIN HARNESS



NX35 Harness - Wiring

P1	P2	P3	POWER+ IGN	DIGITAL I/O	BUS/PRIV/PANIC	Function	Colour
1	4	-	✓	-	-	+VIN	RED
2	5	-	✓	-	-	IGN_IN_EXT	BLUE
3	-	-	-	✓	-	OUTPUT2_EXT	WHITE
4	-	-	-	✓	-	IN2_IN_EXT	BLUE/YELLOW
5	-	-	-	✓	-	IN4_IN_EXT	BLUE/GREEN
6	-	-	-	-	✓	BUS/PRIV_IN_EXT	BLUE/RED
7	-	1	-	-	-	1-WIRE_IN	GREY
8	3	-	-	-	-	COMMS_RXD	GREY/WHITE
9	-	-	✓	-	-	GND	BLACK
10	-	-	-	✓	-	OUTPUT1_EXT	ORANGE
11	-	-	-	✓	-	IN1_IN_EXT	BLUE/WHITE
12	-	-	-	✓	-	IN3_IN_EXT	BLUE/ORANGE
13	2	-	-	-	-	COMMS_GND	BLACK
14	-	-	-	-	✓	BUS/PRIV_GND	BLUE/BLACK
15	-	2	-	-	-	1-WIRE_GND	BLACK/GREY
16	1	-	-	-	-	COMMS_TXD	GREY/PURPLE
16Way Micro-Fit	6Way Micro-Fit	2Way Civilux	Open End 1	Open End 2	Open End 3		

Connector and Terminal Specification

Connector	QTY	Description	Part no.	Manufacturer
P1	1	16 Way, 3mm Pitch Micro-Fit, Molex	0430251600	Molex
P2	1	6 Way, 3mm Pitch Micro-Fit, Molex	0430250600	Molex
P3	1	2 Way, 1.58mm Male Plug, Civilux		
P1, P2	21	Micro-Fit 3.0 Crimp Terminals, Molex	0430300001	Molex
P3	2	1.58mm Male Crimp Terminal, Civilux		

Wire Specifications

Conductors						Wire	
Conductors	Dia	mm ²	Stranding	Material	Impedance	OD(mm)	Jacket
18	0.8	0.35	Multi	Bare Copper	-	1.6	-

Note 1: All cable material specifications should be automotive grade
Note 2: Do not strip or clean open ended wires

Doc No:	DCT-WRL-099	Revision:	02
Product:	Ctrack NX35	Version:	01
Date:	15 April 2016		
Author:	Reviewed by:		Approved by:
G. Botha	J. Bennett	A. Govender	J. le Roux

Ctrack NX35 Main Harness Wiring List

Sheet 2 of 2



FIGURE 3 – MAIN CONNECTOR SIGNALS

	DigiCore Technology (Pty) Ltd P.O. Box 68270, Highveld Park 0169, South Africa	Manual
	Ctrack NX35 Technical Manual	DCT-MAN-296

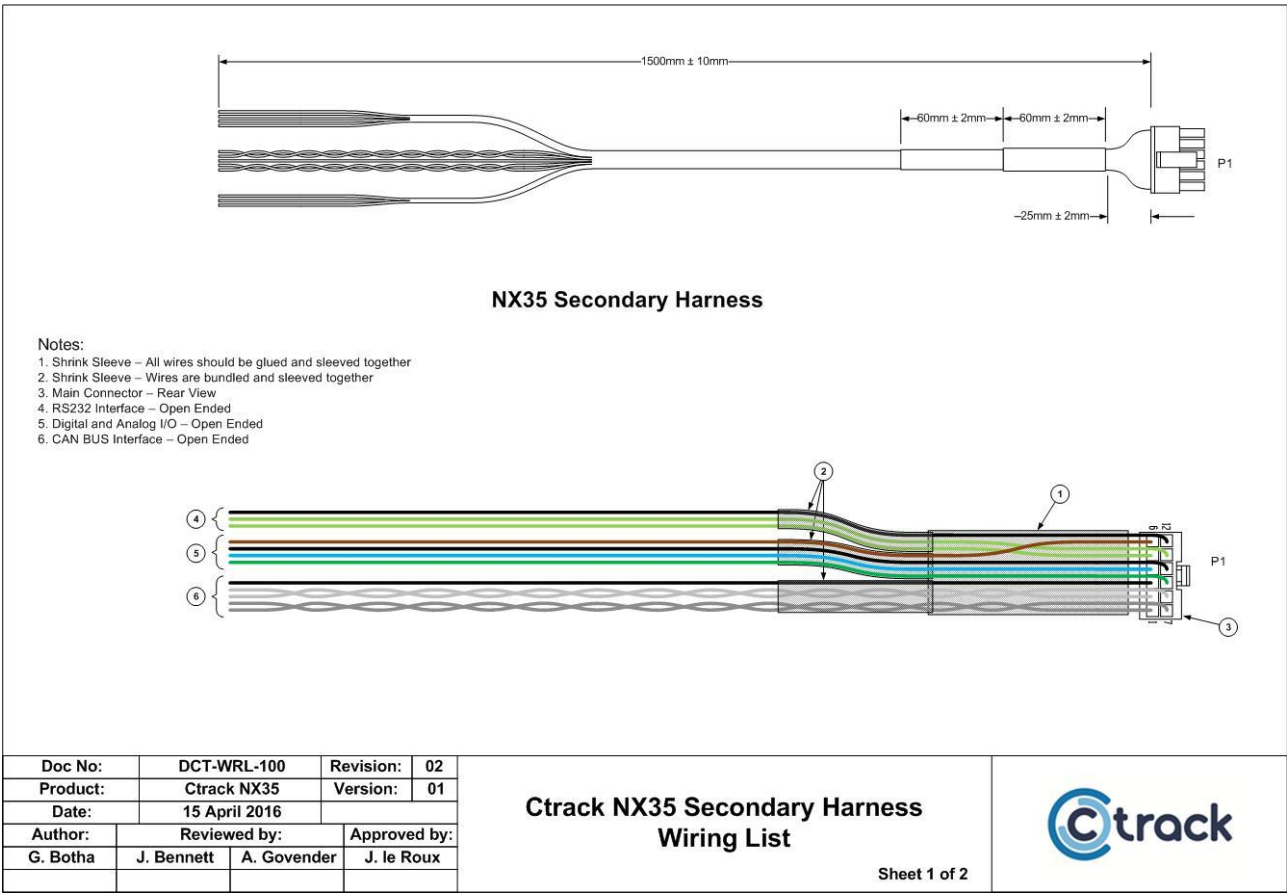



FIGURE 4 - SECONDARY HARNESS

	DigiCore Technology (Pty) Ltd P.O. Box 68270, Highveld Park 0169, South Africa	Manual
	Ctrack NX35 Technical Manual	DCT-MAN-296

NX35 Harness - Wiring					
P1	CAN	I/O	RS232	Function	Colour
1	✓	-	-	CANH_HS	GREY/YELLOW
2	✓	-	-	CANH_LS	WHITE/YELLOW
3	✓	-	-	CAN_GND	BLACK/WHITE
4	-	✓	-	IN5_IN_EXT	BLUE/GREY
5	-	-	✓	COMMS2_TXD	GREEN/PURPLE
6	-	✓	-	ANA_IN_EXT	BROWN
7	✓	-	-	CANL_HS	GREY/GREEN
8	✓	-	-	CANL_LS	WHITE/GREEN
9	-	✓	-	OUTPUT3_EXT	GREEN
10	-	✓	-	GND	BLACK
11	-	-	✓	COMMS2_RXD	GREEN/WHITE
12	-	-	✓	GND	BLACK
12Way Micro-Fit	Open End 1	Open End 2	Open End 3		

Connector and Terminal Specification			
Connector	QTY	Description	Manufacturer
P1	1	12 Way, 3mm Pitch Micro-Fit, Molex	Molex
P1	12	Micro-Fit 3.0 Crimp Terminals, Molex	Molex

Wire Specifications						
Conductors						Wire
Conductors	Dia	mm ²	Stranding	Material	Impedance	OD(mm) Jacket
12	0.8	0.35	Multi	Bare Copper	-	1.6

Note 1: All cable material specifications should be automotive grade
 Note 2: Do not strip or clean open ended wires
 Note 3: CAN Wire pair should be twisted at a rate of 1 turn per 25mm

Doc No:	DCT-WRL-100	Revision:	02	Ctrack NX35 Secondary Harness Wiring List	
Product:	Ctrack NX35	Version:	01		
Date:	15 April 2016				
Author:	Reviewed by:		Approved by:		
G. Botha	J. Bennett	A. Govender	J. le Roux		

Sheet 2 of 2

FIGURE 5 – SECONDARY CONNECTOR SIGNALS

3.2. SIGNAL DESCRIPTION – MAIN/SECONDARY CONNECTOR

The following tables describes the signals with reference to Figure 2 - Main Harness to Figure 5 – Secondary Connector Signals.

Plug	SIGNAL	DESCRIPTION
Main	+VIN	+VOLTAGE INPUT 6-32VDC
Main	GND	POWER GND
Main	IGN_IN_EXT	IGNITION SENSE - Active High Digital Input
Main	IN1_IN_EXT	INPUT 1 - Active Low Digital Input
Main	IN2_IN_EXT	INPUT 2 - Active Low Digital Input
Main	IN3_IN_EXT	INPUT 3 - Active High Digital Input
Main	IN4_IN_EXT	INPUT 4 - Active High Digital Input
Sec	IN5_IN_EXT	INPUT 5 – Can be used as active low digital input or pulse input (7KHz maximum pulse)
Main	OUTPUT1_EXT	DIGITAL OUTPUT1 – Immobilizer Output (Open collector)
-	OUTPUT2_EXT	DIGITAL OUTPUT2 – Buzzer Output
Sec	OUTPUT3_EXT	DIGITAL OUTPUT2 – Auxiliary Output (Open collector)

	DigiCore Technology (Pty) Ltd P.O. Box 68270, Highveld Park 0169, South Africa	Manual
	Ctrack NX35 Technical Manual	DCT-MAN-296

Main	BUS/PRIV_IN_EXT	BUSINESS / PRIVATE / PANIC INPUT
Main	BUS/PRIV_GND	BUSINESS / PRIVATE / PANIC GROUND
Main	1-WIRE_IN	DRIVER ID 1 WIRE INPUT
Main	COMMS_TXD	Serial Port 1 RS232 Transmit
Main	COMMS_RXD	Serial Port 1 RS232 Receive
Main	COMMS_GND	Serial Port 1 RS232 GND
Sec	COMMS2_TXD	Serial Port 2 RS232 Transmit
Sec	COMMS2_RXD	Serial Port 2 RS232 Receive
Sec	COMMS2_GND	Serial Port 2 RS232 GND
Sec	ANA_IN_EXT	ANALOGUE INPUT (0-12Volt)
Sec	CANH_HS	High Speed CAN "H" Signal
Sec	CANL_HS	High Speed CAN "L" Signal
Sec	CANH_LS	Low Speed CAN "H" Signal
Sec	CANL_LS	Low Speed CAN "L" Signal
Sec	CAN_GND	CAN GND

3.3. ENVIRONMENTAL

Certifications	E-Mark, CE-Mark, PTCRB, Australian
Operating Temperature	-20 to 80 deg C
Operating Humidity	95%

3.4. POWER

Input Voltage	6-32 Vdc
Internal Battery	3.6-4.2 Vdc
Normal Operation – GSM Option + maximum battery charging	<1A
Normal Operation – CDMA Option + maximum battery charging	<1A
Sleep Mode	<1 mA
Sleep Mode + maximum battery charging	< 500mA

	DigiCore Technology (Pty) Ltd P.O. Box 68270, Highveld Park 0169, South Africa	Manual
	Ctrack NX35 Technical Manual	DCT-MAN-296

3.5. MECHANICAL

Dimensions: 131 x 73 x 29mm

Weight: ~ 150g



FIGURE 6 - NX35 PICTURE

3.6. LEDS

LED	Function	Pattern and function
1-Green	Install State	On- Reading install state Flash – User installation input required Off – Ready (see *note)
2-Red	GNSS	On – GNSS on and unlocked Fast flash – 2D lock Slow flash – 3D lock Off – GNSS switched off (see *note)
3- Yellow	Heartbeat	Flash – Firmware running On –Firmware busy rebooting
4- Red	Cellular	Off- Cellular off or no service Blip/flashing- Registered on network On- Data transmit in progress
5-Green	Bluetooth	Off- BT disabled or off (see *note) On- BT on Slow flash- BT Discoverable mode Fast flash- Call in progress
6-Red	File system	On when FFS is accessed

	DigiCore Technology (Pty) Ltd P.O. Box 68270, Highveld Park 0169, South Africa	Manual
	Ctrack NX35 Technical Manual	DCT-MAN-296

*Note: 10Minutes after the unit has been finalised and the install tool disconnected, all LEDS will switch off for security reasons. To switch on the LEDs again, connect an install tool.

3.7. GNSS

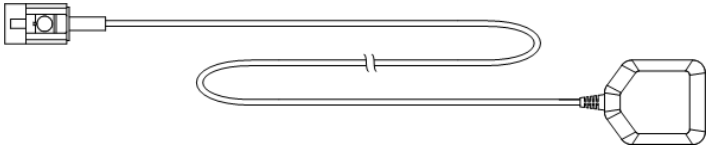
Part	u-blox M8 engine
GPS Receiver	72 channels, GPS/QZSS L1 frequency C/A Code, GLONASS L10F, BeiDou B1, Galileo E1B/C. SBAS L1 C/A; WAAS, EGNOS, MSAS, GAGAN
Time to first fix	Cold start: 26s Aided start: 2s Hot start: 1s
Accuracy	GPS/SBAS/QZSS+GLONASS : 2m
Multi-GNSS Assistance	AssistNow Online AssistNow Offline AssistNow Autonomous
Anti-jamming	Active CW detection and removal
Antenna	External antenna with internal antenna fall back. Antenna part example (DAM1575A4I10_K3M) External antenna assembly shown below: 

3.8. CELLULAR

The hardware layout makes provision for populating the following Cellular Modem types:

1. u-blox SARA-G350 (2G)
2. u-blox LISA-U200 (3G)
3. u-blox TOBY-L200 (LTE)
4. u-blox LISA-C200 (CDMA)

	DigiCore Technology (Pty) Ltd P.O. Box 68270, Highveld Park 0169, South Africa	Manual
	Ctrack NX35 Technical Manual	DCT-MAN-296

3.8.1. Option 1 - u-blox SARA-G350 Cellular Module

Quad band support	GSM 850/900/1800/1900 MHz
GPRS	GPRS Class 10, CS1-CS4 – up to 85.6 kb/s. PBCCH support
Circuit Switched Data	Up to 9.6 kbps
Encryption algorithms	A5/1 supported for GSM and GPRS modes
SMS	Mobile-originated and mobile-terminated SMS supported. Text and PDU modes supported
GSM Jamming detection	Supported

3.8.2. Option 2 - u-blox LISA-U200 Cellular Module

GSM band support	GSM 800/850/900/1700/1900/2100 MHz
GPRS	GPRS Class 12, CS1-CS4 – up to 85.6 kb/s.
EDGE	Class 12, MCS1-9
Circuit Switched Data	GSM Up to 9.6 kbps
Encryption algorithms	A5/1 supported for GSM and GPRS modes
SMS	Mobile-originated and mobile-terminated SMS supported. Text and PDU modes supported
GSM Jamming detection	Supported

3.8.3. Option 3 - u-blox TOBY-L200 Cellular Module

LTE band support	2,4,5,7,17 (N America)
UMTS	850/900/AWS/1900/2100
GSM	850/900/1800/1900
SMS	Mobile-originated and mobile-terminated SMS supported. Text and PDU modes supported
GSM Jamming detection	Future

	DigiCore Technology (Pty) Ltd P.O. Box 68270, Highveld Park 0169, South Africa	Manual
	Ctrack NX35 Technical Manual	DCT-MAN-296

3.8.4. Option 4 - u-blox LISA-C200 Cellular Module

CDMA band support	800, 1900 MHz (Sprint, Verizon)
SMS	Mobile-originated and mobile-terminated SMS supported. Text modes supported
Cellular Jamming detection	Future

3.9. **BLUETOOTH®**

The unit has an on-board Bluetooth® with the following major features:

Device	BCM20706 (Broadcom), (A2DP, SPP, GATT)
Bluetooth Specifications	Bluetooth v4.2 + EDR with integrated Class 1 PA
Integrated RF	Single-ended, 50-ohm RF interface Built-in TX/RX switch Tx class 1 or class2 output power capable RX sensitivity basic rate of -93.5 dBm RX sensitivity for Low Energy of -96.5 dBm
Max Transmit Power	< 12 dBm
BT Low Energy	Supported

	DigiCore Technology (Pty) Ltd P.O. Box 68270, Highveld Park 0169, South Africa	Manual
	Ctrack NX35 Technical Manual	DCT-MAN-296

4. INTERNAL COMPONENTS

4.1. ACCELEROMETER

An on-board 3-axis $\pm 8g$ accelerometer is used for various movement-detection functions:

1. Vehicle movement
2. Roll over and device tamper
3. Severe and High G-force
4. Harsh driving (acceleration, braking, cornering and up/down)

4.2. ON-BOARD MEMORY

The on-board memory is as follows:

- 16 MByte Parallel NOR flash for file system
- 4 Mbyte RAM
- 16 Kbit NFC EEPROM for storage of default settings.

4.3. SIM CARD INTERFACE

On-board SIM card reader with protection and supports 1V8 and 3V SIM cards. An optional second SIM is provided on the board for future use.

(Not supported for CDMA option.)

4.4. WATCHDOG

On-board hardware watchdog circuitry to ensure continuous system operation under all conditions.

4.5. INTERNAL BATTERY

- Uses single Li Polymer 1100mAH battery
- Supplies power to the electronics when external power is removed.
- Automatically charged when external power is connected
- Battery protection consist of over-voltage, under-voltage and over-current. Additional over-temperature protection is provided by the charger in conjunction with the built-in battery thermistor. The battery cannot be charged when its temperature is over 55 deg C.

Revision: 05	03 October 2017	COMPANY CONFIDENTIAL © DigiCore Technology (Pty) Ltd	Page 21 of 22
--------------	-----------------	---	---------------

	DigiCore Technology (Pty) Ltd P.O. Box 68270, Highveld Park 0169, South Africa	Manual
	Ctrack NX35 Technical Manual	DCT-MAN-296

5. REGULATORY COMPLIANCE STATEMENTS

5.1. FEDERAL COMMUNICATIONS COMMISSION (FCC) NOTICE

This equipment has been tested and found to comply with the limits for a Class B digital device, pursuant to Part 15 of the FCC Rules. These limits are designed to provide reasonable protection against harmful interference in a residential installation.

This equipment generates uses and can radiate radio frequency energy and, if not installed and used in accordance with the instructions, may cause harmful interference to radio communications. However, there is no guarantee that interference will not occur in a particular installation. If this equipment does cause harmful interference to radio or television reception, which can be determined by turning the equipment off and on, the user is encouraged to try to correct the interference by one of the following measures:

- Reorient or relocate the receiving antenna.
- Increase the separation between the equipment and receiver.
- Connect the equipment into an outlet on a circuit different from that to which the receiver is connected.
- Consult the dealer or an experienced radio/TV technician for help.

This device complies with part 15 of the FCC Rules. Operation is subject to the following two conditions:

- This device may not cause harmful interference, and
- this device must accept any interference received, including interference that may cause undesired operation

Any changes or modifications made to this device that are not expressly approved by Ctrack may void your authority to operate the equipment.

5.2. INNOVATION SCIENCE AND ECONOMIC DEVELOPMENT (ISED) NOTICE

This device complies with Industry Canada's Licence-Exempt RSSs. Operation is subject to the following two conditions:

- This device may not cause interference; and
- This device must accept any interference, including interference that may cause undesired operation of the device.

Le présent appareil est conforme aux CNR d'Industrie Canada applicables aux appareils radio exempts de licence. L'exploitation est autorisée aux deux conditions suivantes:

- l'appareil ne doit pas produire de brouillage;
- l'appareil doit accepter tout brouillage radioélectrique subi, même si le brouillage est susceptible d'en compromettre le fonctionnement.

5.3. FCC & ISED RF EXPOSURE GUIDANCE STATEMENT

In order to comply with FCC/ISED RF Exposure requirements, this device must be installed to provide at least 20 cm separation from the human body at all times.

Afin de se conformer aux exigences d'exposition RF FCC / ISED, cet appareil doit être installé pour fournir au moins 20 cm de séparation du corps humain en tout temps.

Revision: 05	03 October 2017	COMPANY CONFIDENTIAL © DigiCore Technology (Pty) Ltd	Page 22 of 22
--------------	-----------------	---	---------------