



---

**Choose certainty.  
Add value.**

# Report On

Application for Grant of Equipment Authorization of the  
Novatel Wireless Inc.  
MIFI8800L Wireless Hotspot Modem

FCC CFR 47 Part 2 90 and 96  
RSS-192 Issue 3 January 2008  
RSS-197 Issue 1 February 2010

**Report No. 72139211D**

**August 2018**



**REPORT ON** Radio Testing of the  
Novatel Wireless Inc.  
MIFI8800L Wireless Hotspot Modem

**TEST REPORT NUMBER** 72139211D

**PREPARED FOR** Novatel Wireless Inc.  
9605 Scranton Road, Suite 300  
San Diego, CA 92121  
USA

**CONTACT PERSON** Roman Olmos  
Senior Regulatory Engineer  
(858) 812-3400  
rolmos@nvtl.com

**PREPARED BY**   
Xiaoying Zhang  
**Name**  
Authorized Signatory  
Title: EMC/Wireless Test Engineer

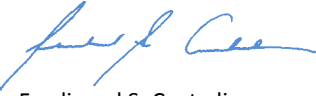
**APPROVED BY**   
Ferdinand S. Custodio  
**Name**  
Authorized Signatory  
Title: Senior EMC Test Engineer/Wireless Team Lead

**DATED** August 27, 2018



**Revision History**

72139211D Novatel Wireless Inc. MIFI8800L Wireless Hotspot Modem					
DATE	OLD REVISION	NEW REVISION	REASON	PAGES AFFECTED	APPROVED BY
08/27/2018	Initial Release				Ferdinand S. Custodio



## CONTENTS

Section	Page No
<b>1</b>	<b>REPORT SUMMARY..... 5</b>
1.1	Introduction ..... 6
1.2	Brief Summary of Results ..... 7
1.3	Product Information..... 8
1.4	EUT Test Configuration ..... 10
1.5	Deviations from the Standard..... 13
1.6	Modification Record..... 13
1.7	Test Methodology ..... 13
1.8	Test Facility Location ..... 13
1.9	Test Facility Registration ..... 13
1.10	Sample Calculations ..... 15
<b>2</b>	<b>TEST DETAILS..... 16</b>
2.1	Transmitter Conducted Power Measurements ..... 17
2.2	Effective Isotropic Radiated Power and Power Spectral Density ..... 27
2.3	Occupied Bandwidth ..... 34
2.4	Band Edge..... 38
2.5	Conducted Spurious Emissions ..... 57
2.6	Field Strength of Spurious Radiation ..... 88
2.7	Frequency Stability ..... 101
2.8	Receiver Spurious Emissions ..... 106
2.9	Conducted Emissions ..... 108
<b>3</b>	<b>TEST EQUIPMENT USED..... 112</b>
3.1	Test Equipment Used ..... 113
3.2	Measurement Uncertainty ..... 115
<b>4</b>	<b>DIAGRAM OF TEST SETUP..... 116</b>
4.1	Test Setup Diagram..... 117
<b>5</b>	<b>ACCREDITATION, DISCLAIMERS AND COPYRIGHT..... 121</b>
5.1	Accreditation, Disclaimers and Copyright..... 122



## **SECTION 1**

### **REPORT SUMMARY**

Radio Testing of the  
Novatel Wireless Inc.  
MIFI8800L Wireless Hotspot Modem



## 1.1 INTRODUCTION

The information contained in this report is intended to show verification of the Novatel Wireless Inc. MIFI8800L Wireless Hotspot Modem to the requirements of the following:

- FCC CFR 47 Part 2 90 and 96
- RSS-Gen Issue 5 April 2018
- RSS-192 Issue 3 January 2008
- RSS-197 Issue 1 February 2010

Objective	To perform Radio Testing to determine the Equipment Under Test's (EUT's) compliance with the Test Specification, for the series of tests carried out.
Manufacturer	Novatel Wireless Inc.
Product Trademark/Brand	Inseego
Product Marketing Name	MiFi 8800L
Model Number(s)	MIFI8800L
FCC ID Number	PKRNVWMIFI8800
IC Number	3229A-MIFI8800
Serial Number(s)	AZ280418A00132
Number of Samples Tested	1
Test Specification/Issue/Date	<ul style="list-style-type: none"><li>• FCC CFR 47 Part 2 90 and 96 (October 1, 2017)</li><li>• RSS-192 Issue 3 January 2008 - Fixed Wireless Access Equipment Operating in the Band 3450-3650 MHz</li><li>• RSS-197 Issue 1 February 2010 – Wireless Broadband Access Equipment Operating in the Band 3650-3700 MHz</li><li>• RSS-Gen Issue 5: April 2018 - General Requirements for Compliance of Radio Apparatus</li><li>• ANSI C63.26-2015: American National Standard for Compliance Testing of Transmitters Used in Licensed Radio Services</li></ul>
Start of Test	June 25, 2018
Finish of Test	July 26, 2018
Name of Engineer(s)	Xiaoying Zhang
Related Document(s)	Supporting documents for EUT certification are separate exhibits.



## 1.2 BRIEF SUMMARY OF RESULTS

A brief summary of the tests carried out in accordance with FCC CFR 47 Part 2 90 and 96 with cross-reference to the corresponding ISED RSS standard is shown below.

Section	FCC Part Sections(s)	RSS Section(s)	Test Description	Result
2.1	2.1046	RSS-192 (5.4)	Transmitter Conducted Output Power	Compliant
2.2	2.1046 96.41(b) 90.1321(c)	RSS-192 (5.4) RSS-197 (5.6)	Effective Isotropic Radiated Power and Power Spectral Density	Compliant
-	96.41(g)	-	Peak-Average Ratio	N/A*
2.3	2.1049 96.41(e)(3) 90.1323(a)	RSS-Gen (6.7)	Occupied Bandwidth	Compliant
2.4	2.1051 96.41(e)(1)(3) 90.1323(a)	RSS-192 (5.5) RSS-197 (5.7)	Band Edge and Emission Mask	Compliant
2.5	2.1051 96.41(e)(1)(2)(3) 90.1323(a)	RSS-192 (5.5) RSS-197 (5.7)	Conducted Spurious Emissions	Compliant
2.6	2.1053 96.41(e) 90.1323(a)	RSS-192 (5.5) RSS-197 (5.7)	Field Strength of Spurious Radiation	Compliant
2.7	2.1055	RSS-192 (5.3) RSS-197 (5.3)	Frequency Stability	Compliant
2.8	-	RSS-192 (5.6) RSS-197 (5.8) RSS-Gen 7.4	Receiver Spurious Emissions	Compliant
2.9	-	RSS-GEN 8.8	Power Line Conducted Emissions	Compliant

N/A\* Not applicable. For CBSD only.



**1.3 PRODUCT INFORMATION**

**1.3.1 EUT General Description**

The Equipment Under Test (EUT) was a Novatel Wireless Inc. MIFI8800L Wireless Hotspot Modem. The EUT is a Wireless Hotspot Modem supporting 2G/3G/4G Technologies. The EUT comes with a USB Port.

**1.3.2 Technical Description**

EUT Description Wireless Hotspot Modem

Product Marketing Name MiFi 8800L

Model Number(s) MIFI8800L

Rated Voltage 3.8V, 4500mAh (Rechargeable Li-Ion battery pack)  
 Input 100-240VAC, Output 5V (External AC-DC Power Adapter)

Mode Verified LTE Band 48: 3550-3700 MHz

Capability WCDMA Band 2, 5, LTE Band 2, 4, 5, 7, 13, 14, 46, 48, 66 and 802.11 a/b/g/n/ac

Primary Unit (EUT)  Production  
 Pre-Production  
 Engineering

Manufacturer declared Rated Power 23 dBm

(Client declaration, max. antenna gain covered under this test report)

LTE Bands	Frequency(ies)	Antenna Gains
Band 48	3550-3700 MHz	2.9 dBi





**1.3.3 Transmit Frequency Table**

LTE Band 48					
Modulation	Bandwidth (MHz)	Tx Frequency (MHz)	Emission Designator	EIRP / 10 MHz	
				Max Power (dBm)	Max Power (Watts)
QPSK	5	3550 - 3650	4M49G7D	21.98	0.16
	10		8M96G7D	21.91	0.16
	15		13M4G7D	20.72	0.12
	20		17M9G7D	19.19	0.08
16QAM	5		4M47W7D	21.0	0.13
	10		8M96W7D	20.86	0.12
	15		13M4W7D	19.63	0.09
	20		17M9W7D	18.21	0.07
64QAM	5		4M47W7D	20.14	0.10
	10		8M96W7D	20.06	0.10
	15		13M4W7D	18.77	0.08
	20		17M9W7D	17.33	0.05

LTE Band 48					
Modulation	Bandwidth (MHz)	Tx Frequency (MHz)	Emission Designator	EIRP / 25 MHz	
				Max Power (dBm)	Max Power (Watts)
QPSK	5	3650 - 3700	4M48G7D	22.78	0.19
	10		8M96G7D	22.9	0.19
	15		13M4G7D	22.86	0.19
	20		18M0G7D	22.97	0.20
16QAM	5		4M48W7D	22.07	0.16
	10		8M97W7D	22.05	0.16
	15		13M5W7D	22.01	0.16
	20		17M9W7D	22.17	0.16
64QAM	5		4M49W7D	21.08	0.13
	10		8M97W7D	21.15	0.13
	15		13M4W7D	20.98	0.13
	20		17M9W7D	21.2	0.13

## 1.4 EUT TEST CONFIGURATION

### 1.4.1 Test Configuration Description

Test Configuration	Description
A	Conducted antenna port measurement. EUT Transmits at max power and is powered by the internal battery and/or USB via AC Adapter.
B	Radiated test setup / case spurious emissions. Antenna port terminated by the call box.
C	Conducted antenna port measurement. EUT in receive mode and is powered by the internal battery and/or USB via AC Adapter.

### 1.4.2 EUT Exercise Software

EUT is controlled by a CMW 500 Wideband Radio Communication Tester. There are no other test software used during verification.

### 1.4.3 Support Equipment and I/O cables

Manufacturer	Equipment/Cable	Description
Novatel Wireless	USB Cable	Standard USB Type A to USB Type C
Novatel Wireless	External AC-DC Power Adapter	Model: SSW-2783, PN: 40123126.01 Input: 100-240VAC, 50/60Hz, 0.5A Output: 5VDC, max. 2A

### 1.4.4 Worst Case Configuration

Worst-case configuration used in this test report as per output power measurements:

Band	Channel BW	Modulation	RB Size/Offset
Band 48 (3450 – 3650 MHz)	15 MHz	QPSK	1/0
Band 48 (3650 – 3700 MHz)	20 MHz	QPSK	1/0

For radiated measurements X, Y, and Z orientations were verified. The verification was determined “Y” as worst case configuration.

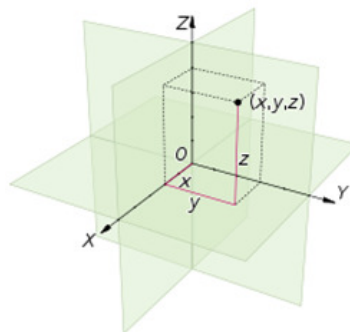

FCC ID PKRNVWMIFI8800  
IC: 3229A-MIFI8800  
Report No. 72139211D



### 1.4.5 Simplified Test Configuration Diagram

#### Radiated Test Configuration

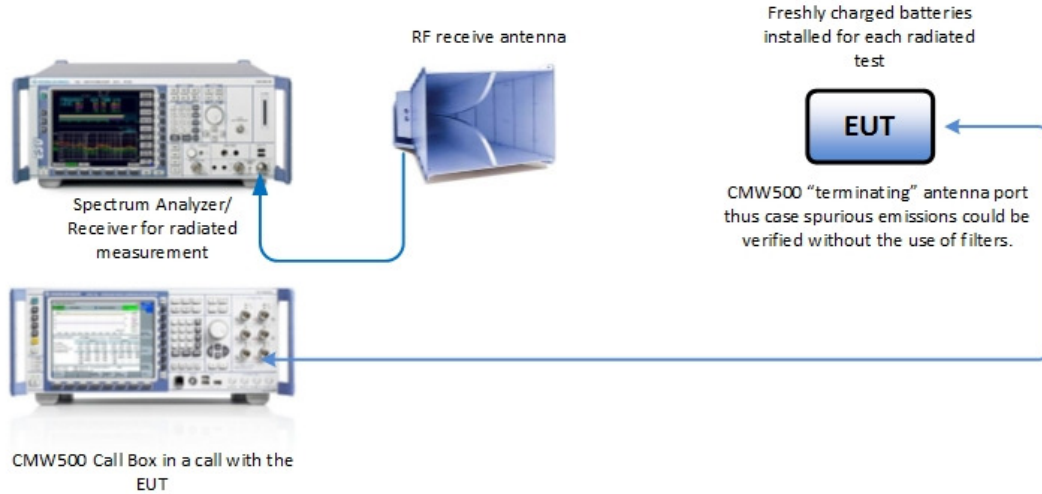

#### Conducted (Antenna Port) Test Configuration

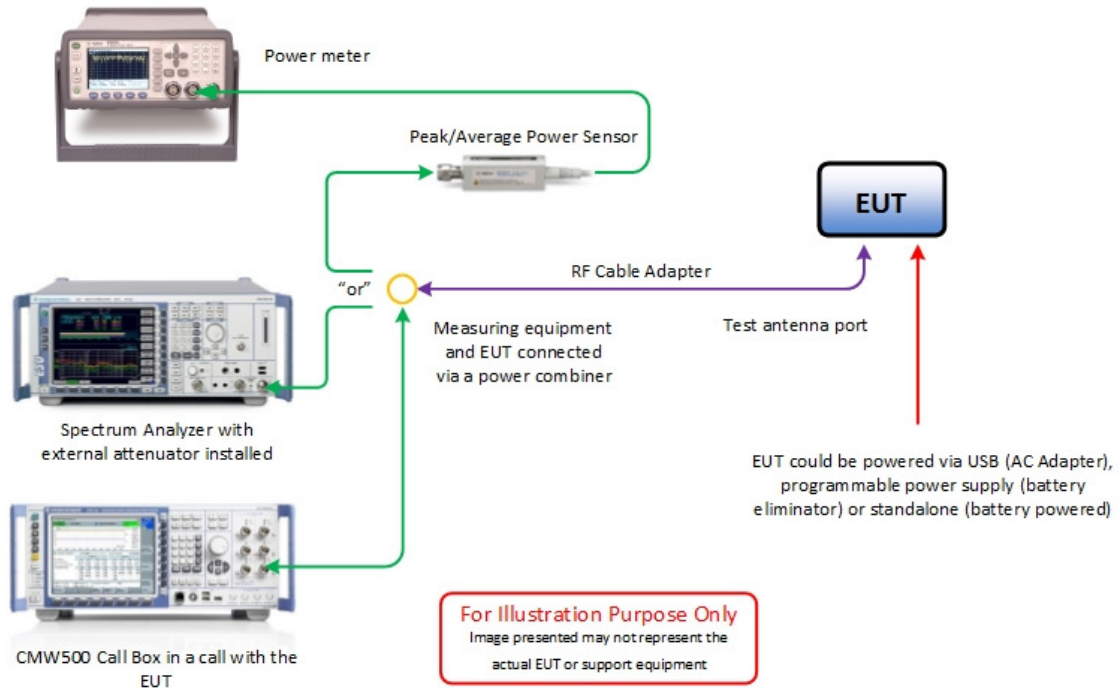



## 1.5 DEVIATIONS FROM THE STANDARD

No deviations from the applicable test standards or test plan were made during testing.

## 1.6 MODIFICATION RECORD

Description of Modification	Modification Fitted By	Date Modification Fitted
Serial Number AZ280418A00132		
None	—	—

The table above details modifications made to the EUT during the test programme. The modifications incorporated during each test (if relevant) are recorded on the appropriate test pages.

## 1.7 TEST METHODOLOGY

All measurements contained in this report were conducted with ANSI C63.26-2015, American National Standard for Compliance Testing of Transmitters Used in Licensed Radio Services.

For conducted and radiated emissions the equipment under test (EUT) was configured to measure its highest possible emission level. The test modes were adapted according to the Operating Instructions provided by the manufacturer/client.

## 1.8 TEST FACILITY LOCATION

### 1.8.1 TÜV SÜD America Inc. (Mira Mesa)

10040 Mesa Rim Road, San Diego, CA 92121-2912 (32.901268,-117.177681). Phone: (858) 678-1400 Fax: (858) 546-0364.

### 1.8.2 TÜV SÜD America Inc. (Rancho Bernardo)

16936 Via Del Campo, San Diego, CA 92127-1708 (33.018644,-117.092409). Phone: (858) 678-1400 Fax: (858) 546-0364.

## 1.9 TEST FACILITY REGISTRATION

### 1.9.1 FCC – Designation No.: US1146

TUV SUD America Inc. (San Diego), is an accredited test facility with the site description report on file and has met all the requirements specified in §2.948 of the FCC rules. The acceptance letter from the FCC is maintained in our files and the Designation is US1146.



**1.9.2 Innovation, Science and Economic Development Canada (IC) Registration No.: 3067A-1 & 22806-1**

The 10m Semi-anechoic chamber of TUV SUD America Inc. (San Diego Rancho Bernardo) has been registered by Certification and Engineering Bureau of Innovation, Science and Economic Development Canada for radio equipment testing with Registration No. 3067A-1.

The 3m Semi-anechoic chamber of TUV SUD America Inc. (San Diego Mira Mesa) has been registered by Certification and Engineering Bureau of Innovation, Science and Economic Development Canada for radio equipment testing with Registration No. 22806-1.

**1.9.3 BSMI – Laboratory Code: SL2-IN-E-028R (US0102)**

TUV Product Service Inc. (San Diego) is a recognized EMC testing laboratory by the BSMI under the MRA (Mutual Recognition Arrangement) with the United States. Accreditation includes CNS 13438 up to 6GHz.

**1.9.4 NCC (National Communications Commission - US0102)**

TUV SUD America Inc. (San Diego) is listed as a Foreign Recognized Telecommunication Equipment Testing Laboratory and is accredited to ISO/IEC 17025 (A2LA Certificate No.2955.13) which under APEC TEL MRA Phase 1 was designated as a Conformity Assessment Body competent to perform testing of equipment subject to the Technical Regulations covered under its scope of accreditation including RTTE01, PLMN01 and PLMN08 for TTE type of testing and LP002 for Low-Power RF Device type of testing.

**1.9.5 VCCI – Registration No. A-0280 and A-0281**

TUV SUD America Inc. (San Diego) is a VCCI registered measurement facility which includes radiated field strength measurement, radiated field strength measurement above 1GHz, mains port interference measurement and telecommunication port interference measurement.

**1.9.6 RRA – Identification No. US0102**

TUV SUD America Inc. (San Diego) is National Radio Research Agency (RRA) recognized laboratory under Phase I of the APEC Tel MRA.

**1.9.7 OFCA – U.S. Identification No. US0102**

TUV SUD America Inc. (San Diego) is recognized by Office of the Communications Authority (OFCA) under Appendix B, Phase I of the APEC Tel MRA.



**1.10 SAMPLE CALCULATIONS**

**1.10.1 LTE Emission Designator (QPSK)**

Emission Designator = 4M51G7D  
 G = Phase Modulation  
 7= Quantized/Digital Info  
 D = Data Transmission, telemetry, telecommand

**1.10.2 LTE Emission Designator (16QAM)**

Emission Designator = 4M50W7D  
 W = Frequency Modulation  
 7= Quantized/Digital Info  
 D = Data Transmission, telemetry, telecommand

**1.10.3 Spurious Radiated Emission (below 1GHz)**

Measuring equipment raw measurement (dbµV) @ 30 MHz		24.4
Correction Factor (dB)	Asset# 1066 (cable)	0.3
	Asset# 1172 (cable)	0.3
	Asset# 1016 (preamplifier)	-30.7
	Asset# 1175(cable)	0.3
	Asset# 1002 (antenna)	17.2
Reported QuasiPeak Final Measurement (dbµV/m) @ 30MHz		11.8

**1.10.4 Spurious Radiated Emission – Substitution Method**

Example = 84dBµV/m @ 1413 MHz (numerical sample only)

The field strength reading of 84dBµV/m @ 1413 MHz (2<sup>nd</sup> Harmonic of 706.5 MHz) is the maximized measurement when the EUT is on the turntable measured at 3 meters. The gain of the substituted antenna is 7.8dBi while the transmit cable loss is 1.0 dB (cable between signal generator and the substituted antenna). The signal generator level is adjusted until the 84dBµV/m level at the receiving end is replicated (identical test setup, i.e. same antenna, cable/s and preamp). If the adjusted signal generator level is -18dBm, then we have the following for both EIRP and ERP as required:

$$\begin{aligned}
 P_{EIRP} &= -18 \text{ dBm} + 7.8 \text{ dBi} - 1 \text{ dB} \\
 &= 11.2 \text{ dBm} \\
 P_{ERP} &= P_{EIRP} - 2.15 \text{ dB} \\
 &= 11.2 \text{ dBm} - 2.15 \text{ dB} \\
 &= 9.05 \text{ dBm}
 \end{aligned}$$



## **SECTION 2**

### **TEST DETAILS**

Radio Testing of the  
Novatel Wireless Inc.  
MIFI8800L Wireless Hotspot Modem





## 2.1 TRANSMITTER CONDUCTED POWER MEASUREMENTS

### 2.1.1 Specification Reference

FCC 47 CFR Part 2, Clause 2.1046  
RSS-192, Clause 5.4

### 2.1.2 Standard Applicable

The conducted power measurements were made in accordance to FCC Part 2 Clause 2.1046 and RSS-192 Clause 5.4.

RSS-192, Clause 5.4:

The average output power,  $P_{\text{mean}}$ , shall be within  $\pm 2.0$  dB of the manufacturer's rated power. The e.i.r.p shall comply with the limits specified in SRS-303.4.

### 2.1.3 Equipment Under Test and Modification State

Serial No: AZ280418A00132 / Test Configuration A

### 2.1.4 Date of Test/Initial of test personnel who performed the test

June 29, 2018 / XYZ

### 2.1.5 Test Equipment Used

The major items of test equipment used for the above tests are identified in Section 3.1.

### 2.1.6 Environmental Conditions/ Test Location

Test performed at TÜV SÜD America Inc. Rancho Bernardo facility

Ambient Temperature	24.80 °C
Relative Humidity	43.2 %
ATM Pressure	98.8kPa

### 2.1.7 Additional Observations

- This is a conducted test using Power Meter.
- The path loss were measured and entered as a level offset.
- Low, Middle and High channels for all bandwidths with different RB size and RB offset and modulations were verified and reported.



2.1.8 Test Results

LTE Band 48 (3550-3650 MHz) according to FCC Part 96 / RSS-192							
Bandwidth (MHz)	Channel	Frequency (MHz)	Modulation	No. RB	RB Start	Average Power (dBm)	Peak Power (dBm)
5.0	55265	3552.5	QPSK	1	0	19.45	27.0
				1	13	19.42	26.91
				1	24	19.44	27.02
				25	0	18.53	27.45
			16QAM	1	0	18.74	28.06
				1	13	18.74	27.89
				1	24	18.7	27.98
				25	0	17.46	28.07
			64QAM	1	0	17.67	28.88
				1	13	17.66	28.78
				1	24	17.62	28.84
				25	0	16.52	27.98
	55740	3600	QPSK	1	0	20.04	27.6
				1	13	20.0	27.55
				1	24	19.99	27.52
				25	0	19.08	28.08
			16QAM	1	0	19.35	28.53
				1	13	19.34	28.49
				1	24	19.29	28.51
				25	0	18.1	28.72
			64QAM	1	0	18.46	28.49
				1	13	18.36	28.61
				1	24	18.3	28.49
				25	0	17.24	28.94
56215	3647.5	QPSK	1	0	19.63	27.34	
			1	13	19.55	27.07	
			1	24	19.48	27.11	
			25	0	18.44	27.86	
		16QAM	1	0	18.91	28.27	
			1	13	18.86	28.13	
			1	24	18.81	28.18	
			25	0	17.62	28.75	
		64QAM	1	0	17.88	28.98	
			1	13	17.88	28.77	
			1	24	17.86	28.72	
			25	0	16.64	27.72	



LTE Band 48 (3550-3650 MHz) according to FCC Part 96 / RSS-192							
Bandwidth (MHz)	Channel	Frequency (MHz)	Modulation	No. RB	RB Start	Average Power (dBm)	Peak Power (dBm)
10.0	55290	3555	QPSK	1	0	19.39	26.94
				1	25	19.27	26.81
				1	49	19.29	26.86
				50	0	18.38	27.83
			16QAM	1	0	18.43	27.9
				1	25	18.33	27.82
				1	49	18.39	27.83
				50	0	17.34	27.69
			64QAM	1	0	17.71	28.88
				1	25	17.68	28.64
				1	49	17.7	28.8
				50	0	16.5	28.08
	55740	3600	QPSK	1	0	20.09	27.49
				1	25	19.94	27.38
				1	49	19.85	27.41
				50	0	19.01	28.22
			16QAM	1	0	19.3	28.45
				1	25	19.08	28.42
				1	49	19.03	28.46
				50	0	17.96	28.62
			64QAM	1	0	18.31	28.48
				1	25	18.09	28.4
				1	49	18.02	28.43
				50	0	17.16	28.36
56190	3645	QPSK	1	0	19.6	27.14	
			1	25	19.35	26.92	
			1	49	19.19	26.89	
			50	0	18.48	27.7	
		16QAM	1	0	18.81	28.18	
			1	25	18.61	28.06	
			1	49	18.53	27.96	
			50	0	17.62	28.15	
		64QAM	1	0	17.71	28.65	
			1	25	17.45	28.38	
			1	49	17.33	28.84	
			50	0	16.55	29.21	



LTE Band 48 (3550-3650 MHz) according to FCC Part 96 / RSS-192							
Bandwidth (MHz)	Channel	Frequency (MHz)	Modulation	No. RB	RB Start	Average Power (dBm)	Peak Power (dBm)
15.0	55315	3557.5	QPSK	1	0	19.52	27.01
				1	38	19.36	26.77
				1	74	19.47	26.9
				75	0	18.36	27.68
			16QAM	1	0	18.89	28.01
				1	38	18.61	27.83
				1	74	18.71	27.87
				75	0	17.55	27.76
			64QAM	1	0	17.75	28.88
				1	38	17.61	28.74
				1	74	17.72	28.71
				75	0	16.51	27.81
	55740	3600	QPSK	1	0	20.26	27.62
				1	38	20.01	27.45
				1	74	19.99	27.53
				75	0	19.10	28.23
			16QAM	1	0	19.35	28.56
				1	38	19.13	28.38
				1	74	19.08	28.47
				75	0	18.02	28.41
			64QAM	1	0	18.33	28.53
				1	38	18.19	28.42
				1	74	18.18	28.44
				75	0	17.15	28.96
56165	3642.5	QPSK	1	0	19.88	27.33	
			1	38	19.41	27.0	
			1	74	19.27	26.87	
			75	0	18.59	17.89	
		16QAM	1	0	18.97	28.44	
			1	38	18.49	28.07	
			1	74	18.35	29.97	
			75	0	17.69	28.33	
		64QAM	1	0	18.26	29.3	
			1	38	17.82	29.0	
			1	74	17.66	28.33	
			75	0	16.73	27.98	



LTE Band 48 (3550-3650 MHz) according to FCC Part 96 / RSS-192							
Bandwidth (MHz)	Channel	Frequency (MHz)	Modulation	No. RB	RB Start	Average Power (dBm)	Peak Power (dBm)
20.0	55340	3560	QPSK	1	0	19.59	27.09
				1	50	19.53	26.92
				1	99	19.57	27.03
				100	0	18.34	27.7
			16QAM	1	0	18.64	28.13
				1	50	18.47	27.9
				1	99	18.71	28.0
				100	0	17.62	27.88
			64QAM	1	0	17.89	28.99
				1	50	17.58	28.68
				1	99	17.85	28.87
				100	0	16.6	27.72
	55740	3600	QPSK	1	0	20.03	27.42
				1	50	19.83	27.2
				1	99	19.76	27.24
				100	0	18.81	27.89
			16QAM	1	0	19.39	28.43
				1	50	19.07	28.23
				1	99	19.01	28.25
				100	0	17.81	28.32
			64QAM	1	0	18.34	29.17
				1	50	18.16	29.05
				1	99	18.07	29.18
				100	0	16.96	28.52
56140	3640	QPSK	1	0	20.03	27.67	
			1	50	19.52	27.14	
			1	99	19.23	26.91	
			100	0	18.72	27.76	
		16QAM	1	0	19.15	28.59	
			1	50	18.61	28.19	
			1	99	18.49	28.01	
			100	0	17.84	28.58	
		64QAM	1	0	18.26	29.54	
			1	50	17.67	29.0	
			1	99	17.57	28.97	
			100	0	16.86	28.22	



America

LTE Band 48 (3650-3700 MHz) according to FCC Part 90 / RSS-197							
Bandwidth (MHz)	Channel	Frequency (MHz)	Modulation	No. RB	RB Start	Average Power (dBm)	Peak Power (dBm)
5.0	56265	3652.5	QPSK	1	0	19.63	27.28
				1	13	19.58	27.2
				1	24	19.53	27.21
				25	0	19.41	27.16
			16QAM	1	0	18.94	28.28
				1	13	18.94	28.15
				1	24	18.83	28.16
				25	0	17.66	27.9
			16QAM	1	0	17.94	29.18
				1	13	17.81	29.02
				1	24	17.87	28.83
				25	0	16.66	28.64
	56490	3675	QPSK	1	0	19.88	27.46
				1	13	19.73	27.41
				1	24	19.87	27.48
				25	0	18.77	27.89
			16QAM	1	0	19.17	28.5
				1	13	19.16	28.46
				1	24	19.13	28.49
				25	0	17.94	28.84
			16QAM	1	0	18.18	28.55
				1	13	18.12	28.5
				1	24	18.14	28.48
				25	0	16.96	28.49
	56715	3697.5	QPSK	1	0	19.7	27.3
				1	13	19.69	27.2
				1	24	19.67	27.24
				25	0	18.66	27.92
16QAM			1	0	19.02	28.37	
			1	13	19.12	28.33	
			1	24	19.05	28.46	
			25	0	17.9	28.25	
16QAM			1	0	18.07	29.22	
			1	13	18.02	29.29	
			1	24	18.01	29.32	
			25	0	16.9	29.2	



LTE Band 48 (3650-3700 MHz) according to FCC Part 90 / RSS-197							
Bandwidth (MHz)	Channel	Frequency (MHz)	Modulation	No. RB	RB Start	Average Power (dBm)	Peak Power (dBm)
10.0	56290	3655	QPSK	1	0	19.66	27.35
				1	25	19.43	27.07
				1	49	19.49	27.12
				50	0	18.58	27.79
			16QAM	1	0	18.92	28.32
				1	25	18.71	28.19
				1	49	18.65	28.09
				50	0	17.73	28.3
			64QAM	1	0	17.91	28.37
				1	25	17.61	28.16
				1	49	17.7	28.07
				50	0	16.74	28.6
	56490	3675	QPSK	1	0	20.0	27.48
				1	25	19.82	27.41
				1	49	19.88	27.48
				50	0	18.81	28.0
			16QAM	1	0	19.15	28.49
				1	25	19.15	28.43
				1	49	19.07	28.5
				50	0	17.98	28.66
			64QAM	1	0	18.13	28.56
				1	25	18.05	28.4
				1	49	18.12	28.4
				50	0	16.98	28.58
56690	3695	QPSK	1	0	19.89	27.31	
			1	25	19.55	27.14	
			1	49	19.58	27.22	
			50	0	18.57	27.76	
		16QAM	1	0	18.79	28.26	
			1	25	18.68	28.23	
			1	49	18.7	28.22	
			50	0	17.68	28.52	
		64QAM	1	0	18.25	29.28	
			1	25	18.11	29.19	
			1	49	18.04	29.31	
			50	0	16.89	28.19	



LTE Band 48 (3650-3700 MHz) according to FCC Part 90 / RSS-197							
Bandwidth (MHz)	Channel	Frequency (MHz)	Modulation	No. RB	RB Start	Average Power (dBm)	Peak Power (dBm)
15.0	56315	3657.5	QPSK	1	0	19.73	27.21
				1	38	19.44	26.96
				1	74	19.32	26.85
				75	0	18.45	27.89
			16QAM	1	0	18.84	28.29
				1	38	18.47	27.94
				1	74	18.39	27.87
				75	0	17.61	28.19
			64QAM	1	0	18.08	29.17
				1	38	17.75	28.96
				1	74	17.71	28.9
				75	0	16.65	28.12
	56490	3675	QPSK	1	0	19.96	27.53
				1	38	19.79	27.38
				1	74	19.95	27.4
				75	0	18.76	28.29
			16QAM	1	0	19.11	28.41
				1	38	18.97	28.34
				1	74	19.06	28.53
				75	0	17.99	28.51
			64QAM	1	0	18.07	28.47
				1	38	18.04	28.35
				1	74	18.12	28.59
				75	0	17.01	29.11
	56665	3692.5	QPSK	1	0	19.81	27.29
				1	38	19.63	27.15
				1	74	19.67	27.24
				75	0	18.74	27.98
			16QAM	1	0	18.99	28.23
				1	38	18.87	28.18
				1	74	18.96	28.29
				75	0	17.73	28.82
			64QAM	1	0	18.07	29.12
				1	38	17.92	29.14
				1	74	17.93	29.13
				75	0	16.82	28.38





America

LTE Band 48 (3650-3700 MHz) according to FCC Part 90 / RSS-197							
Bandwidth (MHz)	Channel	Frequency (MHz)	Modulation	No. RB	RB Start	Average Power (dBm)	Peak Power (dBm)
20.0	56340	3660	QPSK	1	0	19.81	27.25
				1	50	19.4	26.94
				1	99	19.38	26.87
				100	0	18.55	27.73
			16QAM	1	0	18.98	28.39
				1	50	18.71	28.07
				1	99	18.63	27.92
				100	0	17.63	28.17
			64QAM	1	0	18.05	29.94
				1	50	17.71	28.94
				1	99	17.54	28.8
				100	0	16.64	28.4
	56490	3675	QPSK	1	0	20.03	27.54
				1	50	19.88	27.42
				1	99	20.06	27.52
				100	0	18.91	28.11
			16QAM	1	0	19.27	28.47
				1	50	19.08	28.27
				1	99	19.33	28.59
				100	0	17.96	28.69
			64QAM	1	0	18.3	29.25
				1	50	18.1	29.25
				1	99	18.27	29.42
				100	0	17.04	28.73
56640	3690	QPSK	1	0	20.07	27.46	
			1	50	19.87	27.32	
			1	99	19.73	27.24	
			100	0	18.92	28.09	
		16QAM	1	0	19.17	28.38	
			1	50	19.05	28.28	
			1	99	19.05	28.34	
			100	0	18.08	28.96	
		64QAM	1	0	18.19	29.2	
			1	50	17.95	29.2	
			1	99	17.98	29.3	
			100	0	17.1	28.89	

### 2.1.9 Sample Test Measurement Screen

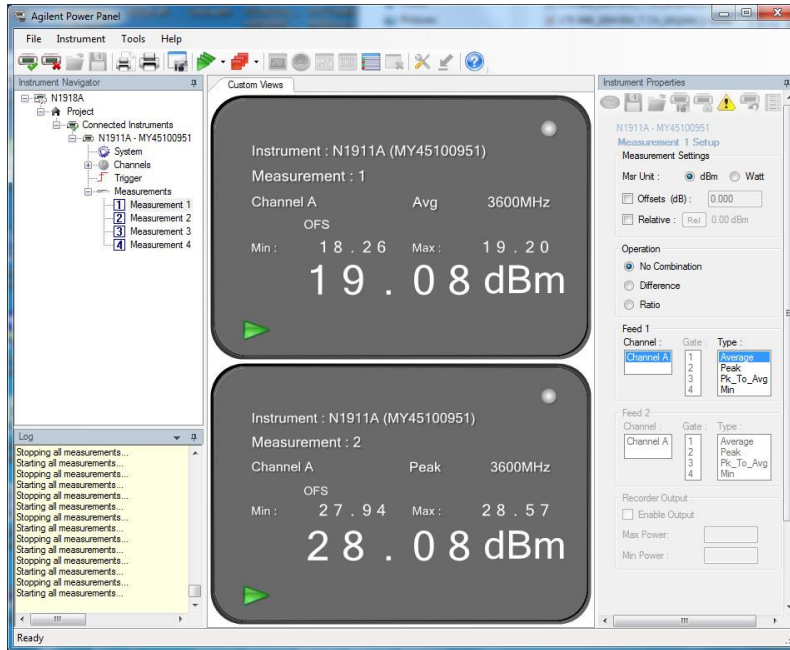

LTE Band 48 (3550 – 3650 MHz)\_5M Bandwidth Middle Chanel QPSK Full RB

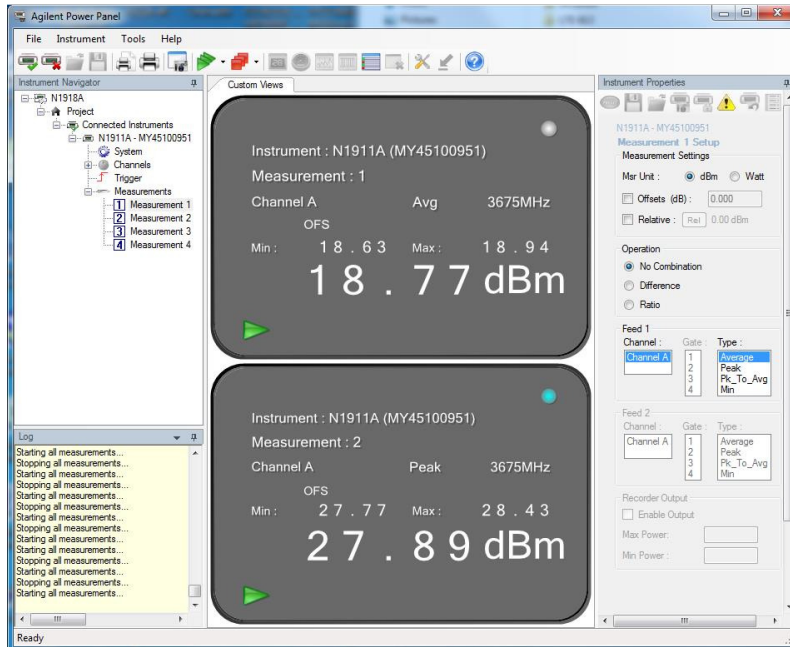

LTE Band 48 (3650 – 3700 MHz)\_5 MHz Bandwidth\_Middle Chanel QPSK Full RB



## 2.2 EFFECTIVE ISOTROPIC RADIATED POWER AND POWER SPECTRAL DENSITY

### 2.2.1 Specification Reference

FCC 47 CFR Part 2, Clause 2.1046  
FCC 47 CFR Part 96, Clause 41(b)  
FCC 47 CFR Part 90, Clause 90.1321(c)  
RSS-192, Clause 5.4  
RSS-197, Clause 5.6

### 2.2.2 Standard Applicable

FCC 47 CFR Part 96, Clause 96.41:

(b) Unless otherwise specified in this section, the maximum effective isotropic radiated power (EIRP) and maximum Power Spectral Density (PSD) of any CBSD and End User Device must comply with the limits shown in the table below:

Device	Maximum EIRP (dBm/10 MHz)	Maximum PSD (dBm/MHz)
End User Device	23	N/A
Category A CBSD	30	20
Category B CBSD	47	37

RSS-192, Clause 5.4:

The average output power,  $P_{mean}$ , shall be within 2.0 dB of the manufacturer's rated power. The e.i.r.p shall comply with the limits specified in SRSP-303.4.

FCC 47 CFR Part 90, Clause 90.1321:

(c) Mobile and portable stations are limited to 1 watt/25 MHz EIRP. In any event, the peak EIRP density shall not exceed 40 milliwatts in any one-mega-hertz slice of spectrum.

RSS-197, Clause 5.6;

The maximum e.i.r.p density of mobile equipment shall not exceed 40 mW in any 1 MHz bandwidth.

### 2.2.3 Equipment Under Test and Modification State

Serial No: AZ280418A00132, Test Configuration A

### 2.2.4 Date of Test/Initial of test personnel who performed the test

July 09, 2018 /XYZ

### 2.2.5 Test Equipment Used

The major items of test equipment used for the above tests are identified in Section 3.1.



## 2.2.6 Environmental Conditions/ Test Location

Test performed at TÜV SÜD America Inc. Rancho Bernardo facility

Ambient Temperature	27.8 °C
Relative Humidity	39.4 %
ATM Pressure	98.8 kPa

## 2.2.7 Additional Observations

- EIRP was calculated as per Section 1.2 and 1.3 of KDB412172 D01 (Determining ERP and EIRP v01r01).
- Calculation formula in logarithmic terms:

$$\text{EIRP} = P_T + G_T - L_C$$

Where:

$P_T$  = transmitter conducted output power dBm (Section 2.1 of this test report)  
 $G_T$  = gain of the transmitting antenna, in dBi (EIRP);  
 $L_C$  = signal attenuation in the connecting cable between the transmitter and antenna, in dB (EUT poses an internal Antenna. The loss between the EUT and the antenna port is considered negligible).

- Maximum EIRP (dBm/10 MHz) for 3550 – 3650 MHz 15 MHz and 20 MHz bandwidth is calculated using the following formula:

$$\text{Maximum EIRP (dBm/10 MHz)} = \text{EIRP}_{(\text{Full RB})} - 10 \lg(\text{OBW} / 10)$$

- This is a conducted test for EIRP Density in any 1 MHz.
- The path loss were measured and entered as a level offset.
- Low, Middle and High channels for all modulations were verified and reported.



**2.2.8 Test Results**

LTE Band 48 (3550 – 3650 MHz) EIRP according to FCC Part 96 / RSS-192									
Modulation	Bandwidth (MHz)	RB Size/Offset	Channels	Frequency (MHz)	Average Power (dBm)	Antenna Gain (dBi)	EIRP (dBm)	Limit (dBm)	Compliance
QPSK	5	1 / 0	55265	3552.5	19.45	2.9	22.35	23 ± 2	Yes
		1 / 0	55740	3600	20.04	2.9	22.94	23 ± 2	Yes
		1 / 0	56215	3647.5	19.63	2.9	22.53	23 ± 2	Yes
	10	1 / 0	55290	3555	19.39	2.9	22.29	23 ± 2	Yes
		1 / 0	55740	3600	20.09	2.9	22.99	23 ± 2	Yes
		1 / 0	56190	3645	19.6	2.9	22.5	23 ± 2	Yes
	15	1 / 0	55315	3557.5	19.52	2.9	22.42	23 ± 2	Yes
		1 / 0	55740	3600	20.26	2.9	23.16	23 ± 2	Yes
		1 / 0	56165	3642.5	19.88	2.9	22.78	23 ± 2	Yes
	20	1 / 0	55340	3560	19.59	2.9	22.49	23 ± 2	Yes
		1 / 0	55740	3600	20.03	2.9	22.93	23 ± 2	Yes
		1 / 0	56140	3640	20.03	2.9	22.93	23 ± 2	Yes
16QAM	5	1 / 0	55265	3552.5	18.74	2.9	21.64	23 ± 2	Yes
		1 / 0	55740	3600	19.35	2.9	22.25	23 ± 2	Yes
		1 / 0	56215	3647.5	18.91	2.9	21.81	23 ± 2	Yes
	10	1 / 0	55290	3555	18.43	2.9	21.33	23 ± 2	Yes
		1 / 0	55740	3600	19.3	2.9	22.2	23 ± 2	Yes
		1 / 0	56190	3645	18.81	2.9	21.71	23 ± 2	Yes
	15	1 / 0	55315	3557.5	18.89	2.9	21.79	23 ± 2	Yes
		1 / 0	55740	3600	19.35	2.9	22.25	23 ± 2	Yes
		1 / 0	56165	3642.5	18.97	2.9	21.87	23 ± 2	Yes
	20	1 / 0	55340	3560	18.64	2.9	21.54	23 ± 2	Yes
		1 / 0	55740	3600	19.39	2.9	22.29	23 ± 2	Yes
		1 / 0	56140	3640	19.15	2.9	22.05	23 ± 2	Yes
64QAM	5	1 / 0	55265	3552.5	17.67	2.9	20.57	23 ± 2	Yes
		1 / 0	55740	3600	18.46	2.9	21.36	23 ± 2	Yes
		1 / 0	56215	3647.5	17.88	2.9	20.78	23 ± 2	Yes
	10	1 / 0	55290	3555	17.71	2.9	20.61	23 ± 2	Yes
		1 / 0	55740	3600	18.31	2.9	21.21	23 ± 2	Yes
		1 / 0	56190	3645	17.71	2.9	20.61	23 ± 2	Yes
	15	1 / 0	55315	3557.5	17.75	2.9	20.65	23 ± 2	Yes
		1 / 0	55740	3600	18.33	2.9	21.23	23 ± 2	Yes
		1 / 0	56165	3642.5	18.26	2.9	21.16	23 ± 2	Yes
	20	1 / 0	55340	3560	17.89	2.9	20.79	23 ± 2	Yes
		1 / 0	55740	3600	18.34	2.9	21.24	23 ± 2	Yes
		1 / 0	56140	3640	18.26	2.9	21.16	23 ± 2	Yes



LTE Band 48 (3550 – 3650 MHz) EIRP/10 MHz according to FCC Part 96 / RSS-192								
Modulation	Bandwidth (MHz)	Channels	Frequency (MHz)	Peak Power (dBm)	Antenna Gain (dBi)	EIRP (dBm/10MHz)	Limit (dBm/10MHz)	Margin (dBm)
QPSK	5	55265	3552.5	18.53	2.9	21.43	23	1.57
		55740	3600	19.08	2.9	21.98	23	1.02
		56215	3647.5	18.44	2.9	21.34	23	1.66
	10	55290	3555	18.38	2.9	21.28	23	1.72
		55740	3600	19.01	2.9	21.91	23	1.09
		56190	3645	18.48	2.9	21.38	23	1.62
	15	55315	3557.5	18.36	2.9	19.98	23	3.02
		55740	3600	19.1	2.9	20.72	23	2.28
		56165	3642.5	18.59	2.9	20.21	23	2.79
	20	55340	3560	18.34	2.9	18.72	23	4.28
		55740	3600	18.81	2.9	19.19	23	3.81
		56140	3640	18.72	2.9	19.10	23	3.90
16QAM	5	55265	3552.5	17.46	2.9	20.36	23	2.64
		55740	3600	18.1	2.9	21.0	23	2
		56215	3647.5	17.62	2.9	20.52	23	2.48
	10	55290	3555	17.34	2.9	20.24	23	2.76
		55740	3600	17.96	2.9	20.86	23	2.14
		56190	3645	17.62	2.9	20.52	23	2.48
	15	55315	3557.5	17.55	2.9	19.16	23	3.84
		55740	3600	18.02	2.9	19.63	23	3.37
		56165	3642.5	17.69	2.9	19.3	23	3.7
	20	55340	3560	17.62	2.9	17.99	23	5.01
		55740	3600	17.81	2.9	18.18	23	4.82
		56140	3640	17.84	2.9	18.21	23	4.79
64QAM	5	55265	3552.5	16.52	2.9	19.42	23	3.58
		55740	3600	17.24	2.9	20.14	23	2.86
		56215	3647.5	16.64	2.9	19.54	23	3.46
	10	55290	3555	16.5	2.9	19.4	23	3.6
		55740	3600	17.16	2.9	20.06	23	2.94
		56190	3645	16.55	2.9	19.45	23	3.55
	15	55315	3557.5	16.51	2.9	18.13	23	4.87
		55740	3600	17.15	2.9	18.77	23	4.23
		56165	3642.5	16.73	2.9	18.35	23	4.65
	20	55340	3560	16.6	2.9	16.97	23	6.03
		55740	3600	16.96	2.9	17.33	23	5.67
		56140	3640	16.86	2.9	17.23	23	5.77



LTE Band 48 (3650 – 3700 MHz) EIRP according to FCC Part 90 / RSS-197									
Modulation	Bandwidth (MHz)	RB Size/Offset	Channels	Frequency (MHz)	Tx Average Power (dBm)	Antenna Gain (dBi)	EIRP (dBm)	Limit (dBm)	Margin (dBm)
QPSK	5	1 / 0	56265	3652.5	19.63	2.9	22.53	30	7.47
		1 / 0	56490	3675	19.88	2.9	22.78	30	7.22
		1 / 0	56715	3697.5	19.7	2.9	22.6	30	7.4
	10	1 / 0	56290	3655	19.66	2.9	22.56	30	7.44
		1 / 0	56490	3675	20.0	2.9	22.9	30	7.1
		1 / 0	56690	3695	19.89	2.9	22.79	30	7.21
	15	1 / 0	56315	3675.5	19.73	2.9	22.63	30	7.37
		1 / 0	56490	3675	19.96	2.9	22.86	30	7.14
		1 / 0	56665	3692.5	19.81	2.9	22.71	30	7.29
	20	1 / 0	56340	3660	19.81	2.9	22.71	30	7.29
		1 / 0	56490	3675	20.03	2.9	22.93	30	7.07
		1 / 0	56640	3690	20.07	2.9	22.97	30	7.03
16QAM	5	1 / 0	56265	3652.5	18.94	2.9	21.84	30	8.16
		1 / 0	56490	3675	19.17	2.9	22.07	30	7.93
		1 / 0	56715	3697.5	19.02	2.9	21.92	30	8.08
		1 / 0	56290	3655	18.92	2.9	21.82	30	8.18
	10	1 / 0	56490	3675	19.15	2.9	22.05	30	7.95
		1 / 0	56690	3695	18.79	2.9	21.69	30	8.31
		1 / 0	56315	3675.5	18.84	2.9	21.74	30	8.26
	15	1 / 0	56490	3675	19.11	2.9	22.01	30	7.99
		1 / 0	56665	3692.5	18.99	2.9	21.89	30	8.11
		1 / 0	56340	3660	18.98	2.9	21.88	30	8.12
	20	1 / 0	56490	3675	19.27	2.9	22.17	30	7.83
		1 / 0	56640	3690	19.17	2.9	21.84	30	8.16
1 / 0		56265	3652.5	17.94	2.9	20.84	30	9.16	
64QAM	5	1 / 0	56490	3675	18.18	2.9	21.08	30	8.92
		1 / 0	56715	3697.5	18.07	2.9	20.97	30	9.03
		1 / 0	56290	3655	17.91	2.9	20.81	30	9.19
	10	1 / 0	56490	3675	18.13	2.9	21.03	30	8.97
		1 / 0	56690	3695	18.25	2.9	21.15	30	8.85
		1 / 0	56315	3675.5	18.08	2.9	20.98	30	9.02
	15	1 / 0	56490	3675	18.07	2.9	20.97	30	9.03
		1 / 0	56665	3692.5	18.07	2.9	20.97	30	9.03
		1 / 0	56340	3660	18.05	2.9	20.95	30	9.05
	20	1 / 0	56490	3675	18.3	2.9	21.2	30	8.8
		1 / 0	56640	3690	18.19	2.9	21.09	30	8.91



LTE Band 48 (3650 – 3700 MHz) EIRP Density according to FCC Part 90 / RSS-197								
Modulation	Bandwidth (MHz)	Channels	Frequency (MHz)	Peak Power Density (dBm / 1 MHz)	Antenna Gain (dBi)	EIRP Density (dBm / 1 MHz)	Limit (dBm)	Margin (dBm)
QPSK	5	56265	3652.5	11.29	2.9	14.19	16.02	1.83
		56490	3675	11.2	2.9	14.1	16.02	1.92
		56715	3697.5	11.79	2.9	14.69	16.02	1.33
	10	56290	3655	8.79	2.9	11.69	16.02	4.33
		56490	3675	8.3	2.9	11.2	16.02	4.82
		56690	3695	8.97	2.9	11.87	16.02	4.15
	15	56315	3675.5	6.37	2.9	9.27	16.02	6.75
		56490	3675	6.11	2.9	9.01	16.02	7.01
		56665	3692.5	6.47	2.9	9.37	16.02	6.65
	20	56340	3660	6.77	2.9	9.67	16.02	6.35
		56490	3675	6.5	2.9	9.4	16.02	6.62
		56640	3690	6.48	2.9	9.38	16.02	6.64
16QAM	5	56265	3652.5	10.36	2.9	13.26	16.02	2.76
		56490	3675	10.13	2.9	13.03	16.02	2.99
		56715	3697.5	10.75	2.9	13.65	16.02	2.37
	10	56290	3655	7.52	2.9	10.42	16.02	5.6
		56490	3675	7.81	2.9	10.71	16.02	5.31
		56690	3695	7.9	2.9	10.8	16.02	5.22
	15	56315	3675.5	5.61	2.9	8.51	16.02	7.51
		56490	3675	5.3	2.9	8.2	16.02	7.82
		56665	3692.5	5.71	2.9	8.61	16.02	7.41
	20	56340	3660	5.82	2.9	8.72	16.02	7.3
		56490	3675	5.83	2.9	8.73	16.02	7.29
		56640	3690	5.89	2.9	8.79	16.02	7.23
64QAM	5	56265	3652.5	9.15	2.9	12.05	16.02	3.97
		56490	3675	9.68	2.9	12.58	16.02	3.44
		56715	3697.5	9.22	2.9	12.12	16.02	3.9
	10	56290	3655	6.82	2.9	9.72	16.02	6.3
		56490	3675	6.13	2.9	9.03	16.02	6.99
		56690	3695	5.13	2.9	8.03	16.02	7.99
	15	56315	3675.5	4.74	2.9	7.64	16.02	8.38
		56490	3675	4.16	2.9	7.06	16.02	8.96
		56665	3692.5	4.77	2.9	7.67	16.02	8.35
	20	56340	3660	4.66	2.9	7.56	16.02	8.46
		56490	3675	4.74	2.9	7.64	16.02	8.38
		56640	3690	4.75	2.9	7.65	16.02	8.37





### 2.2.9 Sample Test Measurement Screen

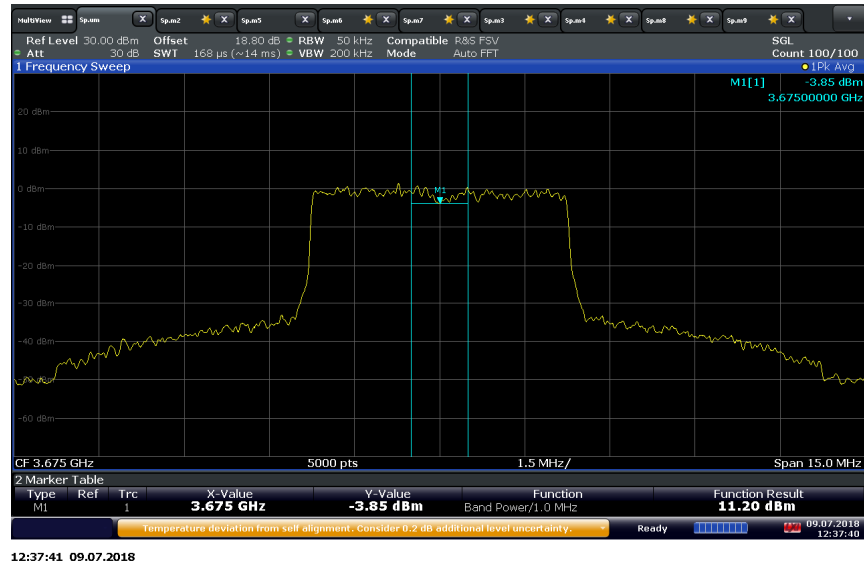

LTE Band 48 (3650 – 3700 MHz) 5 MHz Bandwidth Middle Channel 3675 MHz QPSK Power Spectral Density



## **2.3 OCCUPIED BANDWIDTH**

### **2.3.1 Specification Reference**

FCC 47 CFR Part 2, Clause 2.1049  
FCC 47 CFR Part 96, Clause 96.41 (e)(3)  
FCC 47 CFR Part 90, Clause 90.1323 (a)  
RSS-GEN 6.7

### **2.3.2 Standard Applicable**

The transmitted signal bandwidth shall be reported as the 99% emission bandwidth, that is the frequency bandwidth such that, below its lower and above its upper frequency limits, the mean powers radiated are each equal to 0.5 percent of the total mean power radiated by a given emission.

26dB Bandwidth is defined as the width of the signal between two points, one below the carrier center frequency and one above the carrier center frequency, outside of which all emissions are attenuated by at least 26 dB below the transmitter power.

Using the occupied bandwidth measurement function in the spectrum analyzer, the 99% occupied bandwidth was measured.

In addition, the 26dB bandwidth was measured in accordance with FCC KDB 971168 D01 v03r01 Clause 4.1 using the ndB measurement function in the spectrum analyzer.

### **2.3.3 Equipment Under Test and Modification State**

Serial No: AZ280418A00132 / Test Configuration A

### **2.3.4 Date of Test/Initial of test personnel who performed the test**

June 25 and 30, 2018 / XYZ

### **2.3.5 Test Equipment Used**

The major items of test equipment used for the above tests are identified in Section 3.1.

### **2.3.6 Environmental Conditions/ Test Location**

Test performed at TÜV SÜD America Inc. Rancho Bernardo facility

Ambient Temperature	25.3 - 27.1°C
Relative Humidity	46.2 - 49.0%
ATM Pressure	98.8 - 98.9 kPa



**2.3.7 Additional Observations**

- This is a conducted test. Both 26dB bandwidth and 99% bandwidth presented.
- Using the occupied bandwidth measurement function in the spectrum analyzer, the 99% occupied bandwidth was measured.
- The 26dB bandwidth was measured in accordance with ANSI C63.26 clause 5.4.3 using the ndB measurement function in the spectrum analyzer.
- The transmitter shall be operated at its maximum carrier power measured under normal test conditions.

**2.3.8 Test Results**

LTE Band 48 (3550 – 3650 MHz)					
Modulation	Bandwidth (MHz)	Channel	Frequency (MHz)	99% OBW (MHz)	26dB BW (MHz)
QPSK	5	55740	3600	4.49	5.01
	10			8.96	9.72
	15			13.44	14.59
	20			17.88	19.28
16QAM	5	55740	3600	4.47	4.88
	10			8.96	9.6
	15			13.46	14.65
	20			17.91	19.19
64QAM	5	55740	3600	4.47	5.08
	10			8.96	9.68
	15			13.43	14.59
	20			17.9	19.28

LTE Band 48 (3650 – 3700 MHz)					
Modulation	Bandwidth (MHz)	Channel	Frequency (MHz)	99% OBW (MHz)	26dB BW (MHz)
QPSK	5	56490	3675	4.48	5.01
	10			8.96	9.81
	15			13.44	14.65
	20			17.95	19.28
16QAM	5	56490	3675	4.48	4.91
	10			8.97	9.68
	15			13.46	14.65
	20			17.89	19.28
64QAM	5	56490	3675	4.49	5.08
	10			8.97	9.81
	15			13.43	14.46
	20			17.91	19.28



2.3.9 Example Test Plots

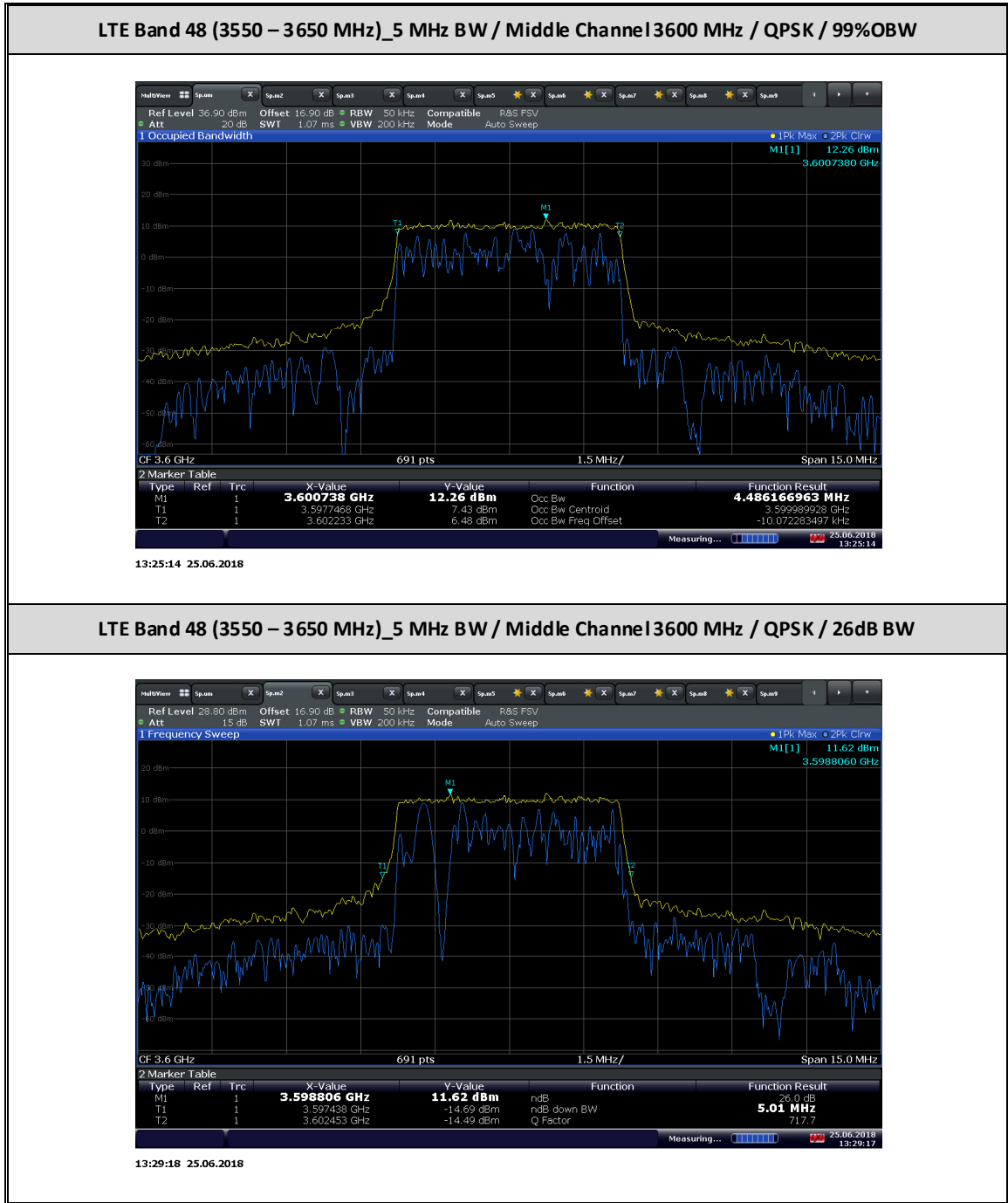



**LTE Band 48 (3650 – 3700 MHz)\_5 MHz BW / Middle Channel 3675 MHz / QPSK / 99%OBW**



14:21:02 25.06.2018

**LTE Band 48 (3650 – 3700 MHz)\_5 MHz BW / Middle Channel 3675 MHz / QPSK / 26dB BW**



14:21:40 25.06.2018



## **2.4 BAND EDGE**

### **2.4.1 Specification Reference**

FCC 47 CFR Part 2, Clause 2.1051  
FCC 47 CFR Part 96, Clause 96.41(e)(1)(3)  
FCC 47 CFR Part 90, Clause 90.1323(a)  
RSS-192, Clause 5.5  
RSS-197, Clause 5.7

### **2.4.2 Standard Applicable**

FCC 47 CFR Part 96.41:

(e) 3.5 GHz Emissions and Interference Limits - (1) General protection levels. Except as otherwise specified in paragraph (e)(2) of this section, for channel and frequency assignments made by the SAS to CBSDs, the conducted power of any emission outside the fundamental emission (whether in or outside of the authorized band) shall not exceed -13 dBm/MHz within 0-10 megahertz above the upper SAS-assigned channel edge and within 0-10 megahertz below the lower SAS-assigned channel edge. At all frequencies greater than 10 megahertz above the upper SAS assigned channel edge and less than 10 MHz below the lower SAS assigned channel edge, the conducted power of any emission shall not exceed -25 dBm/MHz. The upper and lower SAS assigned channel edges are the upper and lower limits of any channel assigned to a CBSD by an SAS, or in the case of multiple contiguous channels, the upper and lower limits of the combined contiguous channels.

RSS-192, Clause 5.5:

The unwanted emissions shall comply with the following limits:

(i) In any 30 kHz bandwidth, the unwanted emission spectral density that is relative to the inband spectral density shall be attenuated at least to the limits shown in Table 1 according to the equipment modulation. The attenuation shall be linearly interpolated between the turning point attenuation limits.



**Table 1: Attenuation of Unwanted Emission Limits for Various Access Schemes**

**Orthogonal Frequency Division Multiple Access (OFDMA)**

Turning Point (F/ChS)	0	0.21	0.56	1.5	2
EMO = 2	8 dB	25 dB	27 dB	50 dB	50 dB
EMO = 4	8 dB	27 dB	32 dB	50 dB	50 dB
EMO = 6	8 dB	32 dB	38 dB	50 dB	50 dB

**Code Division Multiple Access (CDMA)**

Turning Point (F/ChS)	0	0.3	0.5	1	2
EMO Not applicable	0 dB	25 dB	25 dB	45 dB	45 dB

**Frequency Division Multiple Access (FDMA)**

Turning Point (F/ChS)	0	0.1	0.35	1	2
EMO = 2	23 dB	25 dB	25 dB	45 dB	45 dB
EMO = 3	27 dB	29 dB	29 dB	45 dB	45 dB
EMO = 4 or 6	31 dB	33 dB	33 dB	45 dB	45 dB

**Time Division Multiple Access (TDMA)**

Turning Point (F/ChS)	0	0.3	0.56	1.5	2
EMO = 2	Not applicable	25 dB	25 dB	45 dB	45 dB
EMO = 4	Not applicable	32 dB	37 dB	45 dB	45 dB
EMO = 6	13 dB	34 dB	42 dB	45 dB	45 dB

The offset frequency from the block edge, F, at each turning point can be determined as follows:  
 $F = ChS * (\text{Turning Point})$ ; where ChS is defined as the frequency spacing between the centre frequencies of two adjacent channels.

EMO is the equivalent modulation order of the transmitter, defined as  $\log_2(\text{number of discrete states which may be assigned to each symbol})$ . For example, for quadrature amplitude modulation (QAM):

- 2 = 4 QAM
- 4 = 16 QAM
- 6 = 64 QAM

(ii) In any 1.0 MHz band that is removed from the assigned centre frequency by more than  $\pm 250\%$  of the necessary bandwidth, the power of any emission must be attenuated below  $P_{\text{mean}}$  by at least  $43 + 10 \log_{10}(P_{\text{mean}})$  dB, or 70 dB, whichever is less stringent.  $P_{\text{mean}}$  is the mean output power of the transmitter in watts.



FCC 47 CFR Part 90.1323:

(a) The power of any emission outside a licensee's frequency band(s) of operation shall be attenuated below the transmitter power (P) within the licensed band(s) of operation, measured in watts, by at least  $43 + 10 \log(P)$  dB. Compliance with this provision is based on the use of measurement instrumentation employing a resolution bandwidth of 1 MHz or less, but at least one percent of the emission bandwidth of the fundamental emission of the transmitter, provided the measured energy is integrated over a 1 MHz bandwidth.

RSS-197, Clause 5.7:

The unwanted emissions shall be measured at the frequencies of the highest and lowest channel of all bandwidths and types of modulation that the equipment can operate with a resolution bandwidth of 1 MHz or less, but at least 1% of the occupied bandwidth of the transmitter, provided that the measured power is integrated over a 1 MHz bandwidth.

The power of any emissions outside the frequency band 3650-3700 MHz shall be attenuated below the channel transmitter power P (dBW) by  $43 + 10 \log(p)$ , where p is measured in watts.

#### **2.4.3 Equipment Under Test and Modification State**

Serial No: AZ280418A00132 / Test Configuration A

#### **2.4.4 Date of Test/Initial of test personnel who performed the test**

July 01 and 10, 2018 /XYZ

#### **2.4.5 Test Equipment Used**

The major items of test equipment used for the above tests are identified in Section 3.1.

#### **2.4.6 Environmental Conditions/ Test Location**

Test performed at TÜV SÜD America Inc. Rancho Bernardo facility

Ambient Temperature	25.2 - 26.8 °C
Relative Humidity	44.4 - 49.3 %
ATM Pressure	99.0 - 99.1 kPa

#### **2.4.7 Additional Observations**

- This is a conducted test.
- The path loss were measured and entered as a level offset.
- All channel bandwidth, RB Size and offset and modulation are verified. Only the worst case modulation (QPSK) for band edge verification presented in this test report.

#### **2.4.8 Test Results**

See attached test plots.



LTE Band 48 (3550 – 3650 MHz)\_5 MHz BW / QPSK / Low Channel 3552.5 MHz 1 RB 0 offset  
Low Band Edge

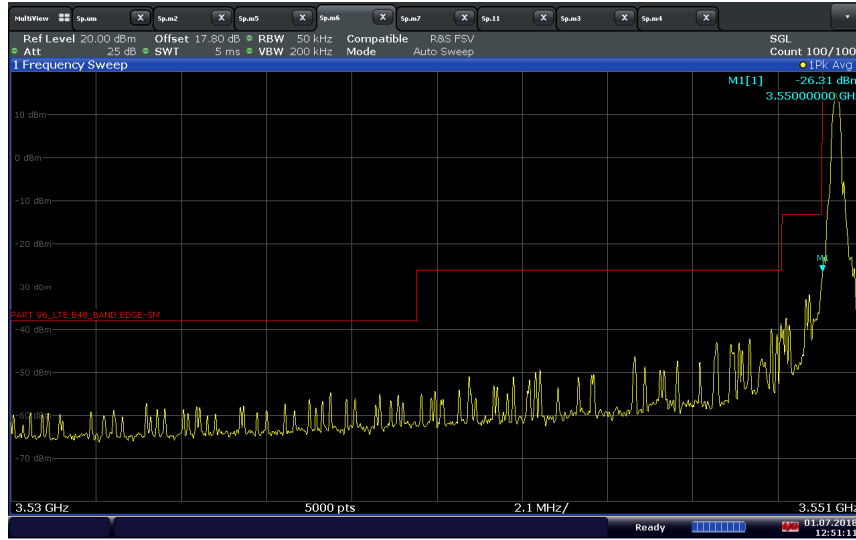

12:51:12 01.07.2018

LTE Band 48 (3550 – 3650 MHz)\_5 MHz BW / QPSK / Low Channel 3552.5 MHz Full RB  
Low Band Edge

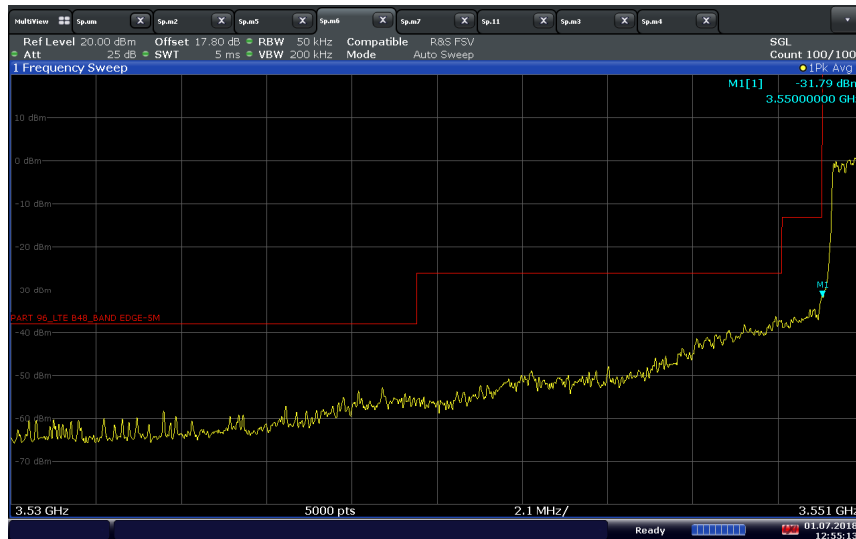

12:55:13 01.07.2018



America

**LTE Band 48 (3550 – 3650 MHz)\_5 MHz BW / QPSK / High Channel 3647.5 MHz 1 RB 24 offset  
High Band Edge**

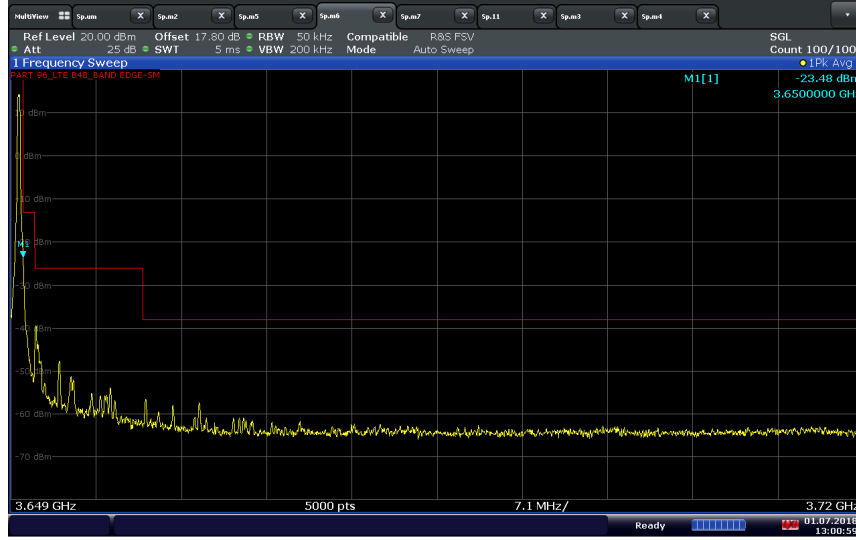

13:00:59 01.07.2018

**LTE Band 48 (3550 – 3650 MHz)\_5 MHz BW / QPSK / High Channel 3647.5 MHz Full RB  
High Band Edge**

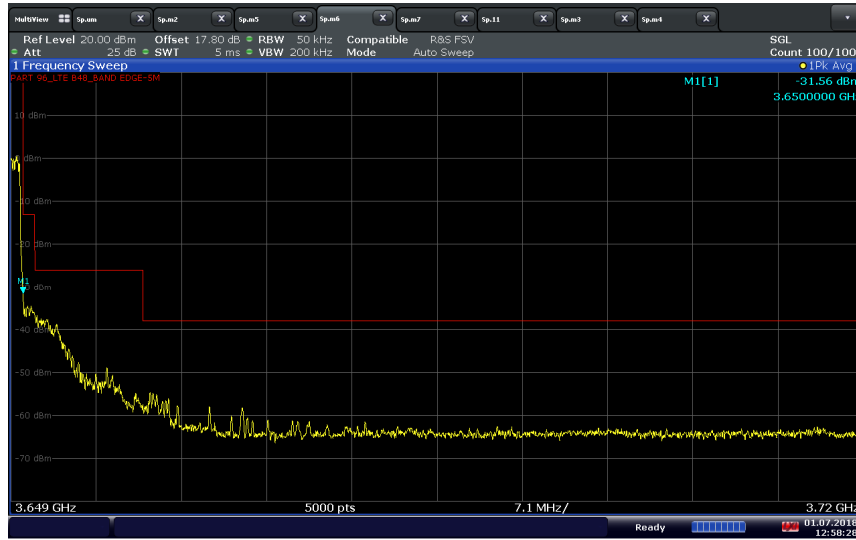

12:58:29 01.07.2018



**LTE Band 48 (3550 – 3650 MHz)\_10 MHz BW / QPSK / Low Channel 3555 MHz 1 RB 0 offset**  
**Low Band Edge**

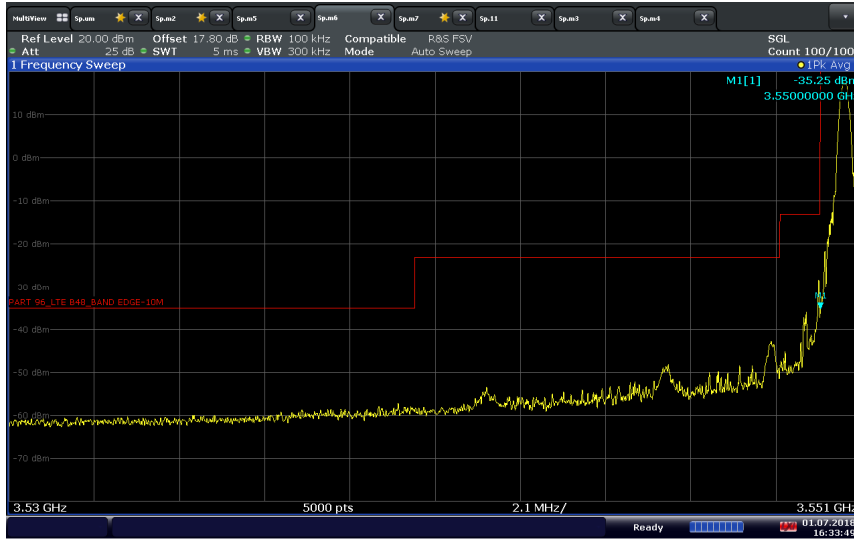

16:33:50 01.07.2018

**LTE Band 48 (3550 – 3650 MHz)\_10 MHz BW / QPSK / Low Channel 3555 MHz Full RB**  
**Low Band Edge**



16:34:19 01.07.2018



America

**LTE Band 48 (3550 – 3650 MHz)\_10 MHz BW / QPSK / High Channel 3645 MHz 1 RB 49 offset  
High Band Edge**

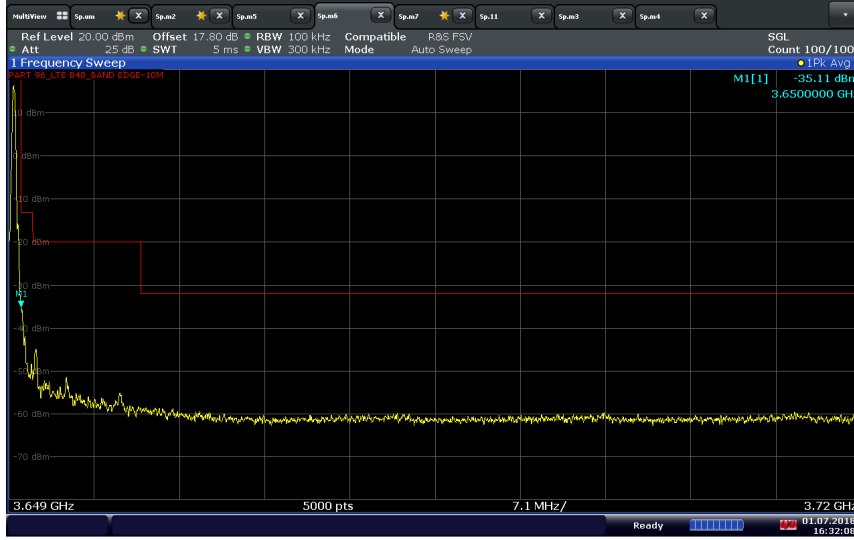

16:32:09 01.07.2018

**LTE Band 48 (3550 – 3650 MHz)\_10 MHz BW / QPSK / High Channel 3645 MHz Full RB  
High Band Edge**

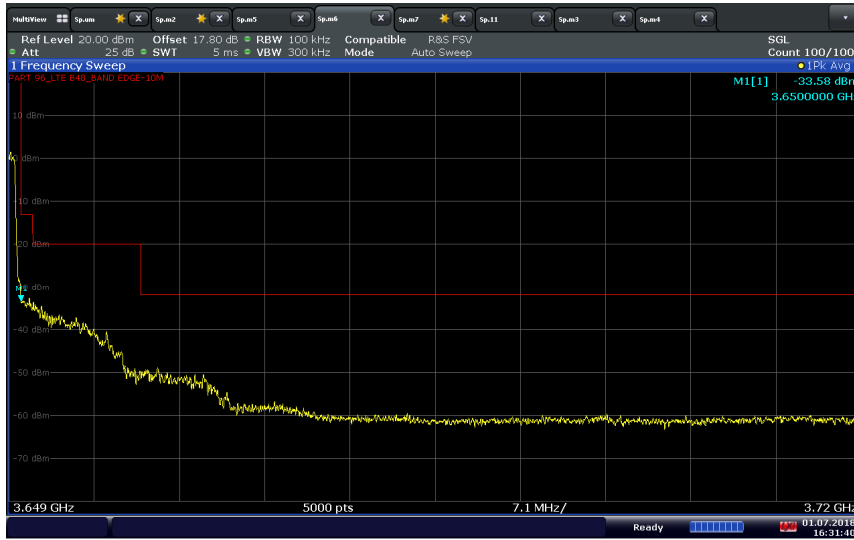

16:31:40 01.07.2018



LTE Band 48 (3550 – 3650 MHz)\_15 MHz BW / QPSK / Low Channel 3557.5 MHz 1 RB 0 offset  
Low Band Edge

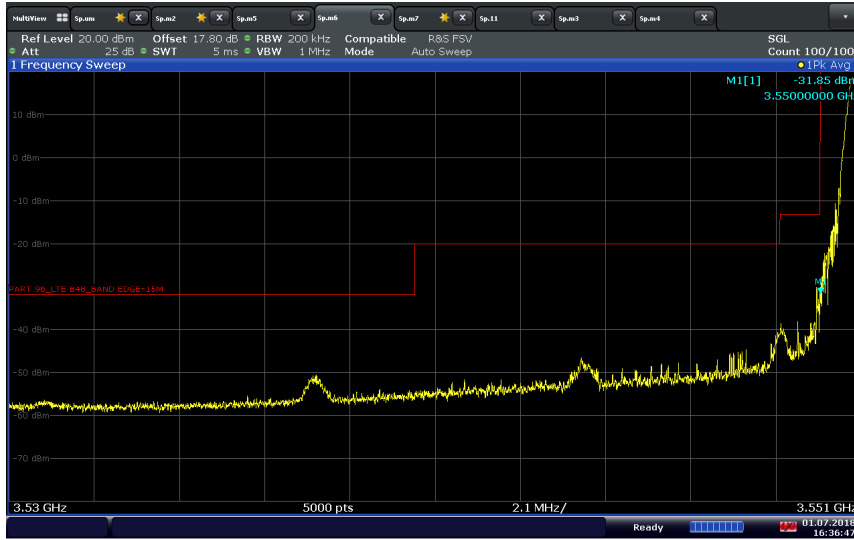

16:36:48 01.07.2018

LTE Band 48 (3550 – 3650 MHz)\_15 MHz BW / QPSK / Low Channel 3557.5 MHz Full RB  
Low Band Edge

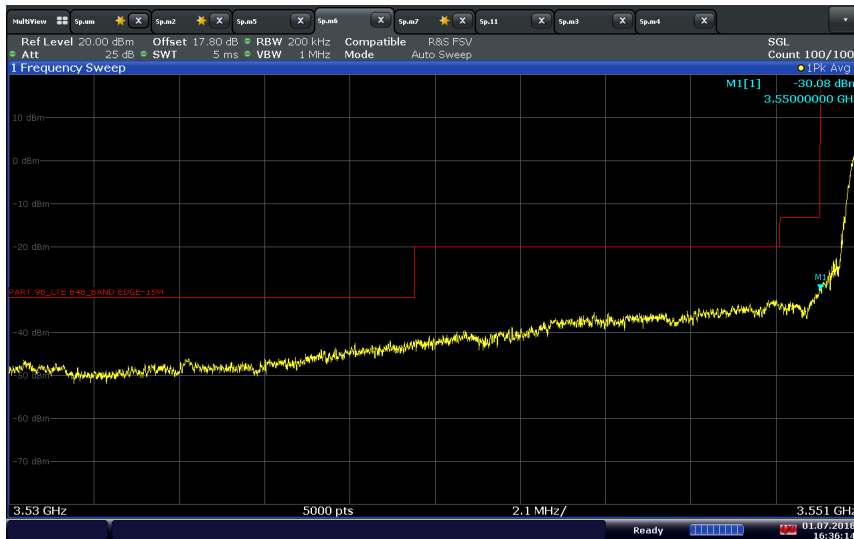

16:36:15 01.07.2018



America

LTE Band 48 (3550 – 3650 MHz)\_15 MHz BW / QPSK / High Channel 3642.5 MHz 1 RB 74 offset  
High Band Edge

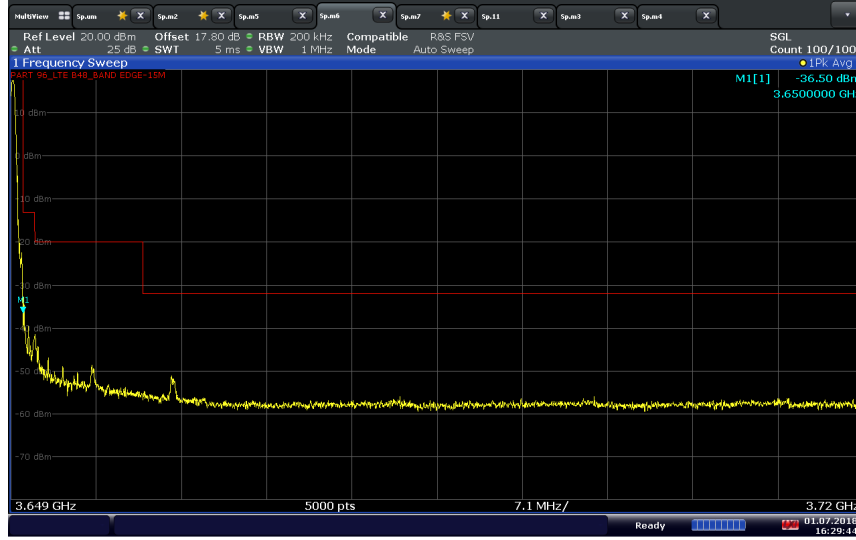

16:29:44 01.07.2018

LTE Band 48 (3550 – 3650 MHz)\_15 MHz BW / QPSK / High Channel 3642.5 MHz Full RB  
High Band Edge



16:30:19 01.07.2018



**LTE Band 48 (3550 – 3650 MHz)\_20 MHz BW / QPSK / Low Channel 3560 MHz 1 RB 0 offset**  
**Low Band Edge**

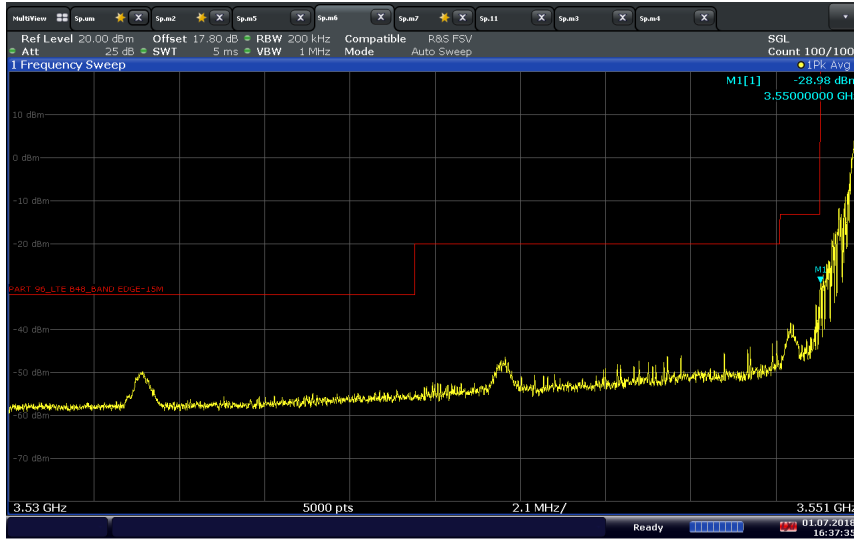

16:37:36 01.07.2018

**LTE Band 48 (3550 – 3650 MHz)\_20 MHz BW / QPSK / Low Channel 3560 MHz Full RB**  
**Low Band Edge**

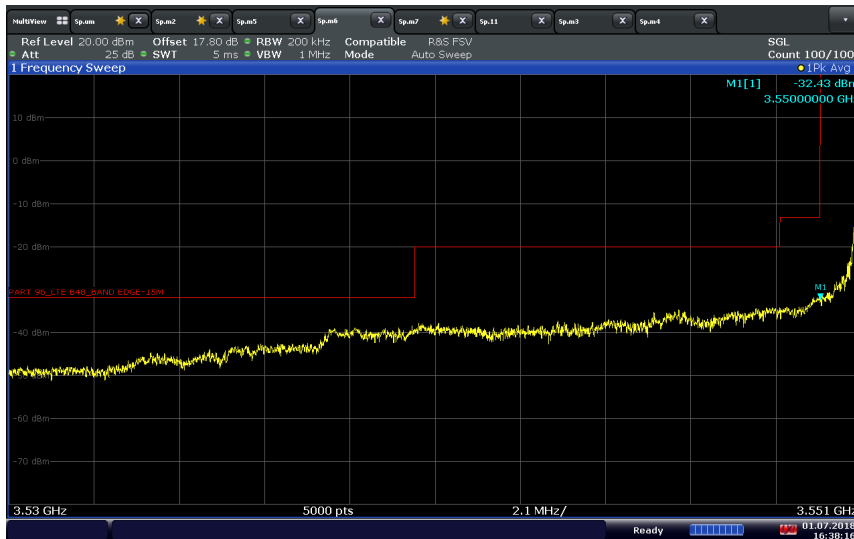

16:38:16 01.07.2018



America

**LTE Band 48 (3550 – 3650 MHz)\_20 MHz BW / QPSK / High Channel 3640 MHz 1 RB 99 offset  
High Band Edge**

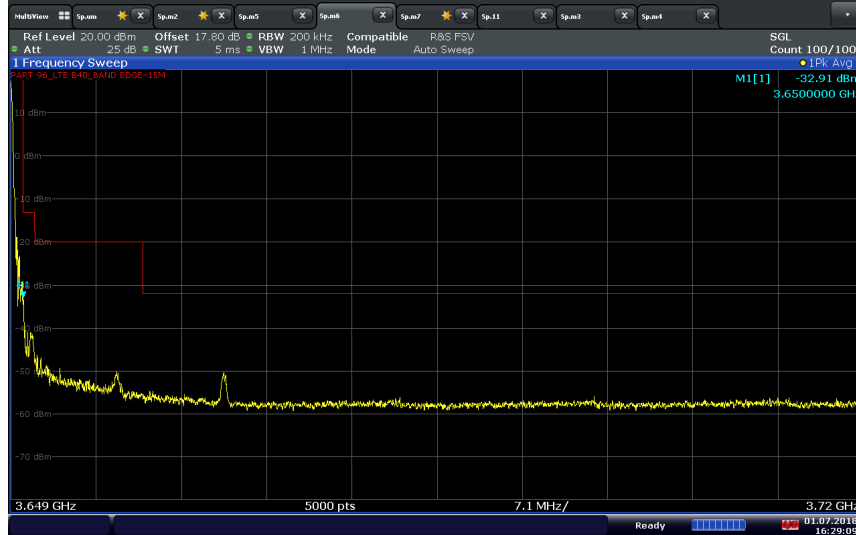

16:29:09 01.07.2018

**LTE Band 48 (3550 – 3650 MHz)\_20 MHz BW / QPSK / High Channel 3640 MHz Full RB  
High Band Edge**

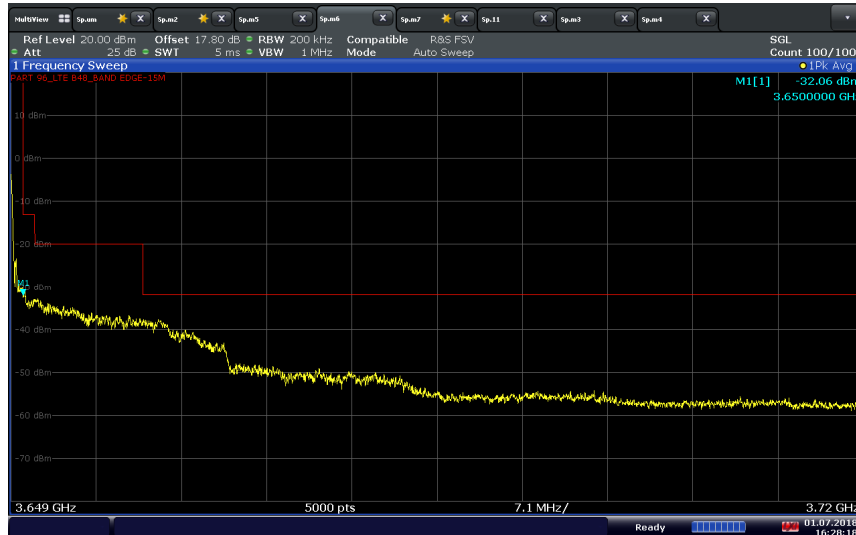

16:28:19 01.07.2018





America

**LTE Band 48 (3650 – 3700 MHz)\_5 MHz BW / QPSK / High Channel 3652.5 MHz 1 RB 0 offset  
Low Band Edge**

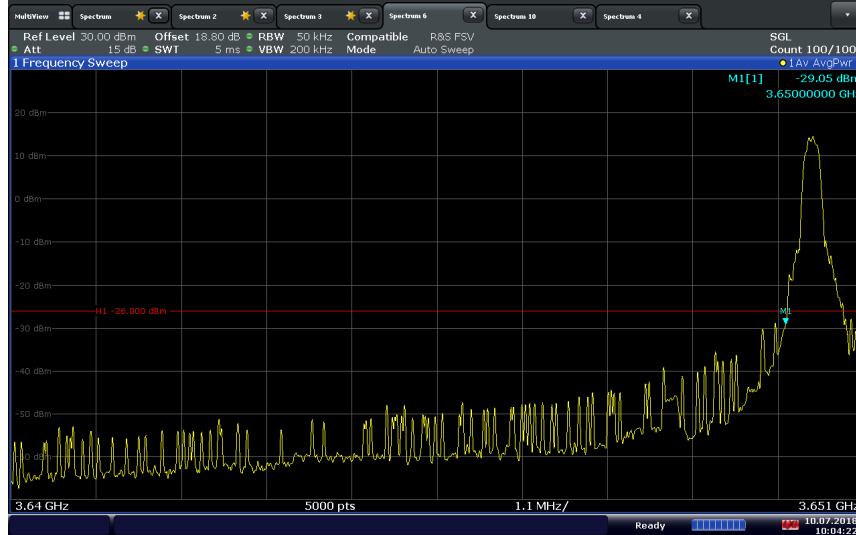

10:04:22 10.07.2018

**LTE Band 48 (3650 – 3700 MHz)\_5 MHz BW / QPSK / Low Channel 3652.5 MHz Full RB  
Low Band Edge**

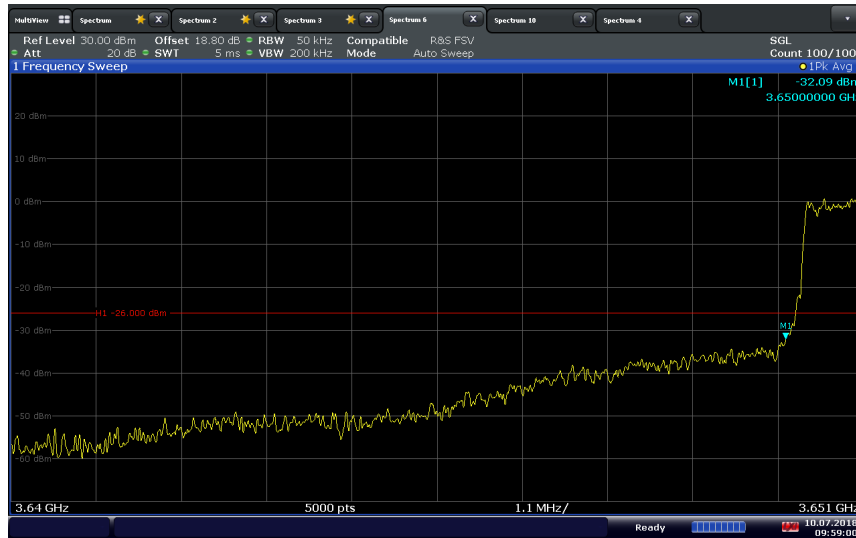

09:59:01 10.07.2018



America

LTE Band 48 (3650 – 3700 MHz)\_5 MHz BW / QPSK / High Channel 3697.5 MHz 1 RB 24 offset  
High Band Edge

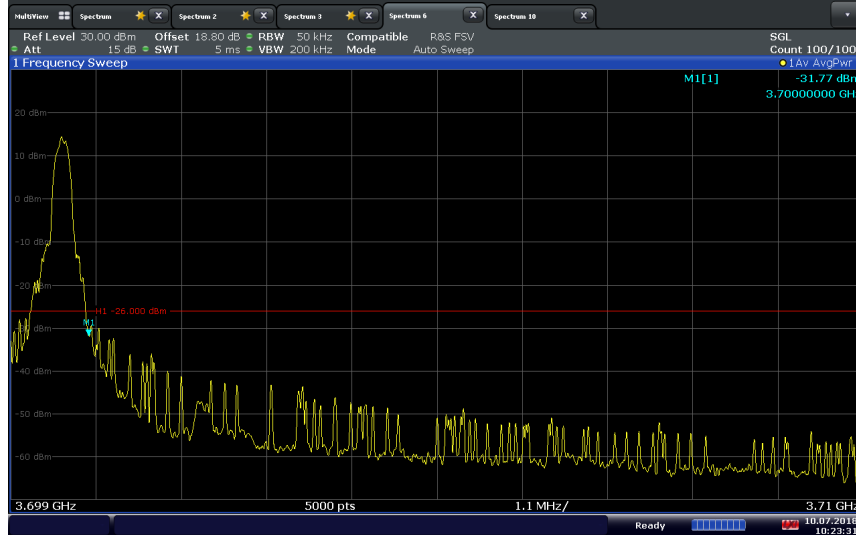

10:23:32 10.07.2018

LTE Band 48 (3650 – 3700 MHz)\_5 MHz BW / QPSK / High Channel 3697.5 MHz Full RB  
High Band Edge

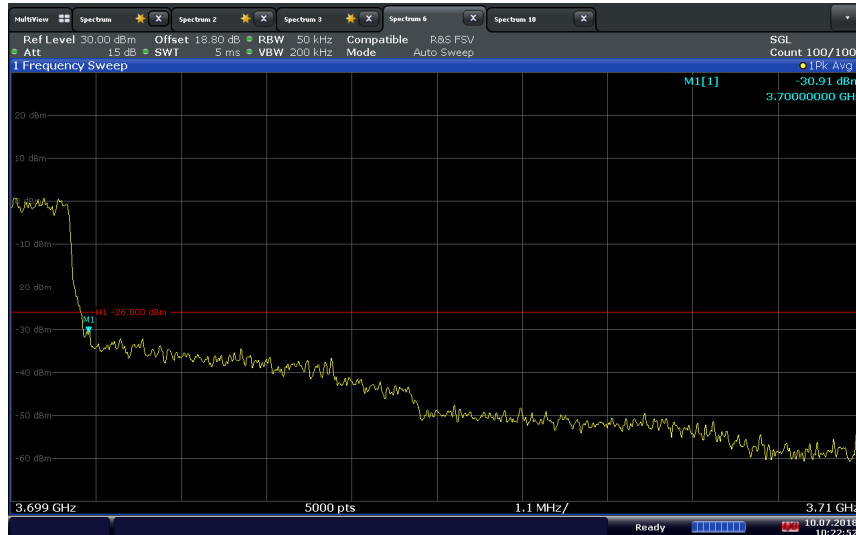

10:22:52 10.07.2018



**LTE Band 48 (3650 – 3700 MHz)\_10 MHz BW / QPSK / Low Channel 3655 MHz 1 RB 0 offset**  
**Low Band Edge**

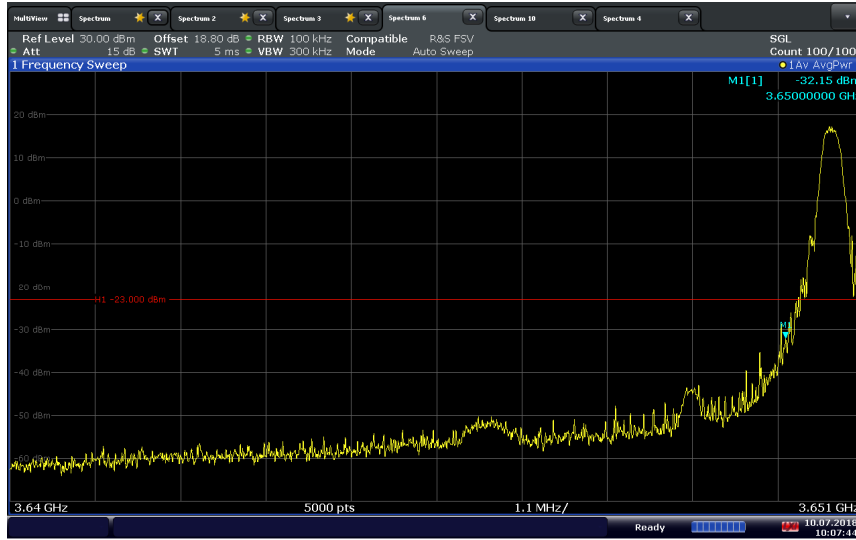

10:07:45 10.07.2018

**LTE Band 48 (3650 – 3700 MHz)\_10 MHz BW / QPSK / Low Channel 3655 MHz Full RB**  
**Low Band Edge**

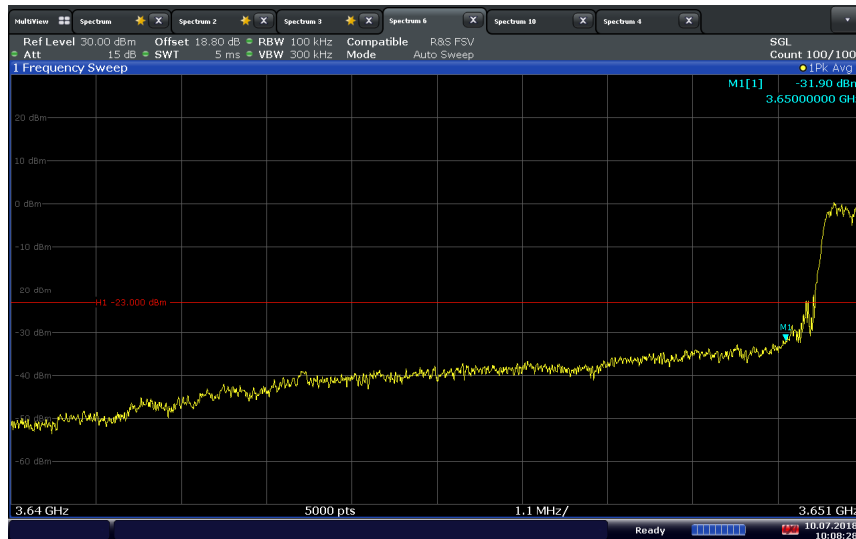

10:08:29 10.07.2018



America

**LTE Band 48 (3650 – 3700 MHz)\_10 MHz BW / QPSK / High Channel 3695 MHz 1 RB 49 offset  
High Band Edge**

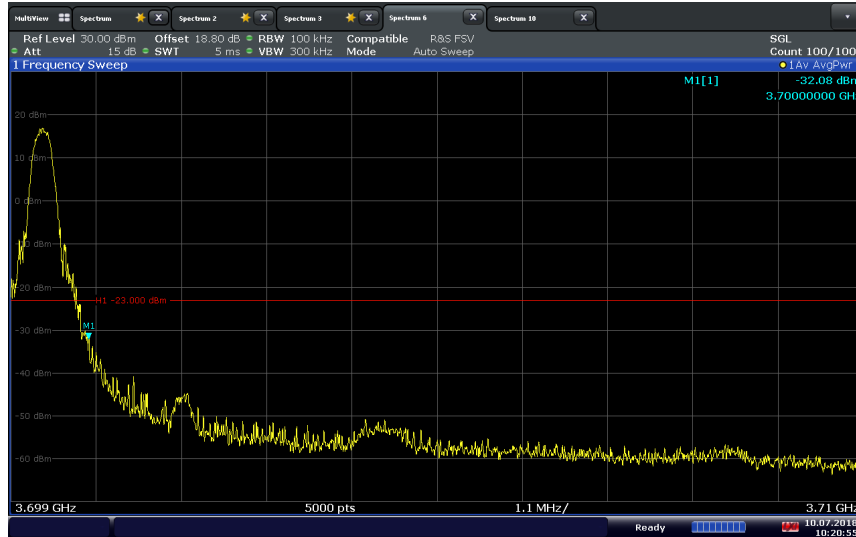

10:20:56 10.07.2018

**LTE Band 48 (3650 – 3700 MHz)\_10 MHz BW / QPSK / High Channel 3695 MHz Full RB  
High Band Edge**

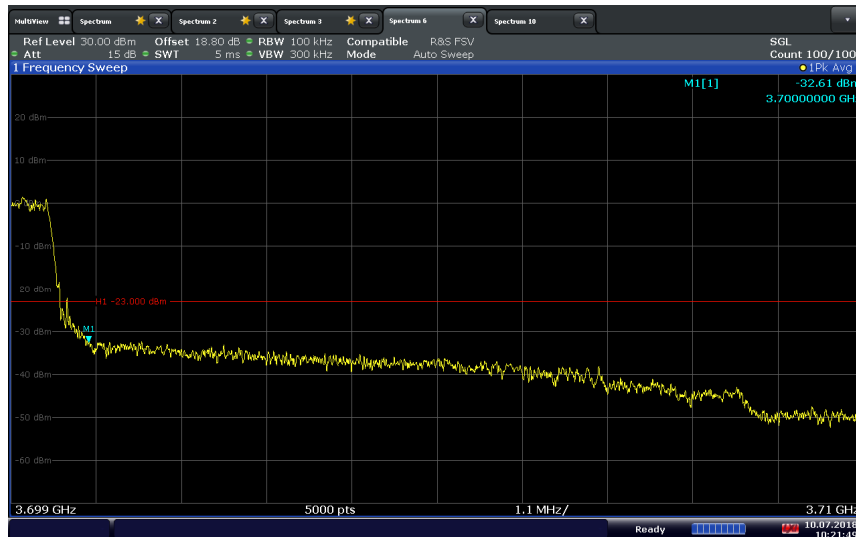

10:21:50 10.07.2018



**LTE Band 48 (3650 – 3700 MHz)\_15 MHz BW / QPSK / Low Channel 3657.5 MHz 1 RB 0 offset**  
**Low Band Edge**

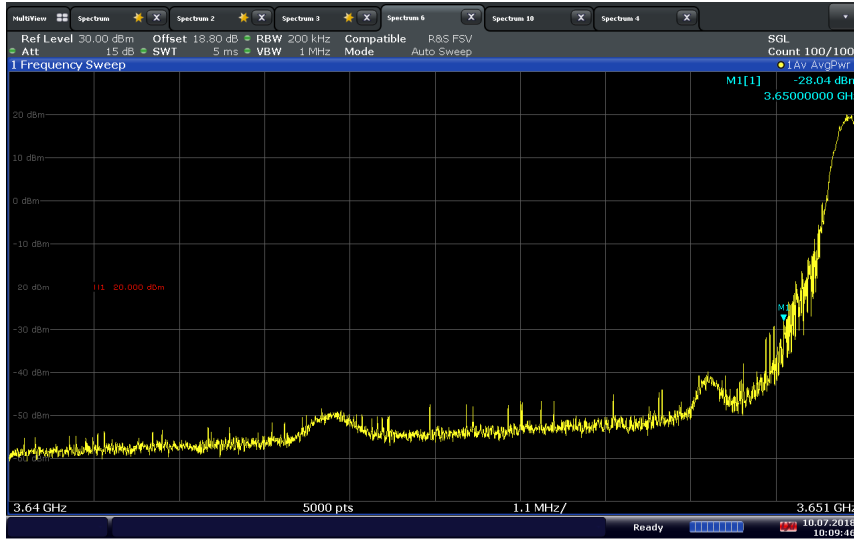

**LTE Band 48 (3650 – 3700 MHz)\_15 MHz BW / QPSK / Low Channel 3657.5 MHz Full RB**  
**Low Band Edge**

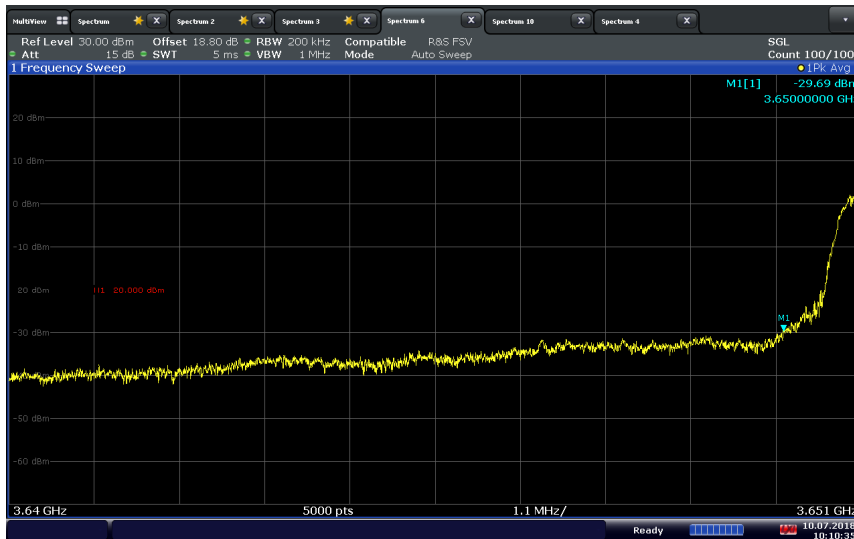



America

LTE Band 48 (3650 – 3700 MHz)\_15 MHz BW / QPSK / High Channel 3692.5 MHz 1 RB 74 offset  
High Band Edge

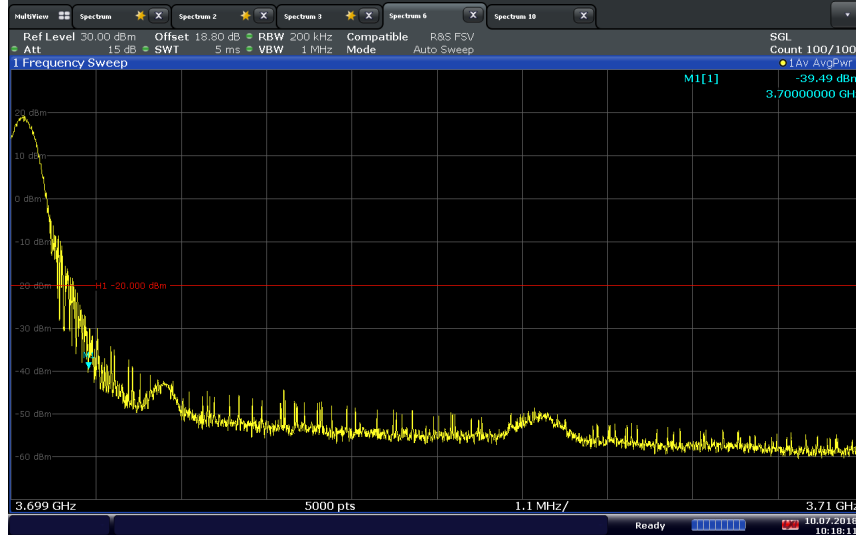

10:18:11 10.07.2018

LTE Band 48 (3650 – 3700 MHz)\_15 MHz BW / QPSK / High Channel 3692.5 MHz Full RB  
High Band Edge

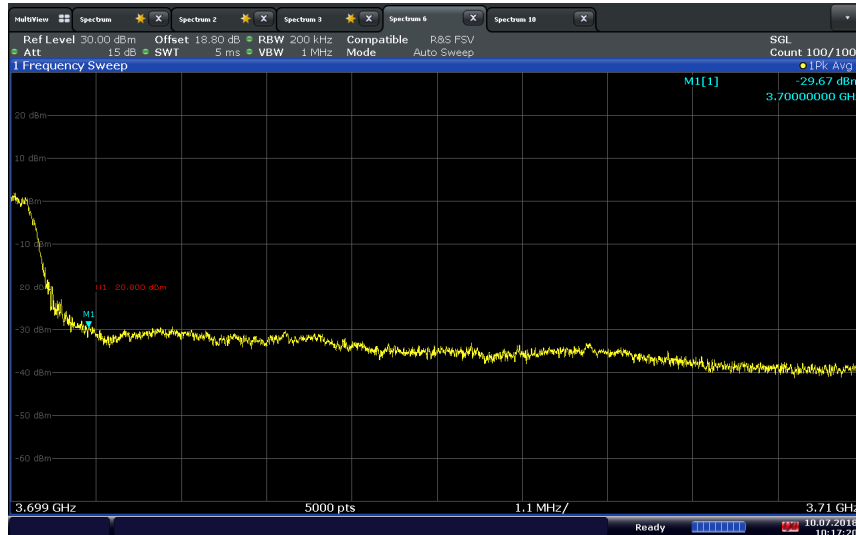

10:17:21 10.07.2018



**LTE Band 48 (3650 – 3700 MHz)\_20 MHz BW / QPSK / Low Channel 3660 MHz 1 RB 0 offset**  
**Low Band Edge**

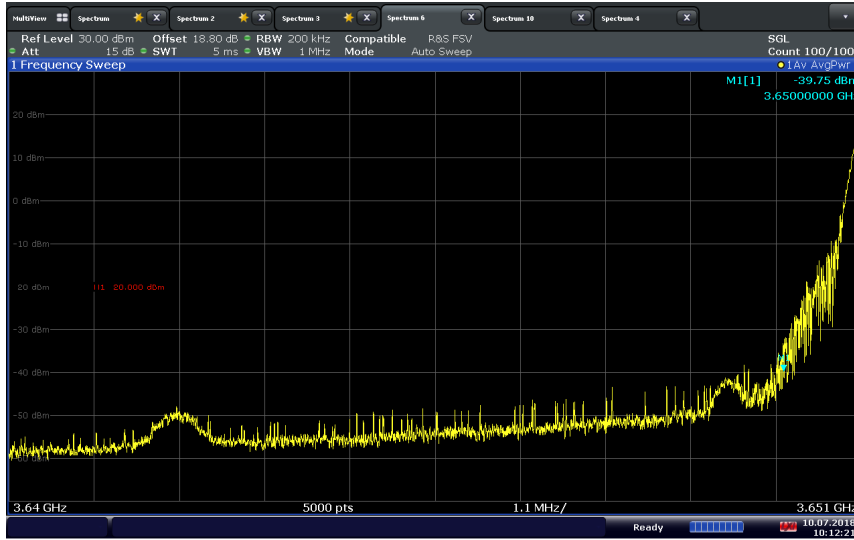

10:12:22 10.07.2018

**LTE Band 48 (3650 – 3700 MHz)\_20 MHz BW / QPSK / Low Channel 3660 MHz Full RB**  
**Low Band Edge**

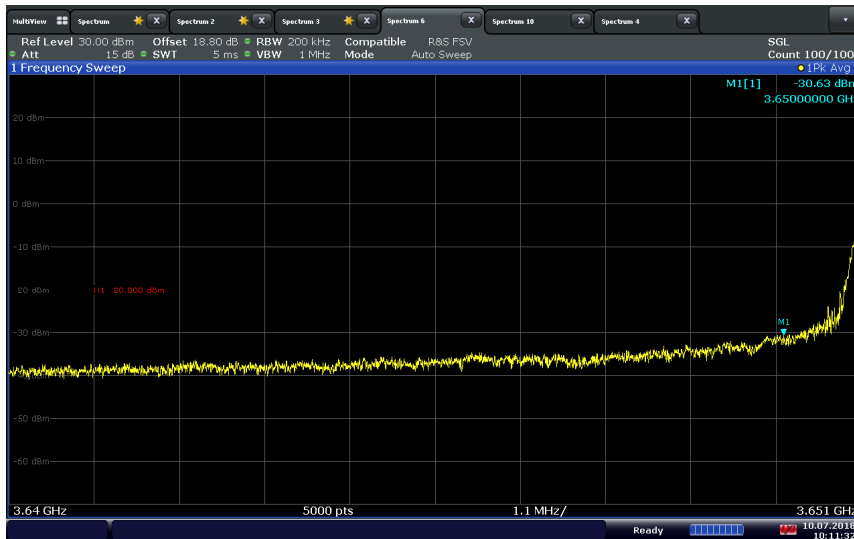

10:11:33 10.07.2018



America

**LTE Band 48 (3650 – 3700 MHz)\_20 MHz BW / QPSK / High Channel 3690 MHz 1 RB 99 offset  
High Band Edge**

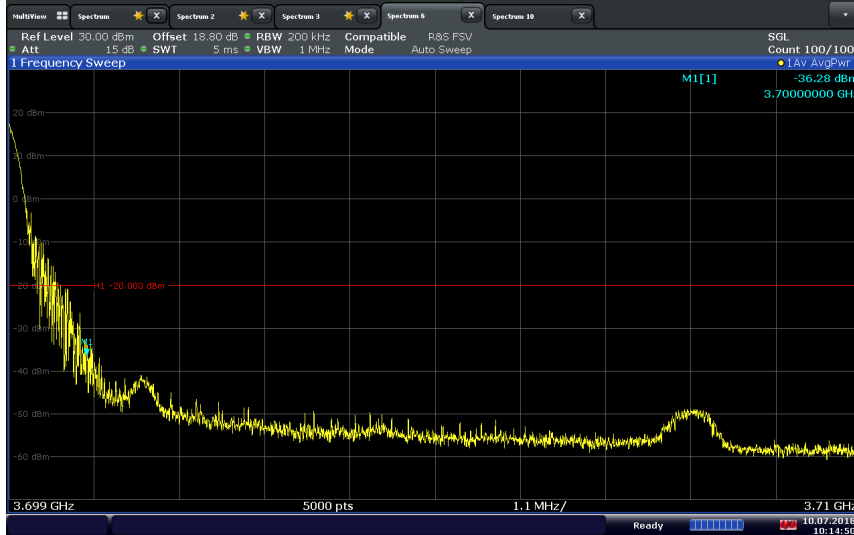

10:14:51 10.07.2018

**LTE Band 48 (3650 – 3700 MHz)\_20 MHz BW / QPSK / High Channel 3690 MHz Full RB  
High Band Edge**

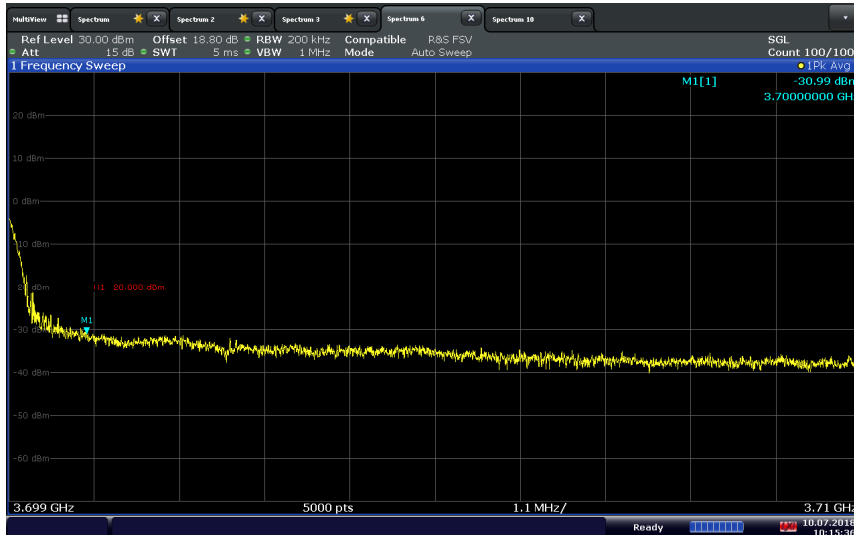

10:15:36 10.07.2018





## **2.5 CONDUCTED SPURIOUS EMISSIONS**

### **2.5.1 Specification Reference**

FCC 47 CFR Part 2, Clause 2.1051  
FCC 47 CFR Part 96, Clause 96.41(e)(1)(2)(3)  
FCC 47 CFR Part 90, Clause 90.1323(a)  
RSS-192, Clause 5.5  
RSS-197, Clause 5.7

### **2.5.2 Standard Applicable**

FCC 47 CFR Part 96.41:

(e) 3.5 GHz Emissions and Interference Limits - (1) General protection levels. Except as otherwise specified in paragraph (e)(2) of this section, for channel and frequency assignments made by the SAS to CBSDs, the conducted power of any emission outside the fundamental emission (whether in or outside of the authorized band) shall not exceed -13 dBm/MHz within 0-10 megahertz above the upper SAS-assigned channel edge and within 0-10 megahertz below the lower SAS-assigned channel edge. At all frequencies greater than 10 megahertz above the upper SAS assigned channel edge and less than 10 MHz below the lower SAS assigned channel edge, the conducted power of any emission shall not exceed -25 dBm/MHz. The upper and lower SAS assigned channel edges are the upper and lower limits of any channel assigned to a CBSD by an SAS, or in the case of multiple contiguous channels, the upper and lower limits of the combined contiguous channels.

(2) Additional protection levels: Notwithstanding paragraph (d)(1) of this section, the conducted power of any emissions below 3530 MHz or above 3720 MHz shall not exceed -40dBm/MHz.

RSS-192, Clause 5.5:

The unwanted emissions shall comply with the following limits:

(i) In any 30 kHz bandwidth, the unwanted emission spectral density that is relative to the inband spectral density shall be attenuated at least to the limits shown in Table 1 according to the equipment modulation. The attenuation shall be linearly interpolated between the turning point attenuation limits.



**Table 1: Attenuation of Unwanted Emission Limits for Various Access Schemes**

**Orthogonal Frequency Division Multiple Access (OFDMA)**

Turning Point (F/ChS)	0	0.21	0.56	1.5	2
EMO = 2	8 dB	25 dB	27 dB	50 dB	50 dB
EMO = 4	8 dB	27 dB	32 dB	50 dB	50 dB
EMO = 6	8 dB	32 dB	38 dB	50 dB	50 dB

**Code Division Multiple Access (CDMA)**

Turning Point (F/ChS)	0	0.3	0.5	1	2
EMO Not applicable	0 dB	25 dB	25 dB	45 dB	45 dB

**Frequency Division Multiple Access (FDMA)**

Turning Point (F/ChS)	0	0.1	0.35	1	2
EMO = 2	23 dB	25 dB	25 dB	45 dB	45 dB
EMO = 3	27 dB	29 dB	29 dB	45 dB	45 dB
EMO = 4 or 6	31 dB	33 dB	33 dB	45 dB	45 dB

**Time Division Multiple Access (TDMA)**

Turning Point (F/ChS)	0	0.3	0.56	1.5	2
EMO = 2	Not applicable	25 dB	25 dB	45 dB	45 dB
EMO = 4	Not applicable	32 dB	37 dB	45 dB	45 dB
EMO = 6	13 dB	34 dB	42 dB	45 dB	45 dB

The offset frequency from the block edge, F, at each turning point can be determined as follows:  
 $F = ChS * (\text{Turning Point})$ ; where ChS is defined as the frequency spacing between the centre frequencies of two adjacent channels.

EMO is the equivalent modulation order of the transmitter, defined as  $\log_2(\text{number of discrete states which may be assigned to each symbol})$ . For example, for quadrature amplitude modulation (QAM):

- 2 = 4 QAM
- 4 = 16 QAM
- 6 = 64 QAM

(ii) In any 1.0 MHz band that is removed from the assigned centre frequency by more than  $\pm 250\%$  of the necessary bandwidth, the power of any emission must be attenuated below  $P_{\text{mean}}$  by at least  $43 + 10 \log_{10}(P_{\text{mean}})$  dB, or 70 dB, whichever is less stringent.  $P_{\text{mean}}$  is the mean output power of the transmitter in watts.



FCC 47 CFR Part 90.1323:

(a) The power of any emission outside a licensee's frequency band(s) of operation shall be attenuated below the transmitter power (P) within the licensed band(s) of operation, measured in watts, by at least  $43 + 10 \log(P)$  dB. Compliance with this provision is based on the use of measurement instrumentation employing a resolution bandwidth of 1 MHz or less, but at least one percent of the emission bandwidth of the fundamental emission of the transmitter, provided the measured energy is integrated over a 1 MHz bandwidth.

RSS-197, Clause 5.7:

The unwanted emissions shall be measured at the frequencies of the highest and lowest channel of all bandwidths and types of modulation that the equipment can operate with a resolution bandwidth of 1 MHz or less, but at least 1% of the occupied bandwidth of the transmitter, provided that the measured power is integrated over a 1 MHz bandwidth.

The power of any emissions outside the frequency band 3650-3700 MHz shall be attenuated below the channel transmitter power P (dBW) by  $43 + 10 \log(p)$ , where p is measured in watts.

### 2.5.3 Equipment Under Test and Modification State

Serial No: AZ280418A00132 / Test Configuration A

### 2.5.4 Date of Test/Initial of test personnel who performed the test

July 01, 09 and 10, 2018 / ZXY

### 2.5.5 Test Equipment Used

The major items of test equipment used for the above tests are identified in Section 3.1.

### 2.5.6 Environmental Conditions/ Test Location

Test performed at TÜV SÜD America Inc. Rancho Bernardo facility

Ambient Temperature	25.2 - 27.8°C
Relative Humidity	39.4 - 49.3 %
ATM Pressure	98.8 - 99.1 kPa

### 2.5.7 Additional Observations

- This is a conducted test.
- The spectrum was searched from 30MHz to the 10<sup>th</sup> harmonic.
- Only noise floor measurements observed above 26.5 GHz.
- Low, Middle and High channels on all channel bandwidth and modulation are verified. Only the worst case channel of each band presented.



2.5.8 Test Results

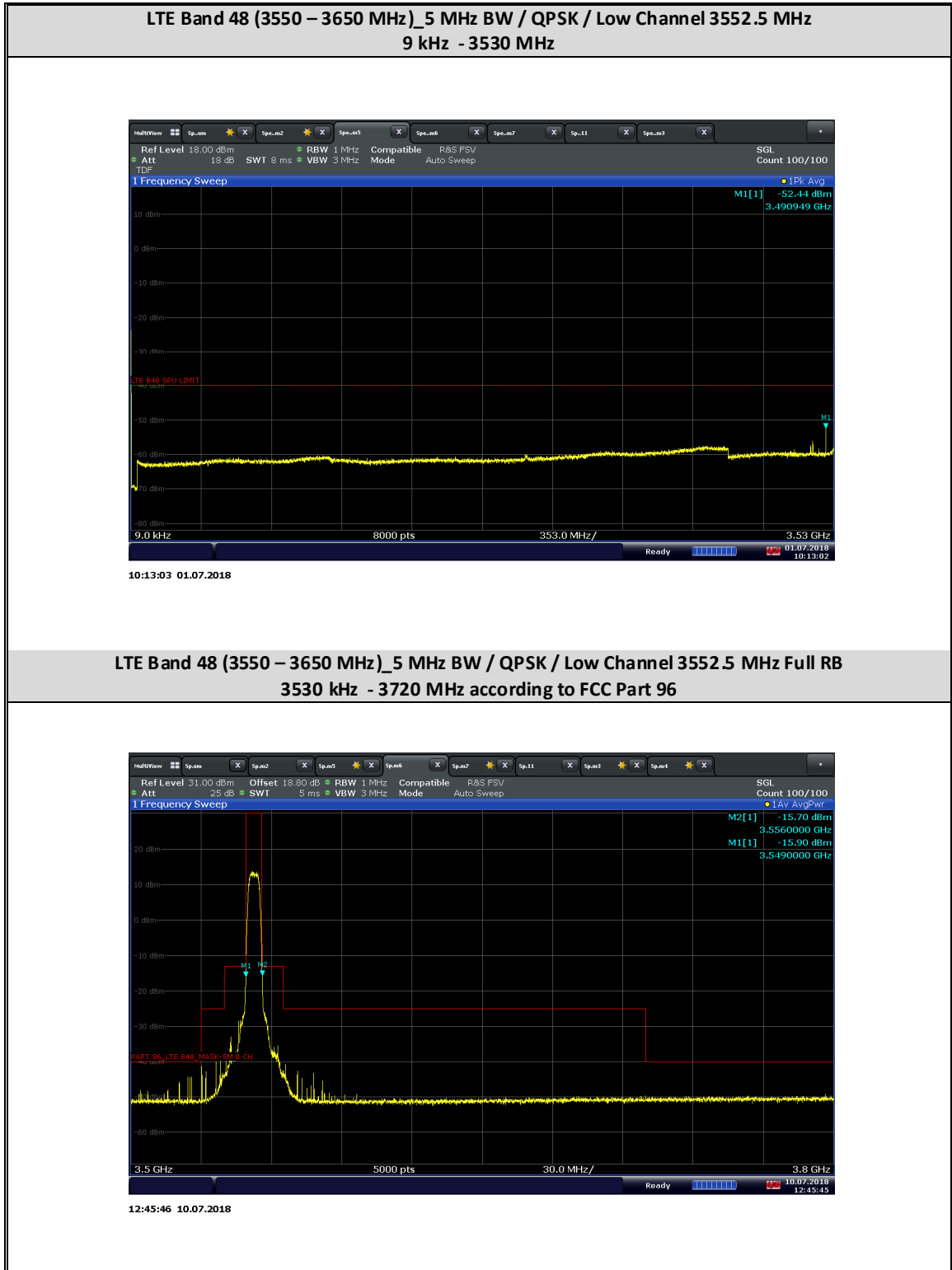



**LTE Band 48 (3550 – 3650 MHz)\_5 MHz BW / QPSK / Low Channel 3552.5 MHz Full RB  
 unwanted emission spectral density Mask according to RSS-192**

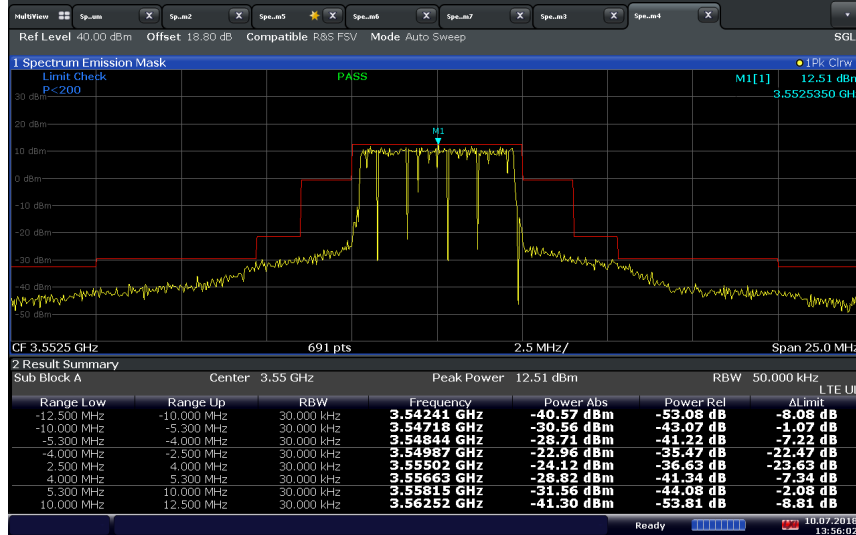

13:56:02 10.07.2018

**LTE Band 48 (3550 – 3650 MHz)\_5 MHz BW / QPSK / Low Channel 3552.5 MHz  
 3720 MHz - 26.5 GHz**



10:14:43 01.07.2018

LTE Band 48 (3550 – 3650 MHz)\_10 MHz BW / QPSK / Low Channel 3555 MHz  
9 kHz - 3530 MHz

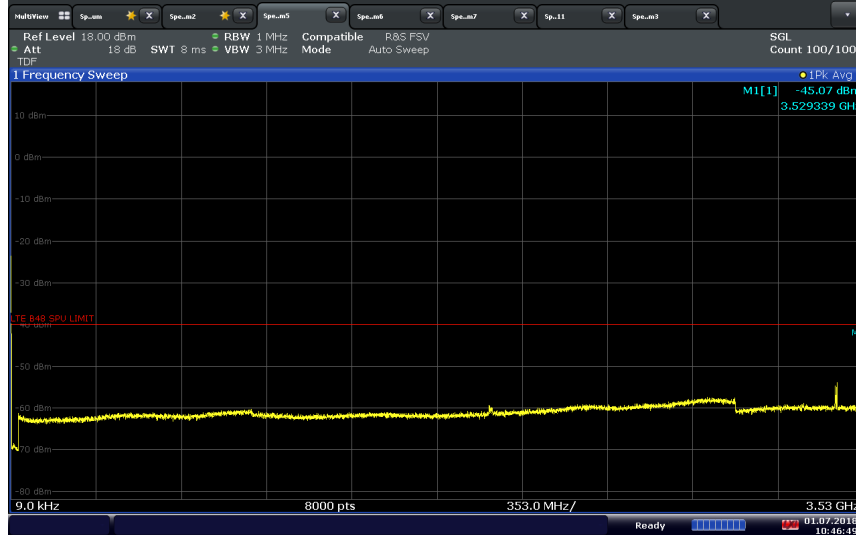

10:46:50 01.07.2018

LTE Band 48 (3550 – 3650 MHz)\_10 MHz BW / QPSK / Low Channel 3555 MHz Full RB  
3530 kHz - 3720 MHz according to FCC Part 96

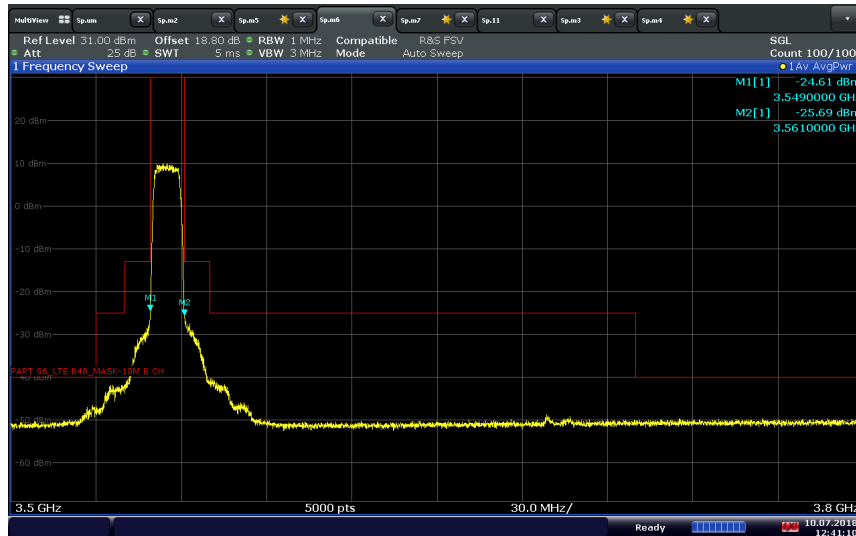

12:41:10 10.07.2018



**LTE Band 48 (3550 – 3650 MHz)\_10 MHz BW / QPSK / Low Channel 3555 MHz full RB  
 unwanted emission spectral density Mask according to RSS-192**

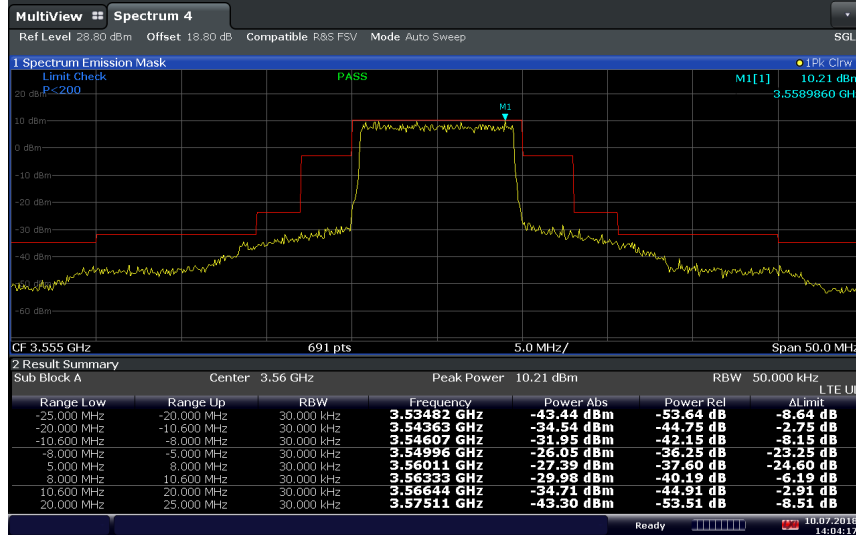

14:04:18 10.07.2018

**LTE Band 48 (3550 – 3650 MHz)\_10 MHz BW / QPSK / Low Channel 3555 MHz  
 3720 MHz - 26.5 GHz**



10:46:07 01.07.2018

LTE Band 48 (3550 – 3650 MHz)\_15 MHz BW / QPSK / Low Channel 3557.5 MHz  
9 kHz - 3530 MHz

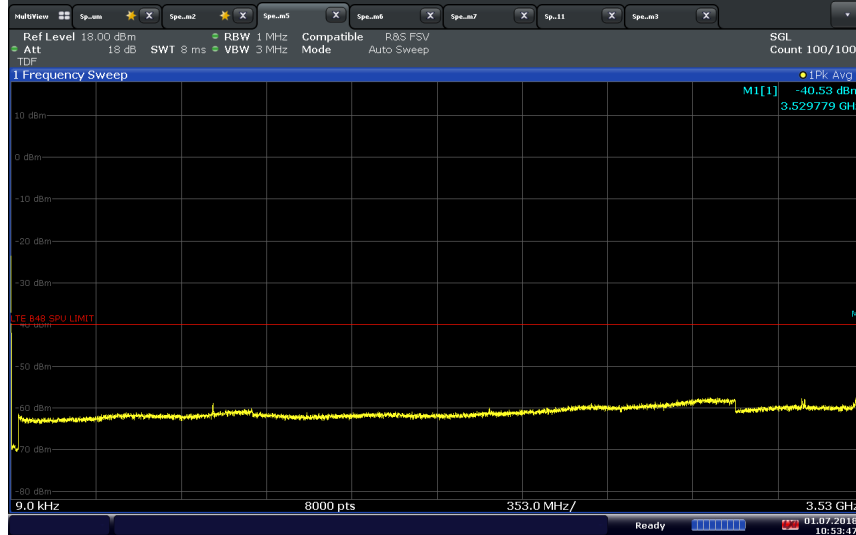

LTE Band 48 (3550 – 3650 MHz)\_15 MHz BW / QPSK / Low Channel 3557.5 MHz 1RB 0 offset  
3530 kHz - 3720 MHz according to FCC Part 96

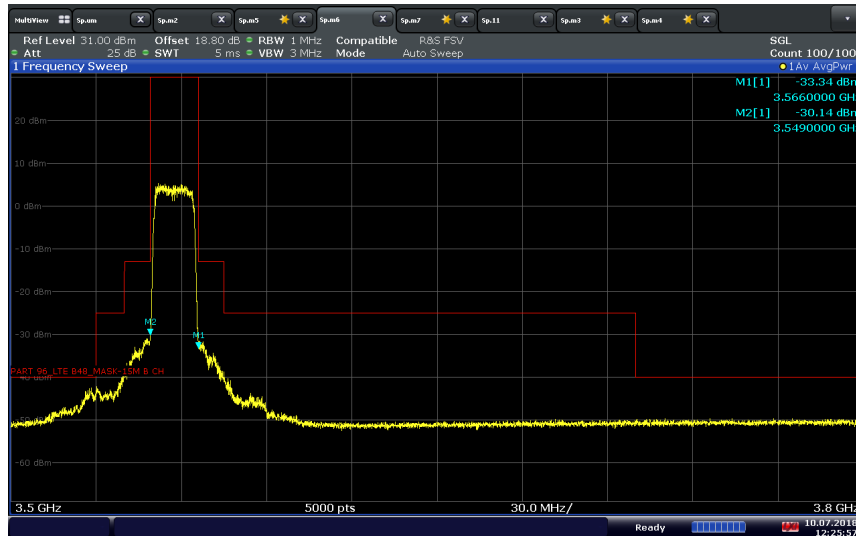





**LTE Band 48 (3550 – 3650 MHz)\_15 MHz BW / QPSK / Low Channel 3557.5 MHz full RB  
 unwanted emission spectral density Mask according to RSS-192**

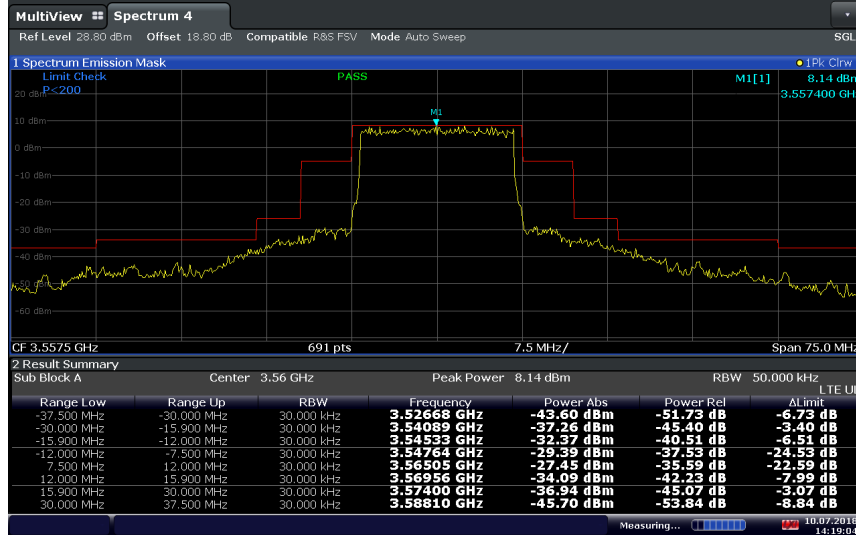

14:19:04 10.07.2018

**LTE Band 48 (3550 – 3650 MHz)\_15 MHz BW / QPSK / Low Channel 3557.5 MHz  
 3720 MHz - 26.5 GHz**



10:58:14 01.07.2018



LTE Band 48 (3550 – 3650 MHz)\_20 MHz BW / QPSK / Low Channel 3560 MHz  
9 kHz - 3530 MHz

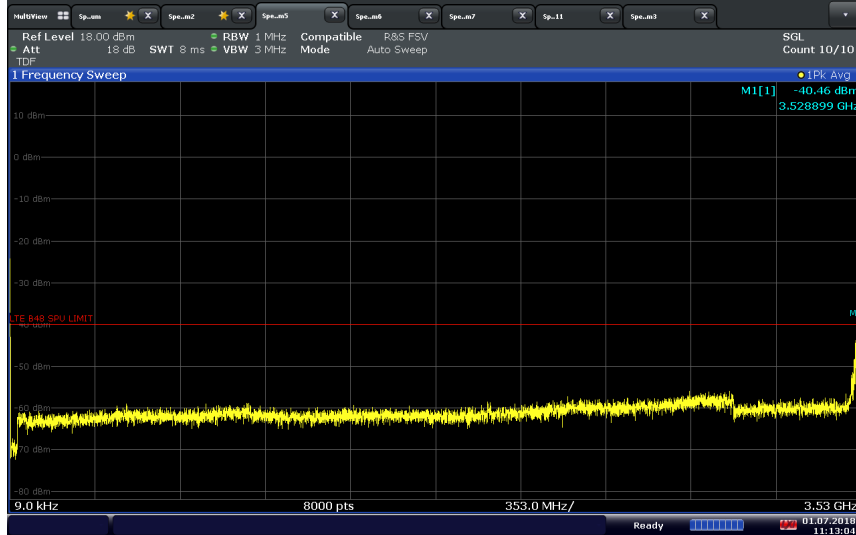

11:13:05 01.07.2018

LTE Band 48 (3550 – 3650 MHz)\_20 MHz BW / QPSK / Low Channel 3560 MHz full RB  
3530 kHz - 3720 MHz according to FCC Part 96

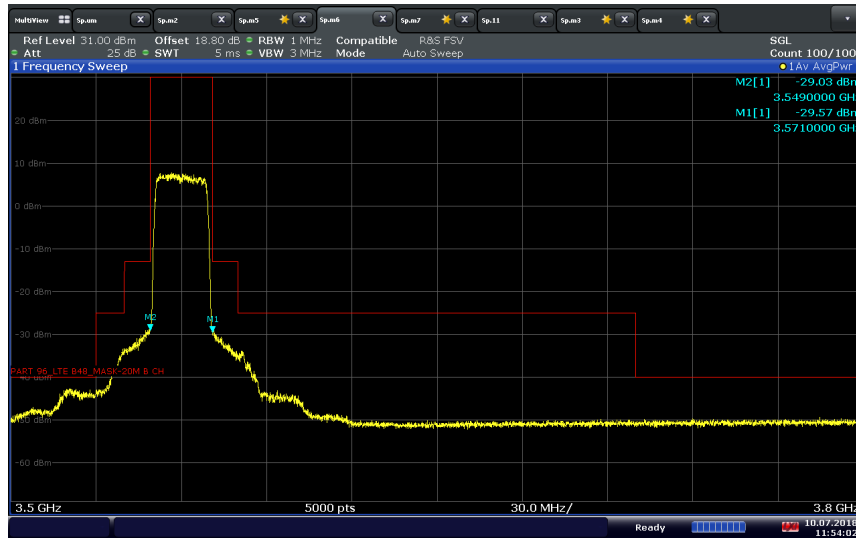

11:54:03 10.07.2018



**LTE Band 48 (3550 – 3650 MHz)\_20 MHz BW / QPSK / Low Channel 3560 MHz full RB  
 unwanted emission spectral density Mask according to RSS-192**

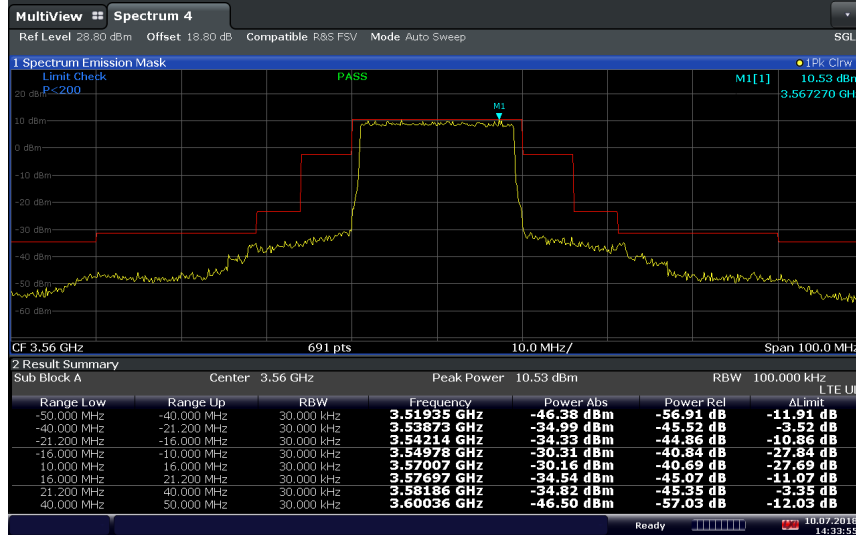

14:33:55 10.07.2018

**LTE Band 48 (3550 – 3650 MHz)\_20 MHz BW / QPSK / Low Channel 3560 MHz  
 3720 MHz - 26.5 GHz**



11:15:44 01.07.2018



LTE Band 48 (3550 – 3650 MHz)\_5 MHz BW / QPSK / Middle Channel 3600 MHz  
9 kHz - 3530 MHz

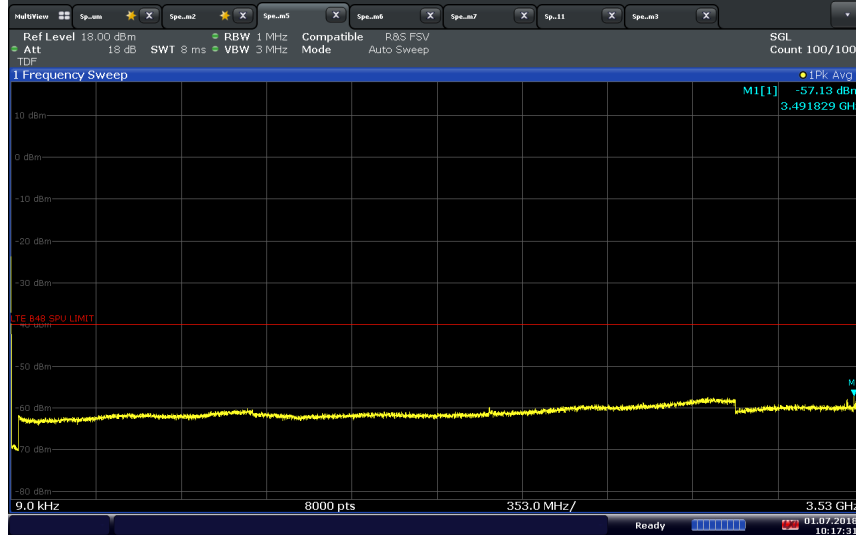

LTE Band 48 (3550 – 3650 MHz)\_5 MHz BW / QPSK / Middle Channel 3600 MHz full RB  
3530 kHz - 3720 MHz according to FCC Part 96

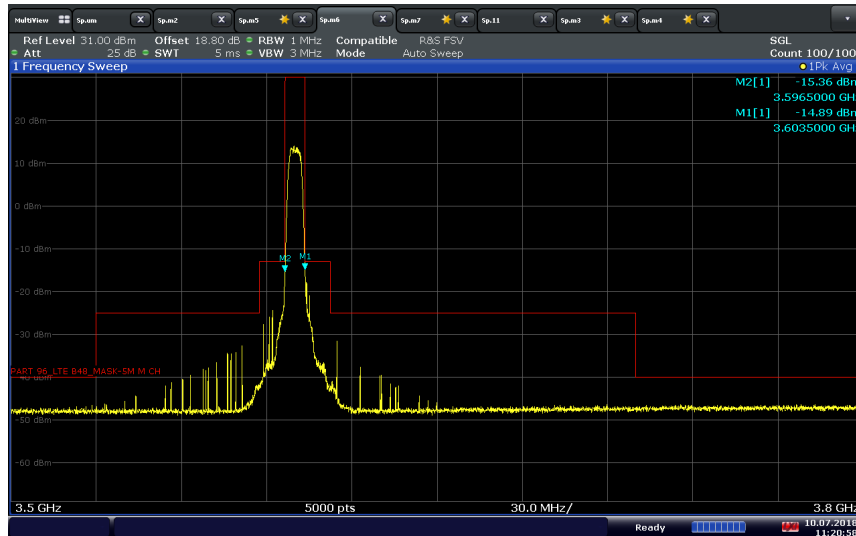



**LTE Band 48 (3550 – 3650 MHz)\_5 MHz BW / QPSK / Middle Channel 3600 MHz full RB  
 unwanted emission spectral density Mask according to RSS-192**

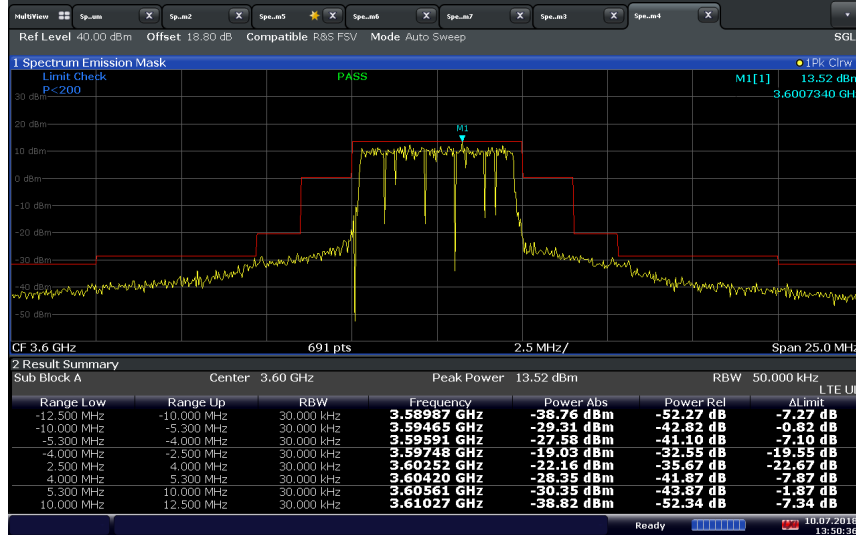

13:50:37 10.07.2018

**LTE Band 48 (3550 – 3650 MHz)\_5 MHz BW / QPSK / Middle Channel 3600 MHz  
 3720 MHz - 26.5 GHz**



10:15:57 01.07.2018



America

LTE Band 48 (3550 – 3650 MHz)\_10 MHz BW / QPSK / Middle Channel 3600 MHz  
9 kHz - 3530 MHz

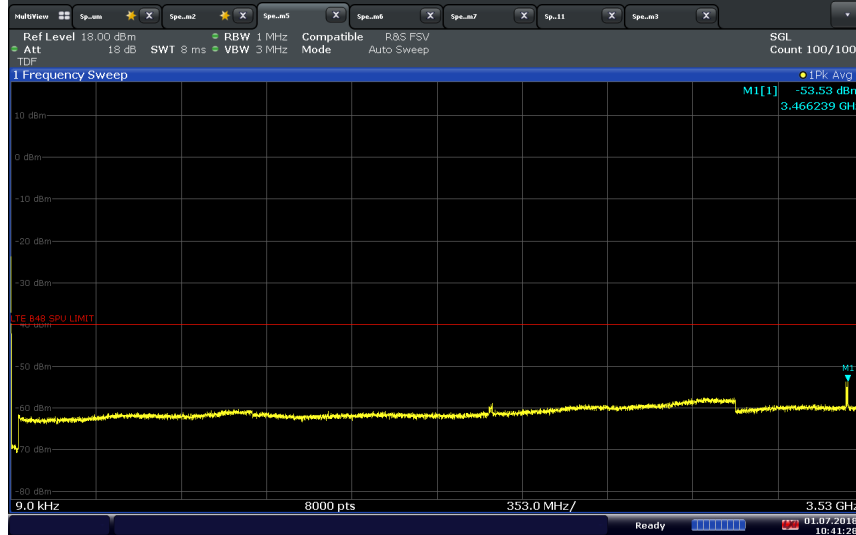

10:41:29 01.07.2018

LTE Band 48 (3550 – 3650 MHz)\_10 MHz BW / QPSK / Middle Channel 3600 MHz full RB  
3530 kHz - 3720 MHz according to FCC Part 96

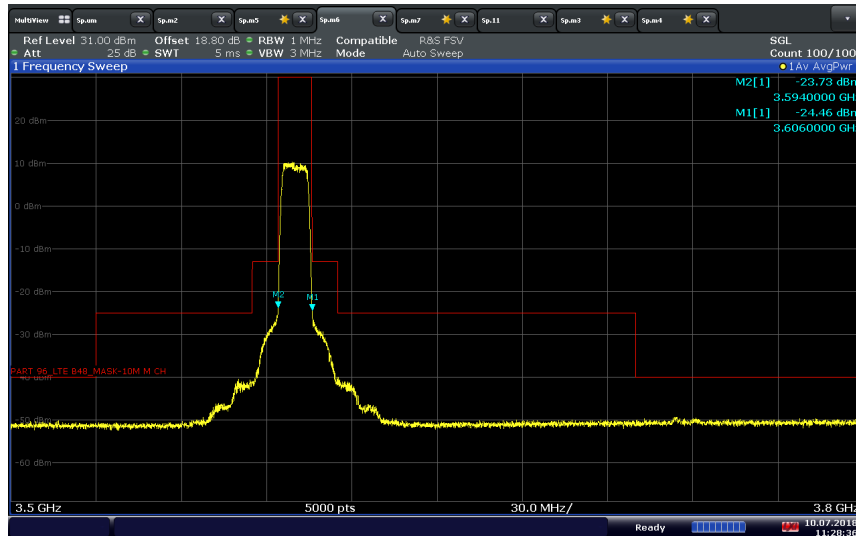

11:28:37 10.07.2018



**LTE Band 48 (3550 – 3650 MHz)\_10 MHz BW / QPSK / Middle Channel 3600 MHz full RB**  
**unwanted emission spectral density Mask according to RSS-192**

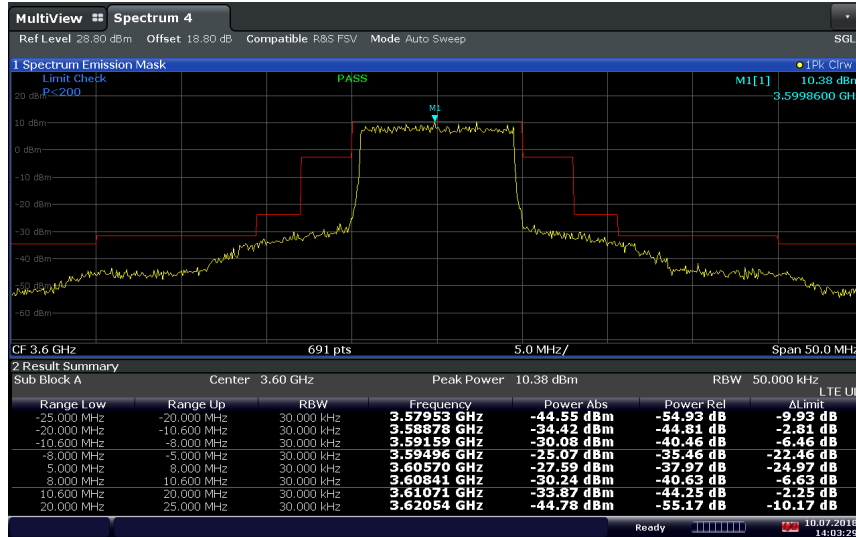

14:03:29 10.07.2018

**LTE Band 48 (3550 – 3650 MHz)\_10 MHz BW / QPSK / Middle Channel 3600 MHz**  
**3720 MHz - 26.5 GHz**



10:46:07 01.07.2018



America

LTE Band 48 (3550 – 3650 MHz)\_15 MHz BW / QPSK / Middle Channel 3600 MHz  
9 kHz - 3530 MHz

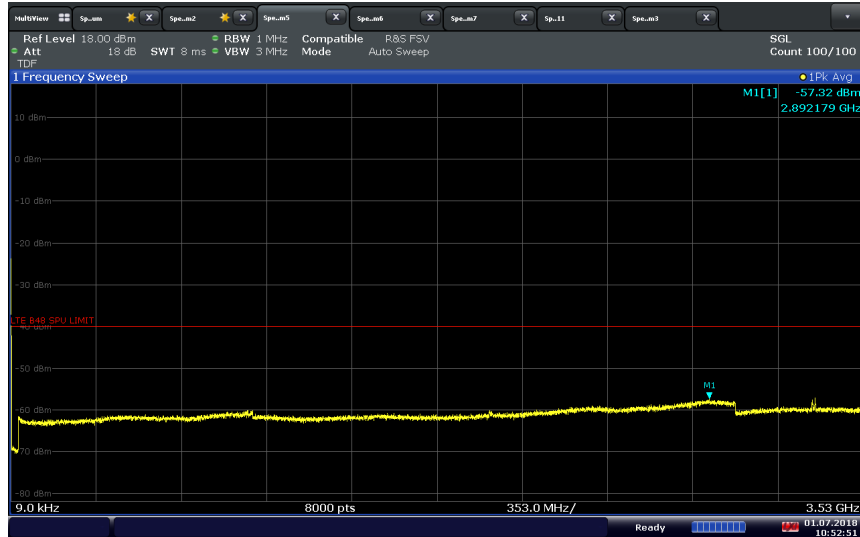

10:52:52 01.07.2018

LTE Band 48 (3550 – 3650 MHz)\_15 MHz BW / QPSK / Middle Channel 3600 MHz full RB  
3530 kHz - 3720 MHz according to FCC Part 96

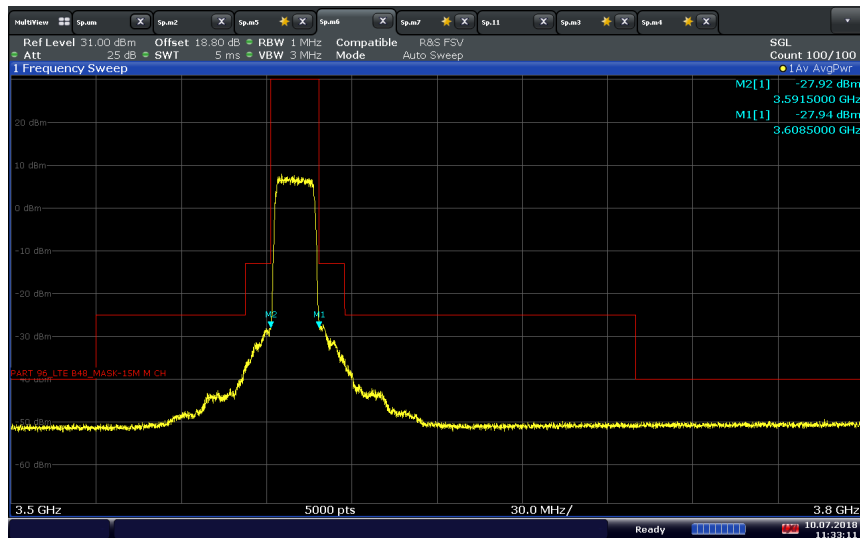

11:33:11 10.07.2018





**LTE Band 48 (3550 – 3650 MHz)\_15 MHz BW / QPSK / Middle Channel 3600 MHz full RB**  
**unwanted emission spectral density Mask according to RSS-192**

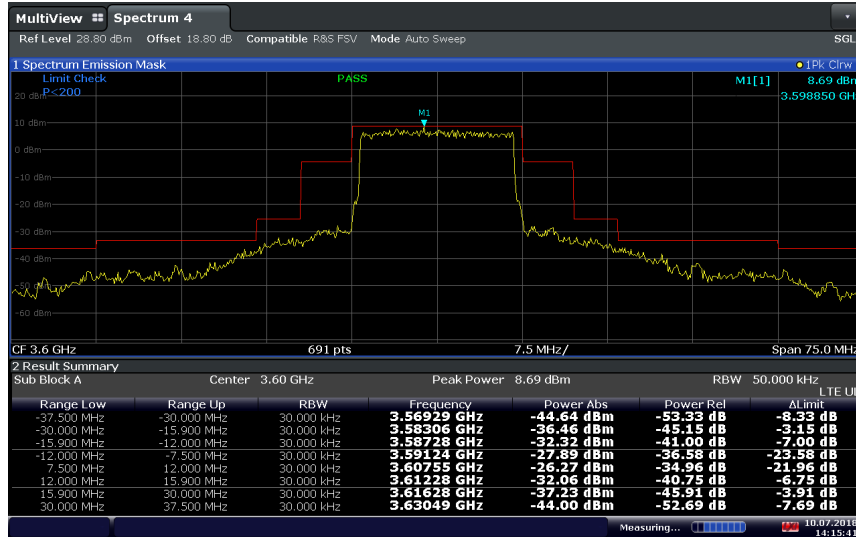

14:15:42 10.07.2018

**LTE Band 48 (3550 – 3650 MHz)\_15 MHz BW / QPSK / Middle Channel 3600 MHz**  
**3720 MHz - 26.5 GHz**



10:58:14 01.07.2018



America

LTE Band 48 (3550 – 3650 MHz)\_20 MHz BW / QPSK / Middle Channel 3600 MHz  
9 kHz - 3530 MHz

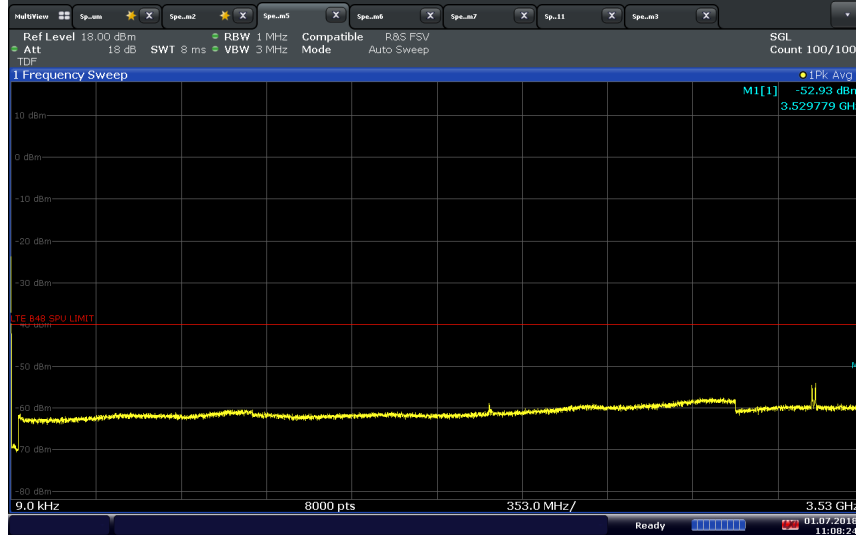

11:08:25 01.07.2018

LTE Band 48 (3550 – 3650 MHz)\_20 MHz BW / QPSK / Middle Channel 3600 MHz full RB  
3530 kHz - 3720 MHz according to FCC Part 96

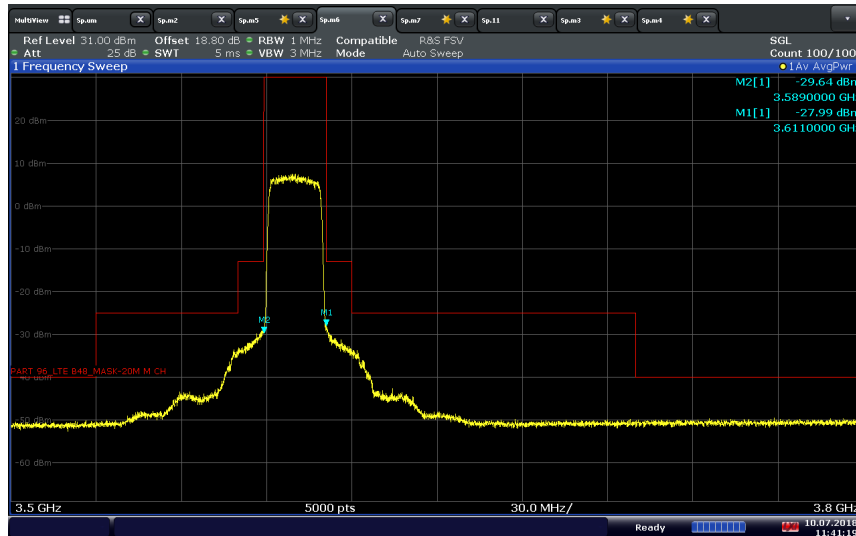

11:41:20 10.07.2018



**LTE Band 48 (3550 – 3650 MHz)\_20 MHz BW / QPSK / Middle Channel 3600 MHz full RB**  
**unwanted emission spectral density Mask according to RSS-192**

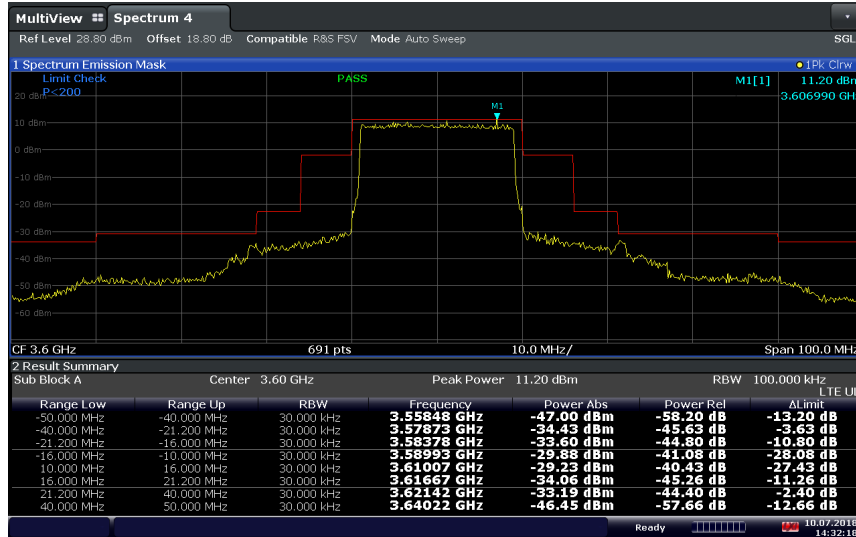

14:32:18 10.07.2018

**LTE Band 48 (3550 – 3650 MHz)\_20 MHz BW / QPSK / Middle Channel 3600 MHz**  
**3720 MHz - 26.5 GHz according to FCC Part 96**



11:07:02 01.07.2018



LTE Band 48 (3550 – 3650 MHz)\_5 MHz BW / QPSK / High Channel 3647.5 MHz  
9 kHz - 3530 MHz

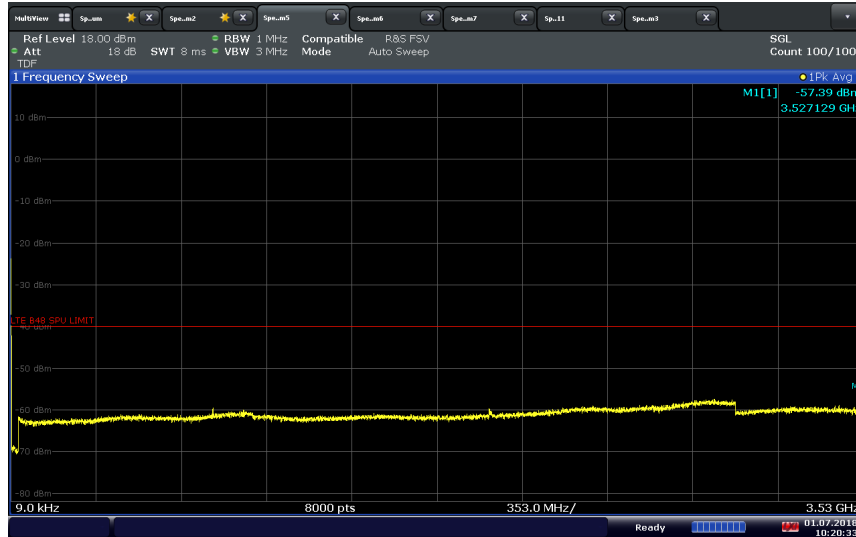

10:20:33 01.07.2018

LTE Band 48 (3550 – 3650 MHz)\_5 MHz BW / QPSK / High Channel 3647.5 MHz full RB  
3530 kHz - 3720 MHz according to FCC Part 96

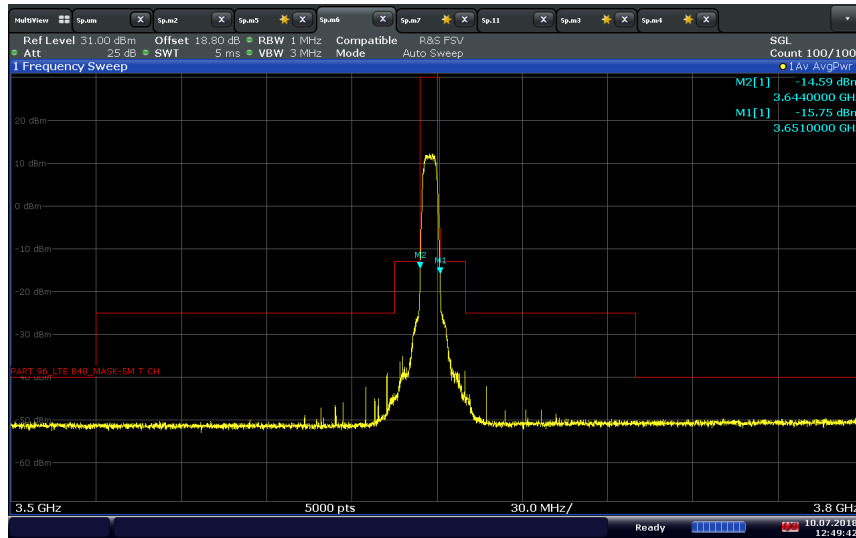

12:49:42 10.07.2018



**LTE Band 48 (3550 – 3650 MHz)\_5 MHz BW / QPSK / High Channel 3647.5 MHz full RB unwanted emission spectral density Mask according to RSS-192**

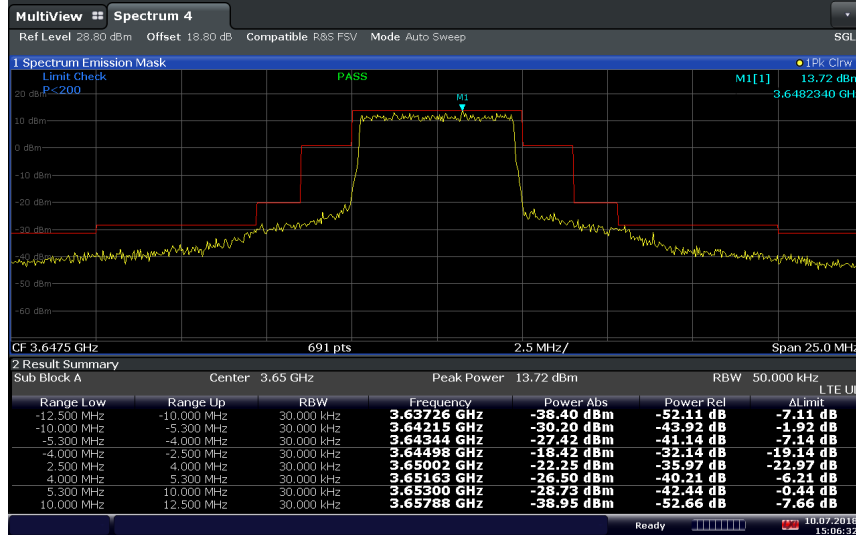

15:06:33 10.07.2018

**LTE Band 48 (3550 – 3650 MHz)\_5 MHz BW / QPSK / High Channel 3647.5 MHz 3720 MHz - 26.5 GHz**



10:19:00 01.07.2018

LTE Band 48 (3550 – 3650 MHz)\_10 MHz BW / QPSK / High Channel 3645 MHz  
9 kHz - 3530 MHz

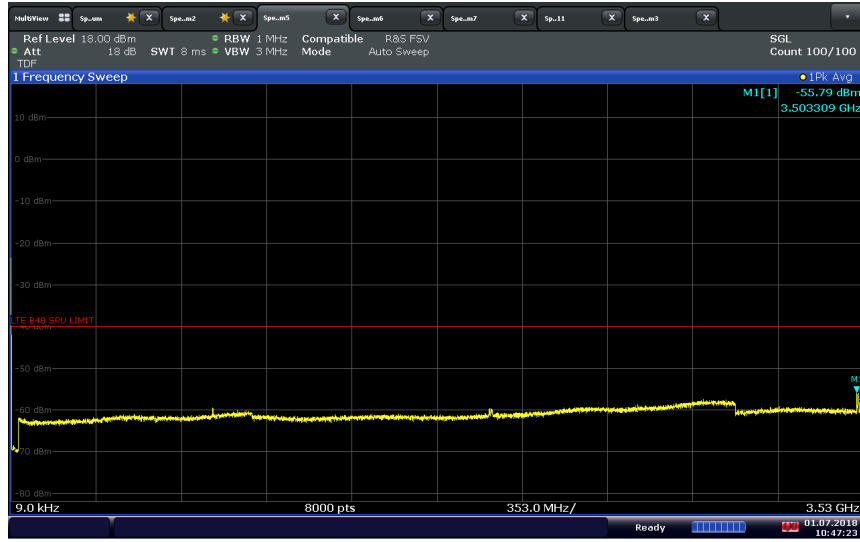

LTE Band 48 (3550 – 3650 MHz)\_10 MHz BW / QPSK / High Channel 3645 MHz Full RB  
3530 kHz - 3720 MHz according to FCC Part 96

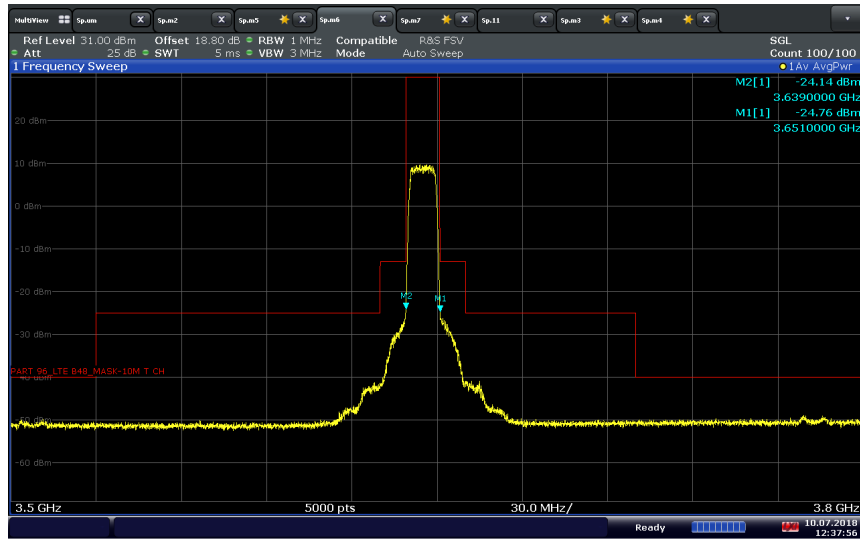



**LTE Band 48 (3550 – 3650 MHz)\_10 MHz BW / QPSK / High Channel 3645 MHz full RB unwanted emission spectral density Mask according to RSS-192**

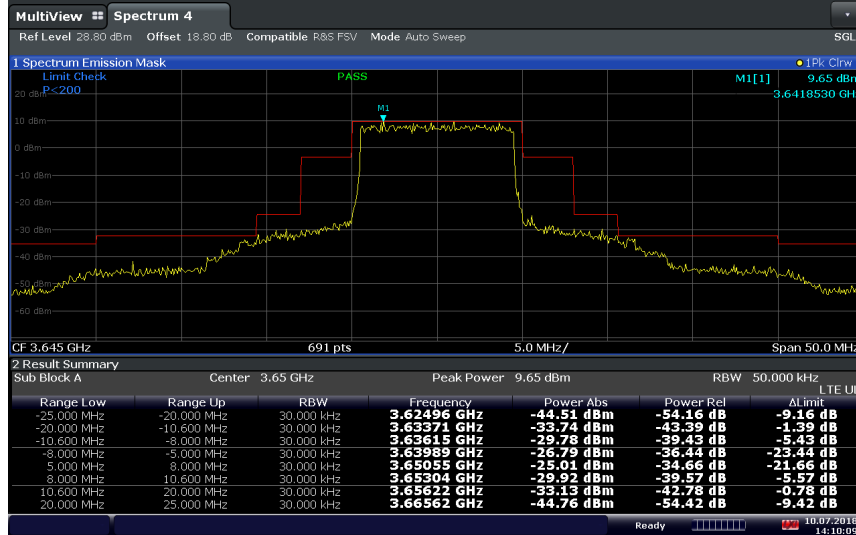

14:10:09 10.07.2018

**LTE Band 48 (3550 – 3650 MHz)\_10 MHz BW / QPSK / High Channel 3645 MHz 3720 MHz - 26.5 GHz**



10:49:01 01.07.2018

LTE Band 48 (3550 – 3650 MHz)\_15 MHz BW / QPSK / High Channel 3642.5 MHz  
9 kHz - 3530 MHz

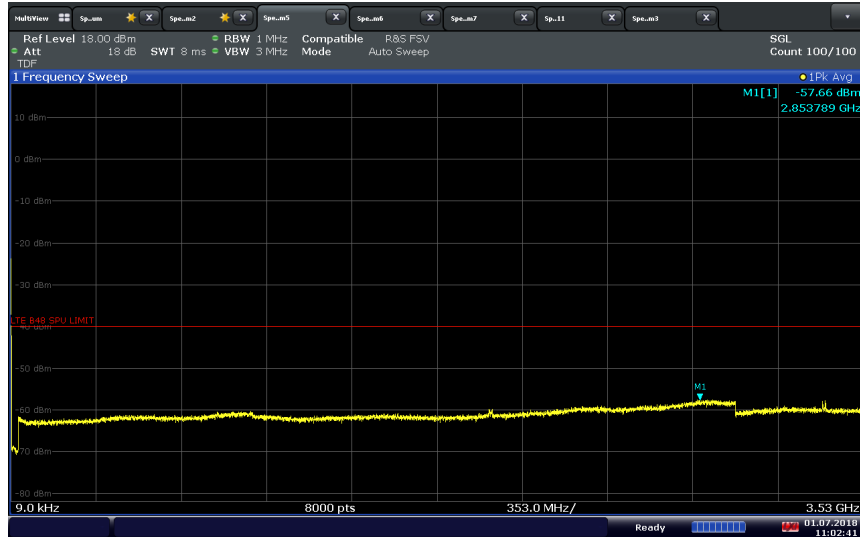

11:02:42 01.07.2018

LTE Band 48 (3550 – 3650 MHz)\_15 MHz BW / QPSK / High Channel 3642.5 MHz full RB  
3530 kHz - 3720 MHz according to FCC Part 96

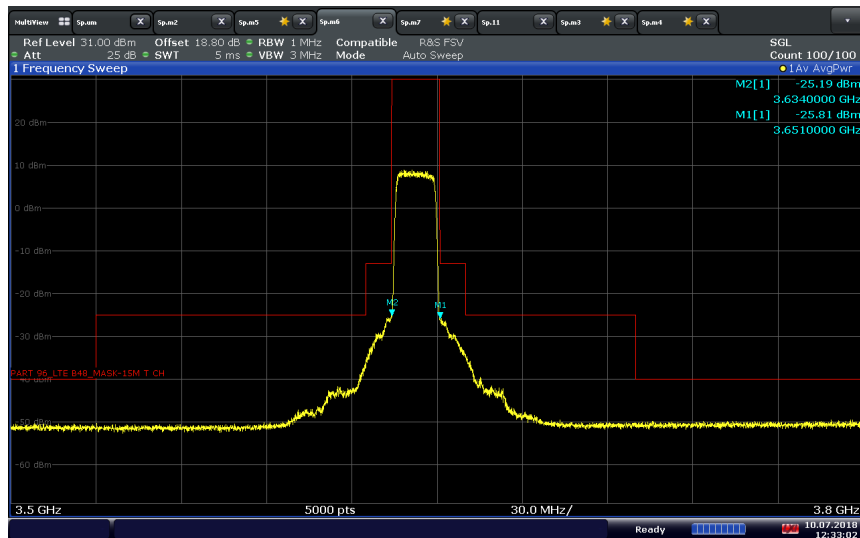

12:33:02 10.07.2018





**LTE Band 48 (3550 – 3650 MHz)\_15 MHz BW / QPSK / High Channel 3642.5 MHz full RB  
 unwanted emission spectral density Mask according to RSS-192**

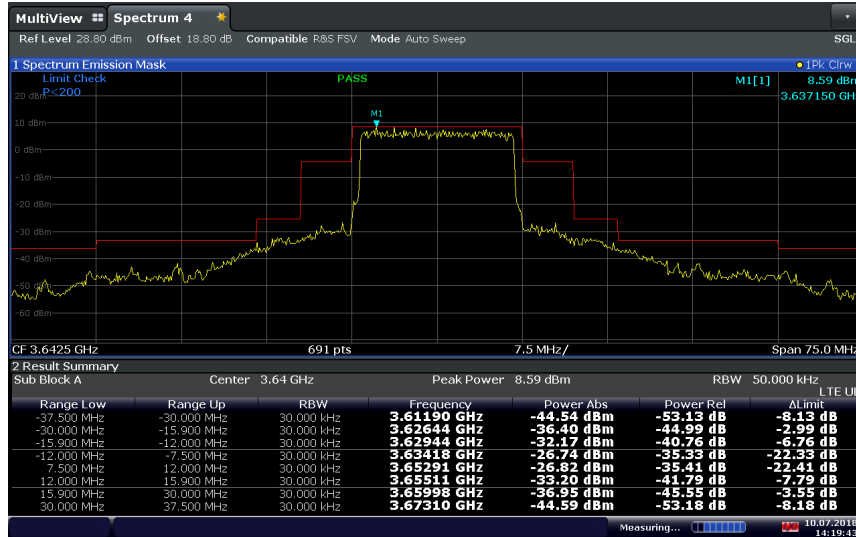

14:19:44 10.07.2018

**LTE Band 48 (3550 – 3650 MHz)\_15 MHz BW / QPSK / High Channel 3642.5 MHz  
 3720 MHz - 26.5 GHz**



10:59:33 01.07.2018



America

LTE Band 48 (3550 – 3650 MHz)\_20 MHz BW / QPSK / High Channel 3640 MHz  
9 kHz - 3530 MHz

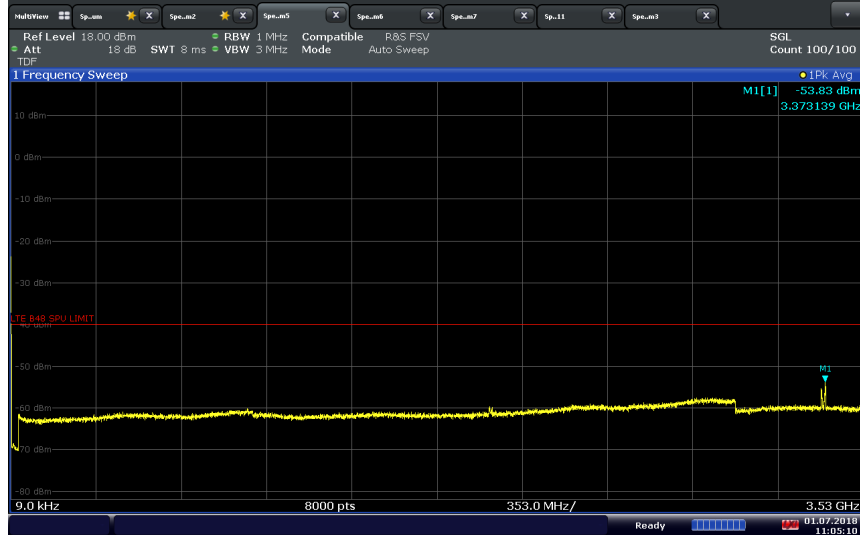

11:05:10 01.07.2018

LTE Band 48 (3550 – 3650 MHz)\_20 MHz BW / QPSK / High Channel 3640 MHz full RB  
3530 kHz - 3720 MHz according to FCC Part 96

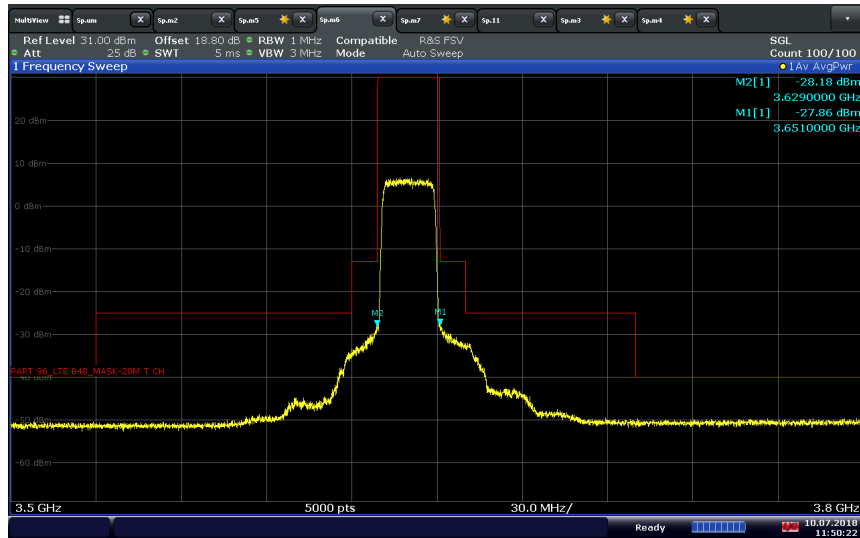

11:50:23 10.07.2018



**LTE Band 48 (3550 – 3650 MHz)\_20 MHz BW / QPSK / High Channel 3640 MHz full RB unwanted emission spectral density Mask according to RSS-192**

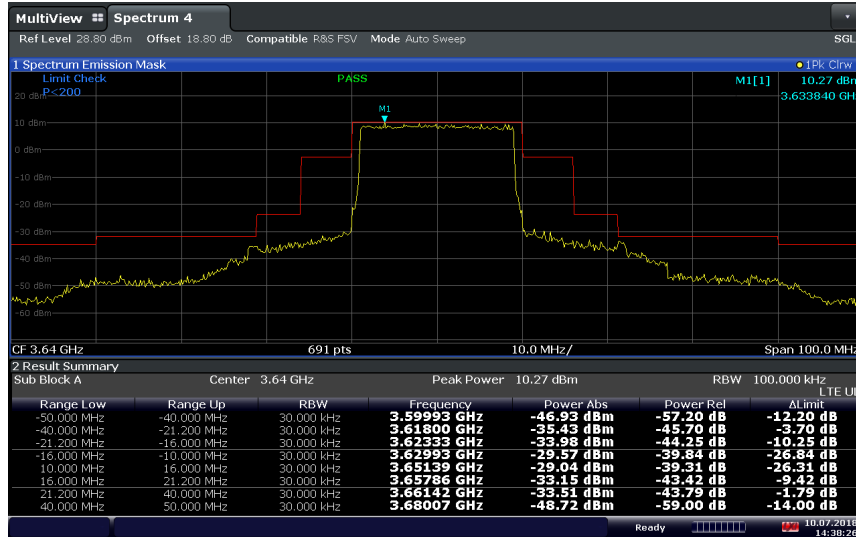

14:38:26 10.07.2018

**LTE Band 48 (3550 – 3650 MHz)\_20 MHz BW / QPSK / High Channel 3640 MHz 3720 MHz - 26.5 GHz**



11:05:56 01.07.2018

LTE Band 48 (3650 – 3700 MHz)\_5 MHz BW / QPSK / Middle Channel 3675 MHz  
9 kHz - 4 GHz

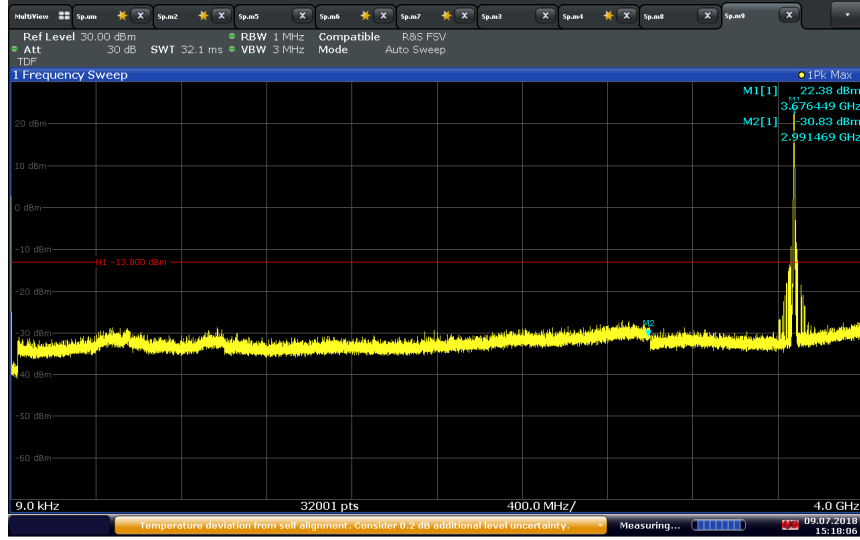

15:18:06 09.07.2018

LTE Band 48 (3550 – 3650 MHz)\_5 MHz BW / QPSK / Middle Channel 3675 MHz  
4 GHz - 26.5 GHz



15:03:53 09.07.2018

LTE Band 48 (3650 – 3700 MHz)\_10 MHz BW / QPSK / Middle Channel 3675 MHz  
9 kHz - 4 GHz

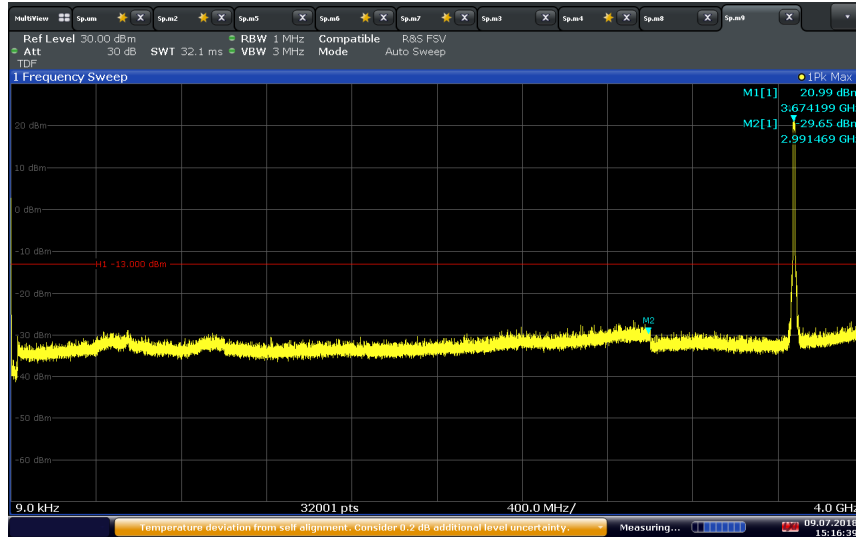

15:16:40 09.07.2018

LTE Band 48 (3550 – 3650 MHz)\_10 MHz BW / QPSK / Middle Channel 3675 MHz  
4 GHz - 26.5 GHz



15:05:14 09.07.2018

LTE Band 48 (3650 – 3700 MHz)\_15 MHz BW / QPSK / Middle Channel 3675 MHz  
9 kHz - 4 GHz

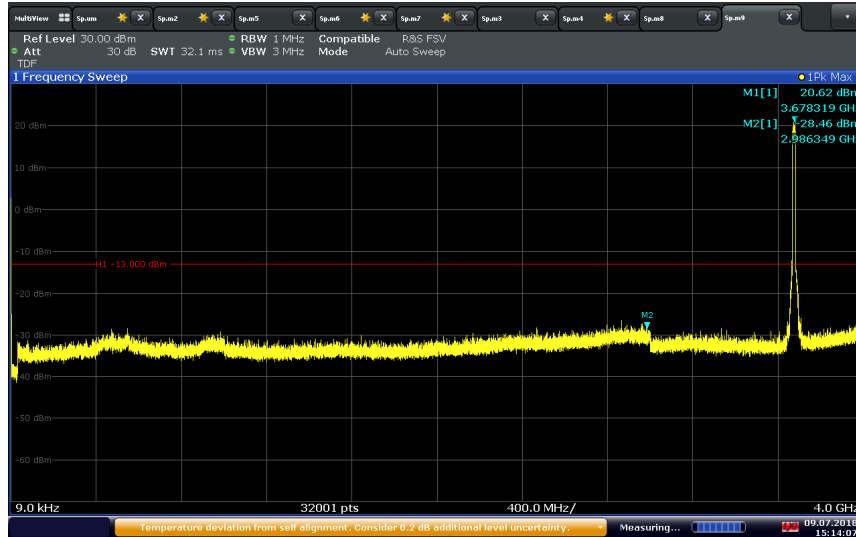

15:14:07 09.07.2018

LTE Band 48 (3550 – 3650 MHz)\_15 MHz BW / QPSK / Middle Channel 3675 MHz  
4 GHz - 26.5 GHz



15:08:08 09.07.2018

LTE Band 48 (3650 – 3700 MHz)\_20 MHz BW / QPSK / Middle Channel 3675 MHz  
9 kHz - 4 GHz

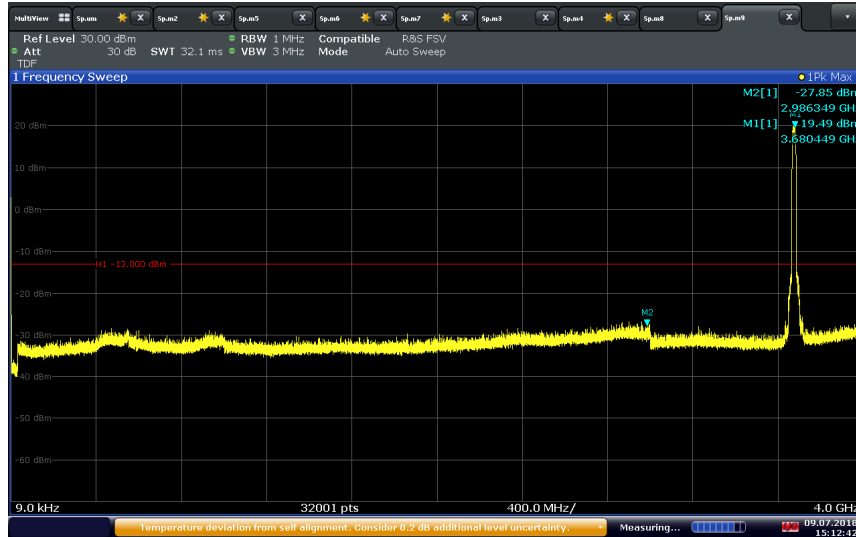

15:12:42 09.07.2018

LTE Band 48 (3550 – 3650 MHz)\_20 MHz BW / QPSK / Middle Channel 3675 MHz  
4 GHz - 26.5 GHz



15:10:52 09.07.2018



## 2.6 FIELD STRENGTH OF SPURIOUS RADIATION

### 2.6.1 Specification Reference

FCC 47 CFR Part 2, Clause 2.1053  
FCC 47 CFR Part 96, Clause 96.41(e)  
FCC 47 CFR Part 90, Clause 90.1323(a)  
RSS-192, Clause 5.5  
RSS-197, Clause 5.7

### 2.6.2 Standard Applicable

FCC 47 CFR Part 96.41:

(e) 3.5 GHz Emissions and Interference Limits - (1) General protection levels. Except as otherwise specified in paragraph (e)(2) of this section, for channel and frequency assignments made by the SAS to CBSDs, the conducted power of any emission outside the fundamental emission (whether in or outside of the authorized band) shall not exceed -13 dBm/MHz within 0-10 megahertz above the upper SAS-assigned channel edge and within 0-10 megahertz below the lower SAS-assigned channel edge. At all frequencies greater than 10 megahertz above the upper SAS assigned channel edge and less than 10 MHz below the lower SAS assigned channel edge, the conducted power of any emission shall not exceed -25 dBm/MHz. The upper and lower SAS assigned channel edges are the upper and lower limits of any channel assigned to a CBSD by an SAS, or in the case of multiple contiguous channels, the upper and lower limits of the combined contiguous channels.

(2) Additional protection levels: Notwithstanding paragraph (d)(1) of this section, the conducted power of any emissions below 3530 MHz or above 3720 MHz shall not exceed -40dBm/MHz.

RSS-192, Clause 5.5:

(ii) In any 1.0 MHz band that is removed from the assigned centre frequency by more than  $\pm 250\%$  of the necessary bandwidth, the power of any emission must be attenuated below  $P_{\text{mean}}$  by at least  $43 + 10 \log_{10}(P_{\text{mean}})$  dB, or 70 dB, whichever is less stringent.  $P_{\text{mean}}$  is the mean output power of the transmitter in watts.





FCC 47 CFR Part 90.1323:

(a) The power of any emission outside a licensee's frequency band(s) of operation shall be attenuated below the transmitter power (P) within the licensed band(s) of operation, measured in watts, by at least  $43 + 10 \log(P)$  dB. Compliance with this provision is based on the use of measurement instrumentation employing a resolution bandwidth of 1 MHz or less, but at least one percent of the emission bandwidth of the fundamental emission of the transmitter, provided the measured energy is integrated over a 1 MHz bandwidth.

RSS-197, Clause 5.7:

The unwanted emissions shall be measured at the frequencies of the highest and lowest channel of all bandwidths and types of modulation that the equipment can operate with a resolution bandwidth of 1 MHz or less, but at least 1% of the occupied bandwidth of the transmitter, provided that the measured power is integrated over a 1 MHz bandwidth.

The power of any emissions outside the frequency band 3650-3700 MHz shall be attenuated below the channel transmitter power P (dBW) by  $43 + 10 \log(p)$ , where p is measured in watts.

### 2.6.3 Equipment Under Test and Modification State

Serial No: AZ280418A00132 / Test Configuration B

### 2.6.4 Date of Test/Initial of test personnel who performed the test

July 05 and 06, 2018 /XYZ

### 2.6.5 Test Equipment Used

The major items of test equipment used for the above tests are identified in Section 3.1.

### 2.6.6 Environmental Conditions/ Test Location

Test performed at TÜV SÜD America Inc. Rancho Bernardo facility

Ambient Temperature	25.2 - 26.7 °C
Relative Humidity	45.7 - 49.3 %
ATM Pressure	98.6 - 98.7 kPa

### 2.6.7 Additional Observations

- This is a radiated test using substitution method as per Unwanted Emissions: Radiated Spurious method of measurement of Sub clause 5.5 of ANSI C63.16-2015.
- Emissions within 6dB of the limit will be proven by substitution method.
- Only the worst case configuration presented in this test report.
- Only noise floor measurements observed above 18GHz.
- Measurement was done using EMC32 V8.53 automated software. Reported level is the actual level with all the correction factors factored in. Correction Factor column is for informational purposes only.

### 2.6.8 Test Results

See attached plots.



**2.6.9 Radiated Emission Test Results Below 1GHz – Worst Case Band 48 (3550 – 3650 MHz)\_QPSK\_15 MHz BW 1RB 0 offset\_High Channel 3600 MHz**

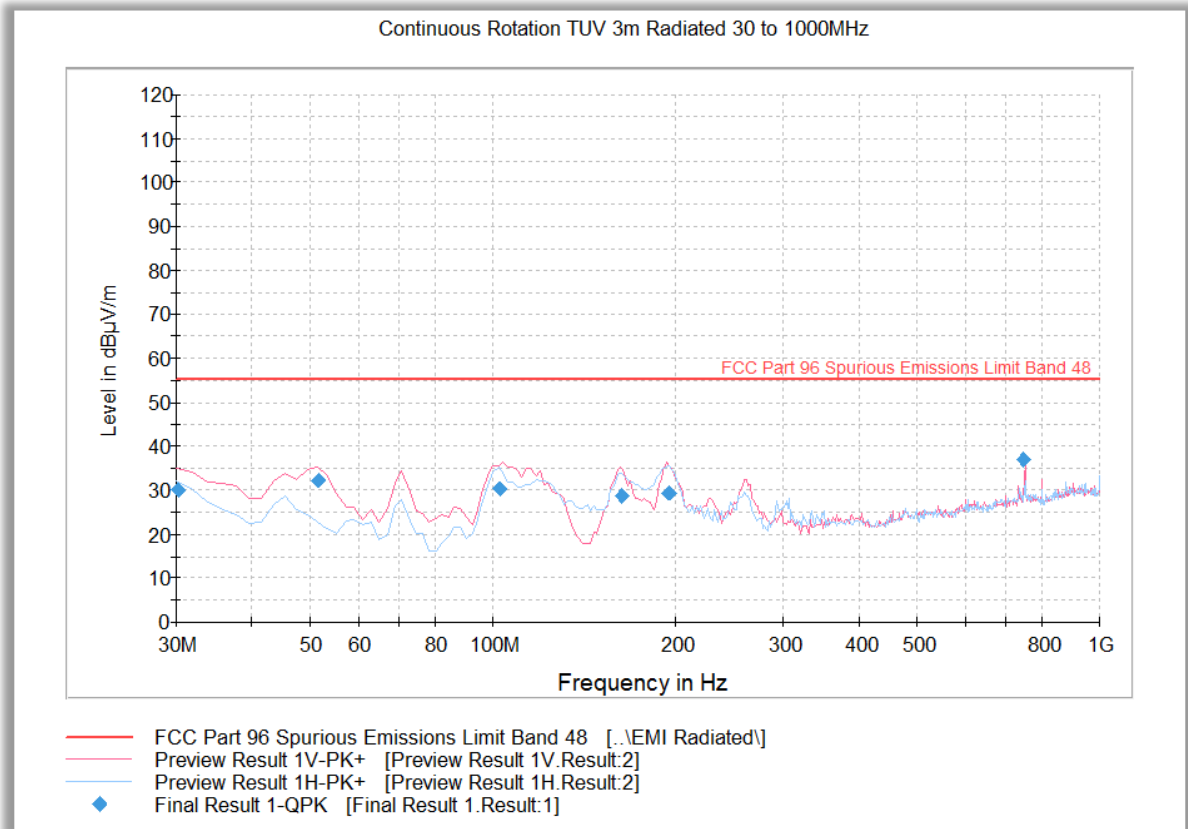

**Quasi Peak Data**

Frequency (MHz)	QuasiPeak (dBµV/m)	Meas. Time (ms)	Bandwidth (kHz)	Height (cm)	Polarization	Azimuth (deg)	Corr. (dB)	Margin (dB)	Limit (dBµV/m)
30.240000	30.1	1000.0	120.000	100.0	V	190.0	-6.6	25.1	55.2
51.422766	32.1	1000.0	120.000	100.0	V	182.0	-15.1	23.1	55.2
102.827735	30.3	1000.0	120.000	100.0	V	159.0	-14.9	24.9	55.2
163.384369	28.7	1000.0	120.000	100.0	V	301.0	-12.8	26.5	55.2
195.166573	29.4	1000.0	120.000	100.0	V	-9.0	-12.1	25.8	55.2
749.982365	37.0	1000.0	120.000	150.0	V	257.0	4.0	18.2	55.2

**Test Notes:** Only worst case modulation/bandwidth/channel presented for spurious emissions below 1GHz.



America

**2.6.10 Radiated Emission Test Results Above 1GHz – Worst Case Band 48 (3550 – 3650 MHz)\_QPSK\_15 MHz  
 BW 1RB 0 offset\_Low Channel 3657.5 MHz**

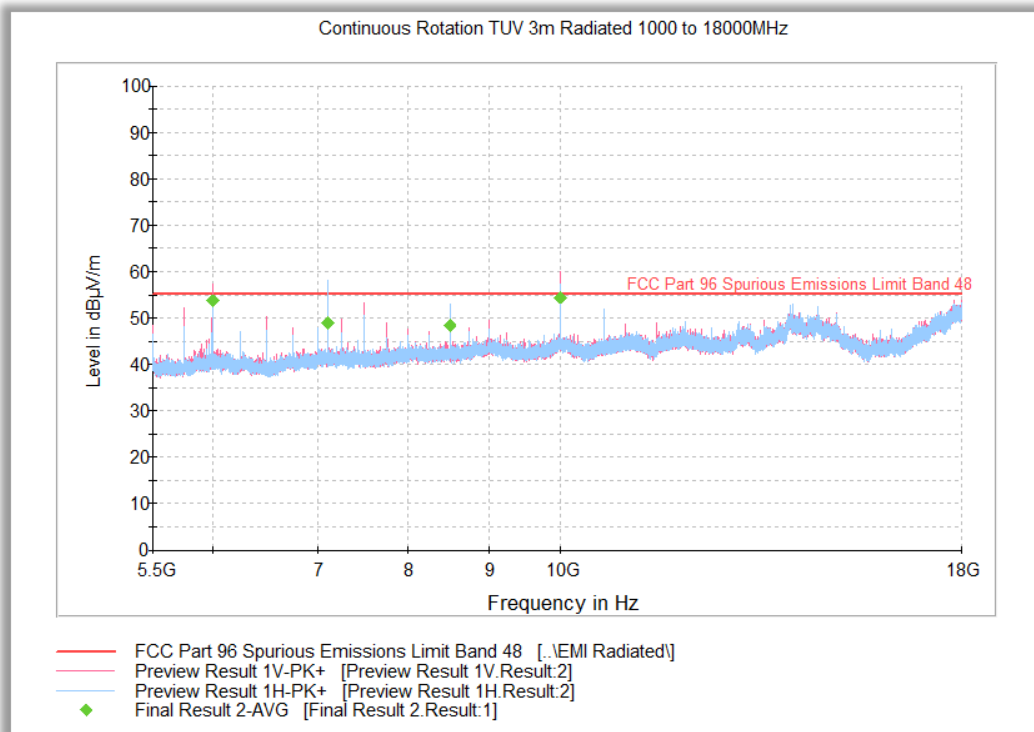
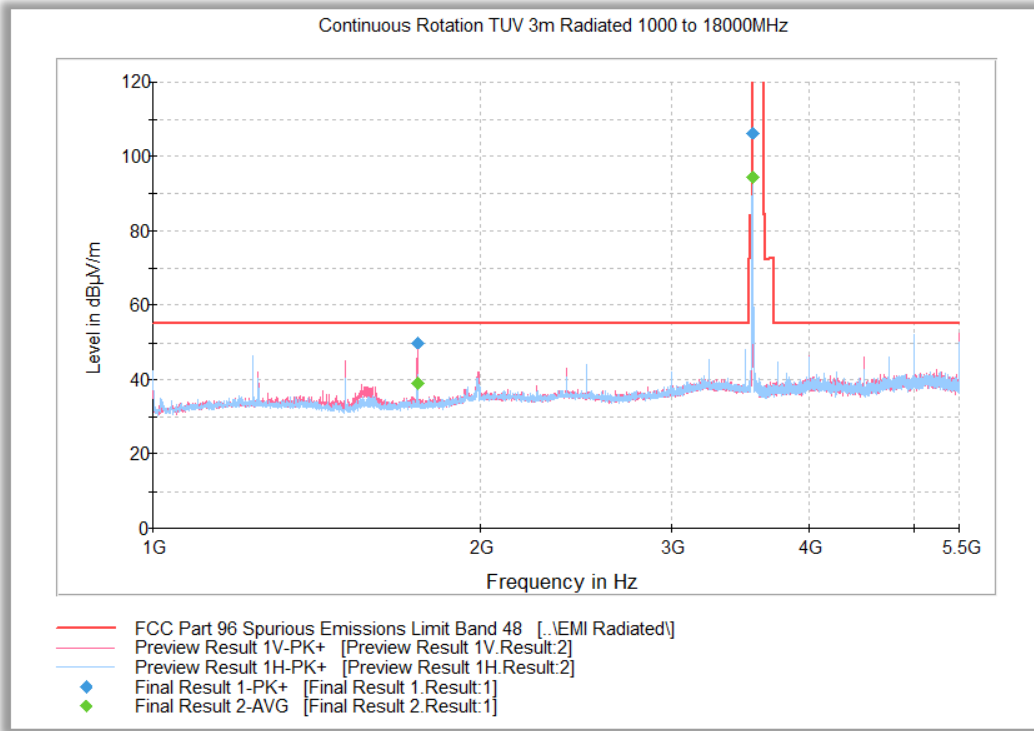



**Average Data**

Frequency (MHz)	Average (dBμV/m)	Meas. Time (ms)	Bandwidth (kHz)	Height (cm)	Polarization	Azimuth (deg)	Corr. (dB)	Peak Margin (dB)	Limit (dBμV/m)
1749.900000	39.1	1000.0	1000.000	227.4	V	-8.0	-6.9	16.1	55.2
3550.766667	94.4	1000.0	1000.000	138.7	H	-8.0	-0.5	* Fundamental Freq.	
5999.783333	53.6	1000.0	1000.000	276.2	V	189.0	4.5	1.6	55.2
7101.866667	49.0	1000.0	1000.000	302.2	V	155.0	6.1	6.2	55.2
8499.783333	48.3	1000.0	1000.000	307.2	H	21.0	8.5	6.9	55.2
9999.783333	54.5	1000.0	1000.000	313.1	V	100.0	10.3	0.7	55.2

\* This is the fundamental frequency not part of spurious emission evaluation. Data provided for information purpose only.

**Substitution Data**

Frequency (MHz)	Field Strength @ 3 meters (dBμV/m)	Cable Loss (dB)	Substitution Antenna Gain (dBi)	Signal Generator Level (dBm)	Substitution Data SGL+AG-CL (dBm)	Limit (dBm)	Compliance
5999.783333	53.6	6.4	11.7	-47.0	-41.7	-40	Yes
9999.783333	54.5	9.1	12.2	-43.9	-40.8	-40	Yes



America

**2.6.11 Radiated Emission Test Results Above 1GHz – Worst Case Band 48 (3550 – 3650 MHz)\_QPSK\_15 MHz BW 1RB 0 offset\_Low Channel 3660 MHz**

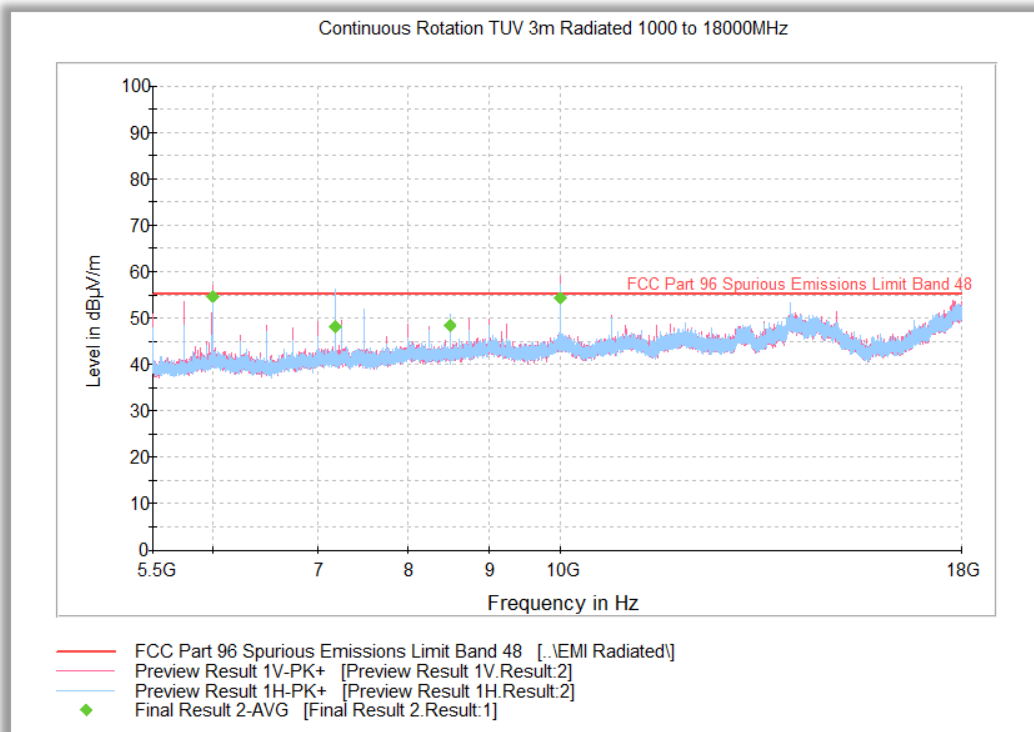
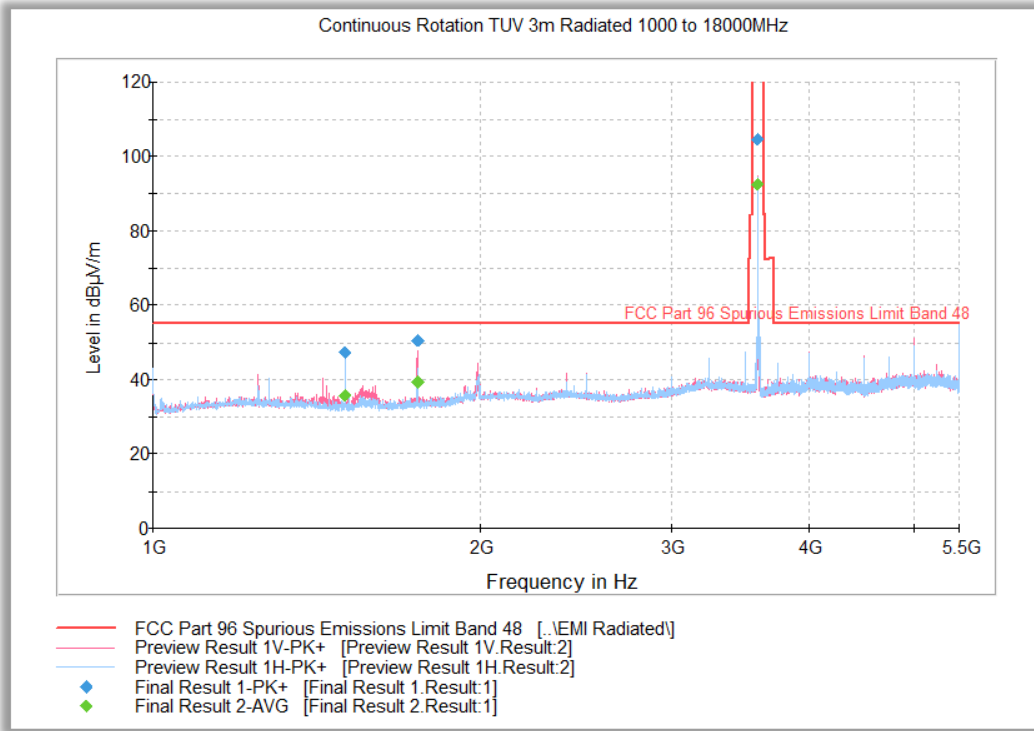



**Average Data**

Frequency (MHz)	Average (dBμV/m)	Meas. Time (ms)	Bandwidth (kHz)	Height (cm)	Polarization	Azimuth (deg)	Corr. (dB)	Peak Margin (dB)	Limit (dBμV/m)
1500.000000	35.9	1000.0	1000.000	190.5	V	174.0	-9.0	19.3	55.2
1749.900000	39.5	1000.0	1000.000	218.4	V	358.0	-6.9	15.7	55.2
3593.266667	92.4	1000.0	1000.000	388.0	V	-1.0	-0.5	* Fundamental Freq.	
5999.783333	54.6	1000.0	1000.000	286.2	V	191.0	4.5	0.6	55.2
7186.650000	48.2	1000.0	1000.000	187.5	H	25.0	6.5	7.0	55.2
8499.800000	48.4	1000.0	1000.000	311.2	H	22.0	8.5	6.8	55.2
9999.800000	54.3	1000.0	1000.000	307.2	V	100.0	10.3	0.9	55.2

\* This is the fundamental frequency not part of spurious emission evaluation. Data provided for information purpose only.

**Substitution Data**

Frequency (MHz)	Field Strength @ 3 meters (dBμV/m)	Cable Loss (dB)	Substitution Antenna Gain (dBi)	Signal Generator Level (dBm)	Substitution Data SGL+AG-CL (dBm)	Limit (dBm)	Compliance
5999.783333	54.6	6.4	11.7	-46.0	-40.7	-40	Yes
9999.800000	54.3	9.1	12.2	-44.1	-41.0	-40	Yes



America

**2.6.12 Radiated Emission Test Results Above 1GHz – Worst Case Band 48 (3550 – 3650 MHz)\_QPSK\_15 MHz  
 BW 1RB 0 offset\_Low Channel 3642.5 MHz**

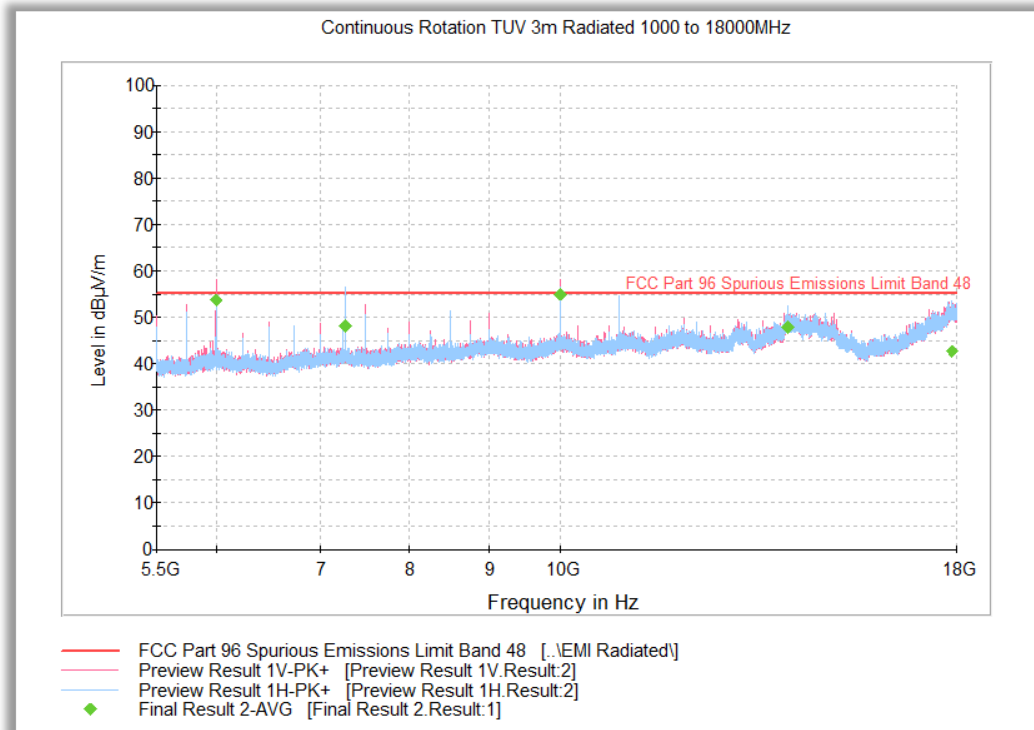
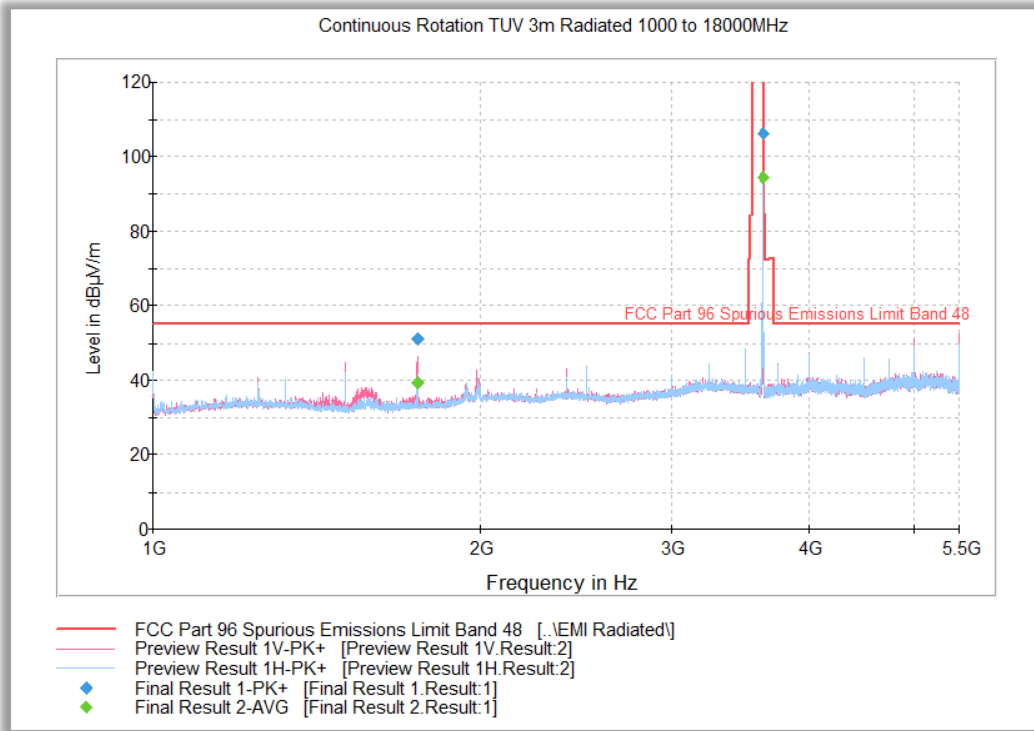



**Average Data**

Frequency (MHz)	Average (dBµV/m)	Meas. Time (ms)	Bandwidth (kHz)	Height (cm)	Polarization	Azimuth (deg)	Corr. (dB)	Peak Margin (dB)	Limit (dBµV/m)
1749.900000	39.3	1000.0	1000.000	226.4	V	20.0	-6.9	15.9	55.2
3635.766667	94.3	1000.0	1000.000	146.7	H	-7.0	-0.2	* Fundamental Freq.	
5999.783333	53.7	1000.0	1000.000	352.7	V	192.0	4.5	1.5	55.2
7271.650000	48.0	1000.0	1000.000	186.5	H	22.0	7.1	7.2	55.2
9999.800000	55.0	1000.0	1000.000	313.1	V	100.0	10.3	0.2	55.2
14000.200000	48.0	1000.0	1000.000	352.7	H	30.0	16.6	7.2	55.2
17882.700000	42.7	1000.0	1000.000	124.7	H	57.0	21.2	12.5	55.2

\* This is the fundamental frequency not part of spurious emission evaluation. Data provided for information purpose only.

**Substitution Data**

Frequency (MHz)	Field Strength @ 3 meters (dBµV/m)	Cable Loss (dB)	Substitution Antenna Gain (dBi)	Signal Generator Level (dBm)	Substitution Data SGL+AG-CL (dBm)	Limit (dBm)	Compliance
5999.783333	53.7	6.4	11.7	-46.9	-41.6	-40	Yes
9999.800000	55.0	9.1	12.2	-43.4	-40.3	-40	Yes





**2.6.13 Radiated Emission Test Results Below 1GHz – Worst Case Band 48 (3650 – 3700 MHz)\_QPSK\_20 MHz BW 1RB 0 offset\_High Channel 3690 MHz**

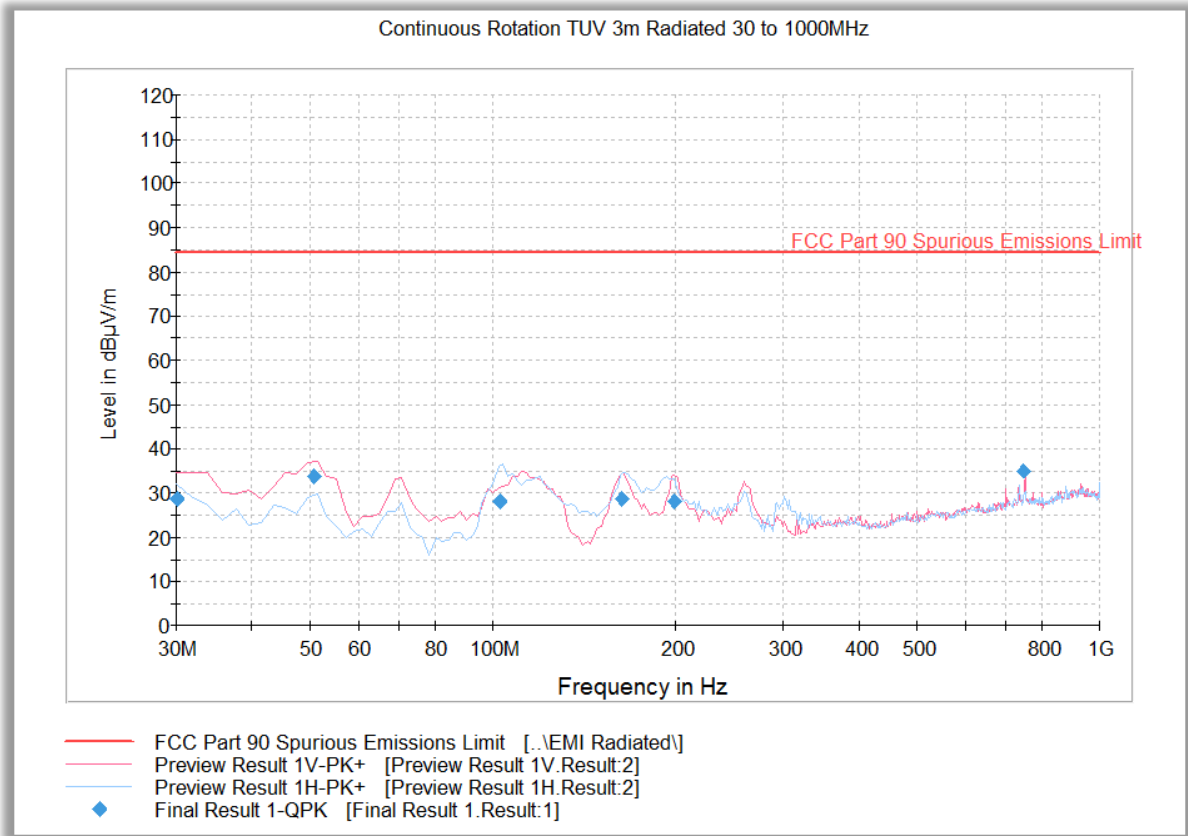

**Quasi Peak Data**

Frequency (MHz)	QuasiPeak (dBµV/m)	Meas. Time (ms)	Bandwidth (kHz)	Height (cm)	Polarization	Azimuth (deg)	Corr. (dB)	Margin (dB)	Limit (dBµV/m)
30.120000	28.8	1000.0	120.000	100.0	V	-4.0	-6.5	55.6	84.4
50.822766	33.9	1000.0	120.000	100.0	V	217.0	-14.9	50.5	84.4
102.827735	28.2	1000.0	120.000	172.0	H	154.0	-14.9	56.2	84.4
162.968257	28.7	1000.0	120.000	100.0	V	324.0	-12.8	55.7	84.4
199.158236	28.1	1000.0	120.000	100.0	V	-8.0	-12.0	56.3	84.4
749.982365	35.2	1000.0	120.000	141.0	V	331.0	4.0	49.2	84.4

**Test Notes:** Only worst case modulation/bandwidth/channel presented for spurious emissions below 1GHz.



**2.6.14 Radiated Emission Test Results Above 1GHz – Worst Case Band 48 (3650 – 3700 MHz)\_QPSK\_20 MHz BW 1RB 0 offset\_Low Channel 3660 MHz**

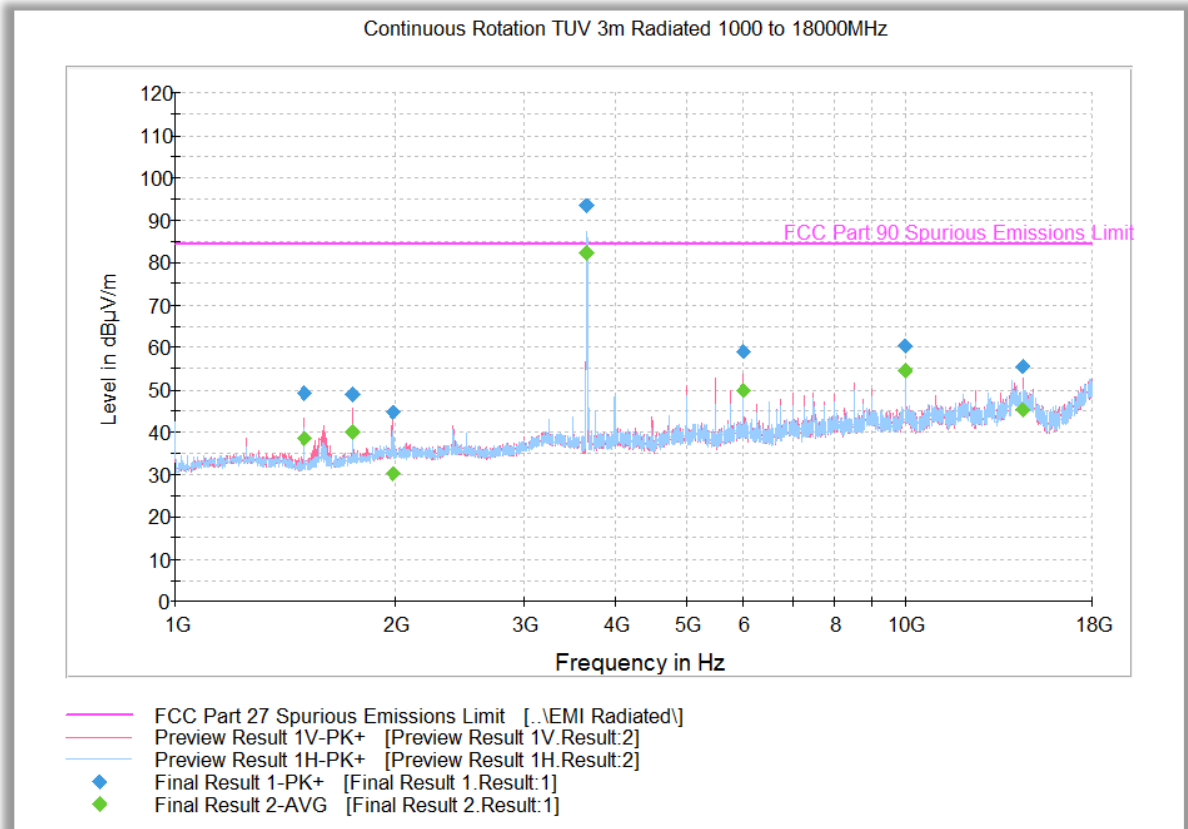

**Peak Data**

Frequency (MHz)	Max Peak (dBµV/m)	Meas. Time (ms)	Bandwidth (kHz)	Height (cm)	Polarization	Azimuth (deg)	Corr. (dB)	Peak Margin (dB)	Limit (dBµV/m)
1500.000000	49.1	1000.0	1000.000	205.5	V	53.0	-9.0	35.3	84.4
1749.900000	48.9	1000.0	1000.000	301.2	V	174.0	-6.9	35.5	84.4
1981.666667	44.7	1000.0	1000.000	302.2	V	51.0	-6.1	39.7	84.4
3653.700000	93.4	1000.0	1000.000	151.6	H	72.0	-0.1	* Fundamental Freq.	
5999.900000	59.0	1000.0	1000.000	307.2	V	220.0	4.5	25.4	84.4
10000.000000	60.2	1000.0	1000.000	352.7	H	150.0	10.3	24.2	84.4
14499.666667	55.6	1000.0	1000.000	291.2	V	52.0	17.5	28.8	84.4

**Average Data**

Frequency (MHz)	Average (dBµV/m)	Meas. Time (ms)	Bandwidth (kHz)	Height (cm)	Polarization	Azimuth (deg)	Corr. (dB)	Peak Margin (dB)	Limit (dBµV/m)
1500.000000	38.4	1000.0	1000.000	205.5	V	53.0	-9.0	46.0	84.4
1749.900000	39.9	1000.0	1000.000	301.2	V	174.0	-6.9	44.5	84.4
1981.666667	30.2	1000.0	1000.000	302.2	V	51.0	-6.1	54.2	84.4
3653.700000	82.3	1000.0	1000.000	151.6	H	72.0	-0.1	* Fundamental Freq.	
5999.900000	49.7	1000.0	1000.000	307.2	V	220.0	4.5	34.7	84.4
10000.000000	54.5	1000.0	1000.000	352.7	H	150.0	10.3	29.9	84.4
14499.666667	45.3	1000.0	1000.000	291.2	V	52.0	17.5	39.1	84.4

\* This is the fundamental frequency not part of spurious emission evaluation. Data provided for information purpose only.



**2.6.15 Radiated Emission Test Results Above 1GHz – Worst Case Band 48 (3650 – 3700 MHz)\_QPSK\_20 MHz BW 1RB 0 offset\_Middle Channel 3675 MHz**

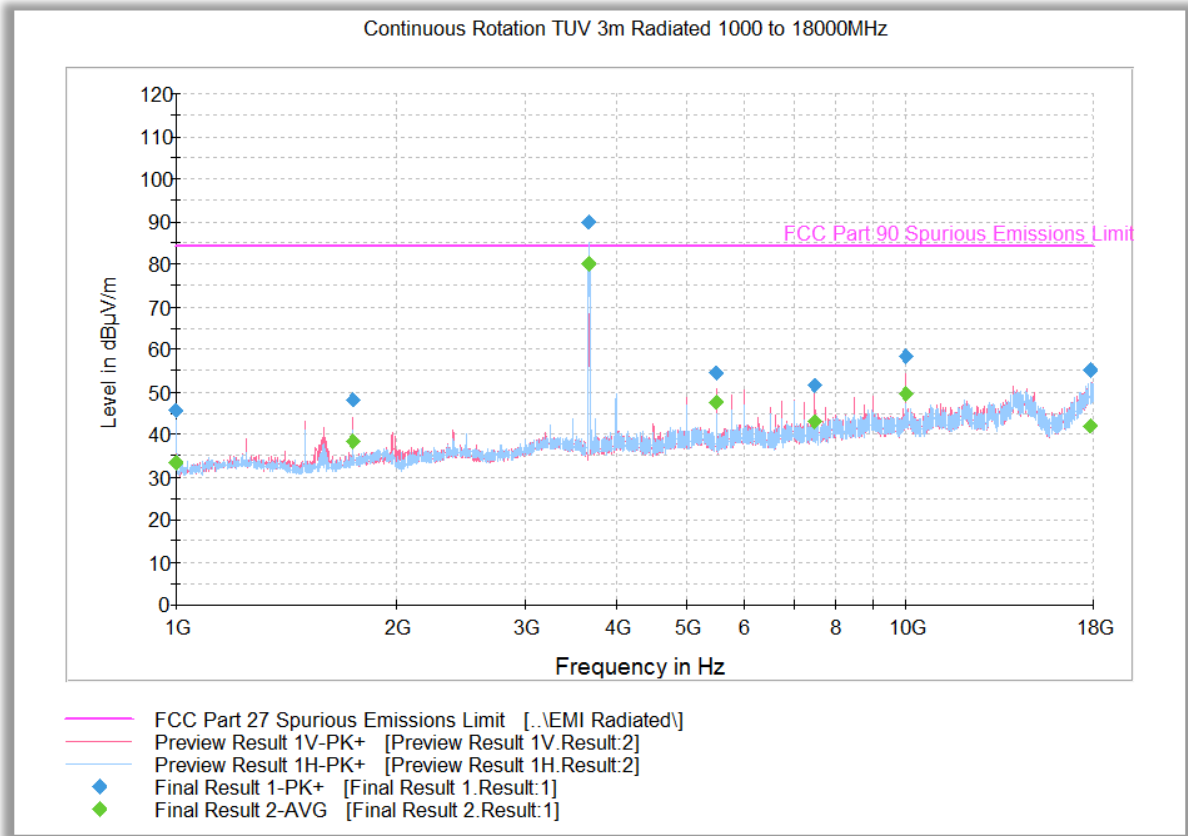

**Peak Data**

Frequency (MHz)	Max Peak (dBµV/m)	Meas. Time (ms)	Bandwidth (kHz)	Height (cm)	Polarization	Azimuth (deg)	Corr. (dB)	Peak Margin (dB)	Limit (dBµV/m)
1000.000000	45.5	1000.0	1000.000	102.7	H	126.0	-10.7	38.9	84.4
1749.900000	48.3	1000.0	1000.000	124.7	V	173.0	-6.9	36.1	84.4
3665.600000	89.7	1000.0	1000.000	250.5	H	350.0	0.0	* Fundamental Freq.	
5500.100000	54.5	1000.0	1000.000	209.4	V	176.0	4.0	29.9	84.4
7499.866667	51.6	1000.0	1000.000	242.3	V	338.0	7.3	32.8	84.4
10000.000000	58.2	1000.0	1000.000	205.4	V	53.0	10.3	26.2	84.4
17810.166667	55.2	1000.0	1000.000	151.2	H	4.0	20.8	29.2	84.4

**Average Data**

Frequency (MHz)	Average (dBµV/m)	Meas. Time (ms)	Bandwidth (kHz)	Height (cm)	Polarization	Azimuth (deg)	Corr. (dB)	Peak Margin (dB)	Limit (dBµV/m)
1000.000000	33.3	1000.0	1000.000	102.7	H	126.0	-10.7	51.1	84.4
1749.900000	38.4	1000.0	1000.000	124.7	V	173.0	-6.9	46.0	84.4
3665.600000	80.0	1000.0	1000.000	250.5	H	350.0	0.0	* Fundamental Freq.	
5500.100000	47.7	1000.0	1000.000	209.4	V	176.0	4.0	36.7	84.4
7499.866667	42.9	1000.0	1000.000	242.3	V	338.0	7.3	41.5	84.4
10000.000000	49.4	1000.0	1000.000	205.4	V	53.0	10.3	35.0	84.4
17810.166667	41.9	1000.0	1000.000	151.2	H	4.0	20.8	42.5	84.4

\* This is the fundamental frequency not part of spurious emission evaluation. Data provided for information purpose only.



**2.6.16 Radiated Emission Test Results Above 1GHz – Worst Case Band 48 (3650 – 3700 MHz)\_QPSK\_20 MHz BW 1RB 0 offset\_Middle Channel 3690 MHz**

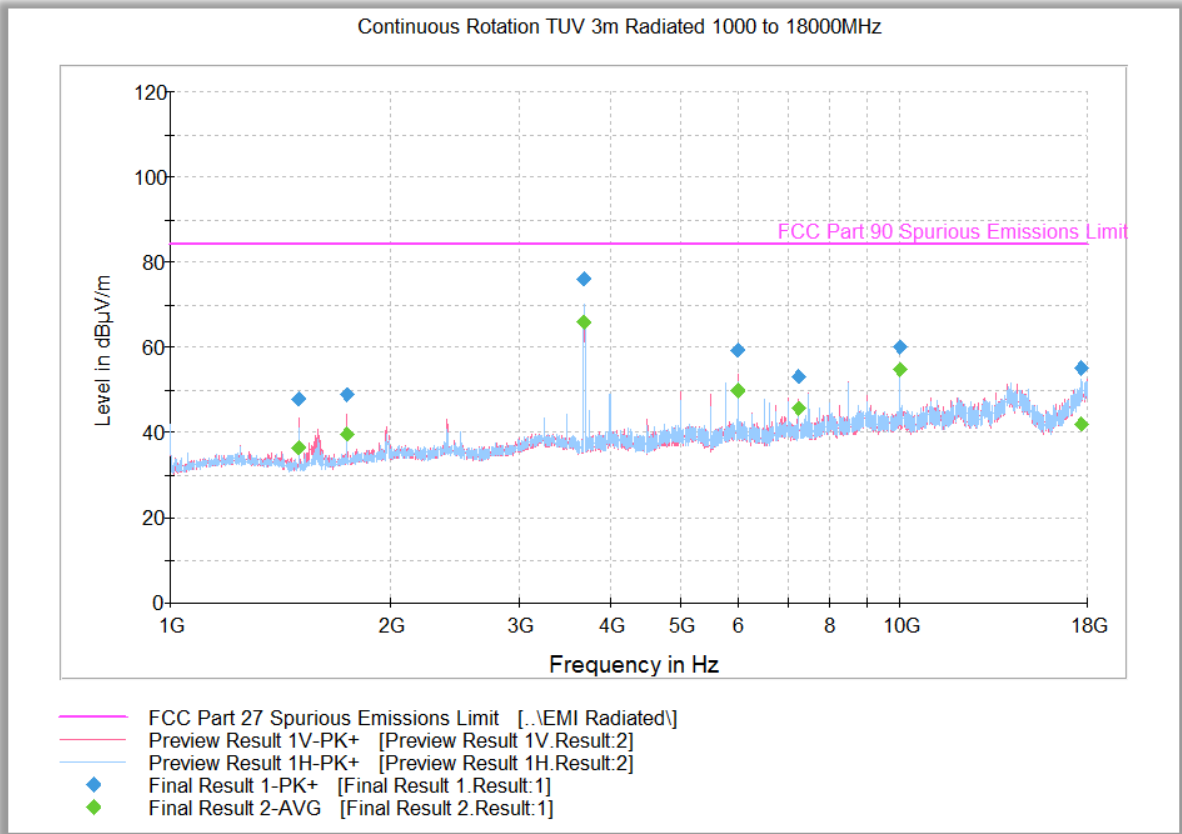

**Peak Data**

Frequency (MHz)	Max Peak (dBµV/m)	Meas. Time (ms)	Bandwidth (kHz)	Height (cm)	Polarization	Azimuth (deg)	Corr. (dB)	Peak Margin (dB)	Limit (dBµV/m)
1500.000000	47.8	1000.0	1000.000	217.4	V	338.0	-9.0	36.6	84.4
1750.066667	48.8	1000.0	1000.000	242.4	V	172.0	-6.9	35.6	84.4
3684.300000	76.2	1000.0	1000.000	143.7	H	-13.0	0.2	* Fundamental Freq.	
6000.100000	59.3	1000.0	1000.000	329.2	V	137.0	4.5	25.1	84.4
7249.566667	53.2	1000.0	1000.000	203.5	V	98.0	7.0	31.2	84.4
10000.000000	60.1	1000.0	1000.000	352.7	H	150.0	10.3	24.3	84.4
17717.833333	55.1	1000.0	1000.000	316.2	H	10.0	20.5	29.3	84.4

**Average Data**

Frequency (MHz)	Average (dBµV/m)	Meas. Time (ms)	Bandwidth (kHz)	Height (cm)	Polarization	Azimuth (deg)	Corr. (dB)	Peak Margin (dB)	Limit (dBµV/m)
1500.000000	36.3	1000.0	1000.000	217.4	V	338.0	-9.0	48.1	84.4
1750.066667	39.6	1000.0	1000.000	242.4	V	172.0	-6.9	44.8	84.4
3684.300000	65.8	1000.0	1000.000	143.7	H	-13.0	0.2	* Fundamental Freq.	
6000.100000	49.7	1000.0	1000.000	329.2	V	137.0	4.5	34.7	84.4
7249.566667	45.4	1000.0	1000.000	203.5	V	98.0	7.0	39.0	84.4
10000.000000	54.7	1000.0	1000.000	352.7	H	150.0	10.3	29.7	84.4
17717.833333	42.1	1000.0	1000.000	316.2	H	10.0	20.5	42.3	84.4

\* This is the fundamental frequency not part of spurious emission evaluation. Data provided for information purpose only.



## **2.7 FREQUENCY STABILITY**

### **2.7.1 Specification Reference**

FCC 47 CFR Part 90, Clause 90.213  
RSS-192, Clause 5.3  
RSS-197, Clause 5.3

### **2.7.2 Standard Applicable**

RSS-192, Clause 5.3  
The carrier frequency shall not depart from the reference frequency in excess of  $\pm 20$  ppm.

RSS-197, Clause 5.3

(a) The frequency offset shall be measured according to the procedure described in RSS-Gen and recorded;

(b) Using a resolution bandwidth of 1% of the occupied bandwidth, a reference point at the unwanted emission level which complies with the attenuation of  $43 + 10 \log_{10} p$  (watts) on the emission mask of the lowest and highest channel shall be selected, and the frequency at these points shall be recorded as  $f_L$  and  $f_H$  respectively.

The applicant shall ensure frequency stability by showing that  $f_L$  minus the frequency offset and  $f_H$  plus the frequency offset shall be within 3650 – 3700 MHz.

### **2.7.3 Equipment Under Test and Modification State**

Serial No: AZ280418A00132 / Test Configuration A

### **2.7.4 Date of Test/Initial of test personnel who performed the test**

June 25 and 29, July 09, 2018 / XYZ

### **2.7.5 Test Equipment Used**

The major items of test equipment used for the above tests are identified in Section 3.1.

### **2.7.6 Environmental Conditions/ Test Location**

Test performed at TÜV SÜD America Inc. Rancho Bernardo facility

Ambient Temperature	24.8 - 27.8 °C
Relative Humidity	39.4 - 49.0 %
ATM Pressure	98.8 - 98.9 kPa



**2.7.7 Additional Observations**

- This is a conducted test. The EUT was operated at 3.7 VDC nominal voltage and was placed in the temperature chamber for this evaluation. The EUT was controlled by a CMW500 and utilizing a spectrum analyser for measurement.
- Test performed in 5 MHz Bandwidth Middle channel as the representative configuration.
- Measurement was done using the CMW 500 measurement function.
- The EUT was tested over the temperature -30°C to +50°C in 10°C steps and allowed to sit for 1 hour to allow the equipment and chamber temperature to stabilize. The measurements were then performed.
- Voltage variation was also performed at voltage 3.3VDC and higher 4.3VDC of the nominal voltage at 20°C.
- The maximum frequency deviation for LTE Band 48 was verified against the frequency band edges using reference points  $F_L$  and  $F_H$  at the unwanted emission level which complies with the attenuation of  $43 + 10 \log_{10} p$  (watts) on the emission mask of the lowest and highest channel.

**2.7.8 Test Results**

LTE Band 48 (3550-3650 MHz) – QPSK 5 MHz BW-Middle Channel 3600 MHz				
Voltage (VDC)	Temperature (°C)	Frequency Error (Hz)	Frequency Error (ppm)	Limit (ppm)
3.7	-30	44.42	0.012	20
	-20	44.76	0.012	20
	-10	43.80	0.012	20
	0	46.35	0.013	20
	+10	44.45	0.012	20
	+20	34.78	0.014	20
	+30	45.98	0.013	20
	+40	42.43	0.012	20
3.3	20	39.54	0.011	20
4.3		39.95	0.011	20

LTE Band 48 (3550-3650 MHz) – QPSK 5 MHz BW						
Voltage (VDC)	Temperature (°C)	$F_L$ (MHz)	$F_L - \text{Freq Error}$ (MHz)	$F_H$ (MHz)	$F_L + \text{Freq Error}$ (MHz)	Compliance
3.7	-30	3550.1427	3550.1427	3649.8988	3649.8988	Yes
	+20	3550.1385	3550.1385	3649.8631	3649.8631	Yes
	+50	3550.1526	3550.1526	3649.8866	3649.8866	Yes
3.3	20	3550.1941	3550.1941	3649.8631	3649.8631	Yes
4.3		3550.1552	3550.1552	3649.9086	3649.9086	Yes



LTE Band 48 (3650-3700 MHz) – QPSK 5 MHz BW-Middle Channel 3675 MHz			
Voltage (VDC)	Temperature (°C)	Frequency Error (Hz)	Frequency Error (ppm)
3.7	-30	45.09	0.012
	-20	46.53	0.013
	-10	48.09	0.013
	0	51.13	0.014
	+10	47.31	0.013
	+20	44.98	0.012
	+30	46.23	0.013
	+40	44.59	0.012
3.3	20	40.91	0.011
4.3		43.09	0.012

LTE Band 48 (3650-3700 MHz) – QPSK 5 MHz BW						
Voltage (VDC)	Temperature (°C)	F <sub>L</sub> (MHz)	F <sub>L</sub> – Freq Error (MHz)	F <sub>H</sub> (MHz)	F <sub>L</sub> + Freq Error (MHz)	Compliance
3.7	-30	3650.1261	3650.1260	3699.857	3699.8571	Yes
	+20	3650.1177	3650.1176	3699.8762	3699.8763	Yes
	+50	3650.1350	3650.1349	3699.8528	3699.8529	Yes
3.3	20	3650.1064	3650.1063	3699.8716	3699.8717	Yes
4.3		3650.0892	3650.0891	3699.8608	3699.8609	Yes

### 2.7.9 Sample Test Results

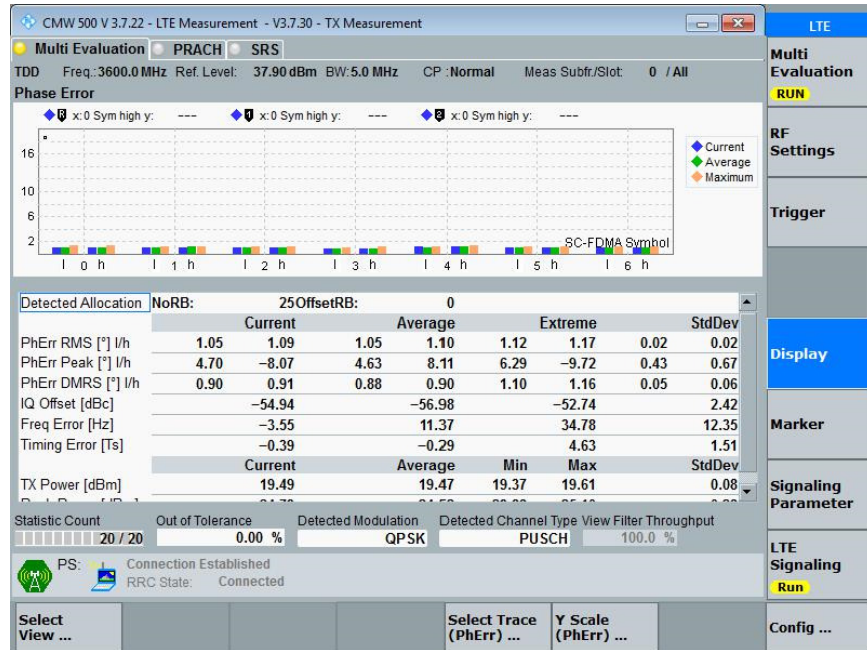

LTE Band 48 (3550-3650 MHz) – QPSK 5 MHz BW-Middle Channel 3600 MHz at Normal Voltage 20°C

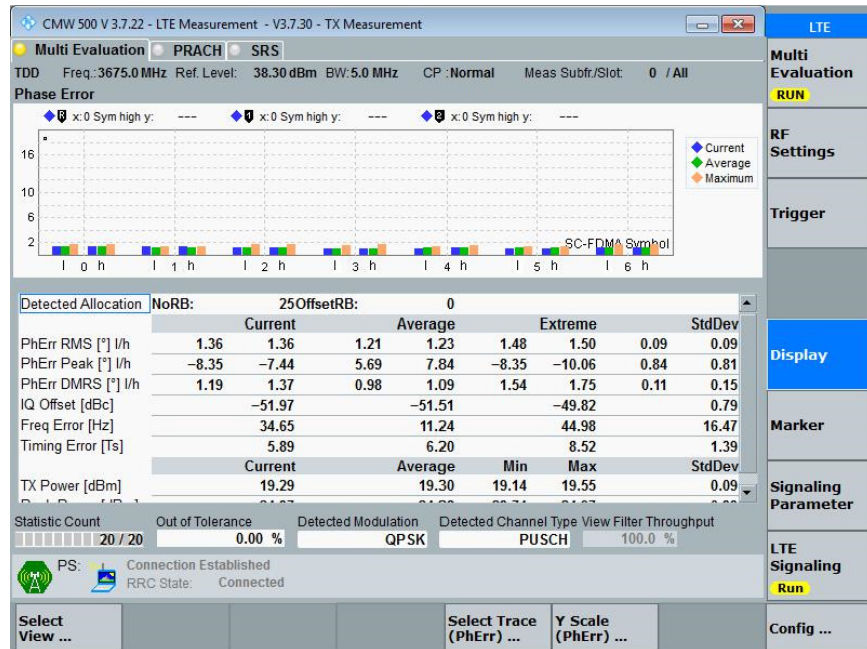

LTE Band 48 (3650-3700 MHz) – QPSK 5 MHz BW-Middle Channel 3675 MHz at Normal Voltage 20°C



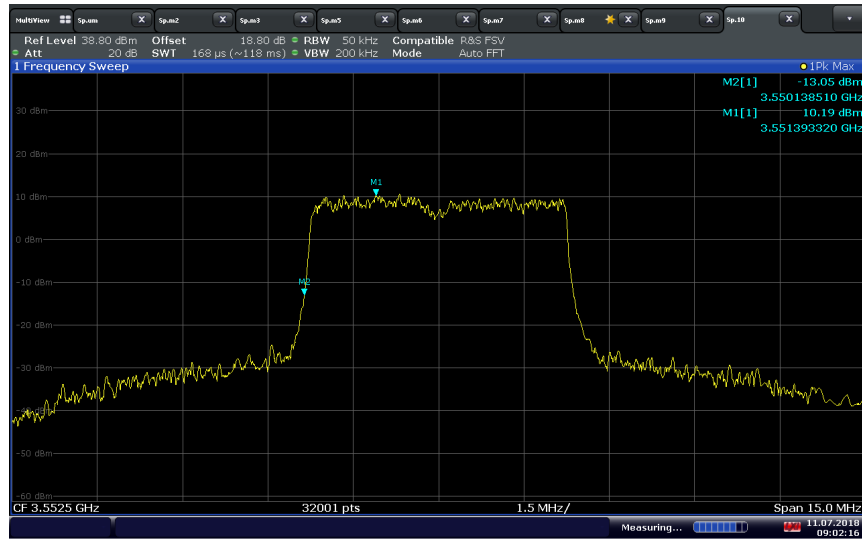

09:02:16 11.07.2018

**Band 48 (3550-3650 MHz) – QPSK 5 MHz BW Low Channel  $F_L$  at Normal Voltage 20°C**

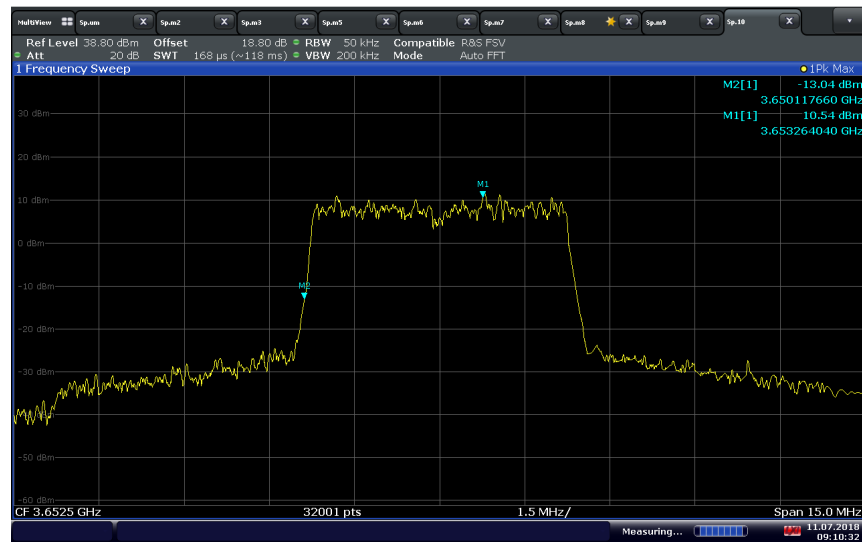

09:10:32 11.07.2018

**LTE Band 48 (3650-3700 MHz) – QPSK 5 MHz BW Low Channel  $F_L$  at Normal Voltage 20°C**



## **2.8 RECEIVER SPURIOUS EMISSIONS**

### **2.8.1 Specification Reference**

RSS-192, Clause 5.6  
RSS-197, Clause 5.8  
RSS-GEN, Clause 7.4

### **2.8.2 Standard Applicable**

RSS-192, Clause 5.6  
Receiver spurious emissions shall not exceed -10 dBW/MHz below 21.2 GHz, and -60 dBW/MHz above 21.2 GHz at the antenna connector. A spectrum analyzer resolution bandwidth of 100 kHz shall be used to measure spurious emissions for emissions below 1.0 GHz, and a bandwidth of 1.0 MHz shall be used for emissions above 1.0 GHz.

RSS-197, Clause 5.8  
Receiver spurious emissions shall comply with the limit specified in RSS-Gen.

RSS-Gen, Clause 7.4

The spurious emissions from the receiver at any discrete frequency, measured at the antenna port by the antenna-conducted method, shall not exceed 2 nW (-57dBm) in the frequency range 30-1000 MHz and 5 nW (-53dBm) above 1 GHz.

### **2.8.3 Equipment Under Test and Modification State**

Serial No: AZ280418A00132 / Test Configuration C

### **2.8.4 Date of Test/Initial of test personnel who performed the test**

July 26, 2018 / XYZ

### **2.8.5 Test Equipment Used**

The major items of test equipment used for the above tests are identified in Section 3.1.

### **2.8.6 Environmental Conditions/ Test Location**

Test performed at TÜV SÜD America Inc. Rancho Bernardo facility

Ambient Temperature	25.9 °C
Relative Humidity	56.1 %
ATM Pressure	99.7 kPa

### **2.8.7 Additional Observations**

- This is a conducted test. The spectrum was searched from 30MHz to the 26.5GHz.
- Test performed on RX only antenna port of the EUT.

### 2.8.8 Test Results

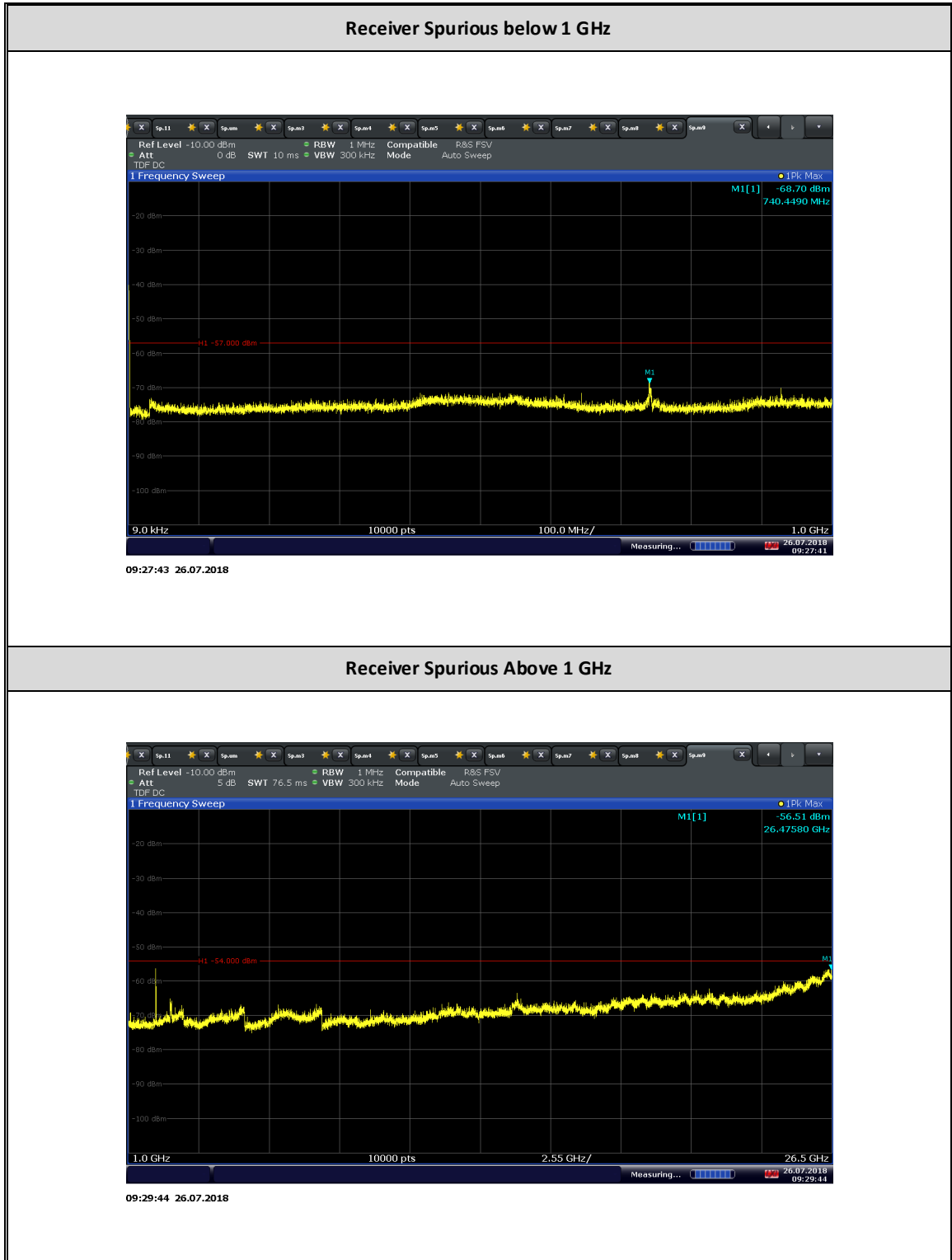



**2.9 CONDUCTED EMISSIONS**

**2.9.1 Specification Reference**

FCC CFR 47 Part 15, Clause 15.207(a)  
 RSS-Gen, Section 8.8

**2.9.2 Standard Applicable**

An intentional radiator that is designed to be connected to the public utility (AC) power line, the radio frequency voltage that is conducted back onto the AC power line on any frequency or frequencies, within the band 150 kHz to 30 MHz, shall not exceed the limits in the following table, as measured using a 50  $\mu$ H/50 ohms line impedance stabilization network (LISN).

Frequency of emission (MHz)	Conducted limit (dB $\mu$ V)	
	Quasi-peak	Average
0.15–0.5	66 to 56*	56 to 46*
0.5–5	56	46
5–30	60	50

*\*Decreases with the logarithm of the frequency.*

**2.9.3 Equipment Under Test and Modification State**

Serial No: AZ280418A00132/Test Configuration B

**2.9.4 Date of Test/Initial of test personnel who performed the test**

July 16, 2018/XYZ

**2.9.5 Test Equipment Used**

The major items of test equipment used for the above tests are identified in Section 3.1.

**2.9.6 Environmental Conditions/ Test Location**

Test performed at TÜV SÜD America Inc. Rancho Bernardo facility

Ambient Temperature 25.1 °C  
 Relative Humidity 53.7 %  
 ATM Pressure 99.0 kPa

**2.9.7 Additional Observations**

Measurement was done using EMC32 V8.53 automated software. Reported level is the actual level with all the correction factors factored in. Correction Factor column is for informational purposes only. See Section 2.1.8 for sample computation.



**2.9.8 Sample Computation (Conducted Emission – Quasi Peak)**

Measuring equipment raw measurement (db $\mu$ V) @ 150kHz		5.5
Asset# 8607 (20 dB attenuator)	19.9	
Correction Factor (dB)	Asset# 1177 (cable)	0.15
	Asset# 1176 (cable)	0.35
	Asset# 7568 (LISN)	0.30
<b>Reported QuasiPeak Final Measurement (db<math>\mu</math>V) @ 150kHz</b>		<b>26.2</b>

**2.9.9 Test Results**

**Compliant.** See attached plots and tables.

**2.9.10 MIFI8800L 120VAC 60Hz (Line 1)**

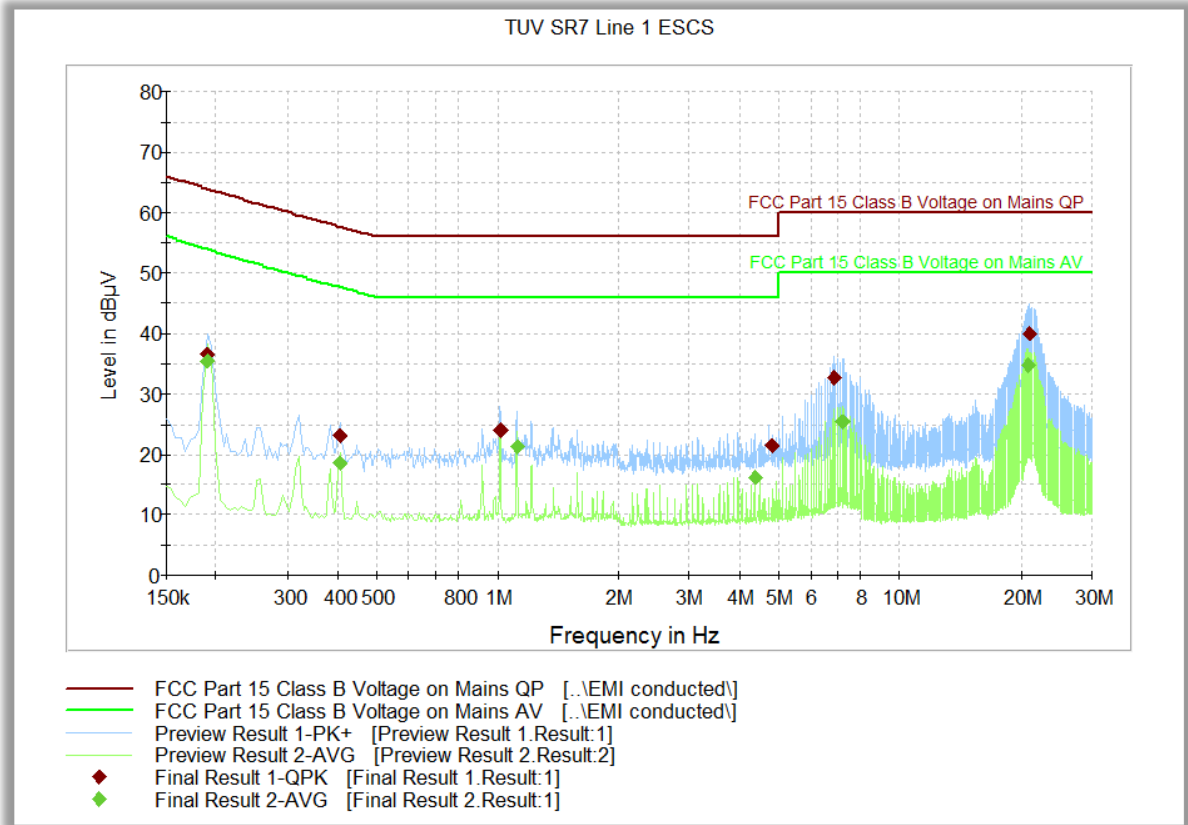

**Quasi Peak**

Frequency (MHz)	QuasiPeak (dBµV)	Meas. Time (ms)	Bandwidth (kHz)	Filter	Line	Corr. (dB)	Margin - QPK (dB)	Limit - QPK (dBµV)
0.190500	36.6	1000.0	9.000	Off	L1	20.2	27.3	63.9
0.406500	23.1	1000.0	9.000	Off	L1	20.2	34.6	57.6
1.018500	23.9	1000.0	9.000	Off	L1	20.2	32.1	56.0
4.830000	21.4	1000.0	9.000	Off	L1	20.4	34.6	56.0
6.900000	32.6	1000.0	9.000	Off	L1	20.5	27.4	60.0
20.998500	40.1	1000.0	9.000	Off	L1	20.8	19.9	60.0

**Average**

Frequency (MHz)	Average (dBµV)	Meas. Time (ms)	Bandwidth (kHz)	Filter	Line	Corr. (dB)	Margin - Ave (dB)	Limit - Ave (dBµV)
0.190500	35.4	1000.0	9.000	Off	L1	20.2	18.4	53.9
0.406500	18.6	1000.0	9.000	Off	L1	20.2	29.0	47.6
1.117500	21.3	1000.0	9.000	Off	L1	20.2	24.7	46.0
4.366500	16.2	1000.0	9.000	Off	L1	20.4	29.8	46.0
7.197000	25.4	1000.0	9.000	Off	L1	20.5	24.6	50.0
20.800500	34.7	1000.0	9.000	Off	L1	20.7	15.3	50.0

**2.9.11 MIFI8800L 120VAC 60Hz (Line 2)**

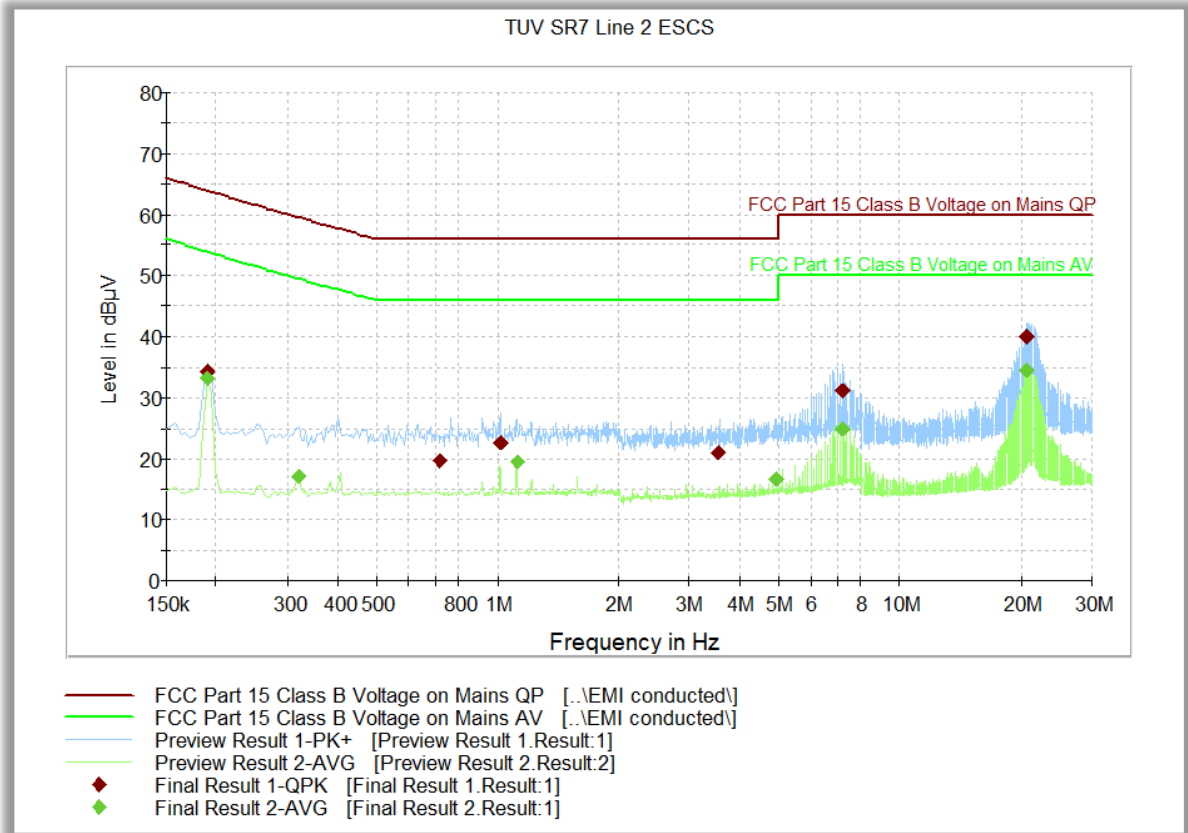

**Quasi Peak**

Frequency (MHz)	QuasiPeak (dBµV)	Meas. Time (ms)	Bandwidth (kHz)	Filter	Line	Corr. (dB)	Margin - QPK (dB)	Limit - QPK (dBµV)
0.190500	34.3	1000.0	9.000	Off	N	20.2	29.6	63.9
0.717000	19.5	1000.0	9.000	Off	N	20.2	36.5	56.0
1.018500	22.7	1000.0	9.000	Off	N	20.2	33.3	56.0
3.547500	21.0	1000.0	9.000	Off	N	20.4	35.0	56.0
7.197000	31.0	1000.0	9.000	Off	N	20.4	29.0	60.0
20.701500	39.9	1000.0	9.000	Off	N	20.7	20.1	60.0

**Average**

Frequency (MHz)	Average (dBµV)	Meas. Time (ms)	Bandwidth (kHz)	Filter	Line	Corr. (dB)	Margin - Ave (dB)	Limit - Ave (dBµV)
0.190500	33.1	1000.0	9.000	Off	N	20.2	20.8	53.9
0.321000	17.1	1000.0	9.000	Off	N	20.3	32.4	49.5
1.117500	19.5	1000.0	9.000	Off	N	20.3	26.5	46.0
4.929000	16.6	1000.0	9.000	Off	N	20.5	29.4	46.0
7.197000	24.9	1000.0	9.000	Off	N	20.4	25.1	50.0
20.701500	34.4	1000.0	9.000	Off	N	20.7	15.6	50.0



### **SECTION 3**

#### **TEST EQUIPMENT USED**





### 3.1 TEST EQUIPMENT USED

List of absolute measuring and other principal items of test equipment.

ID Number (SDGE/SDRB)	Test Equipment	Type	Serial Number	Manufacturer	Cal Date	Cal Due Date
<b>Antenna Conducted Port Setup</b>						
7662	P-Series Power Meter	N1911A	MY45100951	Agilent	06/15/18	06/15/19
7661	50MHz-18GHz Wideband Power Sensor	N1921A	MY45241383	Agilent	06/15/18	06/15/19
7608	Vector Signal Generator	SMBV100A	259021	Rhode & Schwarz	09/19/17	09/19/19
7582	Signal/Spectrum Analyzer	FSW26	101614	Rhode & Schwarz	12/14/17	12/14/18
-	Wideband Radio Communication Tester	CMW 500	158164	Rhode & Schwarz	04/04/18	04/04/19
8825	20dB Attenuator	46-20-34	BK5773	Weinschel Corp.	Verified by 7608 and 7582	
-	10dB Attenuator	VAT-10W2+2W	N/A	MCL	Verified by 7608 and 7582	
<b>AC Conducted Emissions Test Setup</b>						
1024	EMI Test Receiver	ESCS 30	847793/001	Rhode & Schwarz	09/15/17	09/15/18
7567	LISN	FCC-USN-50-25-2	120304	Fischer Custom Comm.	12/14/17	12/14/19
8822	20dB Attenuator	34-20-34	N/A	MCE / Weinschel	Verified by 7608 and 7582	
8824	20dB Attenuator	34-20-34	N/A	MCE / Weinschel	Verified by 7608 and 7582	
7582	Signal/Spectrum Analyzer	FSW26	101614	Rhode & Schwarz	12/14/17	12/14/18
7608	Vector Signal Generator	SMBV100A	259021	Rhode & Schwarz	09/19/17	09/19/19
-	Wideband Radio Communication Tester	CMW 500	158164	Rhode & Schwarz	04/04/18	04/04/19
<b>Radiated Test Setup</b>						
7582	Signal/Spectrum Analyzer	FSW26	101614	Rhode & Schwarz	12/14/17	12/14/18
7608	Vector Signal Generator	SMBV100A	259021	Rhode & Schwarz	09/19/17	09/19/19
1033	BiLog Antenna	3142C	00044556	EMCO	10/11/16	10/11/18
7575	Double-ridged waveguide horn antenna	3117	00155511	EMCO	06/16/18	06/16/20
1193	Pre-amplifier	PAM-0202	185	A.H. Systems, Inc.	04/11/18	04/11/19
8921	High-frequency cable	SuøFlex 100 SX	N/A	Suhner	Verified by 7608 and 7582	
8923	High-frequency cable	Micropore 19057793	N/A	United Microwave Products	Verified by 7608 and 7582	
1040	EMI Test Receiver	ESIB 40	100292	Rhode & Schwarz	10/25/17	10/25/18
1049	EMI Test Receiver	ESU	100133	Rhode & Schwarz	07/13/18	07/13/19
8628	Pre-amplifier	QLI-01182835-JO	8986002	Quinstar	02/06/18	02/06/19
-	Wideband Radio Communication Tester	CMW 500	158164	Rhode & Schwarz	04/04/18	04/04/19



Miscellaneous						
6708	Multimeter	34401A	US36086974	Hewlett Packard	07/05/17	07/05/18
7579	Temperature Chamber	115	151617	TestQuity	08/22/17	08/22/18
11312	Mini Environmental Quality Meter	850027	CF099-56010-340	SperScientific	02/26/18	02/26/19
	Test Software	EMC32	V8.53	Rhode & Schwarz	N/A	



### 3.2 MEASUREMENT UNCERTAINTY

For a 95% confidence level, the measurement uncertainties for defined systems are:

#### 3.2.1 Radiated Emission Measurements (Below 1GHz)

	Contribution	Probability Distribution Type	Probability Distribution $\kappa$	Standard Uncertainty $u(\%)$	$[u(\%)^2]$
1	Receiver/Spectrum Analyzer	Rectangular	0.45	0.26	0.07
2	Cables	Rectangular	0.50	0.29	0.08
3	Pre amp	Rectangular	0.50	0.29	0.08
4	Antenna	Rectangular	0.75	0.43	0.19
5	Site	Rectangular	3.52	1.44	2.07
6	EUT Setup	Rectangular	1.00	0.58	0.33
Combined Uncertainty (u <sub>c</sub> ):					1.68
Coverage Factor (k):					2
Expanded Uncertainty:					3.36

#### 3.2.2 Radiated Emission Measurements (Above 1GHz)

	Contribution	Probability Distribution Type	Probability Distribution $\kappa$	Standard Uncertainty $u(\%)$	$[u(\%)^2]$
1	Receiver/Spectrum Analyzer	Rectangular	0.57	0.33	0.11
2	Cables	Rectangular	0.70	0.40	0.16
3	Pre amp	Rectangular	0.50	0.29	0.08
4	Antenna	Rectangular	0.37	0.21	0.05
5	Site	Rectangular	3.00	1.22	1.50
6	EUT Setup	Rectangular	1.00	0.58	0.33
Combined Uncertainty (u <sub>c</sub> ):					1.49
Coverage Factor (k):					2
Expanded Uncertainty:					2.99

#### 3.2.3 Conducted Antenna Port Measurement

	Contribution	Probability Distribution Type	Probability Distribution $\kappa$	Standard Uncertainty $u(\%)$	$[u(\%)^2]$
1	Receiver/Spectrum Analyzer	Rectangular	0.34	0.20	0.04
2	Cables	Rectangular	0.30	0.17	0.03
3	EUT Setup	Rectangular	0.50	0.29	0.08
Combined Uncertainty (u <sub>c</sub> ):					0.39
Coverage Factor (k):					1.96
Expanded Uncertainty:					0.76



## SECTION 4

### DIAGRAM OF TEST SETUP

#### 4.1 TEST SETUP DIAGRAM

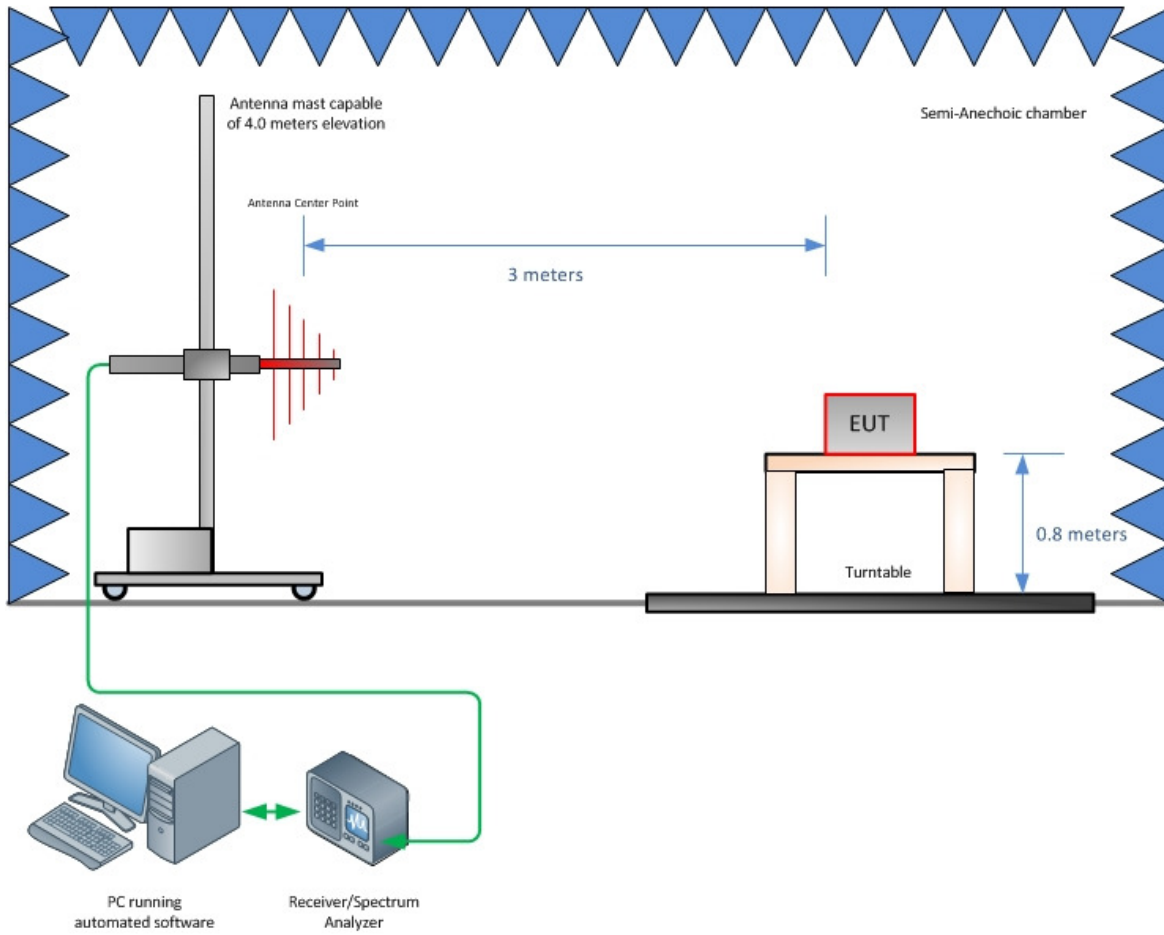

**Radiated Emission Test Setup (Below 1GHz)**

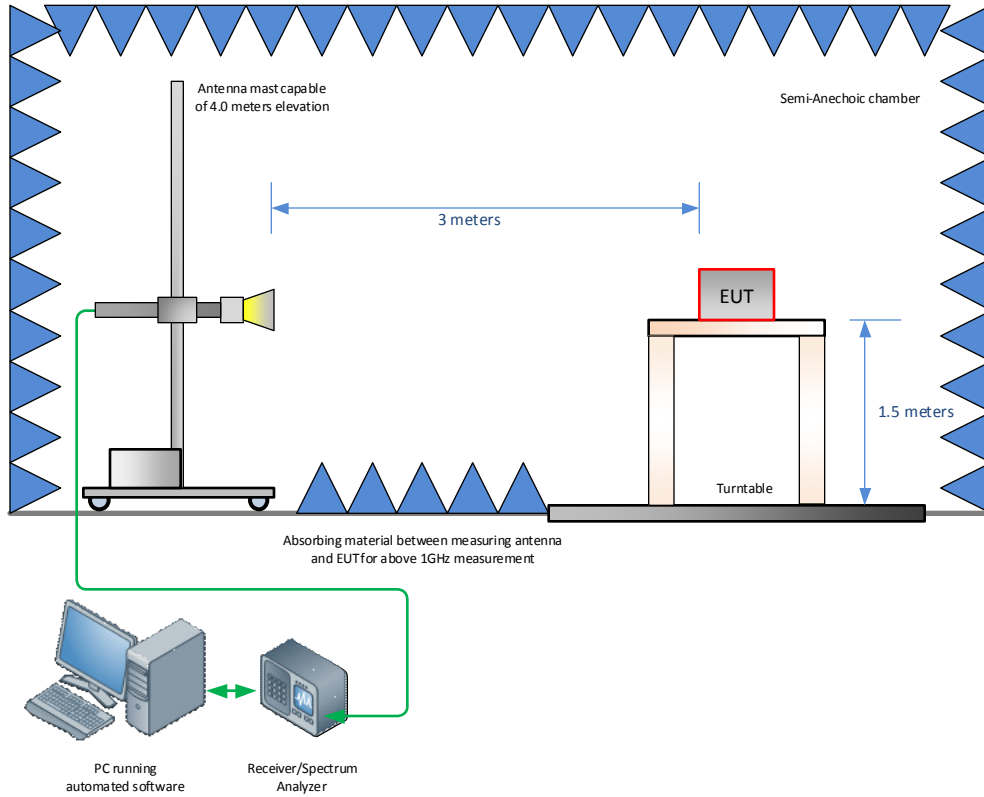

**Radiated Emission Test Setup (Above 1GHz)**

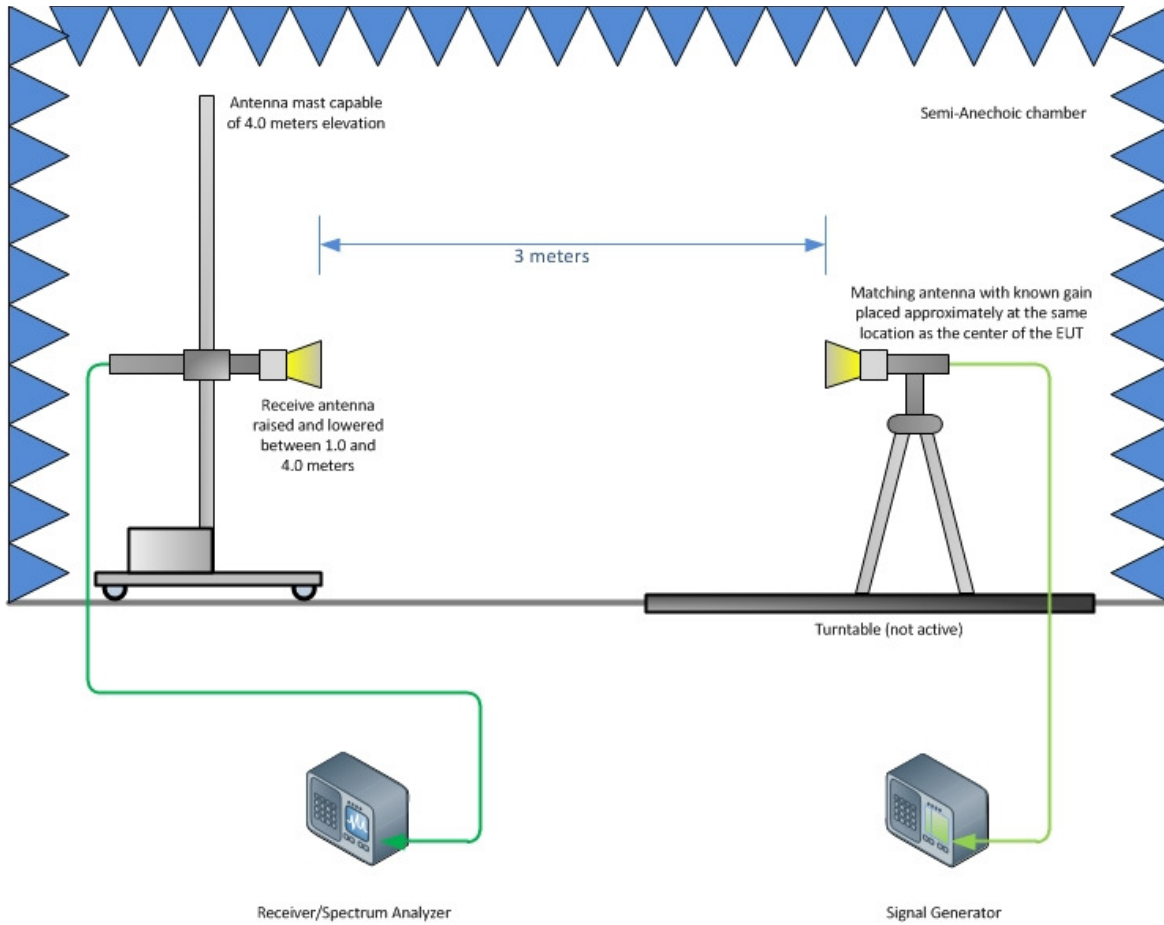

**Substitution Test Method (Above 1GHz)**

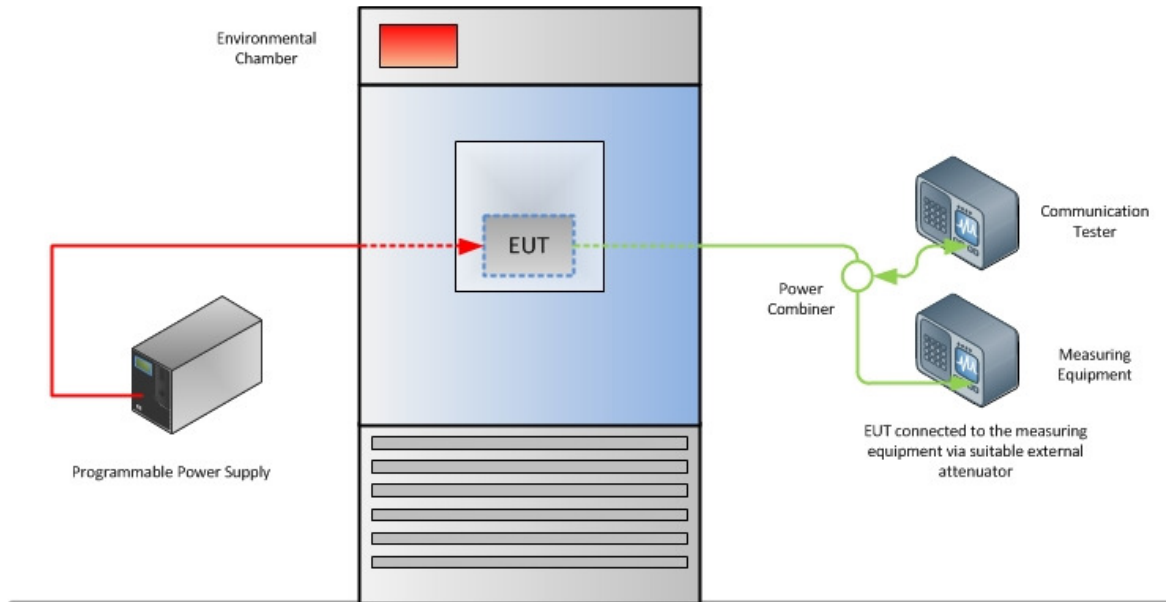

**Frequency Stability Test Configuration**





## SECTION 5

### ACCREDITATION, DISCLAIMERS AND COPYRIGHT



## 5.1 ACCREDITATION, DISCLAIMERS AND COPYRIGHT

TÜV SÜD America Inc.'s reports apply only to the specific sample tested under stated test conditions. It is the manufacturer's responsibility to assure the continued compliance of production units of this model. TÜV SÜD America, Inc. shall have no liability for any deductions, inferences or generalizations drawn by the client or others from TÜV SÜD America, Inc.'s issued reports.

This report is the confidential property of the client. As a mutual protection to our clients, the public and TÜV SÜD America, Inc., extracts from the test report shall not be reproduced, except in full without TÜV SÜD America, Inc.'s written approval.

This report must not be used to claim product certification, approval, or endorsement by A2LA, NIST, or any agency of the federal government.

TÜV SÜD America, Inc. and its professional staff hold government and professional organization certifications for AAMI, ACIL, AEA, ANSI, IEEE, A2LA, NIST and VCCI.

