



**Choose certainty.
Add value.**

Report On

Application for Grant of Equipment Authorization of the
Novatel Wireless Inc.

MIFI8800L Wireless Hotspot Modem

FCC CFR 47 Part 2, 24 and 27

RSS-133 Issue 6 January 2018

RSS-139 Issue 3 July 2015

RSS-130 Issue 1 October 2013

Report No. 72139211G

August 2018



REPORT ON Radio Testing of the
Novatel Wireless Inc.
MIFI8800L Wireless Hotspot Modem

TEST REPORT NUMBER 72139211G

PREPARED FOR Novatel Wireless Inc.
9605 Scranton Road, Suite 300
San Diego, CA 92121
USA

CONTACT PERSON Roman Olmos
Senior Regulatory Engineer
(858) 812-3400
rolmos@nvtl.com

PREPARED BY 
Xiaoying Zhang
Name
Authorized Signatory
Title: EMC/Wireless Test Engineer

APPROVED BY 
Ferdinand S. Custodio
Name
Authorized Signatory
Title: Senior EMC Test Engineer/Wireless Team Lead

DATED August 27, 2018



Revision History

72139211G Novatel Wireless Inc. MIFI8800L Wireless Hotspot Modem					
DATE	OLD REVISION	NEW REVISION	REASON	PAGES AFFECTED	APPROVED BY
08/27/2018	Initial Release				Ferdinand S. Custodio



CONTENTS

Section		Page No
1	REPORT SUMMARY.....	5
1.1	Introduction.....	6
1.2	Brief Summary of Results.....	8
1.3	Product Information.....	9
1.4	Eut Test Configuration.....	11
1.5	Deviations from the Standard.....	14
1.6	Modification Record.....	14
1.7	Test Methodology.....	14
1.8	Test Facility Location.....	14
1.9	Test Facility Registration.....	14
1.10	Sample Calculations.....	16
2	TEST DETAILS.....	17
2.1	Transmitter Conducted Power Measurements.....	18
2.2	Effective Isotropic Radiated Power and Power Spectral Density.....	24
2.3	Peak-Average Ratio.....	29
2.4	Occupied Bandwidth.....	36
2.5	Band Edge.....	45
2.6	Conducted Spurious Emissions.....	56
2.7	Field Strength of Spurious Radiation.....	70
2.8	Frequency Stability.....	78
2.9	Conducted Emissions.....	83
3	TEST EQUIPMENT USED.....	87
3.1	Test Equipment Used.....	88
3.2	Measurement Uncertainty.....	90
4	DIAGRAM OF TEST SETUP.....	91
4.1	Test Setup Diagram.....	92
5	ACCREDITATION, DISCLAIMERS AND COPYRIGHT.....	96
5.1	Accreditation, Disclaimers and Copyright.....	97



SECTION 1

REPORT SUMMARY

Radio Testing of the
Novatel Wireless Inc.
MIFI8800L Wireless Hotspot Modem



1.1 INTRODUCTION

The information contained in this report is intended to show verification of the Novatel Wireless Inc. MIFI8800L Wireless Hotspot Modem to the requirements of the following:

- FCC CFR 47 Part 2, 24 and 27
- RSS-Gen Issue 5 April 2018
- RSS-133 Issue 6 January 2018
- RSS-139 Issue 3 July 2015
- RSS-130 Issue 1 October 2013

Objective	To perform Radio Testing to determine the Equipment Under Test's (EUT's) compliance with the Test Specification, for the series of tests carried out.
Manufacturer	Novatel Wireless Inc.
Product Trademark/Brand	Inseego
Product Marketing Name	MiFi 8800L
Model Number(s)	MIFI8800L
FCC ID Number	PKRNVWMIFI8800
IC Number	3229A-MIFI8800
Serial Number(s)	AZ280418A00044
Number of Samples Tested	1
Test Specification/Issue/Date	<ul style="list-style-type: none">• FCC CFR 47 Part 2, 24 and 27 (October 1, 2017)• RSS-133 Issue 6 January 2018: 2 GHz Personal Communications Services• RSS-139 Issue 3 July 2015 – Advanced Wireless Services (AWS) Equipment Operating in the Bands 1710-1780 MHz and 2110-2180 MHz• RSS-130 Issue 1 October 2013 – Mobile Broadband Services (MBS) Equipment Operating in the Frequency Bands 698-756 MHz and 777-787 MHz• RSS-Gen Issue 5: April 2018 - General Requirements for Compliance of Radio Apparatus• ANSI C63.26-2015: American National Standard for Compliance Testing of Transmitters Used in Licensed Radio Services
Start of Test	June 25, 2018
Finish of Test	August 02, 2018
Name of Engineer(s)	Xiaoying Zhang



America

Related Document(s)

- 3GPP TS 36.521 Version 14.4.0 Release 14: Evolved Universal Terrestrial Radio Access (E-UTRA); User Equipment (UE) Conformance Specification Radio Transmission and Reception; Part 1: Conformance Testing
- 3GPP TS 36.508 Version 14.4.0 Release 14: Evolved Universal Terrestrial Radio Access (E-UTRA) and Evolved Packet Core (EPC); Common Test Environments for User Equipment (UE) Conformance Testing
- Supporting documents for EUT certification are separate exhibits.



1.2 BRIEF SUMMARY OF RESULTS

A brief summary of the tests carried out in accordance with FCC CFR 47 Part 2, 24 and 27 with cross-reference to the corresponding ISED RSS standard is shown below.

Section	FCC Part Sections(s)	RSS Section(s)	Test Description	Result
2.1	2.1046	-	Transmitter Conducted Output Power	Compliant
2.2	2.1046 2.232(C) 27.50 (h)(2)	RSS-133 (6.4) RSS-139 (6.5) RSS-130 (4.4)	Effective Isotropic Radiated Power	Compliant
2.3	27.50 (b)(10)	-	Peak-Average Ratio	Compliant
2.4	2.1049 24.238(b) 27.53(h)(3)	RSS-Gen (6.7)	Occupied Bandwidth	Compliant
2.5	2.1051 24.238(a)(b) 27.53(h)(1)(3) 27.53(c)(2)(5)	RSS-133 (6.5) RSS-139 (6.6) RSS-130 (4.6)	Band Edge	Compliant
2.6	2.1051 24.238(a)(b) 27.53(h)(1)(3) 27.53(c)(2)(4)(5)(f)	RSS-133 (6.5) RSS-139 (6.6) RSS-130 (4.6)	Conducted Spurious Emissions	Compliant
2.7	2.1053 24.238(a) 27.53(h) 27.53(c)	RSS-133 (6.5) RSS-139 (6.6) RSS-130 (4.6)	Field Strength of Spurious Radiation	Compliant
2.8	2.1055 24.235 27.54	RSS-133 (6.3) RSS-139 (6.4) RSS-130 (4.3)	Frequency Stability	Compliant
-	-	RSS-Gen 7.4	Receiver Spurious Emissions	N/A*
2.9	-	RSS-Gen (8.8)	Power Line Conducted Emissions	Compliant

N/A* Not Applicable. No stand-alone receiver.



1.3 PRODUCT INFORMATION

1.3.1 EUT General Description

The Equipment Under Test (EUT) was a Novatel Wireless Inc. MIFI8800L Wireless Hotspot Modem. The EUT is a Wireless Hotspot Modem supporting 2G/3G/4G Technologies. The EUT comes with a USB Port.

1.3.2 Technical Description

EUT Description	Wireless Hotspot Modem
Product Marketing Name	MiFi 8800L
Model Number(s)	MIFI8800L
Rated Voltage	3.8V, 4500mAh (Rechargeable Li-Ion battery pack) Input 100-240VAC, Output 5V (External AC-DC Power Adapter)
Mode Verified	UL Carrier Aggregation: CA_2A-13A, CA_4A-13A, CA_13A-66A
Capability	WCDMA Band 2, 5, LTE Band 2, 4, 5, 7, 13, 14, 46, 48, 66 and 802.11 a/b/g/n/ac
Primary Unit (EUT)	<input checked="" type="checkbox"/> Production <input type="checkbox"/> Pre-Production <input type="checkbox"/> Engineering
Manufacturer declared Rated Power	23 dBm

(Client declaration, max. antenna gain covered under this test report)

LTE Bands	Frequency Range	Antenna Gains
Band 2	1850 – 1910 MHz	0.5 dBi
Band 4	1710 – 1755 MHz	0.0 dBi
Band 13	777 – 787 MHz	-0.6 dBi
Band 66	1710 – 1780 MHz	0.0 dBi



1.3.3 Transmit Frequency Table

Carrier Aggregation					
Mode	Modulation	Bandwidth (MHz)	Tx Frequency (MHz)	EIRP	
				Max Power (dBm)	Max Power (Watts)
CA_2A-13A	QPSK	10 + 10	1880 + 782	23.66	0.23
	16QAM		782 + 1880	23.85	0.24
	64QAM		782 + 1880	23.63	0.23
CA_4A-13A	QPSK	10 + 10	1750 + 782	23.55	0.23
	16QAM		782 + 1732.5	23.82	0.24
	64QAM		782 + 1732.5	23.7	0.23
CA_13A-66A	QPSK	10 + 20	1755 + 782	23.04	0.20
	16QAM		1770 + 782	23.32	0.21
	64QAM		782 + 1755	23.16	0.21



1.4 EUT TEST CONFIGURATION

1.4.1 Test Configuration Description

Test Configuration	Description
A	Conducted antenna port measurement. EUT transmit at a maximum power and powered by the internal battery and/or USB via AC Adapter.
B	Radiated test setup/case spurious emissions. Antenna port terminated by the call box.

1.4.2 EUT Exercise Software

EUT is controlled by a CMW 500 Wideband Radio Communication Tester. There are no other test software used during verification.

1.4.3 Support Equipment and I/O cables

Manufacturer	Equipment/Cable	Description
Novatel Wireless	USB Cable	Type A to Type C USB Cable. M/N: NOV7000USB
Novatel Wireless	External AC-DC Power Adapter	Model: SSW-2783, PN: 40123126.01 Input: 100-240VAC, 50/60Hz, 0.5A Output: 5VDC, max. 2A

1.4.4 Mode of Operation for Inter-Band Carrier Aggregation

The Test frequencies for E-UTRA PCell and SCell for CA inter-band operation during the test is set according to 3GPP TS 36.508 Version 14.4.0 Release 14 as follows:

E-UTRA CA Configuration	CC Combinations / N _{RB_agg}	Test Frequency	CC N _{RB}	N _{UL}	Frequency of Uplink (MHz)
CA_2A-13A	50 + 50	f ₁	CC 50	18900	1880
	50 + 50	f ₂	CC 50	19150	1905
	50 + 50	f ₅	CC 50	23230	782
	50 + 50	f ₆	CC 50	N/A	N/A
CA_4A-13A	50 + 50	f ₁	CC 50	20175	1732.5
	50 + 50	f ₂	CC 50	20350	1750
	50 + 50	f ₅	CC 50	23230	782
	50 + 50	f ₆	CC 50	N/A	N/A
CA_13A-66A	50 + 50	f ₁	CC 50	23230	782
	50 + 50	f ₂	CC 50	N/A	N/A
	50 + 50	f ₅	CC 50	132422	1755
	50 + 50	f ₆	CC 50	132572	1770

1.4.5 Worst Case Configuration

Worst-case configuration used in this test report as per output power measurements:

Band	Channel BW	Frequency (MHz)	Modulation	RB Size/Offset
CA_2A-13A	10 + 10 MHz	782 + 1880	16QAM	1/49 & 1/0
CA_4A-13A	10 + 10 MHz	782 + 1732.5	16QAM	1/49 & 1/0
CA_13A-66A	10 + 20 MHz	1770 + 782	16QAM	100/0 & 50/0

For radiated measurements X, Y, and Z orientations were verified. The verification was determined "Y" as worst case configuration.

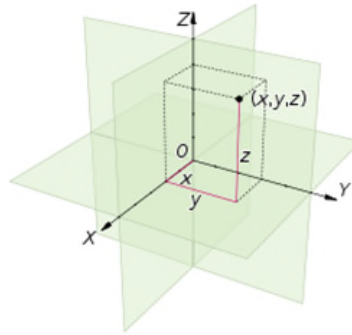

1.4.6 Simplified Test Configuration Diagram

Radiated Test Configuration

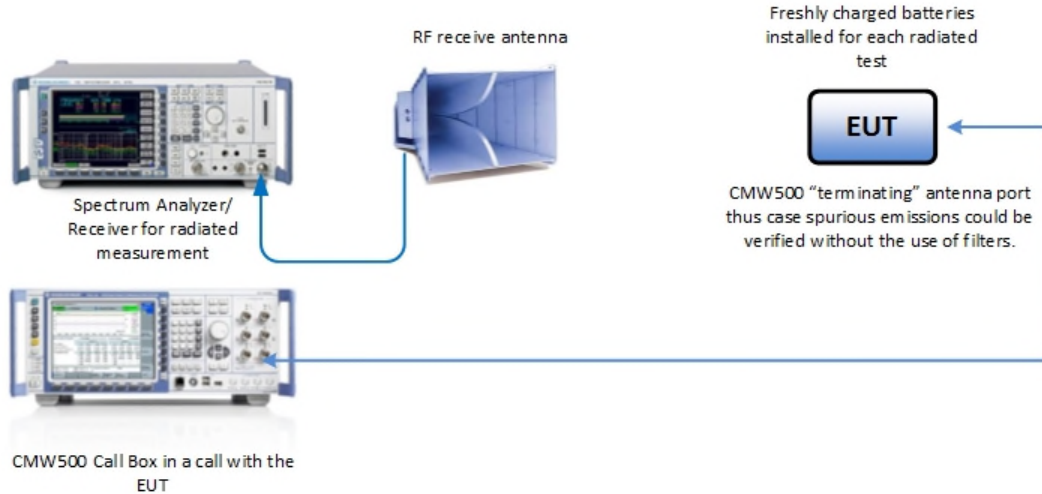

Conducted (Antenna Port) Test Configuration

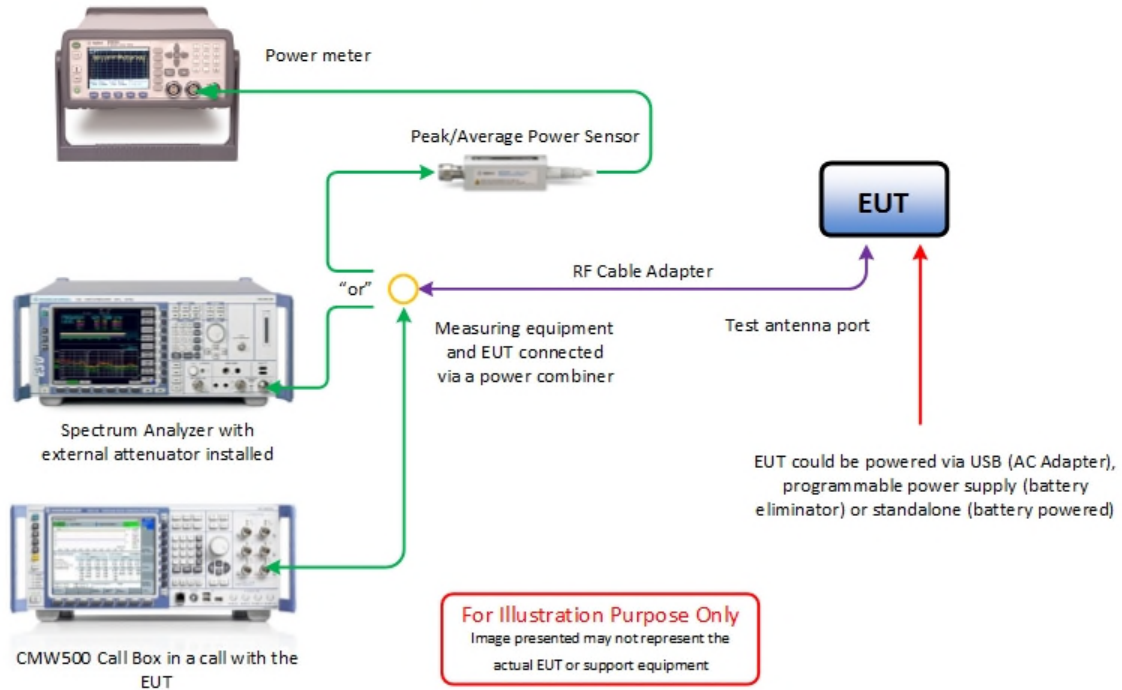



1.5 DEVIATIONS FROM THE STANDARD

No deviations from the applicable test standards or test plan were made during testing.

1.6 MODIFICATION RECORD

Description of Modification	Modification Fitted By	Date Modification Fitted
Serial Number AZ280418A00044		
None	—	—

The table above details modifications made to the EUT during the test programme. The modifications incorporated during each test (if relevant) are recorded on the appropriate test pages.

1.7 TEST METHODOLOGY

All measurements contained in this report were conducted with ANSI C63.26-2015, American National Standard for Compliance Testing of Transmitters Used in Licensed Radio Services.

For conducted and radiated emissions the equipment under test (EUT) was configured to measure its highest possible emission level. The test modes were adapted according to the Operating Instructions provided by the manufacturer/client.

1.8 TEST FACILITY LOCATION

1.8.1 TÜV SÜD America Inc. (Mira Mesa)

10040 Mesa Rim Road, San Diego, CA 92121-2912 (32.901268,-117.177681). Phone: (858) 678-1400 Fax: (858) 546-0364.

1.8.2 TÜV SÜD America Inc. (Rancho Bernardo)

16936 Via Del Campo, San Diego, CA 92127-1708 (33.018644,-117.092409). Phone: (858) 678-1400 Fax: (858) 546-0364.

1.9 TEST FACILITY REGISTRATION

1.9.1 FCC – Designation No.: US1146

TUV SUD America Inc. (San Diego), is an accredited test facility with the site description report on file and has met all the requirements specified in §2.948 of the FCC rules. The acceptance letter from the FCC is maintained in our files and the Designation is US1146.



1.9.2 Innovation, Science and Economic Development Canada (IC) Registration No.: 3067A-1 & 22806-1

The 10m Semi-anechoic chamber of TUV SUD America Inc. (San Diego Rancho Bernardo) has been registered by Certification and Engineering Bureau of Innovation, Science and Economic Development Canada for radio equipment testing with Registration No. 3067A-1.

The 3m Semi-anechoic chamber of TUV SUD America Inc. (San Diego Mira Mesa) has been registered by Certification and Engineering Bureau of Innovation, Science and Economic Development Canada for radio equipment testing with Registration No. 22806-1.

1.9.3 BSMI – Laboratory Code: SL2-IN-E-028R (US0102)

TUV Product Service Inc. (San Diego) is a recognized EMC testing laboratory by the BSMI under the MRA (Mutual Recognition Arrangement) with the United States. Accreditation includes CNS 13438 up to 6GHz.

1.9.4 NCC (National Communications Commission - US0102)

TUV SUD America Inc. (San Diego) is listed as a Foreign Recognized Telecommunication Equipment Testing Laboratory and is accredited to ISO/IEC 17025 (A2LA Certificate No.2955.13) which under APEC TEL MRA Phase 1 was designated as a Conformity Assessment Body competent to perform testing of equipment subject to the Technical Regulations covered under its scope of accreditation including RTTE01, PLMN01 and PLMN08 for TTE type of testing and LP002 for Low-Power RF Device type of testing.

1.9.5 VCCI – Registration No. A-0280 and A-0281

TUV SUD America Inc. (San Diego) is a VCCI registered measurement facility which includes radiated field strength measurement, radiated field strength measurement above 1GHz, mains port interference measurement and telecommunication port interference measurement.

1.9.6 RRA – Identification No. US0102

TUV SUD America Inc. (San Diego) is National Radio Research Agency (RRA) recognized laboratory under Phase I of the APEC Tel MRA.

1.9.7 OFCA – U.S. Identification No. US0102

TUV SUD America Inc. (San Diego) is recognized by Office of the Communications Authority (OFCA) under Appendix B, Phase I of the APEC Tel MRA.



1.10 SAMPLE CALCULATIONS

1.10.1 LTE Emission Designator (QPSK)

Emission Designator = 4M51G7D
 G = Phase Modulation
 7= Quantized/Digital Info
 D = Data Transmission, telemetry, telecommand

1.10.2 LTE Emission Designator (16QAM)

Emission Designator = 4M50W7D
 W = Frequency Modulation
 7= Quantized/Digital Info
 D = Data Transmission, telemetry, telecommand

1.10.3 Spurious Radiated Emission (below 1GHz)

Measuring equipment raw measurement (dbμV) @ 30 MHz			24.4
Correction Factor (dB)	Asset# 1066 (cable)	0.3	-12.6
	Asset# 1172 (cable)	0.3	
	Asset# 1016 (preamplifier)	-30.7	
	Asset# 1175(cable)	0.3	
	Asset# 1002 (antenna)	17.2	
Reported QuasiPeak Final Measurement (dbμV/m) @ 30MHz			11.8

1.10.4 Spurious Radiated Emission – Substitution Method

Example = 84dBμV/m @ 1413 MHz (numerical sample only)

The field strength reading of 84dBμV/m @ 1413 MHz (2nd Harmonic of 706.5 MHz) is the maximized measurement when the EUT is on the turntable measured at 3 meters. The gain of the substituted antenna is 7.8dBi while the transmit cable loss is 1.0 dB (cable between signal generator and the substituted antenna). The signal generator level is adjusted until the 84dBμV/m level at the receiving end is replicated (identical test setup, i.e. same antenna, cable/s and preamp). If the adjusted signal generator level is -18dBm, then we have the following for both EIRP and ERP as required:

$$\begin{aligned}
 P_{EIRP} &= -18 \text{ dBm} + 7.8 \text{ dBi} - 1 \text{ dB} \\
 &= 11.2 \text{ dBm} \\
 P_{ERP} &= P_{EIRP} - 2.15 \text{ dB} \\
 &= 11.2 \text{ dBm} - 2.15 \text{ dB} \\
 &= 9.05 \text{ dBm}
 \end{aligned}$$



SECTION 2

TEST DETAILS

Radio Testing of the
Novatel Wireless Inc.
MIFI8800L Wireless Hotspot Modem



2.1 TRANSMITTER CONDUCTED POWER MEASUREMENTS

2.1.1 Specification Reference

FCC 47 CFR Part 2, Clause 2.1046

2.1.2 Standard Applicable

The conducted power measurements were made in accordance to FCC Part 2 Clause 2.1046.

2.1.3 Equipment Under Test and Modification State

Serial No: AZ280418A00044 / Test Configuration A

2.1.4 Date of Test/Initial of test personnel who performed the test

July 02, 2018 / XYZ

2.1.5 Test Equipment Used

The major items of test equipment used for the above tests are identified in Section 3.1.

2.1.6 Environmental Conditions/ Test Location

Test performed at TÜV SÜD America Inc. Rancho Bernardo facility

Ambient Temperature	25.1 °C
Relative Humidity	52.1 %
ATM Pressure	99.0 kPa

2.1.7 Additional Observations

- This is a conducted test using Power Meter.
- The path loss were measured and entered as a level offset.
- Low, Middle and High channels for all bandwidths with different RB size and RB offset and modulations were verified and reported.



2.1.8 Test Results

CA_2A-13A										
Bandwidth (MHz)	Modulation	PCC Freq (MHz)	No. RB	RB Offset	SCC Freq (MHz)	No. RB	RB Offset	Average Power (dBm)	Peak Power (dBm)	
10+10	QPSK	1880	1	49	782	1	0	22.79	26.26	
			50	0		50	0	23.66	27.68	
	16QAM		1	49		1	0	23.12	27.81	
			50	0		50	0	23.79	28.85	
			64QAM	1		49	1	0	23.2	28.21
				50		0	50	0	23.6	28.96
10+10	QPSK	782	1	49	1880	1	0	23.3	26.66	
			50	0		50	0	23.47	28.06	
	16QAM		1	49		1	0	23.85	28.61	
			50	0		50	0	23.42	28.65	
			64QAM	1		49	1	0	23.63	29.43
				50		0	50	0	23.23	29.32

CA_2A-13A										
Bandwidth (MHz)	Modulation	PCC Freq (MHz)	No. RB	RB Offset	SCC Freq (MHz)	No. RB	RB Offset	Average Power (dBm)	Peak Power (dBm)	
10+10	QPSK	1905	1	49	782	1	0	22.18	26.25	
			50	0		50	0	23.36	27.6	
	16QAM		1	49		1	0	22.6	27.83	
			50	0		50	0	23.53	28.4	
			64QAM	1		49	1	0	23.09	28.11
				50		0	50	0	23.37	28.69
10+10	QPSK	782	1	49	1905	1	0	22.96	26.33	
			50	0		50	0	23.2	27.56	
	16QAM		1	49		1	0	23.36	28.34	
			50	0		50	0	23.23	28.27	
			64QAM	1		49	1	0	23.42	28.87
				50		0	50	0	23.04	28.92



CA_4A-13A									
Bandwidth (MHz)	Modulation	PCC Freq (MHz)	No. RB	RB Offset	SCC Freq (MHz)	No. RB	RB Offset	Average Power (dBm)	Peak Power (dBm)
10+10	QPSK	1732.5	1	49	782	1	0	22.99	26.8
			50	0		50	0	23.46	27.68
	16QAM		1	49		1	0	23.13	27.89
			50	0		50	0	23.58	28.46
	64QAM		1	49		1	0	23.28	28.55
			50	0		50	0	23.15	29.23
10+10	QPSK	782	1	49	1732.5	1	0	23.76	27.04
			50	0		50	0	23.36	27.64
	16QAM		1	49		1	0	23.82	28.47
			50	0		50	0	23.36	28.78
	64QAM		1	49		1	0	23.7	29.33
			50	0		50	0	22.89	28.28

CA_4A-13A									
Bandwidth (MHz)	Modulation	PCC Freq (MHz)	No. RB	RB Offset	SCC Freq (MHz)	No. RB	RB Offset	Average Power (dBm)	Peak Power (dBm)
10+10	QPSK	1750	1	49	782	1	0	23.55	27.29
			50	0		50	0	23.25	26.8
	16QAM		1	49		1	0	23.65	28.24
			50	0		50	0	23.39	28.14
	64QAM		1	49		1	0	23.62	28.4
			50	0		50	0	23.05	29.03
10+10	QPSK	782	1	49	1750	1	0	23.64	26.93
			50	0		50	0	23.29	27.89
	16QAM		1	49		1	0	23.72	28.36
			50	0		50	0	23.25	28.66
	64QAM		1	49		1	0	23.59	29.26
			50	0		50	0	22.81	28.69



CA_13A-66A									
Bandwidth (MHz)	Modulation	PCC Freq (MHz)	No. RB	RB Offset	SCC Freq (MHz)	No. RB	RB Offset	Average Power (dBm)	Peak Power (dBm)
10+20	QPSK	782	1	49	1755	1	0	22.65	26.02
			50	0		100	0	22.86	27.22
	16QAM		1	49		1	0	23.27	28.14
			50	0		100	0	22.91	28.23
	64QAM		1	49		1	0	23.16	28.90
			50	0		100	0	22.45	27.96
10+20	QPSK	1755	1	99	782	1	0	21.75	26.19
			100	0		50	0	23.04	27.07
	16QAM		1	99		1	0	22.33	28.09
			100	0		50	0	23.26	28.12
	64QAM		1	99		1	0	22.63	28.1
			100	0		50	0	22.81	28.69

CA_13A-66A									
Bandwidth (MHz)	Modulation	PCC Freq (MHz)	No. RB	RB Offset	SCC Freq (MHz)	No. RB	RB Offset	Average Power (dBm)	Peak Power (dBm)
10+20	QPSK	782	1	49	1770	1	0	22.64	26.01
			50	0		100	0	22.61	26.97
	16QAM		1	49		1	0	23.23	28.15
			50	0		100	0	22.66	27.99
	64QAM		1	49		1	0	23.09	28.79
			50	0		100	0	22.27	28.02
10+20	QPSK	1770	1	99	782	1	0	21.67	26.37
			100	0		50	0	23.0	26.78
	16QAM		1	99		1	0	22.29	27.71
			100	0		50	0	23.32	29.1
	64QAM		1	99		1	0	21.63	26.35
			100	0		50	0	22.96	28.93

2.1.9 Sample Test Measurement Screen

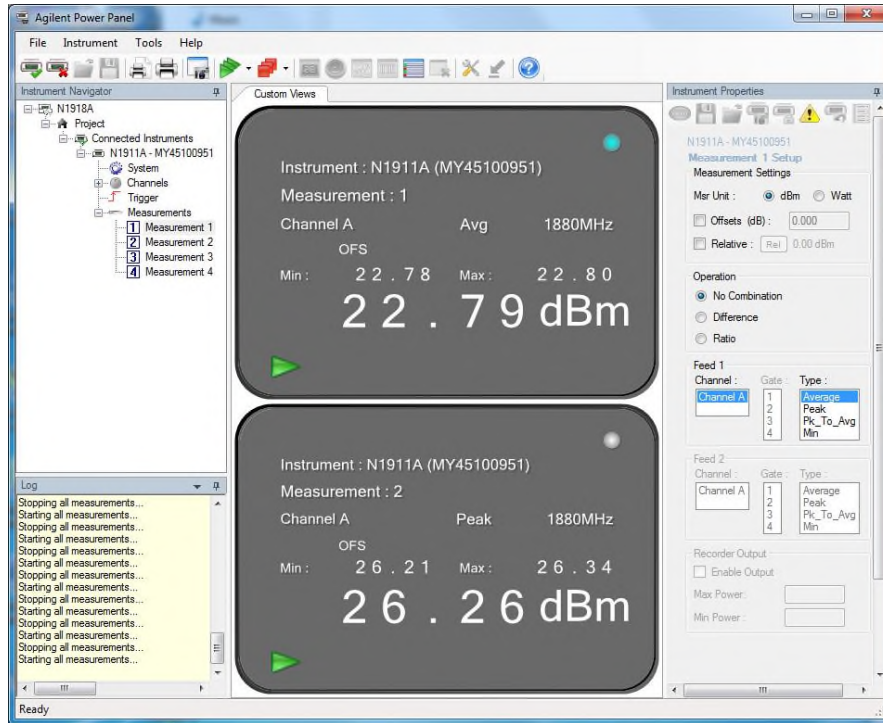

CA_2A-13A_10+10 MHz Bandwidth_1880 MHz 1-49 RB & 782 MHz 1-0 RB_QPSK

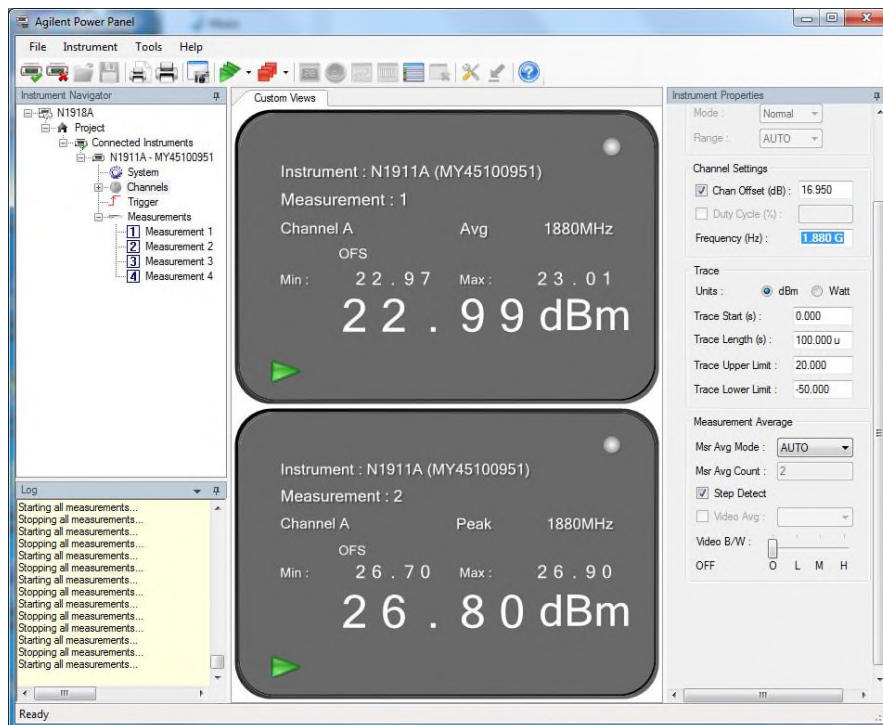

CA_4A-13A_10+10 MHz Bandwidth_1732.5 MHz 1-49 RB & 782 MHz 1-0 RB_QPSK

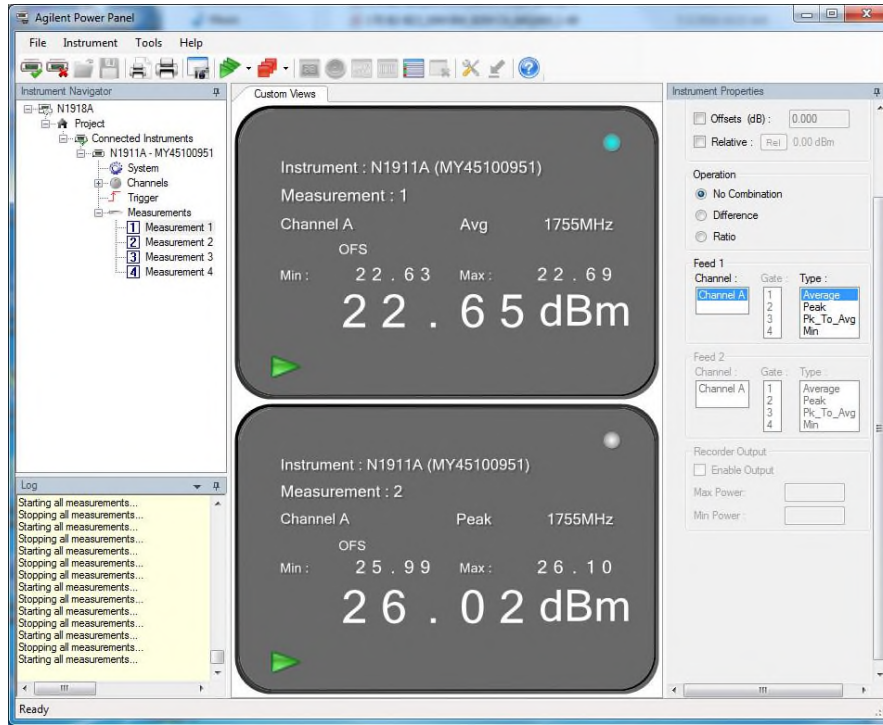

CA_13A_66A_10+20 MHz Bandwidth_782 MHz 1-49 RB & 1755 MHz 1-0 RB & _QPSK



2.2 EFFECTIVE ISOTROPIC RADIATED POWER AND POWER SPECTRAL DENSITY

2.2.1 Specification Reference

FCC 47 CFR Part 2, Clause 2.1046
FCC 47 CFR Part 24, Clause 24.232(c)
FCC 47 CFR Part 27, Clause 27.50(h)(2)
RSS-133, Clause 6.4
RSS-139, Clause 6.5
Rss-130, Clause 4.4

2.2.2 Standard Applicable

FCC Part 24.232:
(c) Mobile and portable stations are limited to 2 watts EIRP and the equipment must employ a means for limiting power to the minimum necessary for successful communications.

RSS-133, Clause 6.4:
The equivalent isotropically radiated power (e.i.r.p.) for Mobile stations and hand-held portables are limited to 2 watts maximum e.i.r.p.

FCC Part 27.50(h):
(2) Mobile and other user stations: Mobile stations are limited to 2 watts EIRP. All user stations are limited to 2.0 watts transmitter output power.

RSS-139, Clause 6.5:
The equivalent isotropically radiated power (e.i.r.p.) for Mobile and portable transmitters shall not exceed one watt.

RSS-130, Clause 4.4:
The e.i.r.p. shall not exceed 50 watts for Mobile equipment or for outdoor fixed subscriber equipment, not shall it exceed 5 watts for portable equipment or for indoor fixed subscriber equipment.

2.2.3 Equipment Under Test and Modification State

Serial No: AZ280418A00044 / Test Configuration (N/A, calculation only)

2.2.4 Date of Test/Initial of test personnel who performed the test

July 02, 2018 / XYZ

2.2.5 Test Equipment Used

The major items of test equipment used for the above tests are identified in Section 3.1.



2.2.6 Additional Observations

- EIRP was calculated as per Section 1.2 and 1.3 of KDB412172 D01 (Determining ERP and EIRP v01r01).
- Calculation formula in logarithmic terms:

$$\text{EIRP} = P_T + G_T - L_c$$

Where:

P_T = transmitter conducted output power dBm (Section 2.1 of this test report)

G_T = gain of the transmitting antenna, in dBi (EIRP);

L_c = signal attenuation in the connecting cable between the transmitter and antenna, in dB (EUT poses an internal Antenna. The loss between the EUT and the antenna port is considered negligible).



2.2.7 Test Results

CA_2A-13A												
Bandwidth (MHz)	Modulation	PCC Freq (MHz)	No. RB	RB Offset	SCC Freq (MHz)	No. RB	RB Offset	Average Power (dBm)	Antenna Gain (dBm)	EIRP (dBm)	Limit (dBm)	Margin (dB)
10+10	QPSK	1880	1	49	782	1	0	22.79	0.5	23.29	33	9.71
			50	0		50	0	23.66	0.5	24.16	33	8.84
	16QAM		1	49		1	0	23.12	0.5	23.62	33	9.38
			50	0		50	0	23.79	0.5	24.29	33	8.71
	64QAM		1	49		1	0	23.2	0.5	23.7	33	9.3
			50	0		50	0	23.6	0.5	24.1	33	8.9
10+10	QPSK	782	1	49	1880	1	0	23.3	0.5	23.8	33	9.2
			50	0		50	0	23.47	0.5	23.97	33	9.03
	16QAM		1	49		1	0	23.85	0.5	24.35	33	8.65
			50	0		50	0	23.42	0.5	23.92	33	9.08
	64QAM		1	49		1	0	23.63	0.5	24.13	33	8.87
			50	0		50	0	23.23	0.5	23.73	33	9.27

CA_2A-13A												
Bandwidth (MHz)	Modulation	PCC Freq (MHz)	No. RB	RB Offset	SCC Freq (MHz)	No. RB	RB Offset	Average Power (dBm)	Antenna Gain (dBm)	EIRP (dBm)	Limit (dBm)	Margin (dB)
10+10	QPSK	1905	1	49	782	1	0	22.18	0.5	22.68	33	10.32
			50	0		50	0	23.36	0.5	23.86	33	9.14
	16QAM		1	49		1	0	22.6	0.5	23.1	33	9.9
			50	0		50	0	23.53	0.5	24.03	33	8.97
	64QAM		1	49		1	0	23.09	0.5	23.59	33	9.41
			50	0		50	0	23.37	0.5	23.87	33	9.13
10+10	QPSK	782	1	49	1905	1	0	22.96	0.5	23.46	33	9.54
			50	0		50	0	23.2	0.5	23.7	33	9.3
	16QAM		1	49		1	0	23.36	0.5	23.86	33	9.14
			50	0		50	0	23.23	0.5	23.73	33	9.27
	64QAM		1	49		1	0	23.42	0.5	23.92	33	9.08
			50	0		50	0	23.04	0.5	23.54	33	9.46



CA_4A-13A												
Bandwidth (MHz)	Modulation	PCC Freq (MHz)	No. RB	RB Offset	SCC Freq (MHz)	No. RB	RB Offset	Average Power (dBm)	Antenna Gain (dBm)	EIRP (dBm)	Limit (dBm)	Margin (dB)
10+10	QPSK	1732.5	1	49	782	1	0	22.99	0.0	22.99	30	7.01
			50	0		50	0	23.46	0.0	23.46	30	6.54
	16QAM		1	49		1	0	23.13	0.0	23.13	30	6.87
			50	0		50	0	23.58	0.0	23.58	30	6.42
	64QAM		1	49		1	0	23.28	0.0	23.28	30	6.72
			50	0		50	0	23.15	0.0	23.15	30	6.85
10+10	QPSK	782	1	49	1732.5	1	0	23.76	0.0	23.76	30	6.24
			50	0		50	0	23.36	0.0	23.36	30	6.64
	16QAM		1	49		1	0	23.82	0.0	23.82	30	6.18
			50	0		50	0	23.36	0.0	23.36	30	6.64
	64QAM		1	49		1	0	23.7	0.0	23.7	30	6.3
			50	0		50	0	22.89	0.0	22.89	30	7.11

CA_4A-13A												
Bandwidth (MHz)	Modulation	PCC Freq (MHz)	No. RB	RB Offset	SCC Freq (MHz)	No. RB	RB Offset	Average Power (dBm)	Antenna Gain (dBm)	EIRP (dBm)	Limit (dBm)	Margin (dB)
10+10	QPSK	1750	1	49	782	1	0	23.55	0.0	23.55	30	6.45
			50	0		50	0	23.25	0.0	23.25	30	6.75
	16QAM		1	49		1	0	23.65	0.0	23.65	30	6.35
			50	0		50	0	23.39	0.0	23.39	30	6.61
	64QAM		1	49		1	0	23.62	0.0	23.62	30	6.38
			50	0		50	0	23.05	0.0	23.05	30	6.95
10+10	QPSK	782	1	49	1750	1	0	23.64	0.0	23.64	30	6.36
			50	0		50	0	23.29	0.0	23.29	30	6.71
	16QAM		1	49		1	0	23.72	0.0	23.72	30	6.28
			50	0		50	0	23.25	0.0	23.25	30	6.75
	64QAM		1	49		1	0	23.59	0.0	23.59	30	6.41
			50	0		50	0	22.81	0.0	22.81	30	7.19



CA_13A-66A												
Bandwidth (MHz)	Modulation	PCC Freq (MHz)	No. RB	RB Offset	SCC Freq (MHz)	No. RB	RB Offset	Average Power (dBm)	Antenna Gain (dBm)	EIRP (dBm)	Limit (dBm)	Margin (dB)
10+20	QPSK	782	1	49	1755	1	0	22.65	0.0	22.65	30	7.35
			50	0		100	0	22.86	0.0	22.86	30	7.14
	16QAM		1	49		1	0	23.27	0.0	23.27	30	6.73
			50	0		100	0	22.91	0.0	22.91	30	7.09
	64QAM		1	49		1	0	23.16	0.0	23.16	30	6.84
			50	0		100	0	22.45	0.0	22.45	30	7.55
10+20	QPSK	1755	1	0	782	1	0	21.75	0.0	21.75	30	8.25
			100	0		50	0	23.04	0.0	23.04	30	6.96
	16QAM		1	0		1	0	22.33	0.0	22.33	30	7.67
			100	0		50	0	23.26	0.0	23.26	30	6.74
	64QAM		1	0		1	0	22.63	0.0	22.63	30	7.37
			100	0		50	0	22.81	0.0	22.81	30	7.19

CA_13A-66A												
Bandwidth (MHz)	Modulation	PCC Freq (MHz)	No. RB	RB Offset	SCC Freq (MHz)	No. RB	RB Offset	Average Power (dBm)	Antenna Gain (dBm)	EIRP (dBm)	Limit (dBm)	Margin (dB)
10+20	QPSK	782	1	49	1770	1	0	22.64	0.0	22.64	30	7.36
			50	0		100	0	22.61	0.0	22.61	30	7.39
	16QAM		1	49		1	0	23.23	0.0	23.23	30	6.77
			50	0		100	0	22.66	0.0	22.66	30	7.34
	64QAM		1	49		1	0	23.09	0.0	23.09	30	6.91
			50	0		100	0	22.27	0.0	22.27	30	7.73
10+20	QPSK	1770	1	99	782	1	0	21.67	0.0	21.67	30	8.33
			100	0		50	0	23.0	0.0	23.0	30	7
	16QAM		1	99		1	0	22.29	0.0	22.29	30	7.71
			100	0		50	0	23.32	0.0	23.32	30	6.68
	64QAM		1	99		1	0	21.63	0.0	21.63	30	8.37
			100	0		50	0	22.96	0.0	22.96	30	7.04



2.3 PEAK-AVERAGE RATIO

2.3.1 Specification Reference

FCC 47 CFR Part 24, Clause 24.232 (d)
RSS-133, Clause 6.4
RSS-139, Clause 6.5

2.3.2 Standard Applicable

FCC Part 24:

Power measurements for transmissions by stations authorized under this section may be made either in accordance with a Commission-approved average power technique or in compliance with paragraph (e) of this section. In both instances, equipment employed must be authorized in accordance with the provisions of §24.51. In measuring transmissions in this band using an average power technique, the peak-to-average ratio (PAR) of the transmission may not exceed 13dB.

RSS-133 and RSS-139:

The transmitter's peak-to-average power ratio (PAPR) shall not exceed 13 dB for more than 0.1% of the time using a signal corresponding to the highest PAPR during periods of continuous transmission.

2.3.3 Equipment Under Test and Modification State

Serial No: AZ280418A00044 / Test Configuration A

2.3.4 Date of Test/Initial of test personnel who performed the test

July 02, 2018 / XYZ

2.3.5 Test Equipment Used

The major items of test equipment used for the above tests are identified in Section 3.1.

2.3.6 Environmental Conditions/ Test Location

Test performed at TÜV SÜD America Inc. Rancho Bernardo facility

Ambient Temperature	25.1 °C
Relative Humidity	52.1 %
ATM Pressure	99.0 kPa



2.3.7 Additional Observations

- This is a conducted test.
- As per FCC KDB 971168 D01 v03r01 clause 5.7, the PAPR was measured in accordance with ANSI C63.26 clause 5.2.3.4.
- Measurement was done using the Spectrum Analyzer's Complementary Cumulative Distribution Function (CCDF) measurement profile. The built-in function is used to determine the largest deviation between the average and the peak power of the EUT in a given bandwidth (crest factor or peak-to-average ratio). The CCDF curve shows how much time the peak waveform spends at or above a given average power level. The percent of time the signals spends at or above the level defines the probability for that particular power level. For GSM signals, an average and a peak trace are used to determine the largest deviation between the average and the peak power of the EUT in a bandwidth greater than the emission bandwidth.
- Low, Middle and High channels for all bandwidths and modulations were verified.
- The path loss for was measured and entered as a level offset.
- There are no measured PAPR levels greater than 13dB. EUT complies.



2.3.8 Test Results

CA_2A-13A						
Bandwidth (MHz)	Modulation	PCC Freq (MHz)	PCC PAR (dB)	SCC Freq (MHz)	SCC PAR (dB)	Limit (dB)
10+10	QPSK	1880	5.4	782	5.6	13
	16QAM	1880	6.71	782	6.6	13
	64QAM	1880	7.4	782	7.44	13

CA_2A-13A						
Bandwidth (MHz)	Modulation	PCC Freq (MHz)	PCC PAR (dB)	SCC Freq (MHz)	SCC PAR (dB)	Limit (dB)
10+10	QPSK	1905	5.1	782	5.4	13
	16QAM	1905	6.56	782	6.48	13
	64QAM	1905	7.43	782	7.52	13

CA_4A-13A						
Bandwidth (MHz)	Modulation	PCC Freq (MHz)	PCC PAR (dB)	SCC Freq (MHz)	SCC PAR (dB)	Limit (dB)
10+10	QPSK	1732.5	4.74	782	6.77	13
	16QAM	1732.5	5.82	782	7.21	13
	64QAM	1732.5	6.62	782	8.16	13

CA_4A-13A						
Bandwidth (MHz)	Modulation	PCC Freq (MHz)	PCC PAR (dB)	SCC Freq (MHz)	SCC PAR (dB)	Limit (dB)
10+10	QPSK	1750	5.11	782	5.23	13
	16QAM	1750	6.31	782	6.49	13
	64QAM	1750	7.18	782	7.33	13



CA_13A-66A						
Bandwidth (MHz)	Modulation	PCC Freq (MHz)	PCC PAR (dB)	SCC Freq (MHz)	SCC PAR (dB)	Limit (dB)
10+20	QPSK	782	5.19	1755	6.74	13
	16QAM	782	6.73	1755	7.69	13
	64QAM	782	7.53	1755	8.21	13

CA_13A-66A						
Bandwidth (MHz)	Modulation	PCC Freq (MHz)	PCC PAR (dB)	SCC Freq (MHz)	SCC PAR (dB)	Limit (dB)
10+20	QPSK	782	5.47	1770	6.75	13
	16QAM	782	6.63	1770	7.89	13
	64QAM	782	7.81	1770	7.91	13

2.3.9 Example Test Plots

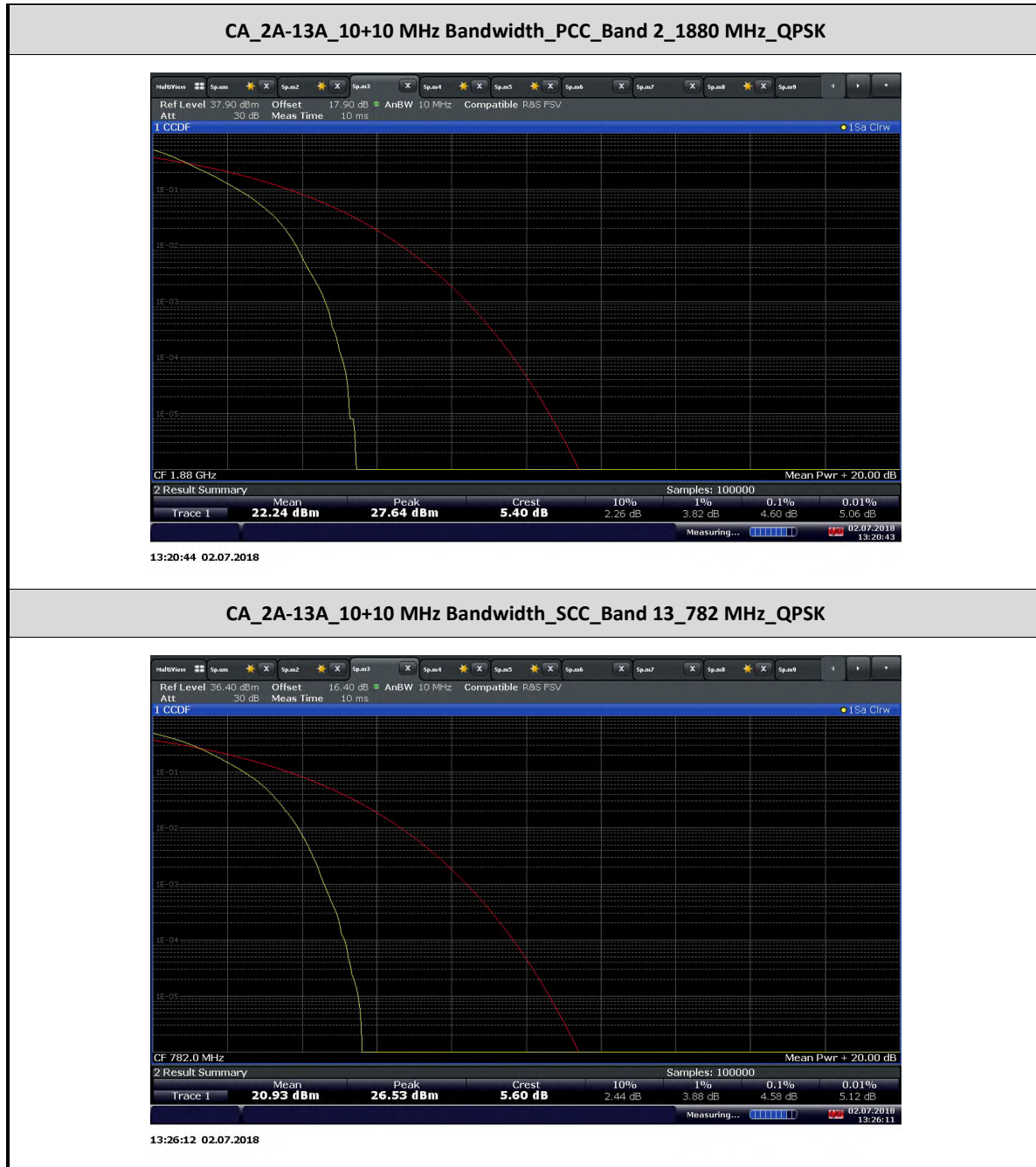

CA_4A-13A_10+10 MHz Bandwidth_PCC_Band 4_1732.5 MHz_QPSK



13:11:04 02.07.2018

CA_4A-13A_10+10 MHz Bandwidth_SCC_Band 13_782 MHz_QPSK



13:09:11 02.07.2018



CA_13A-66A_10+20 MHz Bandwidth_PCC_Band 13_782 MHz_QPSK



13:33:14 02.07.2018

CA_13A-66A_10+20 MHz Bandwidth_SCC_Band 66_1755 MHz_QPSK



13:03:50 02.07.2018



2.4 OCCUPIED BANDWIDTH

2.4.1 Specification Reference

FCC 47 CFR Part 2, Clause 2.1049
FCC 47 CFR Part 24, Clause 24.238(b)
FCC 47 CFR Part 27, Clause 27.53(h)(3)
RSS-GEN, Clause 6.7

2.4.2 Standard Applicable

The transmitted signal bandwidth shall be reported as the 99% emission bandwidth, that is the frequency bandwidth such that, below its lower and above its upper frequency limits, the mean powers radiated are each equal to 0.5 percent of the total mean power radiated by a given emission. 26dB Bandwidth is defined as the width of the signal between two points, one below the carrier center frequency and one above the carrier center frequency, outside of which all emissions are attenuated by at least 26 dB below the transmitter power.

Using the occupied bandwidth measurement function in the spectrum analyzer, the 99% occupied bandwidth was measured.

In addition, the 26dB bandwidth was measured in accordance with FCC KDB 971168 D01 v03r01 Clause 4.1 using the ndB measurement function in the spectrum analyzer.

- The transmitter shall be operated at its maximum carrier power measured under normal test conditions.
- The span of the analyzer shall be set to capture all products of the modulation process, including the emission skirts.
- The resolution bandwidth (RBW) shall be in the range of 1% to 5% of the occupied bandwidth (OBW) and video bandwidth (VBW) shall be at least 3x RBW.

2.4.3 Equipment Under Test and Modification State

Serial No: AZ280418A00044 / Test Configuration A

2.4.4 Date of Test/Initial of test personnel who performed the test

July 02, 2018 / XYZ

2.4.5 Test Equipment Used

The major items of test equipment used for the above tests are identified in Section 3.1.

2.4.6 Environmental Conditions/ Test Location

Test performed at TÜV SÜD America Inc. Rancho Bernardo facility

Ambient Temperature	25.1 °C
Relative Humidity	52.1 %
ATM Pressure	99.0 kPa



2.4.7 Additional Observations

- This is a conducted test. Both 26dB bandwidth and 99% bandwidth presented.
- Using the occupied bandwidth measurement function in the spectrum analyzer, the 99% occupied bandwidth was measured.
- The 26dB bandwidth was measured in accordance with ANSI C63.26 clause 5.4.3 using the ndB measurement function in the spectrum analyzer.
- The transmitter shall be operated at its maximum carrier power measured under normal test conditions.
- The span of the analyzer shall be set to capture all products of the modulation process, including the emission skirts.
- The resolution bandwidth (RBW) shall be in the range of 1% of the occupied bandwidth (OBW) and video bandwidth (VBW) shall be at least 3x RBW.
- Low, Mid and High channels for all bandwidths and modulations were verified. Test results of Mid channel were presented as representative.

2.4.8 Test Results

CA_2A-13A							
Bandwidth (MHz)	Modulation	PCC Freq (MHz)	PCC OBW (MHz)	PCC 26 dB BW (MHz)	SCC Freq (MHz)	SCC OBW (MHz)	SCC 26 dB BW (MHz)
10+10	QPSK	1880	8.93	9.64	782	8.93	9.64
	16QAM	1880	8.95	9.68	782	8.89	9.64
	64QAM	1880	8.95	9.64	782	8.88	9.51

CA_2A-13A							
Bandwidth (MHz)	Modulation	PCC Freq (MHz)	PCC OBW (MHz)	PCC 26 dB BW (MHz)	SCC Freq (MHz)	SCC OBW (MHz)	SCC 26 dB BW (MHz)
10+10	QPSK	1905	8.93	9.68	782	8.91	9.55
	16QAM	1905	8.93	9.64	782	8.91	9.64
	64QAM	1905	8.92	9.64	782	8.93	9.64



CA_4A-13A							
Bandwidth (MHz)	Modulation	PCC Freq (MHz)	PCC OBW (MHz)	PCC 26 dB BW (MHz)	SCC Freq (MHz)	SCC OBW (MHz)	SCC 26 dB BW (MHz)
10+10	QPSK	1732.5	8.96	9.72	782	8.91	9.6
	16QAM	1732.5	8.96	9.68	782	8.91	9.64
	64QAM	1732.5	8.97	9.72	782	8.9	9.68

CA_4A-13A							
Bandwidth (MHz)	Modulation	PCC Freq (MHz)	PCC OBW (MHz)	PCC 26 dB BW (MHz)	SCC Freq (MHz)	SCC OBW (MHz)	SCC 26 dB BW (MHz)
10+10	QPSK	1750	8.96	9.77	782	8.91	9.55
	16QAM	1750	8.97	9.68	782	8.88	9.6
	64QAM	1750	8.96	9.77	782	8.9	9.64

CA_13A-66A							
Bandwidth (MHz)	Modulation	PCC Freq (MHz)	PCC OBW (MHz)	PCC 26 dB BW (MHz)	SCC Freq (MHz)	SCC OBW (MHz)	SCC 26 dB BW (MHz)
10+20	QPSK	782	8.92	9.68	1755	17.97	19.36
	16QAM	782	8.91	9.55	1755	17.92	19.28
	64QAM	782	8.88	9.72	1755	17.93	19.19

CA_13A-66A							
Bandwidth (MHz)	Modulation	PCC Freq (MHz)	PCC OBW (MHz)	PCC 26 dB BW (MHz)	SCC Freq (MHz)	SCC OBW (MHz)	SCC 26 dB BW (MHz)
10+20	QPSK	782	8.91	9.68	1770	17.89	19.28
	16QAM	782	8.9	9.6	1770	17.84	19.19
	64QAM	782	8.91	9.51	1770	17.84	19.19

2.4.9 Example Test Plots

CA_2A-13A_10+10 MHz Bandwidth_PCC_Band 2_1880 MHz_QPSK / 99%OBW



15:20:38 02.07.2018

CA_2A-13A_10+10 MHz Bandwidth_PCC_Band 2_1880 MHz_QPSK / 26dB BW



15:20:09 02.07.2018



CA_2A-13A_10+10 MHz Bandwidth_SCC_Band 13_782 MHz_QPSK / 99%OBW



15:04:52 02.07.2018

CA_2A-13A_10+10 MHz Bandwidth_SCC_Band 13_782 MHz_QPSK / 26dB BW



15:04:06 02.07.2018



CA_4A-13A_10+10 MHz Bandwidth_PCC_Band 4_1732.5 MHz_QPSK / 99%OBW



14:50:52 02.07.2018

CA_4A-13A_10+10 MHz Bandwidth_PCC_Band 4_1732.5 MHz_QPSK / 26dB BW



14:51:25 02.07.2018



CA_4A-13A_10+10 MHz Bandwidth_SCC_Band 13_782 MHz_QPSK / 99%OBW



CA_4A-13A_10+10 MHz Bandwidth_SCC_Band 13_782 MHz_QPSK / 26dB BW





CA_13A-66A_10+20 MHz Bandwidth_PCC_Band 13_782 MHz_QPSK / 99%OBW



14:15:02 02.07.2018

CA_13A-66A_10+20 MHz Bandwidth_PCC_Band 13_782 MHz_QPSK / 26dB BW



14:19:41 02.07.2018



CA_13A-66A_10+20 MHz Bandwidth_SCC_Band 66_1755 MHz_QPSK / 99%OBW



14:32:44 02.07.2018

CA_13A-66A_10+20 MHz Bandwidth_SCC_Band 66_1755 MHz_QPSK / 26dB BW



14:32:12 02.07.2018



2.5 BAND EDGE

2.5.1 Specification Reference

FCC 47 CFR Part 2, Clause 2.1051
FCC 47 CFR Part 24, Clause 24.238(a)(b)
FCC 47 CFR Part 27, Clause 27.53(h)(1)(3)
FCC 47 CFR Part 27, Clause 27.53(c)(2)(5)
RSS-133, Clause 6.5
RSS-139, Clause 6.6
RSS-130, Clause 4.6

2.5.2 Standard Applicable

FCC 47 CFR Part 24.238

(a) Out of band emissions. The power of any emission outside of the authorized operating frequency ranges must be attenuated below the transmitting power (P) by a factor of at least $43 + 10 \log(P)$ dB.

(b) Measurement procedure. Compliance with these rules is based on the use of measurement instrumentation employing a resolution bandwidth of 1 megahertz or greater. However, in the 1 megahertz bands immediately outside and adjacent to the frequency block a resolution bandwidth of at least one percent of the emission bandwidth of the fundamental emission of the transmitter may be employed.

FCC 47 CFR Part 27.53:

(h) AWS emission limits—(1) General protection levels. Except as otherwise specified below, for operations in the 1695-1710 MHz, 1710-1755 MHz, 1755-1780 MHz, 1915-1920 MHz, 1995-2000 MHz, 2000-2020 MHz, 2110-2155 MHz, 2155-2180 MHz, and 2180-2200 bands, the power of any emission outside a licensee's frequency block shall be attenuated below the transmitter power (P) in watts by at least $43 + 10 \log_{10}(P)$ dB

(3) Measurement procedure. (i) Compliance with this provision is based on the use of measurement instrumentation employing a resolution bandwidth of 1 megahertz or greater. However, in the 1 megahertz bands immediately outside and adjacent to the licensee's frequency block, a resolution bandwidth of at least one percent of the emission bandwidth of the fundamental emission of the transmitter may be employed. The emission bandwidth is defined as the width of the signal between two points, one below the carrier center frequency and one above the carrier center frequency, outside of which all emissions are attenuated at least 26 dB below the transmitter power.

(c)(2) On any frequency outside the 776–788 MHz band, the power of any emission shall be attenuated outside the band below the transmitter power (P) by at least $43 + 10 \log(P)$ dB;

(c)(5) Compliance with the provisions of paragraphs (c)(1) and (c)(2) of this section is based on the use of measurement instrumentation employing a resolution bandwidth of 100 kHz or greater. However, in the 100 kHz bands immediately outside and adjacent to the frequency block, a resolution bandwidth of at least 30 kHz may be employed.

RSS-133, Clause 6.5.1

Equipment shall comply with the limits in (i) and (ii) below.

(i) In the 1.0 MHz bands immediately outside and adjacent to the equipment's operating frequency block, the emission power per any 1% of the emission bandwidth shall be attenuated (in dB) below the transmitter output power P (dBW) by at least $43 + 10 \log_{10}(P)$ (watts).

(ii) After the first 1.0 MHz, the emission power in any 1 MHz bandwidth shall be attenuated (in dB) below the transmitter output power P (dBW) by at least $43 + 10 \log_{10}(P)$ (watts). If the



measurement is performed using 1% of the emission bandwidth, power integration over 1.0 MHz is required.

RSS-139, Clause 6.6

- (i) In the first 1.0 MHz bands immediately outside and adjacent to the equipment's smallest operating frequency block, which can contain the equipment's occupied bandwidth, the emission power per any 1% of the emission bandwidth shall be attenuated below the transmitter output power P (in dBW) by at least $43 + 10 \log_{10} p$ (watts) dB.
- (ii) After the first 1.0 MHz outside the equipment's smallest operating frequency block, which can contain the equipment's occupied bandwidth, the emission power in any 1 MHz bandwidth shall be attenuated below the transmitter output power P (dBW) by at least $43 + 10 \log_{10} p$ (watts) dB.

RSS-130, Clause 4.6.1

The power of any unwanted emissions in any 100 kHz bandwidth on any frequency outside the frequency range(s) within which the equipment is designed to operate shall be attenuated below the transmitter power, P (dBW), by at least $43 + 10 \log_{10} p$ (watts), dB. However, in the 100 kHz band immediately outside the equipment's operating frequency range, a resolution bandwidth of 30 kHz may be employed.

2.5.3 Equipment Under Test and Modification State

Serial No: AZ280418A00044 / Test Configuration A

2.5.4 Date of Test/Initial of test personnel who performed the test

July 03, 2018 / XYZ

2.5.5 Test Equipment Used

The major items of test equipment used for the above tests are identified in Section 3.1.

2.5.6 Environmental Conditions/ Test Location

Test performed at TÜV SÜD America Inc. Rancho Bernardo facility

Ambient Temperature	25.8 °C
Relative Humidity	49.4 %
ATM Pressure	98.9 kPa

2.5.7 Additional Observations

- This is a conducted test.
- The path loss were measured and entered as a level offset.
- RBW is set to at least 1% of emission bandwidth for Band 2, Band 4 and Band 66, and 30 kHz for Band 13. VBW is set to 3X RBW.
- For emissions more than 100 kHz (for Band 13) outside the equipment's operating frequency block, the limit is set to:
 $-13 + 10 \lg (\text{RBW}_{\text{used}}/1 \text{ MHz})$ dBm.
- Only worst case configuration for all technologies presented in this test report.

2.5.8 Test Results

CA_2A-13A_10+10 MHz Bandwidth_PCC_Band 2_1905 MHz_Full RB_QPSK / High Edge

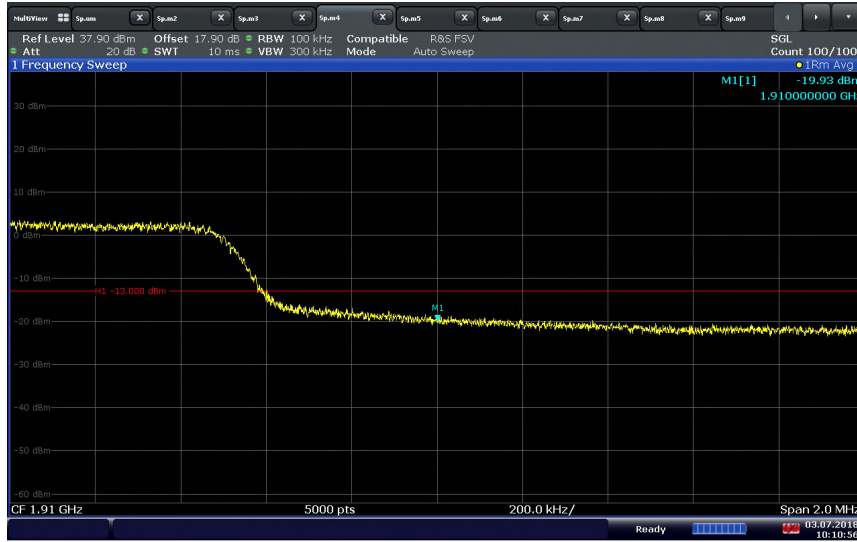

10:10:56 03.07.2018

CA_2A-13A_10+10 MHz Bandwidth_PCC_Band 2_1905 MHz_1 RB_QPSK / High Edge

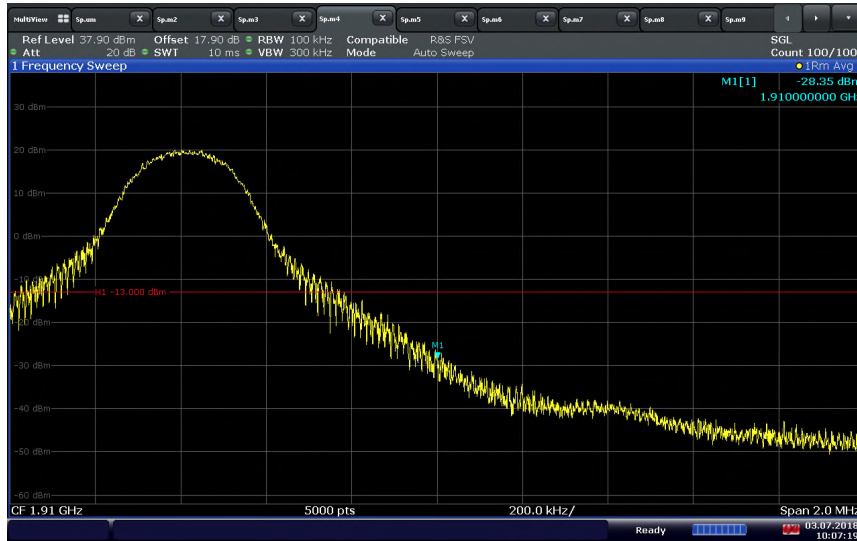

10:07:19 03.07.2018



CA_2A-13A_10+10 MHz Bandwidth_SCC_Band 13_782 MHz_Full RB_QPSK / Low Edge



09:29:01 03.07.2018

CA_2A-13A_10+10 MHz Bandwidth_SCC_Band 13_782 MHz_1-0 RB_QPSK / Low Edge

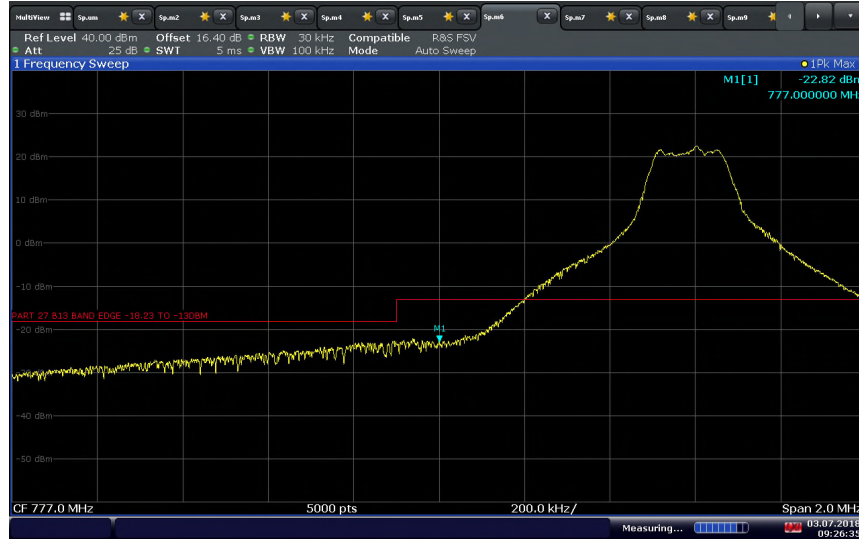

09:26:35 03.07.2018

CA_2A-13A_10+10 MHz Bandwidth_SCC_Band 13_782 MHz_Full RB_QPSK / High Edge



09:21:54 03.07.2018

CA_2A-13A_10+10 MHz Bandwidth_SCC_Band 13_782 MHz_1-49 RB_QPSK / High Edge

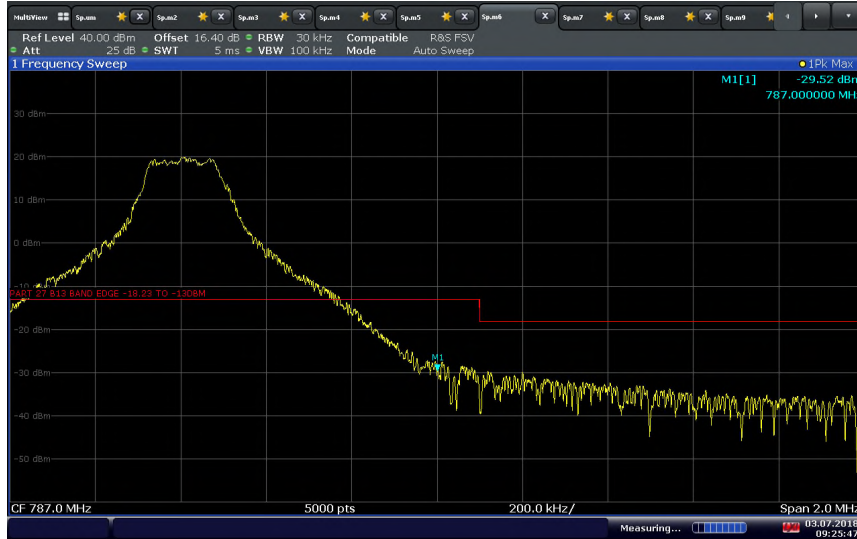

09:25:48 03.07.2018



CA_4A-13A_10+10 MHz Bandwidth_PCC_Band 4_1750 MHz_Full RB_QPSK / High Edge

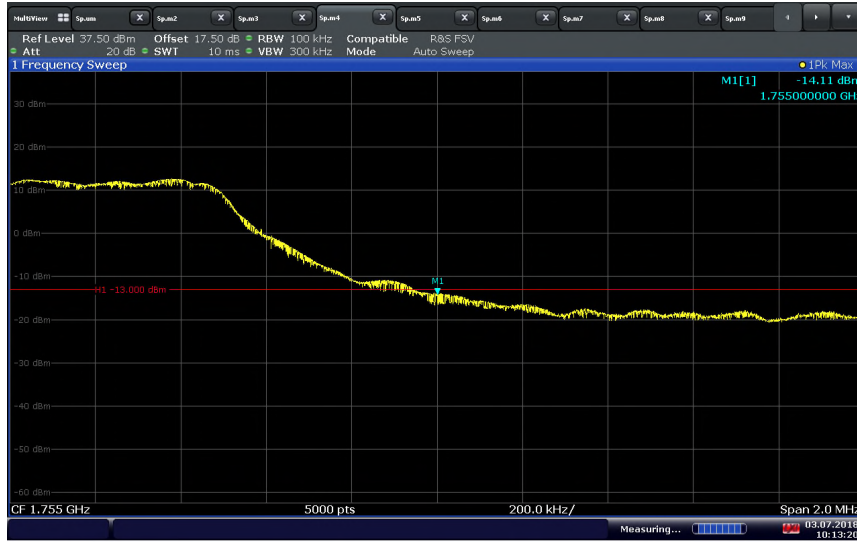

10:13:20 03.07.2018

CA_4A-13A_10+10 MHz Bandwidth_PCC_Band 4_1750 MHz_1-49 RB_QPSK / High Edge

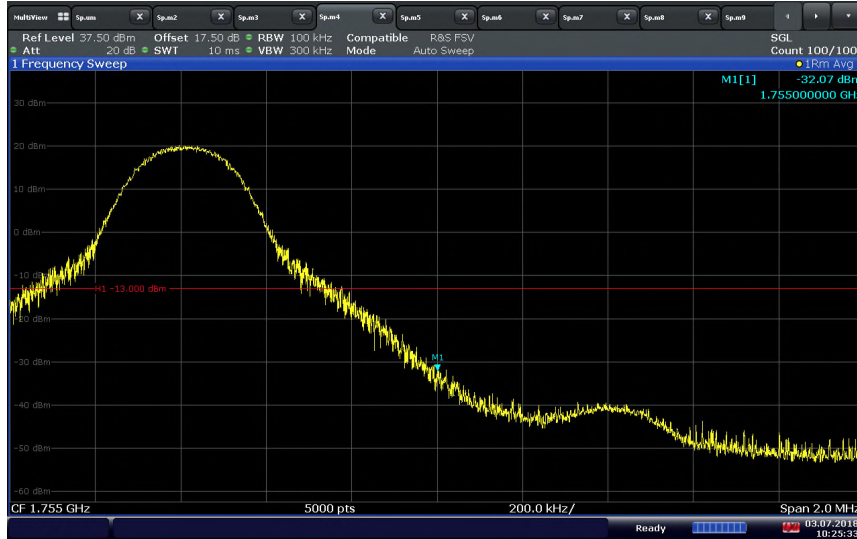

10:25:33 03.07.2018



CA_4A-13A_10+10 MHz Bandwidth_SCC_Band 13_782 MHz_Full RB_QPSK / Low Edge



09:29:01 03.07.2018

CA_4A-13A_10+10 MHz Bandwidth_SCC_Band 13_782 MHz_1-0 RB_QPSK / Low Edge

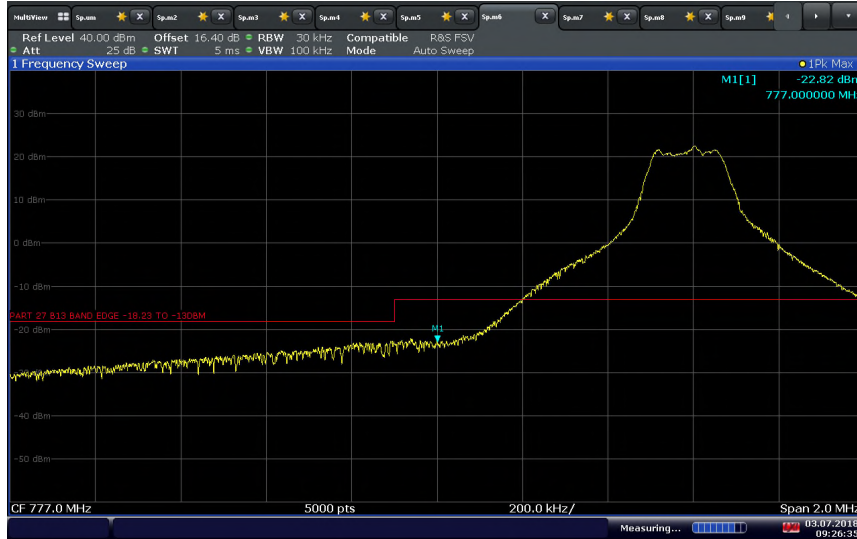

09:26:36 03.07.2018



CA_4A-13A_10+10 MHz Bandwidth_SCC_Band 13_782 MHz_Full RB_QPSK / High Edge



09:21:54 03.07.2018

CA_4A-13A_10+10 MHz Bandwidth_SCC_Band 13_782 MHz_1-49 RB_QPSK / High Edge

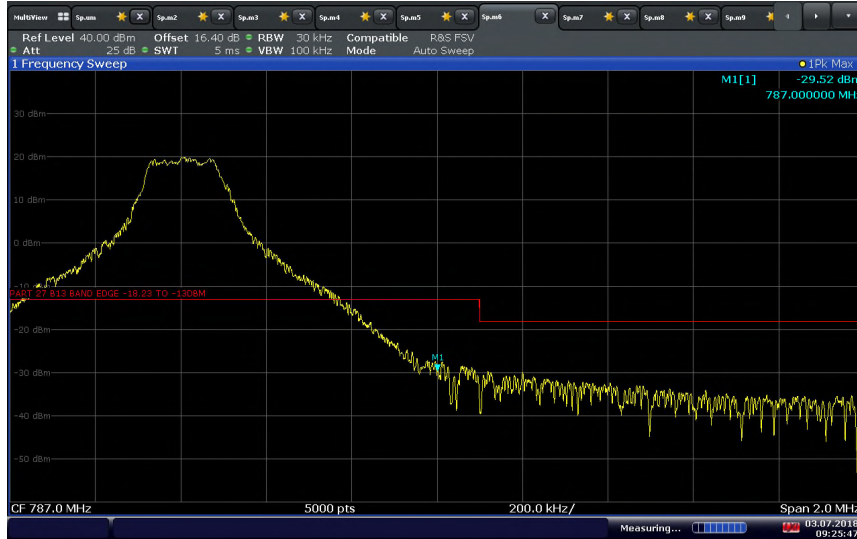

09:25:48 03.07.2018



CA_13A-66A_10+10 MHz Bandwidth_PCC_Band 13_782 MHz_Full RB_QPSK / Low Edge



09:47:09 03.07.2018

CA_13A-66A_10+10 MHz Bandwidth_PCC_Band 13_782 MHz_1-0 RB_QPSK / Low Edge

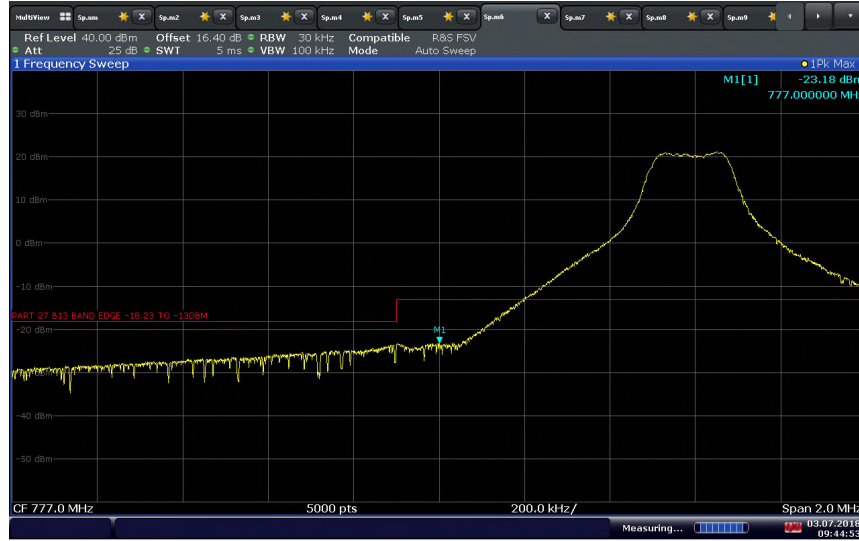

09:44:54 03.07.2018

CA_13A-66A_10+10 MHz Bandwidth_PCC_Band 13_782 MHz_Full RB_QPSK / High Edge



09:41:03 03.07.2018

CA_13A-66A_10+10 MHz Bandwidth_PCC_Band 13_782 MHz_1-49 RB_QPSK / High Edge

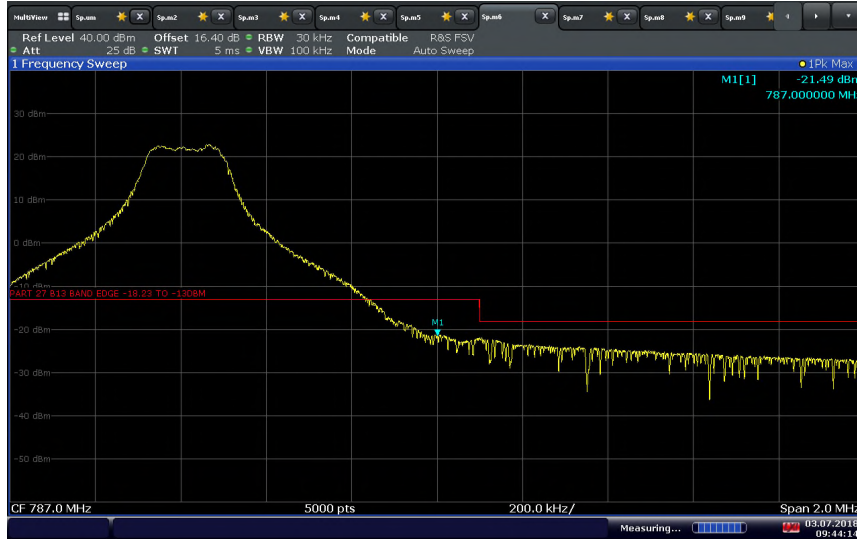

09:44:15 03.07.2018



CA_13A-66A_10+20 MHz Bandwidth_SCC_Band 66_1770 MHz_Full RB_QPSK / High Edge

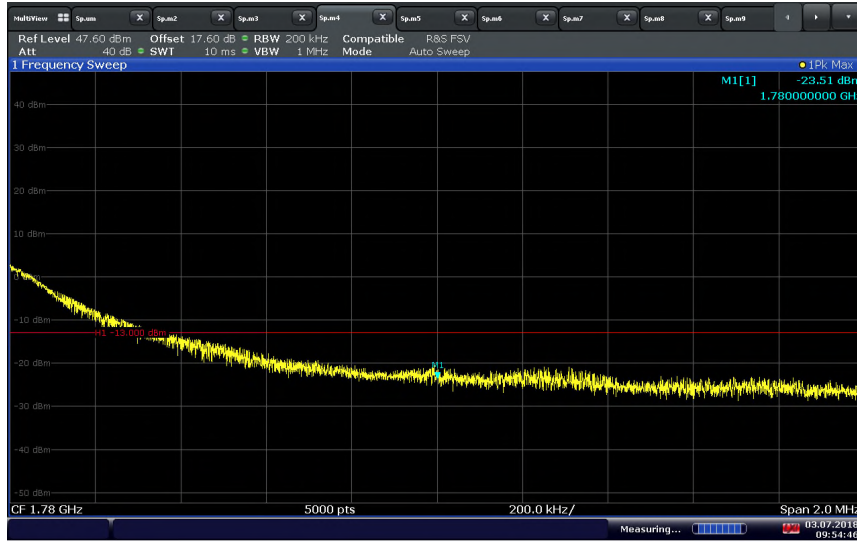

09:54:47 03.07.2018

CA_13A-66A_10+20 MHz Bandwidth_SCC_Band 66_1770 MHz_1-99 RB_QPSK / High Edge

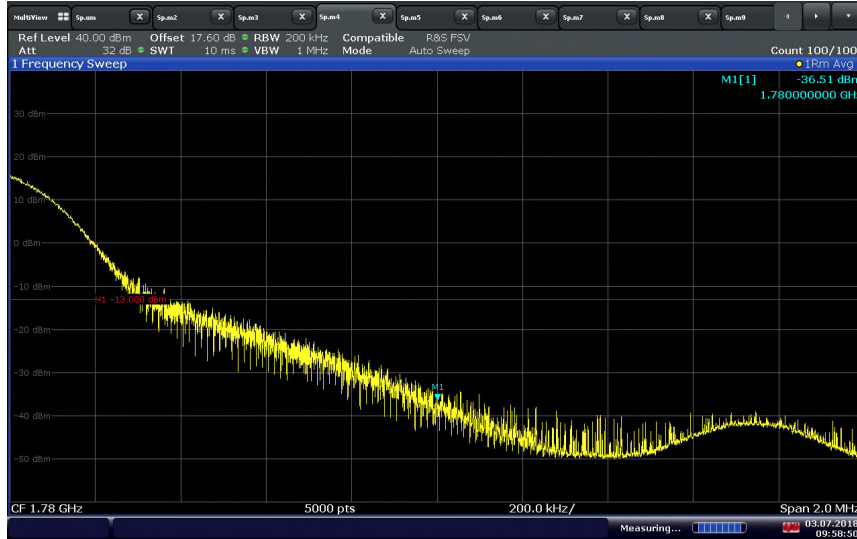

09:58:50 03.07.2018



2.6 CONDUCTED SPURIOUS EMISSIONS

2.6.1 Specification Reference

FCC 47 CFR Part 2, Clause 2.1051
FCC 47 CFR Part 24, Clause 24.238(a)(b)
FCC 47 CFR Part 27, Clause 27.53(h)(1)(3)
FCC 47 CFR Part 27, Clause 27.53(c)(2)(4)(5)(f)
RSS-133, Clause 6.5
RSS-139, Clause 6.6
RSS-130, Clause 4.6

2.6.2 Standard Applicable

FCC 47 CFR Part 24.238

(a) Out of band emissions. The power of any emission outside of the authorized operating frequency ranges must be attenuated below the transmitting power (P) by a factor of at least $43 + 10 \log(P)$ dB.

(b) Measurement procedure. Compliance with these rules is based on the use of measurement instrumentation employing a resolution bandwidth of 1 megahertz or greater. However, in the 1 megahertz bands immediately outside and adjacent to the frequency block a resolution bandwidth of at least one percent of the emission bandwidth of the fundamental emission of the transmitter may be employed.

FCC 47 CFR Part 27.53:

(h) AWS emission limits—(1) General protection levels. Except as otherwise specified below, for operations in the 1695-1710 MHz, 1710-1755 MHz, 1755-1780 MHz, 1915-1920 MHz, 1995-2000 MHz, 2000-2020 MHz, 2110-2155 MHz, 2155-2180 MHz, and 2180-2200 bands, the power of any emission outside a licensee's frequency block shall be attenuated below the transmitter power (P) in watts by at least $43 + 10 \log_{10}(P)$ dB

(3) Measurement procedure. (i) Compliance with this provision is based on the use of measurement instrumentation employing a resolution bandwidth of 1 megahertz or greater. However, in the 1 megahertz bands immediately outside and adjacent to the licensee's frequency block, a resolution bandwidth of at least one percent of the emission bandwidth of the fundamental emission of the transmitter may be employed. The emission bandwidth is defined as the width of the signal between two points, one below the carrier center frequency and one above the carrier center frequency, outside of which all emissions are attenuated at least 26 dB below the transmitter power.

(c)(2) On any frequency outside the 776–788 MHz band, the power of any emission shall be attenuated outside the band below the transmitter power (P) by at least $43 + 10 \log(P)$ dB;

(c)(5) Compliance with the provisions of paragraphs (c)(1) and (c)(2) of this section is based on the use of measurement instrumentation employing a resolution bandwidth of 100 kHz or greater. However, in the 100 kHz bands immediately outside and adjacent to the frequency block, a resolution bandwidth of at least 30 kHz may be employed.

RSS-133, Clause 6.5.1

Equipment shall comply with the limits in (i) and (ii) below.

(i) In the 1.0 MHz bands immediately outside and adjacent to the equipment's operating frequency block, the emission power per any 1% of the emission bandwidth shall be attenuated (in dB) below the transmitter output power P (dBW) by at least $43 + 10 \log_{10}(P)$ (watts).

(ii) After the first 1.0 MHz, the emission power in any 1 MHz bandwidth shall be attenuated (in dB) below the transmitter output power P (dBW) by at least $43 + 10 \log_{10}(P)$ (watts). If the



measurement is performed using 1% of the emission bandwidth, power integration over 1.0 MHz is required.

RSS-139, Clause 6.6

- (i) In the first 1.0 MHz bands immediately outside and adjacent to the equipment's smallest operating frequency block, which can contain the equipment's occupied bandwidth, the emission power per any 1% of the emission bandwidth shall be attenuated below the transmitter output power P (in dBW) by at least $43 + 10 \log_{10} p$ (watts) dB.
- (ii) After the first 1.0 MHz outside the equipment's smallest operating frequency block, which can contain the equipment's occupied bandwidth, the emission power in any 1 MHz bandwidth shall be attenuated below the transmitter output power P (dBW) by at least $43 + 10 \log_{10} p$ (watts) dB.

RSS-130, Clause 4.6.1

The power of any unwanted emissions in any 100 kHz bandwidth on any frequency outside the frequency range(s) within which the equipment is designed to operate shall be attenuated below the transmitter power, P (dBW), by at least $43 + 10 \log_{10} p$ (watts), dB. However, in the 100 kHz band immediately outside the equipment's operating frequency range, a resolution bandwidth of 30 kHz may be employed.

2.6.3 Equipment Under Test and Modification State

Serial No: AZ280418A00044 / Test Configuration A

2.6.4 Date of Test/Initial of test personnel who performed the test

July 02, 2018 / ZXY

2.6.5 Test Equipment Used

The major items of test equipment used for the above tests are identified in Section 3.1.

2.6.6 Environmental Conditions/ Test Location

Test performed at TÜV SÜD America Inc. Rancho Bernardo facility

Ambient Temperature	25.1 °C
Relative Humidity	52.1 %
ATM Pressure	99.0 kPa

2.6.7 Additional Observations

- This is a conducted test.
- The spectrum was searched from 9 kHz to the 10th harmonic.
- The path loss was measured and entered as a transducer factor (TDF).
- Low, Middle and High channels on all channel bandwidth and modulation are verified. Only worst case configuration for all technologies presented in this test report.

2.6.8 Test Results

CA_2A-13A_10+10 MHz Bandwidth_1880 MHz & 782 MHz_Full RB_QPSK / Conducted Spurious Emissions

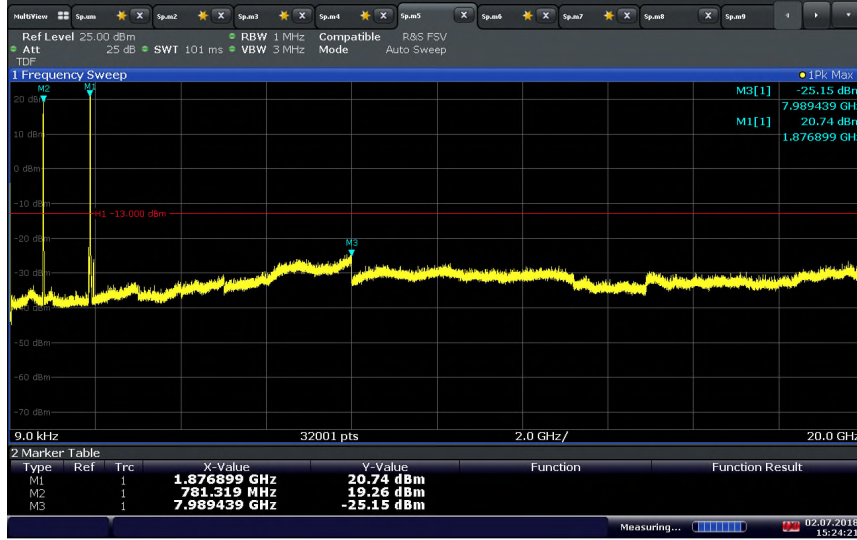

15:24:22 02.07.2018

CA_2A-13A_10+10 MHz Bandwidth_1880 MHz & 782 MHz_Full RB_QPSK / Conducted Spurious Emissions (763-775 MHz)

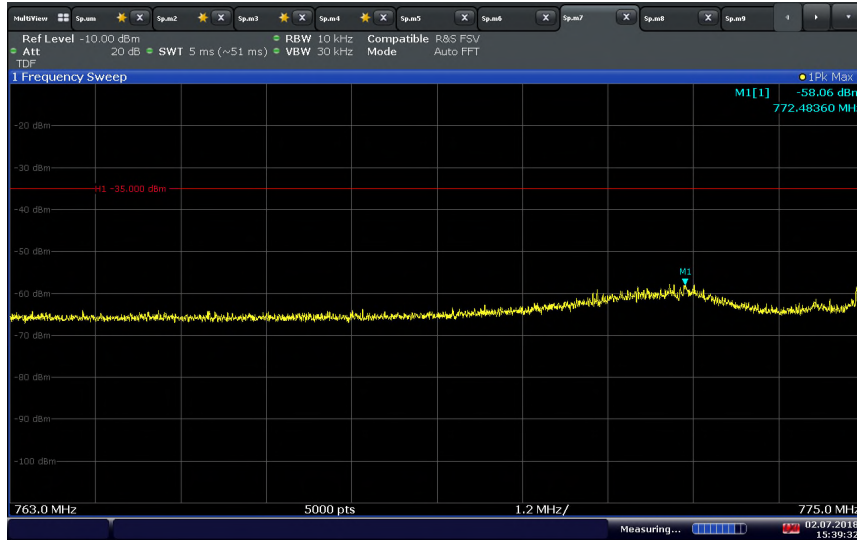

15:39:33 02.07.2018

**CA_2A-13A_10+10 MHz Bandwidth_1880 MHz & 782 MHz_Full RB_QPSK / Conducted Spurious Emissions
(793-806 MHz)**

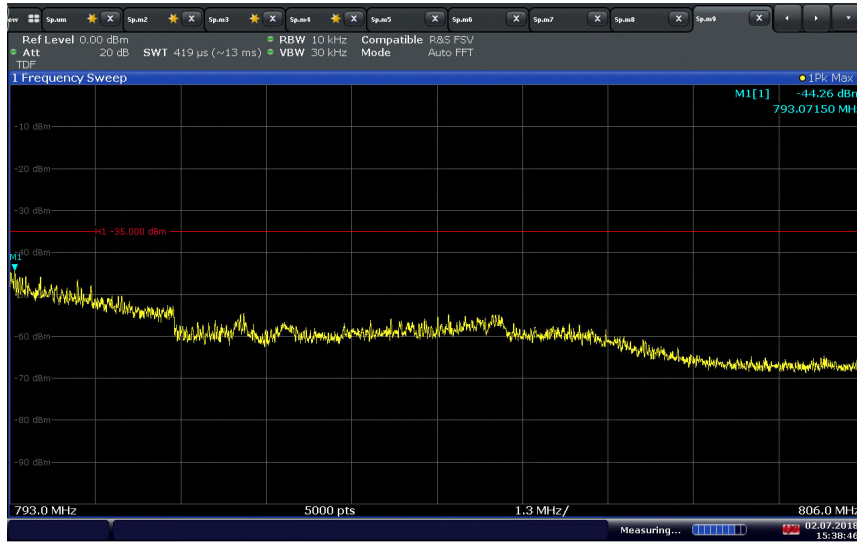

**CA_2A-13A_10+10 MHz Bandwidth_1880 MHz & 782 MHz_1 RB_QPSK / Conducted Spurious Emissions
(1559-1610 MHz)**

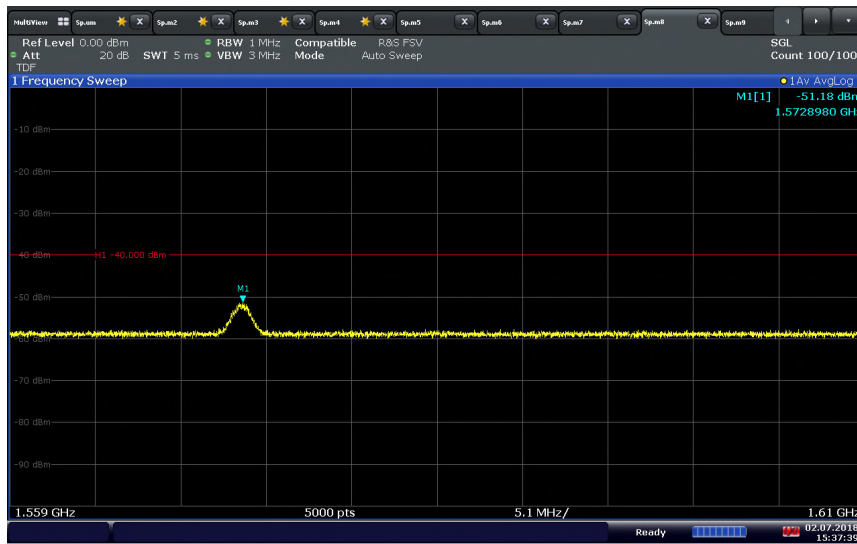



CA_2A-13A_10+10 MHz Bandwidth_1905 MHz & 782 MHz_ Full RB_QPSK / Conducted Spurious Emissions

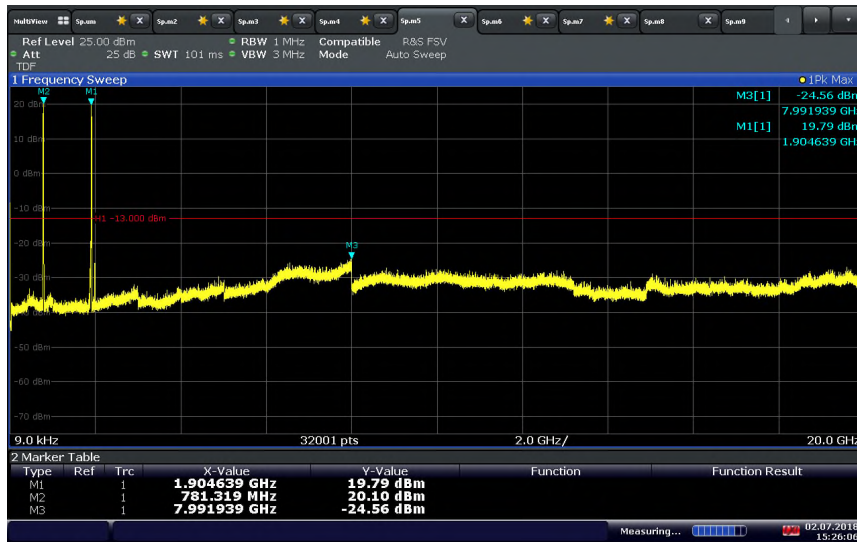

15:26:07 02.07.2018

CA_2A-13A_10+10 MHz Bandwidth_1905 MHz & 782 MHz_ Full RB_QPSK / Conducted Spurious Emissions
 (763-775 MHz)

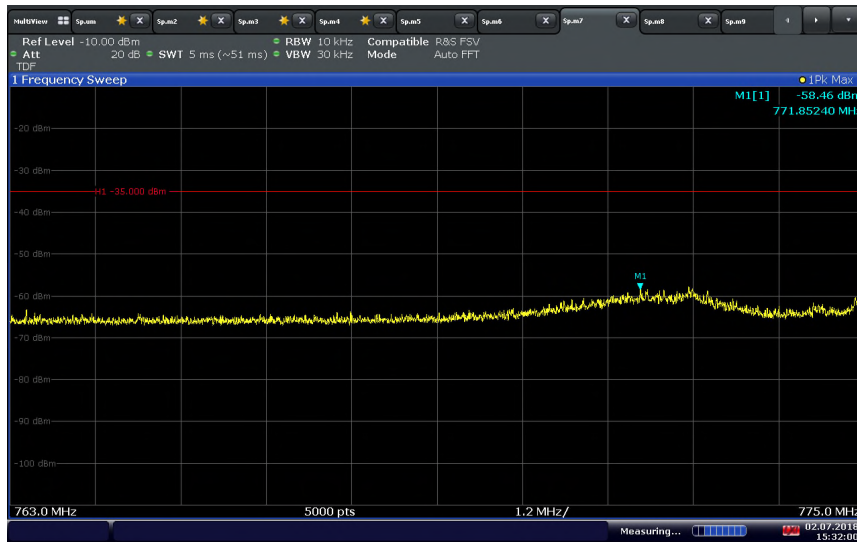

15:32:01 02.07.2018

CA_2A-13A_10+10 MHz Bandwidth_1905 MHz & 782 MHz_Full RB_QPSK / Conducted Spurious Emissions (793-806 MHz)

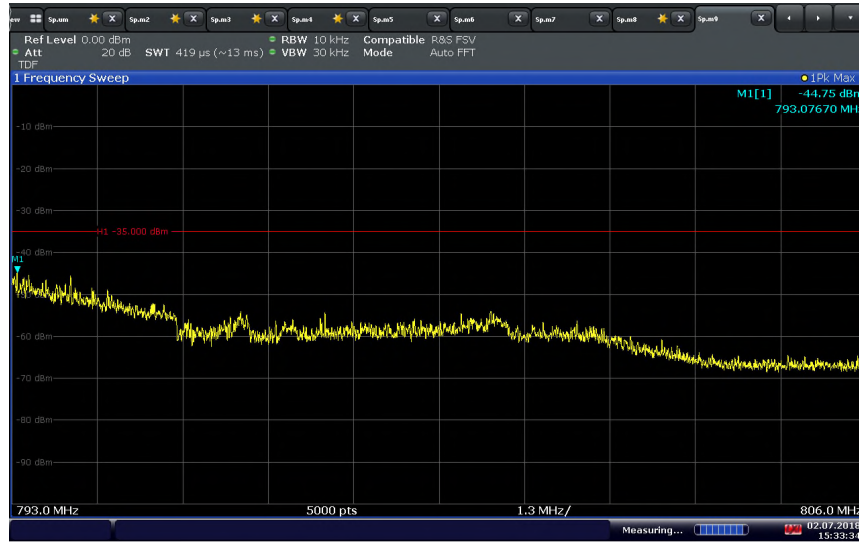

CA_2A-13A_10+10 MHz Bandwidth_1905 MHz & 782 MHz_1 RB_QPSK / Conducted Spurious Emissions (1559-1610 MHz)

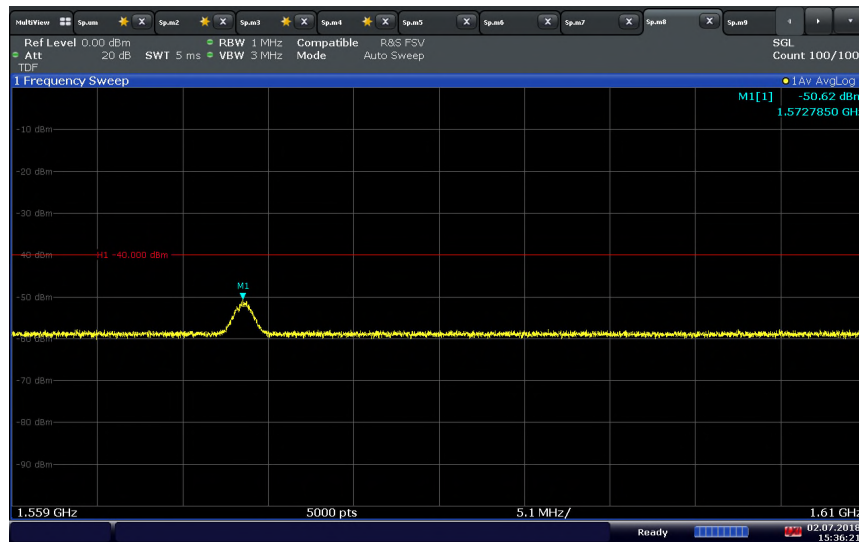



CA_4A-13A_10+10 MHz Bandwidth_1732.5 MHz & 782 MHz_Full RB_QPSK / Conducted Spurious Emissions

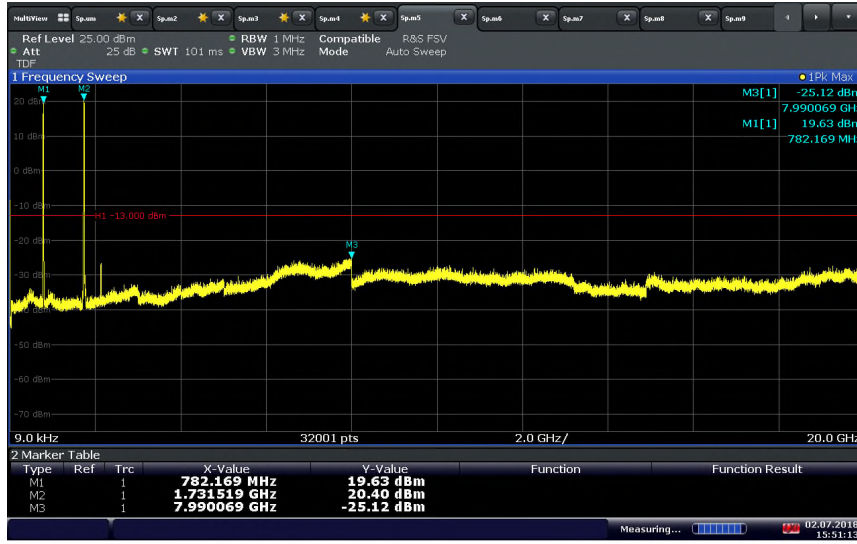

15:51:13 02.07.2018

CA_4A-13A_10+10 MHz Bandwidth_1732.5 MHz & 782 MHz_Full RB_QPSK / Conducted Spurious Emissions (763-775 MHz)

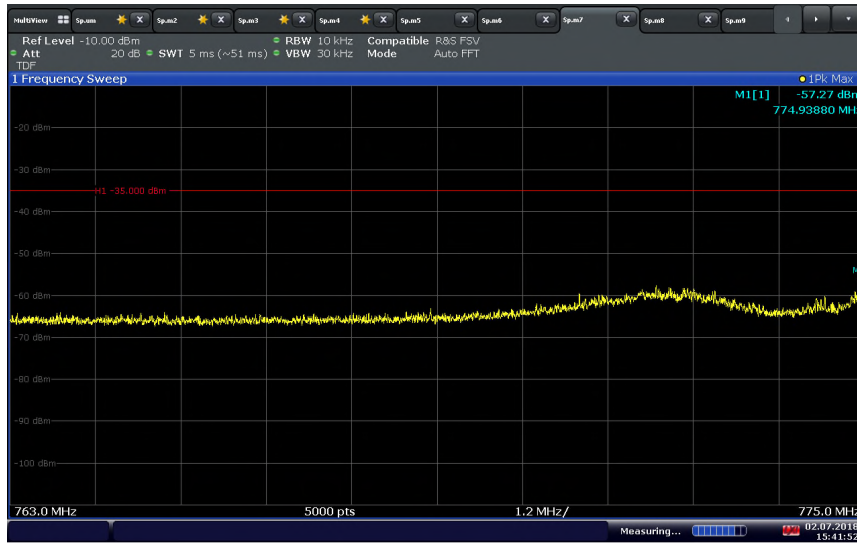

15:41:53 02.07.2018



CA_4A-13A_10+10 MHz Bandwidth_1732.5 MHz & 782 MHz_ Full RB_QPSK / Conducted Spurious Emissions (793-806 MHz)

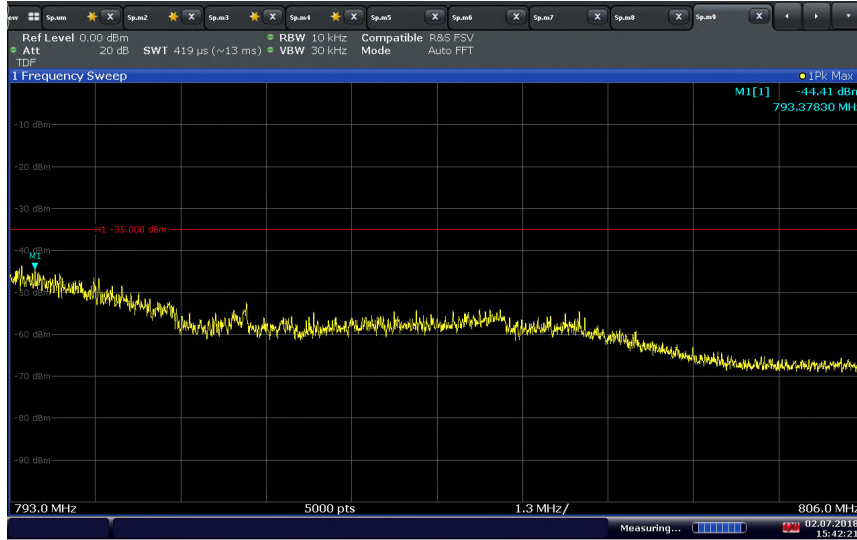

15:42:21 02.07.2018

CA_4A-13A_10+10 MHz Bandwidth_1732.5 MHz & 782 MHz_1 RB_QPSK / Conducted Spurious Emissions (1559-1610 MHz)

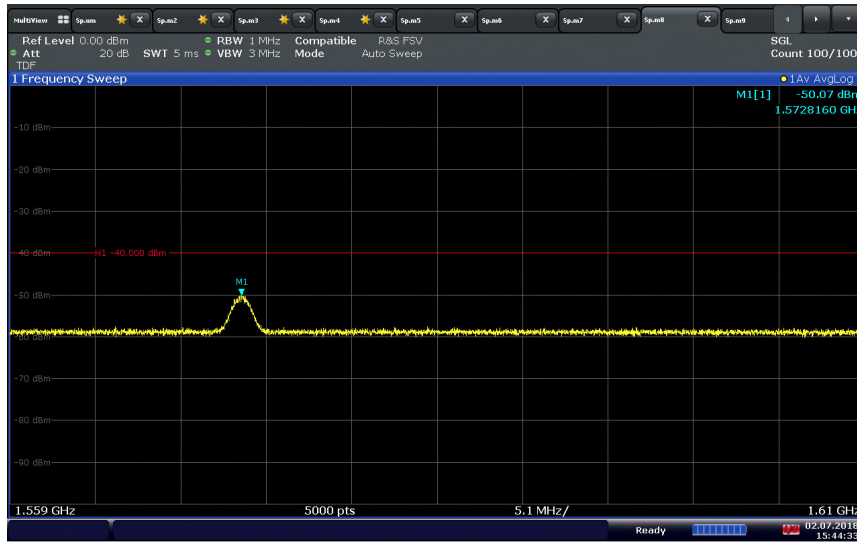

15:44:33 02.07.2018



CA_4A-13A_10+10 MHz Bandwidth_1750 MHz & 782 MHz_Full RB_QPSK / Conducted Spurious Emissions



15:50:07 02.07.2018

CA_4A-13A_10+10 MHz Bandwidth_1750 MHz & 782 MHz_Full RB_QPSK / Conducted Spurious Emissions (763-775 MHz)

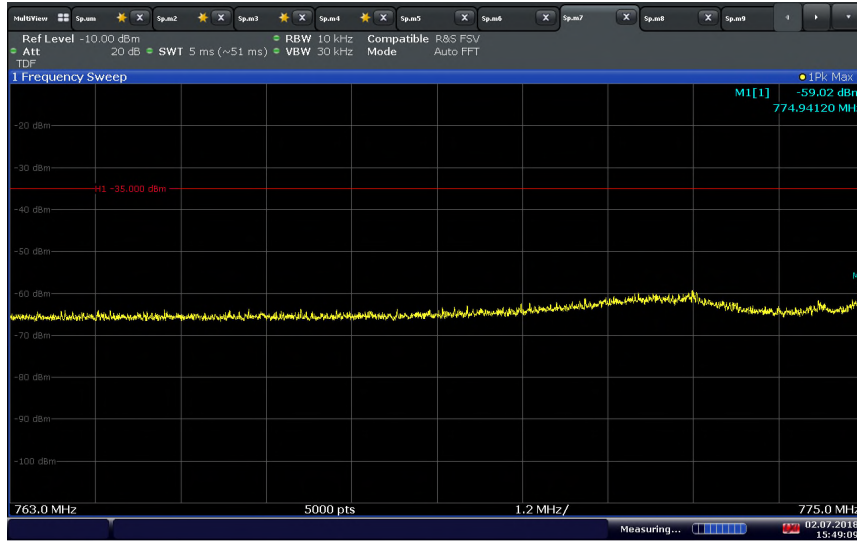

15:49:10 02.07.2018

**CA_4A-13A_10+10 MHz Bandwidth_1750 MHz & 782 MHz_Full RB_QPSK / Conducted Spurious Emissions
(793-806 MHz)**

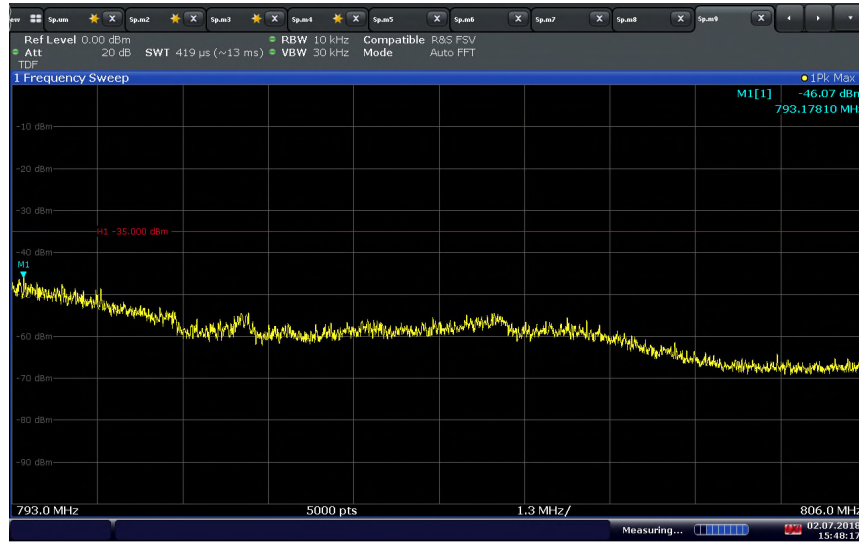

15:48:17 02.07.2018

**CA_4A-13A_10+10 MHz Bandwidth_1750 MHz & 782 MHz_1 RB_QPSK / Conducted Spurious Emissions
(1559-1610 MHz)**

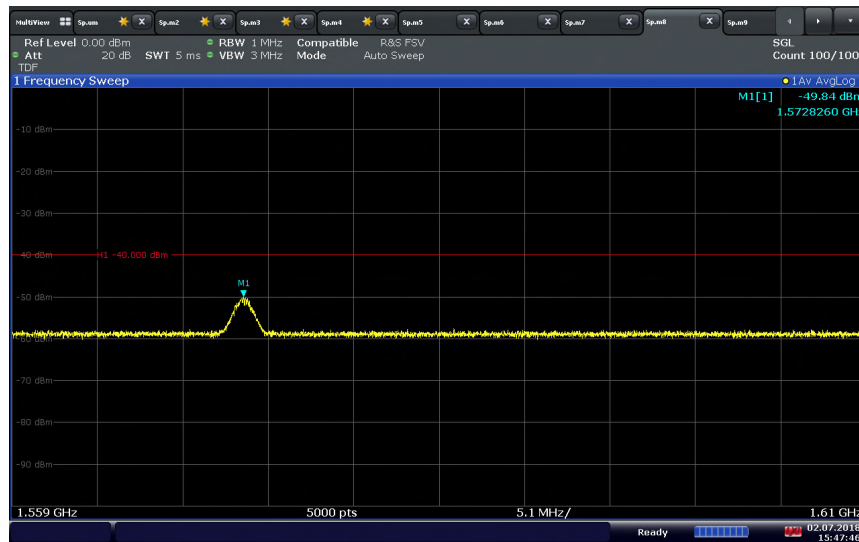

15:47:46 02.07.2018



CA_13A-66A_10+20 MHz Bandwidth_782 MHz & 1755 MHz_Full RB_QPSK / Conducted Spurious Emissions



15:54:01 02.07.2018

CA_13A-66A_10+20 MHz Bandwidth_782 MHz & 1755 MHz_Full RB_QPSK / Conducted Spurious Emissions (763-775 MHz)

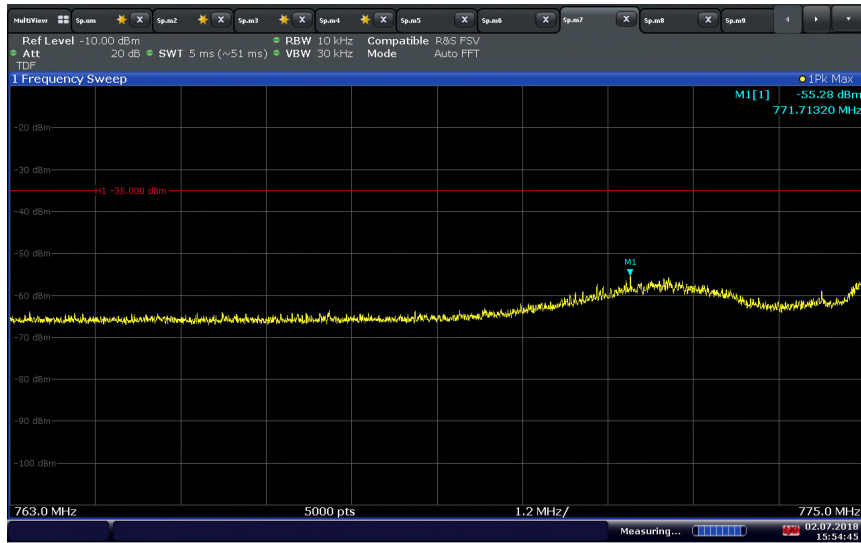

15:54:46 02.07.2018

**CA_13A-66A_10+20 MHz Bandwidth_782 MHz & 1755 MHz_Full RB_QPSK / Conducted Spurious Emissions
(793-806 MHz)**

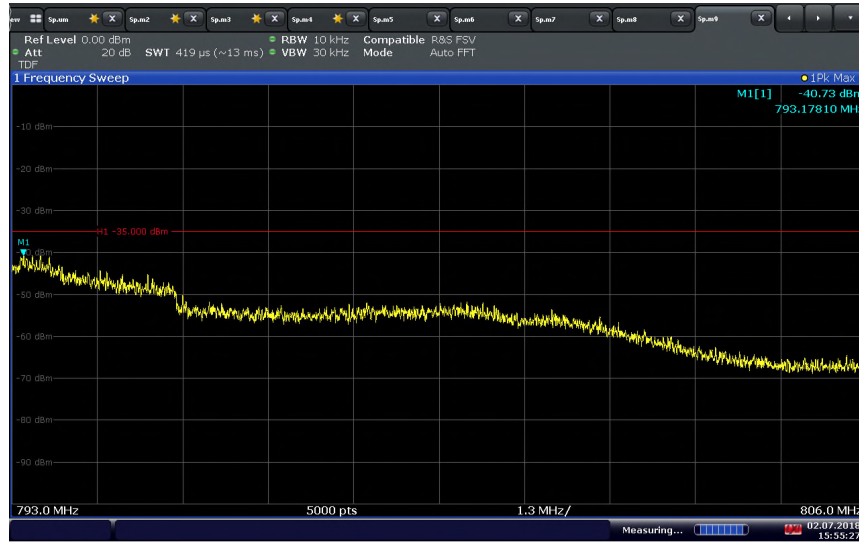

15:55:28 02.07.2018

**CA_13A-66A_10+20 MHz Bandwidth_782 MHz & 1755 MHz_1 RB_QPSK / Conducted Spurious Emissions
(1559-1610 MHz)**

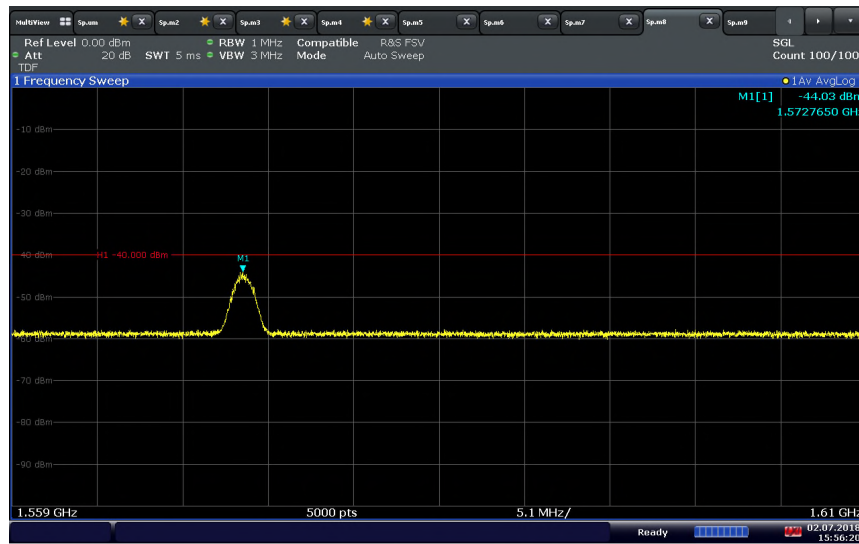

15:56:21 02.07.2018



CA_13A-66A_10+20 MHz Bandwidth_782 MHz & 1770 MHz_Full RB_QPSK / Conducted Spurious Emissions



16:01:12 02.07.2018

CA_13A-66A_10+20 MHz Bandwidth_782 MHz & 1770 MHz_Full RB_QPSK / Conducted Spurious Emissions
 (763-775 MHz)

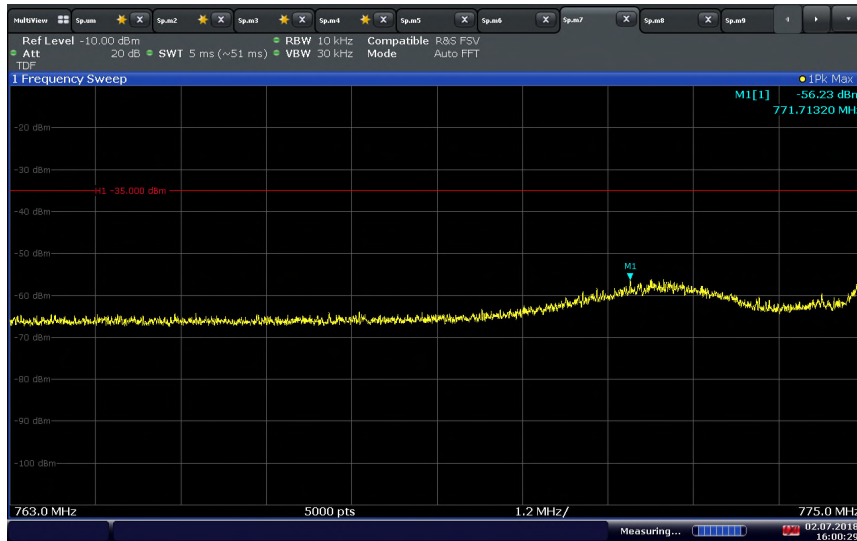

16:00:29 02.07.2018

**CA_13A-66A_10+20 MHz Bandwidth_782 MHz & 1770 MHz_Full RB_QPSK / Conducted Spurious Emissions
(793-806 MHz)**

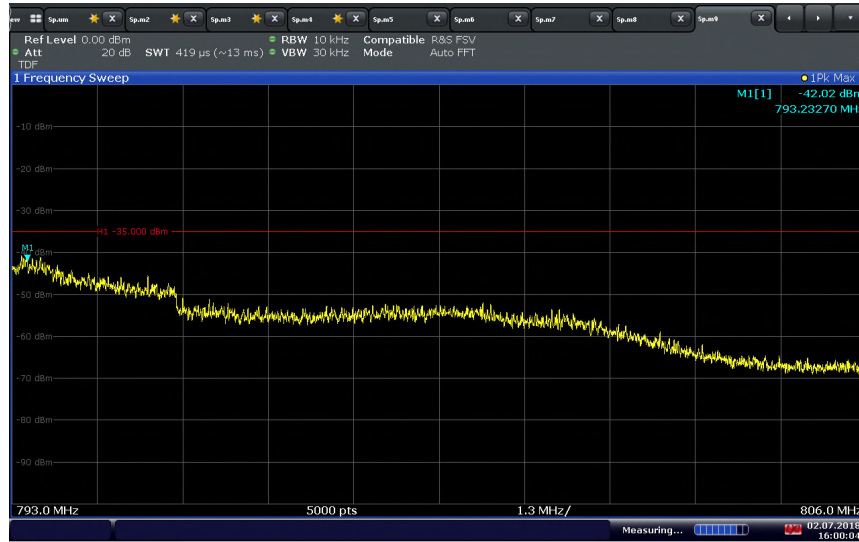

16:00:05 02.07.2018

**CA_13A-66A_10+20 MHz Bandwidth_782 MHz & 1770 MHz_1 RB_QPSK / Conducted Spurious Emissions
(1559-1610 MHz)**

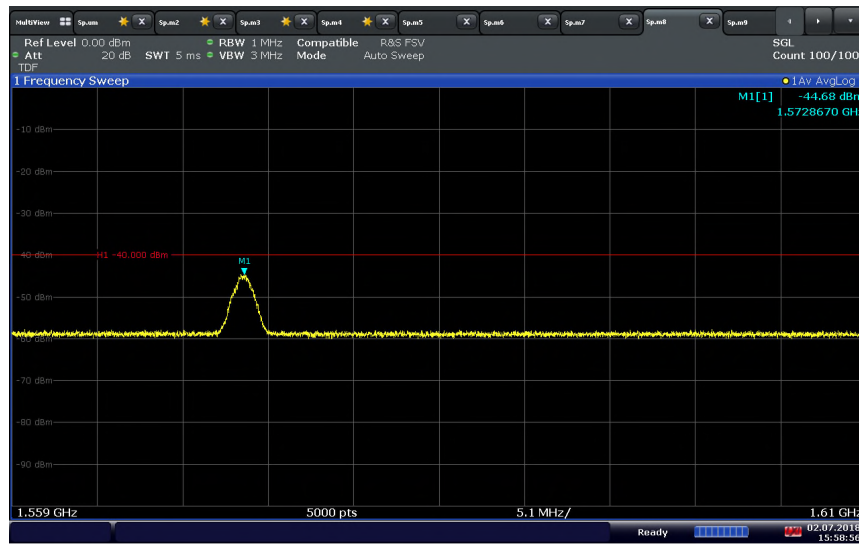

15:58:56 02.07.2018



2.7 FIELD STRENGTH OF SPURIOUS RADIATION

2.7.1 Specification Reference

FCC 47 CFR Part 2, Clause 2.1053
FCC 47 CFR Part 24, Clause 24.238(a)
FCC 47 CFR Part 27, Clause 27.53(h)
FCC 47 CFR Part 27, Clause 27.53(c)
RSS-133, Clause 6.5
RSS-139, Clause 6.6
RSS-130, Clause 4.6

2.7.2 Standard Applicable

FCC 47 CFR Part 24.238

(a) Out of band emissions. The power of any emission outside of the authorized operating frequency ranges must be attenuated below the transmitting power (P) by a factor of at least $43 + 10 \log(P)$ dB.

(b) Measurement procedure. Compliance with these rules is based on the use of measurement instrumentation employing a resolution bandwidth of 1 megahertz or greater. However, in the 1 megahertz bands immediately outside and adjacent to the frequency block a resolution bandwidth of at least one percent of the emission bandwidth of the fundamental emission of the transmitter may be employed.

FCC 47 CFR Part 27.53:

(h) AWS emission limits—(1) General protection levels. Except as otherwise specified below, for operations in the 1695-1710 MHz, 1710-1755 MHz, 1755-1780 MHz, 1915-1920 MHz, 1995-2000 MHz, 2000-2020 MHz, 2110-2155 MHz, 2155-2180 MHz, and 2180-2200 bands, the power of any emission outside a licensee's frequency block shall be attenuated below the transmitter power (P) in watts by at least $43 + 10 \log_{10}(P)$ dB

(c)(2) On any frequency outside the 776–788 MHz band, the power of any emission shall be attenuated outside the band below the transmitter power (P) by at least $43 + 10 \log(P)$ dB;

RSS-133, Clause 6.5.1

Equipment shall comply with the limits in (i) and (ii) below.

- (i) In the 1.0 MHz bands immediately outside and adjacent to the equipment's operating frequency block, the emission power per any 1% of the emission bandwidth shall be attenuated (in dB) below the transmitter output power P (dBW) by at least $43 + 10 \log_{10} p(\text{watts})$.
- (ii) After the first 1.0 MHz, the emission power in any 1 MHz bandwidth shall be attenuated (in dB) below the transmitter output power P (dBW) by at least $43 + 10 \log_{10} p(\text{watts})$. If the measurement is performed using 1% of the emission bandwidth, power integration over 1.0 MHz is required.

RSS-139, Clause 6.6

- (i) In the first 1.0 MHz bands immediately outside and adjacent to the equipment's smallest operating frequency block, which can contain the equipment's occupied bandwidth, the emission power per any 1% of the emission bandwidth shall be attenuated below the transmitter output power P (in dBW) by at least $43 + 10 \log_{10} p(\text{watts})$ dB.
- (ii) After the first 1.0 MHz outside the equipment's smallest operating frequency block, which can contain the equipment's occupied bandwidth, the emission power in any 1 MHz bandwidth shall be attenuated below the transmitter output power P (dBW) by at least $43 + 10 \log_{10} p(\text{watts})$ dB.



RSS-130, Clause 4.6.1

The power of any unwanted emissions in any 100 kHz bandwidth on any frequency outside the frequency range(s) within which the equipment is designed to operate shall be attenuated below the transmitter power, P (dBW), by at least $43 + 10 \log_{10} p$ (watts), dB. However, in the 100 kHz band immediately outside the equipment's operating frequency range, a resolution bandwidth of 30 kHz may be employed.

2.7.3 Equipment Under Test and Modification State

Serial No: AZ280418A00044 / Test Configuration B

2.7.4 Date of Test/Initial of test personnel who performed the test

July 05 and 06, 2018 / XYZ

2.7.5 Test Equipment Used

The major items of test equipment used for the above tests are identified in Section 3.1.

2.7.6 Environmental Conditions/ Test Location

Test performed at TÜV SÜD America Inc. Rancho Bernardo facility

Ambient Temperature	25.2 - 25.7 °C
Relative Humidity	45.7 - 52.3 %
ATM Pressure	98.7 - 99.1 kPa

2.7.7 Additional Observations

- This is a radiated test using substitution method as per Unwanted Emissions: Radiated Spurious method of measurement of ANSI/TIA/EIA-603-C 2004, August 17, 2004.
- Emissions within 6dB of the limit will be proven by substitution method.
- This is cabinet spurious emissions testing. Main antenna port was terminated during the test. Fundamental frequency measurement will be ignored for this test.
- Only the worst case configuration presented in this test report.
- Only noise floor measurements observed above 18GHz.
- Measurement was done using EMC32 V8.52 automated software. Reported level is the actual level with all the correction factors factored in. Correction Factor column is for informational purposes only.

2.7.8 Test Results

Compliant. See attached plots.



2.7.9 Radiated Emission Test Results Below 1GHz – Worst Case CA_2A-13A QPSK

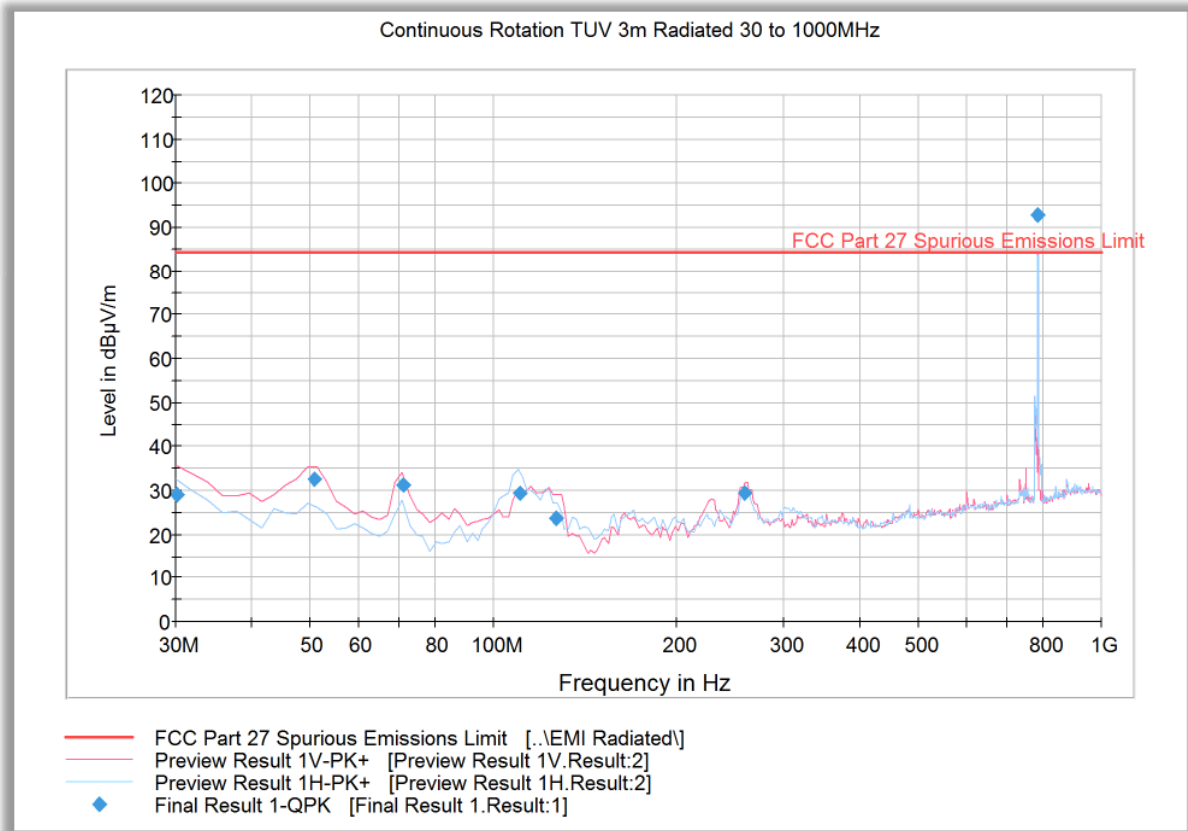

Quasi Peak Data

Frequency (MHz)	QuasiPeak (dBµV/m)	Meas. Time (ms)	Bandwidth (kHz)	Height (cm)	Polarization	Azimuth (deg)	Corr. (dB)	Margin (dB)	Limit (dBµV/m)
30.200000	29.2	1000.0	120.000	105.0	V	310.0	-6.5	55.2	84.4
50.782766	32.7	1000.0	120.000	100.0	V	173.0	-14.9	51.7	84.4
70.901643	31.2	1000.0	120.000	105.0	V	243.0	-17.2	53.2	84.4
110.739399	29.3	1000.0	120.000	195.0	H	15.0	-15.6	55.1	84.4
126.874389	23.6	1000.0	120.000	100.0	V	207.0	-16.1	60.8	84.4
259.162645	29.3	1000.0	120.000	100.0	V	44.0	-9.2	55.1	84.4
786.372345	92.9	1000.0	120.000	159.0	V	249.0	4.4	Fundamental Carrier*	

* This is the fundamental frequency not part of spurious emission evaluation. Data provided for information purpose only.



2.7.10 Radiated Emission Test Results Above 1GHz – Worst Case CA_2A-13A

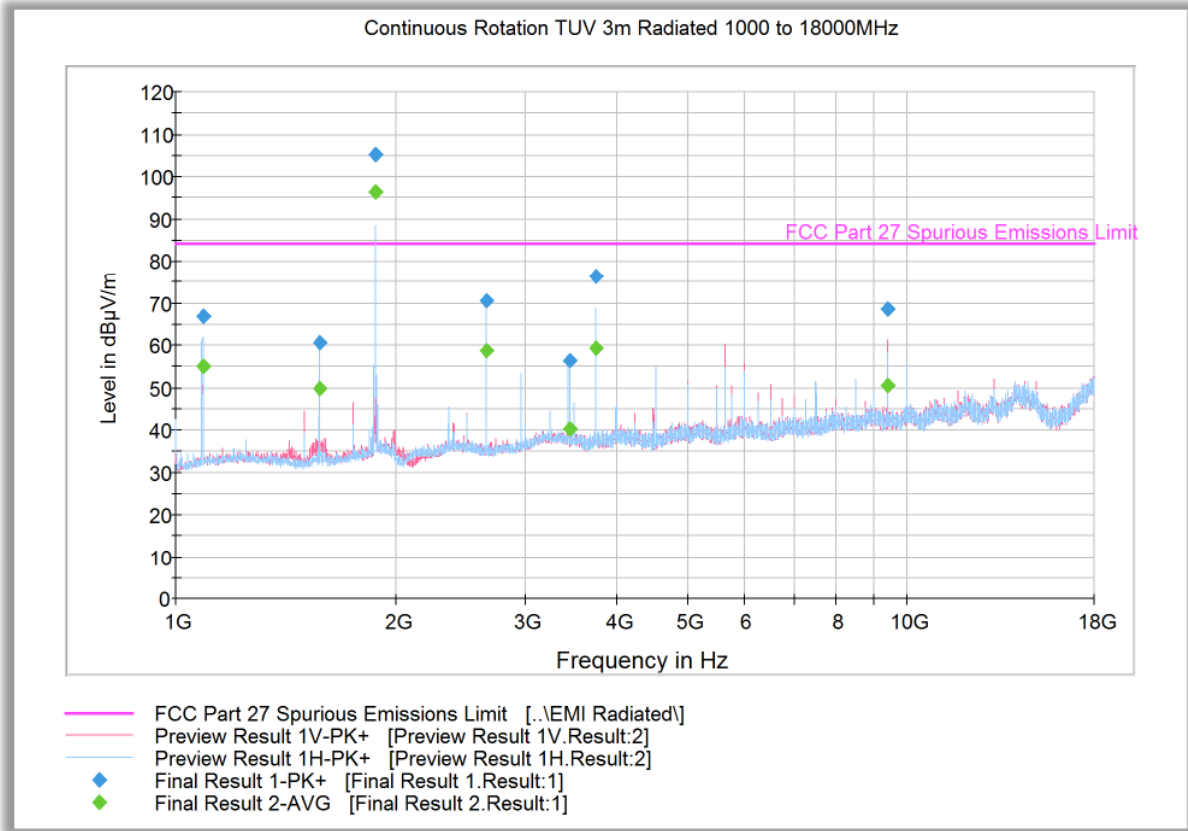

Peak Data

Frequency (MHz)	MaxPeak (dBµV/m)	Meas. Time (ms)	Bandwidth (kHz)	Height (cm)	Polarization	Azimuth (deg)	Corr. (dB)	Margin (dB)	Limit (dBµV/m)
1089.166667	66.8	1000.0	1000.000	99.7	H	209.0	-10.0	17.6	84.4
1572.733333	60.6	1000.0	1000.000	102.7	H	189.0	-8.5	23.8	84.4
1875.700000	105.3	1000.0	1000.000	151.2	H	208.0	-6.6	Fundamental Carrier*	
2661.866667	70.5	1000.0	1000.000	186.5	H	211.0	-4.0	13.9	84.4
3448.200000	56.3	1000.0	1000.000	103.7	H	199.0	-0.8	28.1	84.4
3751.000000	76.3	1000.0	1000.000	119.7	H	14.0	0.8	8.2	84.4
9377.800000	68.4	1000.0	1000.000	144.7	V	189.0	9.8	16.0	84.4

Average Data

Frequency (MHz)	Average (dBµV/m)	Meas. Time (ms)	Bandwidth (kHz)	Height (cm)	Polarization	Azimuth (deg)	Corr. (dB)	Margin (dB)	Limit (dBµV/m)
1089.166667	55.1	1000.0	1000.000	99.7	H	209.0	-10.0	29.3	84.4
1572.733333	49.9	1000.0	1000.000	102.7	H	189.0	-8.5	34.5	84.4
1875.700000	96.3	1000.0	1000.000	151.2	H	208.0	-6.6	Fundamental Carrier*	
2661.866667	58.6	1000.0	1000.000	186.5	H	211.0	-4.0	25.8	84.4
3448.200000	40.4	1000.0	1000.000	103.7	H	199.0	-0.8	44.0	84.4
3751.000000	59.3	1000.0	1000.000	119.7	H	14.0	0.8	25.1	84.4
9377.800000	50.5	1000.0	1000.000	144.7	V	189.0	9.8	33.9	84.4

* This is the fundamental frequency not part of spurious emission evaluation. Data provided for information purpose only.



2.7.11 Radiated Emission Test Results Below 1GHz – Worst Case CA_4A-13A QPSK

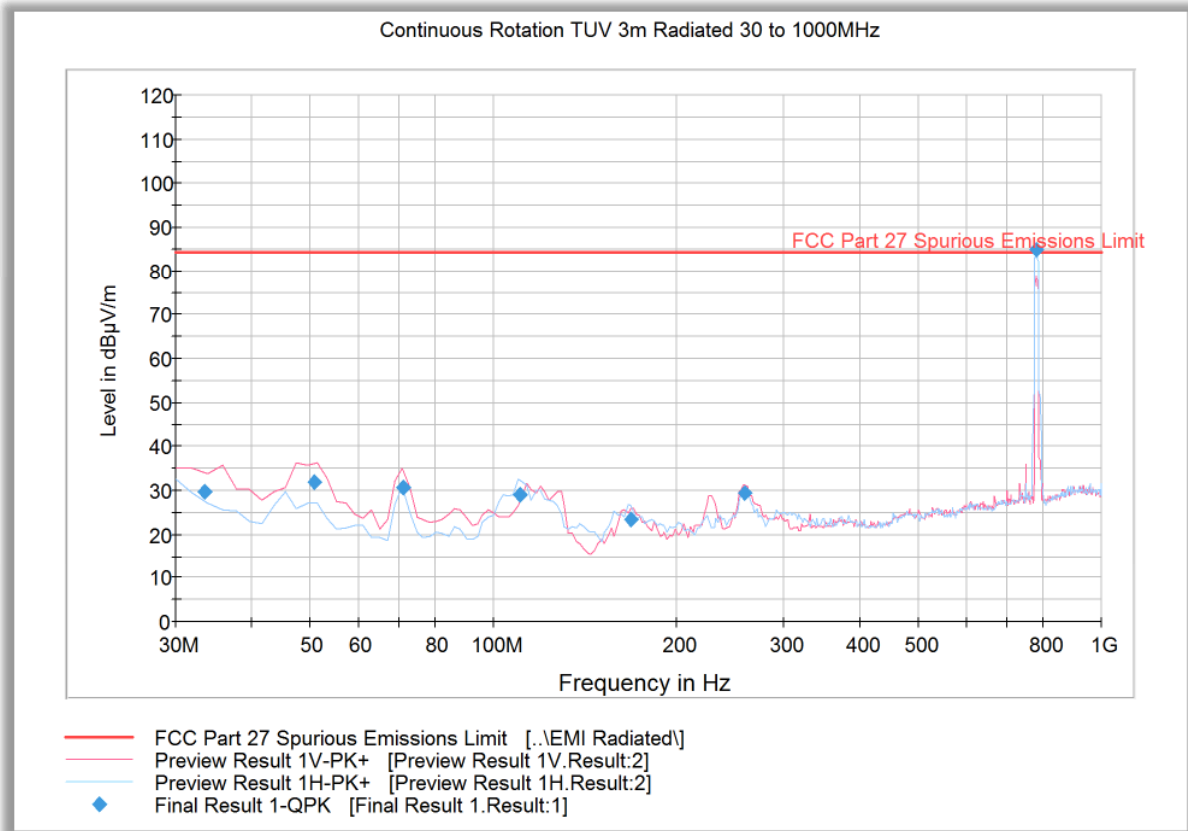

Quasi Peak Data

Frequency (MHz)	QuasiPeak (dBµV/m)	Meas. Time (ms)	Bandwidth (kHz)	Height (cm)	Polarization	Azimuth (deg)	Corr. (dB)	Margin (dB)	Limit (dBµV/m)
33.511663	29.7	1000.0	120.000	100.0	V	198.0	-9.1	54.7	84.4
50.654990	32.0	1000.0	120.000	100.0	V	15.0	-14.9	52.4	84.4
70.941643	30.6	1000.0	120.000	127.0	V	245.0	-17.2	53.8	84.4
110.659399	29.1	1000.0	120.000	183.0	H	177.0	-15.6	55.3	84.4
168.359920	23.3	1000.0	120.000	100.0	H	133.0	-12.4	61.1	84.4
259.458758	29.5	1000.0	120.000	100.0	V	31.0	-9.2	54.9	84.4
781.500681	85.0	1000.0	120.000	100.0	H	192.0	4.4	Fundamental Carrier*	

* This is the fundamental frequency not part of spurious emission evaluation. Data provided for information purpose only.



2.7.12 Radiated Emission Test Results Above 1GHz – Worst Case CA_4A-13A QPSK

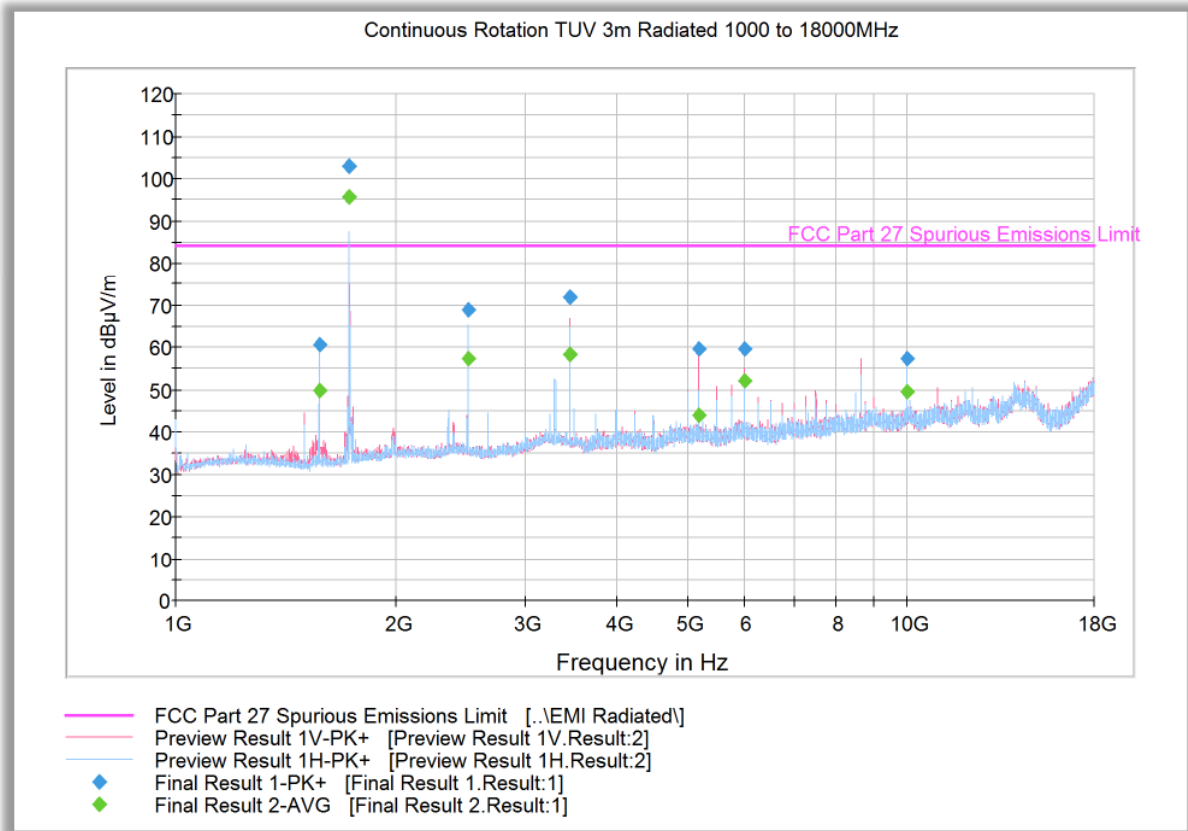

Peak Data

Frequency (MHz)	MaxPeak (dBµV/m)	Meas. Time (ms)	Bandwidth (kHz)	Height (cm)	Polarization	Azimuth (deg)	Corr. (dB)	Margin (dB)	Limit (dBµV/m)
1572.733333	60.7	1000.0	1000.000	103.7	H	195.0	-8.5	23.7	84.4
1728.000000	103.0	1000.0	1000.000	282.2	V	277.0	-7.4	Fundamental Carrier*	
2514.333333	68.9	1000.0	1000.000	152.2	H	218.0	-4.6	15.5	84.4
3456.133333	71.8	1000.0	1000.000	187.5	V	130.0	-0.8	12.6	84.4
5184.466667	59.8	1000.0	1000.000	296.2	V	174.0	3.4	24.6	84.4
5999.666667	59.7	1000.0	1000.000	223.4	V	201.0	4.5	24.7	84.4
10000.000000	57.4	1000.0	1000.000	311.2	H	185.0	10.3	27.0	84.4

Average Data

Frequency (MHz)	Average (dBµV/m)	Meas. Time (ms)	Bandwidth (kHz)	Height (cm)	Polarization	Azimuth (deg)	Corr. (dB)	Margin (dB)	Limit (dBµV/m)
1572.733333	50.0	1000.0	1000.000	103.7	H	195.0	-8.5	34.4	84.4
1728.000000	95.6	1000.0	1000.000	282.2	V	277.0	-7.4	Fundamental Carrier*	
2514.333333	57.4	1000.0	1000.000	152.2	H	218.0	-4.6	27.0	84.4
3456.133333	58.4	1000.0	1000.000	187.5	V	130.0	-0.8	26.0	84.4
5184.466667	43.8	1000.0	1000.000	296.2	V	174.0	3.4	40.6	84.4
5999.666667	52.1	1000.0	1000.000	223.4	V	201.0	4.5	32.3	84.4
10000.000000	49.6	1000.0	1000.000	311.2	H	185.0	10.3	34.8	84.4

* This is the fundamental frequency not part of spurious emission evaluation. Data provided for information purpose only.



2.7.13 Radiated Emission Test Results Below 1GHz – Worst Case CA_13A-66A

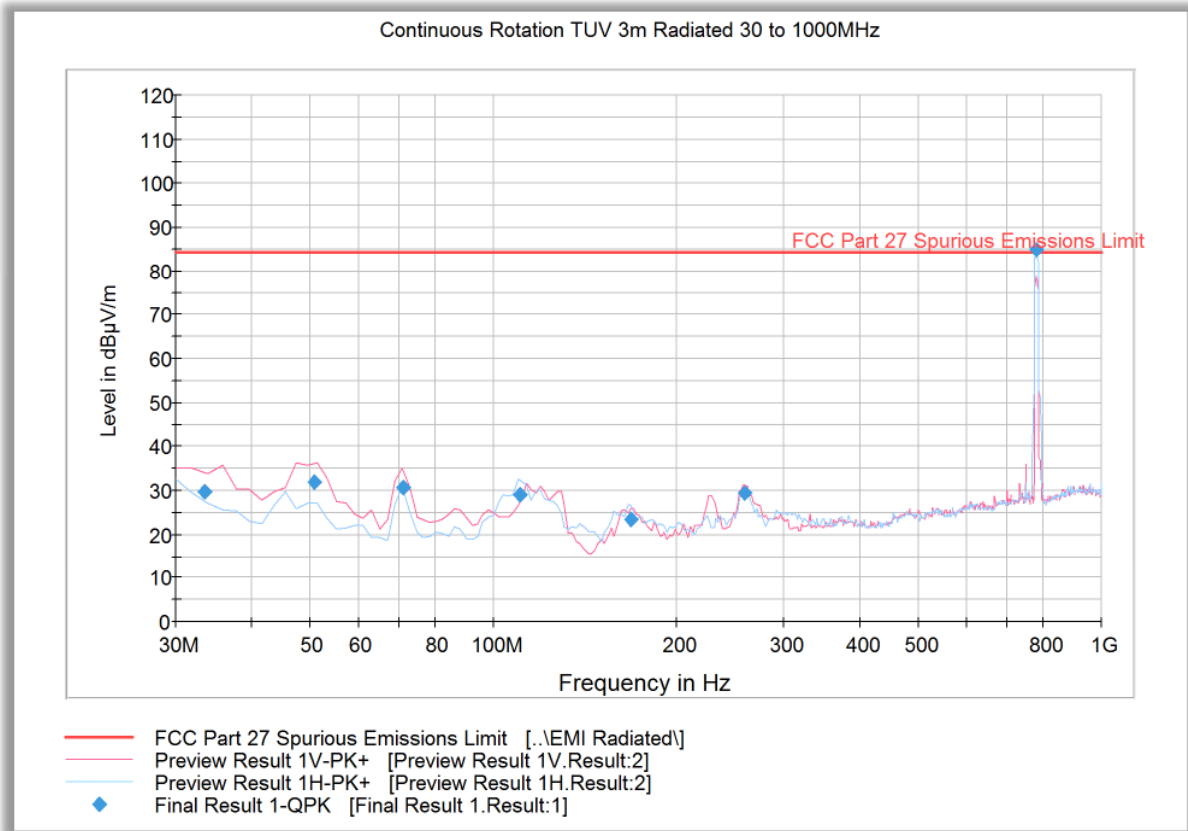

Quasi Peak Data

Frequency (MHz)	QuasiPeak (dBµV/m)	Meas. Time (ms)	Bandwidth (kHz)	Height (cm)	Polarization	Azimuth (deg)	Corr. (dB)	Margin (dB)	Limit (dBµV/m)
33.511663	29.7	1000.0	120.000	100.0	V	198.0	-9.1	54.7	84.4
50.654990	32.0	1000.0	120.000	100.0	V	15.0	-14.9	52.4	84.4
70.941643	30.6	1000.0	120.000	127.0	V	245.0	-17.2	53.8	84.4
110.659399	29.1	1000.0	120.000	183.0	H	177.0	-15.6	55.3	84.4
168.359920	23.3	1000.0	120.000	100.0	H	133.0	-12.4	61.1	84.4
259.458758	29.5	1000.0	120.000	100.0	V	31.0	-9.2	54.9	84.4
781.500681	85.0	1000.0	120.000	100.0	H	192.0	4.4	Fundamental Carrier*	

* This is the fundamental frequency not part of spurious emission evaluation. Data provided for information purpose only.



2.7.14 Radiated Emission Test Results Above 1GHz – Worst Case CA_13A-66A QPSK

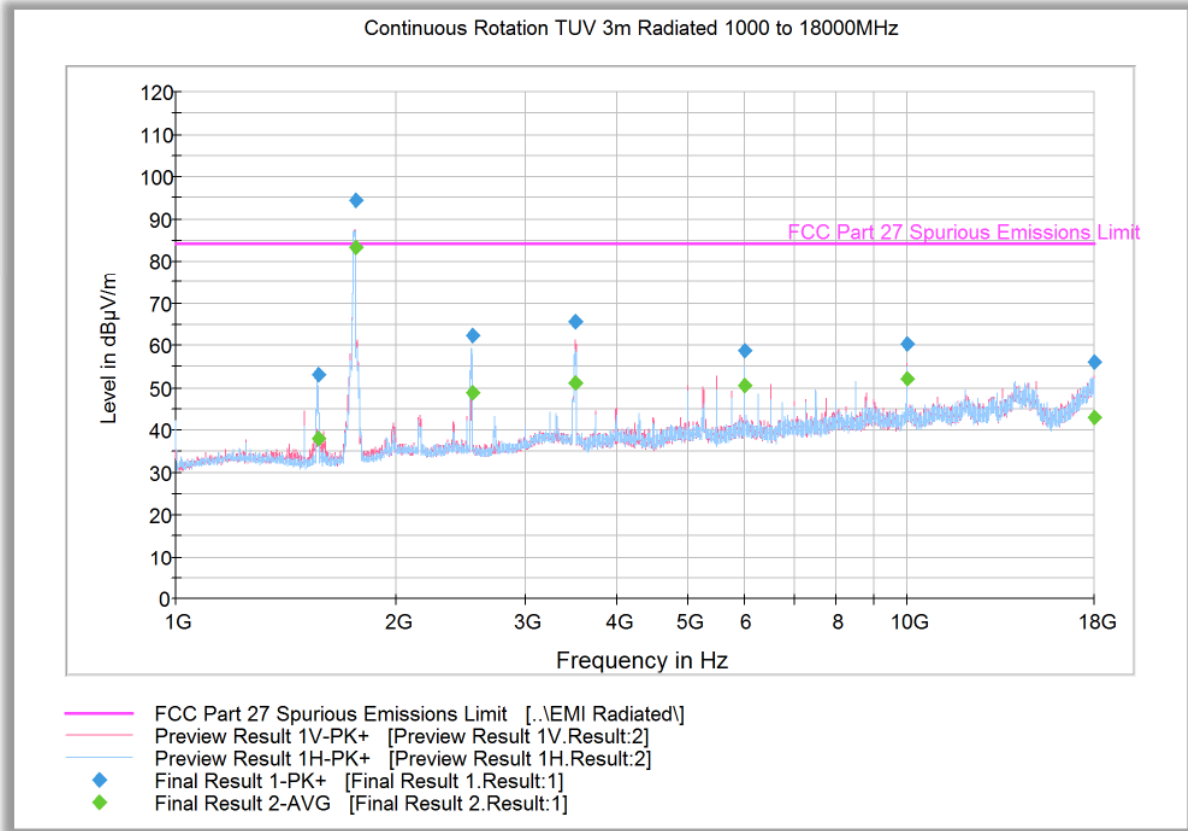

Peak Data

Frequency (MHz)	MaxPeak (dBµV/m)	Meas. Time (ms)	Bandwidth (kHz)	Height (cm)	Polarization	Azimuth (deg)	Corr. (dB)	Margin (dB)	Limit (dBµV/m)
1569.166667	53.2	1000.0	1000.000	103.7	H	197.0	-8.5	31.2	84.4
1762.933333	94.3	1000.0	1000.000	132.7	V	55.0	-6.9	Fundamental Carrier*	
2540.033333	62.2	1000.0	1000.000	99.7	H	202.0	-4.5	22.2	84.4
3522.233333	65.5	1000.0	1000.000	208.4	V	316.0	-0.6	18.9	84.4
5999.900000	58.8	1000.0	1000.000	352.7	H	122.0	4.5	25.6	84.4
10000.000000	60.3	1000.0	1000.000	296.2	V	187.0	10.3	24.1	84.4
17997.700000	56.0	1000.0	1000.000	280.2	V	5.0	21.4	28.4	84.4

Average Data

Frequency (MHz)	Average (dBµV/m)	Meas. Time (ms)	Bandwidth (kHz)	Height (cm)	Polarization	Azimuth (deg)	Corr. (dB)	Margin (dB)	Limit (dBµV/m)
1569.166667	38.1	1000.0	1000.000	103.7	H	197.0	-8.5	46.3	84.4
1762.933333	83.3	1000.0	1000.000	132.7	V	55.0	-6.9	Fundamental Carrier*	
2540.033333	48.8	1000.0	1000.000	99.7	H	202.0	-4.5	35.6	84.4
3522.233333	51.0	1000.0	1000.000	208.4	V	316.0	-0.6	33.4	84.4
5999.900000	50.6	1000.0	1000.000	352.7	H	122.0	4.5	33.8	84.4
10000.000000	52.2	1000.0	1000.000	296.2	V	187.0	10.3	32.2	84.4
17997.700000	42.9	1000.0	1000.000	280.2	V	5.0	21.4	41.5	84.4

* This is the fundamental frequency not part of spurious emission evaluation. Data provided for information purpose only.



2.8 FREQUENCY STABILITY

2.8.1 Specification Reference

FCC 47 CFR Part 2, Clause 2.1055
FCC 47 CFR Part 24, Clause 24.235
FCC 47 CFR Part 27, Clause 27.54
RSS-133, Clause 6.3
RSS-139, Clause 6.4
RSS-130, Clause 4.3

2.8.2 Standard Applicable

FCC 47 CFR Part 24.235 and FCC 47 CFR Part 27.54:

The frequency stability shall be sufficient to ensure the fundamental emissions stays within the authorized frequency block.

RSS-133, Clause 6.3

The carrier frequency shall not depart from the reference frequency, in excess of ± 2.5 ppm for mobile stations and ± 1.0 ppm for base station.

RSS-139, Clause 6.4

The frequency shall be sufficient to ensure that the occupied bandwidth stays within the operating frequency block when tested to the temperature and supply voltage variations specified in RSS-GEN.

RSS-130, Clause 4.3

(a) The frequency offset shall be measured according to the procedure described in RSS-Gen and recorded;

(b) Using a resolution bandwidth of 1% of the occupied bandwidth, a reference point at the unwanted emission level which complies with the attenuation of $43 + 10 \log_{10} p$ (watts) on the emission mask of the lowest and highest channel shall be selected, and the frequency at these points shall be recorded as f_L and f_H respectively.

The applicant shall ensure frequency stability by showing that f_L minus the frequency offset and f_H plus the frequency offset shall be within the frequency range in which the equipment is designed to operate.

2.8.3 Equipment Under Test and Modification State

Serial No: AZ280418A00044 / Test Configuration A

2.8.4 Date of Test/Initial of test personnel who performed the test

June 26 and July 03, 2018 / XYZ



2.8.5 Test Equipment Used

The major items of test equipment used for the above tests are identified in Section 3.1.

2.8.6 Environmental Conditions/ Test Location

Test performed at TÜV SÜD America Inc. Rancho Bernardo facility

Ambient Temperature	25.8 - 28.3 °C
Relative Humidity	47.3 - 49.4 %
ATM Pressure	98.7 - 98.9 kPa

2.8.7 Additional Observations

- This is a conducted test. The EUT was operated at 3.7 VDC nominal voltage and was placed in the temperature chamber for this evaluation. The EUT was controlled by a CMW500 and utilizing a spectrum analyser for measurement.
- Measurement was done using the CMW 500 measurement function.
- The EUT was tested over the temperature -30°C to +50°C in 10°C steps and allowed to sit for 1 hour to allow the equipment and chamber temperature to stabilize. The measurements were then performed.
- Voltage variation was also performed at voltage 3.3VDC and higher 4.3VDC of the nominal voltage at 20°C.
- The maximum frequency deviation for LTE Band 13 was verified against the frequency band edges using reference points F_L and F_H at the unwanted emission level which complies with the attenuation of $43 + 10 \log_{10} p$ (watts) on the emission mask of the lowest and highest channel.



2.8.8 Test Results

CA_2A_13A – QPSK 10 MHz & 10 MHz BW- Channel 1880 + 782 MHz				
Voltage (VDC)	Temperature (°C)	Frequency Error (Hz) LTE Band 2 / Band 13	Frequency Error (ppm) LTE Band 2 / Band 13	Limit (ppm)*
3.7	-30	17.6/-10.0	0.009/-0.013	±2.5 / ±0.1
	-20	17.71/-10.3	0.009/-0.013	±2.5 / ±0.1
	-10	16.51/-11.24	0.009/-0.014	±2.5 / ±0.1
	0	16.31/-9.9	0.009/-0.013	±2.5 / ±0.1
	+10	15.81/-10.77	0.008/-0.014	±2.5 / ±0.1
	+20	15.31/-11.22	0.008/-0.014	±2.5 / ±0.1
	+30	14.89/-10.34	0.008/-0.013	±2.5 / ±0.1
	+40	15.18/-10.76	0.008/-0.014	±2.5 / ±0.1
3.3	20	14.36/-11.32	0.008/-0.014	±2.5 / ±0.1
4.3		16.45/-10.24	0.009/-0.013	±2.5 / ±0.1

CA_2A_13A – QPSK 10 MHz & 10 MHz BW- Channel 1880 + 782 MHz LTE Band 13						
Voltage (VDC)	Temperature (°C)	F _L (MHz)	F _L – Freq Error (MHz)	F _H (MHz)	F _L + Freq Error (MHz)	Compliance
3.7	-30	777.209	777.209	786.779	786.779	Yes
	+20	777.245	777.245	786.773	786.773	Yes
	+50	777.281	777.281	786.749	786.749	Yes
3.3	20	777.215	777.215	786.767	786.767	Yes
4.3		777.221	777.221	786.779	786.779	Yes

*Limit for LTE Band 13 is according to 3GPP TS 36 010 V14.4.0

The frequency stability of the EUT is sufficient to keep it within the authorised frequency ranges at any temperature interval and voltage variations across the measured range.



CA_4A_13A – QPSK 10 MHz & 10 MHz BW- Channel 1732.5 + 782 MHz				
Voltage (VDC)	Temperature (°C)	Frequency Error (Hz) LTE Band 4 / Band 13	Frequency Error (ppm) LTE Band 4 / Band 13	Limit (ppm)*
3.7	-30	18.07/-10.3	0.01/-0.013	±0.1
	-20	16.34/-11.43	0.009/-0.015	±0.1
	-10	18.17/-10.26	0.01/-0.013	±0.1
	0	17.97/-9.9	0.01/-0.013	±0.1
	+10	16.89/-10.1	0.01/-0.013	±0.1
	+20	16.29/-10.13	0.009/-0.013	±0.1
	+30	14.61/-11.67	0.008/-0.015	±0.1
	+40	16.31/-10.1	0.009/-0.013	±0.1
	+50	16.06/-11.04	0.009/-0.014	±0.1
3.3	20	17.58 / -10.61	0.01/-0.014	±0.1
4.3		17.47 / -11.43	0.01/-0.015	±0.1

CA_4A_13A – QPSK 10 MHz & 10 MHz BW- Channel 1732.5 + 782 MHz LTE Band 13						
Voltage (VDC)	Temperature (°C)	F _L (MHz)	F _L – Freq Error (MHz)	F _H (MHz)	F _L + Freq Error (MHz)	Compliance
3.7	-30	777.251	777.251	786.809	786.809	Yes
	+20	777.251	777.251	786.773	786.773	Yes
	+50	777.221	777.221	786.779	786.779	Yes
3.3	20	77.257	77.257	786.767	786.767	Yes
4.3		777.251	777.251	786.773	786.773	Yes

*Limit according to 3GPP TS 36 010 V14.4.0

The frequency stability of the EUT is sufficient to keep it within the authorised frequency ranges at any temperature interval and voltage variations across the measured range.



CA_13A_66A – QPSK 10 MHz & 20 MHz BW- Channel 782 + 1755 MHz				
Voltage (VDC)	Temperature (°C)	Frequency Error (Hz) LTE Band 13 / Band 66	Frequency Error (ppm) LTE Band 13 / Band 66	Limit (ppm)*
3.7	-30	-10.29/-19.45	-0.013/-0.011	±0.1
	-20	-9.73/-20.43	-0.012/-0.012	±0.1
	-10	-9.81/18.54	-0.013/0.011	±0.1
	0	-9.31/17.48	-0.012/0.010	±0.1
	+10	-10.93/16.67	-0.014/0.009	±0.1
	+20	-9.78/16.84	-0.013/0.01	±0.1
	+30	-11.06/16.52	-0.014/0.009	±0.1
	+40	-9.44/18.01	-0.012/0.01	±0.1
3.3	20	-12.9 / 16.55	-0.017/0.009	±0.1
4.3		-11.72 / 16.22	-0.015/0.009	±0.1

CA_13A_66A – QPSK 10 MHz & 10 MHz BW- Channel 782 + 1755 MHz LTE Band 13						
Voltage (VDC)	Temperature (°C)	F _L (MHz)	F _L – Freq Error (MHz)	F _H (MHz)	F _L + Freq Error (MHz)	Compliance
3.7	-30	777.161	777.161	786.833	786.833	Yes
	+20	777.137	777.137	786.863	786.863	Yes
	+50	777.203	777.203	786.803	786.803	Yes
3.3	20	777.149	777.149	786.833	786.833	Yes
4.3		777.155	777.155	786.839	786.839	Yes

*Limit according to 3GPP TS 36 010 V14.4.0

The frequency stability of the EUT is sufficient to keep it within the authorised frequency ranges at any temperature interval and voltage variations across the measured range.



2.9 CONDUCTED EMISSIONS

2.9.1 Specification Reference

FCC CFR 47 Part 15, Clause 15.207(a)
RSS-Gen, Section 8.8

2.9.2 Standard Applicable

An intentional radiator that is designed to be connected to the public utility (AC) power line, the radio frequency voltage that is conducted back onto the AC power line on any frequency or frequencies, within the band 150 kHz to 30 MHz, shall not exceed the limits in the following table, as measured using a 50 μ H/50 ohms line impedance stabilization network (LISN).

Frequency of emission (MHz)	Conducted limit (dB μ V)	
	Quasi-peak	Average
0.15–0.5	66 to 56*	56 to 46*
0.5–5	56	46
5–30	60	50

*Decreases with the logarithm of the frequency.

2.9.3 Equipment Under Test and Modification State

Serial No: AZ280418A00044/Test Configuration B

2.9.4 Date of Test/Initial of test personnel who performed the test

July 16, 2018/XYZ

2.9.5 Test Equipment Used

The major items of test equipment used for the above tests are identified in Section 3.1.

2.9.6 Environmental Conditions/ Test Location

Test performed at TÜV SÜD America Inc. Rancho Bernardo facility

Ambient Temperature 25.1 °C
Relative Humidity 53.7 %
ATM Pressure 99.0 kPa

2.9.7 Additional Observations

Measurement was done using EMC32 V8.53 automated software. Reported level is the actual level with all the correction factors factored in. Correction Factor column is for informational purposes only. See Section 2.1.8 for sample computation.



2.9.8 Sample Computation (Conducted Emission – Quasi Peak)

Measuring equipment raw measurement (db μ V) @ 150kHz			5.5
Correction Factor (dB)	Asset# 8607 (20 dB attenuator)	19.9	20.7
	Asset# 1177 (cable)	0.15	
	Asset# 1176 (cable)	0.35	
	Asset# 7568 (LISN)	0.30	
Reported QuasiPeak Final Measurement (db μ V) @ 150kHz			26.2

2.9.9 Test Results

Compliant. See attached plots and tables.

2.9.10 MIFI8800L 120VAC 60Hz (Line 1)

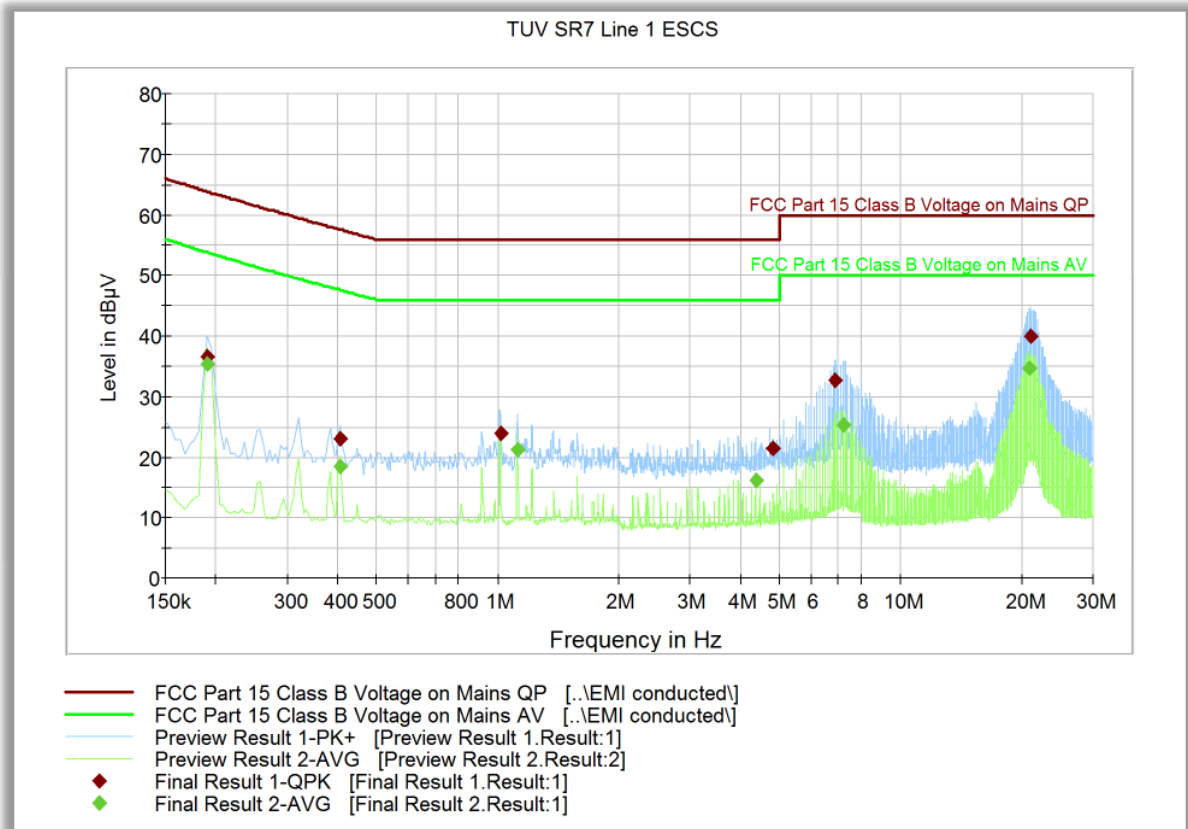

Quasi Peak

Frequency (MHz)	QuasiPeak (dBµV)	Meas. Time (ms)	Bandwidth (kHz)	Filter	Line	Corr. (dB)	Margin - QPK (dB)	Limit - QPK (dBµV)
0.190500	36.6	1000.0	9.000	Off	L1	20.2	27.3	63.9
0.406500	23.1	1000.0	9.000	Off	L1	20.2	34.6	57.6
1.018500	23.9	1000.0	9.000	Off	L1	20.2	32.1	56.0
4.830000	21.4	1000.0	9.000	Off	L1	20.4	34.6	56.0
6.900000	32.6	1000.0	9.000	Off	L1	20.5	27.4	60.0
20.998500	40.1	1000.0	9.000	Off	L1	20.8	19.9	60.0

Average

Frequency (MHz)	Average (dBµV)	Meas. Time (ms)	Bandwidth (kHz)	Filter	Line	Corr. (dB)	Margin - Ave (dB)	Limit - Ave (dBµV)
0.190500	35.4	1000.0	9.000	Off	L1	20.2	18.4	53.9
0.406500	18.6	1000.0	9.000	Off	L1	20.2	29.0	47.6
1.117500	21.3	1000.0	9.000	Off	L1	20.2	24.7	46.0
4.366500	16.2	1000.0	9.000	Off	L1	20.4	29.8	46.0
7.197000	25.4	1000.0	9.000	Off	L1	20.5	24.6	50.0
20.800500	34.7	1000.0	9.000	Off	L1	20.7	15.3	50.0

2.9.11 MIFI8800L 120VAC 60Hz (Line 2)

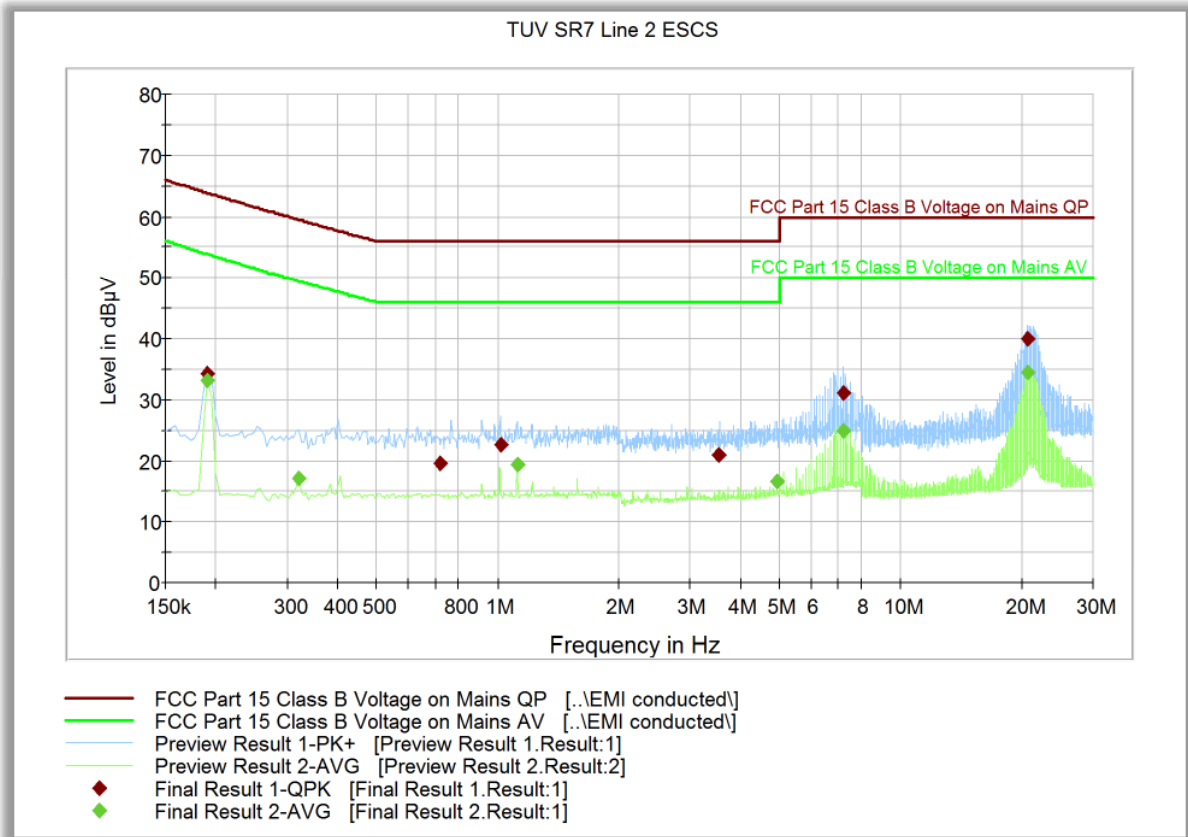

Quasi Peak

Frequency (MHz)	QuasiPeak (dBµV)	Meas. Time (ms)	Bandwidth (kHz)	Filter	Line	Corr. (dB)	Margin - QPK (dB)	Limit - QPK (dBµV)
0.190500	34.3	1000.0	9.000	Off	N	20.2	29.6	63.9
0.717000	19.5	1000.0	9.000	Off	N	20.2	36.5	56.0
1.018500	22.7	1000.0	9.000	Off	N	20.2	33.3	56.0
3.547500	21.0	1000.0	9.000	Off	N	20.4	35.0	56.0
7.197000	31.0	1000.0	9.000	Off	N	20.4	29.0	60.0
20.701500	39.9	1000.0	9.000	Off	N	20.7	20.1	60.0

Average

Frequency (MHz)	Average (dBµV)	Meas. Time (ms)	Bandwidth (kHz)	Filter	Line	Corr. (dB)	Margin - Ave (dB)	Limit - Ave (dBµV)
0.190500	33.1	1000.0	9.000	Off	N	20.2	20.8	53.9
0.321000	17.1	1000.0	9.000	Off	N	20.3	32.4	49.5
1.117500	19.5	1000.0	9.000	Off	N	20.3	26.5	46.0
4.929000	16.6	1000.0	9.000	Off	N	20.5	29.4	46.0
7.197000	24.9	1000.0	9.000	Off	N	20.4	25.1	50.0
20.701500	34.4	1000.0	9.000	Off	N	20.7	15.6	50.0



SECTION 3

TEST EQUIPMENT USED



3.1 TEST EQUIPMENT USED

List of absolute measuring and other principal items of test equipment.

ID Number (SDGE/SDRB)	Test Equipment	Type	Serial Number	Manufacturer	Cal Date	Cal Due Date
Antenna Conducted Port Setup						
7662	P-Series Power Meter	N1911A	MY45100951	Agilent	06/15/18	06/15/19
7661	50MHz-18GHz Wideband Power Sensor	N1921A	MY45241383	Agilent	06/15/18	06/15/19
7608	Vector Signal Generator	SMBV100A	259021	Rhode & Schwarz	09/19/17	09/19/19
7582	Signal/Spectrum Analyzer	FSW26	101614	Rhode & Schwarz	12/14/17	12/14/18
-	Wideband Radio Communication Tester	CMW 500	158164	Rhode & Schwarz	04/04/18	04/04/19
8825	20dB Attenuator	46-20-34	BK5773	Weinschel Corp.	Verified by 7608 and 7582	
-	10dB Attenuator	VAT-10W2+2W	N/A	MCL	Verified by 7608 and 7582	
AC Conducted Emissions Test Setup						
1024	EMI Test Receiver	ESCS 30	847793/001	Rhode & Schwarz	09/15/17	09/15/18
7567	LISN	FCC-LISN-50-25-2	120304	Fischer Custom Comm.	12/14/17	12/14/19
8822	20dB Attenuator	34-20-34	N/A	MCE / Weinschel	Verified by 7608 and 7582	
8824	20dB Attenuator	34-20-34	N/A	MCE / Weinschel	Verified by 7608 and 7582	
7582	Signal/Spectrum Analyzer	FSW26	101614	Rhode & Schwarz	12/14/17	12/14/18
7608	Vector Signal Generator	SMBV100A	259021	Rhode & Schwarz	09/19/17	09/19/19
-	Wideband Radio Communication Tester	CMW 500	158164	Rhode & Schwarz	04/04/18	04/04/19
Radiated Test Setup						
7582	Signal/Spectrum Analyzer	FSW26	101614	Rhode & Schwarz	12/14/17	12/14/18
7608	Vector Signal Generator	SMBV100A	259021	Rhode & Schwarz	09/19/17	09/19/19
1033	Bilog Antenna	3142C	00044556	EMCO	10/11/16	10/11/18
7575	Double-ridged waveguide horn antenna	3117	00155511	EMCO	06/16/18	06/16/20
1193	Pre-amplifier	PAM-0202	185	A.H. Systems, Inc.	04/11/18	04/11/19
8921	High-frequency cable	SucoFlex 100 SX	N/A	Suhner	Verified by 7608 and 7582	
8923	High-frequency cable	Micropore 19057793	N/A	United Microwave Products	Verified by 7608 and 7582	
1040	EMI Test Receiver	ESIB40	100292	Rhode & Schwarz	10/25/17	10/25/18
1049	EMI Test Receiver	ESU	100133	Rhode & Schwarz	07/13/18	07/13/19
8628	Pre-amplifier	QLI-01182835-JO	8986002	Quinstar	02/06/18	02/06/19
-	Wideband Radio Communication Tester	CMW 500	158164	Rhode & Schwarz	04/04/18	04/04/19



America

Miscellaneous						
6708	Multimeter	34401A	US36086974	Hewlett Packard	07/18/18	07/18/19
7579	Temperature Chamber	115	151617	TestQuity	08/22/17	08/22/18
11312	Mini Environmental Quality Meter	850027	CF099-56010-340	Sper Scientific	02/26/18	02/26/19
	Test Software	EMC32	V8.53	Rhode & Schwarz	N/A	

3.2 MEASUREMENT UNCERTAINTY

For a 95% confidence level, the measurement uncertainties for defined systems are:

3.2.1 Radiated Emission Measurements (Below 1GHz)

Contribution		Probability Distribution Type	Probability Distribution x_i	Standard Uncertainty $u(x_i)$	$[u(x_i)]^2$
1	Receiver/Spectrum Analyzer	Rectangular	0.45	0.26	0.07
2	Cables	Rectangular	0.50	0.29	0.08
3	Preamp	Rectangular	0.50	0.29	0.08
4	Antenna	Rectangular	0.75	0.43	0.19
5	Site	Rectangular	3.52	1.44	2.07
6	EUT Setup	Rectangular	1.00	0.58	0.33
Combined Uncertainty (u_c):					1.68
Coverage Factor (k):					2
Expanded Uncertainty:					3.36

3.2.2 Radiated Emission Measurements (Above 1GHz)

Contribution		Probability Distribution Type	Probability Distribution x_i	Standard Uncertainty $u(x_i)$	$[u(x_i)]^2$
1	Receiver/Spectrum Analyzer	Rectangular	0.57	0.33	0.11
2	Cables	Rectangular	0.70	0.40	0.16
3	Preamp	Rectangular	0.50	0.29	0.08
4	Antenna	Rectangular	0.37	0.21	0.05
5	Site	Rectangular	3.00	1.22	1.50
6	EUT Setup	Rectangular	1.00	0.58	0.33
Combined Uncertainty (u_c):					1.49
Coverage Factor (k):					2
Expanded Uncertainty:					2.99

3.2.3 Conducted Antenna Port Measurement

Contribution		Probability Distribution Type	Probability Distribution x_i	Standard Uncertainty $u(x_i)$	$[u(x_i)]^2$
1	Receiver/Spectrum Analyzer	Rectangular	0.34	0.20	0.04
2	Cables	Rectangular	0.30	0.17	0.03
3	EUT Setup	Rectangular	0.50	0.29	0.08
Combined Uncertainty (u_c):					0.39
Coverage Factor (k):					1.96
Expanded Uncertainty:					0.76



SECTION 4

DIAGRAM OF TEST SETUP



4.1 TEST SETUP DIAGRAM

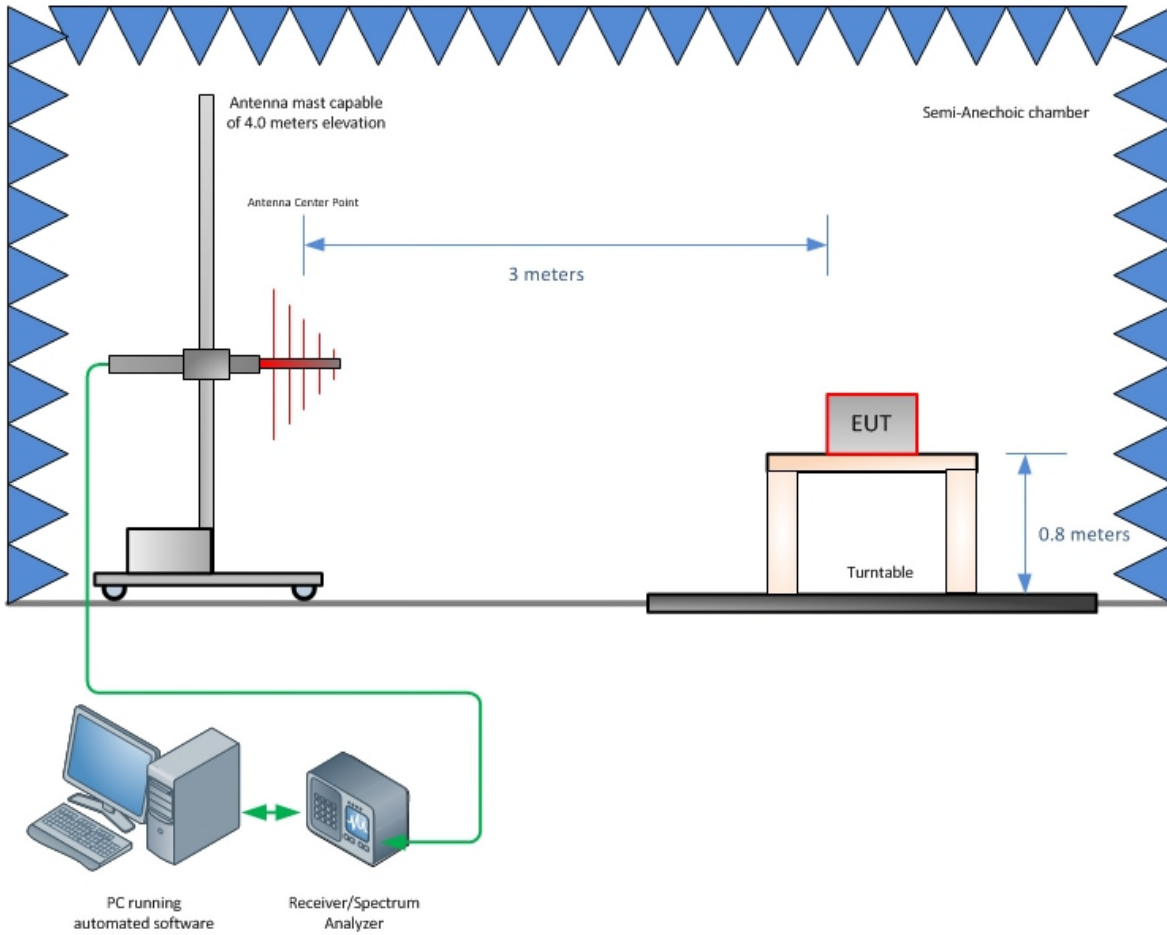

Radiated Emission Test Setup (Below 1GHz)

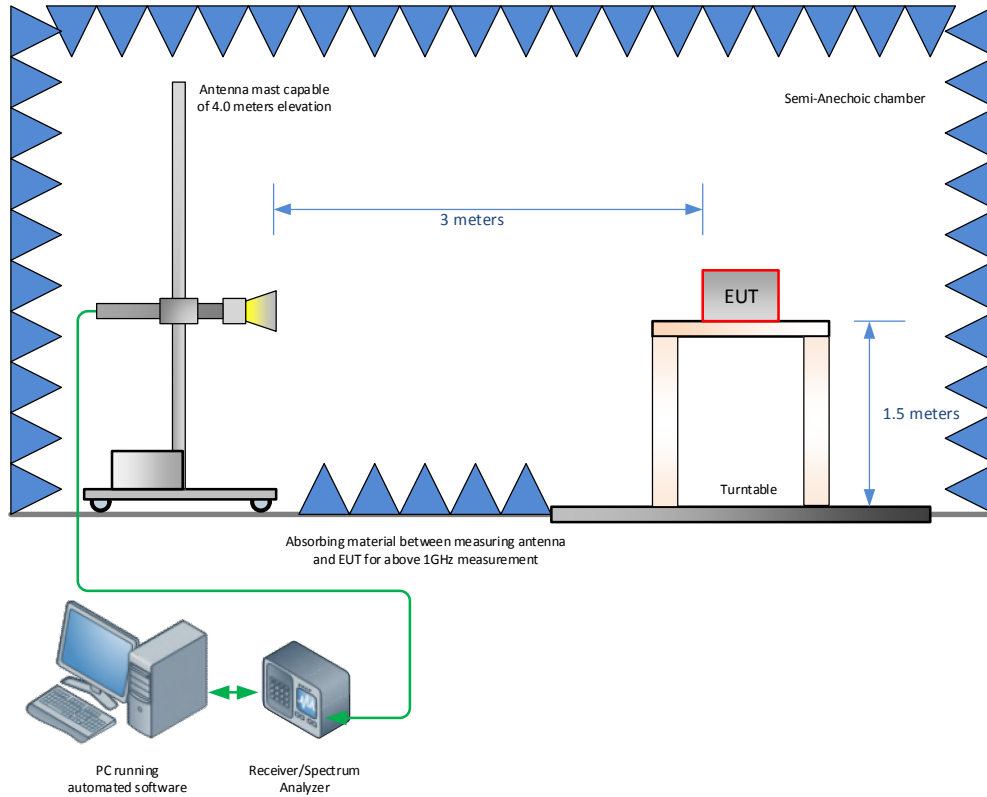

Radiated Emission Test Setup (Above 1GHz)



America

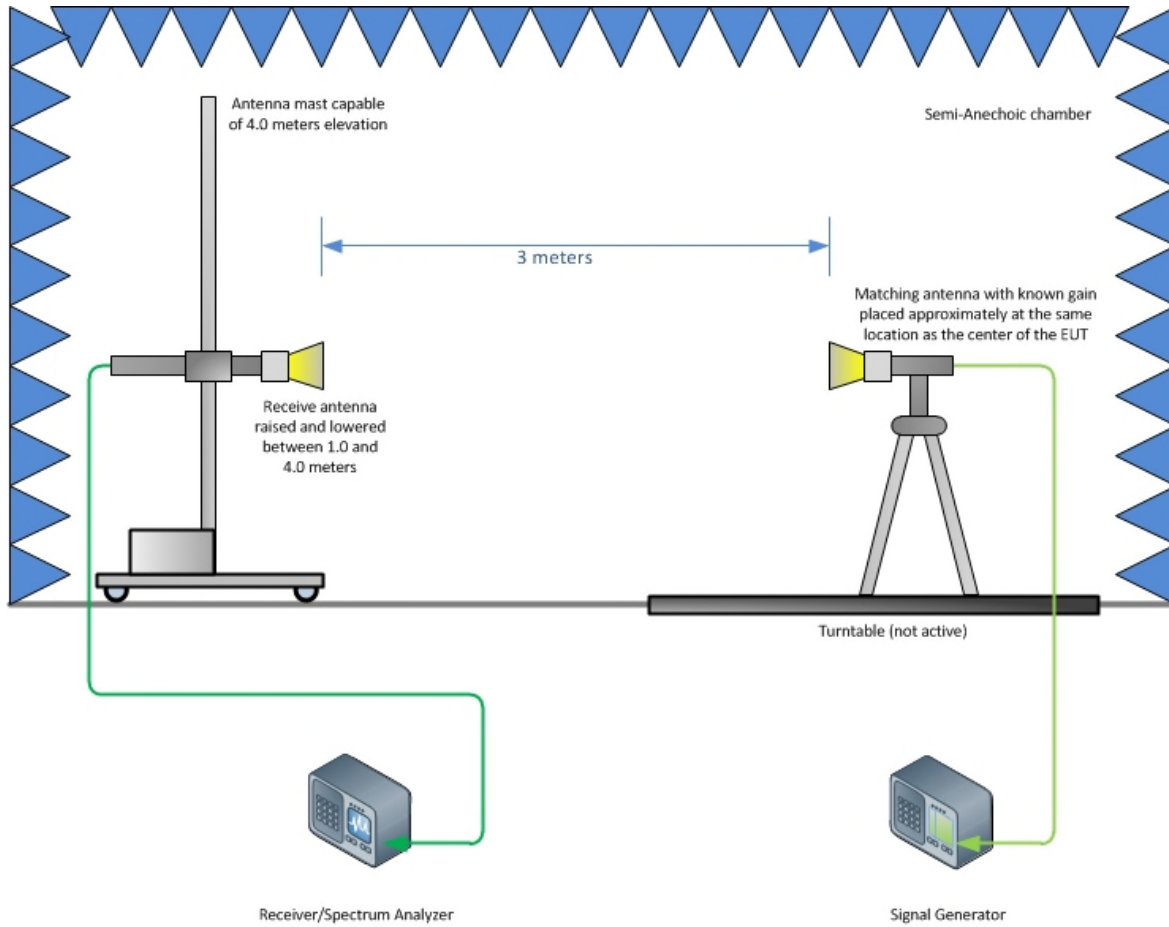

Substitution Test Method (Above 1GHz)

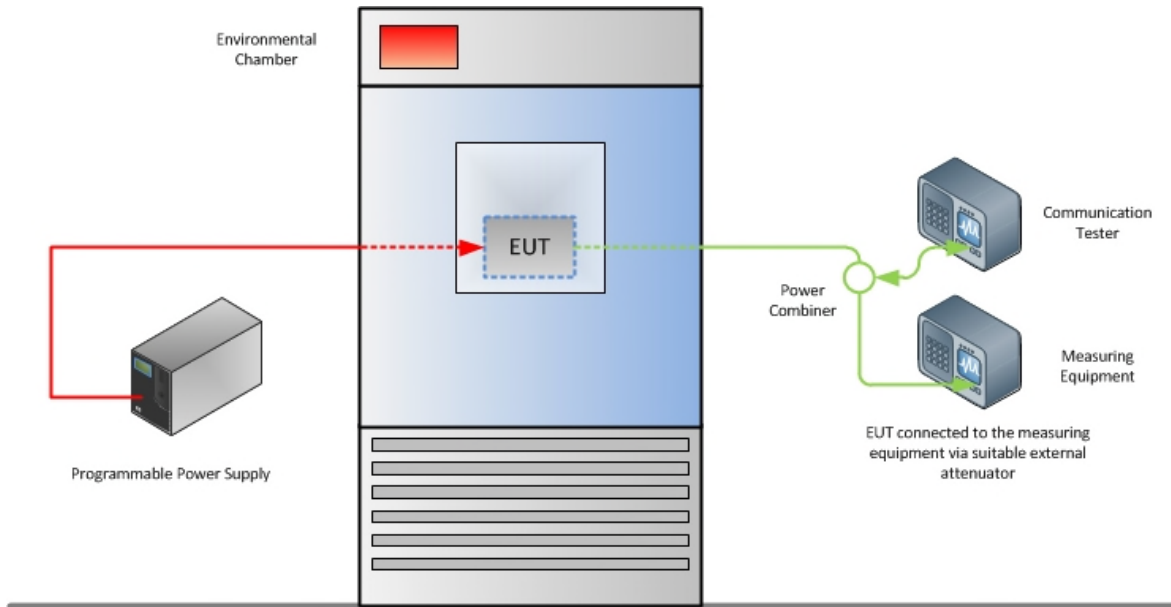

Frequency Stability Test Configuration



SECTION 5

ACCREDITATION, DISCLAIMERS AND COPYRIGHT



5.1 ACCREDITATION, DISCLAIMERS AND COPYRIGHT

TÜV SÜD America Inc.'s reports apply only to the specific sample tested under stated test conditions. It is the manufacturer's responsibility to assure the continued compliance of production units of this model. TÜV SÜD America, Inc. shall have no liability for any deductions, inferences or generalizations drawn by the client or others from TÜV SÜD America, Inc.'s issued reports.

This report is the confidential property of the client. As a mutual protection to our clients, the public and TÜV SÜD America, Inc., extracts from the test report shall not be reproduced, except in full without TÜV SÜD America, Inc.'s written approval.

This report must not be used to claim product certification, approval, or endorsement by A2LA, NIST, or any agency of the federal government.

TÜV SÜD America, Inc. and its professional staff hold government and professional organization certifications for AAMI, ACIL, AEA, ANSI, IEEE, A2LA, NIST and VCCI.

