



America

**Choose certainty.
Add value.**

Report On

Application for Grant of Equipment Authorization of the
Novatel Wireless Inc.

MIFI8800L Wireless Hotspot Modem

FCC CFR 47 Part 2 and 27: 2017

RSS-139 Issue 3: 2015

RSS-199 Issue 3: 2016

RSS-130 Issue 1: 2013

Report No. 72139211B

August 2018





REPORT ON Radio Testing of the
Novatel Wireless Inc.
MIFI8800L Wireless Hotspot Modem

TEST REPORT NUMBER 72139211B

PREPARED FOR Novatel Wireless Inc.
9605 Scranton Road, Suite 300
San Diego, CA 92121
USA

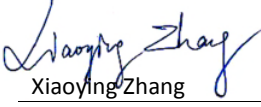
CONTACT PERSON Roman Olmos
Senior Regulatory Engineer
(858) 812-3400
rolmos@nvtl.com

PREPARED BY 
Xiaoying Zhang
Name
Authorized Signatory
Title: EMC/Wireless Test Engineer

APPROVED BY 
Ferdinand S. Custodio
Name
Authorized Signatory
Title: Senior EMC Test Engineer/Wireless Team Lead

DATED August 27, 2018



Revision History

72139211B Novatel Wireless Inc. MIFI8800L Wireless Hotspot Modem					
DATE	OLD REVISION	NEW REVISION	REASON	PAGES AFFECTED	APPROVED BY
08/27/2018	Initial Release				Ferdinand Custodio



CONTENTS

Section	Page No
1	REPORT SUMMARY..... 5
1.1	Introduction 6
1.2	Brief Summary of Results..... 7
1.3	Product Information 9
1.4	EUT Test Configuration 12
1.5	Deviations from the Standard..... 14
1.6	Modification Record 14
1.7	Test Methodology..... 14
1.8	Test Facility Location..... 14
1.9	Test Facility Registration 14
1.10	Sample Calculations 16
2	TEST DETAILS 17
2.1	Transmitter Conducted Power Measurements 18
2.2	Equivalent Isotropic Radiated Power..... 39
2.3	Effective Radiated Power Output Data..... 46
2.4	Occupied Bandwidth..... 48
2.5	Peak-Average Power Ratio..... 55
2.6	Spurious Emission at Band Edge 62
2.7	Conducted Spurious Emissions 100
2.8	Field Strength of Spurious Radiation 126
2.9	Frequency Stability 145
3	TEST EQUIPMENT USED 157
3.1	Test Equipment Used..... 158
3.2	Measurement Uncertainty 160
4	DIAGRAM OF TEST SETUP 161
4.1	Test Setup Diagram..... 162
5	ACCREDITATION, DISCLAIMERS AND COPYRIGHT 166
5.1	Accreditation, Disclaimers and Copyright..... 167



SECTION 1

REPORT SUMMARY

Radio Testing of the
Novatel Wireless Inc.
MIFI8800L Wireless Hotspot Modem



1.1 INTRODUCTION

The information contained in this report is intended to show verification of the Novatel Wireless Inc. MIFI8800L Wireless Hotspot Modem to the requirements of the following:

- FCC CFR 47 Part 2 and 27: 2017
- RSS-139 Issue 3: 2015
- RSS-199 Issue 3: 2016
- RSS-130 Issue 1: 2013

Objective	To perform Radio Testing to determine the Equipment Under Test's (EUT's) compliance with the Test Specification, for the series of tests carried out.
Manufacturer	Novatel Wireless Inc.
Product Trademark/Brand	Inseego
Product Marketing Name	MiFi 8800L
Model Number(s)	MIFI8800L
FCC ID Number	PKRNVWMIFI8800
IC Number	3229A-MIFI8800
Serial Number(s)	AZ280418A00044
Number of Samples Tested	1
Test Specification/Issue/Date	<ul style="list-style-type: none">• FCC CRF 47 Part 2 and 27 (October 1, 2017)• RSS-139 Issue 3: July 2015 – Advanced Wireless Services (AWS) Equipment Operating in the Bands 1710-1780 MHz and 2110-2180 MHz• RSS-199 Issue 3: December 2016 – Broadband Radio Service (BRS) Equipment Operating in the Band 2500-2690 MHz• RSS-130 Issue 1: October 2013 – Mobile Broadband Services (MBS) Equipment Operating in the Frequency Bands 698-756 MHz and 777-787• RSS-Gen Issue 5: April 2018 - General Requirements for Compliance of Radio Apparatus• ANSI C63.26-2015: American National Standard for Compliance Testing of Transmitters Used in Licensed Radio Services
Start of Test	July 06, 2018
Finish of Test	July 27, 2018
Name of Engineer(s)	Xiaoying Zhang
Related Document(s)	Supporting documents for EUT certification are separate exhibits.



1.2 BRIEF SUMMARY OF RESULTS

A brief summary of the tests carried out in accordance with FCC CFR 47 Part 2 and 27: 2017 with cross-reference to the corresponding ISSED RSS standard is shown below.

Section	FCC Part Sections(s)	RSS Section(s)	Test Description	Result
2.1	2.1046	RSS-139 (6.5) RSS-199 (4.4) RSS-130 (4.4)	Transmitter Conducted Output Power	Compliant
2.2	2.1046 27.50 (h)(2)	RSS-139 (6.5) RSS-199 (4.4) RSS-130 (4.4)	Equivalent Isotropic Radiated Power	Compliant
2.3	2.1046 27.50 (b)(10)	-	Effective Radiated Power	Compliant
2.4	2.1049 27.53(h) 25.53(m)(4)	RSS-Gen (6.7)	Occupied Bandwidth	Compliant
2.5	27.50 (d)(5)	RSS-139 (6.5) RSS-199 (4.4) RSS-130 (4.4)	Peak-Average Ratio	Compliant
2.6	2.1051 27.53(h)(1)(3) 27.53(m)(4)(6) 27.53(c)(2)(5)	RSS-139 (6.6) RSS-199 (4.5) RSS-130 (4.6.1)	Band Edge	Compliant
2.7	2.1051 27.53(h)(1)(3) 27.53(m)(4)(6) 27.53(c)(2)(4)(5)&(f)	RSS-139 (6.6) RSS-199 (4.5) RSS-130 (4.6)	Conducted Spurious Emissions	Compliant
2.8	2.1053 27.53(h)(1) 27.53(m)(4) 27.53(c)(2)	RSS-139 (6.6) RSS-199 (4.5) RSS-130 (4.6)	Field Strength of Spurious Radiation	Compliant
2.9	2.1055 27.54	RSS-139 (6.4) RSS-199 (4.3) RSS-130 (4.3)	Frequency Stability	Compliant



America

-	-	RSS-Gen 7.4	Receiver Spurious Emissions	N/A*
2.10	-	RSS-GEN 8.8	Power Line Conducted Emissions	Compliant

N/A* Not Applicable. No stand-alone receiver.



1.3 PRODUCT INFORMATION

1.3.1 EUT General Description

The Equipment Under Test (EUT) was a Novatel Wireless Inc. MIFI8800L Wireless Hotspot Modem. The EUT is a Wireless Hotspot Modem supporting 2G/3G/4G Technologies. The EUT comes with a USB Port.

1.3.2 Technical Description

EUT Description	Wireless Hotspot Modem
Product Marketing Name	MiFi 8800L
Model Number(s)	MIFI8800L
Rated Voltage	3.8V, 4500mAh (Rechargeable Li-Ion battery pack) Input 100-240VAC, Output 5V (External AC-DC Power Adapter)
Mode Verified	LTE Band 4: 1710-1755 MHz LTE Band 7: 2500-2570 MHz LTE Band 13: 777-787 MHz LTE Band 66: 1710-1780 MHz
Capability	WCDMA Band 2, 5, LTE Band 2, 4, 5, 7, 13, 14, 46, 48, 66 and 802.11 a/b/g/n/ac
Primary Unit (EUT)	<input type="checkbox"/> Production <input checked="" type="checkbox"/> Pre-Production <input type="checkbox"/> Engineering

(Client declaration, max. antenna gain covered under this test report)

LTE Bands	Frequency(ies)	Antenna Gains
Band 4	1710-1755 MHz	0.0 dBi
Band 7	2500-2570 MHz	2.3 dBi
Band 13	777-787 MHz	-0.6 dBi
Band 66	1710-1780 MHz	0.0 dBi



1.3.3 Transmit Frequency Table

Technology / Band	Modulation	Bandwidth (MHz)	Tx Frequency (MHz)	Emission Designator	EIRP	
					Max. Power (dBm)	Max. Power (Watts)
LTE Band 4	QPSK	1.4	1710-1750	1M09G7D	23.92	246.6
		3	1710-1750	2M70G7D	23.94	247.74
		5	1710-1750	4M50G7D	23.95	248.31
		10	1710-1750	8M99G7D	23.93	247.17
		15	1710-1750	13M5G7D	23.99	250.61
		20	1710-1750	17M9G7D	23.99	250.61
	16QAM	1.4	1710-1750	1M10W7D	22.65	184.08
		3	1710-1750	2M70W7D	22.69	185.78
		5	1710-1750	4M49W7D	22.84	192.31
		10	1710-1750	8M98W7D	22.75	188.36
		15	1710-1750	13M5W7D	23.19	208.45
LTE Band 7	QPSK	5	2500-2570	4M48G7D	25.99	397.19
		10	2500-2570	8M97G7D	25.38	345.14
		15	2500-2570	13M4G7D	25.42	348.34
		20	2500-2570	17M9G7D	25.37	344.35
	16QAM	5	2500-2570	4M49W7D	25.35	342.77
		10	2500-2570	8M96W7D	24.65	291.74
		15	2500-2570	13M5W7D	24.65	291.74
		20	2500-2570	17M9W7D	24.59	287.74
LTE Band 13	QPSK	5	777-787	4M46G7D	23.35	216.27
		10	777-787	8M92G7D	23.33	215.28
	16QAM	5	777-787	4M47W7D	22.62	182.81
		10	777-787	8M91W7D	22.45	107.15
LTE Band 66	QPSK	1.4	1710-1780	1M10G7D	23.94	247.74
		3	1710-1780	2M70G7D	23.91	246.04
		5	1710-1780	4M50G7D	23.95	248.31
		10	1710-1780	8M98G7D	24.0	251.19
		15	1710-1780	13M5G7D	23.92	246.60
		20	1710-1780	18M0G7D	23.98	250.03
	16QAM	1.4	1710-1780	1M09W7D	22.75	188.36
		3	1710-1780	2M70W7D	22.71	186.64
		5	1710-1780	4M48W7D	23.02	200.45
		10	1710-1780	8M97W7D	22.74	187.93
		15	1710-1780	13M5W7D	22.83	191.87
20	1710-1780	18M0W7D	22.8	190.55		



Technology / Band	Modulation	Bandwidth (MHz)	Tx Frequency (MHz)	Emission Designator	ERP	
					Max. Power (dBm)	Max. Power (Watts)
LTE Band 13	QPSK	5	777-787	4M46G7D	21.2	131.83
		10	777-787	8M92G7D	21.18	131.22
	16QAM	5	777-787	4M47W7D	20.47	111.43
		10	777-787	8M91W7D	20.3	107.15

1.4 EUT TEST CONFIGURATION

1.4.1 Test Configuration Description

Test Configuration	Description
A	Conducted antenna port measurement. EUT Transmits at max power and is powered by the internal battery and/or USB via AC Adapter.
B	Radiated test setup / case spurious emissions. Antenna port terminated by the call box.

1.4.2 EUT Exercise Software

EUT is controlled by a CMW 500 Wideband Radio Communication Tester. There are no other test software used during verification.

1.4.3 Support Equipment and I/O cables

Manufacturer	Equipment/Cable	Description
Novatel Wireless	USB Cable	Standard USB Type A to USB Type C
Novatel Wireless	External AC-DC Power Adapter	Model: SSW-2783, PN: 40123126.01 Input: 100-240VAC, 50/60Hz, 0.5A Output: 5VDC, max. 2A

1.4.4 Worst Case Configuration

Worst-case configuration used in this test report as per output power measurements:

LTE Band	Channel BW	Modulation	RB Size/Offset
Band 4	20 MHz	QPSK	1/0
Band 7	5 MHz	QPSK	1/13
Band 13	5 MHz	QPSK	1/0
Band 66	10 MHz	QPSK	1/0

For radiated measurements X, Y, and Z orientations were verified. The verification was determined "Y" as worst case configuration.

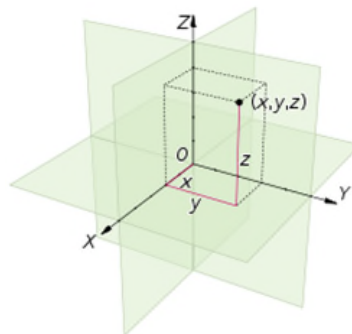

1.4.5 Simplified Test Configuration Diagram

Radiated Test Configuration

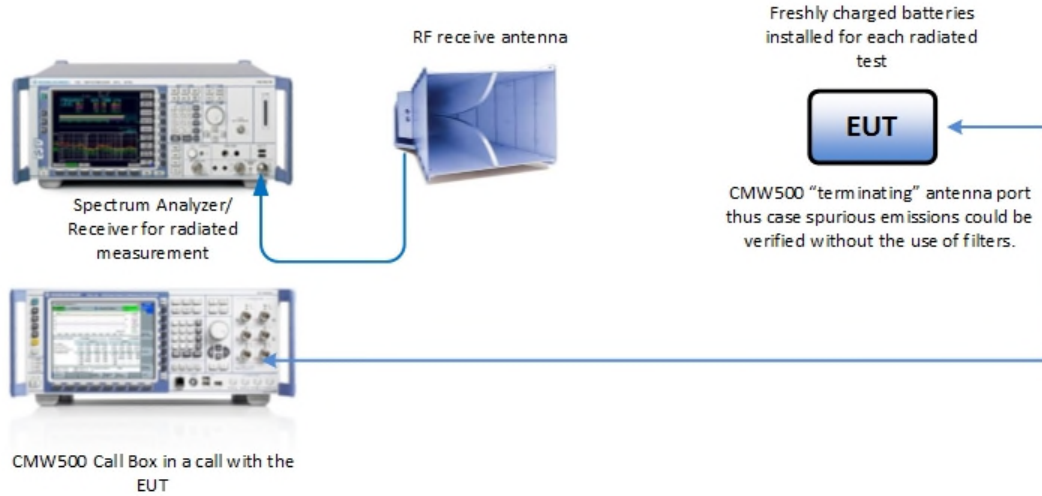

Conducted (Antenna Port) Test Configuration

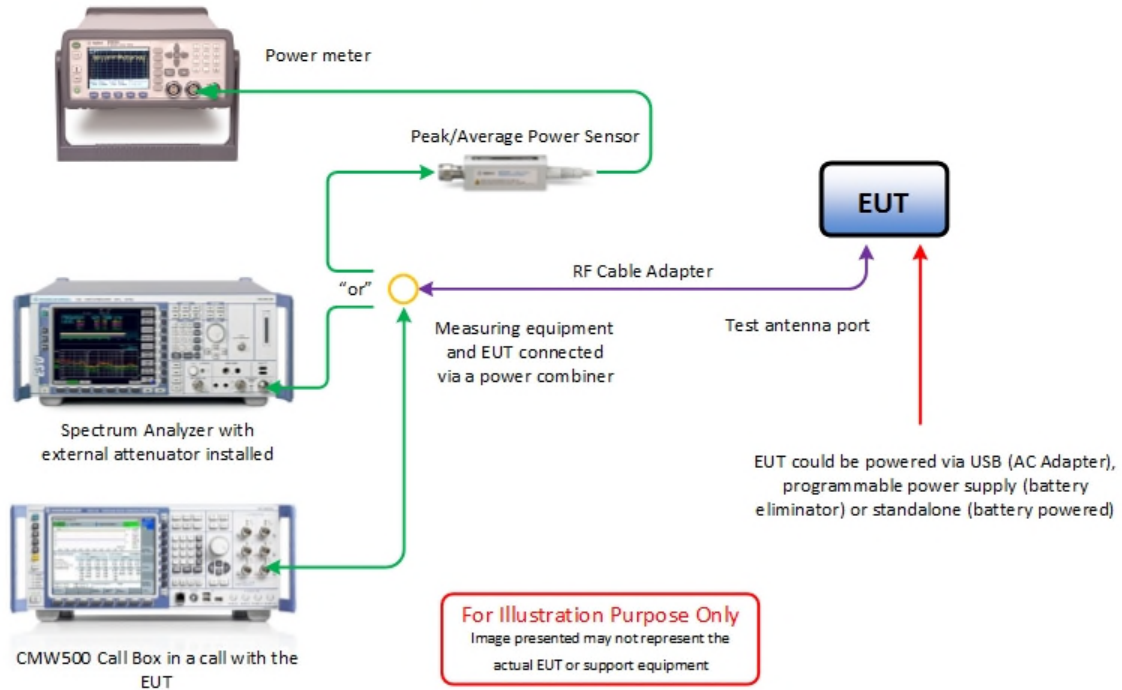



1.5 DEVIATIONS FROM THE STANDARD

No deviations from the applicable test standards or test plan were made during testing.

1.6 MODIFICATION RECORD

Description of Modification	Modification Fitted By	Date Modification Fitted
Serial Number AZ280418A00044		
None	—	—

The table above details modifications made to the EUT during the test programme. The modifications incorporated during each test (if relevant) are recorded on the appropriate test pages.

1.7 TEST METHODOLOGY

All measurements contained in this report were conducted with ANSI C63.26-2015, American National Standard for Compliance Testing of Transmitters Used in Licensed Radio Services.

For conducted and radiated emissions the equipment under test (EUT) was configured to measure its highest possible emission level. The test modes were adapted according to the Operating Instructions provided by the manufacturer/client.

1.8 TEST FACILITY LOCATION

1.8.1 TÜV SÜD America Inc. (Mira Mesa)

10040 Mesa Rim Road, San Diego, CA 92121-2912 (32.901268,-117.177681). Phone: 858 678 1400 FAX: 858 546 0364

1.8.2 TÜV SÜD America Inc. (Rancho Bernardo)

16936 Via Del Campo, San Diego, CA 92127-1708 (33.018644,-117.092409). Phone: (858) 678-1400 Fax: (858) 546-0364.

1.9 TEST FACILITY REGISTRATION

1.9.1 FCC – Designation No.: US1146

TUV SUD America Inc. (San Diego), is an accredited test facility with the site description report on file and has met all the requirements specified in §2.948 of the FCC rules. The acceptance letter from the FCC is maintained in our files and the Designation is US1146.



1.9.2 Innovation, Science and Economic Development Canada (IC) Registration No.: 3067A-1 & 22806-1

The 10m Semi-anechoic chamber of TUV SUD America Inc. (San Diego Rancho Bernardo) has been registered by Certification and Engineering Bureau of Innovation, Science and Economic Development Canada for radio equipment testing with Registration No. 3067A-1.

The 3m Semi-anechoic chamber of TUV SUD America Inc. (San Diego Mira Mesa) has been registered by Certification and Engineering Bureau of Innovation, Science and Economic Development Canada for radio equipment testing with Registration No. 22806-1.

1.9.3 BSMI – Laboratory Code: SL2-IN-E-028R (US0102)

TUV Product Service Inc. (San Diego) is a recognized EMC testing laboratory by the BSMI under the MRA (Mutual Recognition Arrangement) with the United States. Accreditation includes CNS 13438 up to 6GHz.

1.9.4 NCC (National Communications Commission - US0102)

TUV SUD America Inc. (San Diego) is listed as a Foreign Recognized Telecommunication Equipment Testing Laboratory and is accredited to ISO/IEC 17025 (A2LA Certificate No.2955.13) which under APEC TEL MRA Phase 1 was designated as a Conformity Assessment Body competent to perform testing of equipment subject to the Technical Regulations covered under its scope of accreditation including RTTE01, PLMN01 and PLMN08 for TTE type of testing and LP002 for Low-Power RF Device type of testing.

1.9.5 VCCI – Registration No. A-0280 and A-0281

TUV SUD America Inc. (San Diego) is a VCCI registered measurement facility which includes radiated field strength measurement, radiated field strength measurement above 1GHz, mains port interference measurement and telecommunication port interference measurement.

1.9.6 RRA – Identification No. US0102

TUV SUD America Inc. (San Diego) is National Radio Research Agency (RRA) recognized laboratory under Phase I of the APEC Tel MRA.

1.9.7 OFCA – U.S. Identification No. US0102

TUV SUD America Inc. (San Diego) is recognized by Office of the Communications Authority (OFCA) under Appendix B, Phase I of the APEC Tel MRA.



1.10 SAMPLE CALCULATIONS

1.10.1 LTE Emission Designator (QPSK)

Emission Designator = 4M51G7D
 G = Phase Modulation
 7= Quantized/Digital Info
 D = Data Transmission, telemetry, telecommand

1.10.2 LTE Emission Designator (16QAM)

Emission Designator = 4M50W7D
 W = Frequency Modulation
 7= Quantized/Digital Info
 D = Data Transmission, telemetry, telecommand

1.10.3 Spurious Radiated Emission (below 1GHz)

Measuring equipment raw measurement (dbμV) @ 30 MHz			24.4
Correction Factor (dB)	Asset# 1066 (cable)	0.3	-12.6
	Asset# 1172 (cable)	0.3	
	Asset# 1016 (preamplifier)	-30.7	
	Asset# 1175(cable)	0.3	
	Asset# 1002 (antenna)	17.2	
Reported QuasiPeak Final Measurement (dbμV/m) @ 30MHz			11.8

1.10.4 Spurious Radiated Emission – Substitution Method

Example = 84dBμV/m @ 1413 MHz (numerical sample only)

The field strength reading of 84dBμV/m @ 1413 MHz (2nd Harmonic of 706.5 MHz) is the maximized measurement when the EUT is on the turntable measured at 3 meters. The gain of the substituted antenna is 7.8dBi while the transmit cable loss is 1.0 dB (cable between signal generator and the substituted antenna). The signal generator level is adjusted until the 84dBμV/m level at the receiving end is replicated (identical test setup, i.e. same antenna, cable/s and preamp). If the adjusted signal generator level is -18dBm, then we have the following for both EIRP and ERP as required:

$$\begin{aligned}
 P_{EIRP} &= -18 \text{ dBm} + 7.8 \text{ dBi} - 1 \text{ dB} \\
 &= 11.2 \text{ dBm} \\
 P_{ERP} &= P_{EIRP} - 2.15 \text{ dB} \\
 &= 11.2 \text{ dBm} - 2.15 \text{ dB} \\
 &= 9.05 \text{ dBm}
 \end{aligned}$$



SECTION 2

TEST DETAILS

Radio Testing of the
Novatel Wireless Inc.
MIFI8800L Wireless Hotspot Modem



2.1 TRANSMITTER CONDUCTED POWER MEASUREMENTS

2.1.1 Specification Reference

FCC 47 CFR Part 2, Clause 2.1046
RSS-139, Clause 6.5
RSS-199, Clause 4.4
RSS-130, Clause 4.4

2.1.2 Standard Applicable

The conducted power measurements were made in accordance to FCC Part 2 Clause 2.1046 and RSS-139 Clause 6.5, RSS-199 Clause 4.4 and RSS-130 Clause 4.4.

FCC 47 CFR Part 2.1046:

(a) For transmitters other than single sideband, independent sideband and controlled carrier radiotelephone, power output shall be measured at the RF output terminals when the transmitter is adjusted in accordance with the tune-up procedure to give the values of current and voltage on the circuit elements specified in § 2.1033(c)(8). The electrical characteristics of the radio frequency load attached to the output terminals when this test is made shall be stated.

(c) For measurements conducted pursuant to paragraphs (a) and (b) of this section, all calculations and methods used by the applicant for determining carrier power or peak envelope power, as appropriate, on the basis of measured power in the radio frequency load attached to the transmitter output terminals shall be shown. Under the test conditions specified, no components of the emission spectrum shall exceed the limits specified in the applicable rule parts as necessary for meeting occupied bandwidth or emission limitations.

2.1.3 Equipment Under Test and Modification State

Serial No: AZ280418A00044 / Test Configuration A

2.1.4 Date of Test/Initial of test personnel who performed the test

June 18, 19 and July 19, 2018 / XYZ

2.1.5 Test Equipment Used

The major items of test equipment used for the above tests are identified in Section 3.1.

2.1.6 Environmental Conditions/ Test Location

Test performed at TÜV SÜD America Inc. Rancho Bernardo facility

Ambient Temperature	24.0 – 25.1 °C
Relative Humidity	44.0 – 51.6 %
ATM Pressure	98.9 - 99.1 kPa



2.1.7 Additional Observations

- This is a conducted test using Power Meter.
- The path loss was measured and entered as a level offset.
- Low, Middle and High channels for all bandwidths with different RB size and RB offset and modulations were verified and reported.

2.1.8 Test Results

LTE Band 4							
Bandwidth (MHz)	Channel	Frequency (MHz)	Modulation	No. RB	RB Start	Average Power (dBm)	Peak Power (dBm)
1.4	19957	1710.7	QPSK	1	0	23.89	25.59
				1	3	23.92	25.6
				1	5	23.87	25.68
				6	0	23.43	26.32
			16QAM	1	0	22.63	25.69
				1	3	22.65	25.83
				1	5	22.61	25.79
				6	0	22.21	26.57
	20175	1732.5	QPSK	1	0	23.13	26.34
				1	3	23.17	26.24
				1	5	23.11	26.22
				6	0	22.8	26.29
			16QAM	1	0	22.14	26.51
				1	3	22.19	26.61
				1	5	23.16	26.55
				6	0	21.73	26.14
	20393	1754.3	QPSK	1	0	23.02	25.89
				1	3	23.05	25.91
				1	5	22.99	26.03
				6	0	22.54	26.76
			16QAM	1	0	21.99	26.18
				1	3	22.05	26.35
				1	5	21.95	26.37
				6	0	21.58	27.07



LTE Band 4							
Bandwidth (MHz)	Channel	Frequency (MHz)	Modulation	No. RB	RB Start	Average Power (dBm)	Peak Power (dBm)
3	19965	1711.5	QPSK	1	0	23.94	25.61
				1	8	23.9	25.62
				1	14	23.76	25.76
				15	0	23.14	26.28
			16QAM	1	0	22.69	25.64
				1	8	22.63	25.83
				1	14	22.48	25.9
				15	0	22.09	26.54
	20175	1732.5	QPSK	1	0	23.12	26.14
				1	8	23.12	26.15
				1	14	23.06	26.14
				15	0	22.76	26.28
			16QAM	1	0	22.22	26.48
				1	8	22.22	26.67
				1	14	22.18	26.48
				15	0	21.76	26.08
	20385	1753.5	QPSK	1	0	23.1	25.63
				1	8	23.06	25.73
				1	14	22.97	25.88
				15	0	22.66	26.79
			16QAM	1	0	22.02	25.95
				1	8	22.01	26.01
				1	14	22.0	26.26
				15	0	21.64	27.03



America

LTE Band 4							
Bandwidth (MHz)	Channel	Frequency (MHz)	Modulation	No. RB	RB Start	Average Power (dBm)	Peak Power (dBm)
5	19975	1712.5	QPSK	1	0	23.95	25.62
				1	13	23.77	25.77
				1	24	23.66	26.04
				25	0	23.11	26.6
			16QAM	1	0	22.84	25.65
				1	13	22.74	25.89
				1	24	22.71	26.27
				25	0	22.11	26.78
	20175	1732.5	QPSK	1	0	23.17	26.14
				1	13	23.18	26.16
				1	24	23.09	26.16
				25	0	22.71	26.26
			16QAM	1	0	22.3	26.6
				1	13	22.3	26.65
				1	24	22.23	26.55
				25	0	21.63	26.11
	20375	1752.5	QPSK	1	0	23.13	25.52
				1	13	23.1	25.68
				1	24	22.99	25.93
				25	0	22.6	26.63
			16QAM	1	0	22.04	25.80
				1	13	22.04	26.04
				1	24	21.98	26.36
				25	0	21.63	26.82



America

LTE Band 4							
Bandwidth (MHz)	Channel	Frequency (MHz)	Modulation	No. RB	RB Start	Average Power (dBm)	Peak Power (dBm)
10	20000	1715	QPSK	1	0	23.93	25.68
				1	25	23.6	26.25
				1	49	23.4	26.62
				50	0	23.2	27.03
			16QAM	1	0	22.71	25.88
				1	25	22.42	26.57
				1	49	22.33	27.21
				50	0	22.24	27.38
	20175	1732.5	QPSK	1	0	23.77	26.67
				1	25	23.58	26.59
				1	49	23.55	26.58
				50	0	22.72	26.34
			16QAM	1	0	22.75	27.08
				1	25	22.57	27.07
				1	49	22.5	26.98
				50	0	21.67	26.52
	20350	1750	QPSK	1	0	23.67	25.91
				1	25	23.54	29.95
				1	49	23.43	26.4
				50	0	22.57	26.42
			16QAM	1	0	22.63	26.15
				1	25	22.52	26.38
				1	49	22.53	26.82
				50	0	21.64	26.65



America

LTE Band 4							
Bandwidth (MHz)	Channel	Frequency (MHz)	Modulation	No. RB	RB Start	Average Power (dBm)	Peak Power (dBm)
15	20025	1717.5	QPSK	1	0	23.99	25.79
				1	38	23.92	27.08
				1	74	23.71	26.82
				75	0	22.99	27.47
			16QAM	1	0	23.19	26.41
				1	38	23.05	27.59
				1	74	22.84	27.08
				75	0	22.08	28.04
	20175	1732.5	QPSK	1	0	23.85	26.6
				1	38	23.55	26.61
				1	74	23.53	26.52
				75	0	22.73	26.7
			16QAM	1	0	22.88	27.02
				1	38	22.65	27.15
				1	74	22.63	27.02
				75	0	21.8	26.6
	20325	1747.5	QPSK	1	0	23.66	26.33
				1	38	23.5	26.04
				1	74	23.41	26.44
				75	0	22.65	26.6
			16QAM	1	0	22.73	26.69
				1	38	22.46	26.35
				1	74	22.53	26.89
				75	0	21.74	26.86



America

LTE Band 4							
Bandwidth (MHz)	Channel	Frequency (MHz)	Modulation	No. RB	RB Start	Average Power (dBm)	Peak Power (dBm)
20	20050	1720	QPSK	1	0	23.99	26.15
				1	50	23.74	27.13
				1	99	23.58	26.65
				100	0	22.99	27.21
			16QAM	1	0	23.18	26.87
				1	50	22.88	27.95
				1	99	22.54	26.21
				100	0	22.02	27.84
	20175	1732.5	QPSK	1	0	23.86	27.18
				1	50	23.55	26.69
				1	99	23.52	26.56
				100	0	22.81	26.88
			16QAM	1	0	23.05	27.63
				1	50	22.62	26.34
				1	99	22.71	27.18
				100	0	21.72	26.91
	20300	1745	QPSK	1	0	23.24	26.27
				1	50	23.06	25.77
				1	99	22.97	26.11
				100	0	22.65	26.85
			16QAM	1	0	22.25	26.74
				1	50	21.98	26.12
				1	99	22.02	26.69
				100	0	21.72	27.16



America

LTE Band 7							
Bandwidth (MHz)	Channel	Frequency (MHz)	Modulation	No. RB	RB Start	Average Power (dBm)	Peak Power (dBm)
5	20775	2502.5	QPSK	1	0	21.51	25.05
				1	13	21.77	25.22
				1	24	21.69	25.21
				25	0	21.84	27.22
			16QAM	1	0	21.04	26.35
				1	13	21.29	26.44
				1	24	21.17	26.36
				25	0	21.02	27.84
	21100	2535	QPSK	1	0	23.62	27.51
				1	13	23.69	27.43
				1	24	23.59	27.36
				25	0	22.72	28.51
			16QAM	1	0	23.01	28.58
				1	13	23.05	28.47
				1	24	22.9	28.43
				25	0	21.82	29.19
	21425	2567.5	QPSK	1	0	22.99	26.66
				1	13	22.98	26.54
				1	24	22.63	26.28
				25	0	22.2	27.49
			16QAM	1	0	22.29	27.63
1				13	22.29	27.57	
1				24	21.96	27.31	
25				0	21.27	28.02	



America

LTE Band 7							
Bandwidth (MHz)	Channel	Frequency (MHz)	Modulation	No. RB	RB Start	Average Power (dBm)	Peak Power (dBm)
10	20800	2505	QPSK	1	0	21.63	25.14
				1	25	21.93	25.38
				1	49	21.81	25.31
				50	0	21.92	27.24
			16QAM	1	0	20.79	26.3
				1	25	21.13	26.41
				1	49	21.02	26.34
				50	0	20.97	27.41
	21100	2535	QPSK	1	0	22.76	26.46
				1	25	23.06	26.72
				1	49	22.87	26.55
				50	0	22.52	28.32
			16QAM	1	0	22.05	27.66
				1	25	22.35	27.91
				1	49	22.15	27.56
				50	0	21.63	28.37
	21400	2565	QPSK	1	0	23.03	26.66
				1	25	23.08	26.64
				1	49	22.49	26.15
				50	0	22.28	27.98
			16QAM	1	0	22.24	27.66
				1	25	22.29	27.63
				1	49	21.68	27.13
				50	0	21.35	28.16



America

LTE Band 7							
Bandwidth (MHz)	Channel	Frequency (MHz)	Modulation	No. RB	RB Start	Average Power (dBm)	Peak Power (dBm)
15	20825	2507.5	QPSK	1	0	21.57	25.04
				1	38	22.0	25.44
				1	74	20.82	24.27
				75	0	21.85	27.24
			16QAM	1	0	20.82	26.11
				1	38	21.29	26.51
				1	74	20.09	25.37
				75	0	21.03	27.77
	21100	2535	QPSK	1	0	22.63	26.29
				1	38	23.03	26.69
				1	74	22.77	26.35
				75	0	22.52	28.26
			16QAM	1	0	21.93	27.44
				1	38	22.35	27.82
				1	74	22.07	27.44
				75	0	21.57	28.45
	21375	2562.5	QPSK	1	0	23.03	26.63
				1	38	23.12	26.74
				1	74	22.37	26.02
				75	0	22.22	28.07
			16QAM	1	0	22.16	27.69
				1	38	22.26	27.84
				1	74	21.50	27.10
				75	0	21.3	28.19



America

LTE Band 7							
Bandwidth (MHz)	Channel	Frequency (MHz)	Modulation	No. RB	RB Start	Average Power (dBm)	Peak Power (dBm)
20	20850	2510	QPSK	1	0	21.27	24.72
				1	50	22.05	25.5
				1	99	21.68	25.27
				100	0	21.9	27.35
			16QAM	1	0	20.46	25.86
				1	50	21.28	26.5
				1	99	20.84	26.33
				100	0	21.04	27.49
	21100	2535	QPSK	1	0	22.28	25.91
				1	50	22.98	26.64
				1	99	22.46	26.0
				100	0	22.61	28.01
			16QAM	1	0	21.57	27.19
				1	50	22.29	27.75
				1	99	21.74	27.11
				100	0	21.72	28.71
	21350	2560	QPSK	1	0	22.65	26.21
				1	50	23.07	26.76
				1	99	22.09	25.78
				100	0	22.26	27.62
			16QAM	1	0	21.84	27.33
				1	50	22.26	27.81
				1	99	21.22	26.83
				100	0	21.36	28.51



LTE Band 13							
Bandwidth (MHz)	Channel	Frequency (MHz)	Modulation	No. RB	RB Start	Average Power (dBm)	Peak Power (dBm)
5	23205	779.5	QPSK	1	0	23.82	27.08
				1	13	23.82	27.17
				1	24	23.82	27.28
				25	0	23.13	28.0
			16QAM	1	0	22.99	27.61
				1	13	23.01	27.89
				1	24	23.01	27.92
				25	0	22.18	28.78
	23230	782	QPSK	1	0	23.95	27.39
				1	13	23.93	27.34
				1	24	23.88	27.32
				25	0	23.19	28.1
			16QAM	1	0	22.98	28.07
				1	13	23.08	28.01
				1	24	22.97	28.06
				25	0	22.25	28.42
	23255	784.5	QPSK	1	0	23.95	27.41
				1	13	23.86	27.13
				1	24	23.77	27.2
				25	0	23.0	28.22
			16QAM	1	0	23.22	28.05
				1	13	23.1	27.83
				1	24	23.03	27.88
				25	0	22.24	28.32



America

LTE Band 13							
Bandwidth (MHz)	Channel	Frequency (MHz)	Modulation	No. RB	RB Start	Average Power (dBm)	Peak Power (dBm)
10	23230	782	QPSK	1	0	23.93	27.15
				1	25	23.82	27.21
				1	49	23.72	27.1
				50	0	23.12	28.07
			16QAM	1	0	23.05	27.71
				1	25	23.0	27.92
				1	49	22.89	27.88
				50	0	22.18	28.19



LTE Band 66							
Bandwidth (MHz)	Channel	Frequency (MHz)	Modulation	No. RB	RB Start	Average Power (dBm)	Peak Power (dBm)
1.4	131979	1710.7	QPSK	1	0	23.91	25.83
				1	3	23.94	25.87
				1	5	23.9	25.91
				6	0	23.41	26.54
			16QAM	1	0	22.72	26.06
				1	3	22.75	26.11
				1	5	22.7	26.12
				6	0	22.21	26.75
	132322	1745	QPSK	1	0	23.05	25.62
				1	3	23.11	25.51
				1	5	22.98	25.64
				6	0	22.46	26.49
			16QAM	1	0	21.9	26.08
				1	3	21.95	26.14
				1	5	21.86	26.01
				6	0	21.43	26.73
	132665	1779.3	QPSK	1	0	22.84	25.86
				1	3	22.87	25.84
				1	5	22.8	25.94
				6	0	22.33	26.82
			16QAM	1	0	21.77	26.12
				1	3	21.87	26.18
				1	5	21.8	26.29
				6	0	21.38	27.18



LTE Band 66							
Bandwidth (MHz)	Channel	Frequency (MHz)	Modulation	No. RB	RB Start	Average Power (dBm)	Peak Power (dBm)
3	131987	1711.5	QPSK	1	0	23.91	25.92
				1	8	23.85	26.05
				1	14	23.84	26.22
				15	0	23.26	26.75
			16QAM	1	0	22.71	26.08
				1	8	22.71	26.25
				1	14	22.71	26.45
				15	0	22.26	26.98
	132322	1745	QPSK	1	0	23.03	25.62
				1	8	22.96	25.57
				1	14	22.97	25.62
				15	0	22.42	26.8
			16QAM	1	0	21.94	25.96
				1	8	21.91	25.97
				1	14	21.88	25.98
				15	0	21.5	26.96
	132657	1778.5	QPSK	1	0	22.84	25.79
				1	8	22.78	25.84
				1	14	22.73	25.96
				15	0	22.39	26.8
			16QAM	1	0	21.93	26.18
				1	8	21.91	26.29
				1	14	21.89	26.42
				15	0	21.43	26.87



America

LTE Band 66							
Bandwidth (MHz)	Channel	Frequency (MHz)	Modulation	No. RB	RB Start	Average Power (dBm)	Peak Power (dBm)
5	131997	1712.5	QPSK	1	0	23.95	26.48
				1	13	23.92	26.63
				1	24	23.73	26.82
				25	0	23.24	26.85
			16QAM	1	0	22.97	26.71
				1	13	23.02	27.1
				1	24	22.84	27.28
				25	0	22.24	26.93
	132322	1745	QPSK	1	0	23.12	26.21
				1	13	23.11	26.05
				1	24	23.01	26.04
				25	0	22.56	26.28
			16QAM	1	0	22.15	26.62
				1	13	22.15	26.47
				1	24	22.1	26.52
				25	0	21.62	26.65
	132647	1777.5	QPSK	1	0	23.06	26.21
				1	13	23.03	26.26
				1	24	22.98	26.24
				25	0	22.53	27.0
			16QAM	1	0	22.23	26.47
				1	13	22.28	26.81
				1	24	22.17	26.96
				25	0	21.61	27.35



America

LTE Band 66							
Bandwidth (MHz)	Channel	Frequency (MHz)	Modulation	No. RB	RB Start	Average Power (dBm)	Peak Power (dBm)
10	132022	1715	QPSK	1	0	24.0	25.79
				1	25	23.61	26.32
				1	49	23.43	26.66
				50	0	23.24	27.37
			16QAM	1	0	22.74	25.99
				1	25	22.58	26.68
				1	49	22.54	27.34
				50	0	22.25	27.59
	132322	1745	QPSK	1	0	23.19	25.76
				1	25	22.97	25.49
				1	49	22.95	25.55
				50	0	22.54	26.56
			16QAM	1	0	22.11	26.28
				1	25	21.86	25.86
				1	49	21.86	25.97
				50	0	21.61	26.7
	132622	1775	QPSK	1	0	22.94	26.14
				1	25	22.84	25.72
				1	49	22.76	25.85
				50	0	22.49	27.07
			16QAM	1	0	22.1	26.77
				1	25	21.94	26.19
				1	49	21.92	26.18
				50	0	21.58	27.29



America

LTE Band 66							
Bandwidth (MHz)	Channel	Frequency (MHz)	Modulation	No. RB	RB Start	Average Power (dBm)	Peak Power (dBm)
15	132047	1717.5	QPSK	1	0	23.92	25.99
				1	38	23.52	26.7
				1	74	23.43	26.44
				75	0	23.19	27.64
			16QAM	1	0	22.83	26.26
				1	38	22.68	27.31
				1	74	22.51	26.81
				75	0	22.26	27.76
	132322	1745	QPSK	1	0	23.2	26.17
				1	38	22.93	25.62
				1	74	22.89	25.85
				75	0	22.63	26.78
			16QAM	1	0	22.32	26.64
				1	38	21.97	26.02
				1	74	22.0	26.32
				75	0	21.7	27.01
	132597	1772.5	QPSK	1	0	23.04	26.07
				1	38	22.8	26.01
				1	74	22.8	25.92
				75	0	22.54	27.44
			16QAM	1	0	21.97	25.68
				1	38	21.86	26.72
				1	74	21.82	26.41
				75	0	21.65	27.51



America

LTE Band 66							
Bandwidth (MHz)	Channel	Frequency (MHz)	Modulation	No. RB	RB Start	Average Power (dBm)	Peak Power (dBm)
20	132072	1720	QPSK	1	0	23.98	26.26
				1	50	23.44	26.78
				1	99	23.34	26.34
				100	0	23.12	27.39
			16QAM	1	0	22.8	26.6
				1	50	22.48	27.52
				1	99	22.21	25.68
				100	0	22.11	27.8
	132322	1745	QPSK	1	0	23.41	26.37
				1	50	22.95	25.84
				1	99	22.86	26.08
				100	0	22.56	26.9
			16QAM	1	0	22.4	26.75
				1	50	21.93	26.22
				1	99	21.95	26.75
				100	0	21.61	27.14
	132572	1770	QPSK	1	0	22.98	26.31
				1	50	22.91	26.07
				1	99	22.85	26.05
				100	0	22.45	26.91
			16QAM	1	0	22.23	26.71
				1	50	22.05	26.44
				1	99	22.01	26.6
				100	0	21.49	26.77

2.1.9 Sample Test Measurement Screen

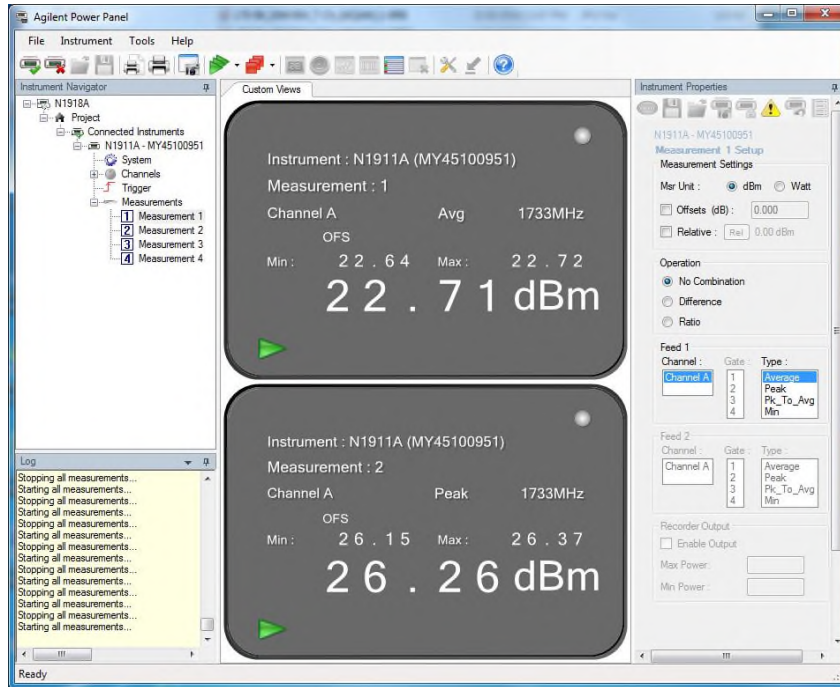

LTE Band 4_5 MHz Bandwidth Middle Chanel QPSK Full RB

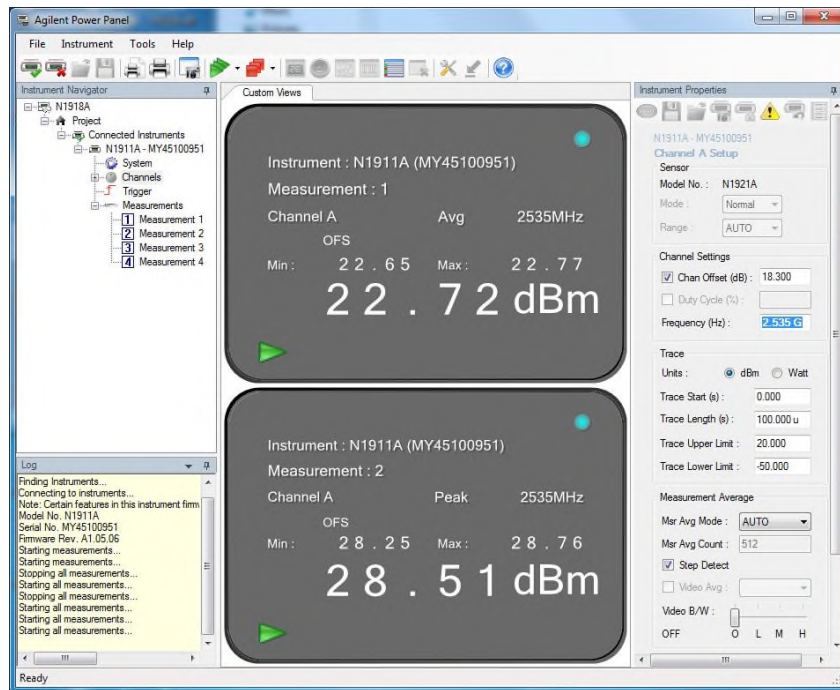

LTE Band 7_10 MHz Bandwidth Middle Chanel QPSK Full RB



America

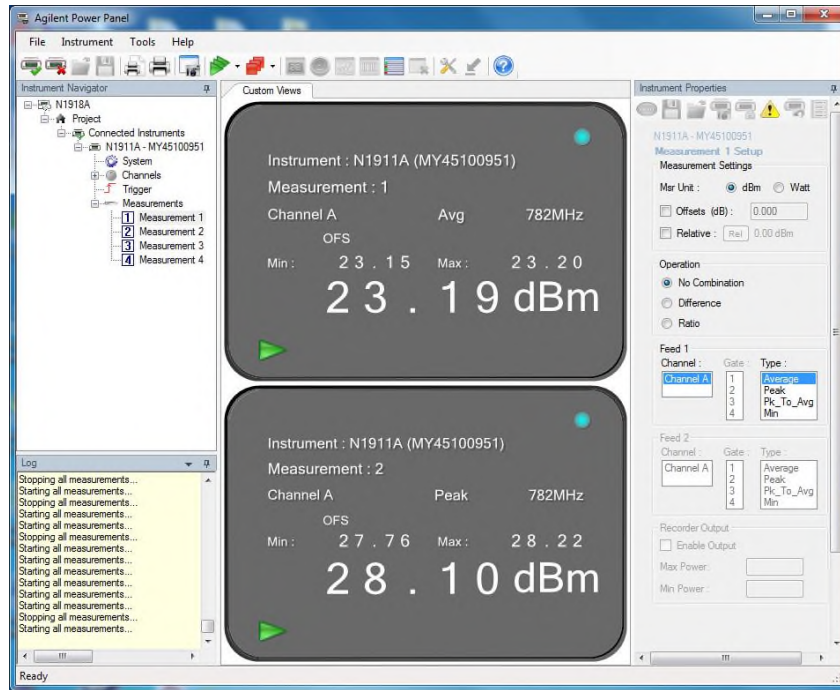

LTE Band 13_5 MHz Bandwidth Middle Chanel QPSK Full RB

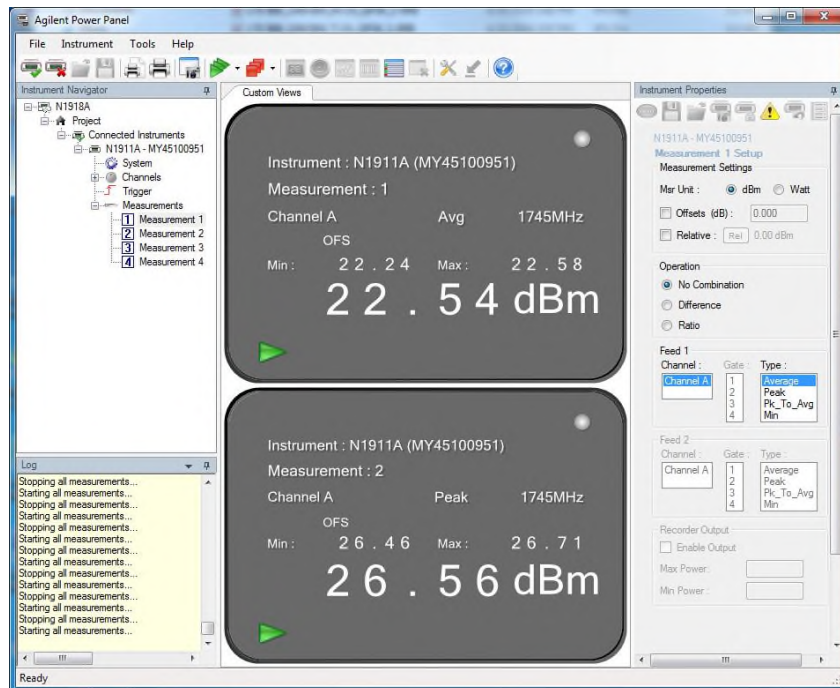

LTE Band 66_10 MHz Bandwidth Middle Chanel QPSK Full RB



2.2 EQUIVALENT ISOTROPIC RADIATED POWER

2.2.1 Specification Reference

FCC 47 CFR Part 2, Clause 2.1046
FCC 47 CFR Part 27, Clause 27.50 (h)(2)
RSS-139, Clause 6.5
RSS-199, Clause 4.4
RSS-130, Clause 4.4

2.2.2 Standard Applicable

FCC 47 CFR Part 27.50(h)
(2) Mobile and other user stations. Mobile stations are limited to 2.0 watts ERRP. All user stations are limited to 2.0 watts transmitter output power.

RSS-139, Clause 6.5:
The equivalent isotropically radiated power (e.i.r.p.) for Mobile and portable transmitters shall not exceed one watt.

RSS-199, Clause 4.4:
For mobile subscriber equipment, the e.i.r.p. shall not exceed 2 W.

RSS-130, Clause 4.4:
The e.i.r.p. shall not exceed 50 watts for mobile equipment or for outdoor fixed subscriber equipment, nor shall it exceed 5 watts for portable equipment or for indoor fixed subscriber equipment.

2.2.3 Equipment Under Test

Serial No: AZ280418A00044, Test Configuration (N/A, calculation only)

2.2.4 Date of Verification/Initial of test personnel who performed the calculation

June 18, 19 and July 19, 2018 / XYZ

2.2.5 Additional Observations

- EIRP was calculated as per Section 1.2 and 1.3 of KDB412172 D01 (Determining ERP and EIRP v01r01).
- Calculation formula in logarithmic terms:

$$EIRP = P_T + G_T - L_c$$

Where:

P_T = transmitter conducted output power dBm (Section 2.1 of this test report)

G_T = gain of the transmitting antenna, in dBi (EIRP)

L_c = signal attenuation in the connecting cable between the transmitter and antenna, in dB (Power measurement performed directly at the primary antenna port. The loss between the LTE module and the primary antenna port is considered negligible).

- Only the worst case RB size and RB offset presented.



2.2.6 Test Results

LTE Band 4									
Modulation	Bandwidth (MHz)	RB Size/Offset	Channels	Frequency (MHz)	Tx Average Power (dBm)	Antenna Gain (dBi)	EIRP (dBm)	Limit (dBm)	Margin (dBm)
QPSK	1.4	1 / 3	19957	1710.7	23.92	0.0	23.92	33	9.08
		1 / 3	20175	1732.5	23.17	0.0	23.17	33	9.83
		1 / 3	20393	1754.3	23.05	0.0	23.05	33	9.95
	3	1 / 0	19965	1711.5	23.94	0.0	23.94	33	9.06
		1 / 8	20175	1732.5	23.12	0.0	23.12	33	9.88
		1 / 0	20385	1753.5	23.1	0.0	23.1	33	9.9
	5	1 / 0	19975	1712.5	23.95	0.0	23.95	33	9.05
		1 / 13	20175	1732.5	23.18	0.0	23.18	33	9.82
		1 / 0	20375	1752.5	23.13	0.0	23.13	33	9.87
	10	1 / 0	20000	1715.0	23.93	0.0	23.93	33	9.07
		1 / 0	20175	1732.5	23.77	0.0	23.77	33	9.23
		1 / 0	20350	1750.0	23.67	0.0	23.67	33	9.33
	15	1 / 0	20025	1717.5	23.99	0.0	23.99	33	9.01
		1 / 0	20175	1732.5	23.85	0.0	23.85	33	9.15
		1 / 0	20325	1747.5	23.66	0.0	23.66	33	9.34
	20	1 / 0	20050	1720.0	23.99	0.0	23.99	33	9.01
		1 / 0	20175	1732.5	23.86	0.0	23.86	33	9.14
		1 / 0	20300	1745.0	23.24	0.0	23.24	33	9.76



LTE Band 4									
Modulation	Bandwidth (MHz)	RB Size/Offset	Channels	Frequency (MHz)	Tx Average Power (dBm)	Antenna Gain (dBi)	EIRP (dBm)	Limit (dBm)	Margin (dBm)
16QAM	1.4	1 / 3	19957	1710.7	22.65	0.0	22.65	33	10.35
		1 / 3	20175	1732.5	22.19	0.0	22.19	33	10.81
		1 / 3	20393	1754.3	22.05	0.0	22.05	33	10.95
	3	1 / 0	19965	1711.5	22.69	0.0	22.69	33	10.31
		1 / 8	20175	1732.5	22.22	0.0	22.22	33	10.78
		1 / 0	20385	1753.5	22.02	0.0	22.02	33	10.98
	5	1 / 0	19975	1712.5	22.84	0.0	22.84	33	10.16
		1 / 13	20175	1732.5	22.3	0.0	22.3	33	10.7
		1 / 0	20375	1752.5	22.04	0.0	22.04	33	10.96
	10	1 / 0	20000	1715.0	22.71	0.0	22.71	33	10.29
		1 / 0	20175	1732.5	22.75	0.0	22.75	33	10.25
		1 / 0	20350	1750.0	22.63	0.0	22.63	33	10.37
	15	1 / 0	20025	1717.5	23.19	0.0	23.19	33	9.81
		1 / 0	20175	1732.5	22.88	0.0	22.88	33	10.12
		1 / 0	20325	1747.5	22.73	0.0	22.73	33	10.27
	20	1 / 0	20050	1720.0	23.18	0.0	23.18	33	9.82
		1 / 0	20175	1732.5	23.05	0.0	23.05	33	9.95
		1 / 0	20300	1745.0	22.25	0.0	22.25	33	10.75



LTE Band 7									
Modulation	Bandwidth (MHz)	RB Size/Offset	Channels	Frequency (MHz)	Tx Average Power (dBm)	Antenna Gain (dBi)	EIRP (dBm)	Limit (dBm)	Margin (dBm)
QPSK	5	1 / 13	20775	2502.5	21.77	2.3	24.07	33	8.93
		1 / 13	21100	2535	23.69	2.3	25.99	33	7.01
		1 / 0	21425	2567.5	22.99	2.3	25.29	33	7.71
	10	1 / 25	20800	2505	21.93	2.3	24.23	33	8.77
		1 / 25	21100	2535	23.06	2.3	25.36	33	7.64
		1 / 25	21400	2565	23.08	2.3	25.38	33	7.62
	15	1 / 38	20825	2507.5	22.0	2.3	24.3	33	8.7
		1 / 38	21100	2535	23.03	2.3	25.33	33	7.67
		1 / 38	21375	2562.5	23.12	2.3	25.42	33	7.58
	20	1 / 50	20850	2510	22.05	2.3	24.35	33	8.65
		1 / 50	21100	2535	22.98	2.3	25.28	33	7.72
		1 / 50	21350	2560	23.07	2.3	25.37	33	7.63
16QAM	5	1 / 13	20775	2502.5	21.29	2.3	23.59	33	9.41
		1 / 13	21100	2535	23.05	2.3	25.35	33	7.65
		1 / 0	21425	2567.5	22.29	2.3	24.59	33	8.41
	10	1 / 25	20800	2505	21.13	2.3	23.43	33	9.57
		1 / 25	21100	2535	22.35	2.3	24.65	33	8.35
		1 / 25	21400	2565	22.29	2.3	24.59	33	8.41
	15	1 / 38	20825	2507.5	21.29	2.3	23.59	33	9.41
		1 / 38	21100	2535	22.35	2.3	24.65	33	8.35
		1 / 38	21375	2562.5	22.26	2.3	24.56	33	8.44
	20	1 / 50	20850	2510	21.28	2.3	23.58	33	9.42
		1 / 50	21100	2535	22.29	2.3	24.59	33	8.41
		1 / 50	21350	2560	22.26	2.3	24.56	33	8.44



America

LTE Band 13									
Modulation	Bandwidth (MHz)	RB Size/Offset	Channels	Frequency (MHz)	Tx Average Power (dBm)	Antenna Gain (dBi)	EIRP (dBm)	Limit (dBm)	Margin (dBm)
QPSK	5	1 / 24	23205	779.5	23.82	-0.6	23.22	36.99	13.77
		1 / 0	23230	782	23.95	-0.6	23.35	36.99	13.64
		1 / 0	23255	784.5	23.95	-0.6	23.35	36.99	13.64
	10	-	-	-	-	-	-	-	-
		1 / 0	23230	782	23.93	-0.6	23.33	36.99	13.66
		-	-	-	-	-	-	-	-
16QAM	5	1 / 24	23205	779.5	23.01	-0.6	22.41	36.99	14.58
		1 / 13	23230	782	23.08	-0.6	22.48	36.99	14.51
		1 / 0	23255	784.5	23.22	-0.6	22.62	36.99	14.37
	10	-	-	-	-	-	-	-	-
		1 / 0	23230	782	23.05	-0.6	22.45	36.99	14.54
		-	-	-	-	-	-	-	-



LTE Band 66									
Modulation	Bandwidth (MHz)	RB Size/Offset	Channels	Frequency (MHz)	Tx Average Power (dBm)	Antenna Gain (dBi)	EIRP (dBm)	Limit (dBm)	Margin (dBm)
QPSK	1.4	1 / 3	131979	1710.7	23.94	0.0	23.94	33	9.06
		1 / 3	132322	1745	23.11	0.0	23.11	33	9.89
		1 / 3	132665	1779.3	22.87	0.0	22.87	33	10.13
	3	1 / 0	131987	1711.5	23.91	0.0	23.91	33	9.09
		1 / 0	132322	1745	23.03	0.0	23.03	33	9.97
		1 / 0	132657	1778.5	22.84	0.0	22.84	33	10.16
	5	1 / 0	131997	1712.5	23.95	0.0	23.95	33	9.05
		1 / 0	132322	1745	23.12	0.0	23.12	33	9.88
		1 / 0	132647	1777.5	23.06	0.0	23.06	33	9.94
	10	1 / 0	132022	1715	24.0	0.0	24.0	33	9
		1 / 0	132322	1745	23.19	0.0	23.19	33	9.81
		1 / 0	132622	1775	22.94	0.0	22.94	33	10.06
	15	1 / 0	132047	1717.5	23.92	0.0	23.92	33	9.08
		1 / 0	132322	1745	23.2	0.0	23.2	33	9.8
		1 / 0	132597	1772.5	23.04	0.0	23.04	33	9.96
	20	1 / 0	132072	1720	23.98	0.0	23.98	33	9.02
		1 / 0	132322	1745	23.41	0.0	23.41	33	9.59
		1 / 0	132572	1770	22.98	0.0	22.98	33	10.02



LTE Band 66									
Modulation	Bandwidth (MHz)	RB Size/Offset	Channels	Frequency (MHz)	Tx Average Power (dBm)	Antenna Gain (dBi)	EIRP (dBm)	Limit (dBm)	Margin (dBm)
16QAM	1.4	1 / 3	131979	1710.7	22.75	0.0	22.75	33	10.25
		1 / 3	132322	1745	21.95	0.0	21.95	33	11.05
		1 / 3	132665	1779.3	21.87	0.0	21.87	33	11.13
	3	1 / 0	131987	1711.5	22.71	0.0	22.71	33	10.29
		1 / 0	132322	1745	21.94	0.0	21.94	33	11.06
		1 / 0	132657	1778.5	21.93	0.0	21.93	33	11.07
	5	1 / 13	131997	1712.5	23.02	0.0	23.02	33	9.98
		1 / 0	132322	1745	22.15	0.0	22.15	33	10.85
		1 / 13	132647	1777.5	22.28	0.0	22.28	33	10.72
	10	1 / 0	132022	1715	22.74	0.0	22.74	33	10.26
		1 / 0	132322	1745	22.11	0.0	22.11	33	10.89
		1 / 0	132622	1775	22.1	0.0	22.1	33	10.9
	15	1 / 0	132047	1717.5	22.83	0.0	22.83	33	10.17
		1 / 0	132322	1745	22.32	0.0	22.32	33	10.68
		1 / 0	132597	1772.5	21.97	0.0	21.97	33	11.03
	20	1 / 0	132072	1720	22.8	0.0	22.8	33	10.2
		1 / 0	132322	1745	22.4	0.0	22.4	33	10.6
		1 / 0	132572	1770	22.23	0.0	22.23	33	10.77



2.3 EFFECTIVE RADIATED POWER

2.3.1 Specification Reference

FCC 47 CFR Part 2, Clause 2.1046
FCC 47 CFR Part 27, Clause 27.50 (b)(10)

2.3.2 Standard Applicable

FCC 47 CFR Part 27.50(b)
(10) Portable stations (hand-held devices) transmitting in the 746-757 MHz, 776-788 MHz, and 805-806 MHz bands are limited to 3 watts ERP.

2.3.3 Equipment Under Test

Serial No: AZ280418A00044, Test Configuration (N/A, calculation only)

2.3.4 Date of Verification/Initial of test personnel who performed the calculation

June 18, 2018 / XYZ

2.3.5 Additional Observations

- ERP was calculated as per Section 1.2 and 1.3 of KDB412172 D01 (Determining ERP and EIRP v01r01).
- Calculation formula in logarithmic terms:

$$\text{ERP} = P_T + G_T - L_c - 2.15\text{dB}$$

Where:

P_T = transmitter conducted output power dBm (Section 2.1 of this test report)

G_T = gain of the transmitting antenna, in dBi (EIRP - the -2.15 in the formula is to convert EIRP to ERP);

L_c = signal attenuation in the connecting cable between the transmitter and antenna, in dB (Power measurement performed directly at the primary antenna port. The loss between the LTE module and the primary antenna port is considered negligible).

- Only the worst-case RB size and RB offset presented.



2.3.6 Test Results

LTE Band 13									
Modulation	Bandwidth (MHz)	RB Size/Offset	Channels	Frequency (MHz)	Tx Average Power (dBm)	Antenna Gain (dBi)	ERP (dBm)	Limit (dBm)	Margin (dBm)
QPSK	5	1 / 24	23205	779.5	23.82	-0.6	21.07	34.77	13.7
		1 / 0	23230	782	23.95	-0.6	21.2	34.77	13.57
		1 / 0	23255	784.5	23.95	-0.6	21.2	34.77	13.57
	10	-	-	-	-	-	-	-	-
		1 / 0	23230	782	23.93	-0.6	21.18	34.77	13.59
		-	-	-	-	-	-	-	-
16QAM	5	1 / 24	23205	779.5	23.01	-0.6	20.26	34.77	14.51
		1 / 13	23230	782	23.08	-0.6	20.33	34.77	14.44
		1 / 0	23255	784.5	23.22	-0.6	20.47	34.77	14.3
	10	-	-	-	-	-	-	-	-
		1 / 0	23230	782	23.05	-0.6	20.3	34.77	14.47
		-	-	-	-	-	-	-	-



2.4 OCCUPIED BANDWIDTH

2.4.1 Specification Reference

FCC 47 CFR Part 2, Clause 2.1049
FCC 47 CFR Part 27, Clause 27.53 (h)
FCC 47 CFR Part 27, 27.53 (m)(4)
RSS-GEN 6.7

2.4.2 Standard Applicable

The transmitted signal bandwidth shall be reported as the 99% emission bandwidth, that is the frequency bandwidth such that, below its lower and above its upper frequency limits, the mean powers radiated are each equal to 0.5 percent of the total mean power radiated by a given emission.

26dB Bandwidth is defined as the width of the signal between two points, one below the carrier center frequency and one above the carrier center frequency, outside of which all emissions are attenuated by at least 26 dB below the transmitter power.

2.4.3 Equipment Under Test and Modification State

Serial No: AZ280418A00044 / Test Configuration A

2.4.4 Date of Test/Initial of test personnel who performed the test

June 07, 11 and 12, 2018 / XYZ

2.4.5 Test Equipment Used

The major items of test equipment used for the above tests are identified in Section 3.1.

2.4.6 Environmental Conditions/ Test Location

Test performed at TÜV SÜD America Inc. Rancho Bernardo facility

Ambient Temperature	24.8 - 25.7°C
Relative Humidity	46.4 - 53.3%
ATM Pressure	98.7 - 98.8kPa

2.4.7 Additional Observations

- This is a conducted test. Both 26dB bandwidth and 99% bandwidth presented.
- Using the occupied bandwidth measurement function in the spectrum analyzer, the 99% occupied bandwidth was measured.
- The 26dB bandwidth was measured in accordance with ANSI C63.26 clause 5.4.3 using the ndB measurement function in the spectrum analyzer.
- The transmitter shall be operated at its maximum carrier power measured under normal test conditions.



- The span of the analyzer shall be set to capture all products of the modulation process, including the emission skirts.
- The resolution bandwidth (RBW) shall be in the range of 1% of the occupied bandwidth (OBW) and video bandwidth (VBW) shall be at least 3x RBW.
- Low, Middle and High channels for all bandwidths and modulations were verified. Test results of Middle channel were presented as representative.

2.4.8 Test Results

LTE Band 4					
Modulation	Bandwidth (MHz)	Channel	Frequency (MHz)	99% OBW (MHz)	26dB BW (MHz)
QPSK	1.4	20175	1732.5	1.09	1.29
	3			2.70	3.40
	5			4.50	5.01
	10			8.99	9.94
	15			13.49	14.98
	20			17.88	19.19
16QAM	1.4	20175	1732.5	1.10	1.29
	3			2.70	3.23
	5			4.49	4.95
	10			8.98	9.77
	15			13.45	14.59
	20			17.88	19.19

LTE Band 7					
Modulation	Bandwidth (MHz)	Channel	Frequency (MHz)	99% OBW (MHz)	26dB BW (MHz)
QPSK	5	21100	2535.0	4.48	4.93
	10			8.97	9.72
	15			13.44	14.65
	20			17.92	19.28
16QAM	5	21100	2535.0	4.49	4.93
	10			8.96	9.72
	15			13.46	14.59
	20			17.93	19.28



LTE Band 13					
<i>Modulation</i>	<i>Bandwidth (MHz)</i>	<i>Channel</i>	<i>Frequency (MHz)</i>	<i>99% OBW (MHz)</i>	<i>26dB BW (MHz)</i>
QPSK	5	23230	782.0	4.46	4.86
	10			8.92	9.68
16QAM	5	23230	782.0	4.47	4.88
	10			8.91	9.64

LTE Band 66					
<i>Modulation</i>	<i>Bandwidth (MHz)</i>	<i>Channel</i>	<i>Frequency (MHz)</i>	<i>99% OBW (MHz)</i>	<i>26dB BW (MHz)</i>
QPSK	1.4	132322	1745.0	1.10	1.25
	3			2.70	3.04
	5			4.50	4.97
	10			8.98	9.90
	15			13.51	14.98
	20			17.97	19.54
16QAM	1.4	132322	1745.0	1.09	1.22
	3			2.70	3.00
	5			4.48	4.91
	10			8.97	9.81
	15			13.51	14.85
	20			17.97	19.45



2.4.9 Example Test Plots

LTE Band 4 (5 MHz BW) / Middle Channel 1732.5 MHz / QPSK / 99%OBW

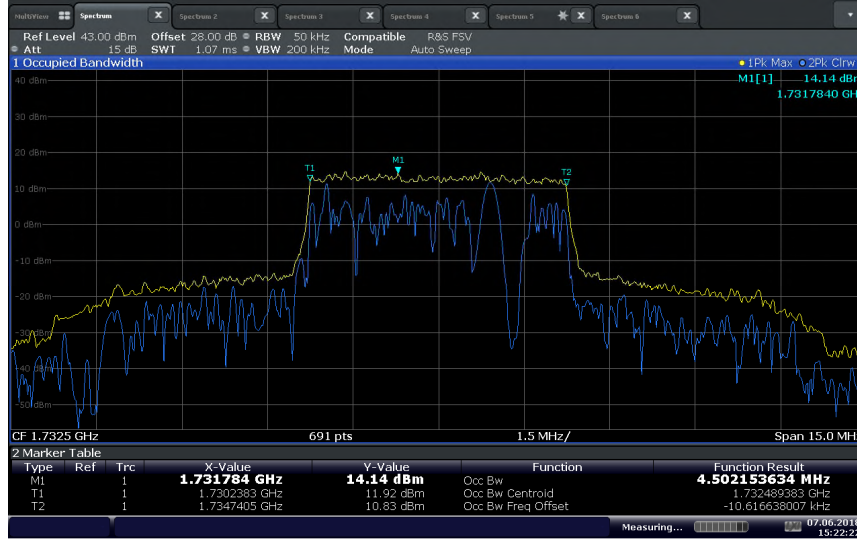

15:22:22 07.06.2018

LTE Band 4 (5 MHz BW) / Middle Channel 1732.5 MHz / QPSK / 26dB BW

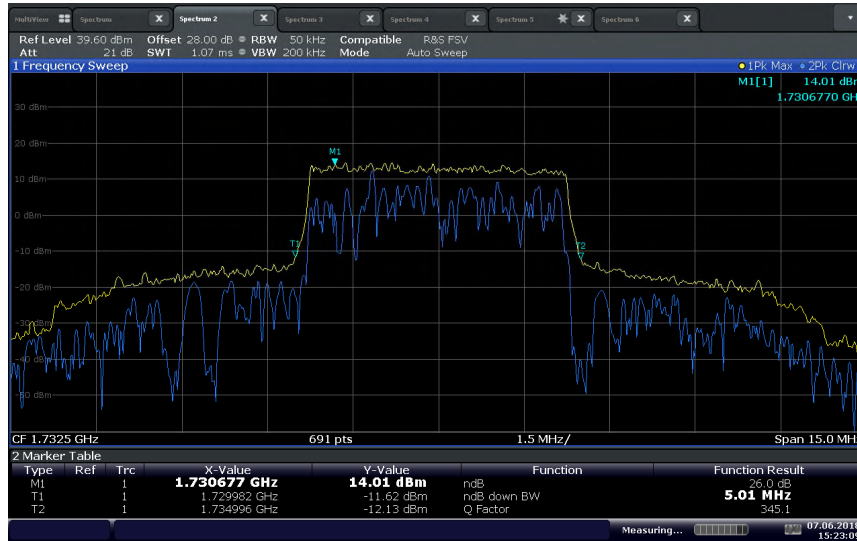

15:23:09 07.06.2018



LTE Band 7 (5 MHz BW) / Middle Channel 2535.0 MHz / QPSK / 99%OBW

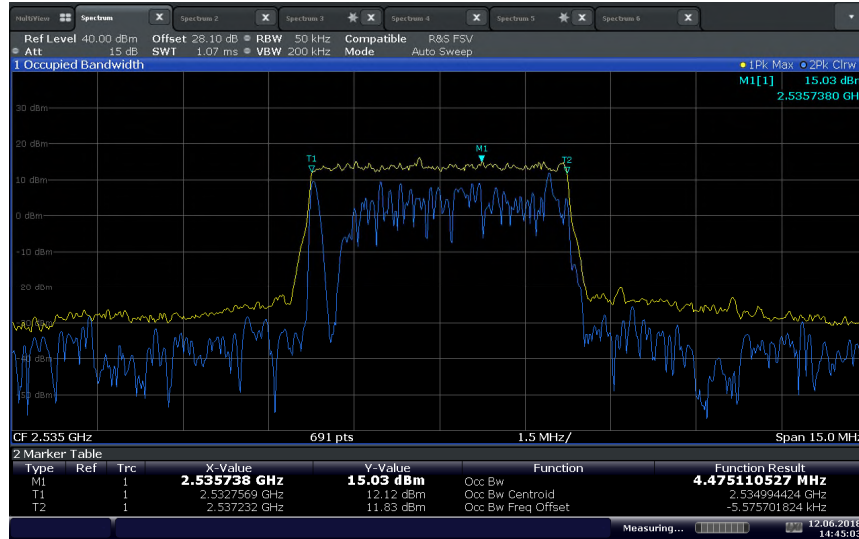

14:45:03 12.06.2018

LTE Band 7 (5 MHz BW) / Middle Channel 2535.0 MHz / QPSK / 26dB BW

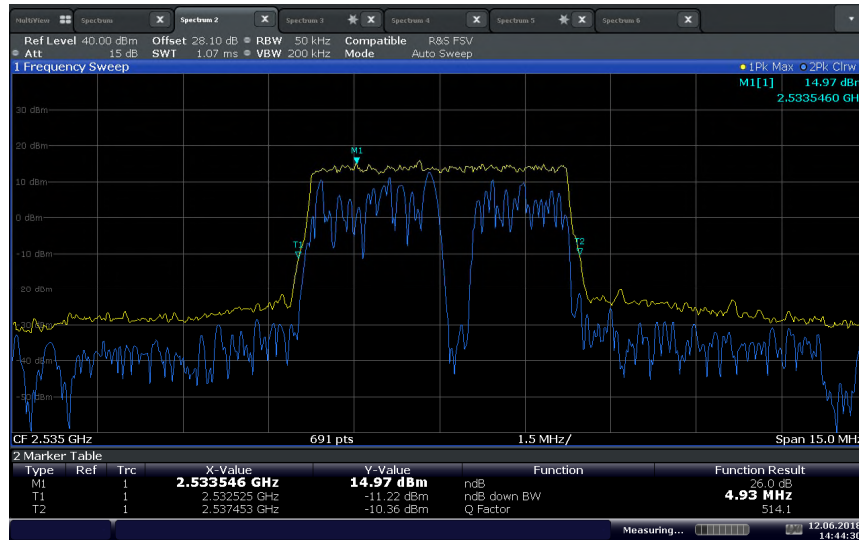

14:44:30 12.06.2018



LTE Band 13 (5 MHz BW) / Middle Channel 782.0 MHz / QPSK / 99%OBW

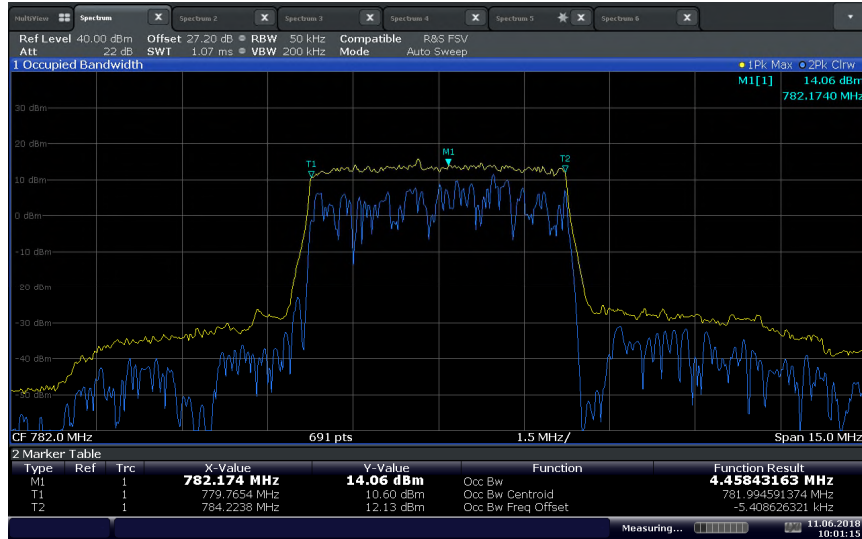

10:01:15 11.06.2018

LTE Band 13 (5 MHz BW) / Middle Channel 782.0 MHz / QPSK / 26dB BW



10:03:06 11.06.2018



LTE Band 66 (5 MHz BW) / Middle Channel 1745.0 MHz / QPSK / 99%OBW



13:29:46 11.06.2018

LTE Band 66 (5 MHz BW) / Middle Channel 1745.0 MHz / QPSK / 26dB BW



13:30:26 11.06.2018



2.5 PEAK-AVERAGE POWER RATIO

2.5.1 Specification Reference

FCC 47 CFR Part 27, Clause 27.50 (d)(5)
RSS-139, Clause 6.5
RSS-199, Clause 4.4
RSS-130, Clause 4.4

2.5.2 Standard Applicable

FCC 47 CFR Part 27.50(d):
(5) Power measurements for transmissions by stations authorized under this section may be made either in accordance with a Commission-approved average power technique or in compliance with paragraph (d)(6) of this section. In measuring transmissions in this band using an average power technique, the peak-to-average ratio (PAR) of the transmission may not exceed 13dB.

RSS-139, RSS-199 and RSS-130:
The transmitter's peak-to-average power ratio (PAPR) shall not exceed 13 dB for more than 0.1% of the time using a signal corresponding to the highest PAPR during periods of continuous transmission.

2.5.3 Equipment Under Test and Modification State

Serial No: AZ280418A00044 / Test Configuration A

2.5.4 Date of Test/Initial of test personnel who performed the test

June 11, 13 and 14, 2018 / XYZ

2.5.5 Test Equipment Used

The major items of test equipment used for the above tests are identified in Section 3.1.

2.5.6 Environmental Conditions/ Test Location

Test performed at TÜV SÜD America Inc. Rancho Bernardo facility

Ambient Temperature	24.9 – 26.2 °C
Relative Humidity	51.3 – 54.2 %
ATM Pressure	98.5 kPa



2.5.7 Additional Observations

- This is a conducted test.
- As per FCC KDB 971168 D01 v03r01 clause 5.7, the PAPR was measured in accordance with ANSI C63.26 clause 5.2.3.4.
- Measurement was done using the Spectrum Analyzer's Complementary Cumulative Distribution Function (CCDF) measurement profile. The built-in function is used to determine the largest deviation between the average and the peak power of the EUT in a given bandwidth (crest factor or peak-to-average ratio) A CCDF curve depicts the probability of the peak signal amplitude exceeding the average power level. Most contemporary measurement instrumentation include the capability to produce CCDF curves for an input signal provided that the instrument's resolution bandwidth can be set wide enough to accommodate the entire input signal bandwidth.
- Low, Middle and High channels for all bandwidths and modulations were verified.
- The path loss for was measured and entered as a level offset.
- There are no measured PAR levels greater than 13dB. EUT complies.



2.5.8 Test Results

LTE Band 4					
Modulation	Bandwidth (MHz)	Channels	Frequency (MHz)	PAR (dB)	Limit for PAR (dB)
QPSK	1.4	19957	1710.7	3.06	13
		20175	1732.5	3.15	13
		20393	1754.3	4.47	13
	3	19965	1711.5	3.19	13
		20175	1732.5	3.13	13
		20385	1753.5	4.03	13
	5	19975	1712.5	3.84	13
		20175	1732.5	3.08	13
		20375	1752.5	4.7	13
	10	20000	1715	4.98	13
		20175	1732.5	4.81	13
		20350	1750	4.71	13
	15	20025	1717.5	5.41	13
		20175	1732.5	5.64	13
		20325	1747.5	5.55	13
	20	20050	1720	6.44	13
		20175	1732.5	6.64	13
		20300	1745	6.74	13
16QAM	1.4	19957	1710.7	4.6	13
		20175	1732.5	4.32	13
		20393	1754.3	5.69	13
	3	19965	1711.5	4.43	13
		20175	1732.5	4.32	13
		20385	1753.5	5.34	13
	5	19975	1712.5	5.07	13
		20175	1732.5	4.19	13
		20375	1752.5	5.66	13
	10	20000	1715	5.96	13
		20175	1732.5	5.53	13
		20350	1750	5.96	13
	15	20025	1717.5	7.03	13
		20175	1732.5	6.81	13
		20325	1747.5	6.37	13
	20	20050	1720	7.77	13
		20175	1732.5	7.72	13
		20300	1745	7.99	13



LTE Band 7					
Modulation	Bandwidth (MHz)	Channels	Frequency (MHz)	PAR (dB)	Limit for PAR (dB)
QPSK	5	20775	2502.5	5.96	13
		21100	2535	6.12	13
		21425	2567.5	5.43	13
	10	20800	2505	5.64	13
		21100	2535	5.8	13
		21400	2565	5.65	13
	15	20825	2507.5	5.65	13
		21100	2535	5.65	13
		21375	2562.5	5.82	13
	20	20850	2510	6.73	13
		21100	2535	6.5	13
		21350	2560	6.72	13
16QAM	5	20775	2502.5	7.04	13
		21100	2535	7.32	13
		21425	2567.5	6.62	13
	10	20800	2505	6.9	13
		21100	2535	7.33	13
		21400	2565	7.03	13
	15	20825	2507.5	7.15	13
		21100	2535	7.73	13
		21375	2562.5	7.07	13
	20	20850	2510	7.55	13
		21100	2535	8.05	13
		21350	2560	8.02	13

LTE Band 13					
Modulation	Bandwidth (MHz)	Channels	Frequency (MHz)	PAR (dB)	Limit for PAR (dB)
QPSK	5	23205	779.5	5.23	13
		23230	782	4.83	13
		23255	784.5	5.64	13
	10	-	-	-	13
		23230	782	5.01	13
		-	-	-	13
16QAM	5	23205	779.5	6.48	13
		23230	782	6.33	13
		23255	784.5	6.65	13
	10	-	-	-	13
		23230	782	6.59	13
		-	-	-	13



LTE Band 66					
Modulation	Bandwidth (MHz)	Channels	Frequency (MHz)	PAR (dB)	Limit for PAR (dB)
QPSK	1.4	131979	1710.7	2.92	13
		132322	1745	3.8	13
		132665	1779.3	4.23	13
	3	131987	1711.5	2.91	13
		132322	1745	3.64	13
		132657	1778.5	3.86	13
	5	131997	1712.5	3.86	13
		132322	1745	4.3	13
		132647	1777.5	4.6	13
	10	132022	1715	4.76	13
		132322	1745	4.78	13
		132622	1775	4.93	13
	15	132047	1717.5	5.41	13
		132322	1745	5.62	13
		132597	1772.5	5.78	13
	20	132072	1720	6.85	13
		132322	1745	6.56	13
		132572	1770	6.57	13
16QAM	1.4	131979	1710.7	4.39	13
		132322	1745	5.19	13
		132665	1779.3	5.45	13
	3	131987	1711.5	4.28	13
		132322	1745	4.77	13
		132657	1778.5	5.04	13
	5	131997	1712.5	4.84	13
		132322	1745	4.55	13
		132647	1777.5	5.56	13
	10	132022	1715	6.15	13
		132322	1745	5.89	13
		132622	1775	6.24	13
	15	132047	1717.5	6.81	13
		132322	1745	6.95	13
		132597	1772.5	7.11	13
	20	132072	1720	7.89	13
		132322	1745	8.02	13
		132572	1770	7.6	13



2.5.9 Example Test Plots

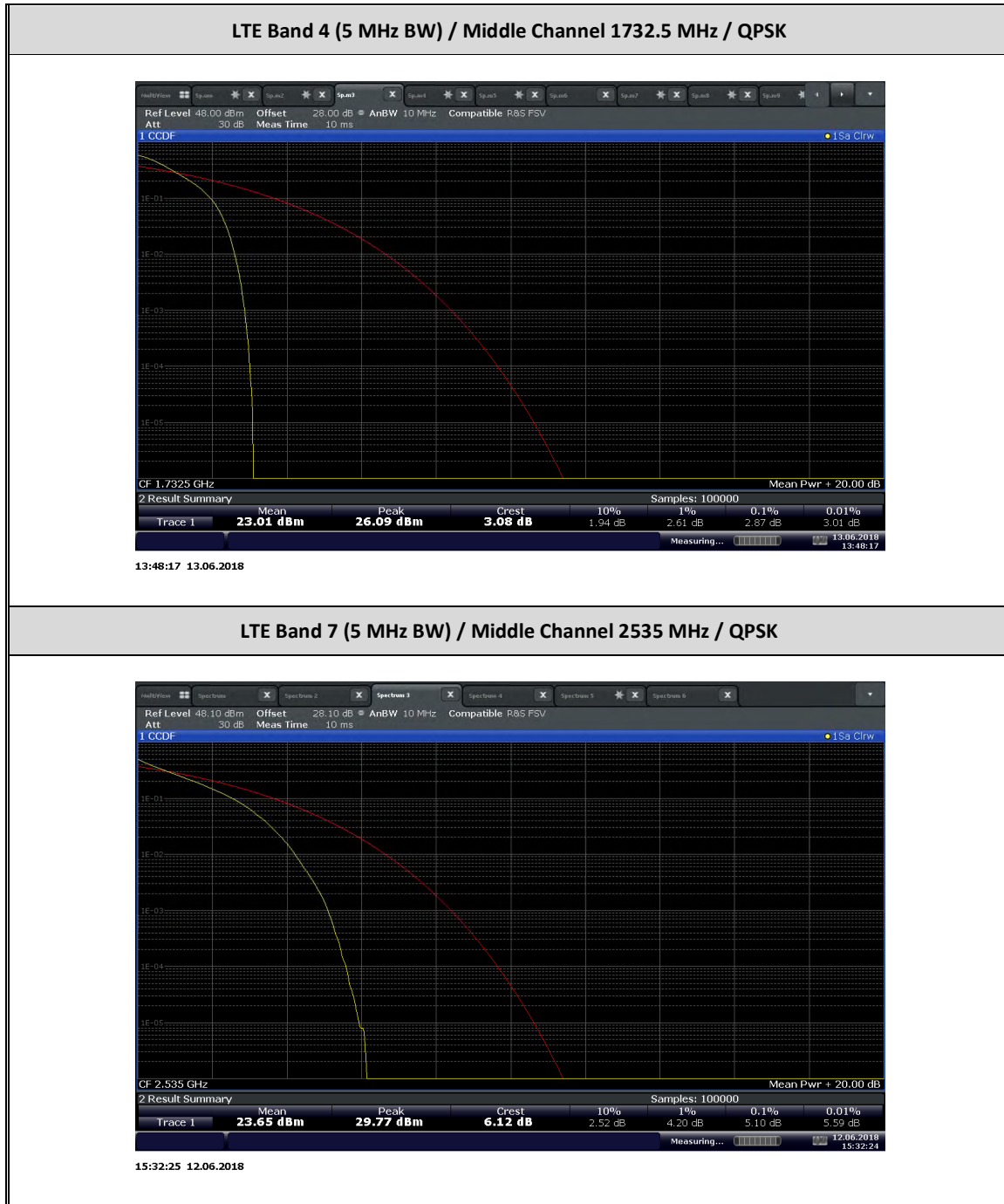



LTE Band 13 (5 MHz BW) / Middle Channel 782 MHz / QPSK



15:04:55 13.06.2018

LTE Band 66 (5 MHz BW) / Middle Channel 1745 MHz / QPSK

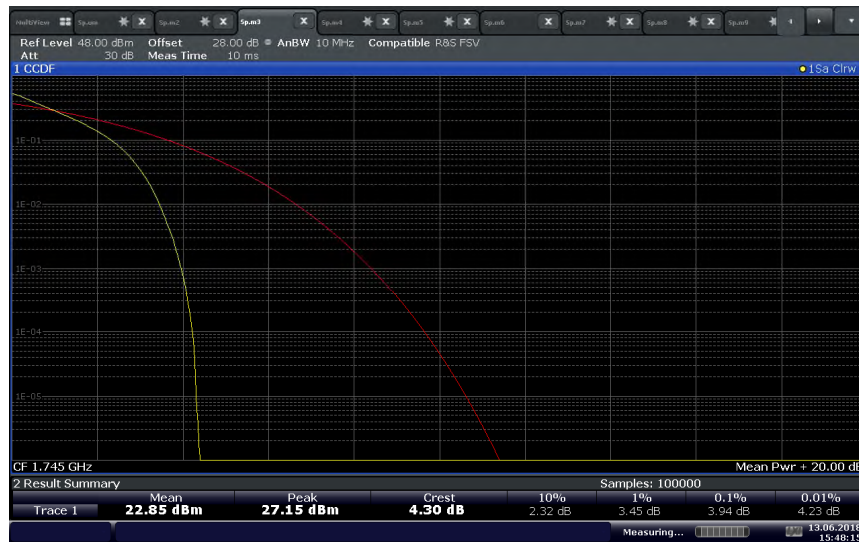

15:48:15 13.06.2018



2.6 SPURIOUS EMISSION AT BAND EDGE

2.6.1 Specification Reference

FCC 47 CFR Part 2, Clause 2.1051
FCC 47 CFR Part 27, Clause 27.53(h)(1)(3)
FCC 47 CFR Part 27, Clause 27.53(m)(4)(6)
FCC 47 CFR Part 27, Clause 27.53(c)(2)(5)
RSS-139, Clause 6.6
RSS-199, Clause 4.5
RSS-130, Clause 4.6

2.6.2 Standard Applicable

FCC 47 CFR Part 27.53

(h)(1) AWS emission limits – (1) General protection levels. Except as otherwise specified below, for operations in the 1695-1710 MHz, 1710-1755 MHz, 1755-1780 MHz, 1915-1920 MHz, 1995-2000 MHz, 2000-2020 MHz, 2110-2155 MHz, 2155-2180 MHz, and 2180-2200 MHz bands, the power of any emission outside a licensee's frequency block shall be attenuated below the transmitter power (P) in watts by at least $43 + 10 \log_{10}(P)$ dB.

(m)(4) For mobile digital stations, the attenuation factor shall be not less than $40 + 10 \log(P)$ dB on all frequencies between the channel edge and 5 megahertz from the channel edge, $43 + 10 \log(P)$ dB on all frequencies between 5 megahertz and X megahertz from the channel edge, and $55 + 10 \log(P)$ dB on all frequencies more than X megahertz from the channel edge, where X is the greater of 6 megahertz or the actual emission bandwidth as defined in paragraph (m)(6) of this section.

(c) For operations in the 746-758 MHz band and the 776-788 MHz band, the power of any emission outside the licensee's frequency band(s) of operation shall be attenuated below the transmitter power (P) within the licensed band(s) of operation, measured in watts, in accordance with the following:

(2) On any frequency outside the 776-788 MHz band, the power of any emission shall be attenuated outside the band below the transmitter power (P) by at least $43 + 10 \log_{10}(P)$ dB.

RSS-139, Clause 6.6:

(i) In the first 1.0 MHz bands immediately outside and adjacent to the equipment's smallest operating frequency block, which can contain the equipment's occupied bandwidth, the emission power per any 1% of the emission bandwidth shall be attenuated below the transmitter output power P (dBW), by at least $43 + 10 \log_{10} p$ (watts) dB.

RSS-199, Clause 4.5:

In the 1 MHz band immediately outside and adjacent to the channel edge, the unwanted emission power shall be measured with a resolution bandwidth of at 1% of the occupied bandwidth for base station and fixed subscriber equipment, and 2% for mobile subscriber equipment. Beyond the 1 MHz band, a resolution bandwidth of 1 MHz shall be used.

(b) for mobile subscriber equipment, the power of any unwanted emissions measured as above shall be attenuated (in dB) below the transmitter power, P (dBW), by at least:

(i) $40 + 10 \log_{10} p$ from the channel edges to 5 MHz away.

(ii) $43 + 10 \log_{10} p$ between 5 MHz and X MHz from the channel edges, and

(iii) $55 + 10 \log_{10} p$ at X MHz and beyond from the channel edges

Note: X is 6 MHz or the equipment occupied bandwidth, whichever is greater



RSS-130, Clause 4.6.1:

The power of any unwanted emissions in any 100 kHz bandwidth on any frequency outside the frequency range(s) within which the equipment is designed to operate shall be attenuated below the transmitter power, P (dBW), by at least $43 + 10 \log_{10} p$ (watts) dB. However, in the 100 kHz band immediately outside the equipment's operating frequency range, a resolution bandwidth of 30 kHz may be employed.

2.6.3 Equipment Under Test and Modification State

Serial No: AZ280418A00044 / Test Configuration A

2.6.4 Date of Test/Initial of test personnel who performed the test

July 16, 17 and 20, 2018 / XYZ

2.6.5 Test Equipment Used

The major items of test equipment used for the above tests are identified in Section 3.1.

2.6.6 Environmental Conditions/ Test Location

Test performed at TÜV SÜD America Inc. Rancho Bernardo facility

Ambient Temperature	24.7 - 25.1 °C
Relative Humidity	53.7 - 56.4 %
ATM Pressure	98.9 - 99.0 kPa

2.6.7 Additional Observations

- This is a conducted test.
- The path loss were measured and entered as a level offset.
- RBW is set to minimum 1% (for band 4, 13 and 66) or 2% (for band 7) of EBW and VBW is set to $>3 \times \text{RBW}$ in the 1 MHz (for band 4, 7 and 66) or 100 kHz (for band 13) band immediately outside and adjacent to the channel edge.
- For LTE Band 4 and 66, RBW was set 1% of the Emission Bandwidth for emissions more than 1.0 MHz outside the equipment's operating frequency block, and the limit is set to: $-13 + 10 \lg (\text{RBW}_{\text{used}}/1 \text{ MHz}) \text{ dBm}$.
- For LTE Band 13, RBW was set 1% of the Emission Bandwidth for emissions more than 100 kHz outside the equipment's operating frequency block, and the limit is set to: $-13 + 10 \lg (\text{RBW}_{\text{used}}/100 \text{ kHz}) \text{ dBm}$.
- For LTE Band 7, RBW was set 2% of the Emission Bandwidth and for emissions more than 1.0 MHz and less than 5 MHz outside the equipment's operating frequency block, the limit is set to: $-10 + 10 \lg (\text{RBW}_{\text{used}}/1 \text{ MHz}) \text{ dBm}$.
- Only worst case configuration for all technologies presented in this test report.

2.6.8 Test Results

LTE Band 4 (1.4 MHz BW)/QPSK/Low Channel 1710.7 MHz/Full RB Band Edge @1710 MHz



LTE Band 4 (1.4 MHz BW)/QPSK/High Channel 1754.3 MHz/Full RB Band Edge @1755 MHz





LTE Band 4 (1.4 MHz BW)/QPSK/Low Channel 1710.7 MHz/1 RB 0 offset Band Edge @1710 MHz



15:59:49 16.07.2018

LTE Band 4 (1.4 MHz BW)/QPSK/High Channel 1754.3 MHz/1 RB 5 offset Band Edge @1755 MHz

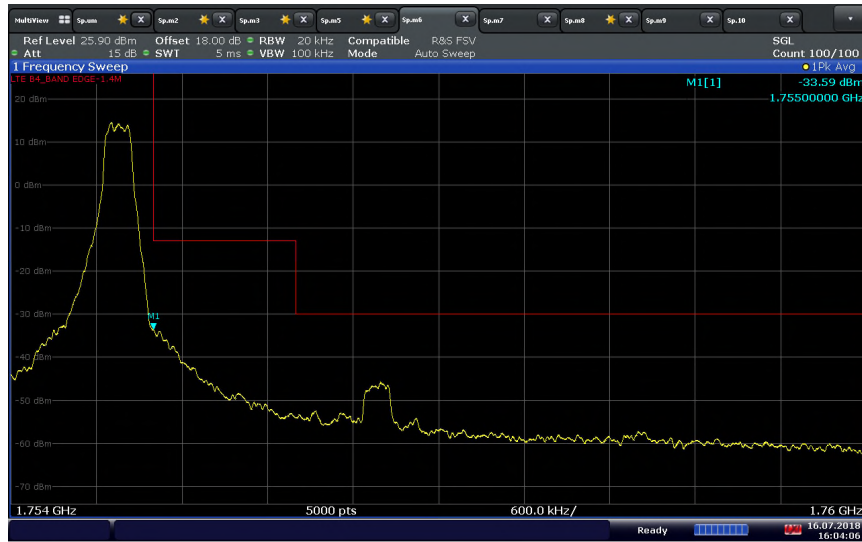

16:04:06 16.07.2018



LTE Band 4 (3 MHz BW)/QPSK/Low Channel 1711.5 MHz/Full RB Band Edge @1710 MHz

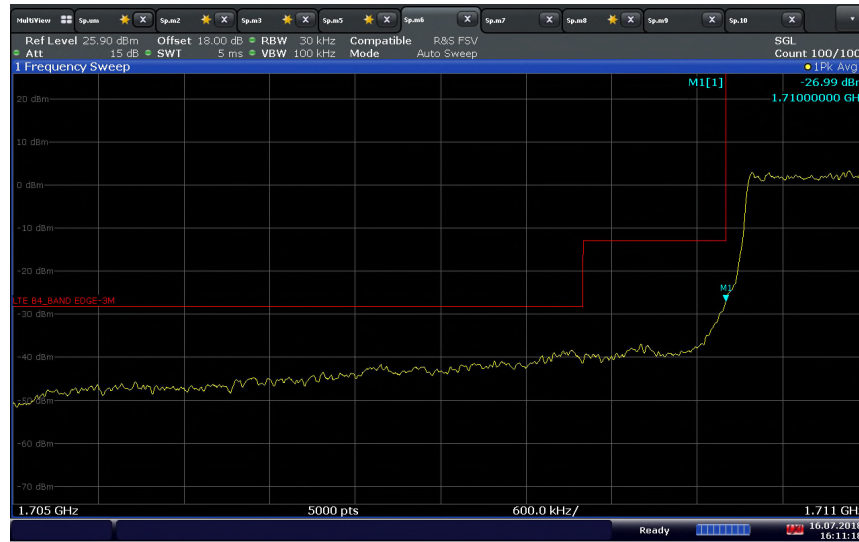

16:11:18 16.07.2018

LTE Band 4 (3 MHz BW)/QPSK/High Channel 1753.5 MHz /Full RB Band Edge @1755 MHz



16:07:46 16.07.2018



America

LTE Band 4 (3 MHz BW)/QPSK/Low Channel 1711.5 MHz/1 RB 0 offset Band Edge @1710 MHz



16:11:38 16.07.2018

LTE Band 4 (3 MHz BW)/QPSK/High Channel 1753.5 MHz/1 RB 14 offset Band Edge @1755 MHz



16:07:17 16.07.2018



LTE Band 4 (5 MHz BW)/QPSK/Low Channel 1712.5 MHz/Full RB Band Edge @1710 MHz

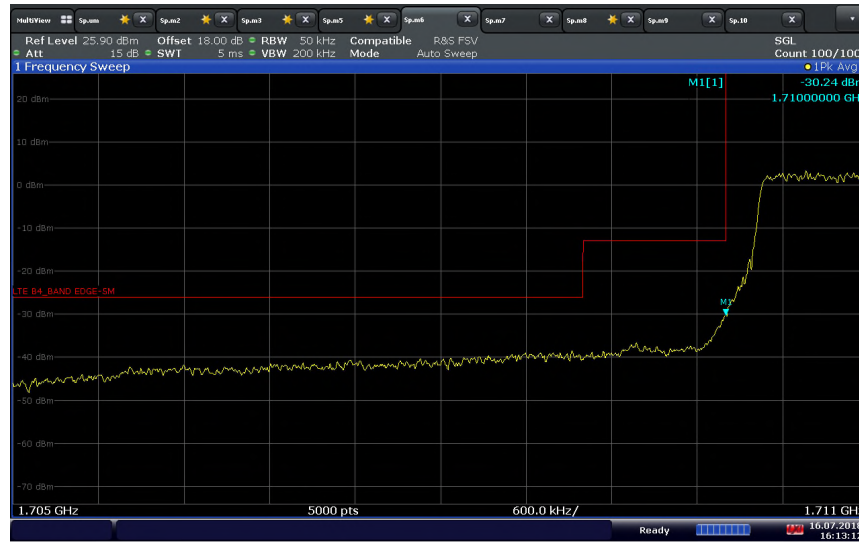

16:13:13 16.07.2018

LTE Band 4 (5 MHz BW)/QPSK/High Channel 1752.5 MHz/Full RB Band Edge @1755 MHz



16:16:59 16.07.2018



LTE Band 4 (5 MHz BW)/QPSK/Low Channel 1712.5 MHz/1 RB 0 offset Band Edge @1710 MHz



16:13:47 16.07.2018

LTE Band 4 (5 MHz BW)/QPSK/High Channel 1752.5 MHz/1 RB 24 offset Band Edge @1755 MHz



16:16:35 16.07.2018



LTE Band 4 (10 MHz BW)/QPSK/Low Channel 1715 MHz/Full RB Band Edge @1710 MHz

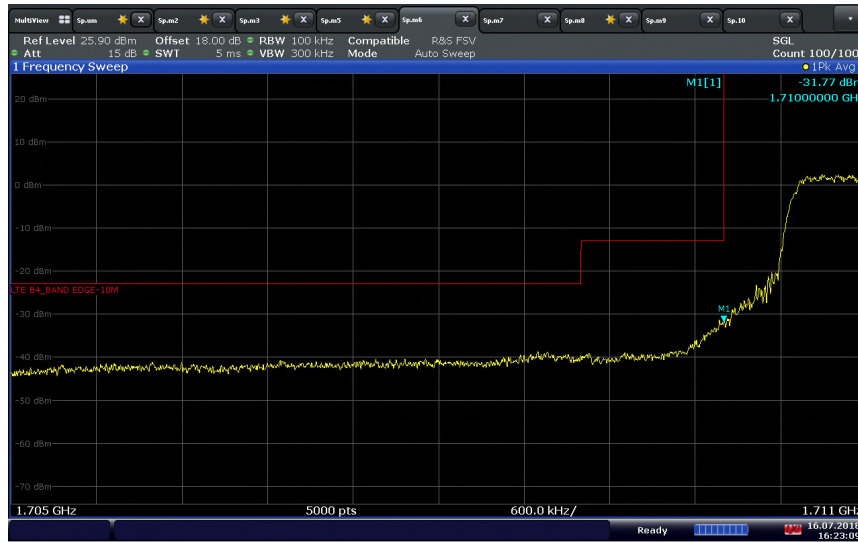

16:23:09 16.07.2018

LTE Band 4 (10 MHz BW)/QPSK/High Channel 1750 MHz/Full RB Band Edge @1755 MHz



16:19:15 16.07.2018



LTE Band 4 (10 MHz BW)/QPSK/Low Channel 1715 MHz/1 RB 0 offset Band Edge @1710 MHz

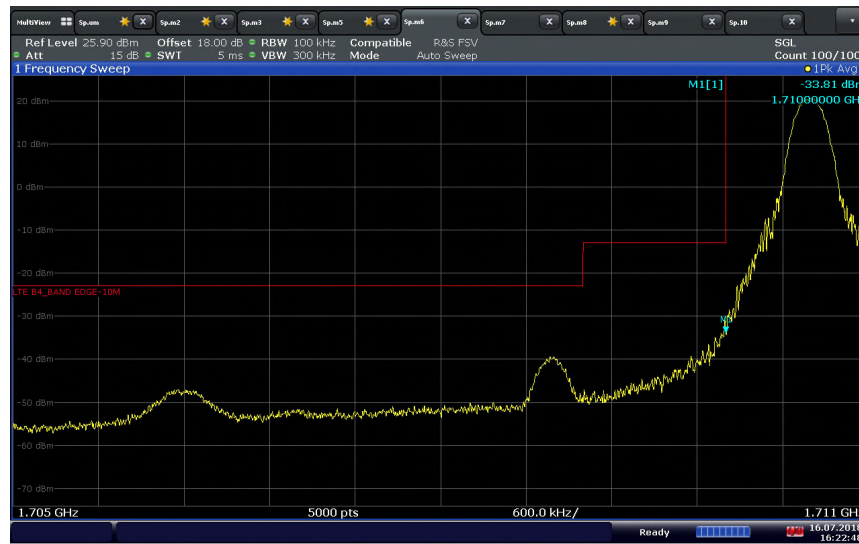

16:22:49 16.07.2018

LTE Band 4 (10 MHz BW)/QPSK/High Channel 1750 MHz/1 RB 49 offset Band Edge @1755 MHz

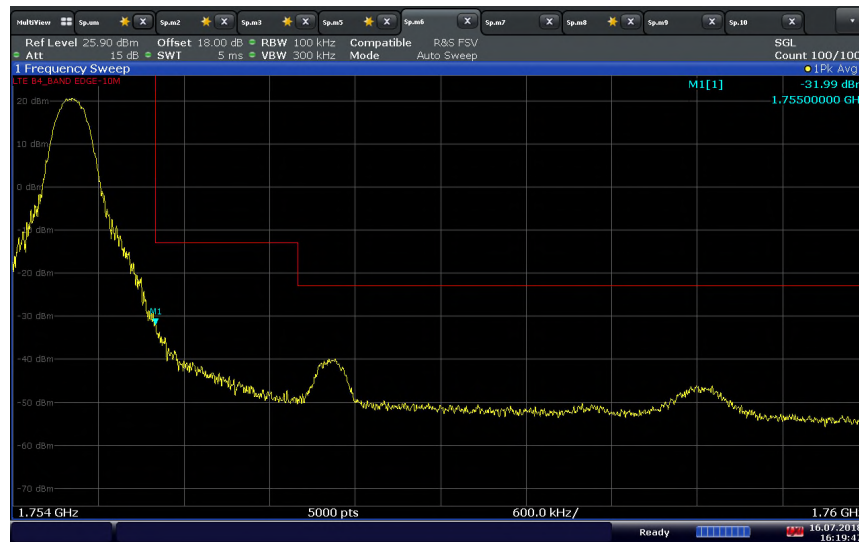

16:19:47 16.07.2018



LTE Band 4 (15 MHz BW)/QPSK/Low Channel 1717.5 MHz/Full RB Band Edge @1710 MHz

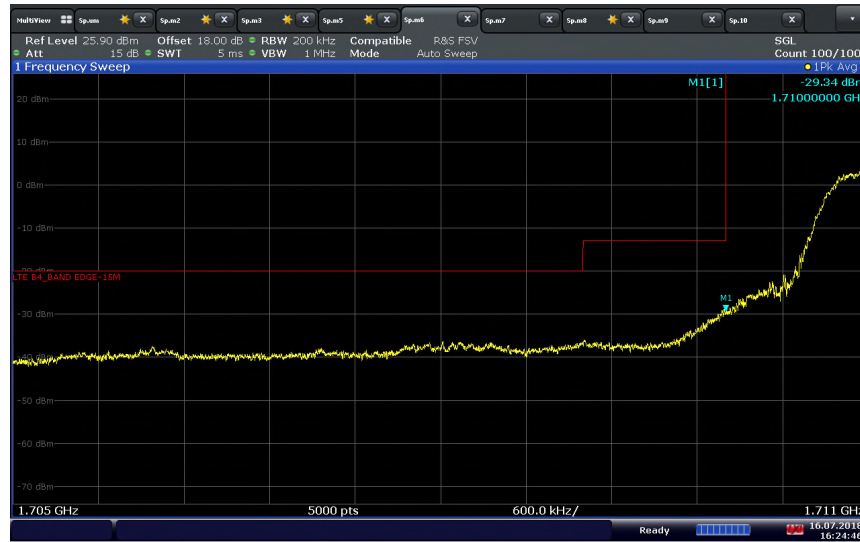

16:24:47 16.07.2018

LTE Band 4 (15 MHz BW)/QPSK/High Channel 1747.5 MHz/Full RB Band Edge @1755 MHz

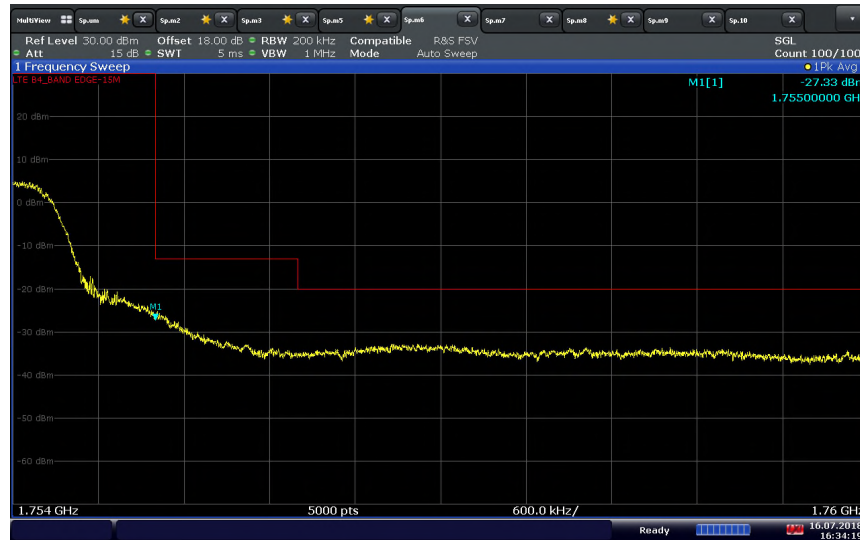

16:34:19 16.07.2018



LTE Band 4 (15 MHz BW)/QPSK/Low Channel 1717.5 MHz/1 RB 0 offset Band Edge @1710 MHz

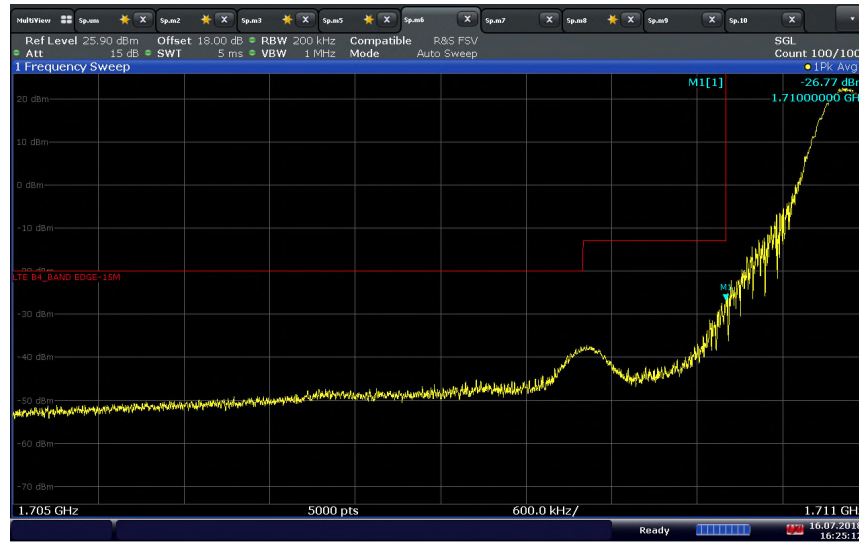

16:25:13 16.07.2018

LTE Band 4 (15 MHz BW)/QPSK/High Channel 1747.5 MHz/1 RB 74 offset Band Edge @1755 MHz

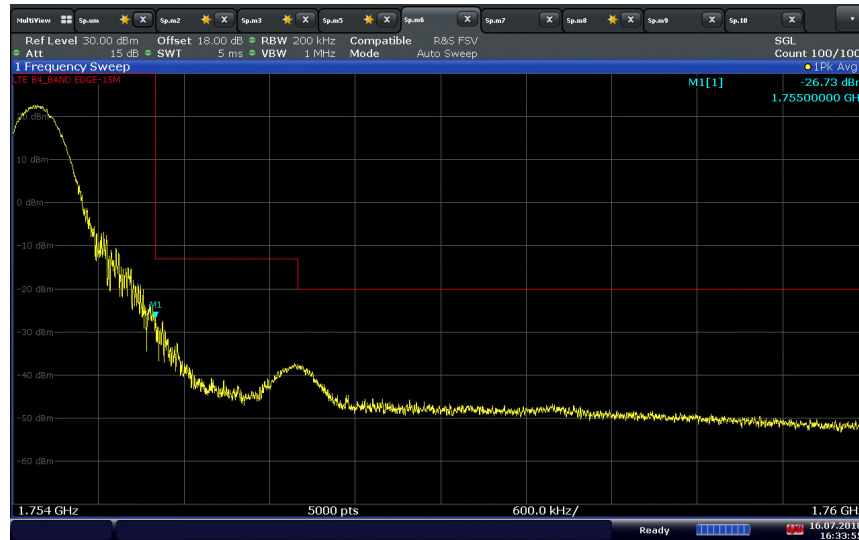

16:33:55 16.07.2018



LTE Band 4 (20 MHz BW)/QPSK/Low Channel 1720 MHz/Full RB Band Edge @1710 MHz

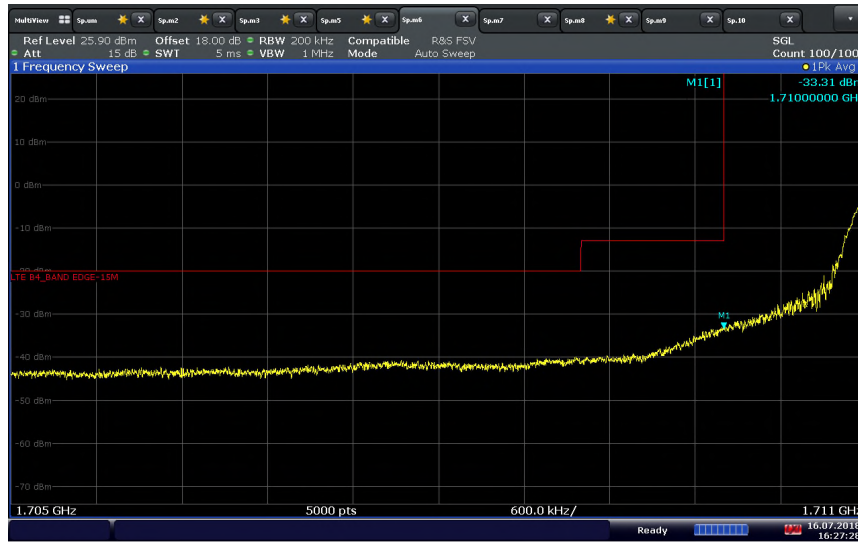

16:27:29 16.07.2018

LTE Band 4 (20 MHz BW)/QPSK/High Channel 1745 MHz/Full RB Band Edge @1755 MHz



16:30:02 16.07.2018



America

LTE Band 4 (20 MHz BW)/QPSK/Low Channel 1720 MHz/1 RB 0 offset Band Edge @1710 MHz

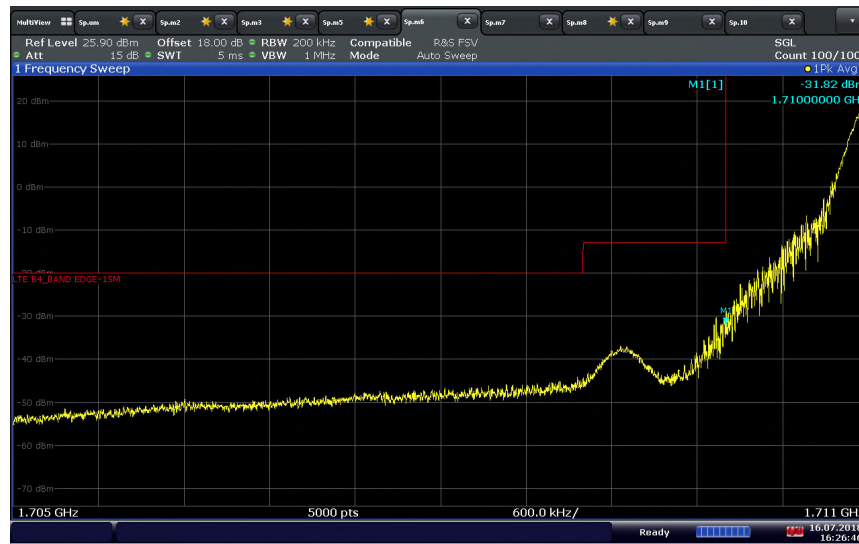

16:26:46 16.07.2018

LTE Band 4 (20 MHz BW)/QPSK/High Channel 1745 MHz/1 RB 99 offset Band Edge @1755 MHz

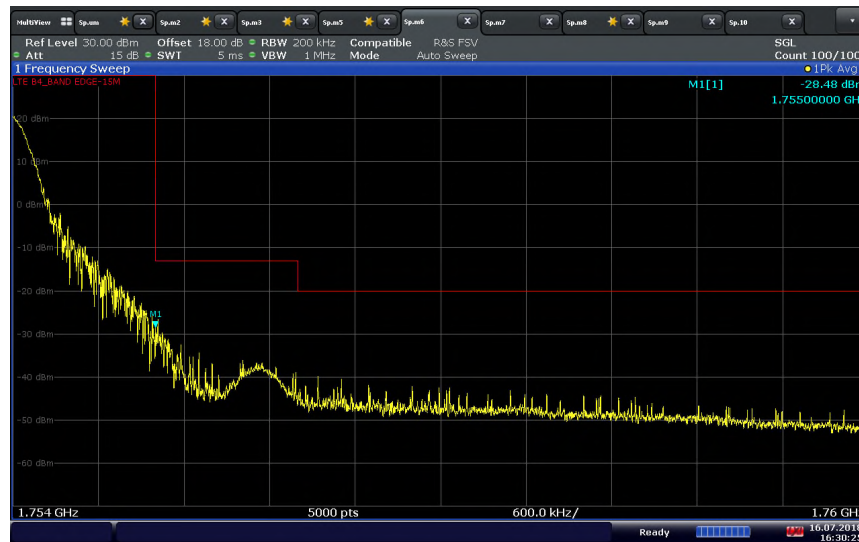

16:30:25 16.07.2018



LTE Band 7 (5 MHz BW)/QPSK/Low Channel 2502.5 MHz/Full RB Band Edge @2500 MHz

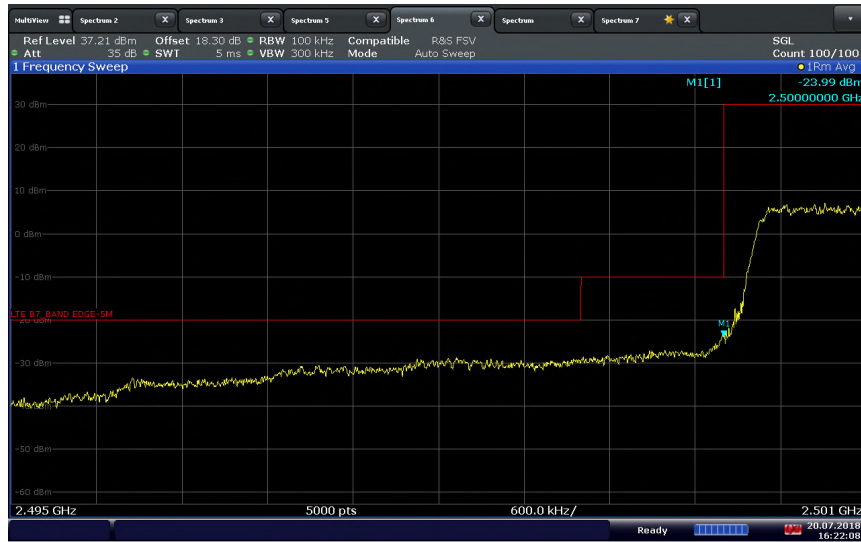

16:22:09 20.07.2018

LTE Band 7 (5 MHz BW)/QPSK/High Channel 2567.5 MHz/Full RB Band Edge @2570 MHz

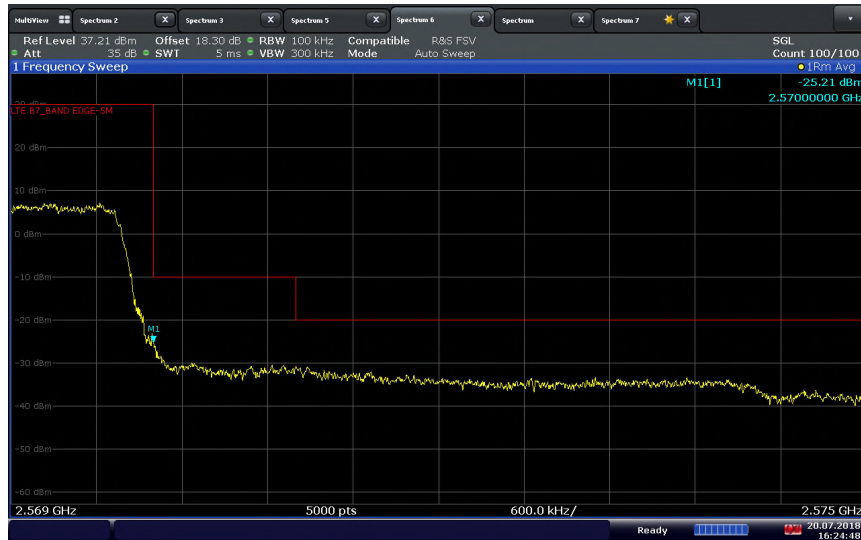

16:24:50 20.07.2018



America

LTE Band 7 (5 MHz BW)/QPSK/Low Channel 2502.5 MHz/1 RB 0 offset Band Edge @2500 MHz



16:22:36 20.07.2018

LTE Band 7 (5 MHz BW)/QPSK/High Channel 2567.5 MHz/1 RB 24 offset Band Edge @2570 MHz

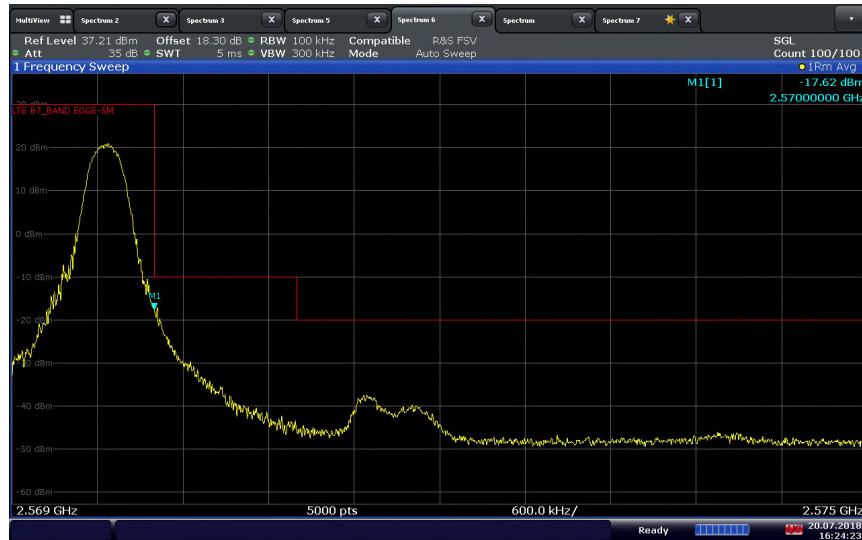

16:24:24 20.07.2018



LTE Band 7 (10 MHz BW)/QPSK/Low Channel 2505 MHz/Full RB Band Edge @2500 MHz

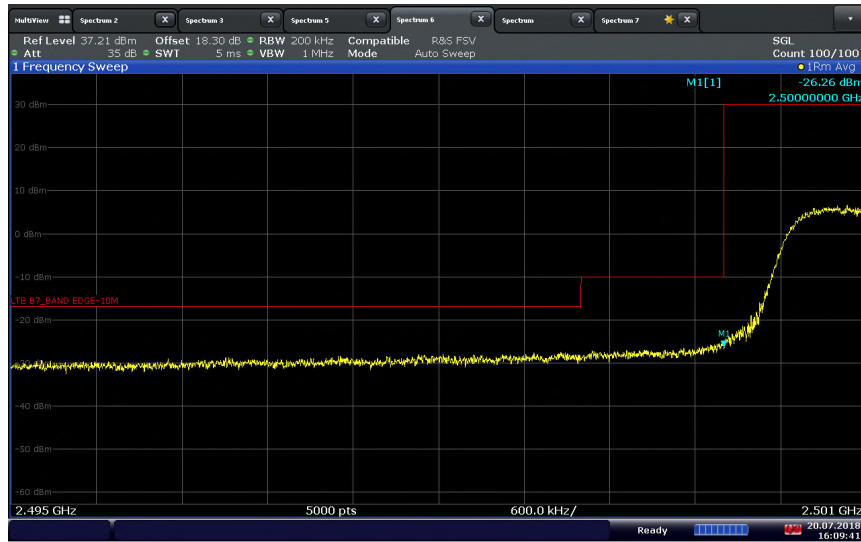

16:09:41 20.07.2018

LTE Band 7 (10 MHz BW)/QPSK/High Channel 2565 MHz/Full RB Band Edge @2570 MHz

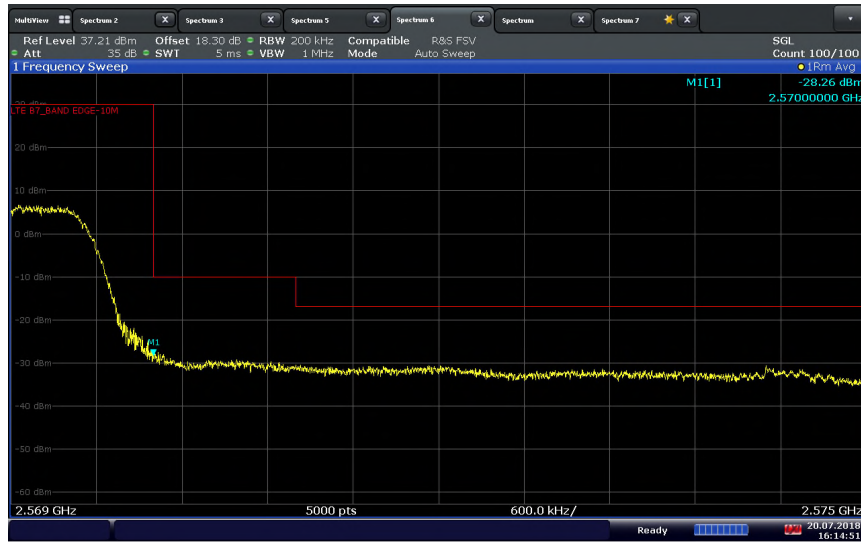

16:14:52 20.07.2018



LTE Band 7 (10 MHz BW)/QPSK/Low Channel 2505 MHz/1 RB 0 offset Band Edge @2500 MHz

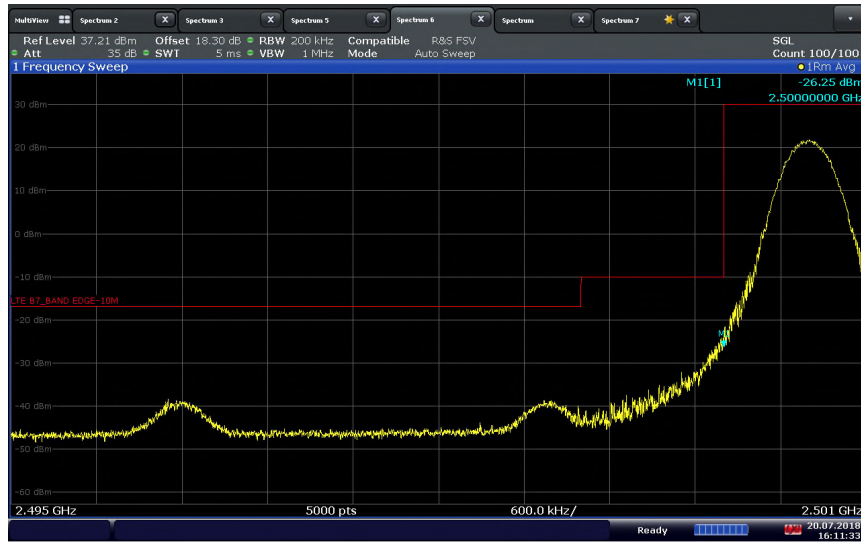

16:11:34 20.07.2018

LTE Band 7 (10 MHz BW)/QPSK/High Channel 2565 MHz/1 RB 49 offset Band Edge @2570 MHz

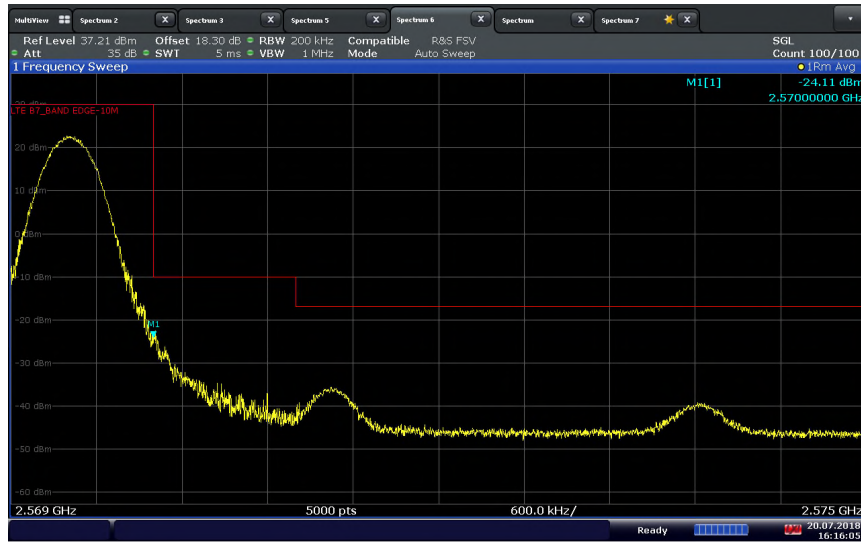

16:16:06 20.07.2018



LTE Band 7 (15 MHz BW)/QPSK/Low Channel 2507.5 MHz/Full RB Band Edge @2500 MHz

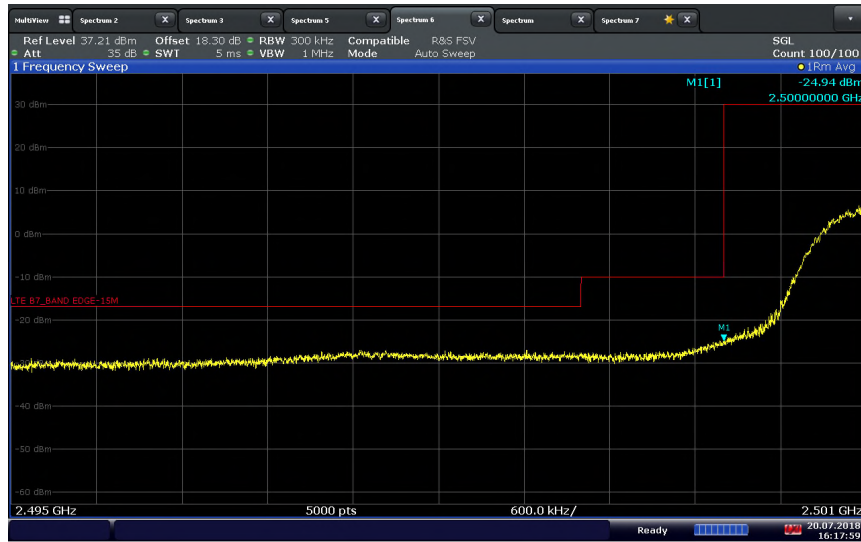

16:17:59 20.07.2018

LTE Band 7 (15 MHz BW)/QPSK/High Channel 2562.5 MHz/Full RB Band Edge @2570 MHz

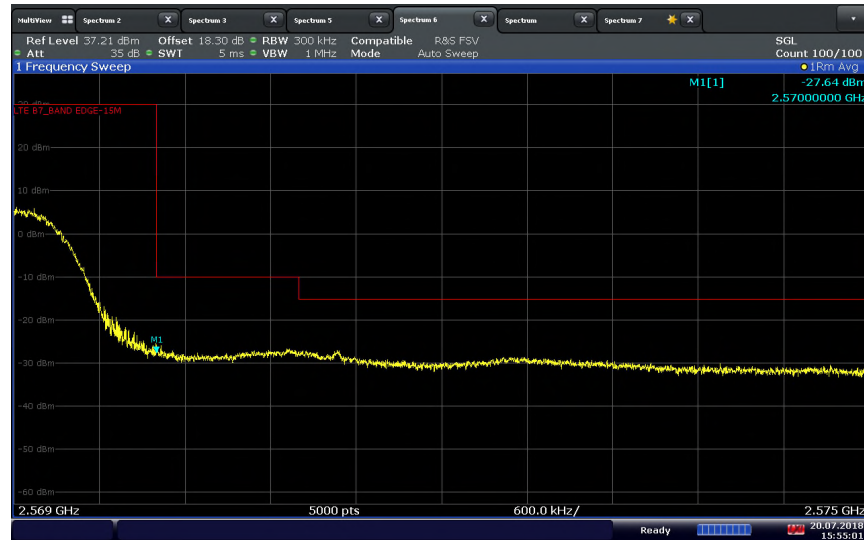

15:55:01 20.07.2018



LTE Band 7 (15 MHz BW)/QPSK/Low Channel 2507.5 MHz/1 RB 0 offset Band Edge @2500 MHz

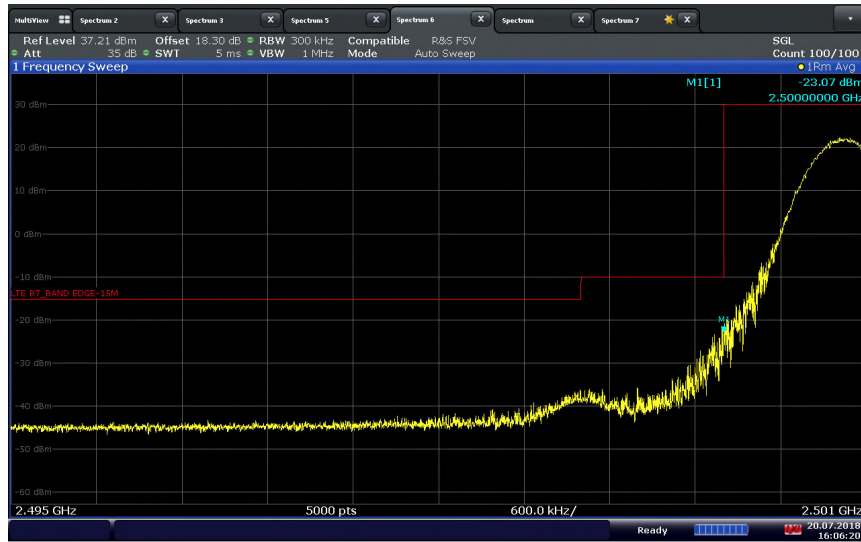

16:06:21 20.07.2018

LTE Band 7 (15 MHz BW)/QPSK/High Channel 2562.5 MHz/1 RB 74 offset Band Edge @2570 MHz

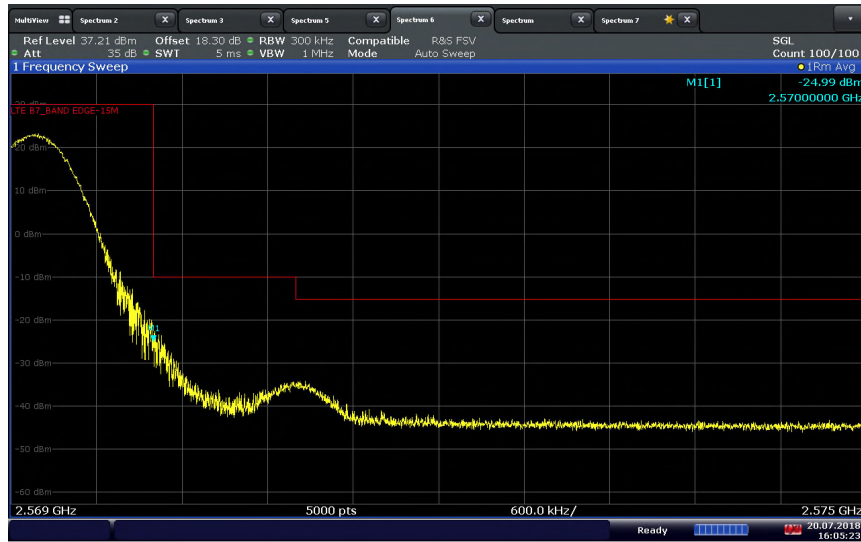

16:05:23 20.07.2018



America

LTE Band 7 (20 MHz BW)/QPSK/Low Channel 2510 MHz/Full RB Band Edge @2500 MHz

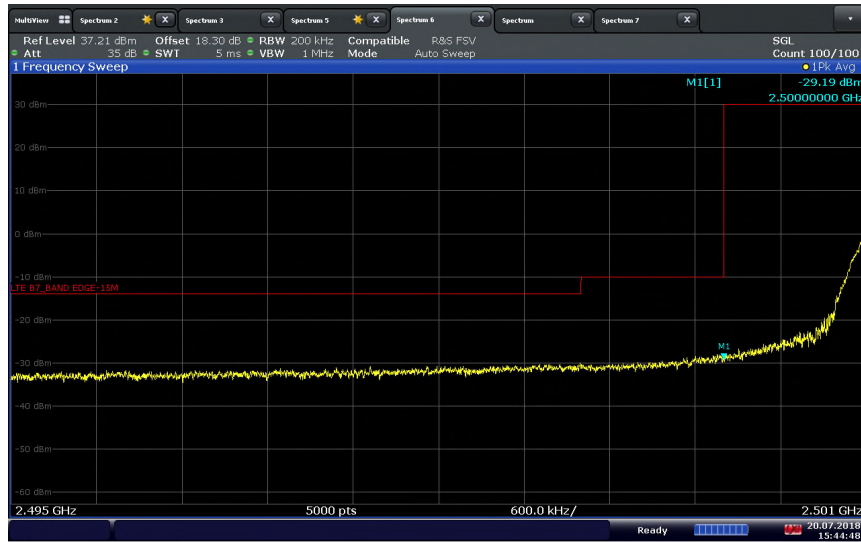

LTE Band 7 (20 MHz BW)/QPSK/High Channel 2560 MHz/Full RB Band Edge @2570 MHz

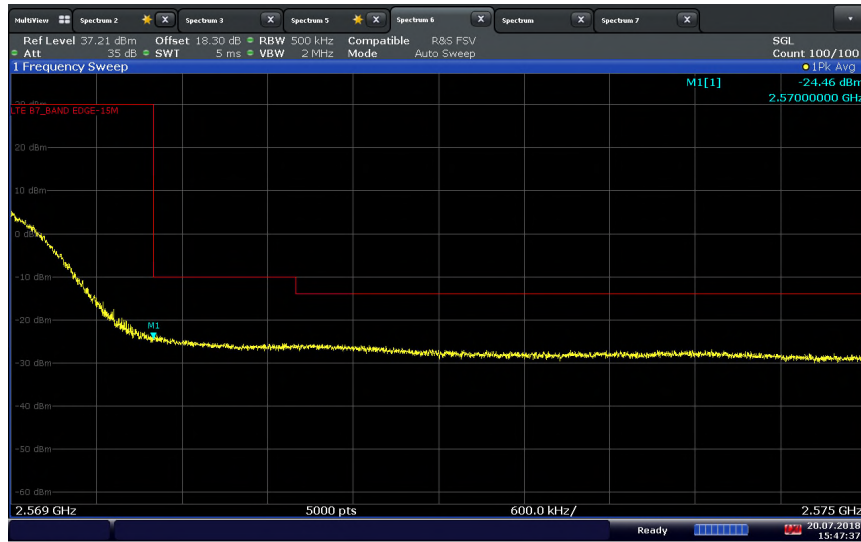



America

LTE Band 7 (20 MHz BW)/QPSK/Low Channel 2510 MHz/1 RB 0 offset Band Edge @2500 MHz

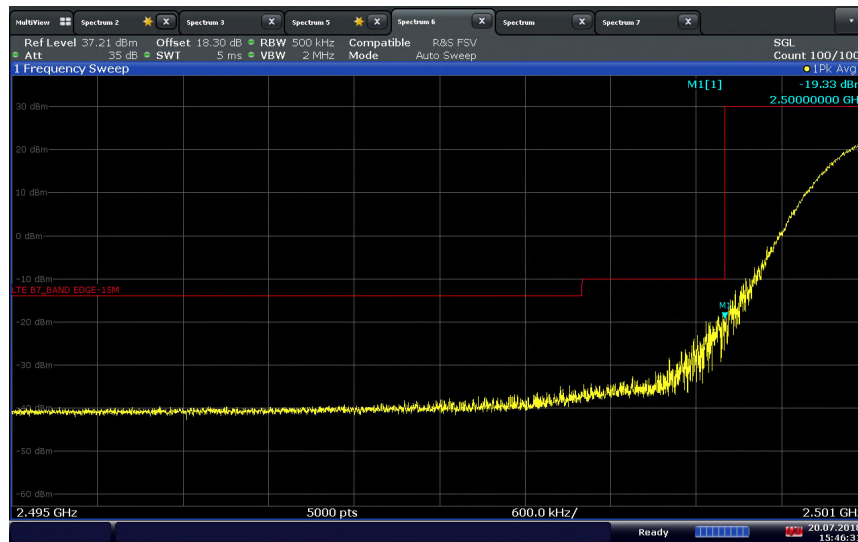

15:46:32 20.07.2018

LTE Band 7 (20 MHz BW)/QPSK/High Channel 2560 MHz/1 RB 99 offset Band Edge @2570 MHz

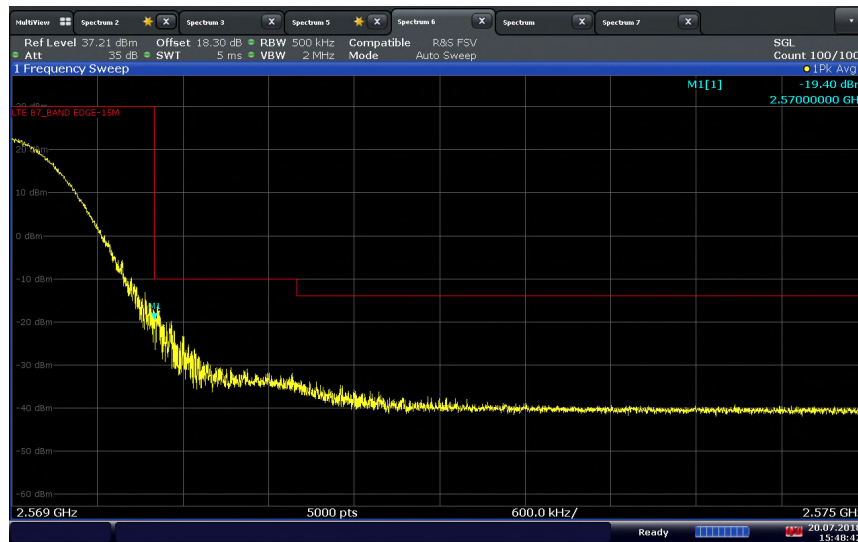

15:48:42 20.07.2018



LTE Band 13 (5 MHz BW)/QPSK/Low Channel 779.5 MHz/Full RB Band Edge @777 MHz



10:52:01 17.07.2018

LTE Band 13 (5 MHz BW)/QPSK/High Channel 784.5 MHz/Full RB Band Edge @787 MHz



11:03:22 17.07.2018



America

LTE Band 13 (5 MHz BW)/QPSK/Low Channel 779.5 MHz/1 RB 0 offset Band Edge @777 MHz



10:53:09 17.07.2018

LTE Band 13 (5 MHz BW)/QPSK/High Channel 784.5 MHz/1 RB 24 offset Band Edge @787 MHz



11:01:33 17.07.2018