



America

**Choose certainty.
Add value.**

Report On

Application for Grant of Equipment Authorization of the
Novatel Wireless Inc.

MIFI7730L Wireless Hotspot Modem

FCC CFR 47 Part 2, Part 22 and Part 24: 2015
RSS-132 issue 3: 2013 and RSS-133 issue 6: 2013

Report No. SD72118338-0716E

September 2016



REPORT ON Radio Testing of the
Novatel Wireless Inc.
MIFI7730L Wireless Hotspot Modem

TEST REPORT NUMBER SD72118338-0716E

PREPARED FOR Novatel Wireless Inc.
9645 Scranton Road, Suite 205
San Diego, CA 92121
USA

CONTACT PERSON Roman Olmos
Senior Regulatory Engineer
(858) 812-3400
rolmos@nvtl.com

PREPARED BY 
Alex Chang
Name
Authorized Signatory
Title: EMC/Wireless Test Engineer

APPROVED BY 
Juan Manuel Gonzalez
Name
Authorized Signatory
Title: Western Region EMC Service Line Manager

DATED September 14, 2016



Revision History

SD72118338-0716E Novatel Wireless Inc. MIFI7730L Wireless Hotspot Modem					
DATE	OLD REVISION	NEW REVISION	REASON	PAGES AFFECTED	APPROVED BY
09/14/2016	Initial Release				Juan M. Gonzalez



CONTENTS

Section	Page No
1	REPORT SUMMARY5
1.1	Introduction.....6
1.2	Brief Summary Of Results 7
1.3	Product Information8
1.4	EUT Test Configuration 11
1.5	Deviations From The Standard..... 14
1.6	Modification Record 14
1.7	Test Methodology 14
1.8	Test Facility Location 14
1.9	Test Facility Registration..... 15
1.10	Sample Calculations..... 16
2	TEST DETAILS.....18
2.1	Transmitter Conducted Power Measurements 19
2.2	Effective Radiated Power..... 25
2.3	Equivalent Isotropic Radiated Power 28
2.4	Peak-Average Ratio..... 32
2.5	Occupied Bandwidth..... 50
2.6	Spurious Emission At Band Edge 67
2.7	Conducted Spurious Emissions 90
2.8	Field Strength Of Spurious Radiation 112
2.9	Frequency Stability 150
3	TEST EQUIPMENT USED 157
3.1	Test Equipment Used..... 158
3.2	Measurement Uncertainty 159
4	DIAGRAM OF TEST SETUP160
4.1	Test Setup Diagram 161
5	ACCREDITATION, DISCLAIMERS AND COPYRIGHT 164
5.1	Accreditation, Disclaimers And Copyright 165



SECTION 1

REPORT SUMMARY

Radio Testing of the
Novatel Wireless Inc.
MIFI7730L Wireless Hotspot Modem



1.1 INTRODUCTION

The information contained in this report is intended to show verification of the Novatel Wireless Inc. MIFI7730L Wireless Hotspot Modem to the requirements of the following:

- FCC CFR 47 Part 2, Part 22 and Part 24: 2015
- RSS-132 issue 3: 2013 and RSS-133 issue 6: 2013

Objective	To perform Radio Testing to determine the Equipment Under Test's (EUT's) compliance with the Test Specification, for the series of tests carried out.
Manufacturer	Novatel Wireless Inc.
Product Marketing Name	MiFi 7730L
Model Number(s)	MIFI7730L
FCC ID Number	PKRNVWMIFI7730
IC Number	3229A-MIFI7730
Serial Number(s)	SZ17061900005 and SZ17061900013
Number of Samples Tested	2
Test Specification/Issue/Date	<ul style="list-style-type: none">• FCC CFR 47 Part 2, Part 22 and Part 24: 2015• 412172 D01 Determining ERP and EIRP v01r01 August 07, 2015 (Guidelines for determining the Effective Radiated Power (ERP) and Equivalent Isotropically Radiated Power (EIRP) of an RF transmitting system)• 971168 D01 Power Meas License Digital Systems v02r02: October 17 2014; (Measurement guidance for certification of licensed digital transmitters• RSS-132 issue 3: January 2013; (Cellular Telephone Systems Operating in the Bands 824-849 MHz and 869-894 MHz)• RSS-133 issue 6: January 2013; (2 GHz Personal Communications Services)• ANSI C63.26-2015. American National Standard for Compliance Testing of Transmitters Used in Licensed Radio Services
Start of Test	July 05, 2016
Finish of Test	August 01, 2016
Name of Engineer(s)	Alex Chang Ferdie Custodio Xiaoying Zhang Ivan Retana
Related Document(s)	Supporting documents for EUT certification are separate exhibits.



1.2 BRIEF SUMMARY OF RESULTS

A brief summary of the tests carried out in accordance with FCC CFR 47 Part 2, Part 22 and Part 24: 2015 and RSS-132 issue 3: 2013 and RSS-133 issue 6: 2013 standard is shown below.

Section	FCC Part Sections(s)	ISED Sections	Test Description	Result
2.1	2.1046	RSS-132: 5.4, RSS-133: 6.4	Transmitter Conducted Output Power	Compliant
2.2	2.1046, 22.913(a)(2)	-	Effective Radiated Power	Compliant
2.3	2.1046, 24.232(c)	RSS-132: 5.4 RSS-133: 6.4	Equivalent Isotropic Radiated Power	Compliant
2.4	24.232(d)	RSS-132: 5.4, RSS-133: 6.4	Peak-Average Ratio	Compliant
2.5	2.1049, 22.917(b), 24.238(b)	RSS-GEN 4.6.1	Occupied Bandwidth	Compliant
2.6	2.1051, 22.917(a), 24.238(a)	RSS-132: 5.5, RSS-133: 6.5	Band Edge	Compliant
2.7	2.1051, 22.917(a), 24.238(a)	RSS-132: 5.5, RSS-133: 6.5	Conducted Spurious Emissions	Compliant
2.8	2.1053, 22.917(a), 24.238(a)	RSS-132: 5.5, RSS-133: 6.5	Field Strength Of Spurious Radiation	Compliant
2.9	2.1055, 22.355, 24.235	RSS-132: 5.3, RSS-133: 6.3	Frequency Stability	Compliant



1.3.3 Transmit Frequency Table

Technology / Mode	Tx Frequency (MHz)	Emission Designator	ERP (Part 22) / EIRP (RSS-132 and Part 24/RSS-133)	
			ERP Max. Power (dBm)	EIRP Max. Power (dBm)
CDMA1xRTT Cell Band (BC0)	824-849	1M33F9W	23.910	—
CDMA1xRTT PCS Band (BC1)	1850-1910	1M34F9W	—	22.026
1xEvDO Release 0 Cell Band (BC0)	824-849	1M30F9W	23.749	—
1xEvDO Release 0 PCS Band (BC1)	1850-1910	1M31F9W	—	22.878
1xEvDO Release A Cell Band (BC0)	824-849	1M30F9W	23.900	—
1xEvDO Release A PCS Band (BC1)	1850-1910	1M30F9W	—	23.083
GSM850 (GPRS)	824-849	254KGXW	31.6	—
GSM1900 (GPRS)	1850-1910	246KGXW	—	28.2
GSM850 (EGPRS)	824-849	254KG7W	26.993	—
GSM1900 (EGPRS)	1850-1910	244KG7W	—	26.4
WCDMA Band 5	824-849	4M17F9W	23.512	—
WCDMA Band 2	1850-1910	4M15F9W	—	22.323



Technology / Mode	Modulation	Bandwidth (MHz)	Tx Frequency (MHz)	Emission Designator	ERP (Part 22) / EIRP (RSS-132 and Part 24/RSS-133)	
					ERP Max. Power (dBm)	EIRP Max. Power (dBm)
LTE Band 2	QPSK	1.4	1850-1910	1M09G7D	—	24.91
		3	1850-1910	2M69G7D	—	25.31
		5	1850-1910	4M47G7D	—	24.93
		10	1850-1910	8M99G7D	—	25.13
		15	1850-1910	13M5G7D	—	25.50
		20	1850-1910	17M9G7D	—	25.61
	16QAM	1.4	1850-1910	1M08W7D	—	24.06
		3	1850-1910	2M69W7D	—	24.47
		5	1850-1910	4M47W7D	—	24.24
		10	1850-1910	8M94W7D	—	24.32
		15	1850-1910	13M5W7D	—	24.64
		20	1850-1910	18M0W7D	—	24.83
LTE Band 5	QPSK	1.4	824-849	1M09G7D	19.35	—
		3	824-849	2M69G7D	18.86	—
		5	824-849	4M49G7D	19.28	—
		10	824-849	8M94G7D	19.13	—
	16QAM	1.4	824-849	1M09W7D	18.42	—
		3	824-849	2M69W7D	17.94	—
		5	824-849	4M47W7D	18.50	—
		10	824-849	8M94W7D	18.27	—



1.4 EUT TEST CONFIGURATION

1.4.1 Test Configuration Description

Test Configuration	Description
A	Conducted antenna port measurement. EUT Tx at a max power and powered by the internal battery and/or USB via AC Adapter.
B	Radiated test setup/case spurious emissions. Antenna port terminated by the call box.

1.4.2 EUT Exercise Software

EUT is controlled by a CMW 500 Wideband Radio Communication Tester. There are no other test software used during verification.

1.4.3 Support Equipment and I/O cables

Manufacturer	Equipment/Cable	Description
Novatel Wireless	USB Cable	Micro USB Type B to Standard USB Type B
Novatel Wireless	External AC-DC Power Adapter	Model: SSW-2783, PN: 40123126.01 Input: 100-240VAC, Output: 5VDC

1.4.4 Worst Case Configuration

Worst-case configuration used in this test report:

Technology	Band	Test Configuration
CDMA – 1xRTT	Cell (BC0)	Mobile Station Control: SO: 55; RC: 3/3
CDMA – 1xRTT	PCS (BC1)	
GSM850 / GSM1900 (GPRS)	Cell	PCL:0 ; PS Service: Test Mode A; CS-1 for GPRS and MCS-5 for EGPRS
	PCS	
WCDMA/HSPA	Cell (Band 5)	Connection Setup: Test Mode Type: RMC Test Mode: Loop Mode 2
	PCS (Band 2)	

Band	Modulation
LTE Band 5	QPSK
LTE Band 2	QPSK

For radiated measurements X, Y, and Z orientations were verified. The verification was determined "Y" as worst case configuration.

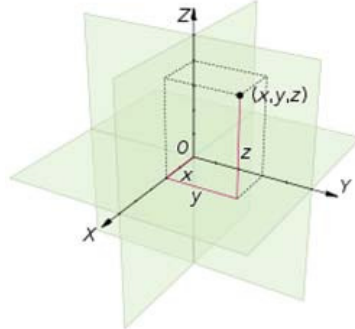

1.4.5 Simplified Test Configuration Diagram

Radiated Test Configuration

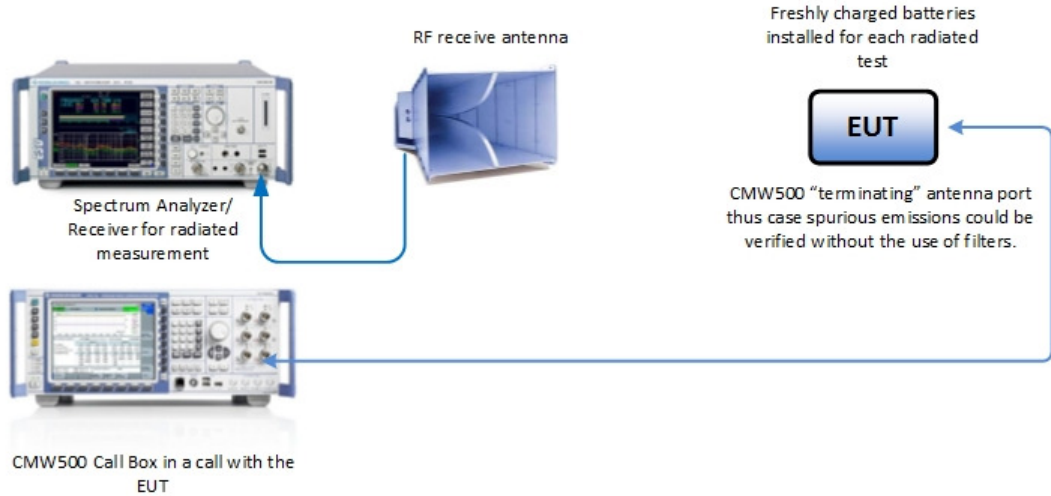

Conducted (Antenna Port) Test Configuration

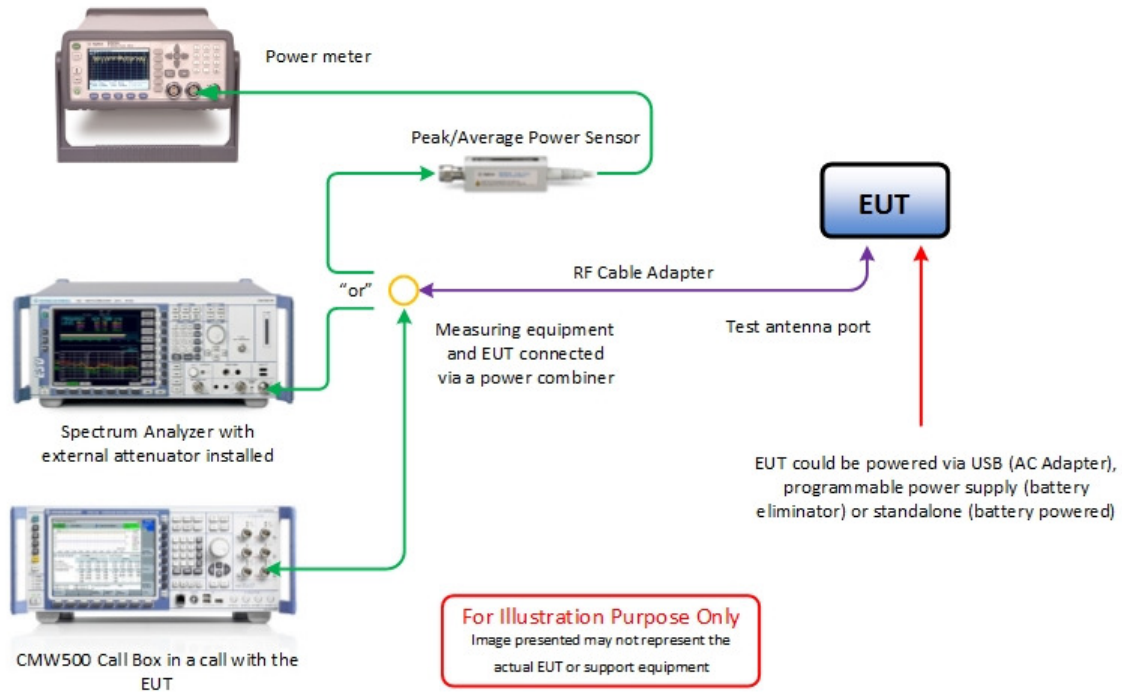



1.5 DEVIATIONS FROM THE STANDARD

No deviations from the applicable test standards or test plan were made during testing.

1.6 MODIFICATION RECORD

Description of Modification	Modification Fitted By	Date Modification Fitted
Serial Number: SZ17061900005 and SZ17061900013		
None	—	—

The table above details modifications made to the EUT during the test programme. The modifications incorporated during each test (if relevant) are recorded on the appropriate test pages.

1.7 TEST METHODOLOGY

All measurements contained in this report were conducted with ANSI C63.26-2015, American National Standard for Compliance Testing of Transmitters Used in Licensed Radio Services.

For conducted and radiated emissions the equipment under test (EUT) was configured to measure its highest possible emission level. The test modes were adapted according to the Operating Instructions provided by the manufacturer/client.

1.8 TEST FACILITY LOCATION

1.8.1 TÜV SÜD America Inc. (Mira Mesa)

10040 Mesa Rim Road, San Diego, CA 92121-2912 (32.901268,-117.177681). Phone: 858 678 1400 FAX: 858 546 0364

1.8.2 TÜV SÜD America Inc. (Rancho Bernardo)

16936 Via Del Campo, San Diego, CA 92127-1708 (33.018644,-117.092409). Phone: 858 678 1466 FAX: 858 546 0364



1.9 TEST FACILITY REGISTRATION

1.9.1 FCC – Registration No.: US1146

TUV SUD America Inc. (San Diego), is an accredited test facility with the site description report on file and has met all the requirements specified in §2.948 of the FCC rules. The acceptance letter from the FCC is maintained in our files and the Registration is US1146.

1.9.2 Innovation, Science and Economic Development Canada (ISED) Registration No.: 3067A

The 10m Semi-anechoic chamber of TUV SUD America Inc. (San Diego) has been registered by Certification and Engineering Bureau of Innovation, Science and Economic Development Canada (ISED) for radio equipment testing with Registration No. 3067A.



1.10 SAMPLE CALCULATIONS

1.10.1 GSM Emission Designator

Emission Designator = 250KGXW
 GSM BW = 250 kHz
 G = Phase Modulation
 X = Cases not otherwise covered
 W = Combination (Audio/Data)

1.10.2 WCDMA Emission Designator

Emission Designator = 4M15F9W
 WCDMA BW = 4.15 MHz
 F = Frequency Modulation
 9= Composite Digital Info
 W = Combination (Audio/Data)

1.10.3 CDMA Emission Designator

Emission Designator = 1M30F9W
 F = Frequency Modulation
 9= Composite Digital Info
 W = Combination (Audio/Data)

1.10.4 LTE Emission Designator (QPSK)

Emission Designator = 4M51G7D
 G = Phase Modulation
 7= Quantized/Digital Info
 D = Combination (Audio/Data)

1.10.5 LTE Emission Designator (16QAM)

Emission Designator = 4M52W7D
 W = Frequency Modulation
 7= Quantized/Digital Info
 D = Combination (Audio/Data)

1.10.6 Spurious Radiated Emission (below 1GHz)

Measuring equipment raw measurement (dBµV/m) @ 30 MHz		24.4
Correction Factor (dB)	Asset# 1066 (cable)	0.3
	Asset# 1172 (cable)	0.3
	Asset# 1016 (preamplifier)	-30.7
	Asset# 1175(cable)	0.3
	Asset# 1002 (antenna)	17.2
Reported QuasiPeak Final Measurement (dBµV/m) @ 30MHz		11.8

1.10.7 Spurious Radiated Emission – Substitution Method

Example = 84dBµV/m @ 1413 MHz (numerical sample only)



The field strength reading of $84\text{dB}\mu\text{V}/\text{m}$ @ 1413 MHz (2nd Harmonic of 706.5 MHz) is the maximized measurement when the EUT is on the turntable measured at 3 meters. The gain of the substituted antenna is 7.8dBi while the transmit cable loss is 1.0 dB (cable between signal generator and the substituted antenna). The signal generator level is adjusted until the $84\text{dB}\mu\text{V}/\text{m}$ level at the receiving end is replicated (identical test setup, i.e. same antenna, cable/s and preamp). If the adjusted signal generator level is -18dBm, then we have the following for both EIRP and ERP as required:

$$\begin{aligned} P_{\text{EIRP}} &= -18 \text{ dBm} + 7.8 \text{ dBi} - 1 \text{ dB} \\ &= 11.2 \text{ dBm} \\ P_{\text{ERP}} &= P_{\text{EIRP}} - 2.15 \text{ dB} \\ &= 11.2 \text{ dBm} - 2.15 \text{ dB} \\ &= 9.05 \text{ dBm} \end{aligned}$$



SECTION 2

TEST DETAILS

Radio Testing of the
Novatel Wireless Inc.
MIFI7730L Wireless Hotspot Modem



2.1 TRANSMITTER CONDUCTED POWER MEASUREMENTS

2.1.1 Specification Reference

FCC 47 CFR Part 2, Clause 2.1046
RSS-132, Clause 5.4
RSS-133, Clause 6.4

2.1.2 Standard Applicable

The conducted power measurements were made in accordance to FCC Part 2 Clause 2.1046 and RSS-132 Clause 5.4 and RSS-133 Clause 6.4.

2.1.3 Equipment Under Test and Modification State

Serial No: SZ17061900005 / Test Configuration A

2.1.4 Date of Test/Initial of test personnel who performed the test

July 05 and 06, 2016 / FC and XYZ

2.1.5 Test Equipment Used

The major items of test equipment used for the above tests are identified in Section 3.1.

2.1.6 Environmental Conditions

Test performed at TÜV SÜD America Inc. Rancho Bernardo facility

Ambient Temperature	27.1 °C
Relative Humidity	42.4 %
ATM Pressure	99.2 kPa

2.1.7 Additional Observations

For CELL and PCS Bands:

- This is a conducted test using an USB wideband power sensor.
- The path loss for Cell Band (CDMA/EvDO/GSM850/WCDMA) and PCS Band (CDMA/EvDO/GSM1900/WCDMA) were measured and entered as a level offset.
- Only worst case of SO/RC, RTAP and RETAP offset presented and recorded in this test report.

For LTE Bands:

- This is a conducted test using a high speed average power sensor.
- The path loss for LTE Band 5 and LTE Band 2 was measured and entered as a level offset.
- Only worst case of RB size and RB offset presented and recorded in this test report.



2.1.8 Test Results

CDMA 1xRTT				
Band	Channel	Frequency (MHz)	Max Power Average (dBm)	Mobile Station Control (SO) / (RC)
Cell (BC0)	1013	824.70	23.910	55 / (3/3)
	384	836.52	23.740	55 / (3/3)
	777	848.31	23.374	55 / (3/3)
PCS (BC1)	25	1851.25	22.026	55 / (3/3)
	600	1880.00	22.023	55 / (3/3)
	1175	1908.75	21.136	55 / (3/3)

CDMA – 1xEvDO Release 0				
Band	Channel	Frequency (MHz)	Max Power Average (dBm)	Access Terminal Control
Cell (BC0)	1013	824.70	23.749	Forward
	384	836.52	23.656	Forward
	777	848.31	23.305	Forward
PCS (BC1)	25	1851.25	22.657	Forward
	600	1880.00	22.878	Forward
	1175	1908.75	22.315	Forward

CDMA – 1xEvDO Release A				
Band	Channel	Frequency (MHz)	Max Power Average (dBm)	Access Terminal Control
Cell (BC0)	1013	824.70	23.900	Forward
	384	836.52	23.797	Forward
	777	848.31	23.052	Forward
PCS (BC1)	25	1851.25	22.802	Forward
	600	1880.00	23.083	Forward
	1175	1908.75	22.446	Forward

GPRS			
Band	Channel	Frequency (MHz)	Max Power Average (dBm)
GPRS850	128	824.2	31.600
	190	836.6	31.500
	251	848.8	31.600
GPRS1900	512	1850.2	27.800
	661	1880.0	28.000
	810	1909.8	28.200



EGPRS			
Band	Channel	Frequency (MHz)	Max Power Average (dBm)
EGPRS850	128	824.2	26.563
	190	836.6	26.993
	251	848.8	26.840
EGPRS1900	512	1850.2	26.100
	661	1880.0	26.100
	810	1909.8	26.400

WCDMA			
Band	Channel	Frequency (MHz)	Max Power Average (dBm)
Band 5	4132	826.4	23.512
	4183	836.6	23.510
	4233	846.6	23.311
Band 2	9262	1852.4	22.117
	9400	1880.0	22.323
	9538	1907.6	21.700



LTE Band 5						
Modulation	Bandwidth	RB Size	RB Offset	Channels	Frequency	Tx Average (dBm)
QPSK	1.4 MHz	1	0	20407	824.7	22.96
		1	0	20525	836.5	22.95
		1	0	20643	848.3	23.00
	3 MHz	1	0	20415	825.5	22.49
		1	0	20525	836.5	22.43
		1	0	20635	847.5	22.51
	5 MHz	1	0	20425	826.5	22.54
		1	0	20525	836.5	22.34
		1	0	20625	846.5	22.93
	10 MHz	1	0	20450	829.0	22.77
		1	0	20525	836.5	22.74
		1	0	20600	844.0	22.78

LTE Band 5						
Modulation	Bandwidth	RB Size	RB Offset	Channels	Frequency	Tx Average (dBm)
16QAM	1.4 MHz	1	0	20407	824.7	22.07
		1	0	20525	836.5	22.00
		1	0	20643	848.3	22.03
	3 MHz	1	0	20415	825.5	21.59
		1	0	20525	836.5	21.52
		1	0	20635	847.5	21.51
	5 MHz	1	0	20425	826.5	21.77
		1	0	20525	836.5	21.45
		1	0	20625	846.5	22.15
	10 MHz	1	0	20450	829.0	21.88
		1	0	20525	836.5	21.92
		1	0	20600	844.0	21.85



LTE Band 2						
Modulation	Bandwidth	RB Size	RB Offset	Channels	Frequency	Tx Average (dBm)
QPSK	1.4 MHz	1	0	18607	1850.7	23.31
		1	0	18900	1880.0	23.04
		1	0	19193	1909.3	23.11
	3 MHz	1	0	18615	1851.5	23.36
		1	0	18900	1880.0	23.71
		1	0	19185	1908.5	22.27
	5 MHz	1	0	18625	1852.5	23.33
		1	0	18900	1880.0	23.24
		1	0	19175	1907.5	23.12
	10 MHz	1	0	18650	1855.0	23.24
		1	0	18900	1880.0	23.43
		1	0	19150	1905.0	23.53
	15 MHz	1	0	18675	1857.5	23.54
		1	0	18900	1880.0	23.90
		1	0	19125	1902.5	23.85
	20 MHz	1	0	18700	1860.0	23.52
		1	0	18900	1880.0	24.01
		1	0	19100	1900.0	23.67

LTE Band 2						
Modulation	Bandwidth	RB Size	RB Offset	Channels	Frequency	Tx Average (dBm)
16QAM	1.4 MHz	1	0	18607	1850.7	22.46
		1	0	18900	1880.0	22.16
		1	0	19193	1909.3	22.23
	3 MHz	1	0	18615	1851.5	22.46
		1	0	18900	1880.0	22.87
		1	0	19185	1908.5	21.43
	5 MHz	1	0	18625	1852.5	22.64
		1	0	18900	1880.0	22.24
		1	0	19175	1907.5	22.40
	10 MHz	1	0	18650	1855.0	22.27
		1	0	18900	1880.0	22.72
		1	0	19150	1905.0	22.70
	15 MHz	1	0	18675	1857.5	22.75
		1	0	18900	1880.0	23.04
		1	0	19125	1902.5	22.10
	20 MHz	1	0	18700	1860.0	22.65
		1	0	18900	1880.0	23.23
		1	0	19100	1900.0	22.78



2.1.9 Sample Test Measurement Screen

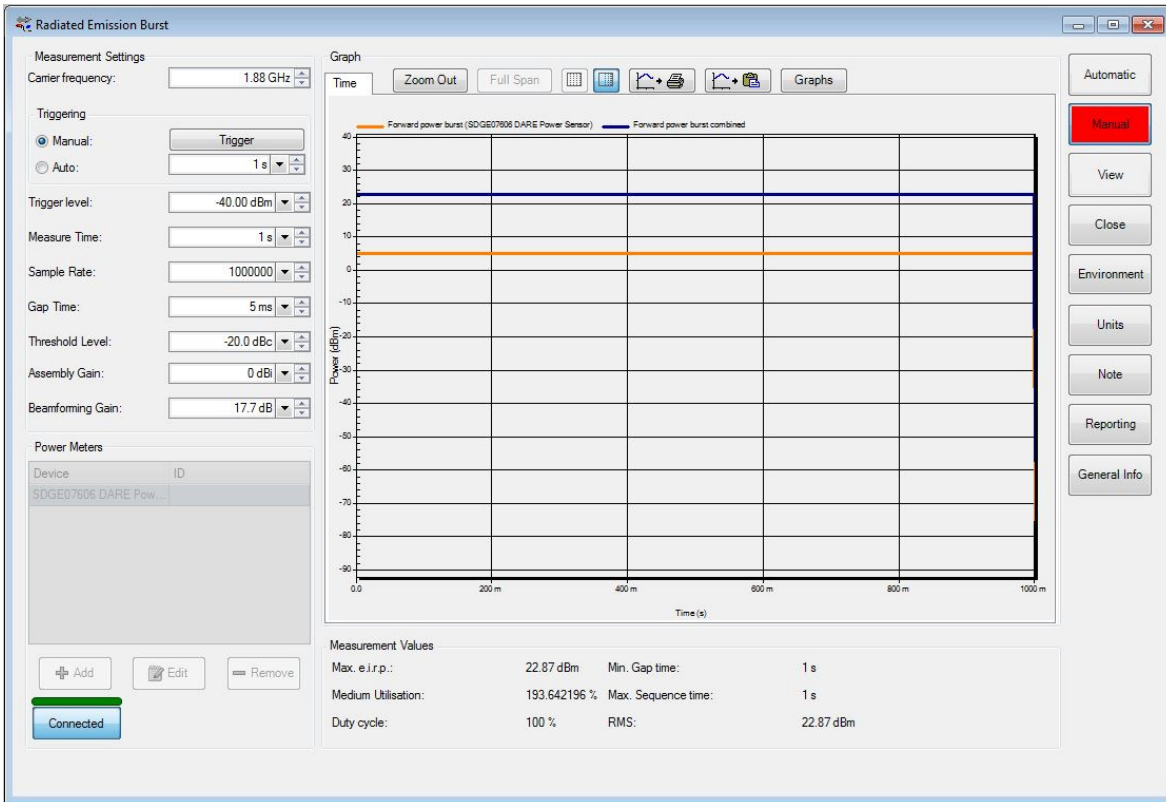
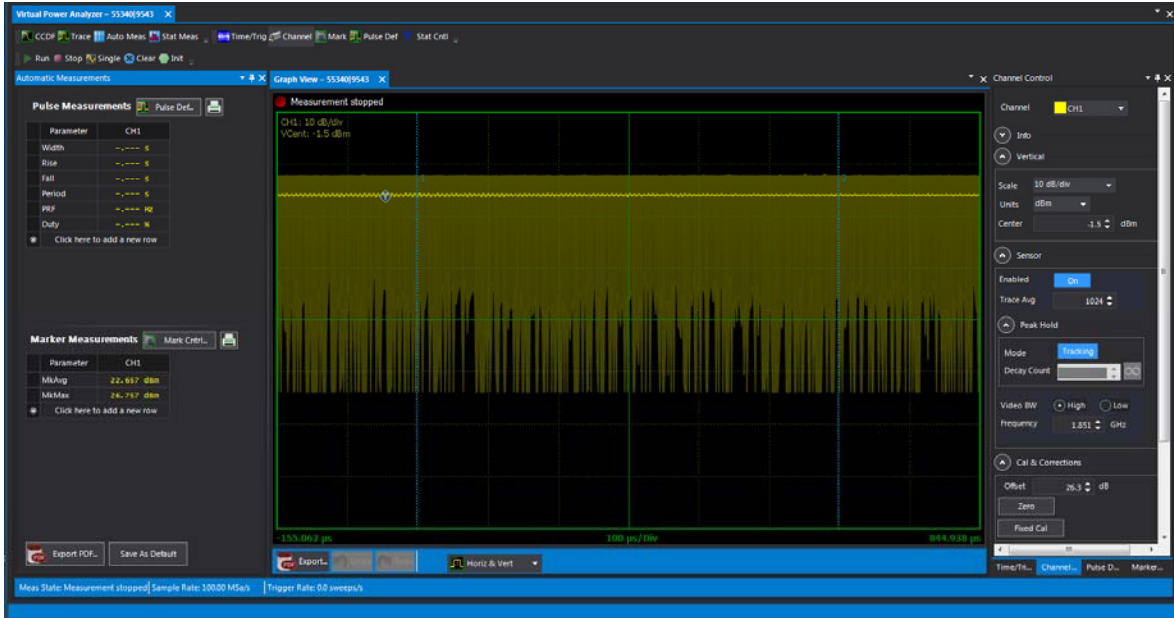



2.2 EFFECTIVE RADIATED POWER

2.2.1 Specification Reference

FCC 47 CFR Part 2, Clause 2.1046
FCC 47 CFR Part 22, Clause 22.913(a)(2)

2.2.2 Standard Applicable

FCC Part 22:
The ERP of mobile transmitters and auxiliary test transmitters must not exceed 7 Watts.

2.2.3 Equipment Under Test and Modification State

Serial No: SZ17061900005 / Test Configuration (N/A, calculation only)

2.2.4 Date of Test/Initial of test personnel who performed the test

August 01, 2016 / AC

2.2.5 Test Equipment Used

The major items of test equipment used for the above tests are identified in Section 3.1.

2.2.6 Additional Observations

- ERP was calculated as per Section 1.2 and 1.3 of KDB412172 D01 (Determining ERP and EIRP v01r01).
- Calculation formula in logarithmic terms:

$$\text{ERP} = P_T + G_T - L_C - 2.15\text{dB}$$

Where:

P_T = transmitter conducted output power dBm (Section 2.1 of this test report)
 G_T = gain of the transmitting antenna, in dBi (EIRP: the -2.15 in the formula is to convert EIRP to ERP);
 L_C = signal attenuation in the connecting cable between the transmitter and antenna, in dB (EUT configuration during verification is mounted on an interface board with short direct connection to the antenna port. The loss between the EUT and the antenna port is considered negligible).



2.2.7 Test Results

CDMA 1xRTT (BC0)						
Frequency (MHz)	Max Power Average (dBm)	Antenna Gain (dBi)	ERP			
			(dBm)	(W)	ERP Limit (dBm)	Margin (dB)
824.70	23.910	-1.5	20.26	0.11	38.45	18.19
836.52	23.740	-1.5	21.59	0.14	38.45	16.86
848.31	23.374	-1.5	21.22	0.13	38.45	17.23

CDMA – 1xEvDO Release 0 (BC0)						
Frequency (MHz)	Max Power Average (dBm)	Antenna Gain (dBi)	ERP			
			(dBm)	(W)	ERP Limit (dBm)	Margin (dB)
824.70	23.749	-1.5	20.10	0.10	38.45	18.35
836.52	23.656	-1.5	21.51	0.14	38.45	16.94
848.31	23.305	-1.5	21.16	0.13	38.45	17.29

CDMA – 1xEvDO Release A (BC0)						
Frequency (MHz)	Max Power Average (dBm)	Antenna Gain (dBi)	ERP			
			(dBm)	(W)	ERP Limit (dBm)	Margin (dB)
824.70	23.90	-1.5	20.25	0.11	38.45	18.20
836.52	23.797	-1.5	21.65	0.15	38.45	16.80
848.31	23.052	-1.5	20.90	0.12	38.45	17.55

GPRS850-BC0						
Frequency (MHz)	Max Power Average (dBm)	Antenna Gain (dBi)	ERP			
			(dBm)	(W)	ERP Limit (dBm)	Margin (dB)
824.2	31.6	-1.5	27.95	0.62	38.45	10.50
836.6	31.5	-1.5	29.35	0.86	38.45	9.10
848.8	31.6	-1.5	29.45	0.88	38.45	9.00

EGPRS850-BC0						
Frequency (MHz)	Max Power Average (dBm)	Antenna Gain (dBi)	ERP			
			(dBm)	(W)	ERP Limit (dBm)	Margin (dB)
824.2	26.563	-1.5	22.91	0.20	38.45	15.54
836.6	26.993	-1.5	24.84	0.30	38.45	13.61
848.8	26.840	-1.5	24.69	0.29	38.45	13.76



WCDMA Band 5						
Frequency (MHz)	Max Power Average (dBm)	Antenna Gain (dBi)	ERP			
			(dBm)	(W)	ERP Limit (dBm)	Margin (dB)
826.4	23.512	-1.5	19.86	0.10	38.45	18.59
836.6	23.510	-1.5	21.36	0.14	38.45	17.09
846.6	23.311	-1.5	21.16	0.13	38.45	17.29

LTE Band 5									
Modulation	Bandwidth (MHz)	RB Size/Offset	Channels	Frequency (MHz)	Tx Average Power (dBm)	Antenna Gain (dBi)	ERP (dBm)	Limit (dBm)	Margin (dBm)
QPSK	1.4	1 / 0	20407	824.7	22.96	-1.5	19.31	38.45	19.14
		1 / 0	20525	836.5	22.95	-1.5	19.3	38.45	19.15
		1 / 0	20643	848.3	23.00	-1.5	19.35	38.45	19.10
	3	1 / 0	20415	825.5	22.49	-1.5	18.84	38.45	19.61
		1 / 0	20525	836.5	22.43	-1.5	18.78	38.45	19.67
		1 / 0	20635	847.5	22.51	-1.5	18.86	38.45	19.59
	5	1 / 0	20425	826.5	22.54	-1.5	18.89	38.45	19.56
		1 / 0	20525	836.5	22.34	-1.5	18.69	38.45	19.76
		1 / 0	20625	846.5	22.93	-1.5	19.28	38.45	19.17
	10	1 / 0	20450	829	22.77	-1.5	19.12	38.45	19.33
		1 / 0	20525	836.5	22.74	-1.5	19.09	38.45	19.36
		1 / 0	20600	844	22.78	-1.5	19.13	38.45	19.32

LTE Band 5									
Modulation	Bandwidth (MHz)	RB Size/Offset	Channels	Frequency (MHz)	Tx Average Power (dBm)	Antenna Gain (dBi)	ERP (dBm)	Limit (dBm)	Margin (dBm)
16QAM	1.4	1 / 0	20407	824.7	22.07	-1.5	18.42	38.45	20.03
		1 / 0	20525	836.5	22.00	-1.5	18.35	38.45	20.10
		1 / 0	20643	848.3	22.03	-1.5	18.38	38.45	20.07
	3	1 / 0	20415	825.5	21.59	-1.5	17.94	38.45	20.51
		1 / 0	20525	836.5	21.52	-1.5	17.87	38.45	20.58
		1 / 0	20635	847.5	21.51	-1.5	17.86	38.45	20.59
	5	1 / 0	20425	826.5	21.77	-1.5	18.12	38.45	20.33
		1 / 0	20525	836.5	21.45	-1.5	17.8	38.45	20.65
		1 / 0	20625	846.5	22.15	-1.5	18.5	38.45	19.95
	10	1 / 0	20450	829	21.88	-1.5	18.23	38.45	20.22
		1 / 0	20525	836.5	21.92	-1.5	18.27	38.45	20.18
		1 / 0	20600	844	21.85	-1.5	18.2	38.45	20.25



2.3 EQUIVALENT ISOTROPIC RADIATED POWER

2.3.1 Specification Reference

FCC 47 CFR Part 2, Clause 2.1046
RSS-132, Clause 5.4
FCC 47 CFR Part 24, Clause 24.232 (c)
RSS-133, Clause 6.4

2.3.2 Standard Applicable

IC RSS-132:
The EIRP for mobile equipment shall not exceed 11.5 watts

FCC Part 24:
Mobile and portable stations are limited to 2 watts EIRP and the equipment must employ a means for limiting power to the minimum necessary for successful communications.

IC RSS-133:
The equivalent isotropically radiated power (e.i.r.p.) for Mobile stations and hand-held portables are limited to 2 watts maximum e.i.r.p.

2.3.3 Equipment Under Test and Modification State

Serial No: SZ17061900005 / Test Configuration (N/A, calculation only)

2.3.4 Date of Test/Initial of test personnel who performed the test

August 01, 2016 / AC

2.3.5 Test Equipment Used

The major items of test equipment used for the above tests are identified in Section 3.1.

2.3.6 Additional Observations

- ERP was calculated as per Section 1.2 and 1.3 of KDB412172 D01 (Determining ERP and EIRP v01r01).
- Calculation formula in logarithmic terms:

$$\text{EIRP} = P_T + G_T - L_C$$

Where:

P_T = transmitter conducted output power dBm (Section 2.1 of this test report)

G_T = gain of the transmitting antenna, in dBi (EIRP);

L_C = signal attenuation in the connecting cable between the transmitter and antenna, in dB (EUT poses an internal Antenna. The loss between the EUT and the antenna port is considered negligible).



2.3.7 Test Results

CDMA 1xRTT (BC1)						
Frequency (MHz)	Max Power Average (dBm)	Antenna Gain (dBi)	EIRP			
			(dBm)	(W)	Limit (dBm)	Margin (dB)
1851.25	22.026	1.6	23.626	0.23	33	9.37
1880.00	22.023	1.6	23.623	0.23	33	9.38
1908.75	21.136	1.6	22.736	0.19	33	10.26

CDMA – 1xEvDO Release 0 (BC1)						
Frequency (MHz)	Max Power Average (dBm)	Antenna Gain (dBi)	EIRP			
			(dBm)	(W)	Limit (dBm)	Margin (dB)
1851.25	22.657	1.6	24.257	0.27	33	8.74
1880.00	22.878	1.6	24.478	0.28	33	8.52
1908.75	22.315	1.6	23.915	0.25	33	9.09

CDMA – 1xEvDO Release A (BC1)						
Frequency (MHz)	Max Power Average (dBm)	Antenna Gain (dBi)	EIRP			
			(dBm)	(W)	Limit (dBm)	Margin (dB)
1851.25	22.802	1.6	24.402	0.28	33	8.60
1880.00	23.083	1.6	24.683	0.29	33	8.32
1908.75	22.446	1.6	24.046	0.25	33	8.95

GPRS1900-BC1						
Frequency (MHz)	Max Power Average (dBm)	Antenna Gain (dBi)	EIRP			
			(dBm)	(W)	Limit (dBm)	Margin (dB)
1850.2	27.8	1.6	29.4	0.87	33	3.60
1880.0	28.0	1.6	29.6	0.91	33	3.40
1909.8	28.2	1.6	29.8	0.95	33	3.20

EGPRS1900-BC1						
Frequency (MHz)	Max Power Average (dBm)	Antenna Gain (dBi)	EIRP			
			(dBm)	(W)	Limit (dBm)	Margin (dB)
1850.2	26.1	1.6	27.7	0.59	33	5.30
1880.0	26.1	1.6	27.7	0.59	33	5.30
1909.8	26.4	1.6	28	0.63	33	5.00



WCDMA Band 2						
Frequency (MHz)	Max Power Average (dBm)	Antenna Gain (dBi)	EIRP			
			(dBm)	(W)	Limit (dBm)	Margin (dB)
1852.4	22.117	1.4	23.517	0.22	33	9.48
1880.0	22.323	1.4	23.723	0.24	33	9.28
1907.6	21.7	1.4	23.1	0.20	33	9.90

LTE Band 2									
Modulation	Bandwidth (MHz)	RB Size/Offset	Channels	Frequency (MHz)	Tx Average Power (dBm)	Antenna Gain (dBi)	EIRP (dBm)	Limit (dBm)	Margin (dBm)
QPSK	1.4	1 / 0	18607	1850.7	23.31	1.6	24.91	33	8.09
		1 / 0	18900	1880.0	23.04	1.6	24.64	33	8.36
		1 / 0	19193	1909.3	23.11	1.6	24.71	33	8.29
	3	1 / 0	18615	1851.5	23.36	1.6	24.96	33	8.04
		1 / 0	18900	1880.0	23.71	1.6	25.31	33	7.69
		1 / 0	19185	1908.5	22.27	1.6	23.87	33	9.13
	5	1 / 0	18625	1852.5	23.33	1.6	24.93	33	8.07
		1 / 0	18900	1880.0	23.24	1.6	24.84	33	8.16
		1 / 0	19175	1907.5	23.12	1.6	24.72	33	8.28
	10	1 / 0	18650	1855.0	23.24	1.6	24.84	33	8.16
		1 / 0	18900	1880.0	23.43	1.6	25.03	33	7.97
		1 / 0	19150	1905.0	23.53	1.6	25.13	33	7.87
	15	1 / 0	18675	1857.5	23.54	1.6	25.14	33	7.86
		1 / 0	18900	1880.0	23.90	1.6	25.5	33	7.50
		1 / 0	19125	1902.5	23.85	1.6	25.45	33	7.55
	20	1 / 0	18700	1860.0	23.52	1.6	25.12	33	7.88
		1 / 0	18900	1880.0	24.01	1.6	25.61	33	7.39
		1 / 0	19100	1900.0	23.67	1.6	25.27	33	7.73



LTE Band 2									
Modulation	Bandwidth (MHz)	RB Size/Offset	Channels	Frequency (MHz)	Tx Average Power (dBm)	Antenna Gain (dBi)	EIRP (dBm)	Limit (dBm)	Margin (dBm)
16QAM	1.4	1 / 0	18607	1850.7	22.46	1.6	24.06	33	8.94
		1 / 0	18900	1880.0	22.16	1.6	23.76	33	9.24
		1 / 0	19193	1909.3	22.23	1.6	23.83	33	9.17
	3	1 / 0	18615	1851.5	22.46	1.6	24.06	33	8.94
		1 / 0	18900	1880.0	22.87	1.6	24.47	33	8.53
		1 / 0	19185	1908.5	21.43	1.6	23.03	33	9.97
	5	1 / 0	18625	1852.5	22.64	1.6	24.24	33	8.76
		1 / 0	18900	1880.0	22.24	1.6	23.84	33	9.16
		1 / 0	19175	1907.5	22.40	1.6	24	33	9.00
	10	1 / 0	18650	1855.0	22.27	1.6	23.87	33	9.13
		1 / 0	18900	1880.0	22.72	1.6	24.32	33	8.68
		1 / 0	19150	1905.0	22.70	1.6	24.3	33	8.70
	15	1 / 0	18675	1857.5	22.75	1.6	24.35	33	8.65
		1 / 0	18900	1880.0	23.04	1.6	24.64	33	8.36
		1 / 0	19125	1902.5	22.10	1.6	23.7	33	9.30
	20	1 / 0	18700	1860.0	22.65	1.6	24.25	33	8.75
		1 / 0	18900	1880.0	23.23	1.6	24.83	33	8.17
		1 / 0	19100	1900.0	22.78	1.6	24.38	33	8.62



2.4 PEAK-AVERAGE RATIO

2.4.1 Specification Reference

FCC 47 CFR Part 24, Clause 24.2329 (d)
RSS-133, Clause 6.4
RSS-132, Clause 5.4

2.4.2 Standard Applicable

FCC Part 24:

Power measurements for transmissions by stations authorized under this section may be made either in accordance with a Commission-approved average power technique or in compliance with paragraph (e) of this section. In both instances, equipment employed must be authorized in accordance with the provisions of §24.51. In measuring transmissions in this band using an average power technique, the peak-to-average ratio (PAR) of the transmission may not exceed 13dB

IC RSS-132 and RSS-133:

The transmitter's peak-to-average power ratio (PAPR) shall not exceed 13 dB for more than 0.1% of the time using a signal corresponding to the highest PAPR during periods of continuous transmission.

2.4.3 Equipment Under Test and Modification State

Serial No: SZ17061900005 / Test Configuration A

2.4.4 Date of Test/Initial of test personnel who performed the test

July 06 to 08, 2016 / XYZ
July 08 and 14, 2016 / FC and AC

2.4.5 Test Equipment Used

The major items of test equipment used for the above tests are identified in Section 3.1.

2.4.6 Environmental Conditions/ Test Location

Test performed at TÜV SÜD America Inc. Rancho Bernardo facility

Ambient Temperature	24.3 - 25.4°C
Relative Humidity	37.8 - 42.4
ATM Pressure	99.2 - 99.7 kPa



2.4.7 Additional Observations

- This is a conducted test. Test procedure is per FCC KDB 971168 D01 v02r02 clause 5.7.
- Measurement was done using the Spectrum Analyzer's Complementary Cumulative Distribution Function (CCDF) measurement profile. The built-in function is used to determine the largest deviation between the average and the peak power of the EUT in a given bandwidth (crest factor or peak-to-average ratio) The CCDF curve shows how much time the peak waveform spends at or above a given average power level. The percent of time the signals spends at or above the level defines the probability for that particular power level. For GSM signals, an average and a peak trace are used to determine the largest deviation between the average and the peak power of the EUT in a bandwidth greater than the emission bandwidth.
- Only the worst channel and configuration presented.
- The path loss for was measured and entered as a level offset.
- There are no measured PAPR levels greater than 13dB. EUT complies.

2.4.8 Test Results

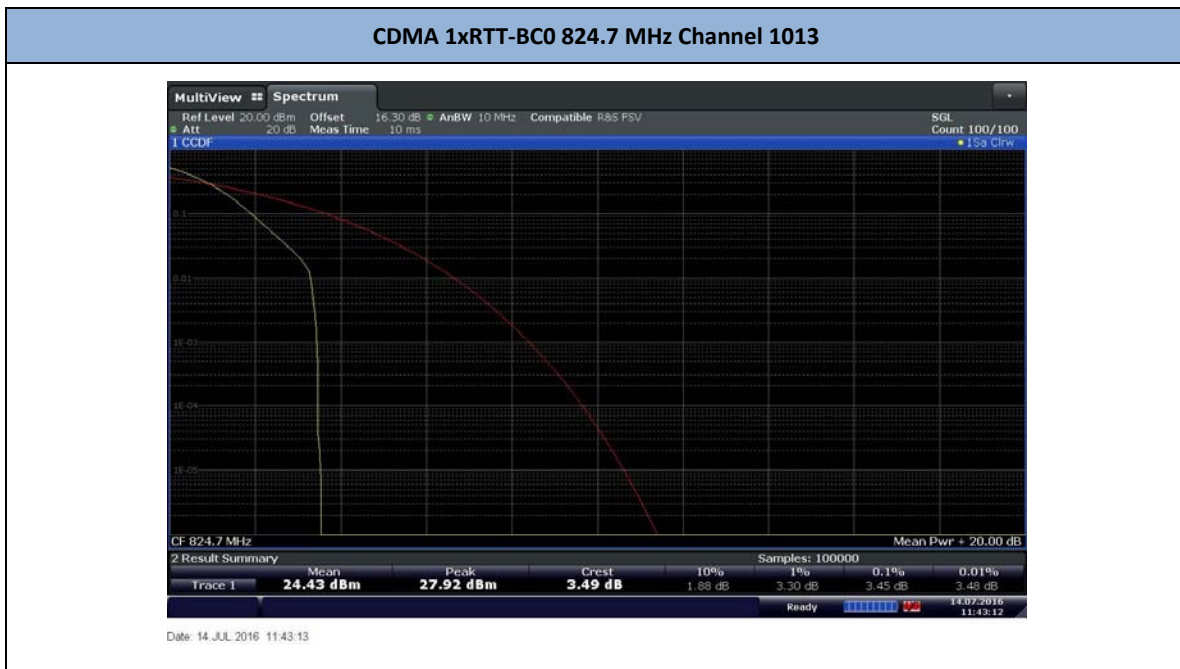



CDMA 1xRTT-BC1 1851.25 MHz Channel 25



Date: 14 JUL 2016 11:46:56

CDMA - 1xEvDO Rel 0-BC0 824.7 MHz Channel 1013



Date: 14 JUL 2016 11:55:44



CDMA – 1xEvDO Rel 0-BC1 1880.0 MHz Channel 600



Date: 14 JUL 2016 11:58:21

CDMA – 1xEvDO Rel A-BC0 824.7MHz Channel 1013



Date: 14 JUL 2016 12:04:28



CDMA – 1xEvDO Release A-BC1 1880.00 MHz Channel 600



Date: 14 JUL 2016 12:06:17

GPRS850-BC0 824.2MHz Channel 128

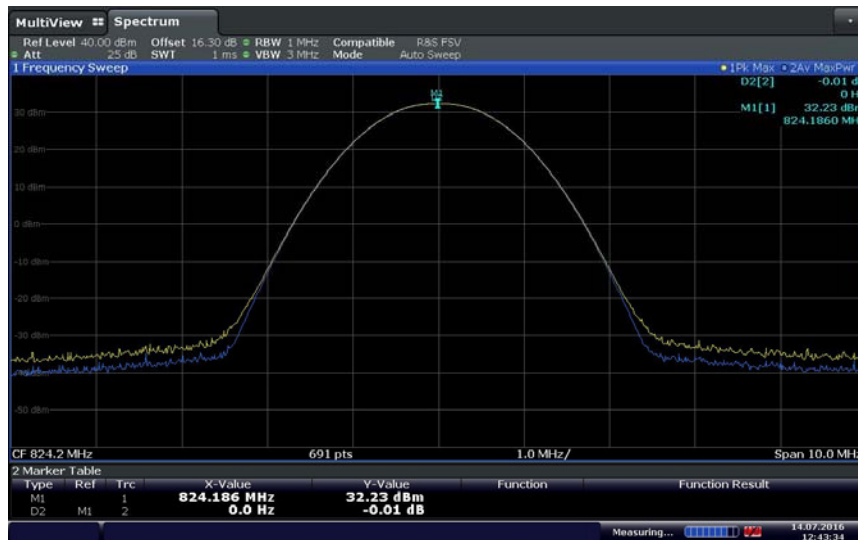

Date: 14 JUL 2016 12:43:35



GPRS1900-BC1 1880.0 MHz Channel 661

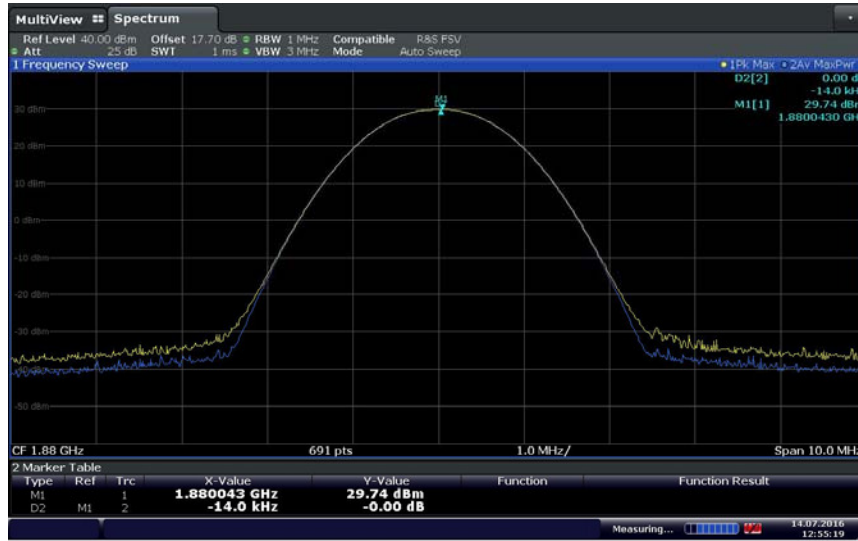

Date: 14 JUL 2016 12:55:19

EGPRS850-BC0 836.6 MHz Channel 190

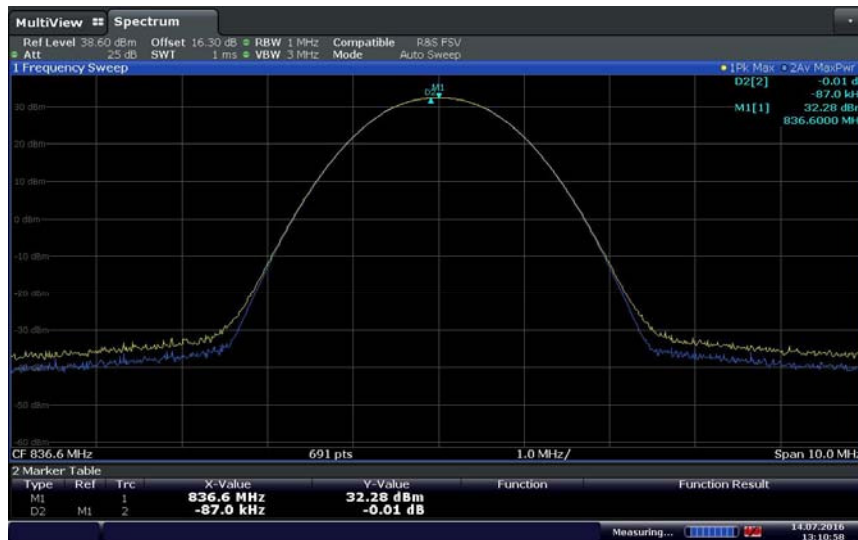

Date: 14 JUL 2016 13:10:58



EGPRS1900-BC1 1909.8 MHz Channel 810

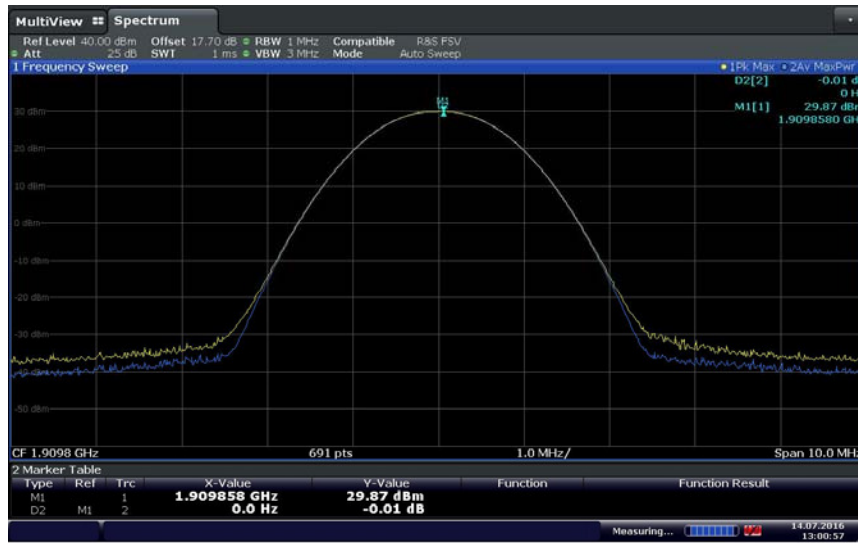

Date: 14 JUL 2016 13:00:57

WCDMA – Band 5 826.4 MHz Channel 4132



Date: 14 JUL 2016 13:21:10



WCDMA – Band 2 1880.0 MHz Channel 9400



Date: 14 JUL 2016 13:24:57



LTE Band 5 (1.4 MHz BW)/836.5 MHz/QPSK



Date: 8 JUL 2016 14:08:16

LTE Band 5 (1.4 MHz BW)/836.5 MHz/16QAM



Date: 8 JUL 2016 14:08:57



LTE Band 5 (3 MHz BW)/836.5 MHz/QPSK



Date: 8 JUL 2016 11:16:19

LTE Band 5 (3 MHz BW)/836.5MHz/16QAM



Date: 8 JUL 2016 11:17:01



LTE Band 5 (5 MHz BW)/836.5 MHz/QPSK



Date: 8 JUL 2016 11:12:42

LTE Band 5 (5 MHz BW)/836.5 MHz/16QAM



Date: 8 JUL 2016 11:11:58



LTE Band 5 (10 MHz BW)/836.5MHz/QPSK



LTE Band 5 (10 MHz BW)/836.5 MHz/16QAM





LTE Band 2 (1.4 MHz BW)/1880 MHz/QPSK



LTE Band Band 2 (1.4 MHz BW)/1880 MHz/16QAM





LTE Band Band 2 (3 MHz BW)/1880 MHz/QPSK



Date: 6 JUL 2016 16:57:24

LTE Band Band 2 (3 MHz BW)/1880 MHz/16QAM



Date: 6 JUL 2016 16:57:02



LTE Band 2 (5 MHz BW)/1880 MHz/QPSK



LTE Band 2 (5 MHz BW)/1880 MHz/16QAM





LTE Band 2 (10 MHz BW)/1880 MHz/QPSK



Date: 6 JUL 2016 16:28:59

LTE Band 2 (10 MHz BW)/1880 MHz/16QAM



Date: 6 JUL 2016 16:35:33



LTE Band 2 (15 MHz BW)/1880 MHz/QPSK



LTE Band 2 (15 MHz BW)/1880 MHz/16QAM





LTE Band 2 (20 MHz BW)/1880 MHz/QPSK



Date: 6 JUL 2016 16:23:17

LTE Band 2 (20 MHz BW)/1880 MHz/16QAM



Date: 6 JUL 2016 16:23:42



2.5 OCCUPIED BANDWIDTH

2.5.1 Specification Reference

FCC 47 CFR Part 2, Clause 2.1049
FCC 47 CFR Part 22, Clause 22.917(b)
FCC 47 CFR Part 24, Clause 24.238(b)
RSS-GEN 4.6.1

2.5.2 Standard Applicable

The transmitted signal bandwidth shall be reported as the 99% emission bandwidth, that is the frequency bandwidth such that, below its lower and above its upper frequency limits, the mean powers radiated are each equal to 0.5 percent of the total mean power radiated by a given emission.

26dB Bandwidth is defined as the width of the signal between two points, one below the carrier center frequency and one above the carrier center frequency, outside of which all emissions are attenuated by at least 26 dB below the transmitter power.

2.5.3 Equipment Under Test and Modification State

Serial No: SZ17061900005 / Test Configuration A

2.5.4 Date of Test/Initial of test personnel who performed the test

July 06 to 08, 2016 / XYZ
July 11 and 15, 2016 / FC and AC

2.5.5 Test Equipment Used

The major items of test equipment used for the above tests are identified in Section 3.1.

2.5.6 Environmental Conditions/ Test Location

Test performed at TÜV SÜD America Inc. Rancho Bernardo facility

Ambient Temperature	24.3 - 25.4°C
Relative Humidity	37.8 – 42.4
ATM Pressure	99.2 - 99.7 kPa

2.5.7 Additional Observations

- This is a conducted test. Both 26dB bandwidth and 99% bandwidth presented.
- Using the occupied bandwidth measurement function in the spectrum analyzer, the 99% occupied bandwidth was measured.
- The 26dB bandwidth was measured in accordance with FCC KDB 971168 D01 v02r02 clause 4.1 using the ndB measurement function in the spectrum analyzer.
- The transmitter shall be operated at its maximum carrier power measured under normal test conditions.



- The span of the analyzer shall be set to capture all products of the modulation process, including the emission skirts.
- The resolution bandwidth (RBW) shall be in the range of 1% of the occupied bandwidth (OBW) and video bandwidth (VBW) shall be at least 3x RBW.
- Low, Mid and High channels for all bandwidths and modulations were verified. Test results of Mid channel were presented as representative.

2.5.8 Test Results

CDMA 1xRTT					
Band	Service Option (SO) / (RC)	Channel	Frequency	99% OBW (MHz)	26dB BW (MHz)
BC0	55 / (3/3)	384	836.52	1.33	1.53
BC1	55 / (3/3)	600	1880.0	1.34	1.55

CDMA – 1xEvDO Release 0					
Band	Access Terminal Control	Channel	Frequency	99% OBW (MHz)	26dB BW (MHz)
BC0	Forward	384	836.52	1.30	1.47
BC1	Forward	600	1880.0	1.31	1.50

CDMA – 1xEvDO Release A					
Band	Access Terminal Control	Channel	Frequency	99% OBW (MHz)	26dB BW (MHz)
BC0	Forward	384	836.52	1.30	1.47
BC1	Forward	600	1880.0	1.30	1.51

GPRS				
Band	Channel	Frequency	99% OBW (kHz)	26dB BW (kHz)
GPRS850	190	836.6	254.7	335.7
GPRS1900	661	1880.0	246.0	322.7

EGPRS				
Band	Channel	Frequency	99% OBW (kHz)	26dB BW (kHz)
EGPRS850	190	836.6	254.7	341.5
EGPRS1900	661	1880.0	244.6	325.6



WCDMA				
Band	Channel	Frequency	99% OBW (MHz)	26dB BW (MHz)
Band 5	4183	836.6	4.17	4.73
Band 2	9400	1880.0	4.15	4.75

LTE (QPSK)					
Band	Bandwidth (MHz)	Channel	Frequency	99% OBW (kHz)	26dB BW (kHz)
5	1.4	20525	836.5	1.09	1.24
	3			2.69	2.98
	5			4.49	4.97
	10			8.94	9.72
2	1.4	18900	1880.0	1.09	1.23
	3			2.69	3.04
	5			4.47	4.93
	10			8.99	9.64
	15			13.48	14.72
	20			17.89	19.19

LTE (16QAM)					
Band	Bandwidth (MHz)	Channel	Frequency	99% OBW (kHz)	26dB BW (kHz)
5	1.4	20525	836.5	1.09	1.24
	3			2.69	2.98
	5			4.47	4.86
	10			8.94	9.68
2	1.4	18900	1880.0	1.08	1.22
	3			2.69	2.94
	5			4.47	4.91
	10			8.94	9.64
	15			13.48	14.65
	20			17.97	19.19



2.5.9 Example Test Plots

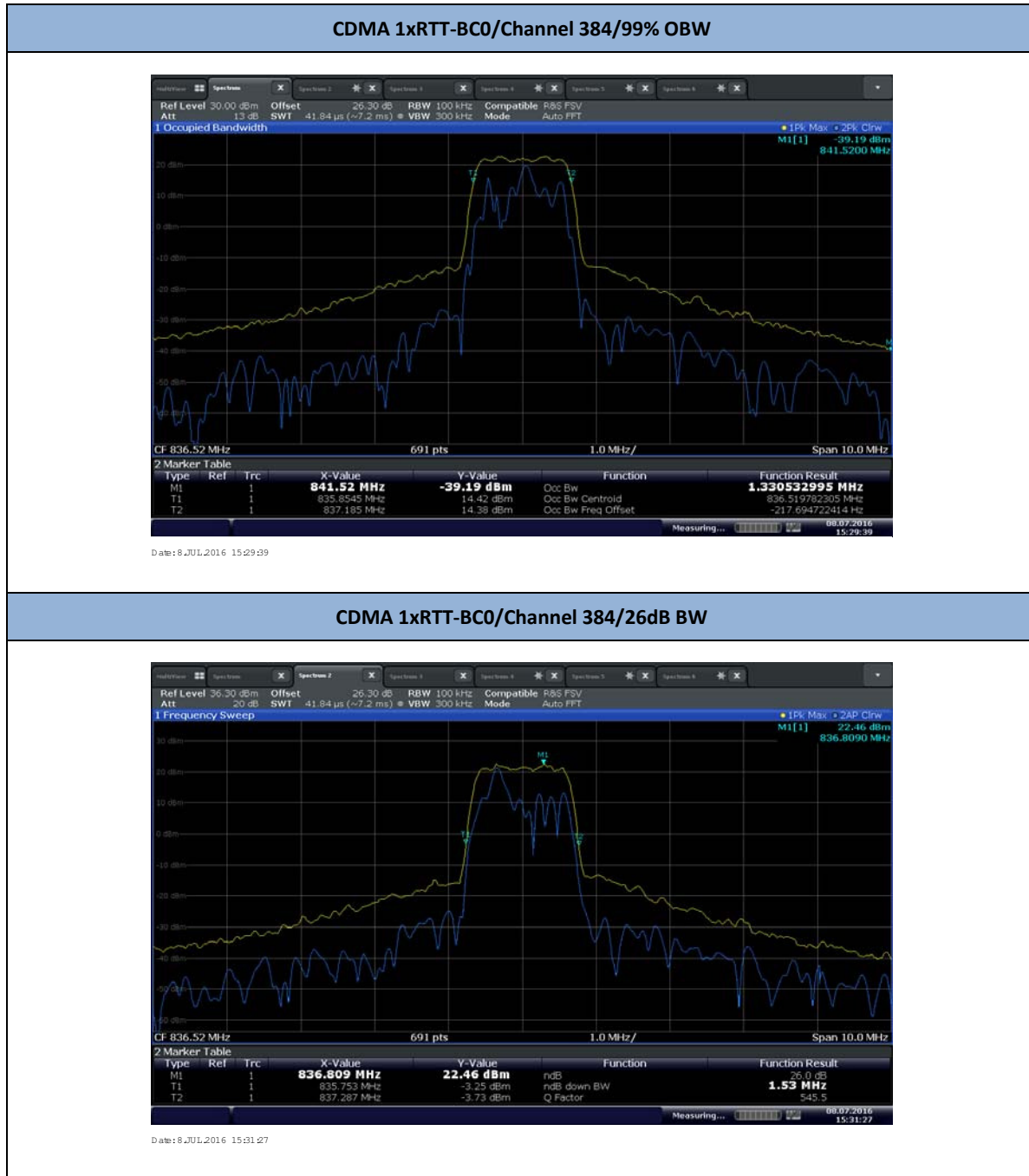



CDMA 1xRTT-BC1/Channel 600/99% OBW

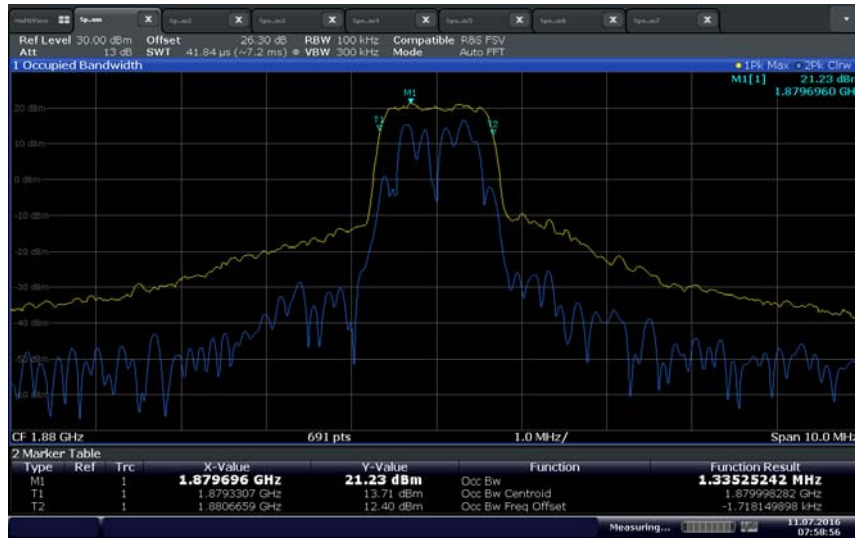

Date:11.JUL.2016 07:58:56

CDMA 1xRTT-BC1/Channel 600/26dB BW



Date:11.JUL.2016 07:59:54



CDMA – 1xEVDO-Rel 0-BC0/Channel 384/99% OBW



Date: 15 JUL 2016 11:11:54

CDMA – 1xEVDO-Rel 0-BC0/Channel 384/26dB BW



Date: 15 JUL 2016 11:12:53



CDMA – 1xEVDO-Rel 0-BC1/Channel 600/99% OBW



Date: 15 JUL 2016 10:51:16

CDMA – 1xEVDO-Rel 0-BC1/Channel 600/26dB BW



Date: 15 JUL 2016 10:45:52



CDMA – 1xEVDO-Rel A-BC0/Channel 384/99% OBW



Date: 15 JUL 2016 11:20:08

CDMA – 1xEVDO-Rel A-BC0/Channel 384/26dB BW



Date: 15 JUL 2016 11:19:09



CDMA – 1xEVDO-Rel A-BC1/Channel 600/99% OBW



Date: 15 JUL 2016 10:49:55

CDMA – 1xEVDO-Rel A-BC1/Channel 600/26dB BW



Date: 15 JUL 2016 10:49:21



GPRS850-BC0/Channel 190/99% OBW

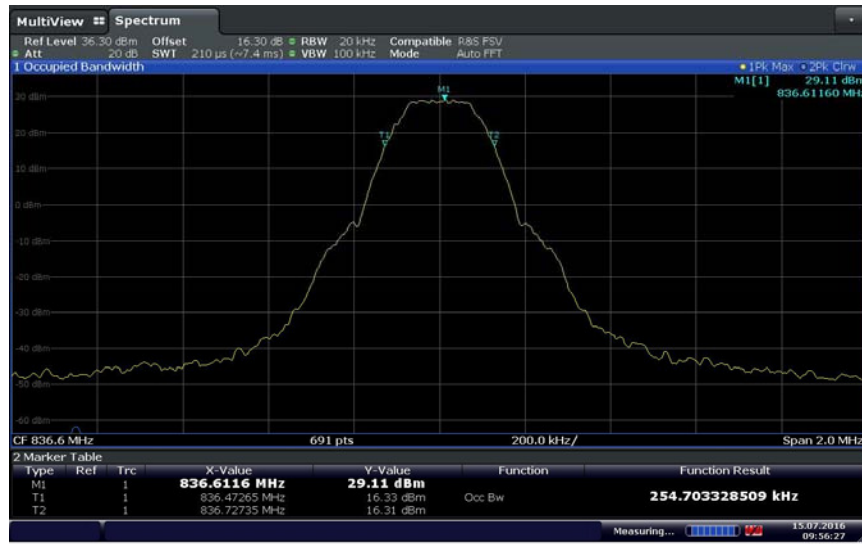

Date: 15 JUL 2016 09:56:28

GPRS850-BC0/Channel 190/26dB BW



Date: 15 JUL 2016 09:57:29



GPRS1900-BC1/Channel 661/99% OBW

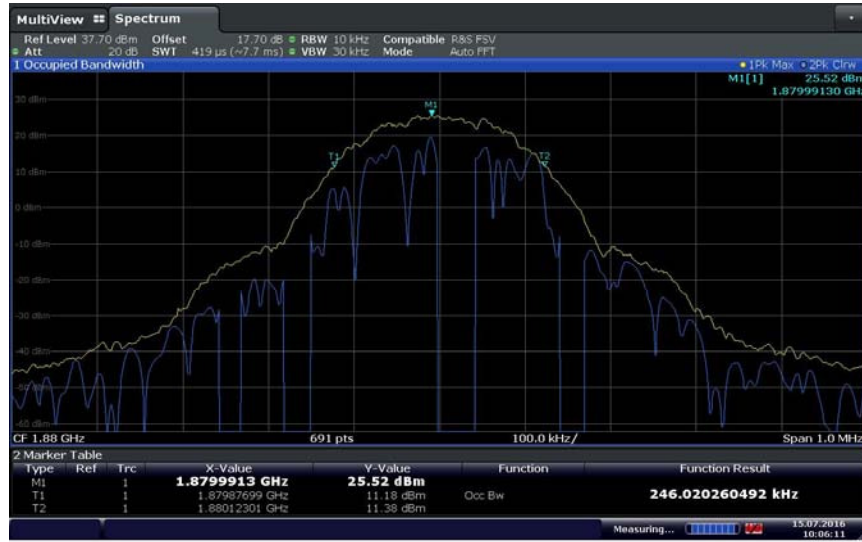

GPRS1900-BC1/Channel 661/26dB BW

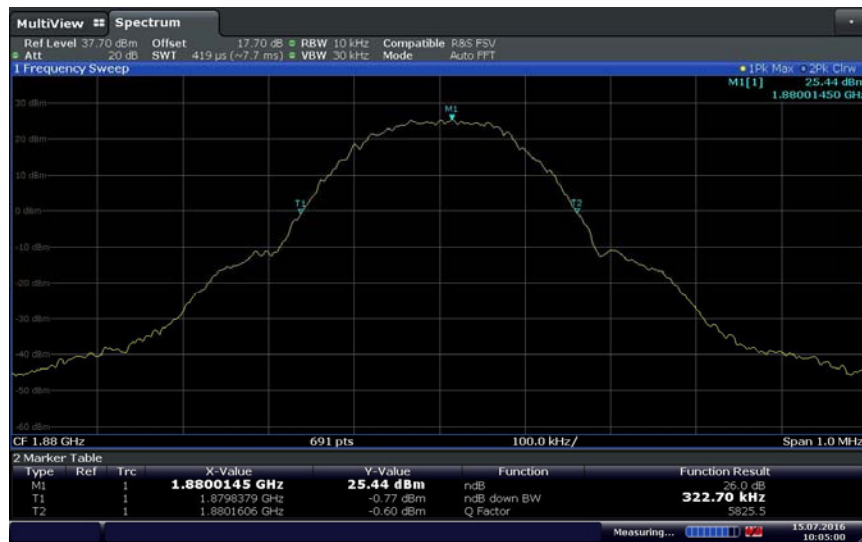



EGPRS850-BC0/Channel 190/99% OBW



Date: 15 JUL 2016 09:54:24

EGPRS850-BC0/Channel 190/26dB BW

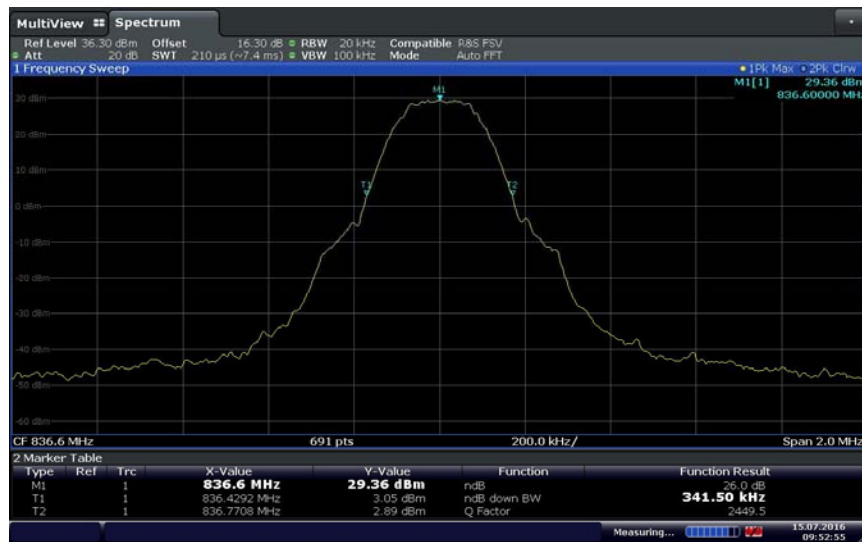

Date: 15 JUL 2016 09:52:58



EGPRS1900-BC1/Channel 661/99% OBW

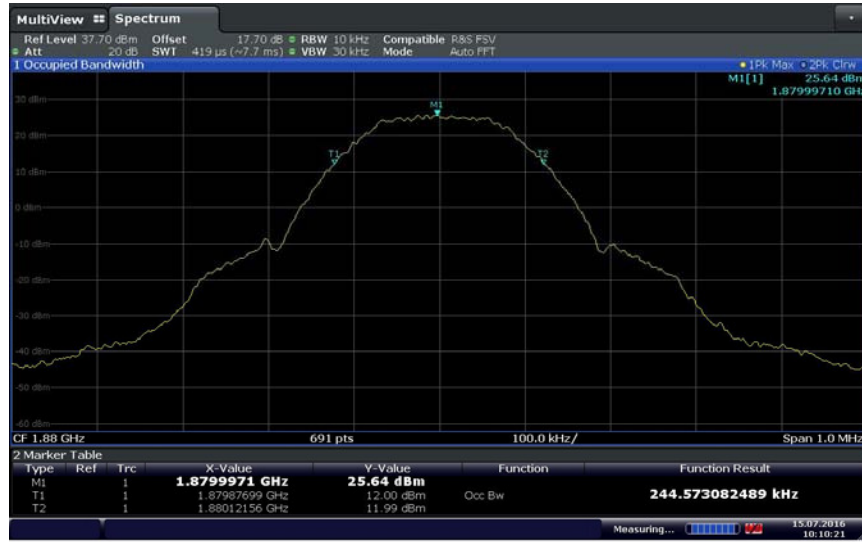

Date: 15 JUL 2016 10:10:21

EGPRS1900-BC1/Channel 661/26dB BW

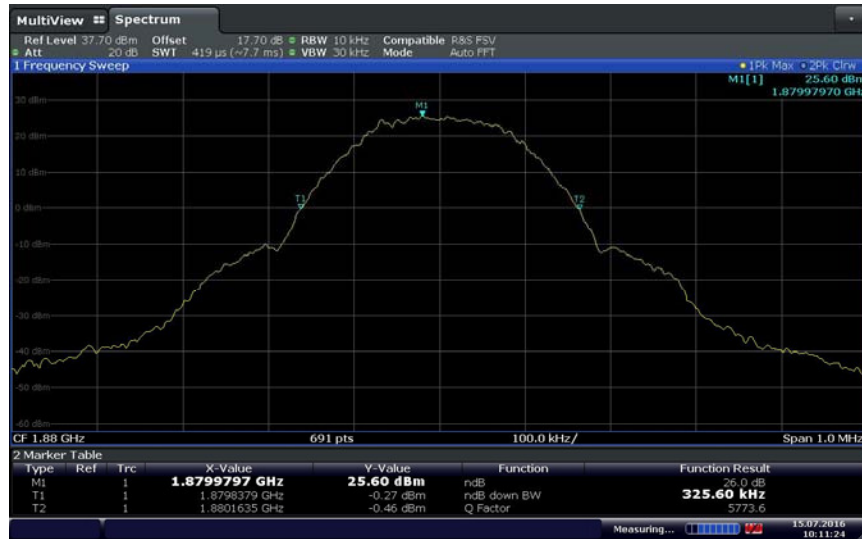

Date: 15 JUL 2016 10:11:23



WCDMA – Band 5/Channel 4183/99% OBW



Date: 15 JUL 2016 10:22:36

WCDMA – Band 5/Channel 4183/99% OBW



Date: 15 JUL 2016 10:21:34



WCDMA – Band 2/Channel 9400/99% OBW



Date: 15 JUL 2016 10:23:35

WCDMA – Band 2/Channel 9400/26dB BW



Date: 15 JUL 2016 10:24:11



LTE Band 5 (1.4 MHz BW)/ Channel 20525/QPSK/99% OBW



Date: 8 JUL 2016 14:03:23

LTE Band 5 (1.4 MHz BW)/ Channel 20525/QPSK/26dB BW



Date: 8 JUL 2016 14:05:49



LTE Band 2 (1.4 MHz BW)/ Channel 1890/QPSK/99% OBW



Date: 7 JUL 2016 11:01:23

LTE Band 2 (1.4 MHz BW)/ Channel 1890/QPSK/26dB BW



Date: 7 JUL 2016 11:02:12



2.6 SPURIOUS EMISSION AT BAND EDGE

2.6.1 Specification Reference

FCC 47 CFR Part 2, Clause 2.1051
FCC 47 CFR Part 22, Clause 22.917(a)
FCC 47 CFR Part 24, Clause 24.238(a)
RSS-132, Clause 5.5
RSS-133, Clause 6.5

2.6.2 Standard Applicable

In the 1.0 MHz bands immediately outside and adjacent to the equipment's operating frequency block, the emission power per any 1% of the emission bandwidth shall be attenuated (in dB) below the transmitter output power P (dBW) by at least $43 + 10 \log_{10} P$ (watts).

2.6.3 Equipment Under Test and Modification State

Serial No: SZ17061900005 / Test Configuration A

2.6.4 Date of Test/Initial of test personnel who performed the test

July 06 to 08, 2016 / XYZ
July 08 and 15, 2016 / FC and AC

2.6.5 Test Equipment Used

The major items of test equipment used for the above tests are identified in Section 3.1.

2.6.6 Environmental Conditions/ Test Location

Test performed at TÜV SÜD America Inc. Rancho Bernardo facility

Ambient Temperature	24.3 - 25.7°C
Relative Humidity	37.8 - 41.5%
ATM Pressure	99.2 - 99.8 kPa

2.6.7 Additional Observations

- This is a conducted test.
- The path loss were measured and entered as a level offset.
- RBW is set to minimum 1% of EBW and VBW is set to $>3 \times$ RBW in the 1 MHz band immediately outside and adjacent to the channel edge.
- For Cell Band, RBW was set to 100 kHz or 1% of the OBW provided the measurement result is integrated over the full reference bandwidth (100kHz).
- Only worst case configuration for all technologies presented in this test report.



2.6.8 Test Results

CDMA 1xRTT/Low Channel (1013)/BC0 Band Edge @ 824 MHz



Date: 8 JUL 2016 15:42:28

CDMA 1xRTT/High Channel (777)/BC0 Band Edge @ 849 MHz



Date: 11 JUL 2016 04:50:11



CDMA 1xRTT/Low Channel (25)/BC1 Band Edge @ 1850 MHz



Date: 11 JUL 2016 07:51:39

CDMA 1xRTT/High Channel (1175)/BC1 Band Edge @ 1910 MHz



Date: 11 JUL 2016 08:02:11



CDMA – 1xEVDO Rel 0/Low Channel (1013)/BC0 Band Edge @ 824 MHz



CDMA – 1xEVDO Rel 0/High Channel (777)/BC0 Band Edge @ 849 MHz





CDMA – 1xEvDO Rel 0/Low Channel (25)/BC1 Band Edge @ 1850 MHz



Date: 15 JUL 2016 13:26:56

CDMA – 1xEvDO Rel 0/High Channel (1175)/BC1 Band Edge @ 1910 MHz



Date: 15 JUL 2016 13:30:16



CDMA – 1xEvDO Rel A/Low Channel (1013)/BC0 Band Edge @ 824 MHz

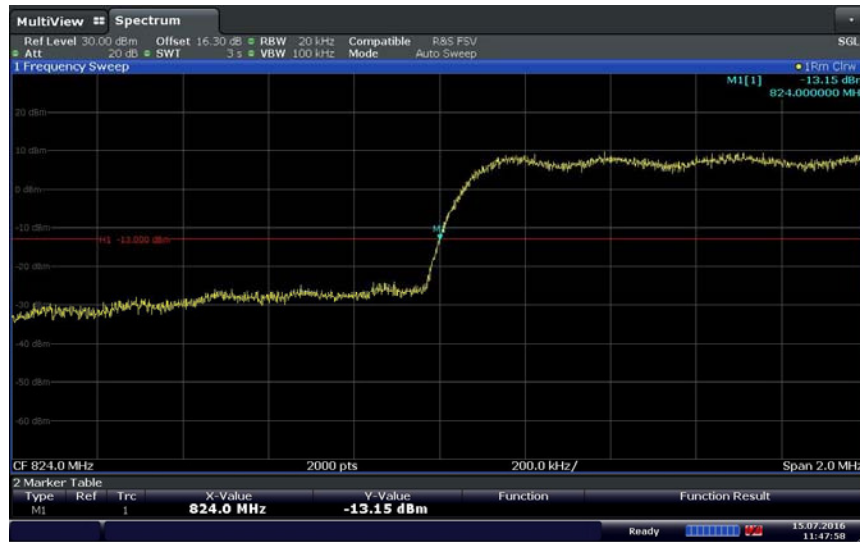

Date: 15 JUL 2016 11:47:58

CDMA – 1xEvDO Rel A/High Channel (777)/BC0 Band Edge @ 849 MHz

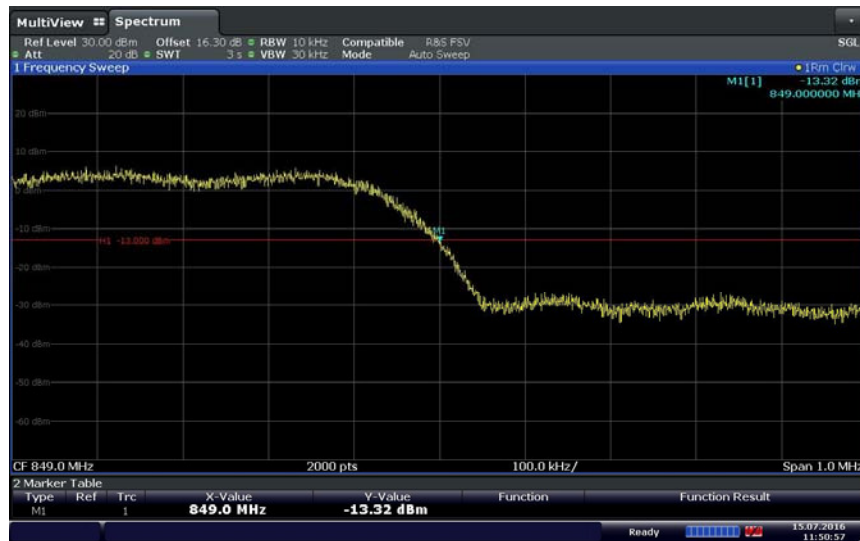

Date: 15 JUL 2016 11:50:57



CDMA – 1xEVDO Rel A/Low Channel (25)/BC1 Band Edge @ 1850 MHz

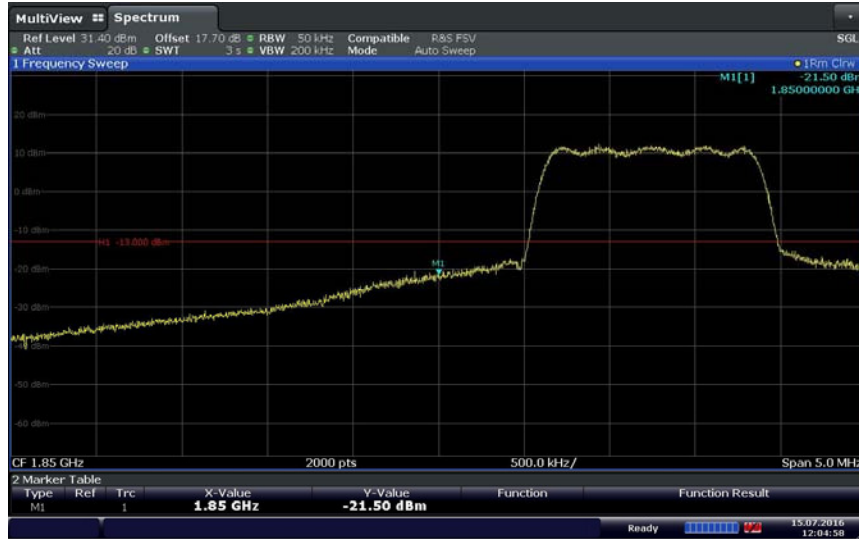

Date: 15 JUL 2016 12:04:58

CDMA – 1xEVDO Rel A/High Channel (1175)/BC1 Band Edge @ 1910 MHz



Date: 15 JUL 2016 12:06:19



GPRS850-BC0/Low Channel (128)/Band Edge @ 824 MHz



Date: 15 JUL 2016 12:36:07

GPRS850-BC0/High Channel (251)/Band Edge @ 849 MHz

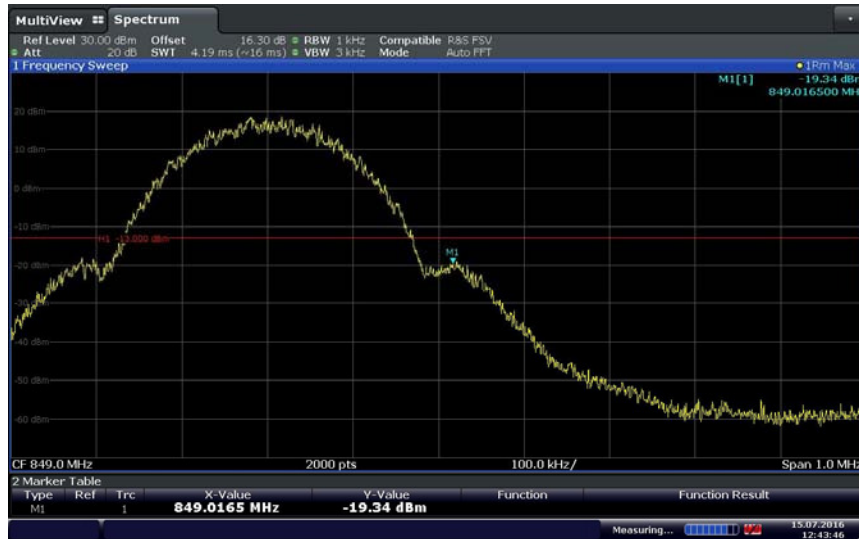

Date: 15 JUL 2016 12:43:46



GPRS1900-BC1/Low Channel (512)/Band Edge @ 1850 MHz

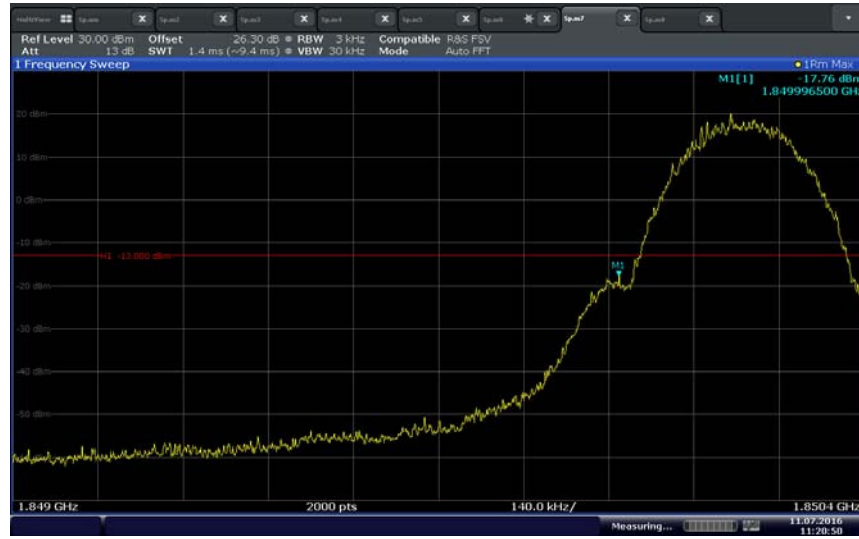

GPRS1900-BC1/High Channel (810)/Band Edge @ 1910 MHz

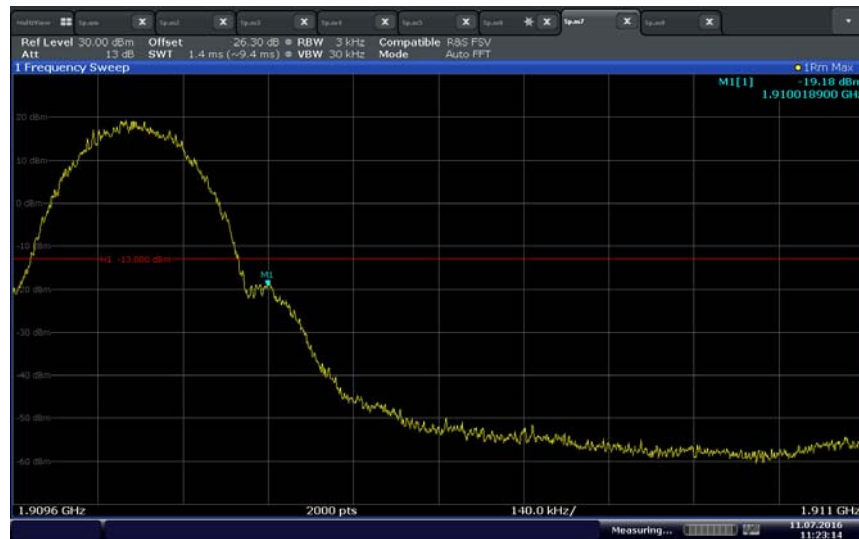



EGPRS850-BC0/Low Channel (128)/Band Edge @ 824 MHz



Date: 15 JUL 2016 12:42:39

EGPRS850-BC0/High Channel (251)/Band Edge @ 849 MHz



Date: 15 JUL 2016 12:41:04



EGPRS1900-BC1/Low Channel (512)/Band Edge @ 1850 MHz



EGPRS1900-BC1/High Channel (810)/Band Edge @ 1910 MHz

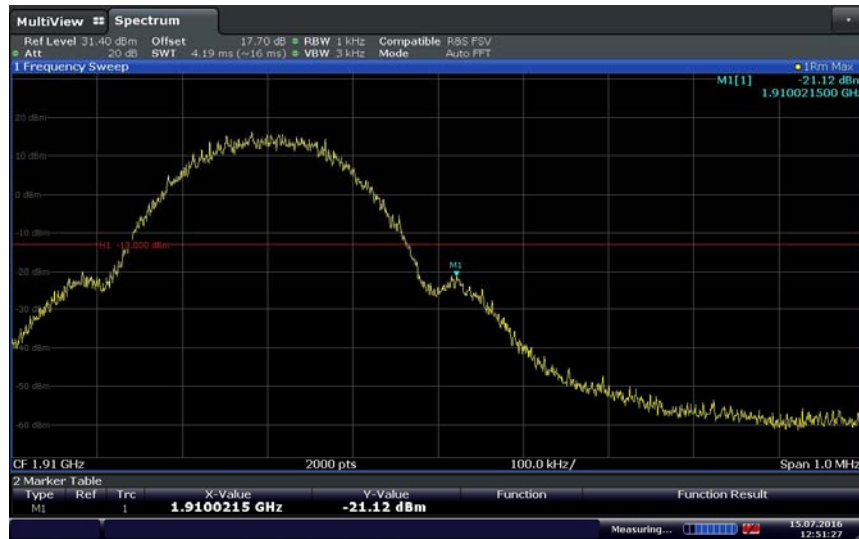



WCDMA – Band 5/Low Channel (4132)/Band Edge @ 824 MHz



Date: 15 JUL 2016 13:13:14

WCDMA – Band 5/High Channel (4233)/Band Edge @ 849 MHz



Date: 15 JUL 2016 13:15:06



WCDMA – Band 2/Low Channel (9262)/Band Edge @ 1850 MHz



Date: 15 JUL 2016 13:16:57

WCDMA – Band 2/High Channel (9538)/Band Edge @ 1910 MHz



Date: 15 JUL 2016 13:18:23



LTE Band 5 (1.4 MHz BW)/QPSK/Low Channel (20407) Band Edge @ 824 MHz



Date: 8 JUL 2016 14:43:12

LTE Band 5 (1.4 MHz BW)/QPSK/High Channel (20643) Band Edge @ 849 MHz



Date: 8 JUL 2016 14:44:16



LTE Band 5 (3 MHz BW)/QPSK/Low Channel (20415) Band Edge @ 824 MHz



LTE Band 5 (3 MHz BW)/QPSK/High Channel (20635) Band Edge @ 849 MHz





LTE Band 5 (5 MHz BW)/QPSK/Low Channel (20425) Band Edge @ 824 MHz



Date: 8 JUL 2016 11:58:48

LTE Band 5 (5 MHz BW)/QPSK/High Channel (20625) Band Edge @ 849 MHz

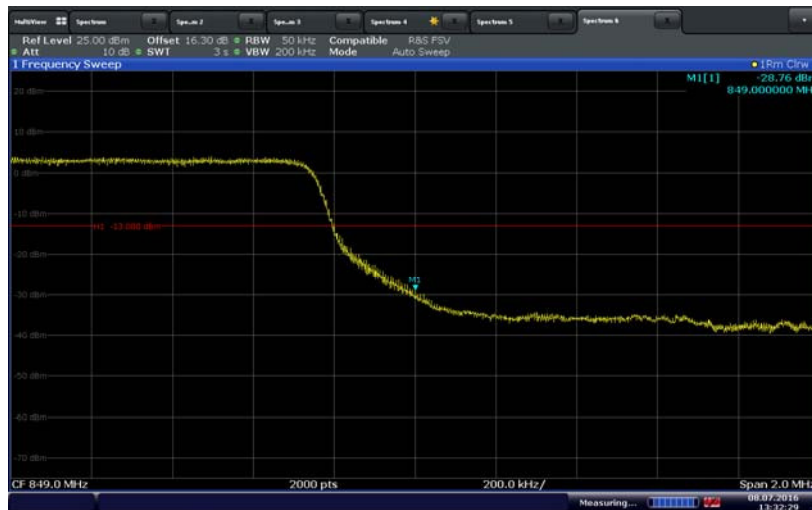

Date: 8 JUL 2016 13:32:29



LTE Band 5 (10 MHz BW)/QPSK/Low Channel (20450) Band Edge @ 824 MHz

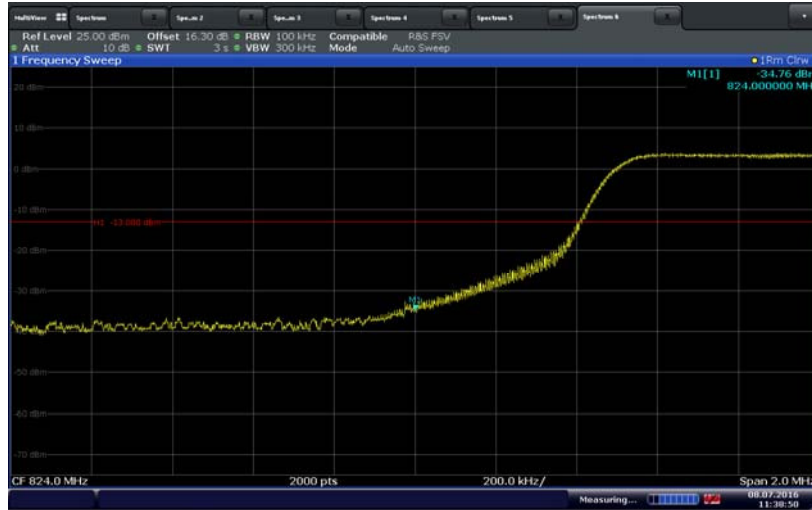

Date: 8 JUL 2016 11:38:50

LTE Band 5 (10 MHz BW)/QPSK/High Channel (20600) Band Edge @ 849 MHz

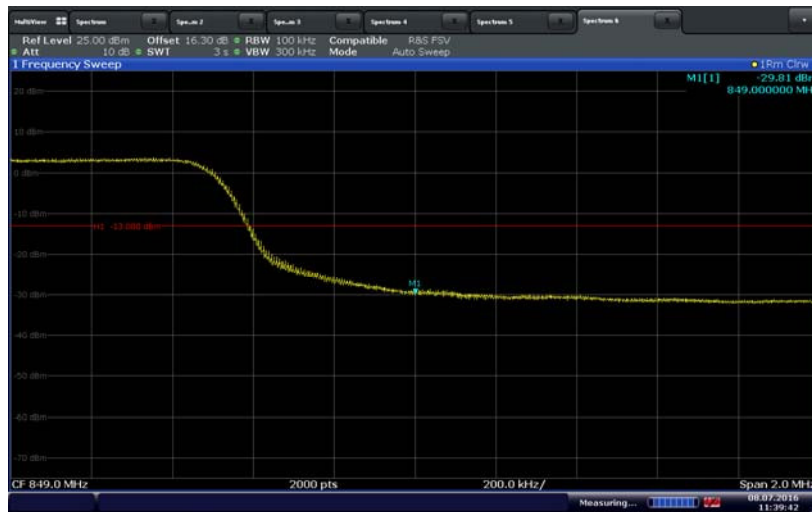

Date: 8 JUL 2016 11:39:42



LTE Band 2 (1.4 MHz BW)/QPSK/Low Channel (18607) Band Edge @ 1850 MHz



Date: 7 JUL 2016 11:16:11

LTE Band 2 (1.4 MHz BW)/QPSK/High Channel (19193) Band Edge @ 1910 MHz



Date: 7 JUL 2016 11:20:53



LTE Band 2 (3 MHz BW)/QPSK/Low Channel (18615) Band Edge @ 1850 MHz



Date: 6 JUL 2016 17:10:47

LTE Band 2 (3 MHz BW)/QPSK/High Channel (19185) Band Edge @ 1910 MHz



Date: 6 JUL 2016 17:13:39