

SAR Data Summary – 835 MHz Body - WCDMA

MEASUREMENT RESULTS

Gap	Plot	Frequency		Modulation	Position	End Power (dBm)	RMC	Test Set Up	Measured SAR (W/kg)	Reported SAR (W/kg)
		MHz	Ch.							
10 mm	1	836.6	4183	WCDMA	Side A	23.98	12.2 kbps	Test Loop 1	0.679	0.68
	----	836.6	4183	WCDMA	Side B	23.98	12.2 kbps	Test Loop 1	0.325	0.33
	----	836.6	4183	WCDMA	Side C	23.98	12.2 kbps	Test Loop 1	0.437	0.44
	----	836.6	4183	WCDMA	Side D	23.98	12.2 kbps	Test Loop 1	0.180	0.18
	----	836.6	4183	WCDMA	Side E	23.98	12.2 kbps	Test Loop 1	0.128	0.13

Body
1.6 W/kg (mW/g)
averaged over 1 gram

1. SAR Measurement
 - Phantom Configuration Left Head Eli4 Right Head
 - SAR Configuration Head Body
2. Test Signal Call Mode Test Code Base Station Simulator
3. Test Configuration With Belt Clip Without Belt Clip N/A
4. Tissue Depth is at least 15.0 cm

SAR Data Summary – 835 MHz Body - GPRS
MEASUREMENT RESULTS

Gap	Plot	Frequency		Rev Level/ Modulation	Position	End Power (dBm)	TX Level	Multislot Configuration	Measured SAR (W/kg)	Reported SAR (W/kg)
		MHz	Ch.							
10 mm	2	836.6	190	GMSK	Side A	32.45	5	1 Slot	0.697	0.79
	----	836.6	190	GMSK	Side B	32.45	5	1 Slot	0.289	0.33
	----	836.6	190	GMSK	Side C	32.45	5	1 Slot	0.307	0.35
	----	836.6	190	GMSK	Side D	32.45	5	1 Slot	0.114	0.13
	----	836.6	190	GMSK	Side E	32.45	5	1 Slot	0.098	0.11

Body
1.6 W/kg (mW/g)
averaged over 1 gram

1. SAR Measurement
 - Phantom Configuration
 - Left Head
 - Eli4
 - Head
 - Body
 - Right Head
 - SAR Configuration
 - Test Code
 - Base Station Simulator
2. Test Signal Call Mode
 - Test Code
 - Base Station Simulator
3. Test Configuration
 - With Belt Clip
 - Without Belt Clip
 - N/A
4. Tissue Depth is at least 15.0 cm

SAR Data Summary – 835 MHz Body – LTE Band 5

MEASUREMENT RESULTS												
Gap	Plot	Position	Frequency		BW/ Modulation	RB Size	RB Offset	MPR Target	End Power (dBm)	Measured SAR (W/kg)	Reported SAR (W/kg)	
			MHz	Ch.								
10 mm	3	Side A	836.5	20525	10 MHz/QPSK	1	0	0	22.97	0.391	0.50	
	-----		836.5	20525	10 MHz/QPSK	25	0	1	22.05	0.309	0.39	
	-----	Side B	836.5	20525	10 MHz/QPSK	1	0	0	22.97	0.247	0.31	
	-----		836.5	20525	10 MHz/QPSK	25	0	1	22.05	0.187	0.23	
	-----	Side C	836.5	20525	10 MHz/QPSK	1	0	0	22.97	0.379	0.48	
	-----		836.5	20525	10 MHz/QPSK	25	0	1	22.05	0.304	0.38	
	-----	Side D	836.5	20525	10 MHz/QPSK	1	0	0	22.97	0.196	0.25	
	-----		836.5	20525	10 MHz/QPSK	25	0	1	22.05	0.156	0.19	
	-----	Side E	836.5	20525	10 MHz/QPSK	1	0	0	22.97	0.0582	0.07	
	-----		836.5	20525	10 MHz/QPSK	25	0	1	22.05	0.0474	0.06	
	Body 1.6 W/kg (mW/g) averaged over 1 gram											

1. SAR Measurement
 - Phantom Configuration Left Head Eli4 Right Head
 - SAR Configuration Head Body
2. Test Signal Call Mode Test Code Base Station Simulator
3. Test Configuration With Belt Clip Without Belt Clip N/A
4. Tissue Depth is at least 15.0 cm

SAR Data Summary – 1900 MHz Body - WCDMA
MEASUREMENT RESULTS

Gap	Plot	Frequency		Rev Level/ Modulation	Position	End Power (dBm)	RMC	Test Set Up	Measured SAR (W/kg)	Reported SAR (W/kg)
		MHz	Ch.							
10 mm	----	1852.4	9262	WCDMA	Side A	23.88	12.2 kbps	Test Loop 1	1.07	1.10
	----	1880.0	9400	WCDMA		23.90	12.2 kbps	Test Loop 1	0.852	0.87
	----	1907.6	9538	WCDMA		23.95	12.2 kbps	Test Loop 1	0.621	0.63
	----	1852.4	9262	WCDMA	Side B	23.88	12.2 kbps	Test Loop 1	0.114	0.12
	4	1852.4	9262	WCDMA	Side C	23.88	12.2 kbps	Test Loop 1	1.35	1.39
	----	1880.0	9400	WCDMA		23.90	12.2 kbps	Test Loop 1	1.13	1.16
	----	1907.6	9538	WCDMA		23.95	12.2 kbps	Test Loop 1	0.952	0.96
	----	1852.4	9262	WCDMA	Side D	23.88	12.2 kbps	Test Loop 1	0.128	0.13
----	1852.4	9262	WCDMA	Side E	23.88	12.2 kbps	Test Loop 1	0.562	0.58	

Body
1.6 W/kg (mW/g)
 averaged over 1 gram

1. SAR Measurement
 - Phantom Configuration
 - Left Head
 - Eli4
 - Head
 - Body
 - Right Head
 - 2. Test Signal Call Mode
 - Test Code
 - Base Station Simulator
 - 3. Test Configuration
 - With Belt Clip
 - Without Belt Clip
 - N/A
 - 4. Tissue Depth is at least 15.0 cm

SAR Data Summary – 1900 MHz Body - GPRS
MEASUREMENT RESULTS

Gap	Plot	Frequency		Rev Level/ Modulation	Position	End Power (dBm)	TX Level	Multislot Configuration	Measured SAR (W/kg)	Reported SAR (W/kg)
		MHz	Ch.							
10 mm	----	1880.0	661	GMSK	Side A	29.20	0	1 Slot	0.317	0.38
	----	1880.0	661	GMSK	Side B	29.20	0	1 Slot	0.0397	0.05
	5	1880.0	661	GMSK	Side C	29.20	0	1 Slot	0.415	0.50
	----	1880.0	661	GMSK	Side D	29.20	0	1 Slot	0.0462	0.06
	----	1880.0	661	GMSK	Side E	29.20	0	1 Slot	0.179	0.22

Body
1.6 W/kg (mW/g)
averaged over 1 gram

1. SAR Measurement
 - Phantom Configuration
 - Left Head
 - Eli4
 - Head
 - Body
 - Right Head
 - 2. Test Signal Call Mode
 - Test Code
 - Base Station Simulator
 - 3. Test Configuration
 - With Belt Clip
 - Without Belt Clip
 - N/A
 - 4. Tissue Depth is at least 15.0 cm

SAR Data Summary – 1900 MHz Body – LTE Band 2

MEASUREMENT RESULTS											
Gap	Plot	Position	Frequency		BW/ Modulation	RB Size	RB Offset	MPR Target	End Power (dBm)	Measured SAR (W/kg)	Reported SAR (W/kg)
			MHz	Ch.							
10 mm	----	Side A	1860.0	18700	20 MHz/QPSK	1	0	0	23.48	1.11	1.25
	----		1880.0	18900	20 MHz/QPSK	1	0	0	23.50	0.867	0.97
	----		1900.0	19100	20 MHz/QPSK	1	0	0	23.34	0.773	0.90
	----		1860.0	18700	20 MHz/QPSK	50	0	1	22.39	0.795	0.92
	----		1880.0	18900	20 MHz/QPSK	50	0	1	22.61	0.689	0.75
	----		1900.0	19100	20 MHz/QPSK	50	0	1	22.22	0.572	0.69
	----	Side B	1860.0	18700	20 MHz/QPSK	1	0	0	23.48	0.142	0.16
	----		1860.0	18700	20 MHz/QPSK	50	0	1	22.39	0.104	0.12
	----	Side C	1860.0	18700	20 MHz/QPSK	1	0	0	23.48	1.14	1.29
	6		1880.0	18900	20 MHz/QPSK	1	0	0	23.50	1.27	1.43
	----		1900.0	19100	20 MHz/QPSK	1	0	0	23.34	0.84	0.98
	----		1860.0	18700	20 MHz/QPSK	50	0	1	22.39	0.96	1.11
	----		1880.0	18900	20 MHz/QPSK	50	0	1	22.61	0.811	0.89
	----		1900.0	19100	20 MHz/QPSK	50	0	1	22.22	0.658	0.79
	----	Side D	1860.0	18700	20 MHz/QPSK	1	0	0	23.48	0.149	0.17
	----		1860.0	18700	20 MHz/QPSK	50	0	1	22.39	0.112	0.13
	----	Side E	1860.0	18700	20 MHz/QPSK	1	0	0	23.48	0.919	1.04
	----		1880.0	18900	20 MHz/QPSK	1	0	0	23.50	0.705	0.79
----	1900.0		19100	20 MHz/QPSK	1	0	0	23.34	0.624	0.73	
----	1860.0		18700	20 MHz/QPSK	50	0	1	22.39	0.635	0.73	

Body
1.6 W/kg (mW/g)
 averaged over 1 gram

- 5. SAR Measurement
 - Phantom Configuration Left Head Eli4 Right Head
 - SAR Configuration Head Body
- 6. Test Signal Call Mode Test Code Base Station Simulator
- 7. Test Configuration With Belt Clip Without Belt Clip N/A
- 8. Tissue Depth is at least 15.0 cm

SAR Data Summary – 1735 MHz Body – LTE Band 4

MEASUREMENT RESULTS											
Gap	Plot	Position	Frequency		BW/ Modulation	RB Size	RB Offset	MPR Target	End Power (dBm)	Measured SAR (W/kg)	Reported SAR (W/kg)
			MHz	Ch.							
10 mm	-----	Side A	1720.0	20050	20 MHz/QPSK	1	0	0	24.00	1.41	1.41
	-----		1732.5	20175	20 MHz/QPSK	1	0	0	23.10	1.07	1.32
	-----		1745.0	20300	20 MHz/QPSK	1	0	0	23.98	1.26	1.27
	-----		1720.0	20050	20 MHz/QPSK	50	0	1	22.21	0.914	1.10
	-----		1732.5	20175	20 MHz/QPSK	50	0	1	23.00	0.896	0.90
	-----		1745.0	20300	20 MHz//QPSK	50	0	1	22.61	0.947	1.04
	-----	Side B	1720.0	20050	20 MHz/QPSK	1	0	0	24.00	0.177	0.18
	-----		1720.0	20050	20 MHz/QPSK	50	0	1	22.21	0.113	0.14
	-----	Side C	1720.0	20050	20 MHz/QPSK	1	0	0	24.00	1.42	1.42
	7		1732.5	20175	20 MHz/QPSK	1	0	0	23.10	1.17	1.44
	-----		1745.0	20300	20 MHz/QPSK	1	0	0	23.98	1.26	1.27
	-----		1720.0	20050	20 MHz/QPSK	50	0	1	22.21	0.895	1.07
	-----		1732.5	20175	20 MHz/QPSK	50	0	1	23.00	0.886	0.89
	-----		1745.0	20300	20 MHz//QPSK	50	0	1	22.61	0.952	1.04
	-----	Side D	1720.0	20050	20 MHz/QPSK	1	0	0	24.00	0.0778	0.08
	-----		1720.0	20050	20 MHz/QPSK	50	0	1	22.21	0.0466	0.06
	-----	Side E	1720.0	20050	20 MHz/QPSK	1	0	0	24.00	1.05	1.05
	-----		1732.5	20175	20 MHz/QPSK	1	0	0	23.10	0.779	0.96
	-----		1745.0	20300	20 MHz/QPSK	1	0	0	23.98	0.924	0.93
	-----		1720.0	20050	20 MHz/QPSK	50	0	1	22.21	0.635	0.76

Body
1.6 W/kg (mW/g)
 averaged over 1 gram

1. SAR Measurement
 - Phantom Configuration Left Head Eli4 Right Head
 - SAR Configuration Head Body
2. Test Signal Call Mode Test Code Base Station Simulator
3. Test Configuration With Belt Clip Without Belt Clip N/A
4. Tissue Depth is at least 15.0 cm

SAR Data Summary – 750 MHz Body – LTE Band 12

MEASUREMENT RESULTS											
Gap	Plot	Position	Frequency		BW/ Modulation	RB Size	RB Offset	MPR Target	End Power (dBm)	Measured SAR (W/kg)	Reported SAR (W/kg)
			MHz	Ch.							
10 mm	8	Side A	707.5	23095	10 MHz/QPSK	1	0	0	23.13	0.440	0.54
	-----		707.5	23095	10 MHz/QPSK	25	0	1	22.19	0.354	0.43
	-----	Side B	707.5	23095	10 MHz/QPSK	1	0	0	23.13	0.208	0.25
	-----		707.5	23095	10 MHz/QPSK	25	0	1	22.19	0.164	0.20
	-----	Side C	707.5	23095	10 MHz/QPSK	1	0	0	23.13	0.309	0.38
	-----		707.5	23095	10 MHz/QPSK	25	0	1	22.19	0.246	0.30
	-----	Side D	707.5	23095	10 MHz/QPSK	1	0	0	23.13	0.0798	0.10
	-----		707.5	23095	10 MHz/QPSK	25	0	1	22.19	0.0624	0.08
	-----	Side E	707.5	23095	10 MHz/QPSK	1	0	0	23.13	0.0744	0.09
	-----		707.5	23095	10 MHz/QPSK	25	0	1	22.19	0.0587	0.07

Body
1.6 W/kg (mW/g)
 averaged over 1 gram

1. SAR Measurement
 Phantom Configuration Left Head Eli4 Right Head
 SAR Configuration Head Body
 Test Signal Call Mode Test Code Base Station Simulator
 Test Configuration With Belt Clip Without Belt Clip N/A
4. Tissue Depth is at least 15.0 cm

SAR Data Summary – 2450 MHz Body 802.11b/g

MEASUREMENT RESULTS

Gap	Plot	Position	Frequency		Modulation	Antenna	End Power	Measured SAR (W/kg)	Reported SAR (W/kg)
			MHz	Ch.			(dBm)		
10 mm	-----	Side A	2437	6	DSSS	Chain 0	17.58	0.079	0.09
	9	Side B	2437	6	DSSS		17.58	0.278	0.31
	-----	Side C	2437	6	DSSS		17.58	0.136	0.15
	-----	Side D	2437	6	DSSS		17.58	0.0056	0.01
	-----	Side E	2437	6	DSSS		17.58	0.0013	0.01
	-----	Side A	2437	6	OFDM	Chain 1	3.81	0.040	0.04
	-----	Side B	2437	6	OFDM		3.81	0.057	0.06
	-----	Side C	2437	6	OFDM		3.81	0.014	0.01
	-----	Side D	2437	6	OFDM		3.81	0.0037	0.01
	-----	Side E	2437	6	OFDM		3.81	0.001	0.01

Body
1.6 W/kg (mW/g)
 averaged over 1 gram

1. SAR Measurement
 - Phantom Configuration Left Head Eli4 Right Head
 - SAR Configuration Head Body
2. Test Signal Call Mode Test Code Base Station Simulator
3. Test Configuration With Belt Clip Without Belt Clip N/A
4. Tissue Depth is at least 15.0 cm

SAR Data Summary – 5200 MHz Body 802.11a

MEASUREMENT RESULTS

Gap	Plot	Position	Frequency		Modulation	Antenna	End Power	Measured SAR (W/kg)	Reported SAR (W/kg)
			MHz	Ch.			(dBm)		
10 mm	-----	Side A	5220	44	OFDM	Chain 0	7.98	0.0186	0.02
	-----	Side B	5220	44	OFDM		7.98	0.0341	0.03
	10	Side C	5220	44	OFDM		7.98	0.0671	0.07
	-----	Side D	5220	44	OFDM		7.98	0.0015	0.01
	-----	Side E	5220	44	OFDM		7.98	0.0006	0.01
	-----	Side A	5220	44	OFDM	Chain 1	7.98	0.0193	0.02
	-----	Side B	5220	44	OFDM		7.98	0.0385	0.04
	-----	Side C	5220	44	OFDM		7.98	0.0597	0.06
	-----	Side D	5220	44	OFDM		7.98	0.0013	0.01
	-----	Side E	5220	44	OFDM		7.98	0.0006	0.01

Body
1.6 W/kg (mW/g)
 averaged over 1 gram

1. SAR Measurement
 Phantom Configuration Left Head Eli4 Right Head
 SAR Configuration Head Body
2. Test Signal Call Mode Test Code Base Station Simulator
3. Test Configuration With Belt Clip Without Belt Clip N/A
4. Tissue Depth is at least 15.0 cm

SAR Data Summary – 5800 MHz Body 802.11a
MEASUREMENT RESULTS

Gap	Plot	Position	Frequency		Modulation	Antenna	End Power	Measured SAR (W/kg)	Reported SAR (W/kg)
			MHz	Ch.			(dBm)		
10 mm	-----	Side A	5785	157	OFDM	Chain 0	7.96	0.0204	0.02
	-----	Side B	5785	157	OFDM		7.96	0.0326	0.03
	11	Side C	5785	157	OFDM		7.96	0.0633	0.06
	-----	Side D	5785	157	OFDM		7.96	0.0013	0.01
	-----	Side E	5785	157	OFDM		7.96	0.0005	0.01
	-----	Side A	5785	157	OFDM	Chain 1	7.96	0.0157	0.02
	-----	Side B	5785	157	OFDM		7.96	0.0374	0.04
	-----	Side C	5785	157	OFDM		7.96	0.0547	0.06
	-----	Side D	5785	157	OFDM		7.96	0.0011	0.01
	-----	Side E	5785	157	OFDM		7.96	0.0003	0.01

Body
1.6 W/kg (mW/g)
averaged over 1 gram

1. SAR Measurement
 - Phantom Configuration
 - Left Head
 - Eli4
 - Head
 - Body
 - Right Head
2. Test Signal Call Mode
 - Test Code
 - Base Station Simulator
3. Test Configuration
 - With Belt Clip
 - Without Belt Clip
 - N/A
4. Tissue Depth is at least 15.0 cm

SAR Data Summary – Simultaneous Transmit (WLAN SISO)

MEASUREMENT RESULTS									
Plot	Position	Frequency (WLAN)		Frequency (WWAN)		WWAN Technology	SAR (W/kg) WLAN	SAR (W/kg) WWAN	Total SAR (W/kg)
		MHz	Ch.	MHz	Ch.				
----	Side A	2437	6	1720.0	20050	LTE Band 4	0.09	1.41	1.50
----	Side B	2437	6	836.5	20525	LTE Band 5	0.31	0.31	0.62
----	Side C	2437	6	1732.5	20175	LTE Band 4	0.15	1.44	1.59
----	Side D	2437	6	836.5	20525	LTE Band 5	0.01	0.25	0.26
----	Side E	2437	6	1720.0	2005	LTE Band 4	0.01	1.05	1.06
Body 1.6 W/kg (mW/g) averaged over 1 gram									

Note: The WWAN and WLAN antennas can transmit simultaneously. Therefore, the SAR is calculated by summing the individual SAR values on each side. The highest SAR value of all bands was used to determine each sides compliance.

SAR Data Summary – Simultaneous Transmit (WLAN MIMO)

MEASUREMENT RESULTS									
Plot	Position	Frequency (WLAN)		Frequency (WWAN)		WWAN Technology	SAR (W/kg) WLAN	SAR (W/kg) WWAN	Total SAR (W/kg)
		MHz	Ch.	MHz	Ch.				
----	Side A	2437	6	1720.0	20050	LTE Band 4	0.09 + 0.04	1.41	1.54
----	Side B	2437	6	836.5	20525	LTE Band 5	0.31 + 0.06	0.31	0.68
----	Side C	2437	6	1732.5	20175	LTE Band 4	0.15 + 0.01	1.44	1.60
----	Side D	2437	6	836.5	20525	LTE Band 5	0.01 + 0.01	0.25	0.27
----	Side E	2437	6	1720.0	2005	LTE Band 4	0.01 + 0.01	1.05	1.07
Body 1.6 W/kg (mW/g) averaged over 1 gram									

Note: The WWAN and WLAN antennas can transmit simultaneously. Therefore, the SAR is calculated by summing the individual SAR values on each side. The highest SAR value of all bands was used to determine each sides compliance.

The sum of all simultaneous transmitters is less than the limit of 1.6 W/kg. Therefore, the simultaneous transmission meets the requirements.

11. Test Equipment List

Table 11.1 Equipment Specifications

Type	Calibration Due Date	Calibration Done Date	Serial Number
Staubli Robot TX60L	N/A	N/A	F07/55M6A1/A/01
Measurement Controller CS8c	N/A	N/A	1012
ELI4 Flat Phantom	N/A	N/A	1065
Device Holder	N/A	N/A	N/A
Data Acquisition Electronics 4	08/15/2014	08/15/2013	759
Data Acquisition Electronics 4	01/13/2015	01/13/2014	1416
Data Acquisition Electronics 4	08/12/2015	08/12/2014	759
SPEAG E-Field Probe EX3DV4	08/27/2014	08/27/2013	3693
SPEAG E-Field Probe EX3DV4	04/15/2015	04/15/2014	3662
Speag Validation Dipole D750V2	12/04/2015	12/03/2012	1016
Speag Validation Dipole D835V2	12/04/2015	12/03/2012	4d089
Speag Validation Dipole D1750V2	12/05/2015	12/05/2012	1018
Speag Validation Dipole D1900V2	12/06/2015	12/06/2012	5d116
Speag Validation Dipole D2450V2	12/04/2015	12/04/2012	829
Speag Validation Dipole D5GHzV2	12/11/2015	12/11/2012	1085
Agilent N1911A Power Meter	03/24/2015	03/24/2014	GB45100254
Agilent N1922A Power Sensor	06/25/2014	06/25/2013	MY45240464
Advantest R3261A Spectrum Analyzer	03/24/2015	03/24/2014	31720068
Agilent (HP) 8350B Signal Generator	03/24/2015	03/24/2014	2749A10226
Agilent (HP) 83525A RF Plug-In	03/24/2015	03/24/2014	2647A01172
Agilent (HP) 8753C Vector Network Analyzer	03/25/2015	03/25/2014	3135A01724
Agilent (HP) 85047A S-Parameter Test Set	03/25/2015	03/25/2014	2904A00595
Agilent (HP) 8960 Base Station Sim.	10/19/2016	10/19/2014	MY48360364
Anritsu MT8820C	07/29/2015	07/29/2014	6201176199
Apriel Dielectric Probe Assembly	N/A	N/A	0011
Body Equivalent Matter (750 MHz)	N/A	N/A	N/A
Body Equivalent Matter (835 MHz)	N/A	N/A	N/A
Body Equivalent Matter (1750 MHz)	N/A	N/A	N/A
Body Equivalent Matter (1900 MHz)	N/A	N/A	N/A
Body Equivalent Matter (2450 MHz)	N/A	N/A	N/A
Body Equivalent Matter (5 Ghz)	N/A	N/A	N/A

12. Conclusion

The SAR measurement indicates that the EUT complies with the RF radiation exposure limits of the FCC/IC. These measurements are taken to simulate the RF effects exposure under worst-case conditions. Precise laboratory measures were taken to assure repeatability of the tests. The tested device complies with the requirements in respect to all parameters subject to the test. The test results and statements relate only to the item(s) tested.

Please note that the absorption and distribution of electromagnetic energy in the body is a very complex phenomena that depends on the mass, shape, and size of the body; the orientation of the body with respect to the field vectors; and, the electrical properties of both the body and the environment. Other variables that may play a substantial role in possible biological effects are those that characterize the environment (e.g. ambient temperature, air velocity, relative humidity, and body insulation) and those that characterize the individual (e.g. age, gender, activity level, debilitation, or disease). Because innumerable factors may interact to determine the specific biological outcome of an exposure to electromagnetic fields, any protection guide shall consider maximal amplification of biological effects as a result of field-body interactions, environmental conditions, and physiological variables.

13. References

- [1] Federal Communications Commission, ET Docket 93-62, Guidelines for Evaluating the Environmental Effects of Radio Frequency Radiation, August 1996
- [2] ANSI/IEEE C95.1 – 1992, American National Standard Safety Levels with respect to Human Exposure to Radio Frequency Electromagnetic Fields, 300kHz to 100GHz, New York: IEEE, 1992.
- [3] ANSI/IEEE C95.3 – 1992, IEEE Recommended Practice for the Measurement of Potentially Hazardous Electromagnetic Fields – RF and Microwave, New York: IEEE, 1992.
- [4] IEEE Standard 1528 – 2003, IEEE Recommended Practice for Determining the Peak-Spatial Average Specific Absorption Rate (SAR) in the Human Head from Wireless Communication Devices: Measurement Techniques, October 2003.
- [5] Industry Canada, RSS – 102e, Radio Frequency Exposure Compliance of Radiocommunication Apparatus (All Frequency Bands), March 2010.
- [6] Health Canada, Safety Code 6, Limits of Human Exposure to Radiofrequency Electromagnetic Fields in the Frequency Range from 3kHz to 300 GHz, 2009.

Appendix A – System Validation Plots and Data

Test Result for UIM Dielectric Parameter

Thu 18/Dec/2014

Freq Frequency(GHz)

FCC_eH Limits for Head Epsilon

FCC_sH Limits for Head Sigma

FCC_eB Limits for Body Epsilon

FCC_sB Limits for Body Sigma

Test_e Epsilon of UIM

Test_s Sigma of UIM

Freq	FCC_eB	FCC_sB	Test_e	Test_s
0.7000	55.73	0.96	55.46	0.95
0.7040	55.714	0.96	55.444	0.95*
0.7075	55.70	0.96	55.43	0.95*
0.7100	55.69	0.96	55.42	0.95
0.7110	55.686	0.96	55.415	0.951*
0.7200	55.65	0.96	55.37	0.96
0.7300	55.61	0.96	55.33	0.96
0.7400	55.57	0.96	55.29	0.97
0.7500	55.53	0.96	55.24	0.97
0.7600	55.49	0.96	55.20	0.98
0.7700	55.45	0.96	55.16	0.99
0.7800	55.41	0.97	55.11	0.99
0.7900	55.38	0.97	55.07	1.00
0.8000	55.34	0.97	55.02	1.00

* value interpolated

Test Result for UIM Dielectric Parameter

Sat 24/May/2014

Freq Frequency(GHz)

FCC_eH FCC Bulletin 65 Supplement C (June 2001) Limits for Head Epsilon

FCC_sH FCC Bulletin 65 Supplement C (June 2001) Limits for Head Sigma

FCC_eB FCC Limits for Body Epsilon

FCC_sB FCC Limits for Body Sigma

Test_e Epsilon of UIM

Test_s Sigma of UIM

Freq	FCC_eB	FCC_sB	Test_e	Test_s
0.8050	55.32	0.97	54.24	0.94
0.8150	55.28	0.97	54.28	0.95
0.8250	55.24	0.97	54.33	0.96
0.8350	55.20	0.97	54.37	0.98
0.8366	55.195	0.972	54.375	0.982*
0.8450	55.17	0.98	54.40	0.99
0.8550	55.14	0.99	54.44	1.02
0.8650	55.11	1.01	54.48	1.04

* value interpolated

Test Result for UIM Dielectric Parameter

Thu 18/Dec/2014

Freq Frequency(GHz)

FCC_eH Limits for Head Epsilon

FCC_sH Limits for Head Sigma

FCC_eB Limits for Body Epsilon

FCC_sB Limits for Body Sigma

Test_e Epsilon of UIM

Test_s Sigma of UIM

Freq	FCC_eB	FCC_sB	Test_e	Test_s
0.8050	55.32	0.97	55.07	0.96
0.8150	55.28	0.97	55.02	0.97
0.8250	55.24	0.97	54.98	0.98
0.8290	55.224	0.97	54.96	0.984*
0.8350	55.20	0.97	54.93	0.99
0.8365	55.196	0.972	54.924	0.992*
0.8440	55.173	0.979	54.894	0.999*
0.8450	55.17	0.98	54.89	1.00
0.8550	55.14	0.99	54.86	1.02
0.8650	55.11	1.01	54.83	1.03

* value interpolated

Test Result for UIM Dielectric Parameter

Fri 23/May/2014

Freq Frequency(GHz)

FCC_eH FCC Bulletin 65 Supplement C (June 2001) Limits for Head Epsilon

FCC_sH FCC Bulletin 65 Supplement C (June 2001) Limits for Head Sigma

FCC_eB FCC Limits for Body Epsilon

FCC_sB FCC Limits for Body Sigma

Test_e Epsilon of UIM

Test_s Sigma of UIM

Freq	FCC_eB	FCC_sB	Test_e	Test_s
1.6900	53.59	1.45	52.89	1.51
1.7000	53.56	1.46	52.85	1.52
1.7100	53.54	1.46	52.81	1.53
1.7200	53.51	1.47	52.78	1.54
1.7300	53.48	1.48	52.74	1.55
1.7325	53.475	1.48	52.73	1.55*
1.7400	53.46	1.48	52.70	1.55
1.7450	53.445	1.485	52.69	1.555*
1.7500	53.43	1.49	52.68	1.56
1.7600	53.41	1.49	52.66	1.56
1.7700	53.38	1.50	52.65	1.57
1.7800	53.35	1.51	52.61	1.58
1.7900	53.33	1.51	52.58	1.59

* value interpolated

Test Result for UIM Dielectric Parameter

Thu 22/May/2014

Freq Frequency(GHz)

FCC_eH FCC Bulletin 65 Supplement C (June 2001) Limits for Head Epsilon

FCC_sH FCC Bulletin 65 Supplement C (June 2001) Limits for Head Sigma

FCC_eB FCC Limits for Body Epsilon

FCC_sB FCC Limits for Body Sigma

Test_e Epsilon of UIM

Test_s Sigma of UIM

Freq	FCC_eB	FCC_sB	Test_e	Test_s
1.8500	53.30	1.52	53.27	1.49
1.8502	53.30	1.52	53.27	1.49*
1.8513	53.30	1.52	53.267	1.491*
1.8524	53.30	1.52	53.265	1.492*
1.8525	53.30	1.52	53.265	1.493*
1.8600	53.30	1.52	53.25	1.50
1.8700	53.30	1.52	53.23	1.51
1.8800	53.30	1.52	53.21	1.52
1.8900	53.30	1.52	53.19	1.53
1.9000	53.30	1.52	53.17	1.54
1.9075	53.30	1.52	53.155	1.548*
1.9076	53.30	1.52	53.155	1.548*
1.9088	53.30	1.52	53.152	1.549*
1.9098	53.30	1.52	53.15	1.55*
1.9100	53.30	1.52	53.15	1.55
1.9200	53.30	1.52	53.14	1.57
1.9300	53.30	1.52	53.12	1.58

* value interpolated

Test Result for UIM Dielectric Parameter

Tue 17/Feb/2015

Freq Frequency(GHz)

FCC_eH Limits for Head Epsilon

FCC_sH Limits for Head Sigma

FCC_eB Limits for Body Epsilon

FCC_sB Limits for Body Sigma

Test_e Epsilon of UIM

Test_s Sigma of UIM

Freq	FCC_eB	FCC_sB	Test_e	Test_s
2.4100	52.75	1.91	52.61	1.92
2.4120	52.748	1.912	52.606	1.922*
2.4200	52.74	1.92	52.59	1.93
2.4300	52.73	1.93	52.57	1.94
2.4370	52.716	1.937	52.556	1.947*
2.4400	52.71	1.94	52.55	1.95
2.4500	52.70	1.95	52.53	1.96
2.4600	52.69	1.96	52.51	1.98
2.4620	52.686	1.964	52.508	1.982*
2.4700	52.67	1.98	52.50	1.99
2.4800	52.66	1.99	52.48	2.00

* value interpolated

Test Result for UIM Dielectric Parameter

Sat 31/May/2014

Freq Frequency(GHz)

FCC_eH FCC Bulletin 65 Supplement C (June 2001) Limits for Head Epsilon

FCC_sH FCC Bulletin 65 Supplement C (June 2001) Limits for Head Sigma

FCC_eB FCC Limits for Body Epsilon

FCC_sB FCC Limits for Body Sigma

Test_e Epsilon of UIM

Test_s Sigma of UIM

Freq	FCC_eB	FCC_sB	Test_e	Test_s
5.1000	49.15	5.18	49.22	5.10
5.1200	49.12	5.21	49.19	5.12
5.1400	49.10	5.23	49.16	5.14
5.1600	49.07	5.25	49.13	5.16
5.1800	49.04	5.28	49.10	5.19
5.2000	49.01	5.30	49.07	5.21
5.2200	48.99	5.32	49.04	5.23
5.2400	48.96	5.35	49.01	5.25
5.2600	48.93	5.37	48.98	5.28
5.2800	48.91	5.39	48.95	5.31
5.7200	48.31	5.91	48.29	5.89
5.7400	48.28	5.93	48.26	5.91
5.7450	48.273	5.935	48.253	5.918*
5.7600	48.25	5.95	48.23	5.94
5.7800	48.23	5.98	48.20	5.97
5.7850	48.223	5.985	48.193	5.975*
5.8000	48.20	6.00	48.17	5.99
5.8200	48.17	6.02	48.14	6.02
5.8250	48.165	6.028	48.133	6.025*
5.8400	48.15	6.05	48.11	6.04

* value interpolated

RF Exposure Lab

Plot 1

DUT: Dipole 750 MHz D750V3; Type: D750V3; Serial: D750V3 - SN:1016

Communication System: CW; Frequency: 750 MHz; Duty Cycle: 1:1
Medium: MSL750; Medium parameters used: $f = 750 \text{ MHz}$; $\sigma = 0.94 \text{ S/m}$; $\epsilon_r = 54.69$; $\rho = 1000 \text{ kg/m}^3$
Phantom section: Flat Section

Test Date: Date: 5/27/2014; Ambient Temp: 23 °C; Tissue Temp: 21 °C

Probe: EX3DV4 - SN3693; ConvF(8.67, 8.67, 8.67); Calibrated: 8/27/2013;
Sensor-Surface: 2mm (Mechanical Surface Detection)
Electronics: DAE4 Sn759; Calibrated: 8/15/2013
Phantom: ELI v4.0; Type: QDOVA001BB; Serial: TP:1065
Measurement SW: DASY52, Version 52.8 (7); SEMCAD X Version 14.6.10 (7164)

Procedure Notes:

750 MHz/Verification/Area Scan (5x11x1): Measurement grid: dx=15mm, dy=15mm
Maximum value of SAR (measured) = 1.08 W/kg

750 MHz/Verification/Zoom Scan (5x5x7)/Cube 0: Measurement grid: dx=8mm, dy=8mm, dz=5mm
Reference Value = 31.227 V/m; Power Drift = 0.02 dB
Peak SAR (extrapolated) = 1.30 W/kg
SAR(1 g) = 0.865 W/kg; SAR(10 g) = 0.569 W/kg
Maximum value of SAR (measured) = 1.10 W/kg

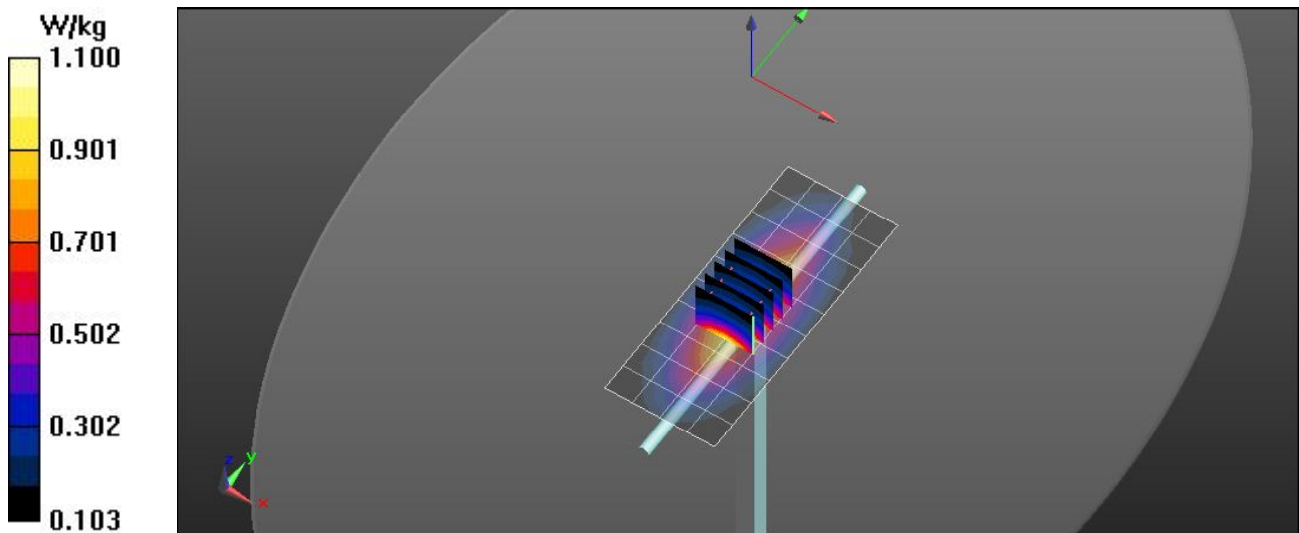

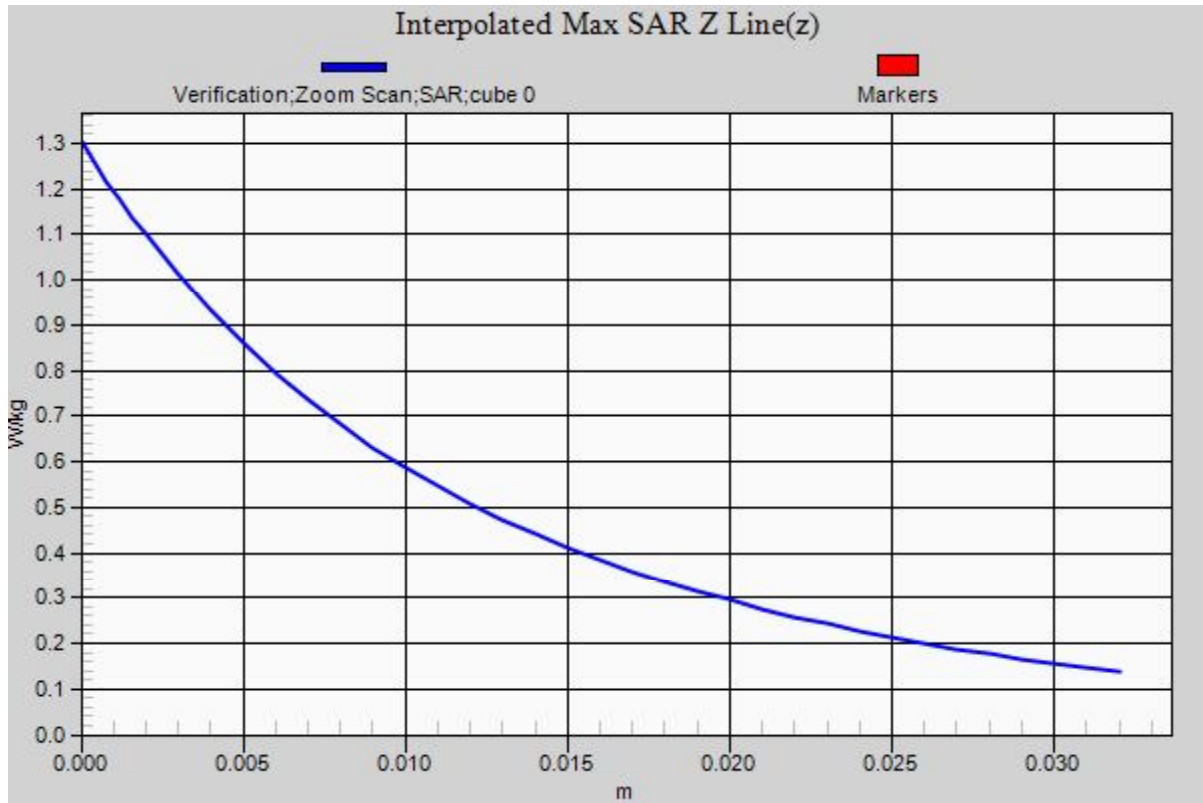

RF Exposure Lab

Plot 2

DUT: Dipole 835 MHz D835V2; Type: D835V2; Serial: D835V2 - SN:4d089

Communication System: CW; Frequency: 835 MHz; Duty Cycle: 1:1
Medium: MSL835; Medium parameters used: $f = 835 \text{ MHz}$; $\sigma = 0.98 \text{ S/m}$; $\epsilon_r = 54.37$; $\rho = 1000 \text{ kg/m}^3$
Phantom section: Flat Section

Test Date: Date: 5/24/2014; Ambient Temp: 23 °C; Tissue Temp: 21 °C

Probe: EX3DV4 - SN3693; ConvF(8.66, 8.66, 8.66); Calibrated: 8/27/2013;
Sensor-Surface: 2mm (Mechanical Surface Detection)
Electronics: DAE4 Sn759; Calibrated: 8/15/2013
Phantom: ELI v4.0; Type: QDOVA001BB; Serial: TP:1065
Measurement SW: DASY52, Version 52.8 (7); SEMCAD X Version 14.6.10 (7164)

Procedure Notes:

835 MHz/Verification/Area Scan (5x11x1): Measurement grid: $dx=15\text{mm}$, $dy=15\text{mm}$
Maximum value of SAR (measured) = 1.18 W/kg

835 MHz/Verification/Zoom Scan (5x5x7)/Cube 0: Measurement grid: $dx=8\text{mm}$, $dy=8\text{mm}$, $dz=5\text{mm}$
Reference Value = 31.227 V/m; Power Drift = -0.01 dB
Peak SAR (extrapolated) = 1.47 W/kg
SAR(1 g) = 0.943 W/kg; SAR(10 g) = 0.619 W/kg

Info: Interpolated medium parameters used for SAR evaluation.
Maximum value of SAR (measured) = 1.19 W/kg

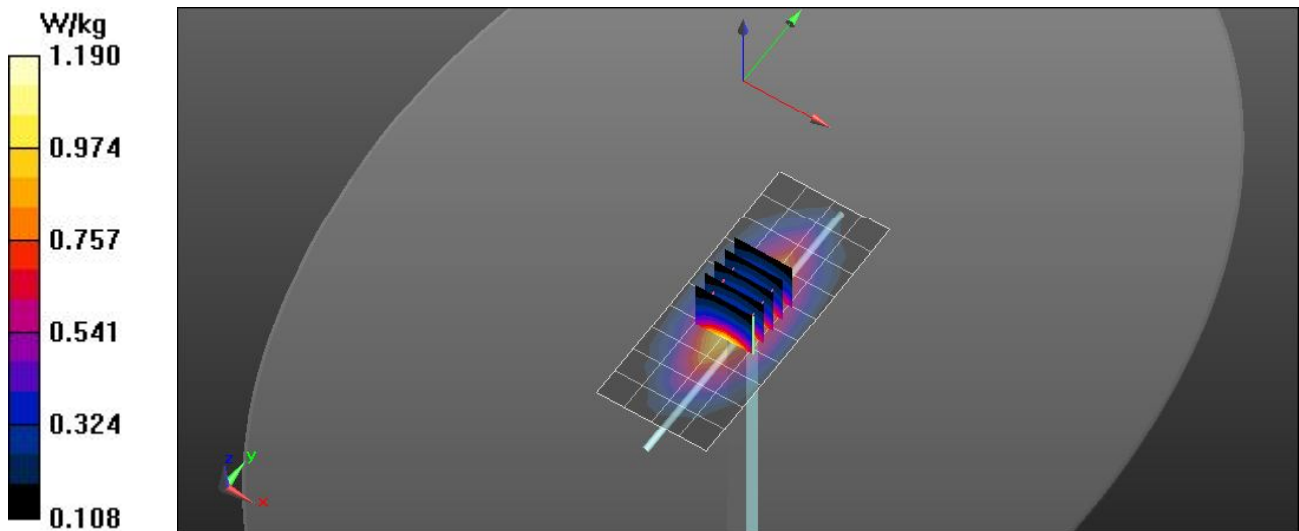

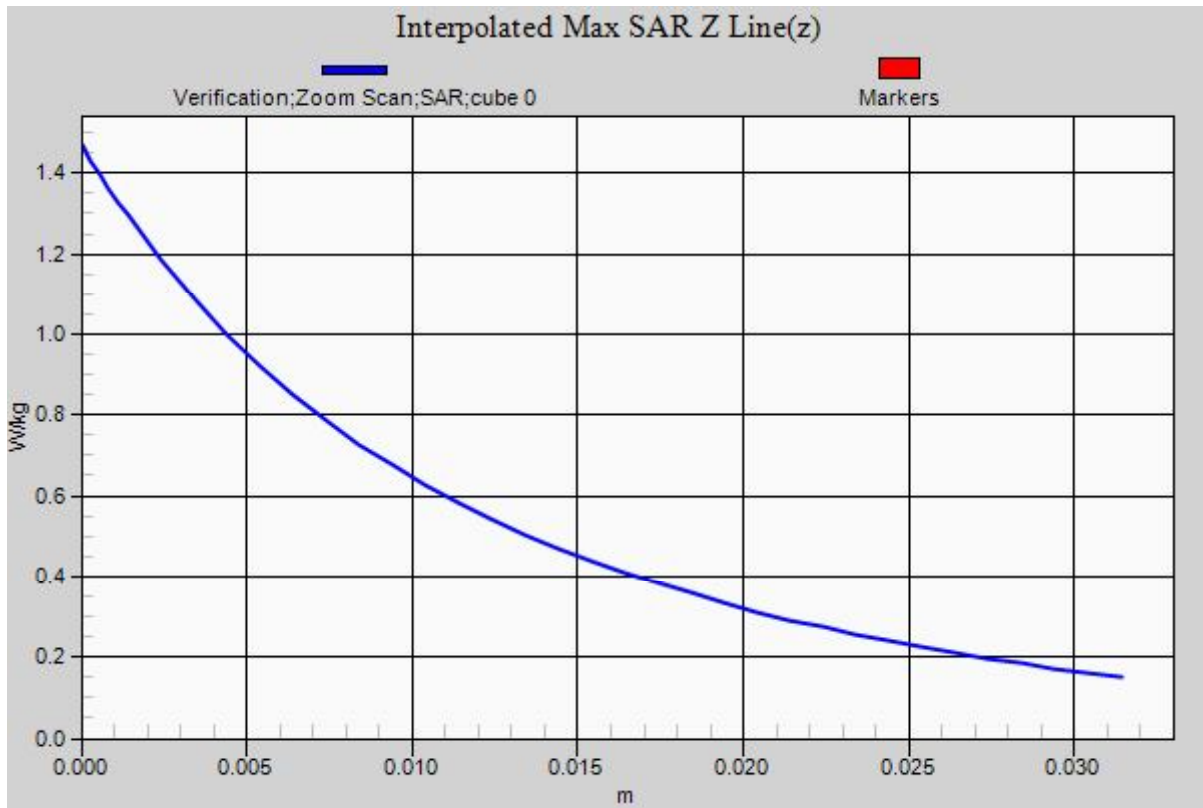

RF Exposure Lab

Plot 3

DUT: Dipole 1750 MHz D1750V2; Type: D1750V2; Serial: D1750V2 - SN:1018

Communication System: CW; Frequency: 1750 MHz; Duty Cycle: 1:1
Medium: MSL1750; Medium parameters used: $f = 1750$ MHz; $\sigma = 1.56$ S/m; $\epsilon_r = 52.68$; $\rho = 1000$ kg/m³
Phantom section: Flat Section

Test Date: Date: 5/23/2014; Ambient Temp: 23 °C; Tissue Temp: 21 °C

Probe: EX3DV4 - SN3693; ConvF(7.35, 7.35, 7.35); Calibrated: 8/27/2013;
Sensor-Surface: 2mm (Mechanical Surface Detection)
Electronics: DAE4 Sn759; Calibrated: 8/15/2013
Phantom: ELI v4.0; Type: QDOVA001BB; Serial: TP:1065
Measurement SW: DASY52, Version 52.8 (7); SEMCAD X Version 14.6.10 (7164)

Procedure Notes:

1750 MHz/Verification/Area Scan (5x7x1): Measurement grid: dx=15mm, dy=15mm
Maximum value of SAR (measured) = 5.33 W/kg

1750 MHz/Verification/Zoom Scan (5x5x7)/Cube 0: Measurement grid: dx=8mm, dy=8mm, dz=5mm
Reference Value = 31.227 V/m; Power Drift = -0.01 dB
Peak SAR (extrapolated) = 6.89 W/kg
SAR(1 g) = 3.85 W/kg; SAR(10 g) = 2.03 W/kg
Maximum value of SAR (measured) = 5.49 W/kg

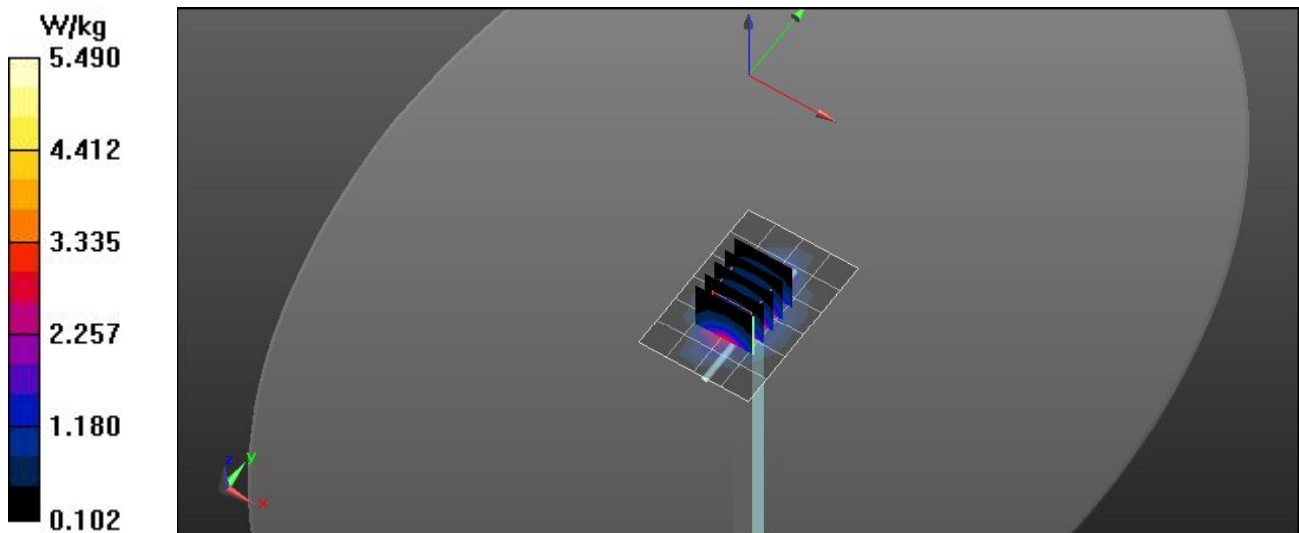

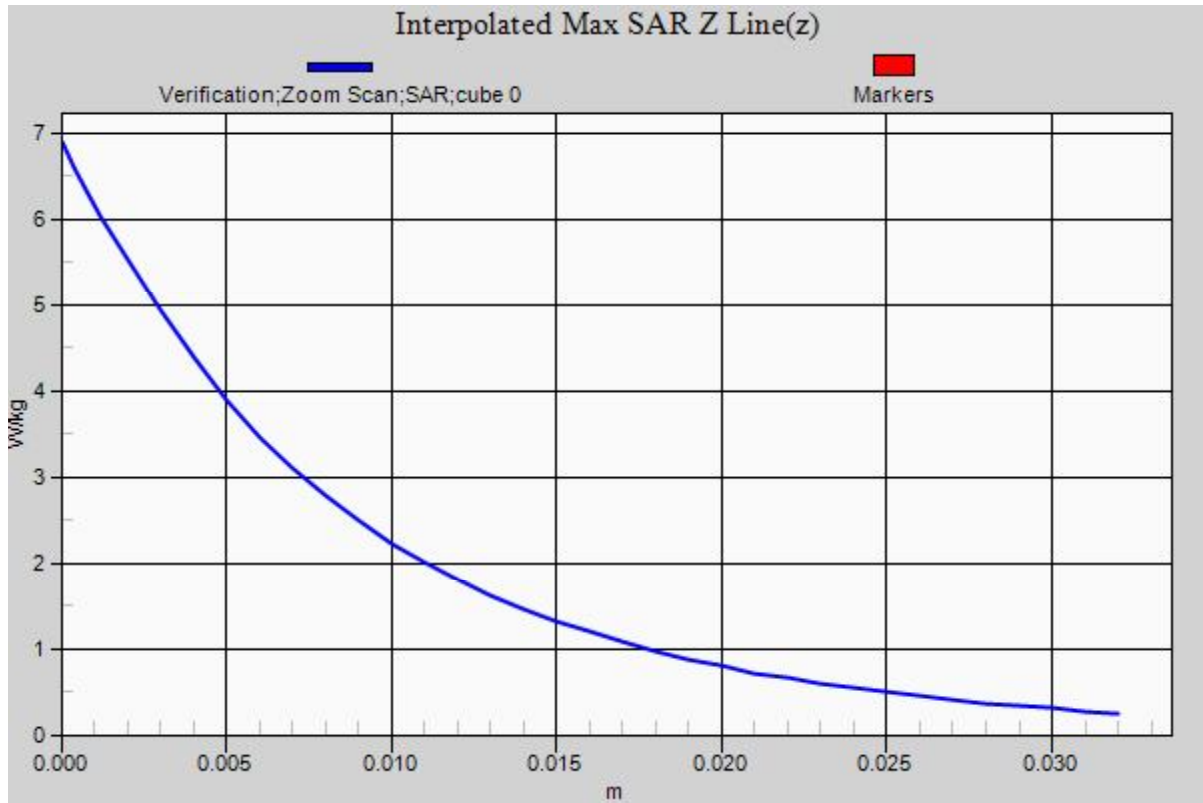

RF Exposure Lab

Plot 4

DUT: Dipole 1900 MHz D1900V2; Type: D1900V2; Serial: D1900V2 - SN:5d116

Communication System: CW; Frequency: 1900 MHz; Duty Cycle: 1:1
Medium: MSL1900; Medium parameters used: $f = 1900$ MHz; $\sigma = 1.54$ S/m; $\epsilon_r = 53.17$; $\rho = 1000$ kg/m³
Phantom section: Flat Section

Test Date: Date: 5/25/2014; Ambient Temp: 23 °C; Tissue Temp: 21 °C

Probe: EX3DV4 - SN3693; ConvF(7.1, 7.1, 7.1); Calibrated: 8/27/2013;
Sensor-Surface: 2mm (Mechanical Surface Detection)
Electronics: DAE4 Sn759; Calibrated: 8/15/2013
Phantom: ELI v4.0; Type: QDOVA001BB; Serial: TP:1065
Measurement SW: DASY52, Version 52.8 (7); SEMCAD X Version 14.6.10 (7164)

Procedure Notes:

1900 MHz/Verification/Area Scan (5x7x1): Measurement grid: dx=15mm, dy=15mm
Maximum value of SAR (measured) = 5.44 W/kg

1900 MHz/Verification/Zoom Scan (5x5x7)/Cube 0: Measurement grid: dx=8mm, dy=8mm, dz=5mm
Reference Value = 31.227 V/m; Power Drift = -0.01 dB
Peak SAR (extrapolated) = 7.22 W/kg
SAR(1 g) = 4.02 W/kg; SAR(10 g) = 2.1 W/kg
Maximum value of SAR (measured) = 5.77 W/kg

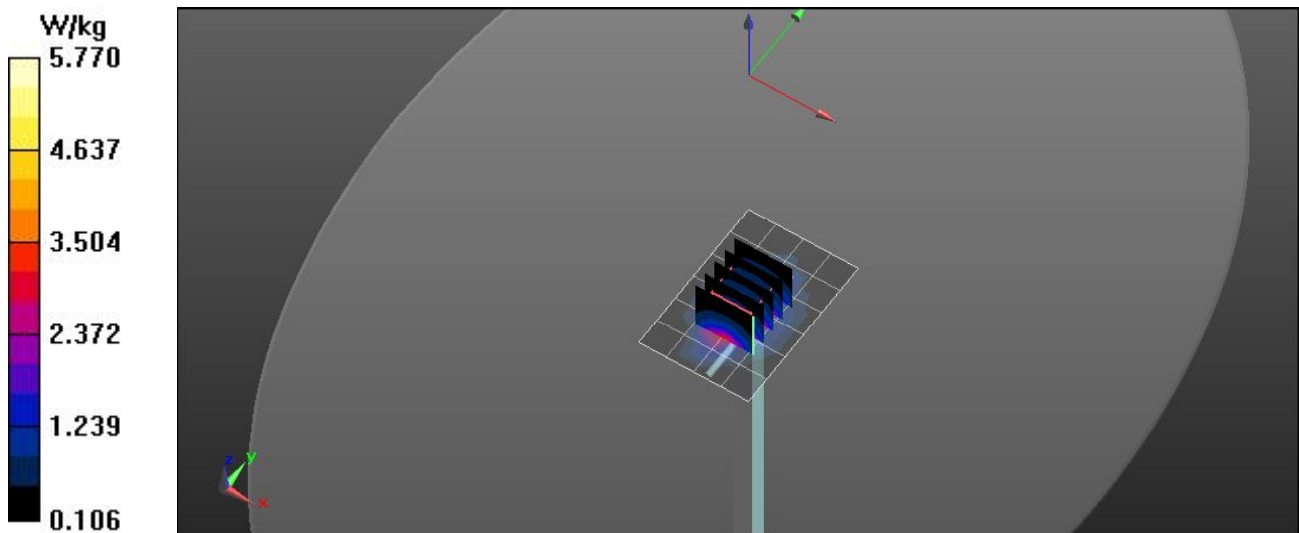

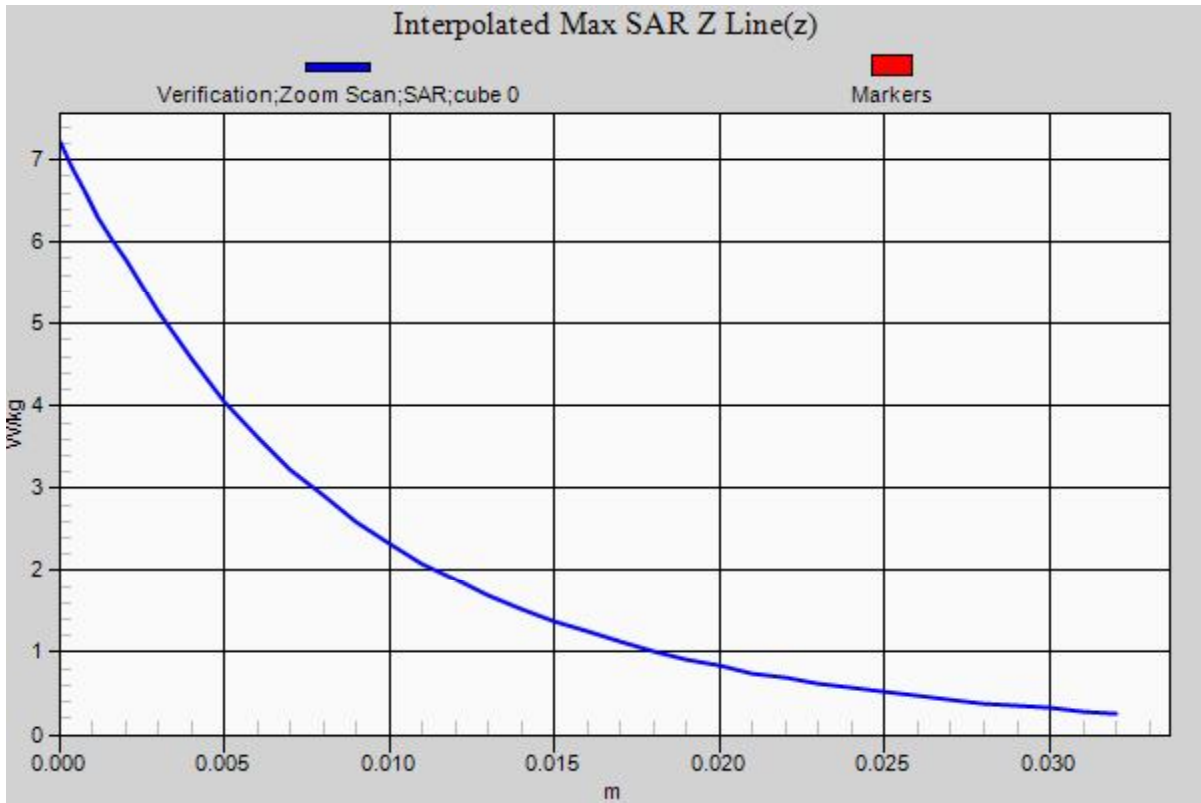

RF Exposure Lab

Plot 5

DUT: Dipole 2450 MHz D2450V2; Type: D2450V2; Serial: D2450V2 - SN: 829

Communication System: CW; Frequency: 2450 MHz; Duty Cycle: 1:1
 Medium: MSL2450; Medium parameters used: $f = 2450 \text{ MHz}$; $\sigma = 1.96 \text{ S/m}$; $\epsilon_r = 52.53$; $\rho = 1000 \text{ kg/m}^3$
 Phantom section: Flat Section

Test Date: Date: 2/17/2015; Ambient Temp: 23 °C; Tissue Temp: 21 °C
 Probe: EX3DV4 - SN3662; ConvF(7.12, 7.12, 7.12); Calibrated: 4/15/2014;
 Sensor-Surface: 2mm (Mechanical Surface Detection)
 Electronics: DAE4 Sn759; Calibrated: 8/12/2014
 Phantom: ELI v4.0; Type: QDOVA001BB; Serial: 1251
 Measurement SW: DASY52, Version 52.8 (8); SEMCAD X Version 14.6.10 (7331)

Procedure Notes:

Body Verification/2450 MHz/Area Scan (61x101x1): Interpolated grid: $dx=1.200 \text{ mm}$, $dy=1.200 \text{ mm}$
 Maximum value of SAR (interpolated) = 8.95 W/kg

Body Verification/2450 MHz/Zoom Scan (7x7x7)/Cube 0: Measurement grid: $dx=5\text{mm}$, $dy=5\text{mm}$, $dz=5\text{mm}$
 Reference Value = 53.597 V/m; Power Drift = -0.01 dB
 Peak SAR (extrapolated) = 11.18 W/kg
 $P_{in} = 100 \text{ mW}$
SAR(1 g) = 5.22 W/kg; SAR(10 g) = 2.4 W/kg
 Maximum value of SAR (measured) = 8.71 W/kg

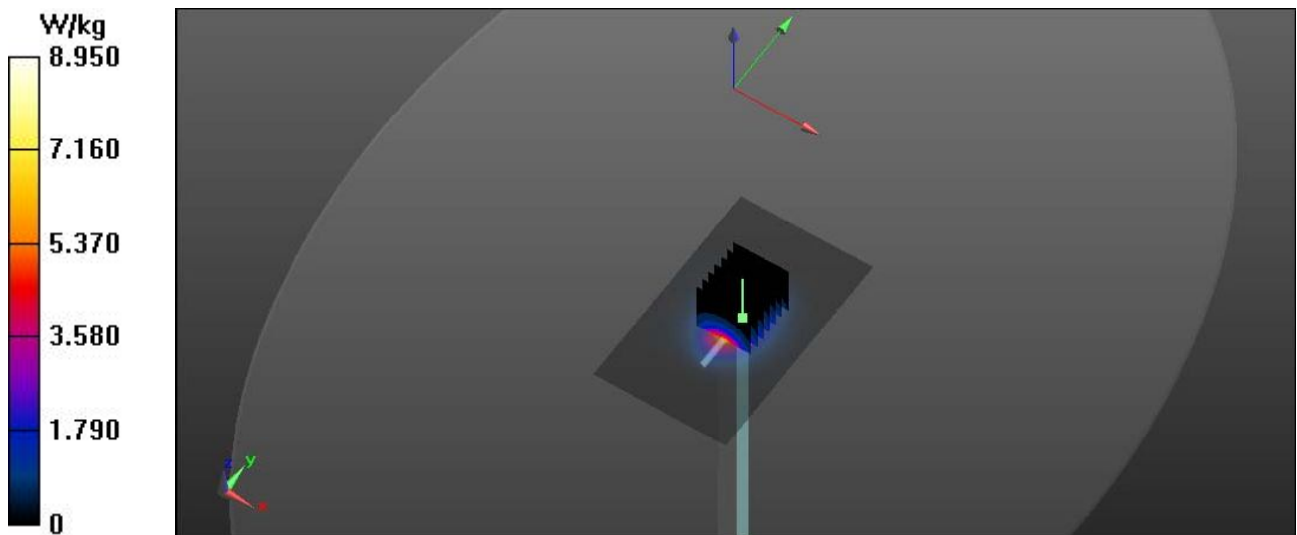

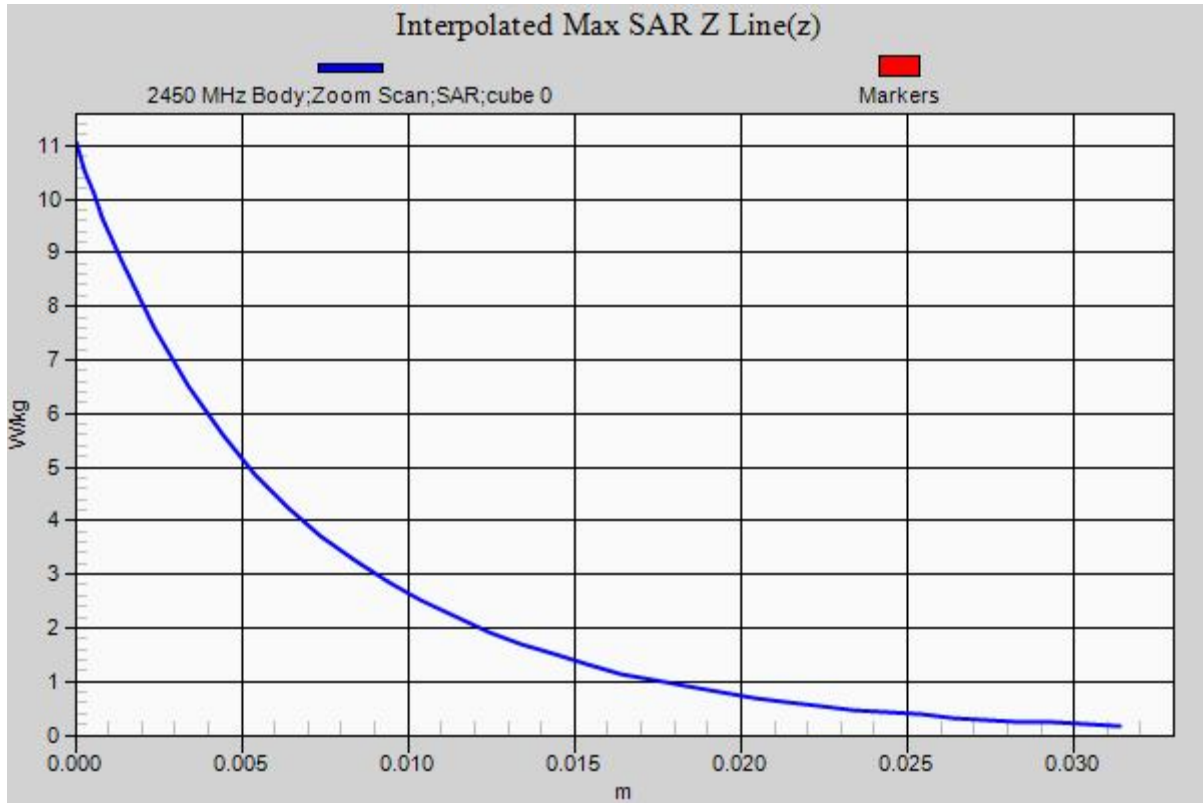

RF Exposure Lab

Plot 6

DUT: Dipole D5GHzV2; Type: D5GHzV2; Serial: D5GHzV2 - SN:1085

Communication System: CW; Frequency: 5200 MHz; Duty Cycle: 1:1
 Medium: MSL 3-6 GHz; Medium parameters used: $f = 5200$ MHz; $\sigma = 5.21$ S/m; $\epsilon_r = 49.07$; $\rho = 1000$ kg/m³
 Phantom section: Flat Section

Test Date: Date: 5/31/2014; Ambient Temp: 23 °C; Tissue Temp: 21 °C
 Probe: EX3DV4 - SN3693; ConvF(4.39, 4.39, 4.39); Calibrated: 8/27/2013;
 Sensor-Surface: 2mm (Mechanical Surface Detection)
 Electronics: DAE4 Sn759; Calibrated: 8/15/2013
 Phantom: ELI v4.0; Type: QDOVA001BB; Serial: TP:1065
 Measurement SW: DASY52, Version 52.8 (7); SEMCAD X Version 14.6.10 (7164)

Procedure Notes:

5200 MHz Body/Verification/Area Scan (7x9x1): Measurement grid: dx=10mm, dy=10mm
 Maximum value of SAR (measured) = 1.58 W/kg

5200 MHz Body/Verification/Zoom Scan (7x7x12)/Cube 0: Measurement grid: dx=4mm, dy=4mm, dz=2mm
 Reference Value = 11.705 V/m; Power Drift = 0.01 dB
 Peak SAR (extrapolated) = 3.75 W/kg
SAR(1 g) = 0.763 W/kg; SAR(10 g) = 0.211 W/kg
 Maximum value of SAR (measured) = 1.65 W/kg

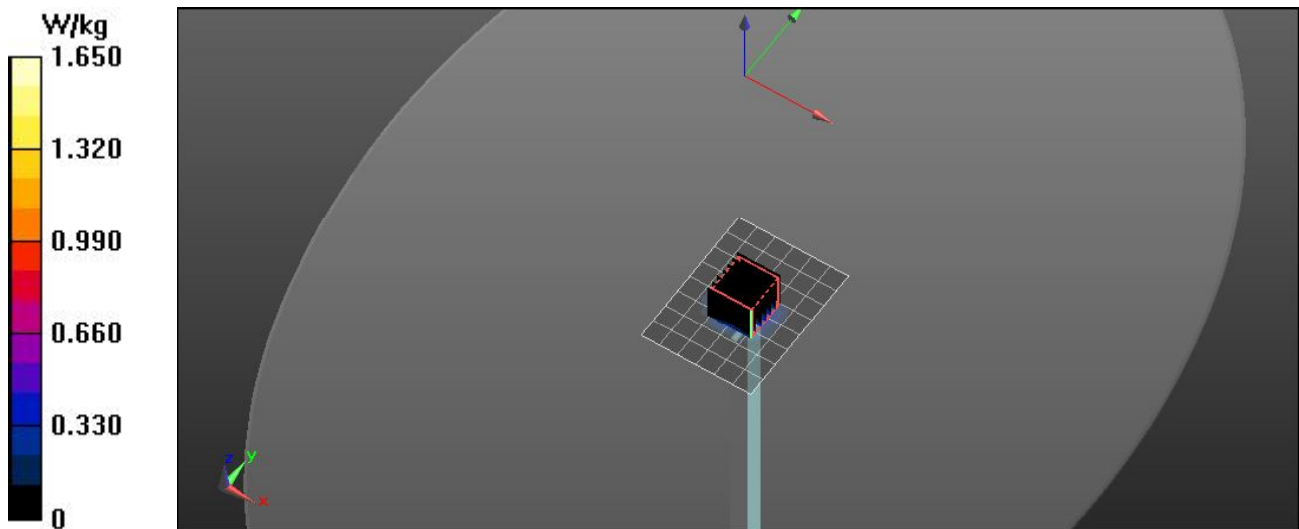

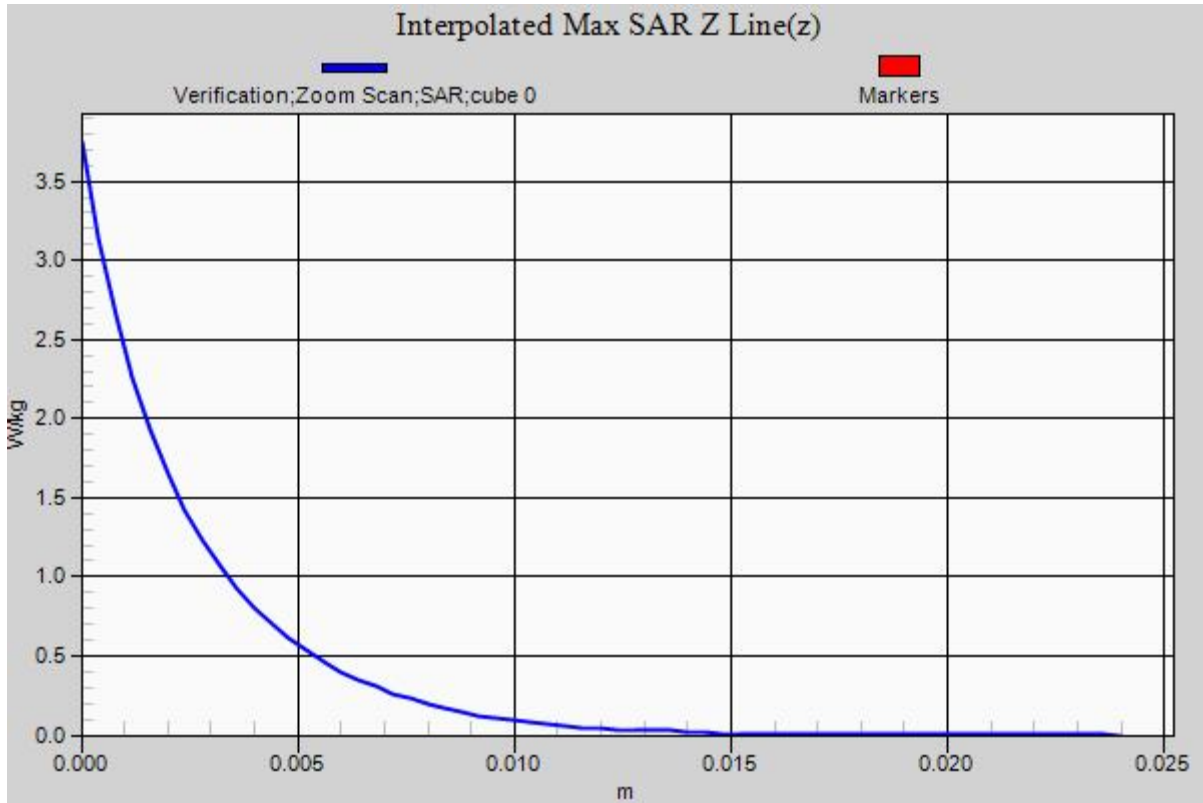

RF Exposure Lab

Plot 7

DUT: Dipole D5GHzV2; Type: D5GHzV2; Serial: D5GHzV2 - SN:1085

Communication System: CW; Frequency: 5800 MHz; Duty Cycle: 1:1
 Medium: MSL 3-6 GHz; Medium parameters used: $f = 5800$ MHz; $\sigma = 5.99$ S/m; $\epsilon_r = 48.17$; $\rho = 1000$ kg/m³
 Phantom section: Flat Section

Test Date: Date: 5/31/2014; Ambient Temp: 23 °C; Tissue Temp: 21 °C
 Probe: EX3DV4 - SN3693; ConvF(4.04, 4.04, 4.04); Calibrated: 8/27/2013;
 Sensor-Surface: 2mm (Mechanical Surface Detection)
 Electronics: DAE4 Sn759; Calibrated: 8/15/2013
 Phantom: ELI v4.0; Type: QDOVA001BB; Serial: TP:1065
 Measurement SW: DASY52, Version 52.8 (7); SEMCAD X Version 14.6.10 (7164)

Procedure Notes:

5800 MHz Body/Verification/Area Scan (7x9x1): Measurement grid: dx=10mm, dy=10mm
 Maximum value of SAR (measured) = 1.56 W/kg

5800 MHz Body/Verification/Zoom Scan (7x7x12)/Cube 0: Measurement grid: dx=4mm, dy=4mm, dz=2mm
 Reference Value = 11.621 V/m; Power Drift = -0.01 dB
 Peak SAR (extrapolated) = 3.47 W/kg
SAR(1 g) = 0.749 W/kg; SAR(10 g) = 0.208 W/kg
 Maximum value of SAR (measured) = 1.63 W/kg

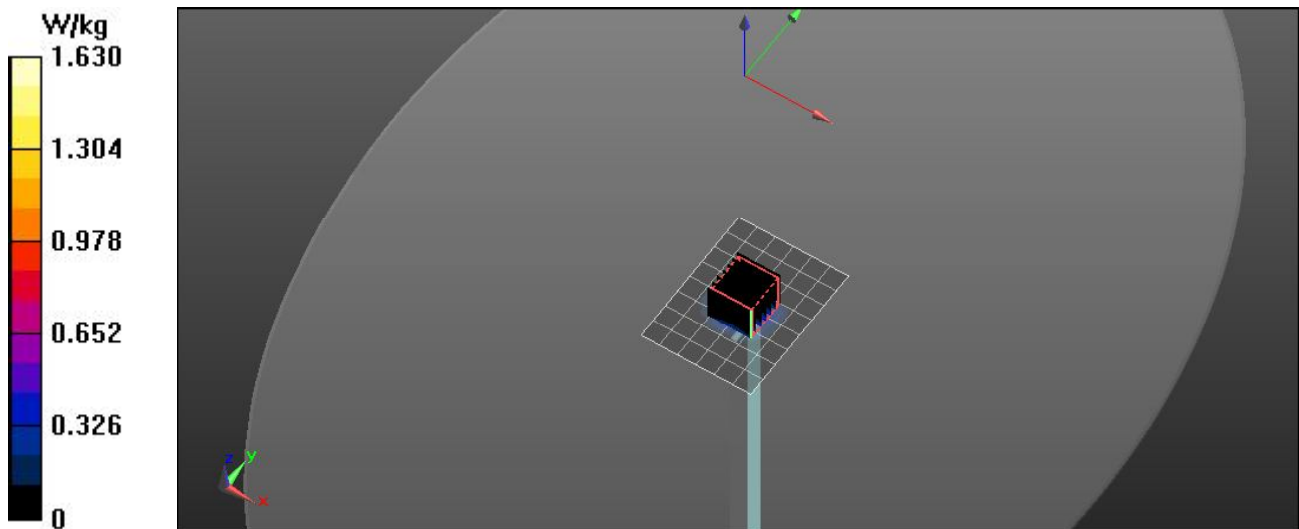

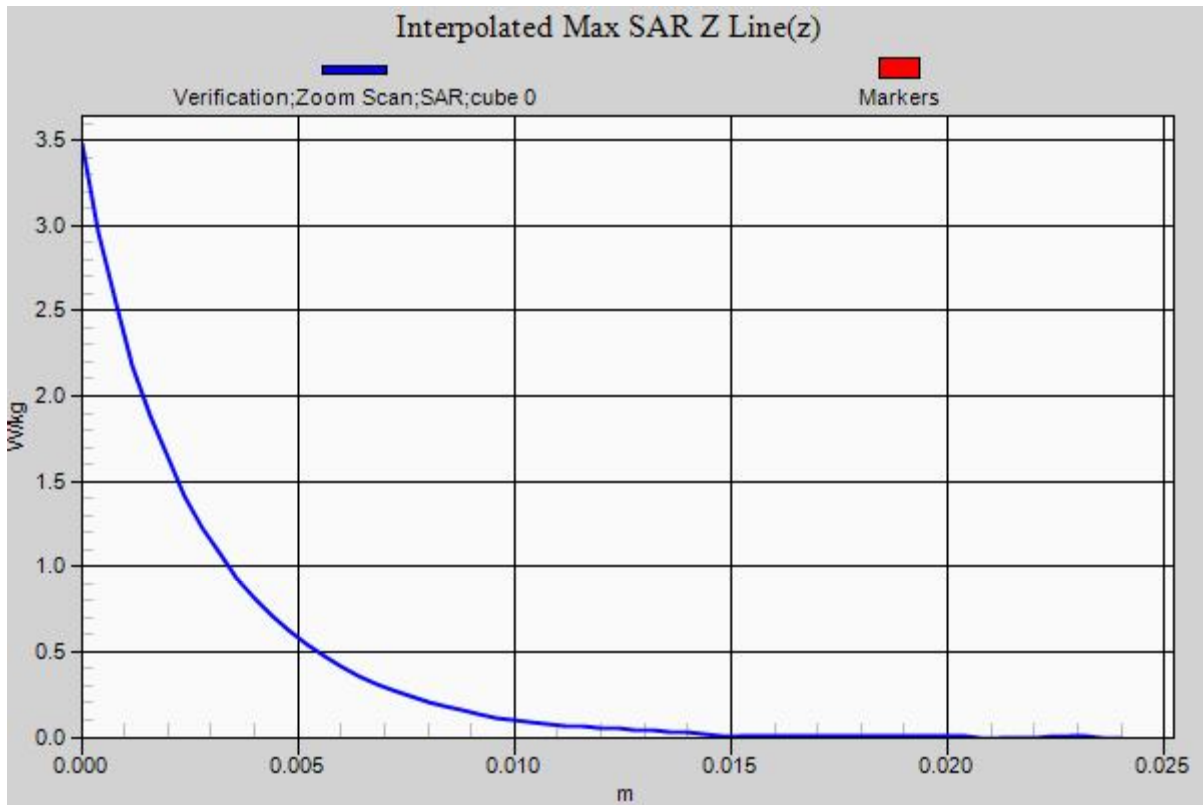

RF Exposure Lab

Plot 8

DUT: Dipole 750 MHz D750V3; Type: D750V3; Serial: D750V3 - SN:1016

Communication System: CW; Frequency: 750 MHz; Duty Cycle: 1:1
Medium: MSL750; Medium parameters used: $f = 750$ MHz; $\sigma = 0.97$ S/m; $\epsilon_r = 55.24$; $\rho = 1000$ kg/m³
Phantom section: Flat Section

Test Date: Date: 12/18/2014; Ambient Temp: 23 °C; Tissue Temp: 21 °C

Probe: EX3DV4 - SN3662; ConvF(9.42, 9.42, 9.42); Calibrated: 4/15/2014;
Sensor-Surface: 2mm (Mechanical Surface Detection)
Electronics: DAE4 Sn1416; Calibrated: 1/13/2014
Phantom: ELI v4.0; Type: QDOVA001BB; Serial: 1065
Measurement SW: DASY52, Version 52.8 (8); SEMCAD X Version 14.6.10 (7331)

Procedure Notes:

750 MHz/Verification/Area Scan (5x11x1): Measurement grid: dx=15mm, dy=15mm
Maximum value of SAR (measured) = 1.13 W/kg

750 MHz/Verification/Zoom Scan (5x5x7)/Cube 0: Measurement grid: dx=8mm, dy=8mm, dz=5mm
Reference Value = 32.026 V/m; Power Drift = -0.01 dB
Peak SAR (extrapolated) = 1.32 W/kg
SAR(1 g) = 0.881 W/kg; SAR(10 g) = 0.583 W/kg
Maximum value of SAR (measured) = 1.11 W/kg

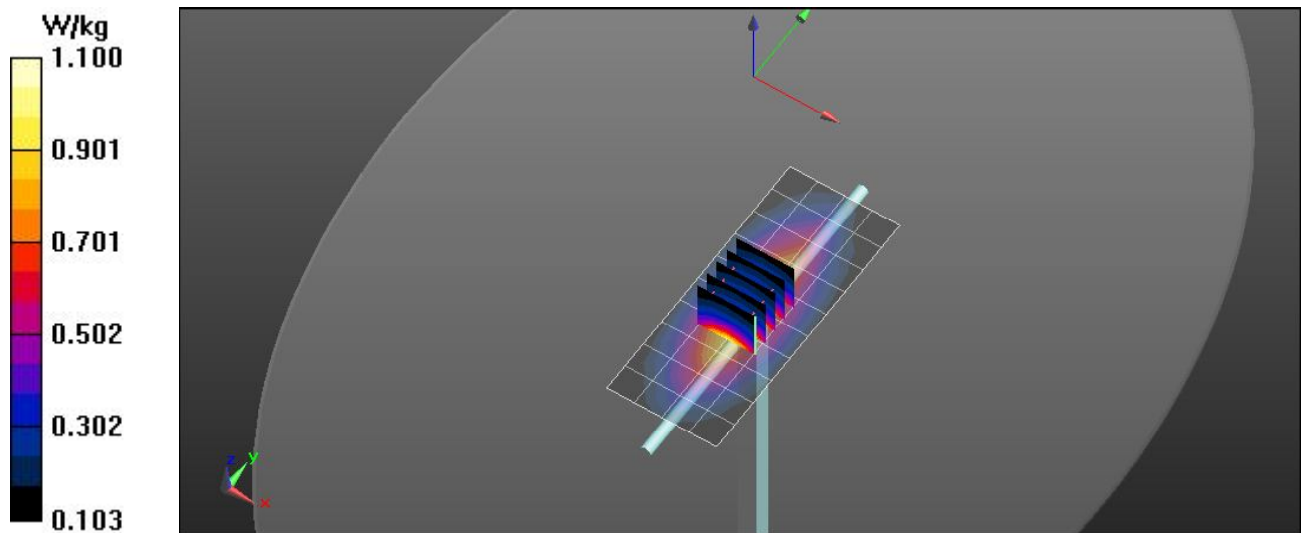

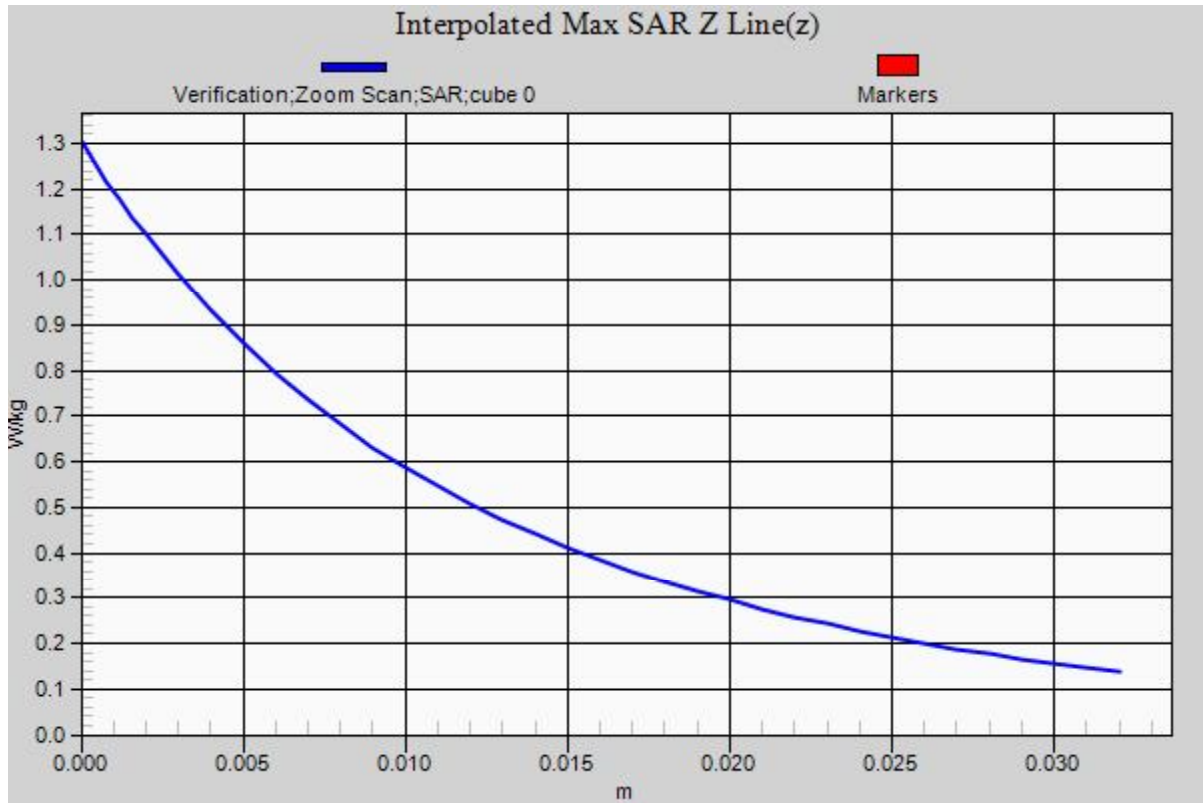

RF Exposure Lab

Plot 9

DUT: Dipole 835 MHz D835V2; Type: D835V2; Serial: D835V2 - SN:4d089

Communication System: CW; Frequency: 835 MHz; Duty Cycle: 1:1
Medium: MSL835; Medium parameters used: $f = 835 \text{ MHz}$; $\sigma = 0.99 \text{ S/m}$; $\epsilon_r = 54.93$; $\rho = 1000 \text{ kg/m}^3$
Phantom section: Flat Section

Test Date: Date: 12/18/2014; Ambient Temp: 23 °C; Tissue Temp: 21 °C

Probe: EX3DV4 - SN3662; ConvF(9.3, 9.3, 9.3); Calibrated: 4/15/2014;
Sensor-Surface: 2mm (Mechanical Surface Detection)
Electronics: DAE4 Sn1416; Calibrated: 1/13/2014
Phantom: ELI v4.0; Type: QDOVA001BB; Serial: 1065
Measurement SW: DASY52, Version 52.8 (8); SEMCAD X Version 14.6.10 (7331)

Procedure Notes:

835 MHz/Verification/Area Scan (5x11x1): Measurement grid: dx=15mm, dy=15mm
Maximum value of SAR (measured) = 1.19 W/kg

835 MHz/Verification/Zoom Scan (5x5x7)/Cube 0: Measurement grid: dx=8mm, dy=8mm, dz=5mm
Reference Value = 31.468 V/m; Power Drift = -0.02 dB
Peak SAR (extrapolated) = 1.48 W/kg
SAR(1 g) = 0.951 W/kg; SAR(10 g) = 0.625 W/kg

Info: Interpolated medium parameters used for SAR evaluation.
Maximum value of SAR (measured) = 1.20 W/kg

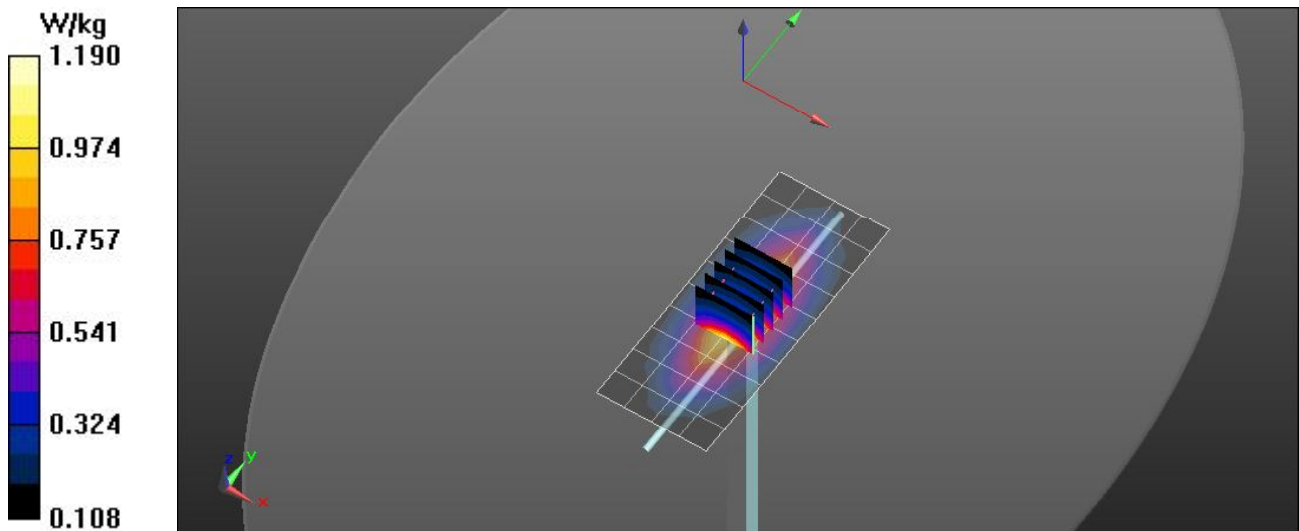

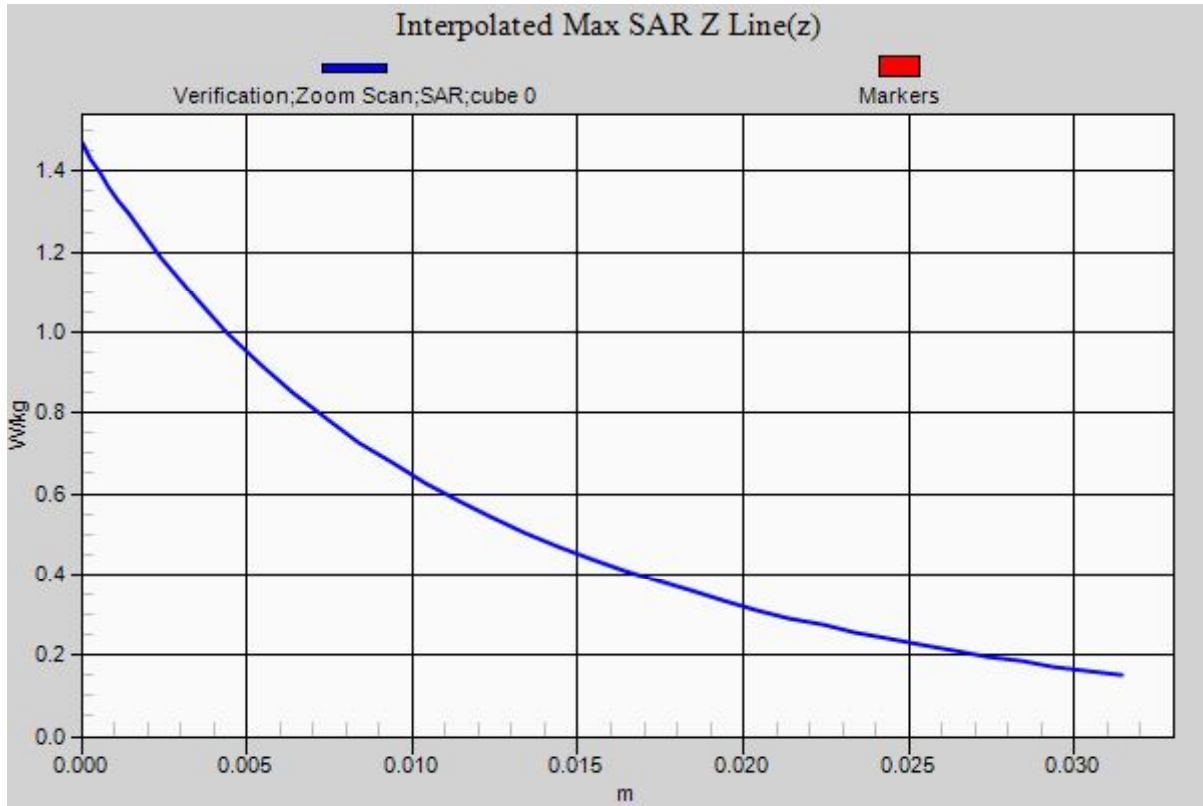

Appendix B – SAR Test Data Plots

RF Exposure Lab

Plot 1

DUT: MiFi 6620; Type: Hotspot; Serial: SS220414800535

Communication System: UMTS (WCDMA); Frequency: 836.6 MHz; Duty Cycle: 1:1
Medium: MSL835; Medium parameters used (interpolated): $f = 836.6$ MHz; $\sigma = 0.982$ S/m; $\epsilon_r = 54.375$; $\rho = 1000$ kg/m³
Phantom section: Flat Section

Test Date: Date: 5/24/2014; Ambient Temp: 23 °C; Tissue Temp: 21 °C

Probe: EX3DV4 - SN3693; ConvF(8.66, 8.66, 8.66); Calibrated: 8/27/2013;
Sensor-Surface: 2mm (Mechanical Surface Detection)
Electronics: DAE4 Sn759; Calibrated: 8/15/2013
Phantom: ELI v4.0; Type: QDOVA001BB; Serial: TP:1065
Measurement SW: DASY52, Version 52.8 (7); SEMCAD X Version 14.6.10 (7164)

Procedure Notes:

835 MHz WCDMA/Top Mid/Area Scan (7x9x1): Measurement grid: dx=15mm, dy=15mm

Info: Interpolated medium parameters used for SAR evaluation.
Maximum value of SAR (measured) = 0.810 W/kg

835 MHz WCDMA/Top Mid/Zoom Scan (5x5x7)/Cube 0: Measurement grid: dx=8mm, dy=8mm, dz=5mm

Reference Value = 21.489 V/m; Power Drift = -0.01 dB

Peak SAR (extrapolated) = 1.07 W/kg

SAR(1 g) = 0.679 W/kg; SAR(10 g) = 0.447 W/kg

Info: Interpolated medium parameters used for SAR evaluation.
Maximum value of SAR (measured) = 0.873 W/kg

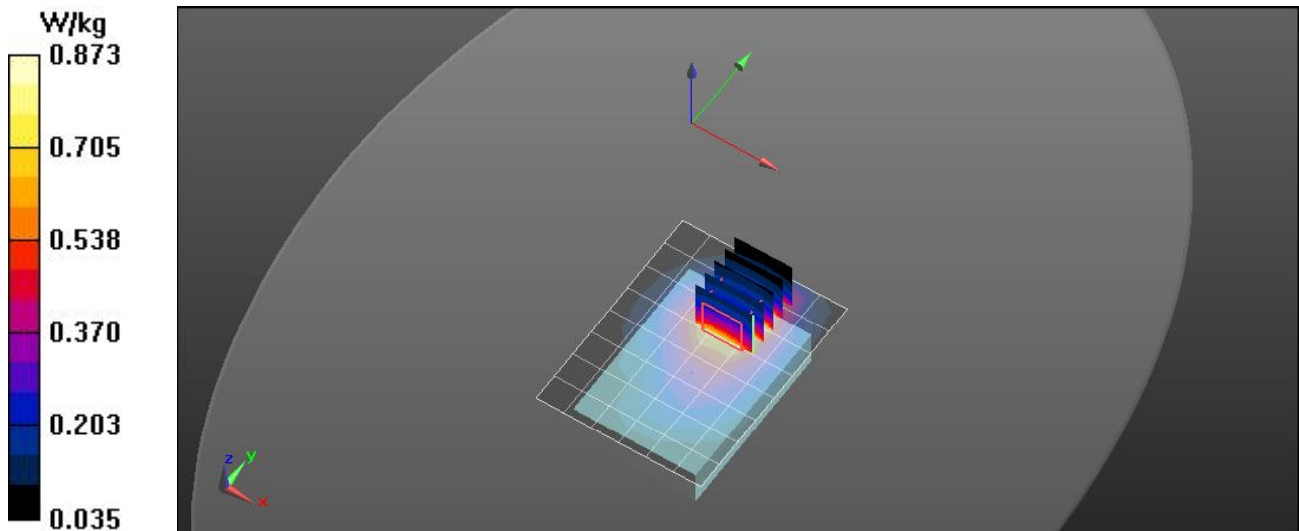

RF Exposure Lab

Plot 2

DUT: MiFi 6620; Type: Hotspot; Serial: SS220414800535

Communication System: GPRS 1-Slot (GMSK); Frequency: 836.6 MHz; Duty Cycle: 1:8.30042
Medium: MSL835; Medium parameters used (interpolated): $f = 836.6$ MHz; $\sigma = 0.982$ S/m; $\epsilon_r = 54.375$; $\rho = 1000$ kg/m³
Phantom section: Flat Section

Test Date: Date: 5/25/2014; Ambient Temp: 23 °C; Tissue Temp: 21 °C

Probe: EX3DV4 - SN3693; ConvF(8.66, 8.66, 8.66); Calibrated: 8/27/2013;
Sensor-Surface: 2mm (Mechanical Surface Detection)
Electronics: DAE4 Sn759; Calibrated: 8/15/2013
Phantom: ELI v4.0; Type: QDOVA001BB; Serial: TP:1065
Measurement SW: DASY52, Version 52.8 (7); SEMCAD X Version 14.6.10 (7164)

Procedure Notes:

835 MHz GSM/Top Mid/Area Scan (7x9x1): Measurement grid: dx=15mm, dy=15mm

Info: Interpolated medium parameters used for SAR evaluation.
Maximum value of SAR (measured) = 0.898 W/kg

835 MHz GSM/Top Mid/Zoom Scan (5x5x7)/Cube 0: Measurement grid: dx=8mm, dy=8mm, dz=5mm
Reference Value = 21.489 V/m; Power Drift = -0.01 dB
Peak SAR (extrapolated) = 1.23 W/kg
SAR(1 g) = 0.697 W/kg; SAR(10 g) = 0.421 W/kg

Info: Interpolated medium parameters used for SAR evaluation.
Maximum value of SAR (measured) = 0.972 W/kg

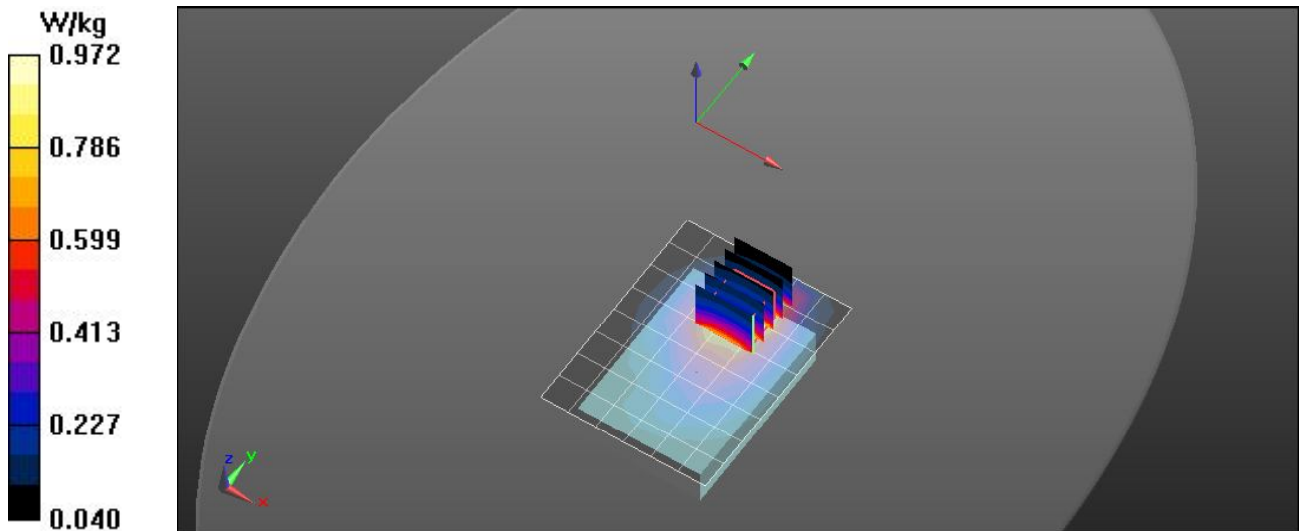

RF Exposure Lab

Plot 3

DUT: MiFi6630; Type: Hotspot; Serial: SH181114900016

Communication System: LTE (SC-FDMA, 1 RB, 10 MHz, QPSK); Frequency: 836.5 MHz; Duty Cycle: 1:1
Medium: MSL835; Medium parameters used (interpolated): $f = 836.5$ MHz; $\sigma = 0.992$ S/m; $\epsilon_r = 54.924$; $\rho = 1000$ kg/m³
Phantom section: Flat Section

Test Date: Date: 12/18/2014; Ambient Temp: 23 °C; Tissue Temp: 21 °C

Probe: EX3DV4 - SN3662; ConvF(9.3, 9.3, 9.3); Calibrated: 4/15/2014;
Sensor-Surface: 2mm (Mechanical Surface Detection)
Electronics: DAE4 Sn1416; Calibrated: 1/13/2014
Phantom: ELI v4.0; Type: QDOVA001BB; Serial: TP:1065
Measurement SW: DASY52, Version 52.8 (8); SEMCAD X Version 14.6.10 (7331)

Procedure Notes:

835 MHz LTE/Top Mid 1RB 0 Offset/Area Scan (7x9x1): Measurement grid: dx=15mm, dy=15mm

Info: Interpolated medium parameters used for SAR evaluation.
Maximum value of SAR (measured) = 0.454 W/kg

835 MHz LTE/Top Mid 1RB 0 Offset/Zoom Scan (5x5x7)/Cube 0: Measurement grid: dx=8mm, dy=8mm, dz=5mm
Reference Value = 20.19 V/m; Power Drift = -0.01 dB
Peak SAR (extrapolated) = 0.549 W/kg
SAR(1 g) = 0.391 W/kg; SAR(10 g) = 0.274 W/kg

Info: Interpolated medium parameters used for SAR evaluation.
Maximum value of SAR (measured) = 0.469 W/kg

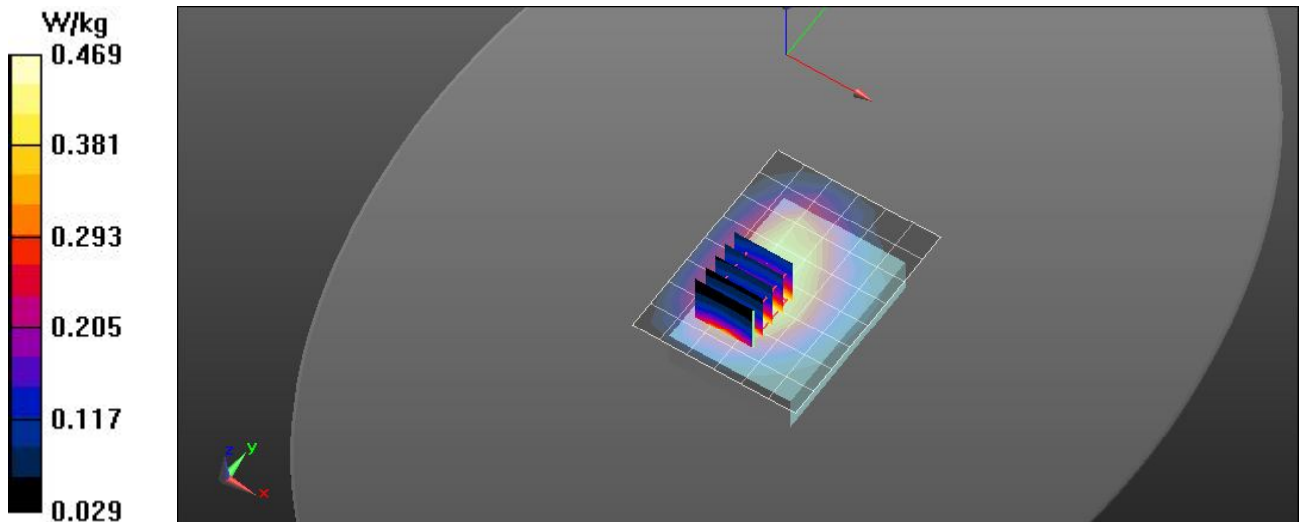

RF Exposure Lab

Plot 4

DUT: MiFi 6620; Type: Hotspot; Serial: SS220414800535

Communication System: UMTS (WCDMA); Frequency: 1852.4 MHz; Duty Cycle: 1:1
Medium: MSL1900; Medium parameters used (interpolated): $f = 1852.4$ MHz; $\sigma = 1.492$ S/m; $\epsilon_r = 53.265$; $\rho = 1000$ kg/m³
Phantom section: Flat Section

Test Date: Date: 5/25/2014; Ambient Temp: 23 °C; Tissue Temp: 21 °C

Probe: EX3DV4 - SN3693; ConvF(7.1, 7.1, 7.1); Calibrated: 8/27/2013;
Sensor-Surface: 2mm (Mechanical Surface Detection)
Electronics: DAE4 Sn759; Calibrated: 8/15/2013
Phantom: ELI v4.0; Type: QDOVA001BB; Serial: TP:1065
Measurement SW: DASY52, Version 52.8 (7); SEMCAD X Version 14.6.10 (7164)

Procedure Notes:

1900 MHz WCDMA/Bottom Low/Area Scan (7x9x1): Measurement grid: dx=15mm, dy=15mm

Info: Interpolated medium parameters used for SAR evaluation.
Maximum value of SAR (measured) = 1.80 W/kg

1900 MHz WCDMA/Bottom Low/Zoom Scan (5x5x7)/Cube 0: Measurement grid: dx=8mm, dy=8mm, dz=5mm
Reference Value = 13.241 V/m; Power Drift = 0.01 dB
Peak SAR (extrapolated) = 2.12 W/kg
SAR(1 g) = 1.35 W/kg; SAR(10 g) = 0.779 W/kg

Info: Interpolated medium parameters used for SAR evaluation.
Maximum value of SAR (measured) = 1.77 W/kg

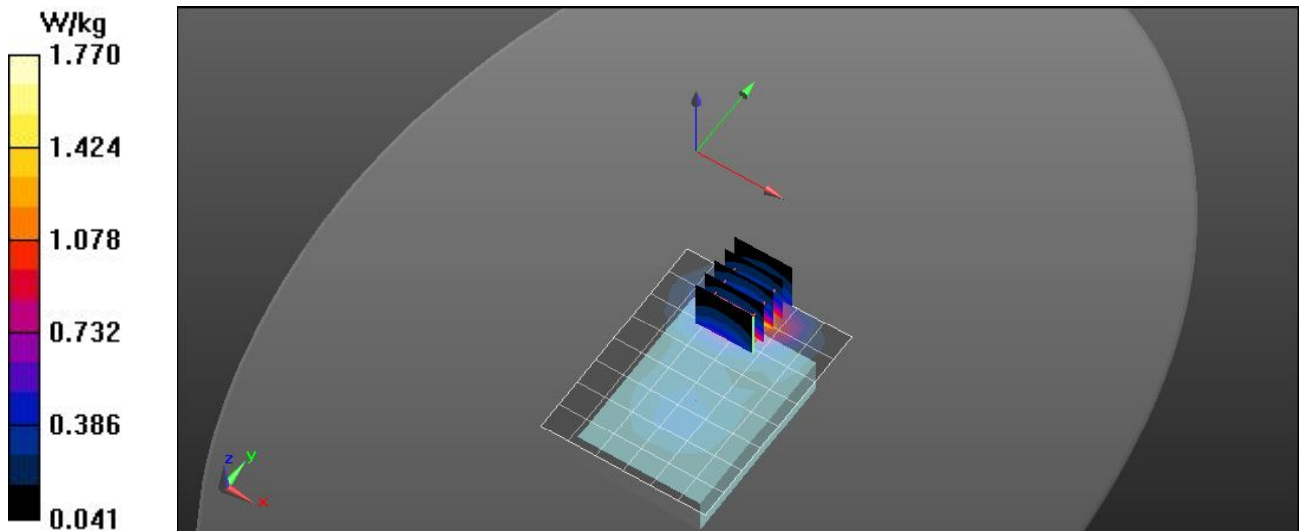

RF Exposure Lab

Plot 5

DUT: MiFi 6620; Type: Hotspot; Serial: SS220414800535

Communication System: GPRS 1-Slot (GMSK); Frequency: 1880 MHz; Duty Cycle: 1:8.30042
Medium: MSL1900; Medium parameters used: $f = 1880$ MHz; $\sigma = 1.52$ S/m; $\epsilon_r = 53.21$; $\rho = 1000$ kg/m³
Phantom section: Flat Section

Test Date: Date: 5/26/2014; Ambient Temp: 23 °C; Tissue Temp: 21 °C

Probe: EX3DV4 - SN3693; ConvF(7.1, 7.1, 7.1); Calibrated: 8/27/2013;
Sensor-Surface: 2mm (Mechanical Surface Detection)
Electronics: DAE4 Sn759; Calibrated: 8/15/2013
Phantom: ELI v4.0; Type: QDOVA001BB; Serial: TP:1065
Measurement SW: DASY52, Version 52.8 (7); SEMCAD X Version 14.6.10 (7164)

Procedure Notes:

1900 MHz GSM/Bottom Mid/Area Scan (7x9x1): Measurement grid: dx=15mm, dy=15mm
Maximum value of SAR (measured) = 0.549 W/kg

1900 MHz GSM/Bottom Mid/Zoom Scan (5x5x7)/Cube 0: Measurement grid: dx=8mm, dy=8mm, dz=5mm
Reference Value = 5.812 V/m; Power Drift = -0.02 dB
Peak SAR (extrapolated) = 0.653 W/kg
SAR(1 g) = 0.415 W/kg; SAR(10 g) = 0.234 W/kg
Maximum value of SAR (measured) = 0.543 W/kg

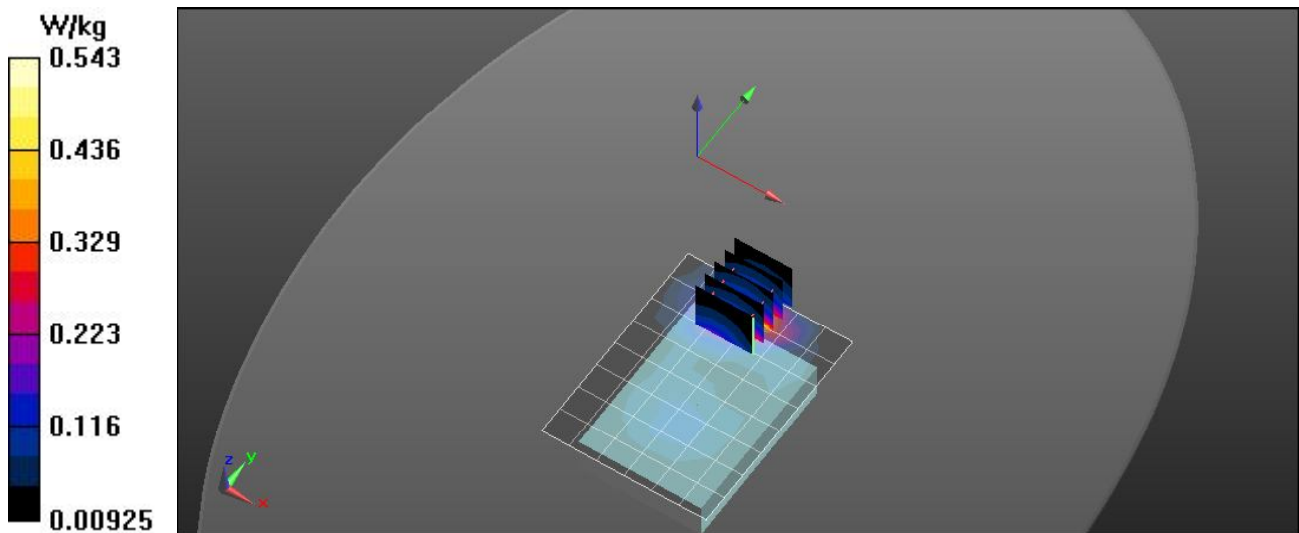

RF Exposure Lab

Plot 6

DUT: MiFi 6620; Type: Hotspot; Serial: SS220414800535

Communication System: LTE (SC-FDMA, 1 RB, 20 MHz, QPSK); Frequency: 1860 MHz; Duty Cycle: 1:1
Medium: MSL1900; Medium parameters used: $f = 1860$ MHz; $\sigma = 1.5$ S/m; $\epsilon_r = 53.25$; $\rho = 1000$ kg/m³
Phantom section: Flat Section

Test Date: Date: 5/26/2014; Ambient Temp: 23 °C; Tissue Temp: 21 °C

Probe: EX3DV4 - SN3693; ConvF(7.1, 7.1, 7.1); Calibrated: 8/27/2013;
Sensor-Surface: 2mm (Mechanical Surface Detection)
Electronics: DAE4 Sn759; Calibrated: 8/15/2013
Phantom: ELI v4.0; Type: QDOVA001BB; Serial: TP:1065
Measurement SW: DASY52, Version 52.8 (7); SEMCAD X Version 14.6.10 (7164)

Procedure Notes:

1900 MHz LTE/Bottom Low 1RB 0 Offset/Area Scan (7x9x1): Measurement grid: dx=15mm, dy=15mm
Maximum value of SAR (measured) = 1.75 W/kg

1900 MHz LTE/Bottom Low 1RB 0 Offset/Zoom Scan (5x5x7)/Cube 0: Measurement grid: dx=8mm, dy=8mm, dz=5mm

Reference Value = 12.943 V/m; Power Drift = -0.03 dB

Peak SAR (extrapolated) = 2.07 W/kg

SAR(1 g) = 1.27 W/kg; SAR(10 g) = 0.733 W/kg

Maximum value of SAR (measured) = 1.72 W/kg

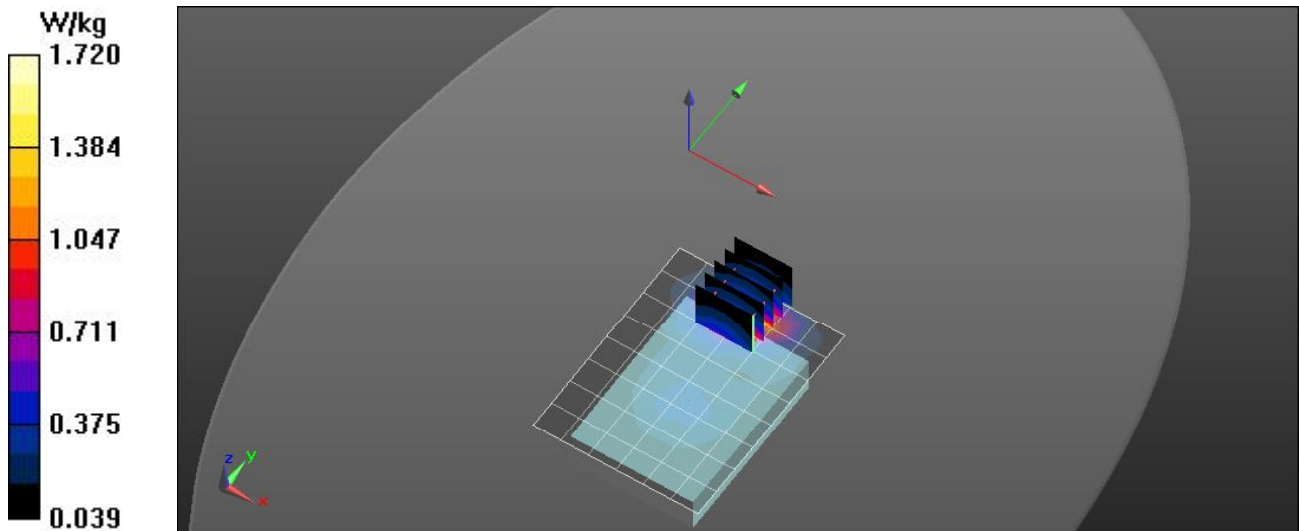

RF Exposure Lab

Plot 7

DUT: MiFi 6620; Type: Hotspot; Serial: SS220414800535

Communication System: LTE (SC-FDMA, 1 RB, 20 MHz, QPSK); Frequency: 1720 MHz; Duty Cycle: 1:1
 Medium: MSL1750; Medium parameters used: $f = 1720$ MHz; $\sigma = 1.54$ S/m; $\epsilon_r = 52.78$; $\rho = 1000$ kg/m³
 Phantom section: Flat Section

Test Date: Date: 5/23/2014; Ambient Temp: 23 °C; Tissue Temp: 21 °C

Probe: EX3DV4 - SN3693; ConvF(7.35, 7.35, 7.35); Calibrated: 8/27/2013;
 Sensor-Surface: 2mm (Mechanical Surface Detection)
 Electronics: DAE4 Sn759; Calibrated: 8/15/2013
 Phantom: ELI v4.0; Type: QDOVA001BB; Serial: TP:1065
 Measurement SW: DASY52, Version 52.8 (7); SEMCAD X Version 14.6.10 (7164)

Procedure Notes:

1750 MHz LTE/Bottom Low 1RB 0 Offset/Area Scan (7x9x1): Measurement grid: dx=15mm, dy=15mm
 Maximum value of SAR (measured) = 1.64 W/kg

1750 MHz LTE/Bottom Low 1RB 0 Offset/Zoom Scan (5x5x7)/Cube 0: Measurement grid: dx=8mm, dy=8mm, dz=5mm

Reference Value = 12.943 V/m; Power Drift = -0.01 dB

Peak SAR (extrapolated) = 2.22 W/kg

SAR(1 g) = 1.42 W/kg; SAR(10 g) = 0.807 W/kg

Maximum value of SAR (measured) = 1.85 W/kg

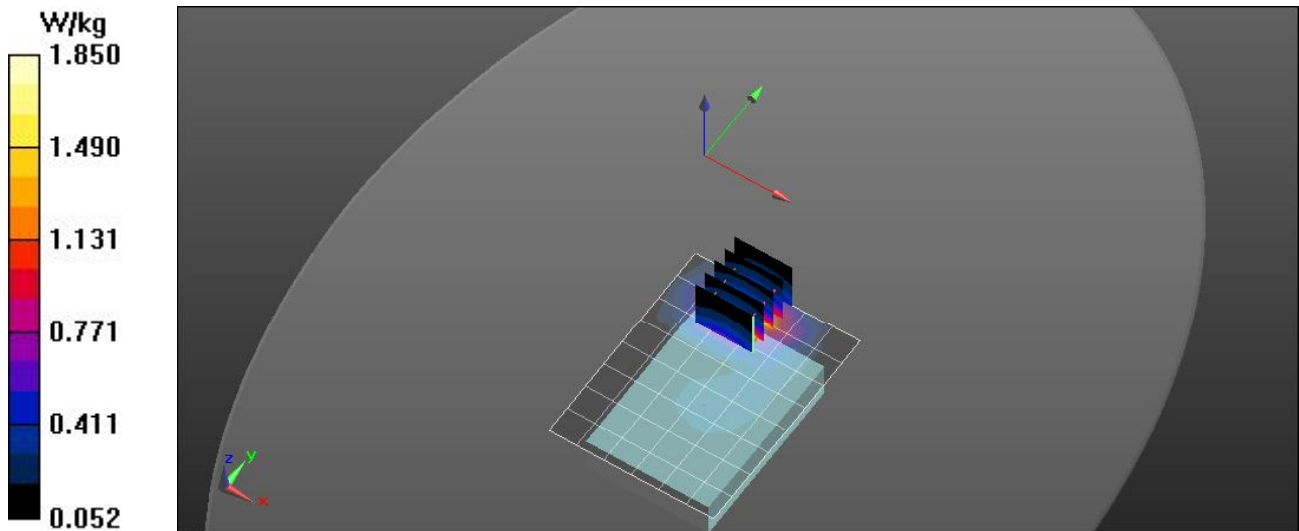

RF Exposure Lab

Plot 8

DUT: MiFi6630; Type: Hotspot; Serial: SH181114900016

Communication System: LTE (SC-FDMA, 1 RB, 10 MHz, QPSK); Frequency: 707.5 MHz; Duty Cycle: 1:1
 Medium: MSL750; Medium parameters used (interpolated): $f = 707.5$ MHz; $\sigma = 0.95$ S/m; $\epsilon_r = 55.43$; $\rho = 1000$ kg/m³
 Phantom section: Flat Section

Test Date: Date: 12/18/2014; Ambient Temp: 23 °C; Tissue Temp: 21 °C

Probe: EX3DV4 - SN3662; ConvF(9.42, 9.42, 9.42); Calibrated: 4/15/2014;
 Sensor-Surface: 2mm (Mechanical Surface Detection)
 Electronics: DAE4 Sn1416; Calibrated: 1/13/2014
 Phantom: ELI v4.0; Type: QDOVA001BB; Serial: TP:1065
 Measurement SW: DASY52, Version 52.8 (8); SEMCAD X Version 14.6.10 (7331)

Procedure Notes:

750 MHz LTE/Top Mid 1RB 0 Offset/Area Scan (7x9x1): Measurement grid: dx=15mm, dy=15mm

Info: Interpolated medium parameters used for SAR evaluation.
 Maximum value of SAR (measured) = 0.548 W/kg

750 MHz LTE/Top Mid 1RB 0 Offset/Zoom Scan (5x5x7)/Cube 0: Measurement grid: dx=8mm, dy=8mm, dz=5mm

Reference Value = 16.14 V/m; Power Drift = 0.02 dB
 Peak SAR (extrapolated) = 0.655 W/kg
SAR(1 g) = 0.440 W/kg; SAR(10 g) = 0.294 W/kg

Info: Interpolated medium parameters used for SAR evaluation.
 Maximum value of SAR (measured) = 0.555 W/kg

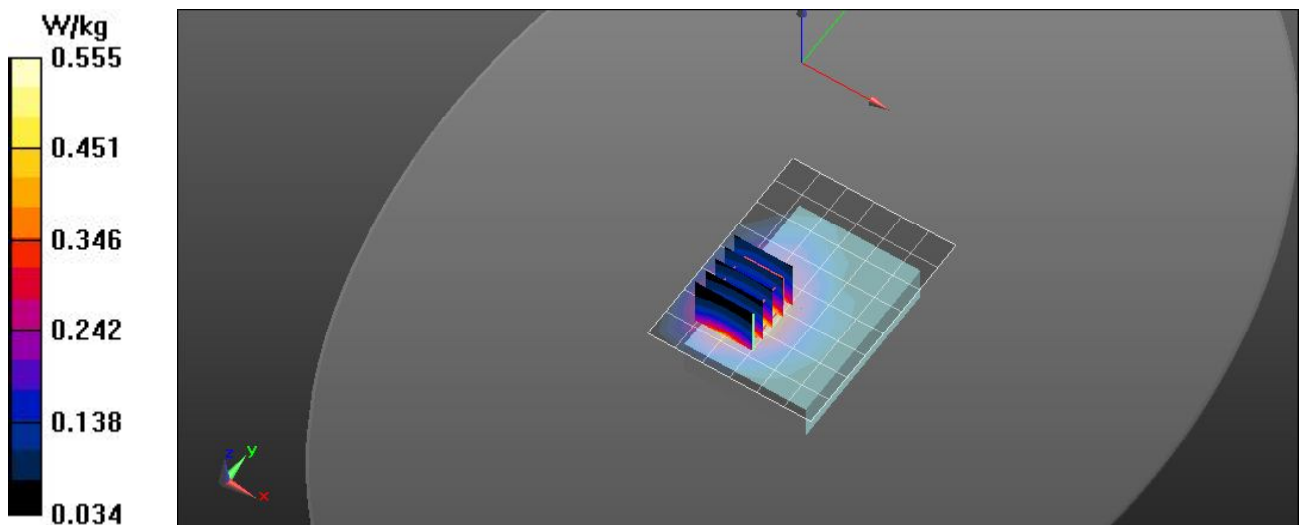

RF Exposure Lab

Plot 9

DUT: MiFi 6620; Type: Hotspot; Serial: SS220414800535

Communication System: WiFi 802.11b (DSSS, 1 Mbps); Frequency: 2437 MHz; Duty Cycle: 1:1
 Medium: MSL2450; Medium parameters used (interpolated): $f = 2437$ MHz; $\sigma = 1.947$ S/m; $\epsilon_r = 52.556$; $\rho = 1000$ kg/m³
 Phantom section: Flat Section

Test Date: Date: 2/17/2015; Ambient Temp: 23 °C; Tissue Temp: 21 °C

Probe: EX3DV4 - SN3662; ConvF(7.12, 7.12, 7.12); Calibrated: 4/15/2014;
 Sensor-Surface: 2mm (Mechanical Surface Detection)
 Electronics: DAE4 Sn759; Calibrated: 8/12/2014
 Phantom: ELI v4.0; Type: QDOVA001BB; Serial: 1251
 Measurement SW: DASY52, Version 52.8 (8); SEMCAD X Version 14.6.10 (7331)

Procedure Notes:

2.4 GHz/Chain 0 Top 6/Area Scan (10x13x1): Measurement grid: dx=10mm, dy=10mm

Info: Interpolated medium parameters used for SAR evaluation.
 Maximum value of SAR (measured) = 0.420 W/kg

2.4 GHz/Chain 0 Top 6/Zoom Scan (7x7x7)/Cube 0: Measurement grid: dx=5mm, dy=5mm, dz=5mm

Reference Value = 2.727 V/m; Power Drift = 0.02 dB
 Peak SAR (extrapolated) = 0.551 W/kg
SAR(1 g) = 0.278 W/kg; SAR(10 g) = 0.138 W/kg

Info: Interpolated medium parameters used for SAR evaluation.
 Maximum value of SAR (measured) = 0.416 W/kg

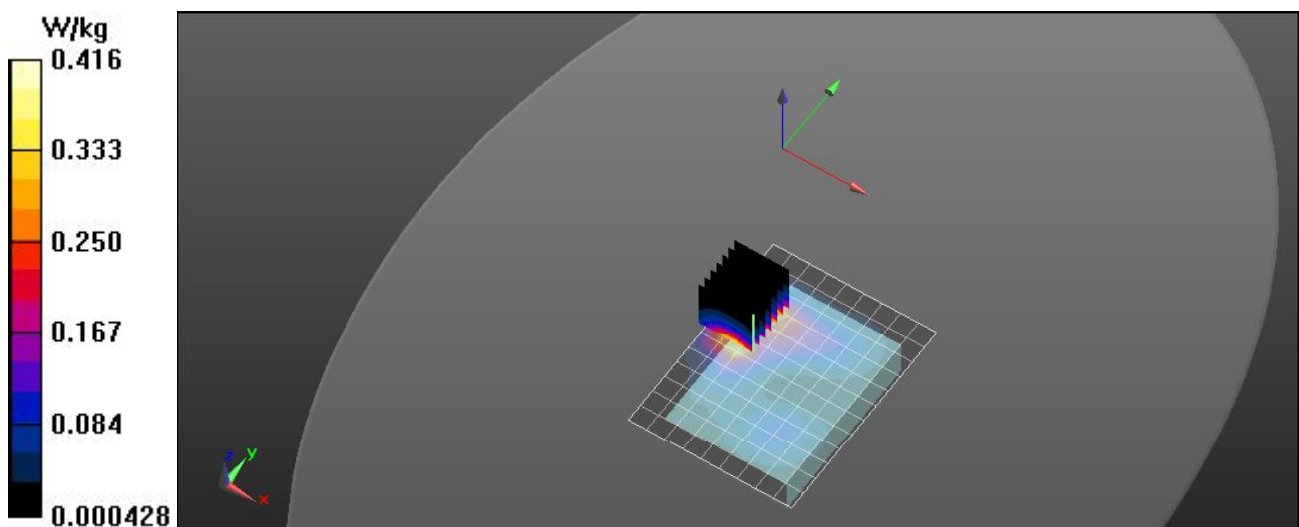

RF Exposure Lab

Plot 10

DUT: MiFi 6620; Type: Hotspot; Serial: SS220414800535

Communication System: WiFi 802.11a (OFDM, 6 Mbps); Frequency: 5220 MHz; Duty Cycle: 1:1
 Medium: MSL 3-6 GHz; Medium parameters used: $f = 5220 \text{ MHz}$; $\sigma = 5.23 \text{ S/m}$; $\epsilon_r = 49.04$; $\rho = 1000 \text{ kg/m}^3$
 Phantom section: Flat Section

Test Date: Date: 5/31/2014; Ambient Temp: 23 °C; Tissue Temp: 21 °C

Probe: EX3DV4 - SN3693; ConvF(4.39, 4.39, 4.39); Calibrated: 8/27/2013;
 Sensor-Surface: 2mm (Mechanical Surface Detection)
 Electronics: DAE4 Sn759; Calibrated: 8/15/2013
 Phantom: ELI v4.0; Type: QDOVA001BB; Serial: TP:1065
 Measurement SW: DASY52, Version 52.8 (7); SEMCAD X Version 14.6.10 (7164)

Procedure Notes:

5.2 GHz/Chain 0 Right 44/Area Scan (10x13x1): Measurement grid: dx=10mm, dy=10mm
 Maximum value of SAR (measured) = 0.0863 W/kg

5.2 GHz/Chain 0 Right 44/Zoom Scan (7x7x12)/Cube 0: Measurement grid: dx=4mm, dy=4mm, dz=2mm
 Reference Value = 1.901 V/m; Power Drift = 0.02 dB
 Peak SAR (extrapolated) = 0.246 W/kg
SAR(1 g) = 0.067 W/kg; SAR(10 g) = 0.033 W/kg
 Maximum value of SAR (measured) = 0.120 W/kg

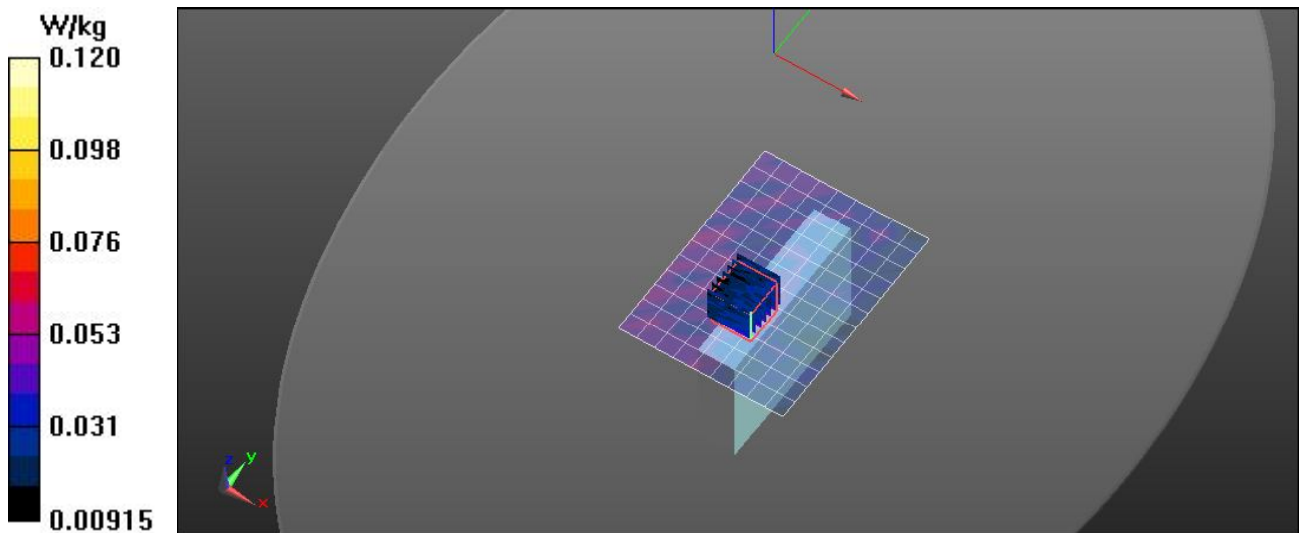

RF Exposure Lab

Plot 11

DUT: MiFi 6620; Type: Hotspot; Serial: SS220414800535

Communication System: WiFi 802.11a (OFDM, 6 Mbps); Frequency: 5785 MHz; Duty Cycle: 1:1
Medium: MSL 3-6 GHz; Medium parameters used (interpolated): $f = 5785$ MHz; $\sigma = 5.975$ S/m; $\epsilon_r = 48.193$; $\rho = 1000$ kg/m³
Phantom section: Flat Section

Test Date: Date: 6/1/2014; Ambient Temp: 23 °C; Tissue Temp: 21 °C

Probe: EX3DV4 - SN3693; ConvF(4.04, 4.04, 4.04); Calibrated: 8/27/2013;
Sensor-Surface: 2mm (Mechanical Surface Detection)
Electronics: DAE4 Sn759; Calibrated: 8/15/2013
Phantom: ELI v4.0; Type: QDOVA001BB; Serial: TP:1065
Measurement SW: DASY52, Version 52.8 (7); SEMCAD X Version 14.6.10 (7164)

Procedure Notes:

5.8 GHz/Chain 0 Right 157/Area Scan (10x13x1): Measurement grid: dx=10mm, dy=10mm

Info: Interpolated medium parameters used for SAR evaluation.
Maximum value of SAR (measured) = 0.112 W/kg

5.8 GHz/Chain 0 Right 157/Zoom Scan (7x7x12)/Cube 0: Measurement grid: dx=4mm, dy=4mm, dz=2mm
Reference Value = 1.956 V/m; Power Drift = -0.01 dB
Peak SAR (extrapolated) = 0.401 W/kg
SAR(1 g) = 0.066 W/kg; SAR(10 g) = 0.037 W/kg

Info: Interpolated medium parameters used for SAR evaluation.
Maximum value of SAR (measured) = 0.110 W/kg

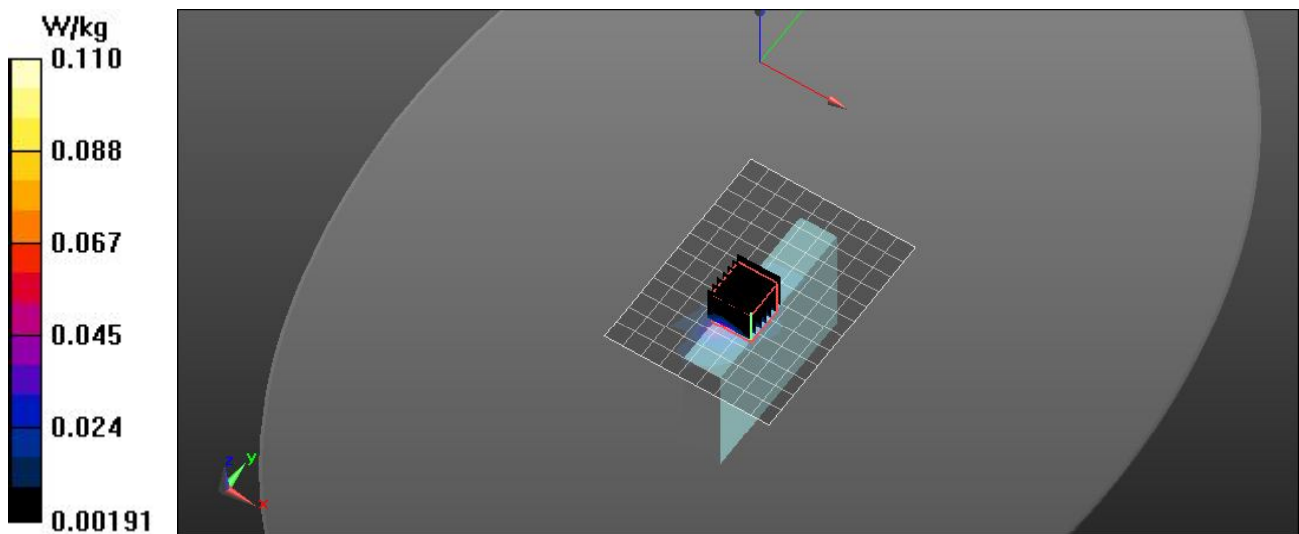

Appendix C – SAR Test Setup Photos



Test Position Side A 10 mm Gap



Test Position Side B 10 mm Gap



Test Position Side C 10 mm Gap

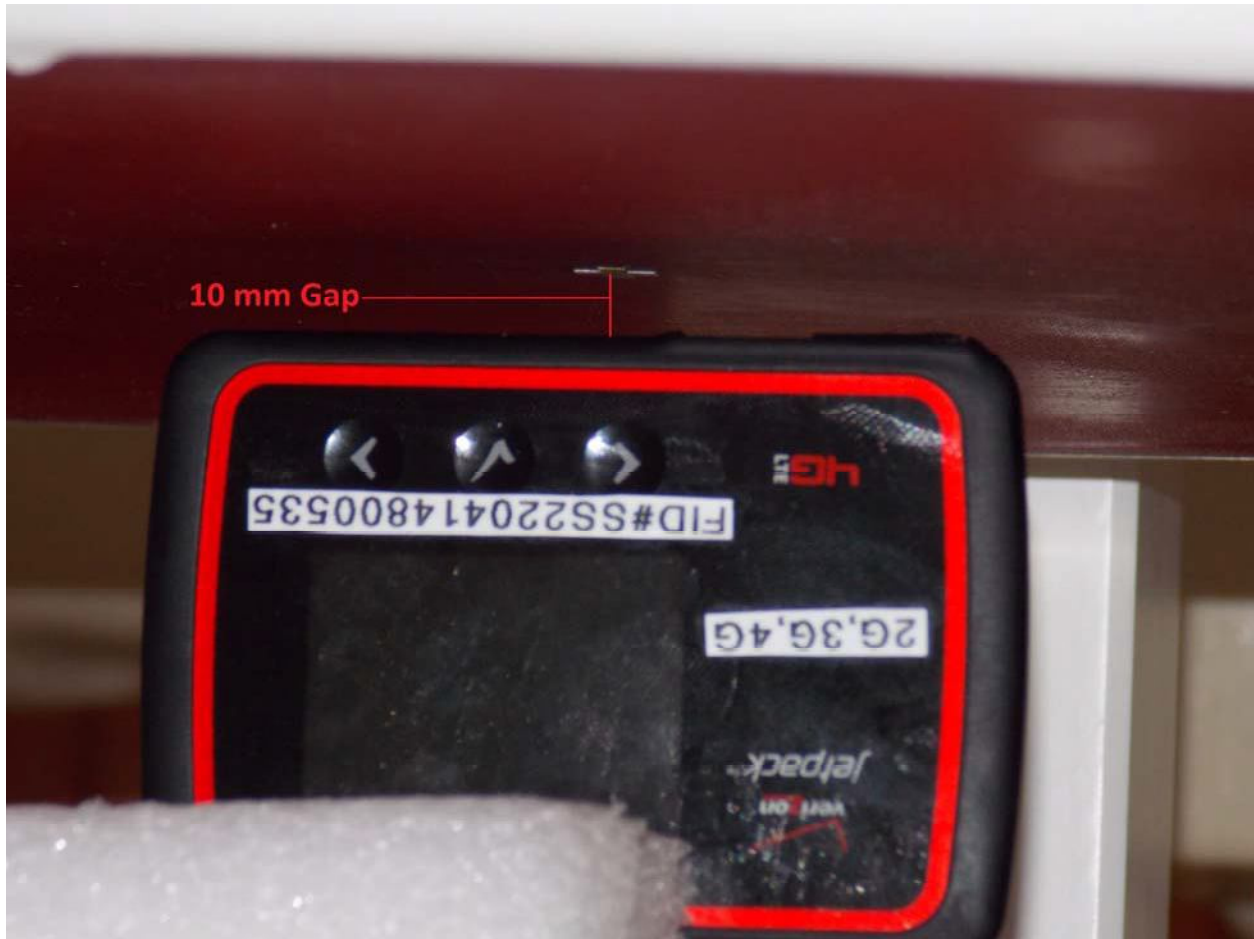

Test Position Side D 10 mm Gap



Test Position Side E 10 mm Gap



Test and Antenna Locations



Front of Device



Back of Device

Appendix D – Probe Calibration Data Sheets



Accredited by the Swiss Accreditation Service (SAS)
The Swiss Accreditation Service is one of the signatories to the EA
Multilateral Agreement for the recognition of calibration certificates

Accreditation No.: **SCS 108**

Client **RF Exposure lab**

Certificate No: **EX3-3693_Aug13**

CALIBRATION CERTIFICATE

Object: **EX3DV4 - SN:3693**

Calibration procedure(s): **QA CAL-01.v9, QA CAL-14.v4, QA CAL-23.v5, QA CAL-25.v6**
Calibration procedure for dosimetric E-field probes

Calibration date: **August 27, 2013**

This calibration certificate documents the traceability to national standards, which realize the physical units of measurements (SI).
The measurements and the uncertainties with confidence probability are given on the following pages and are part of the certificate.

All calibrations have been conducted in the closed laboratory facility: environment temperature $(22 \pm 3)^\circ\text{C}$ and humidity $< 70\%$.

Calibration Equipment used (M&TE critical for calibration)

Primary Standards	ID	Cal Date (Certificate No.)	Scheduled Calibration
Power meter E4419B	GB41293874	04-Apr-13 (No. 217-01733)	Apr-14
Power sensor E4412A	MY41498087	04-Apr-13 (No. 217-01733)	Apr-14
Reference 3 dB Attenuator	SN: S5054 (3c)	04-Apr-13 (No. 217-01737)	Apr-14
Reference 20 dB Attenuator	SN: S5277 (20x)	04-Apr-13 (No. 217-01735)	Apr-14
Reference 30 dB Attenuator	SN: S5129 (30b)	04-Apr-13 (No. 217-01738)	Apr-14
Reference Probe ES3DV2	SN: 3013	28-Dec-12 (No. ES3-3013, Dec12)	Dec-13
DAE4	SN: 660	31-Jan-13 (No. DAE4-660, Jan13)	Jan-14
Secondary Standards	ID	Check Date (in house)	Scheduled Check
RF generator HP 8648C	US3642U01700	4-Aug-99 (in house check Apr-13)	In house check: Apr-15
Network Analyzer HP 8753E	US37390585	18-Oct-01 (in house check Oct-12)	In house check: Oct-13

	Name	Function	Signature
Calibrated by:	Jeton Kastrati	Laboratory Technician	
Approved by:	Katja Pokovic	Technical Manager	
			Issued: August 29, 2013
This calibration certificate shall not be reproduced except in full without written approval of the laboratory			



Accredited by the Swiss Accreditation Service (SAS)

Accreditation No.: **SCS 108**

The Swiss Accreditation Service is one of the signatories to the EA
Multilateral Agreement for the recognition of calibration certificates

Glossary:

TSL	tissue simulating liquid
NORM _{x,y,z}	sensitivity in free space
ConvF	sensitivity in TSL / NORM _{x,y,z}
DCP	diode compression point
CF	crest factor (1/duty_cycle) of the RF signal
A, B, C, D	modulation dependent linearization parameters
Polarization φ	φ rotation around probe axis
Polarization ϑ	ϑ rotation around an axis that is in the plane normal to probe axis (at measurement center), i.e., $\vartheta = 0$ is normal to probe axis

Calibration is Performed According to the Following Standards:

- IEEE Std 1528-2003, "IEEE Recommended Practice for Determining the Peak Spatial-Averaged Specific Absorption Rate (SAR) in the Human Head from Wireless Communications Devices: Measurement Techniques", December 2003
- IEC 62209-1, "Procedure to measure the Specific Absorption Rate (SAR) for hand-held devices used in close proximity to the ear (frequency range of 300 MHz to 3 GHz)", February 2005

Methods Applied and Interpretation of Parameters:

- NORM_{x,y,z}**: Assessed for E-field polarization $\vartheta = 0$ ($f \leq 900$ MHz in TEM-cell; $f > 1800$ MHz; R22 waveguide). NORM_{x,y,z} are only intermediate values, i.e., the uncertainties of NORM_{x,y,z} does not affect the E²-field uncertainty inside TSL (see below ConvF).
- NORM(\bar{f})_{x,y,z} = NORM_{x,y,z} * frequency_response** (see Frequency Response Chart). This linearization is implemented in DASY4 software versions later than 4.2. The uncertainty of the frequency response is included in the stated uncertainty of ConvF.
- DCP_{x,y,z}**: DCP are numerical linearization parameters assessed based on the data of power sweep with CW signal (no uncertainty required). DCP does not depend on frequency nor media.
- PAR**: PAR is the Peak to Average Ratio that is not calibrated but determined based on the signal characteristics
- A_{x,y,z}; B_{x,y,z}; C_{x,y,z}; D_{x,y,z}; VR_{x,y,z}; A, B, C, D** are numerical linearization parameters assessed based on the data of power sweep for specific modulation signal. The parameters do not depend on frequency nor media. VR is the maximum calibration range expressed in RMS voltage across the diode.
- ConvF and Boundary Effect Parameters**: Assessed in flat phantom using E-field (or Temperature Transfer Standard for $f \leq 800$ MHz) and inside waveguide using analytical field distributions based on power measurements for $f > 800$ MHz. The same setups are used for assessment of the parameters applied for boundary compensation (alpha, depth) of which typical uncertainty values are given. These parameters are used in DASY4 software to improve probe accuracy close to the boundary. The sensitivity in TSL corresponds to NORM_{x,y,z} * ConvF whereby the uncertainty corresponds to that given for ConvF. A frequency dependent ConvF is used in DASY version 4.4 and higher which allows extending the validity from ± 50 MHz to ± 100 MHz.
- Spherical isotropy (3D deviation from isotropy)**: in a field of low gradients realized using a flat phantom exposed by a patch antenna.
- Sensor Offset**: The sensor offset corresponds to the offset of virtual measurement center from the probe tip (on probe axis). No tolerance required.

Probe EX3DV4

SN:3693

Manufactured: April 22, 2009
Calibrated: August 27, 2013

Calibrated for DASY/EASY Systems
(Note: non-compatible with DASY2 system!)

DASY/EASY - Parameters of Probe: EX3DV4 - SN:3693

Basic Calibration Parameters

	Sensor X	Sensor Y	Sensor Z	Unc (k=2)
Norm ($\mu\text{V}/(\text{V}/\text{m})^2$) ^A	0.49	0.48	0.46	$\pm 10.1\%$
DCP (mV) ^B	97.4	101.0	102.0	

Modulation Calibration Parameters

UID	Communication System Name		A dB	B dB $\sqrt{\mu\text{V}}$	C	D dB	VR mV	Unc ^F (k=2)
0	CW	X	0.0	0.0	1.0	0.00	166.1	$\pm 3.0\%$
		Y	0.0	0.0	1.0		162.2	
		Z	0.0	0.0	1.0		163.1	

The reported uncertainty of measurement is stated as the standard uncertainty of measurement multiplied by the coverage factor k=2, which for a normal distribution corresponds to a coverage probability of approximately 95%.

^A The uncertainties of Norm X,Y,Z do not affect the E²-field uncertainty inside TSL (see Pages 5 and 6).

^B Numerical linearization parameter; uncertainty not required

^F Uncertainty is determined using the max. deviation from linear response applying rectangular distribution and is expressed for the square of the field value

DASY/EASY - Parameters of Probe: EX3DV4 - SN:3693

Calibration Parameter Determined in Head Tissue Simulating Media

f (MHz) ^C	Relative Permittivity ^F	Conductivity (S/m) ^F	ConvF X	ConvF Y	ConvF Z	Alpha	Depth (mm)	Unct. (k=2)
750	41.9	0.89	9.00	9.00	9.00	0.21	1.28	± 12.0 %
835	41.5	0.90	8.84	8.84	8.84	0.80	0.60	± 12.0 %
900	41.5	0.97	8.61	8.61	8.61	0.39	0.89	± 12.0 %
1750	40.1	1.37	7.69	7.69	7.69	0.41	0.75	± 12.0 %
1900	40.0	1.40	7.49	7.49	7.49	0.53	0.68	± 12.0 %
2450	39.2	1.80	6.79	6.79	6.79	0.30	0.92	± 12.0 %
2550	39.1	1.91	6.64	6.64	6.64	0.30	0.96	± 12.0 %
2600	39.0	1.96	6.66	6.66	6.66	0.26	1.07	± 12.0 %
5200	36.0	4.66	4.93	4.93	4.93	0.40	1.80	± 13.1 %
5300	35.9	4.76	4.59	4.59	4.59	0.40	1.80	± 13.1 %
5600	35.5	5.07	4.34	4.34	4.34	0.40	1.80	± 13.1 %
5800	35.3	5.27	4.25	4.25	4.25	0.45	1.80	± 13.1 %

^C Frequency validity of ± 100 MHz only applies for DASY v4.4 and higher (see Page 2), else it is restricted to ± 50 MHz. The uncertainty is the RSS of the ConvF uncertainty at calibration frequency and the uncertainty for the indicated frequency band.

^F At frequencies below 3 GHz, the validity of tissue parameters (ϵ and σ) can be relaxed to ± 10% if liquid compensation formula is applied to measured SAR values. At frequencies above 3 GHz, the validity of tissue parameters (ϵ and σ) is restricted to ± 5%. The uncertainty is the RSS of the ConvF uncertainty for indicated target tissue parameters.

DASY/EASY - Parameters of Probe: EX3DV4 - SN:3693

Calibration Parameter Determined in Body Tissue Simulating Media

f (MHz) ^C	Relative Permittivity ^F	Conductivity (S/m) ^F	ConvF X	ConvF Y	ConvF Z	Alpha	Depth (mm)	Unct. (k=2)
750	56.5	0.96	8.67	8.67	8.67	0.55	0.76	± 12.0 %
835	55.2	0.97	8.66	8.66	8.66	0.31	1.03	± 12.0 %
900	55.0	1.05	8.46	8.46	8.46	0.24	1.34	± 12.0 %
1750	53.4	1.49	7.35	7.35	7.35	0.33	0.97	± 12.0 %
1900	53.3	1.52	7.10	7.10	7.10	0.27	1.01	± 12.0 %
2450	52.7	1.95	6.70	6.70	6.70	0.72	0.60	± 12.0 %
2550	52.6	2.09	6.79	6.79	6.79	0.74	0.62	± 12.0 %
2600	52.5	2.16	6.61	6.61	6.61	0.77	0.55	± 12.0 %
5200	49.0	5.30	4.39	4.39	4.39	0.40	1.90	± 13.1 %
5300	48.9	5.42	4.10	4.10	4.10	0.45	1.90	± 13.1 %
5600	48.5	5.77	3.63	3.63	3.63	0.50	1.90	± 13.1 %
5800	48.2	6.00	4.04	4.04	4.04	0.50	1.90	± 13.1 %

^C Frequency validity of ± 100 MHz only applies for DASY v4.4 and higher (see Page 2), else it is restricted to ± 50 MHz. The uncertainty is the RSS of the ConvF uncertainty at calibration frequency and the uncertainty for the indicated frequency band.

^F At frequencies below 3 GHz, the validity of tissue parameters (ϵ and σ) can be relaxed to ± 10% if liquid compensation formula is applied to measured SAR values. At frequencies above 3 GHz, the validity of tissue parameters (ϵ and σ) is restricted to ± 5%. The uncertainty is the RSS of the ConvF uncertainty for indicated target tissue parameters.

Frequency Response of E-Field

(TEM-Cell: ifr110 EXX, Waveguide: R22)

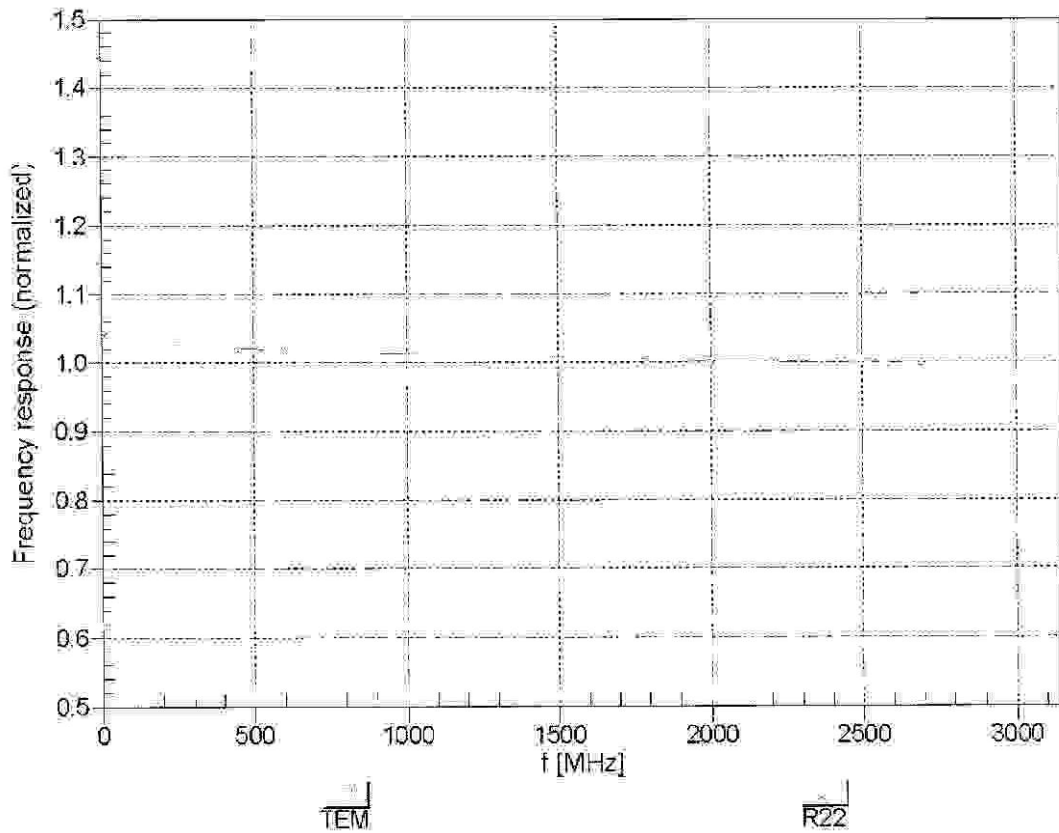

Uncertainty of Frequency Response of E-field: $\pm 6.3\%$ (k=2)

Receiving Pattern (ϕ), $\theta = 0^\circ$

f=600 MHz, TEM

f=1800 MHz, R22

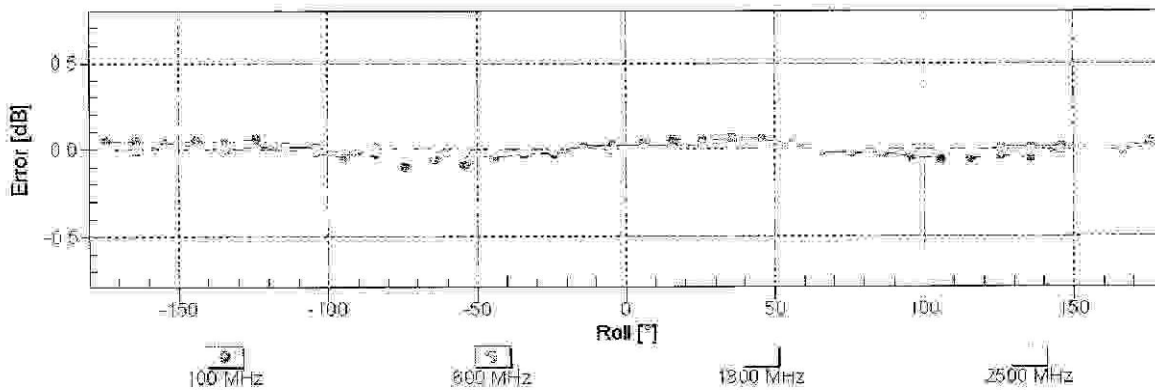
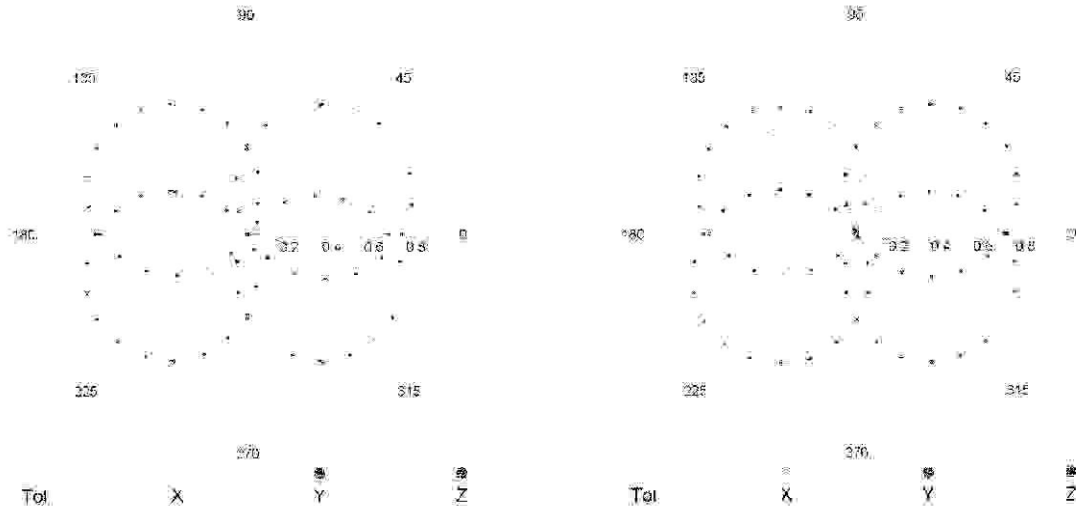

Uncertainty of Axial Isotropy Assessment: $\pm 0.5\%$ (k=2)

Dynamic Range $f(SAR_{head})$ (TEM cell , $f = 900$ MHz)

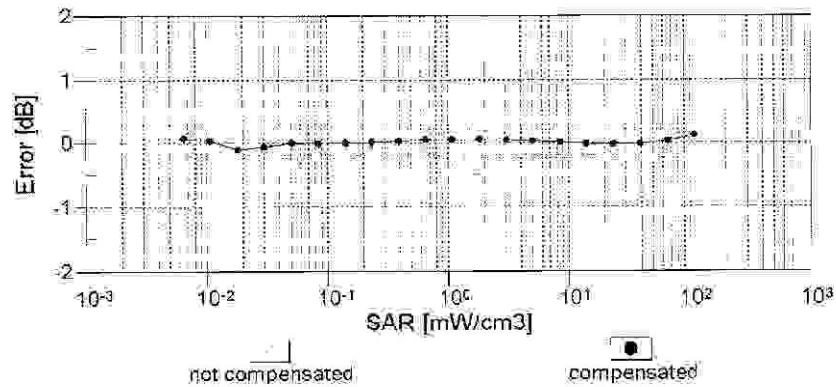
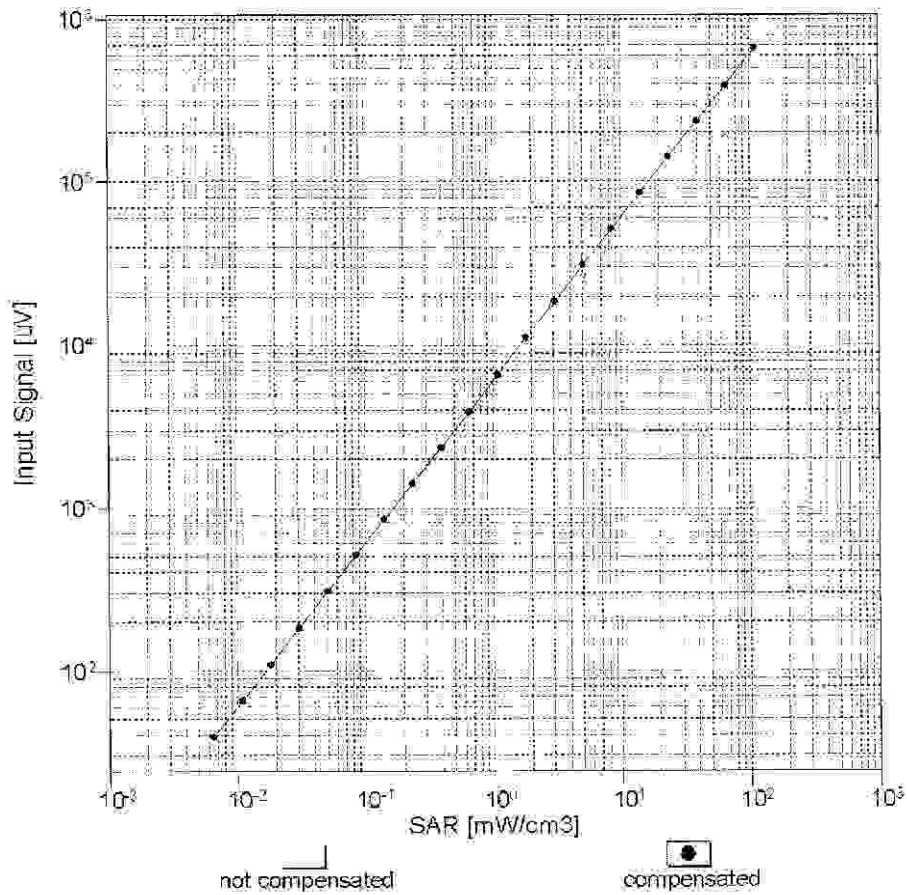

Uncertainty of Linearity Assessment: $\pm 0.6\%$ ($k=2$)

Conversion Factor Assessment

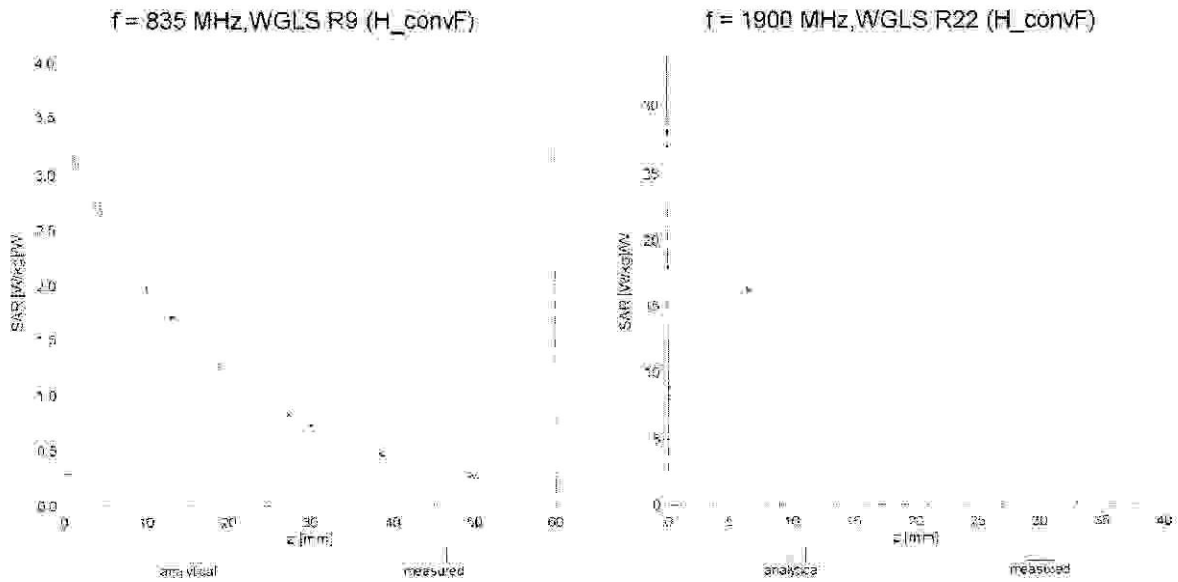

Deviation from Isotropy in Liquid Error (ϕ, θ), f = 900 MHz

