

INSPIRON

SETUP GUIDE







INSPIRON 910

SETUP GUIDE

Model PP39S

Notes, Notices, and Cautions



NOTE: A NOTE indicates important information that helps you make better use of your computer.



NOTICE: A NOTICE indicates either potential damage to hardware or loss of data and tells you how to avoid the problem.



CAUTION: A CAUTION indicates a potential for property damage, personal injury, or death.

Information in this document is subject to change without notice.

© 2008 Dell Inc. All rights reserved.

Reproduction of these materials in any manner whatsoever without the written permission of Dell Inc. is strictly forbidden.

Trademarks used in this text: *Dell*, the *DELL* logo, *Inspiron*, *YOURS IS HERE*, and *DellConnect* are trademarks of Dell Inc.; *Intel*, and *Atom* are registered trademarks and *Core* is a trademark of Intel Corporation; *Microsoft*, *Windows*, and *Windows XP* are either trademarks or registered trademarks of Microsoft Corporation in the United States and/or other countries.; *Bluetooth* is a registered trademark owned by Bluetooth SIG, Inc. and is used by Dell under license.

Other trademarks and trade names may be used in this document to refer to either the entities claiming the marks and names or their products. Dell Inc. disclaims any proprietary interest in trademarks and trade names other than its own.

Model PP39S

June 2008

P/N M770H

Rev. A00

Contents

Setting Up Your Inspiron Ultra Mobile Device	5	Solving Problems	21
Before Setting Up Your Computer	5	Network Problems	21
Connect the AC Adapter	6	Power Problems	22
Connect the Network Cable (optional)	7	Memory Problems	23
Press the Power Button	8	Lockups and Software Problems	23
Microsoft® Windows® XP Setup	9	Using Support Tools	26
Connect to the Internet (Optional)	9	Dell Support Center	26
Using Your Inspiron Ultra Mobile Device	12	System Messages	27
Left Side Features	14	Hardware Troubleshooter	28
Computer Base and Keyboard Features	16	Dell Diagnostics	28
Display Features	18	Restoring Your Operating System	31
Removing and Replacing the Battery	19	Windows Operating System Reinstallation	31
Software Features	20	Getting Help	33
		Technical Support and Customer Service	34

Online Services	34
AutoTech Service.	35
Product Information.	35
Before You Call.	36
Contacting Dell.	37
Finding More Information and Resources	38
Basic Specifications	40
Index	48

Setting Up Your Inspiron Ultra Mobile Device

This section provides information about setting up your Inspiron 910 ultra mobile device and connecting peripherals.

Before Setting Up Your Computer

When positioning your computer, ensure that you allow easy access to a power source, adequate ventilation, and a level surface to place your computer.

Restricting airflow around your Inspiron ultra mobile device may cause it to overheat. To prevent overheating ensure that you leave at least 10.2 cm (4 in) at the back of the computer and a minimum of 5.1 cm (2 in) on all other sides. You should never put your computer in an enclosed space, such as a cabinet or drawer when it is powered on.

- ➔ **NOTICE:** Placing or stacking heavy or sharp objects on the computer may result in permanent damage to the computer.



Setting Up Your Inspiron Ultra Mobile Device

Connect the AC Adapter

Connect the AC adapter to the computer and then plug it into a wall outlet or surge protector.

⚠ CAUTION: The AC adapter works with electrical outlets worldwide. However, power connectors and power strips vary among countries. Using an incompatible cable or improperly connecting the cable to a power strip or electrical outlet may cause fire or equipment damage.

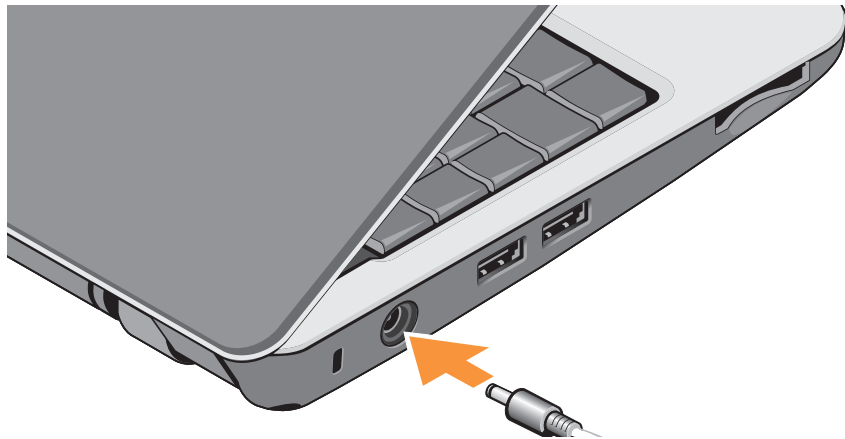

Connect the Network Cable (optional)

To use a wired network connection, plug in the network cable.

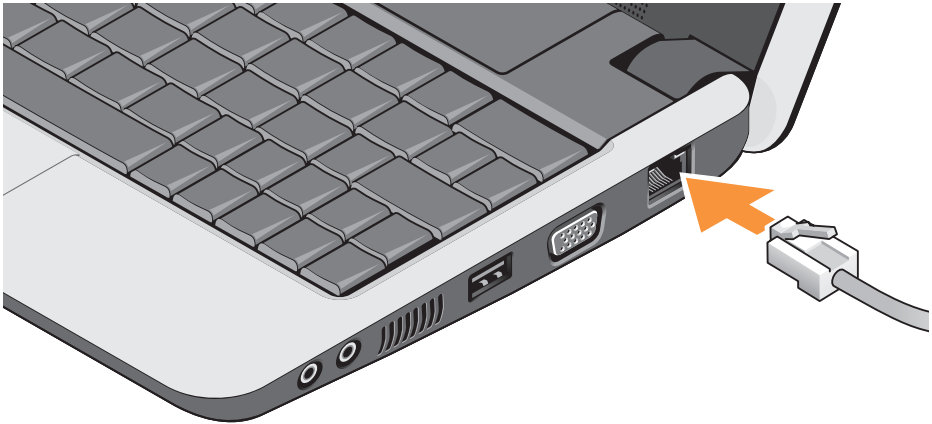

Setting Up Your Inspiron Ultra Mobile Device

Press the Power Button



Microsoft® Windows® XP Setup

If you ordered Windows XP operating system with your computer, it is already configured. To set up Windows XP for the first time, follow the instructions on the screen. These steps are mandatory and may take up to 15 minutes to complete. The screens will take you through several procedures including accepting license agreements, setting preferences and setting up an Internet connection.

- ➔ **NOTICE:** Do not interrupt the operating system's setup process, doing so may render your computer unusable.

Connect to the Internet (Optional)

-  **NOTE:** ISPs (Internet Service Providers) and ISP offerings vary by country.

To connect to the Internet, you need an external modem or network connection and an Internet service provider (ISP).

-  **NOTE:** If an external USB modem or WLAN adapter is not a part of your original order, you can purchase one from the Dell website at www.dell.com.

Setting Up a Wired Internet Connection in Windows XP

If you are using a dial-up connection, connect the telephone line to the external USB modem (optional) and to the telephone wall connector before you set up your Internet connection. If you are using a DSL or cable/satellite modem connection, contact your ISP or cellular telephone service for setup instructions and see "Setting Up Your Internet Connection in Windows XP" on page 10.

Setting Up a Wireless Connection in Windows XP

Before you can use your wireless Internet connection, you need to connect to your wireless router.

Setting Up Your Inspiron Ultra Mobile Device

To set up your connection using a wireless router:

1. Save and close any open files, and exit any open programs.
2. Click **Start**→ **Internet Explorer**→ **Connect to the Internet**.
3. Follow the instructions on the screen to complete the setup.

Setting Up Your Internet Connection in Windows XP

To set up an Internet connection, perform the steps in the following section.

 **NOTE:** If you cannot connect to the Internet but have successfully connected in the past, the ISP might have a service outage. Contact your ISP to check the service status, or try connecting again later.

 **NOTE:** Have your ISP information ready. If you do not have an ISP, the Connect to the Internet wizard can help you get one.

1. Save and close any open files, and exit any open programs.
2. Click **Start**→ **Internet Explorer**→ **Connect to the Internet**.
3. In the next window, click the appropriate option:
 - a. If you do not have an ISP, click **Choose from a list of Internet service providers (ISPs)**.

Setting Up Your Inspiron Ultra Mobile Device

- b. If you have already obtained setup information from your ISP but you did not receive a setup CD, click **Set up my connection manually**.
- c. If you have a setup CD, click **Use the CD I got from an ISP**.

 **NOTE:** Your computer may or may not have an optical drive. Use an external optical drive or any external storage device for the procedures that involve media.

4. Click **Next**.

If you selected **Set up my connection manually** in step 3, continue to step 5. Otherwise, follow the instructions on the screen to complete the setup.

 **NOTE:** If you do not know which type of connection to select, contact your ISP.



5. Click the appropriate option under **How do you want to connect to the Internet?**, and click **Next**.
6. Use the setup information provided by your ISP to complete the setup.

Using Your Inspiron Ultra Mobile Device

Your Inspiron 910 has indicators, buttons, and features that provide information at-a-glance and time-saving shortcuts for common tasks.

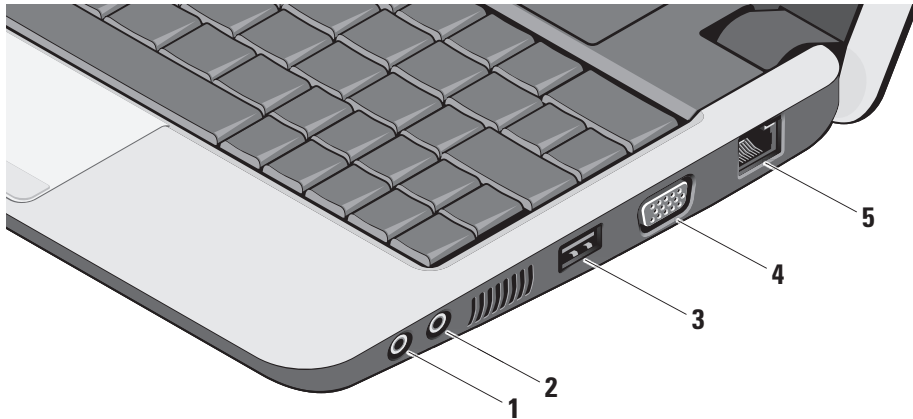
Right Side Features



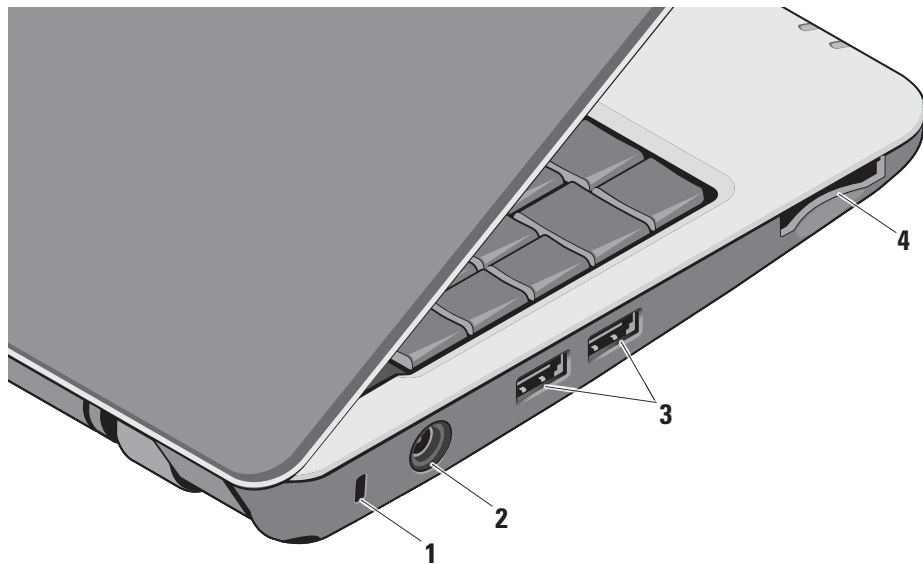

-  **Audio Out/ Headphone connector**
– Connects to a pair of headphones, or sends audio to a powered speaker or sound system.
-  **Audio In/ Microphone connector** –
Connects to a microphone or input signal for use with audio programs.
-  **USB 2.0 connector** – Connects to USB devices, such as a mouse, keyboard, printer, external drive, or MP3 player.
-  **VGA connector** – Connects to a monitor or projector.
-  **Network connector** – If you are using a cabled network signal, this connects your computer to a network or broadband device.

Left Side Features



- 1 Security cable slot** – Attaches a commercially available antitheft device to the computer.

 **NOTE:** Before you buy an antitheft device, ensure that it works with the security cable slot on your computer.

- 2  AC adapter connector** – Connects to the AC adapter to power on the computer and charge the battery when the computer is not in use.

- 3  USB 2.0 connectors (2)** – Connect to USB devices, such as a mouse, keyboard, printer, external drive, or MP3 player.

- 4 **

3-in-1 Media card reader – Provides a fast and convenient way to view and share digital photos, music, videos, and documents stored on the following digital memory cards:

- Secure digital (SD) memory card
- Secure Digital High Capacity (SDHC) card
- Multi Media Card (MMC)
- Memory Stick

Computer Base and Keyboard Features

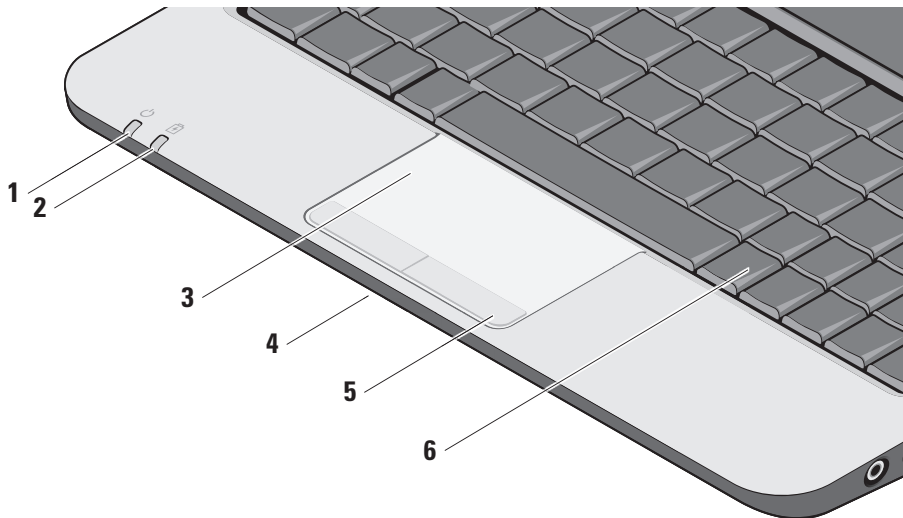

- 1 Power indicator light** – Turns on when the system is powered on.

The light operates as follows:

- Solid white: The system is on.
- Flashing white: The system is in standby mode.
- Off: The system is off or in hibernate mode.

- 2 Battery status light** – Flashes amber light to indicate that the battery charge is low. Connect to an AC adapter to charge the battery.

- 3 Touch pad** – Provides the functionality of a mouse to move the cursor, drag or move selected items, and left-click by tapping the surface.

- 4 Integrated single analog microphone** – Provides quality sound for video chatting and voice recording.

- 5 Touch pad buttons** – Provide left- and right-click functions like those on a mouse.

- 6 Keyboard** – The settings for this keyboard can be personalized by using the system setting utility.

Display Features

The display panel holds an optional camera and accompanying dual microphones.

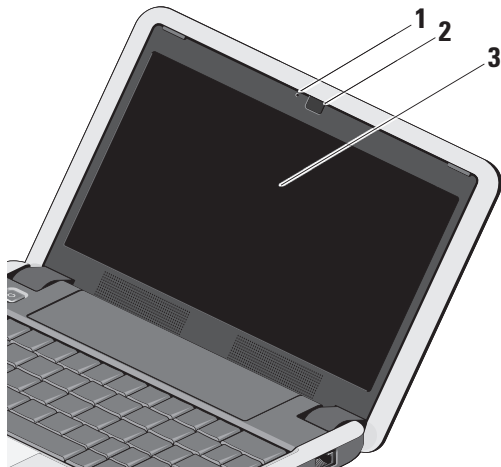

1 Camera activity light (optional)

– Indicates when the camera is on or off. Based on selections you made when purchasing your computer, your computer may not include a camera.

2 Camera (optional)

– Built-in camera for video capture, conferencing, and chat. Based on the selections you made when purchasing your computer, your computer may not include a camera.

3 Display

– Your display can vary based on selections you made when purchasing your computer. For more information about displays, see the *Dell Technology Guide*.

Removing and Replacing the Battery

⚠ CAUTION: Using an incompatible battery may increase the risk of fire or explosion. This computer should only use a battery purchased from Dell. Do not use batteries from other computers.

⚠ CAUTION: Before removing the battery, shut down the computer, and remove external cables (including the AC adapter).

To remove the battery:

1. Shut down the computer and turn it over.
2. Slide the battery release latch to the unlock position and hold.
3. Slide the battery out.

To replace the battery, slide it into the bay until it clicks into place.

- 1 Battery
- 2 Battery release latch (2)

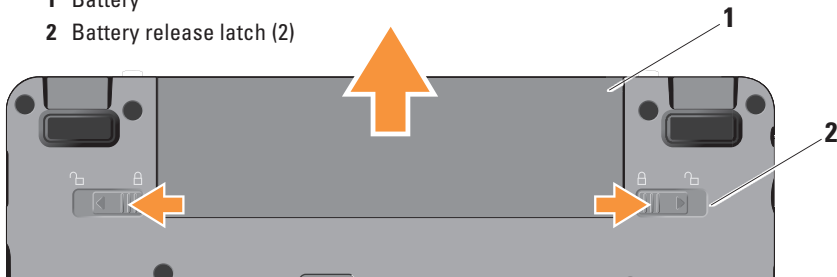

Software Features

 **NOTE:** For more information about the features described in this section, see the *Dell Technology Guide* on your hard drive or on the Dell Support website at support.dell.com.

Productivity and Communication

You can use your computer to create presentations, brochures, greeting cards, fliers, and spreadsheets depending on the applications installed in your computer. Check your purchase order for software installed on your computer.

After connecting to the Internet, you can access websites, setup an e-mail account, upload and download files, and so on.

Entertainment and Multimedia

You can use your computer to watch videos, play games, listen to music and internet radio stations.

Customizing the Desktop in Windows XP

You can customize your desktop to change the appearance, resolution, wallpaper, screensaver, and so on by accessing the **Display Properties** window.

To access the display properties window:

1. Right-click an open area of the desktop.
2. Click **Properties**, to open the **Display Properties** window and learn more about your customization options.

Solving Problems

Network Problems

Wireless Connections

If the wireless network connection is lost

— You can manage the Wireless LAN using *Windows Wireless Network Connections*, accessed from Control Panel.

— Interference may be blocking or interrupting your wireless connection. Try moving the computer closer to your wireless router

Wired Connections

If the network connection is lost — The cable is loose or damaged.

- Check the cable to ensure it is plugged in and not damaged.

The link integrity light on the integrated network connector lets you verify that your connection is working and provides information on the status:

- Green — A good connection exists between a 10-Mbps network and the computer.
- Orange — A good connection exists between a 100-Mbps network and the computer.
- Off — The computer is not detecting a physical connection to the network.

 **NOTE:** The link integrity light on the network connector is only for the wired cable connection. The link integrity light does not provide status for wireless connections.

 **NOTE:** If you cannot connect to the Internet but have successfully connected in the past, the ISP might have a service outage. Contact your ISP to check the service status, or try connecting again later.

Power Problems

If the power light is off — The computer is either turned off or is not receiving power.

- Reseat the power cable into both the power connector on the computer and the electrical outlet.
- If the computer is plugged into a power strip, ensure that the power strip is plugged into an electrical outlet and that the power strip is turned on. Also bypass power protection devices, power strips, and power extension cables to verify that the computer turns on properly.
- Ensure that the electrical outlet is working by testing it with another device, such as a lamp.
- Check the AC adapter cable connections. If the AC adapter has a light, ensure that the light on the AC adapter is on.

If the power light is solid white and the computer is not responding — The display may not be responding. Press the power button until the computer turns off and then turn it back on. If the problem persists, see the *Dell Technology Guide* on your computer or on the Dell Support website at support.dell.com.

If the power light is blinking white — The computer is in standby mode. Press a key on the keyboard, move the pointer using the touch pad or a connected mouse, or press the power button to resume normal operation.

If you encounter interference that hinders reception on your computer — An unwanted signal is creating interference by interrupting or blocking other signals. Some possible causes of interference are:

- Power, keyboard, and mouse extension cables.
- Too many devices connected to a power strip.

- Multiple power strips connected to the same electrical outlet.

Memory Problems

If you receive an insufficient memory message—

- Save and close any open files and exit any open programs you are not using to see if that resolves the problem.
- See the software documentation for minimum memory requirements. If necessary, install additional memory (See the *Service Manual* on the Dell Support website at support.dell.com).
- Reseat the memory modules (See the *Service Manual* on the Dell Support website at support.dell.com) to ensure that your computer is successfully communicating with the memory.

If you experience other memory problems —

- Ensure that you are following the memory installation guidelines (see the *Service Manual* on the Dell Support website at support.dell.com).
- Check if the memory module is compatible with your computer. Your computer supports DDR2 memory. For more information about the type of memory supported by your computer, see “Basic Specifications” on page 40.
- Run the Dell Diagnostics (see “Dell Diagnostics” on page 28).
- Reseat the memory modules (see the *Service Manual* on the Dell Support website at support.dell.com) to ensure that your computer is successfully communicating with the memory.

Lockups and Software Problems



If the computer does not start up — Ensure that the power cable is firmly connected to the computer and to the electrical outlet.

Solving Problems

If a program stops responding — End the program:

1. Press <Ctrl><Shift><Esc> simultaneously.
2. Click **Applications**.
3. Click the program that is no longer responding
4. Click **End Task**.

If a program crashes repeatedly — Check the software documentation. If necessary, uninstall and then reinstall the program.

-  **NOTE:** Software usually includes installation instructions in its documentation or on the media (CD or DVD).
-  **NOTE:** Your computer may or may not have an optical drive. Use an external optical drive or any external storage device for the procedures that involve media.

If the computer stops responding —

-  **NOTICE:** You might lose data if you are unable to perform an operating system shutdown.

Turn the computer off. If you are unable to get a response by pressing a key on your keyboard or moving your mouse, press the power button for at least 8 to 10 seconds until the computer turns off and then restart your computer.

If a program is designed for an earlier Microsoft® Windows® operating system —

Run the Program Compatibility Wizard. The Program Compatibility Wizard configures a program so that it runs in an environment similar to non-Windows XP operating system environments.

1. Click **Start** → **All Programs** → **Accessories** → **Program Compatibility Wizard**.
2. In the welcome screen, click **Next**.
3. Follow the instructions on the screen.

If a solid blue screen appears — Turn the computer off. If you are unable to get a response by pressing a key on your keyboard or moving your pointer using the touch pad or mouse, press and hold the power button for at least 8 to 10 seconds until the computer turns off and then restart your computer.

If you have other software problems —

- Back up your files immediately.
- Use a virus-scanning program to check the hard drive or CDs.
- Save and close any open files or programs and shut down your computer through the **Start** menu.
- Check the software documentation or contact the software manufacturer for troubleshooting information:
 - Ensure that the program is compatible with the operating system installed on your computer.

- Ensure that your computer meets the minimum hardware requirements needed to run the software. See the software documentation for information.
- Ensure that the program is installed and configured properly.
- Verify that the device drivers do not conflict with the program.
- If necessary, uninstall and then reinstall the program.
- Write down any error message that is displayed to help in troubleshooting.

Using Support Tools

 **NOTE:** The instructions in this section are for computers with Windows XP operating system installed.

Dell Support Center

The **Dell Support Center** helps you find the service, support, and system-specific information you need. For more information about **Dell Support Center** and available support tools, click the **Services** tab at support.dell.com.



Click the  icon in the taskbar to run the application. The home page provides links to access:

- Self Help (Troubleshooting, Security, System Performance, Network/Internet, Backup/Recovery, and Windows operating system)
- Alerts (technical support alerts relevant to your computer)

- Assistance from Dell (Technical Support with DellConnect™, Customer Service, Training and Tutorials, How-To Help with Dell on Call, and Online Scan with PCCheckUp)
- About Your System (System Documentation, Warranty Information, System Information, Upgrades & Accessories)

The top of the **Dell Support Center** home page displays your computer's model number along with its service tag and express service code.

For more information about the **Dell Support Center**, see the *Dell Technology Guide* on your hard drive or on the Dell Support website at support.dell.com.

System Messages

If your computer has an issue or error, it may display a System Message that will help you identify the cause and action needed to resolve the issue.

 **NOTE:** If the message you received is not listed in the following examples, see the documentation for either the operating system or the program that was running when the message appeared. Alternatively you could see the *Service Manual* on the Dell Support website at support.dell.com or see “Contacting Dell” on page 37 for assistance.

Alert! Previous attempts at booting this system have failed at checkpoint [nnnn]. For help in resolving this problem, please note this checkpoint and contact Dell Technical Support — The computer failed to complete the boot routine three consecutive times for the same error see “Contacting Dell” on page 37 for assistance.

CMOS checksum error — Possible motherboard failure or RTC battery low. Replace the battery. See the *Service Manual* on the Dell Support website at support.dell.com or see “Contacting Dell” on page 37 for assistance.

Hard-disk (HDD) drive failure — Possible hard disk drive failure during HDD POST, see “Contacting Dell” on page 37 for assistance.

Hard-disk (HDD) drive read failure — Possible hard disk drive failure during HDD boot test see “Contacting Dell” on page 37 for assistance.

Keyboard failure — Keyboard failure or loose cable.

No boot device available — No bootable partition on hard disk drive, the hard disk drive connector is loose, or no bootable device exists.

- If the hard drive is your boot device, ensure that the connector is connected and that the drive is installed properly and partitioned as a boot device.

Using Support Tools

- Enter system setup and ensure that the boot sequence information is correct (see the *Service Manual* on the Dell Support website at support.dell.com).

No timer tick interrupt — A chip on the system board might be malfunctioning or motherboard failure (see the *Service Manual* on the Dell Support website at support.dell.com).

USB over current error — Disconnect the USB device. Your USB device needs more power for it to function properly. Use an external power source to connect the USB device, or if your device has two USB cables, connect both of them.

NOTICE - Hard Drive SELF MONITORING SYSTEM has reported that a parameter has exceeded its normal operating range. Dell recommends that you back up your data regularly. A parameter out of range may or may not indicate a potential hard drive problem — S.M.A.R.T error, possible hard disk drive failure. This feature can be enabled or disabled in the

BIOS setup (see “Contacting Dell” on page 37 for assistance).

Hardware Troubleshooter

If a device is either not detected during the operating system setup or is detected but incorrectly configured, you can use the **Hardware Troubleshooter** to resolve the incompatibility.

To start the Hardware Troubleshooter:

1. Click **Start** → **Help and Support**.
2. Type `hardware troubleshooter` in the search field and press <Enter> to start the search.
3. In the search results, select the option that best describes the problem and follow the remaining troubleshooting steps.

Dell Diagnostics

If you experience a problem with your computer, perform the checks in “Lockups and Software Problems” on page 23 and run the

Dell Diagnostics before you contact Dell for technical assistance.

It is recommended that you print these procedures before you begin.

➔ **NOTICE:** Dell Diagnostics works only on Dell computers.

 **NOTE:** The *Drivers and Utilities* media is optional and may not ship with your computer.

See the System Setup section in the *Service Manual* to review your computer's configuration information, and ensure that the device that you want to test displays in the system setup program and is active.

Start the Dell Diagnostics from your hard drive or from the *Drivers and Utilities* media.

Starting Dell Diagnostics From Your Hard Drive

The Dell Diagnostics is located on a hidden diagnostic utility partition on your hard drive.

 **NOTE:** If your computer cannot display a screen image, see “Contacting Dell” on page 37.

1. Ensure that the computer is connected to an electrical outlet that is known to be working properly.
2. Turn on (or restart) your computer.
3. When the DELL™ logo appears, press <0> immediately. Select **Diagnostics** from the boot menu and press <Enter>.

 **NOTE:** If you wait too long and the operating system logo appears, continue to wait until you see the Microsoft® Windows® desktop; then, shut down your computer and try again.

 **NOTE:** If you see a message stating that no diagnostics utility partition has been found, run the Dell Diagnostics from the *Drivers and Utilities* media.

4. Press any key to start the Dell Diagnostics from the diagnostics utility partition on your hard drive.

Using Support Tools

Starting Dell Diagnostics From the Drivers and Utilities Media

 **NOTE:** Your computer may or may not have an optical drive. Use an external optical drive or any external storage device for the procedures that involve media.

1. Insert the *Drivers and Utilities* media.
2. Shut down and restart the computer.
When the DELL logo appears, press <0> immediately.

 **NOTE:** If you wait too long and the operating system logo appears, continue to wait until you see the Microsoft® Windows® desktop; then, shut down your computer and try again.

 **NOTE:** The next steps change the boot sequence for one time only. On the next start-up, the computer boots according to the devices specified in the system setup program.

3. When the boot device list appears, highlight **CD/DVD/CD-RW** and press <Enter>.
4. Select the **Boot from CD-ROM** option from the menu that appears and press <Enter>.
5. Type 1 to start the CD menu and press <Enter> to proceed.
6. Select **Run the 32 Bit Dell Diagnostics** from the numbered list. If multiple versions are listed, select the version appropriate for your computer.
7. When the Dell Diagnostics **Main Menu** appears, select the test you want to run.

Restoring Your Operating System

If you received an Operating System media with your computer, you can use it to restore your operating system. However, using the Operating System media also deletes all data on the hard drive.

 **NOTE:** Your computer may or may not have an optical drive. Use an external optical drive or any external storage device for the procedures that involve media.

Windows Operating System Reinstallation

Before you Begin

If you are considering reinstalling the Windows operating system to correct a problem with a newly installed driver, first try using Windows Device Driver Rollback.

 **NOTICE:** Before performing the installation, back up all data files on your primary hard drive. For conventional hard drive configurations, the primary hard drive is the first drive detected by the computer.

To reinstall Windows, you need the following items:

- *Dell Operating System* media
- *Dell Drivers and Utilities* media

 **NOTE:** The *Dell Drivers and Utilities* media contains drivers that were installed during the assembly of the computer. Use the *Dell Drivers and Utilities* media to load any required drivers. Depending on the region from which you ordered your computer, or whether you requested the media, the *Dell Drivers and Utilities* media and *Operating System* media may not ship with your computer.

Restoring Your Operating System

Reinstalling Windows XP

The reinstallation process can take one to two hours to complete. After you reinstall the operating system, you must also reinstall the device drivers, virus protection program, and other software.

1. Save and close any open files and exit any open programs.
2. Insert the *Operating System* media.
3. Click **Exit** if the **Install Windows** message appears.
4. Restart the computer.
5. When the DELL logo appears, press <0> immediately.

 **NOTE:** If you wait too long and the operating system logo appears, continue to wait until you see the Microsoft® Windows® desktop; then, shut down your computer and try again.

 **NOTE:** The next steps change the boot sequence for one time only. On the next start-up, the computer boots according to the devices specified in the system setup program.

6. When the boot device list appears, highlight **CD/DVD/CD-RW Drive** and press <Enter>.

 **NOTE:** Your computer may or may not have an optical drive. Use an external optical drive or any external storage device for the procedures that involve media.

7. Press any key to **Boot from CD-ROM**. Follow the instructions on the screen to complete the installation.

Getting Help

If you experience a problem with your computer, you can complete the following steps to diagnose and troubleshoot the problem:

1. See “Solving Problems” on page 20 for information and procedures that pertain to the problem your computer is experiencing.
2. See “Dell Diagnostics” on page 28 for procedures on how to run Dell Diagnostics.
3. Fill out the “Diagnostic Checklist” on page 36.
4. Use Dell’s extensive suite of online services available at Dell Support (support.dell.com) for help with installation and troubleshooting procedures. See “Online Services” on page 34 for a more extensive list of Dell Support online.
5. If the preceding steps have not resolved the problem, see “Before You Call” on page 36 and then “Contacting Dell” on page 37.

 **NOTE:** Call Dell Support from a telephone near or at the computer so that the support staff can assist you with any necessary procedures.

 **NOTE:** Dell’s Express Service Code system may not be available in all countries.

When prompted by Dell’s automated telephone system, enter your Express Service Code to route the call directly to the proper support personnel. If you do not have an Express Service Code, open the **Dell Accessories** folder, double-click the **Express Service Code** icon, and follow the directions.

 **NOTE:** Some of the services mentioned below are not always available in all locations outside the continental U.S. Call your local Dell representative for information on availability.

Getting Help

Technical Support and Customer Service

Dell's support service is available to answer your questions about Dell hardware. Our support staff use computer-based diagnostics to provide fast, accurate answers.

To contact Dell's support service, see "Before You Call" on page 36 and then see the contact information for your region or go to **support.dell.com**.

Online Services

You can learn about Dell products and services on the following websites:

- **www.dell.com**
- **www.dell.com/ap** (Asian/Pacific countries only)
- **www.dell.com/jp** (Japan only)
- **www.euro.dell.com** (Europe only)

- **www.dell.com/la** (Latin American and Caribbean countries)
- **www.dell.ca** (Canada only)

You can access Dell Support through the following websites and e-mail addresses:

Dell Support websites

- **support.dell.com**
- **support.jp.dell.com** (Japan only)
- **support.euro.dell.com** (Europe only)

Dell Support e-mail addresses

- **mobile_support@us.dell.com**
- **support@us.dell.com**
- **la-techsupport@dell.com** (Latin America and Caribbean countries only)
- **apsupport@dell.com** (Asian/Pacific countries only)

Dell Marketing and Sales e-mail addresses

- **apmarketing@dell.com** (Asian/Pacific countries only)

- **sales_canada@dell.com** (Canada only)

Anonymous file transfer protocol (FTP)

- **ftp.dell.com**

Log in as user: `anonymous`, and use your e-mail address as your password.

AutoTech Service

Dell's automated support service—AutoTech—provides recorded answers to the questions most frequently asked by Dell customers about their portable and desktop computers.

When you call AutoTech, use your touch-tone telephone to select the subjects that correspond to your questions. For instructions on accessing the telephone number to call your region, see “Contacting Dell” on page 37.

Automated Order-Status Service

To check on the status of any Dell products that you have ordered, you can go to **support.dell.com**, or you can call the automated order-status service. A recording prompts you

for the information needed to locate and report on your order. For the telephone number to call your region, see “Contacting Dell” on page 37 for problems with your order.

If you have a problem with your order, such as missing parts, wrong parts, or incorrect billing, contact Dell for customer assistance. Have your invoice or packing slip handy when you call. For the telephone number to call for your region, see “Contacting Dell” on page 37.

Product Information

If you need information about additional products available from Dell, or if you would like to place an order, visit the Dell website at **www.dell.com**. For the telephone number to call for your region or to speak to a sales specialist, see “Contacting Dell” on page 37.

Before You Call

 **NOTE:** Have your Express Service Code ready when you call. The code helps Dell's automated-support telephone system direct your call more efficiently. You may also be asked for your Service Tag (located on the back or bottom of your computer).

Remember to fill out the following Diagnostics Checklist. If possible, turn on your computer before you call Dell for assistance and call from a telephone at or near the computer. You may be asked to type some commands at the keyboard, relay detailed information during operations, or try other troubleshooting steps possible only at the computer itself. Ensure that the computer documentation is available.

Diagnostic Checklist

- Name:
- Date:
- Address:
- Phone number:
- Service Tag (bar code on the back or bottom of the computer):
- Express Service Code:
- Return Material Authorization Number (if provided by Dell support technician):
- Operating system and version:
- Devices:
- Expansion cards:
- Are you connected to a network? Yes /No
- Network, version, and network adapter:
- Programs and versions:

See your operating system documentation to determine the contents of the computer's start-up files. If the computer is connected to

a printer, print each file. Otherwise, record the contents of each file before calling Dell.

- Error message, beep code, or diagnostic code:
- Description of problem and troubleshooting procedures you performed:

Contacting Dell

 **NOTE:** See “Before You Call” on page 36 before you contact Dell.

For customers in the United States, call 800-WWW-DELL (800-999-3355).

 **NOTE:** If you do not have an active Internet connection, you can find contact information on your purchase invoice, packing slip, bill, or Dell product catalog.

Dell provides several online and telephone-based support and service options. Availability varies by country and product, and some services may not be available in your area.

To contact Dell for sales, technical support, or customer service issues:

1. Visit **support.dell.com**.
2. Verify your country or region in the **Choose A Country/Region** drop-down menu at the bottom of the page.
3. Click **Contact Us** on the left side of the page.
4. Select the appropriate service or support link based on your need.
5. Choose the method of contacting Dell that is convenient for you.

Finding More Information and Resources

If you need to:

reinstall your operating system.

run a diagnostic program for your computer, reinstall notebook system software, or update drivers for your computer, and readme files.

learn more about your operating system, maintaining peripherals, RAID, Internet, Bluetooth[®], networking, and e-mail.

upgrade your computer with new or additional memory, or a new hard drive.

reinstall or replace a worn or defective part.

See:

your Operating System media.

the *Drivers and Utilities* media.



NOTE: Drivers and documentation updates can be found on the Dell™ Support website at support.dell.com.

the *Dell Technology Guide* installed on your hard drive.

the *Service Manual* on the Dell Support website at support.dell.com



NOTE: In some countries, opening and replacing parts of your computer may void your warranty. Check your warranty and return policies before working inside your computer.

Finding More Information and Resources

If you need to:

find safety best practices information for your computer

review Warranty information, Terms and Conditions (U.S. only), Safety instructions, Regulatory information, Ergonomics information, and End User License Agreement.

find your Service tag/Express Service Code— You must use the service tag to identify your computer on **support.dell.com** or to contact technical support.

find drivers and downloads.

access technical support and product help.

check on your order status for new purchases.

find solutions and answers to common questions.

locate information for last-minute updates about technical changes to your computer or advanced technical-reference material for technicians or experienced users.

See:

the safety and regulatory documents that shipped with your computer and also see the Regulatory Compliance Homepage at **www.dell.com/regulatory_compliance**.

the back or bottom of your computer.

the Dell™ Support website at **support.dell.com**.

Basic Specifications

System Model - Dell Inspiron 910

This section provides basic information that you may need when setting up, updating drivers for, and upgrading your computer. For more detailed specifications, see the *Service Manual* on the Dell Support website at support.dell.com.

 **NOTE:** Offerings may vary by region. For more information regarding the configuration of your computer, click **Start** → **Help and Support** and select the option to view information about your computer.

Processor

Type	Intel® Atom™ N270
L2 cache	512 KB
External bus frequency	533 MHz

Memory

Connectors	one internally-accessible SO-DIMM socket
Capacities	512 MB, and 1 GB
Memory type	533/667/800 MHz DDR2 SO-DIMM
Memory configuration possible	512 MB, 1 GB

 **NOTE:** For instructions on upgrading your memory, see the *Service Manual* on the Dell Support website at support.dell.com.

Computer Information

System Chipset	Intel 945GSE
Data bus width	64 bits
DRAM bus width	single channel 64-bit buses
Processor address bus width	32 bits
Flash EPROM	1 MB
PCI Bus	32 bits

Communications

Modem type	External V.92 56K USB Modem
Modem interface	Universal Serial Bus (USB)

Communications

Network adapter	10/100 Ethernet LAN on system board
Wireless	internal WLAN, WWAN (Mini-Card), Bluetooth® wireless technology

Video

video controller	Intel 945GSE UMA
video memory	8 MB of system memory
LCD interface	LVDS

Basic Specifications

Audio

Audio type	2 channel High Definition Audio
Audio controller	ALC268
Stereo conversion	24-bit (analog-to-digital and digital-to-analog)
Internal Interface	Intel High Definition Audio
External Interface	integrated analog microphone, microphone-in connector, stereo headphones/speakers connector
Speaker	two 4-ohm speakers
Internal speaker amplifier	0.5 watt per channel into 4 ohm
Volume controls	program menus

Ports and Connectors

Audio	integrated analog microphone, microphone connector, one stereo headphone/speakers connector
Mini-Card	two Type IIIA Full Mini Card slot
Network adapter	RJ-45 port
USB	three 4-pin USB 2.0-compliant connectors
Video	15-hole connector

Basic Specifications

Display

Type (TrueLife)	8.9 inch WSVGA
<i>Dimensions:</i>	
Height	129.55 mm (5.1 in)
Width	213.36 mm (8.2 in)
Maximum resolution	1024 x 600
Refresh rate	60 Hz
Operating angle	0° (closed) to 135°
Luminance	162 min. 180 typ. cd/ m ² (5 point avg)

Viewing Angles:

Horizontal	±40° (LED) min.
Vertical	+15°/–30° (LED) min.
Pixel pitch	0.1905x0.189 mm
Controls	brightness can be controlled through keyboard shortcuts (see <i>Dell Technology Guide</i> for more information.)

Keyboard

Number of keys	61 (U.S. and Canada); 66 (Europe); 68 (Japan); 62 (Korea)
----------------	---

Basic Specifications

Camera (optional)

Pixel	0.3 megapixel 1.3 megapixel
Video resolution	320x240 ~1280x1024 (640x480 at 30fps)
Diagonal viewing angle	66°

Touchpad

X/Y position resolution (graphics table mode)	240 cpi
<i>Size:</i>	
Width	62 mm (2.44 in) sensor-active area
Height	32.5 mm (1.28 in) rectangle

Battery

Type	4-cell lithium ion
Depth	58.23 mm (2.30 inches)
Height	21.5 mm (0.8 in)
Width	140.6 mm (5.54 in)
Weight	0.23 kg (0.5 lb)
Voltage	14.8 VDC

Charge time (approximate):

Computer off	4 hours
--------------	---------

Basic Specifications

Battery

Operating time	Battery operating time varies depending on operating conditions and can be significantly reduced under certain power-intensive conditions. <i>See Dell Technology Guide</i> for more information.
Life span (approximate)	300 discharge/charge cycles
<i>Temperature range:</i>	
Operating	0° to 35°C (32° to 95°F)
Storage	-40° to 65°C (-40° to 149°F)
Coin-cell battery	CR-2032

AC Adapter

Input voltage	100–240 VAC
Input current (maximum)	1.0 A
Input frequency	50–60 Hz
Output power	30 W
Output current	1.58 A (maximum)
Rated output voltage	19.0 VDC
<i>Dimensions:</i>	
30 W (APD)	
Height	59.2 mm (2.33 in)
Width	34.0 mm (1.34 in)
Depth	85.0 mm (3.35 in)
Weight (with cables)	0.15 kg (0.33 lb)
30 W (ESP)	

Basic Specifications

AC Adapter

Height 57.0 mm (2.24 in)

Width 40.0 mm (1.57 in)

Depth 80.0 mm (3.15in)

Weight (with cables) 0.18 kg (0.40 lb)

30 W (PI)

Height 70.0 mm (2.76 in)

Width 36.0 mm (1.42 in)

Depth 78.0 mm (3.07in)

Weight (with cables) 0.156 kg (0.34 lb)

Physical

Height 27.2 mm to 31.7 mm
(1.07 in to 1.25 in)

Width 232 mm (9.1 in)

Physical

Depth 172 mm (6.80 in)

Weight (with 4-cell
battery):

Configurable to less
than 1.07 kg (2.36 lb)

Computer Environment

Temperature range:

Operating 0° to 35°C (32° to
95°F)

Storage -40° to 65°C (-40° to
149°F)

Relative humidity (maximum):

Operating 10% to 90%
(noncondensing)

Storage 5% to 95%
(noncondensing)

Basic Specifications

Computer Environment

Maximum vibration (using a random-vibration spectrum that simulates user environment):

Operating 0.66 GRMS

Storage 1.3 GRMS

Maximum shock (measured with hard drive in head-parked position and a 2-ms half-sine pulse):

Operating 110 G

Storage 163 G

Computer Environment

Altitude (maximum):

Operating -15.2 to 3048 m
(-50 to 10,000 ft)

Storage -15.2 to 10,668 m
(-50 to 35,000 ft)

Airborne contaminant level G2 or lower
as defined by
ISA-S71.04-1985

Index

A

- AC adapter
 - size and weight **45, 46**
- airflow, allowing **5**
- AutoTech **35**

C

- calling Dell **36**
- chipset **41**
- computer, setting up **5**
- connect(ing)
 - to the Internet **9**
- Contacting Dell online **37**
- customer service **34**

D

- damage, avoiding **5**
- Dell Support Center **26**
- Dell support website **39**
- Dell Technology Guide
 - for further information **38**
- Diagnostic Checklist **36**
- drivers and downloads **39**

E

- e-mail addresses
 - for technical support **34**
- expansion bus **41**

F

- finding more information **38**
- FTP login, anonymous **35**

H

hardware problems

diagnosing **28**

Hardware Troubleshooter **28**

help

getting assistance and support **33**

I

Internet connection **9**

ISP

Internet Service Provider **9**

M

memory problems

solving **23**

memory support **40**

Microsoft® Windows® XP

Program Compatibility Wizard **24**

reinstalling **32**

setup **9**

N

network connection

fixing **21**

O

order status **35**

P

power problems, solving **22**

power strips, using **6**

problems, solving **21**

processor **40**

products

information and purchasing **35**

Index

R

reinstalling

Windows **31**

resources, finding more **38**

S

setup, before you begin **5**

software features **20**

software problems **23**

solving problems **21**

specifications **40**

support e-mail addresses **34**

support sites

worldwide **34**

System Messages **27**

system reinstall options **31**

T

technical support **34**

50

V

ventilation, ensuring **5**

W

Windows, reinstalling **31**

wired network

network cable, connecting **7**

wireless network connection **21**





Printed in the U.S.A.

www.dell.com | support.dell.com



0M770HA00

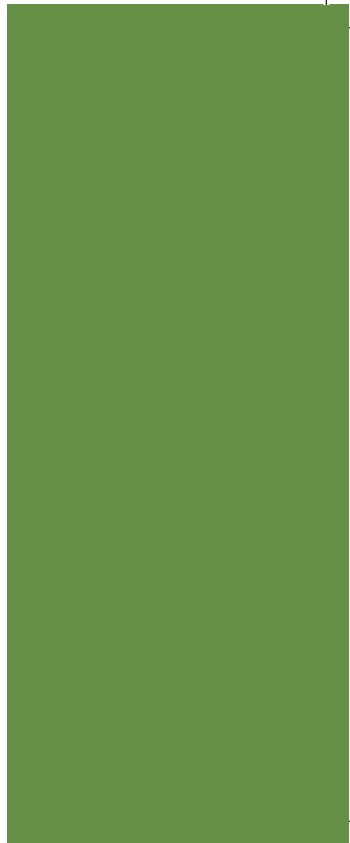



Printed in Malaysia.

www.dell.com | support.dell.com



OM770HA00





Printed in Ireland.

www.dell.com | support.dell.com



0M770HA00

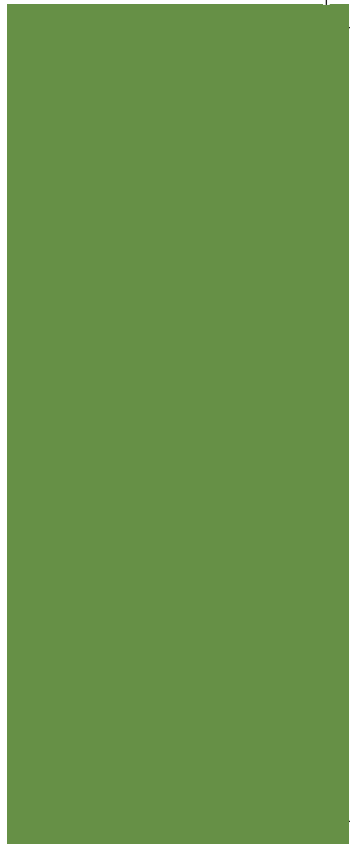



Printed in Brazil.

www.dell.com | support.dell.com



0M770HA00

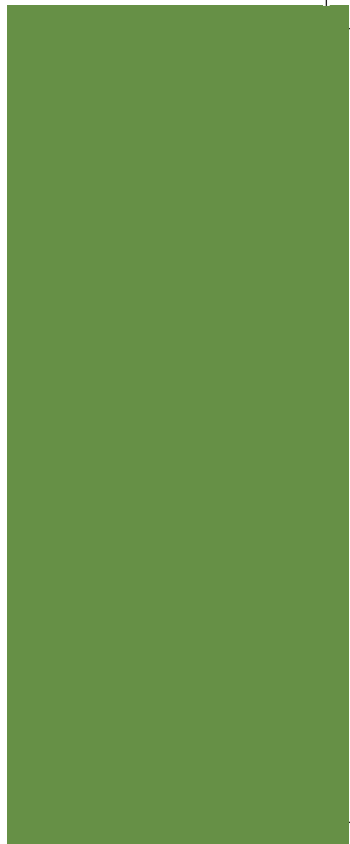



Printed in China.
Printed on recycled paper.

www.dell.com | support.dell.com



0M770HA00

