





# Dell™ Latitude™ E6400 XFR

## Setup and Features Information

 **WARNING:** A WARNING indicates a potential for property damage, personal injury, or death.

 **CAUTION:** A CAUTION indicates either potential damage to hardware or loss of data and tells you how to avoid the problem.

 **NOTE:** A NOTE indicates important information that helps you make better use of your computer.

### Front View

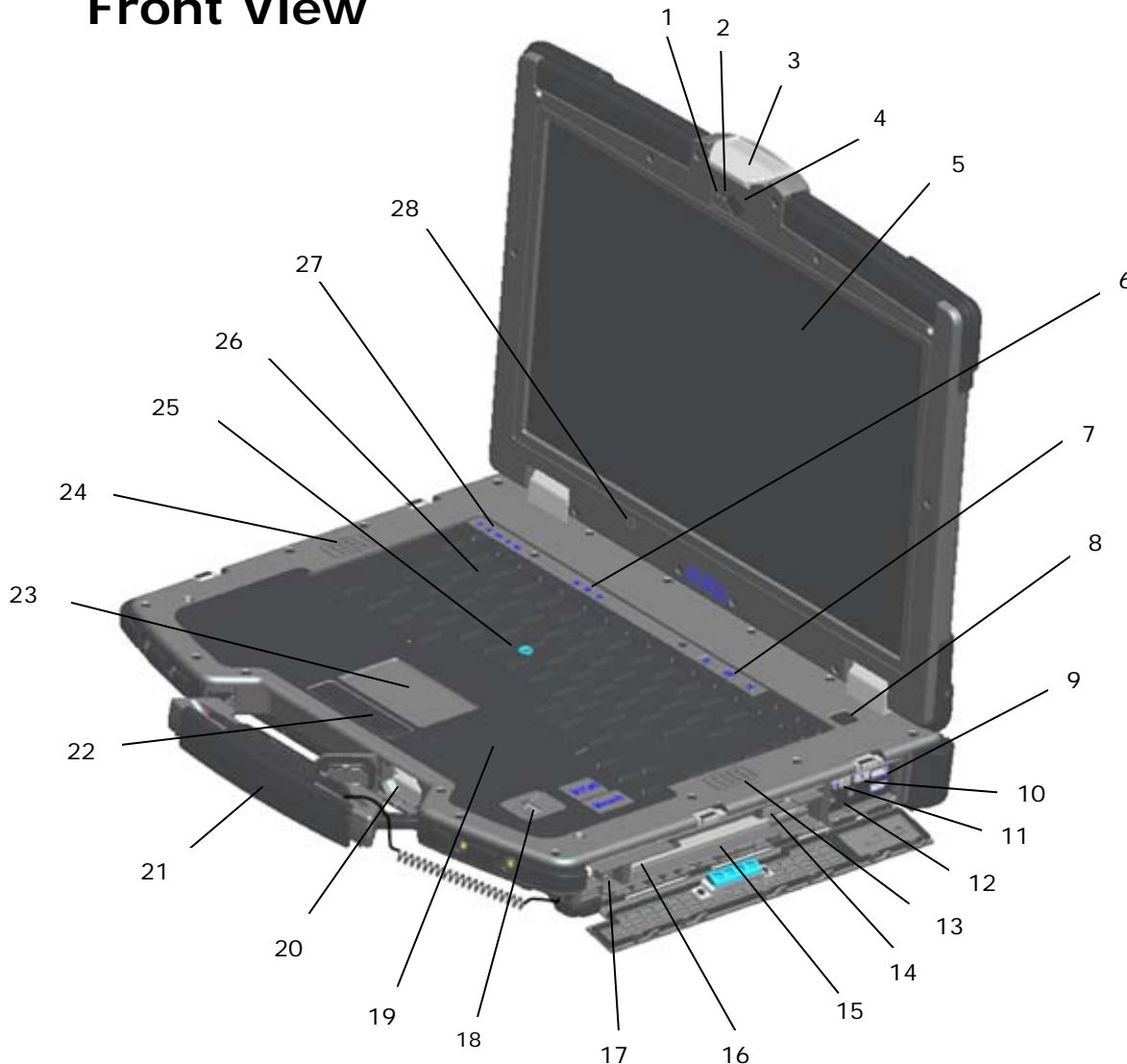

- |    |  |    |   |
|----|--|----|---|
| 1  | Microphone   | 2  | Camera light (optional)                     |
| 3  | Display latch and release                                  | 4  | Camera (optional)                           |
| 5  | DirectVue™ Outdoor-Readable Display (optional touchscreen) | 6  | Keyboard status lights                      |
| 7  | Volume control buttons                                     | 8  | Power button                                |
| 9  | USB connectors (2)   | 10 | Wi-Fi Catcher™ Network Locator              |
| 11 | Wireless switch  | 12 | Audio connectors (2)                        |
| 13 | Right speaker  | 14 | SIM card reader                             |
| 15 | Media bay (with optical drive)                             | 16 | PC or PC-Express card slot (base dependent) |
| 17 | IEEE 1394a connector                                       | 18 | Fingerprint reader (optional)               |
| 19 | Contactless smart-card reader (see Smart Cards)            | 20 | Secure Digital (SD) memory-card reader      |
| 21 | Handle (with optional touchscreen stylus)                  | 22 | Touch pad buttons/Track stick buttons       |
| 23 | Touch pad  | 24 | Left speaker                                |
| 25 | Track stick (not available on sealed rubber keyboard)      | 26 | Keyboard                                    |
| 27 | Device status lights                                       | 28 | Ambient light sensor                        |

## Back View

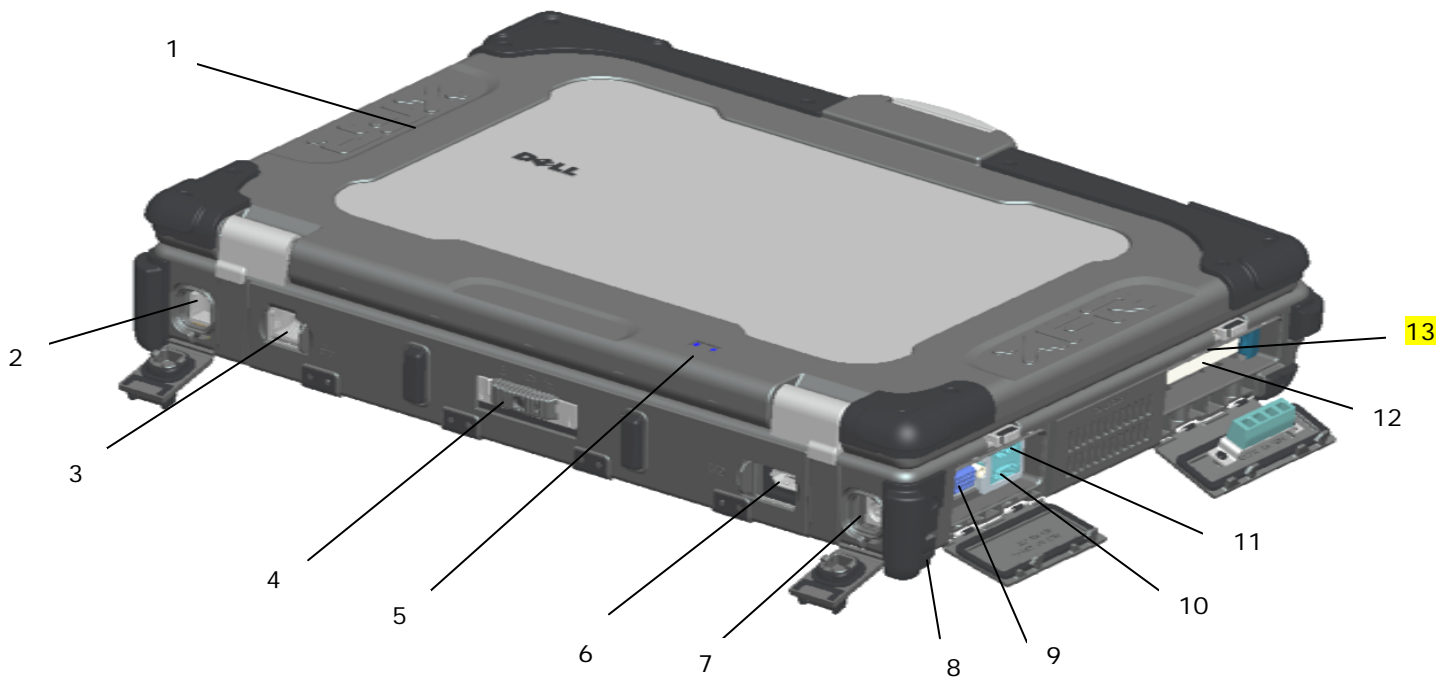

- |   |  |   |                       |
|---|--|---|-----------------------|
| 1 | PR-481™ Ultra-Performance Chassis Material | 2 | RJ-11 modem connector |
| 3 | RJ-45 network connector                    | 4 | Battery access panel  |

- |    |  |    |                       |
|----|--|----|-----------------------|
| 5  | Battery/power lights                                 | 6  | Multimode DisplayPort |
| 7  | AC adapter   | 8  | Security cable slot   |
| 9  | Video connector                                      | 10 | eSATA/USB connector   |
| 11 | USB PowerShare connector                             | 12 | Hard Disk Drive       |
| 13 | Smart-card reader (see <a href="#">Smart Cards</a> ) |    |                       |

**⚠ WARNING:** Do not block, push objects into, or allow dust to accumulate in the air vents. Do not store your Dell™ computer in a low-airflow environment, such as a closed briefcase, while it is running. Restricting the airflow can damage the computer or cause a fire. The computer turns on the fan when the computer gets hot. Fan noise is normal and does not indicate a problem with the fan or the computer.

## Bottom View

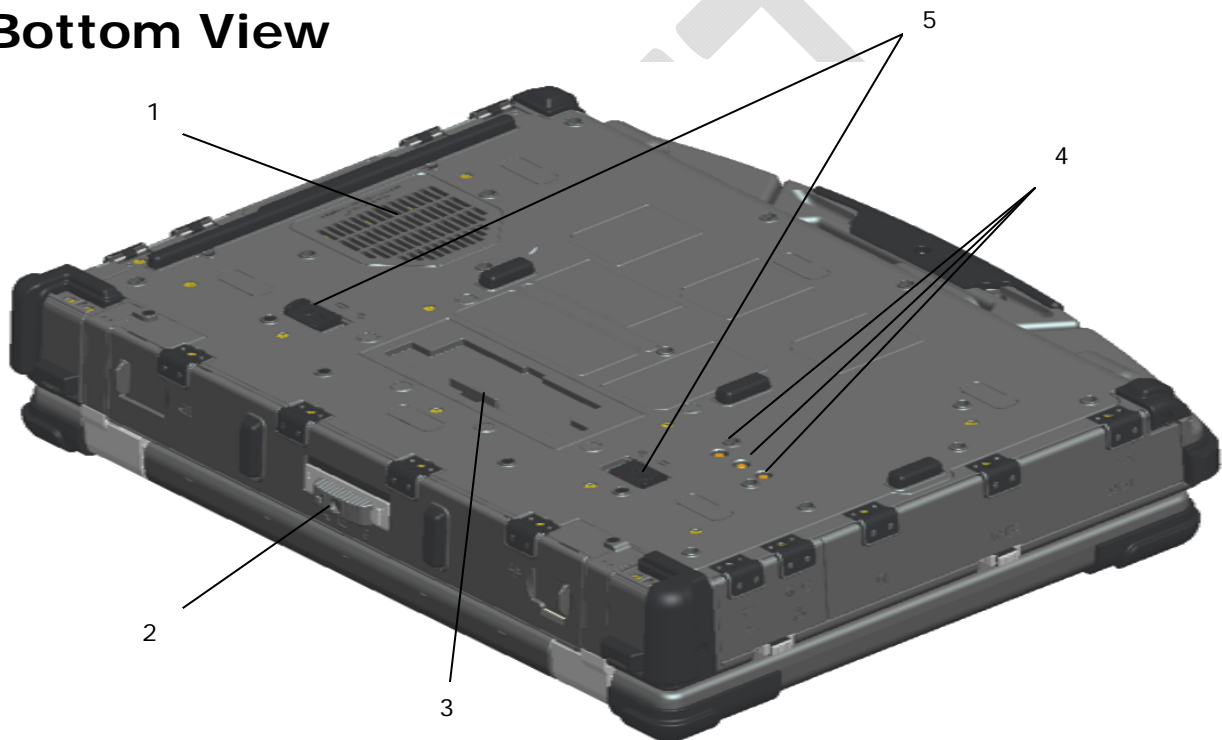

- |   |   |   |   |
|---|---|---|---|
| 1 | QuadCool™ thermal management              | 2 | Battery access panel  |
| 3 | Sliding cover to docking device connector | 4 | RF pass-through connectors (see <a href="#">RF Pass-through</a> ) |
| 5 | Battery latch release                     |   |   |

## Battery Removal

**⚠ CAUTION:** Before you begin any of the procedures in this section, follow the safety instructions that shipped with your computer.

**⚠ CAUTION:** Using an incompatible battery may increase the risk of fire or explosion. Replace the battery only with a compatible battery purchased from Dell. The battery is designed to work with your Dell computer. Do not use a battery from other computers with your computer.

**⚠ CAUTION:** Before removing or replacing the battery, turn off the computer, disconnect

the AC adapter from the electrical outlet and the computer, disconnect the modem from the wall connector and computer, and remove any other external cables from the computer.

1. Release the rear panel.
  - a. Push the latch to the right, to its unlocked position.
  - b. Then, press the latch down.



2. Lower the rear panel.



3. Press in the two battery release latches on the bottom of the computer.



4. Use the tab on the edge of the battery to remove the battery from the computer.



## Battery Installation

1. Insert battery until you hear a click and a mechanical stop.
2. Push the latch down and rotate the door into place.
3. Ensure the door is in the fully closed position, raise the latch up and then push the latch to the left into the locked position.

## Hard Disk Drive Removal

1. Open the hard disk drive door located on the left side panel by pushing the latch towards the rear of the computer,



and rotating the door down.

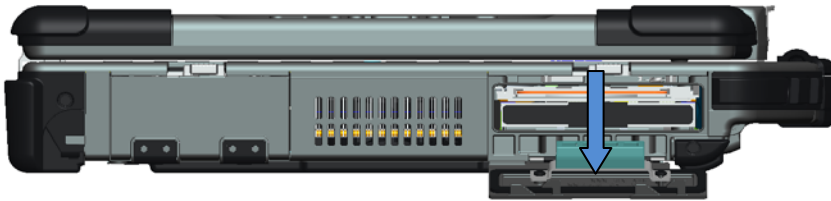

2. To remove the hard disk drive:
  - a. While pressing in the release tab on the right side of the hard disk drive compartment,
  - b. Use the tab on the edge of the hard disk drive to pull the hard disk drive from the compartment.

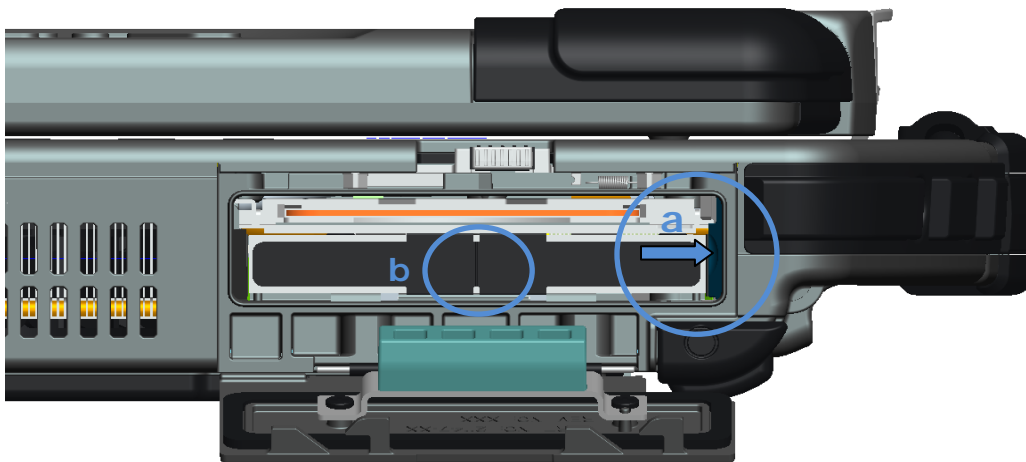

## Hard Drive Installation

1. Insert hard drive until you hear a click and a mechanical stop.
2. Rotate the door into place and press until it clicks into its closed position.

## Operation of the PrimoSeal™ Doors

## Docking Device Connector Door

The docking device connector door is opened by sliding the door towards the front of the computer until it clicks into its open position. Reverse this procedure to close the door.

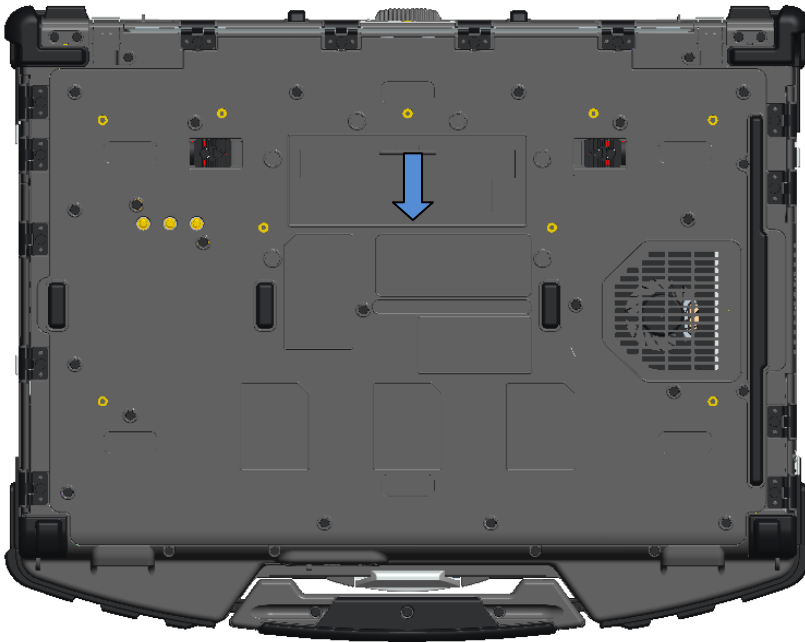

## Press-Fit Door

The press-fit door is opened by inserting a finger into the door slot and pulling the door away from the computer. To close the door, rotate it back into its closed position and press until it clicks into position.



## Latch Door

The latch door is opened by sliding the latch towards the rear of the computer, and then rotating the door down. To close the door, rotate the door back into its closed position and press until you hear it click into position.

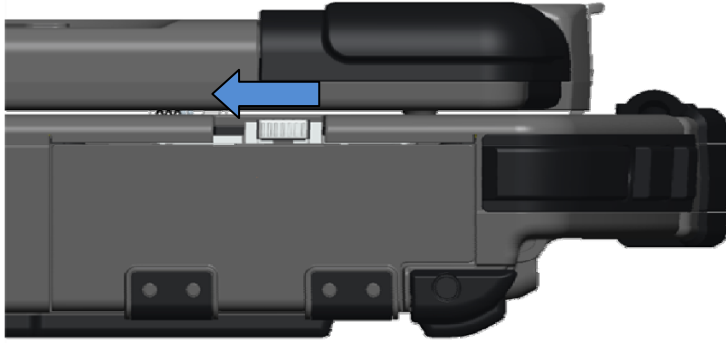



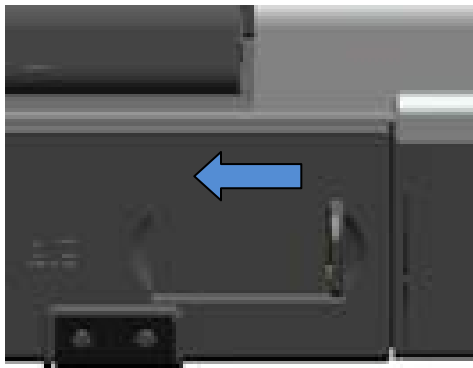

## Slide Insert Door

The slide insert door is opened by sliding the door to its open position until it clicks into position. Reverse the procedure to close the door.



## Quick Setup

-  **WARNING:** Before you begin any of the procedures in this section, follow the safety instructions that shipped with your computer.
  -  **WARNING:** The AC adapter works with electrical outlets worldwide. However, power connectors and power strips vary among countries. Using an incompatible cable or improperly connecting the cable to the power strip or electrical outlet may cause fire or equipment damage.
  -  **CAUTION:** When you disconnect the AC adapter cable from the computer, grasp the connector, not the cable itself, and pull firmly but gently to avoid damaging the cable. When you wrap the AC adapter cable, ensure that you follow the angle of the connector on the AC adapter to avoid damaging the cable.
  -  **NOTE:** Some devices may not be included if you did not order them.
  -  **NOTE:** It is recommended that you turn on and shut down your computer at least once before you install any cards or connect the computer to a docking device or other external device, such as a printer.
1. Connect the AC adapter to the AC adapter connector on the computer and to the electrical outlet.



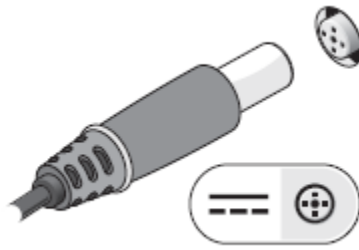

2. Connect the network cable.

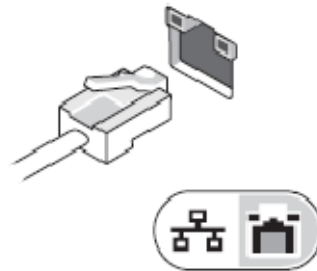

3. Connect USB devices, such as a mouse or keyboard.

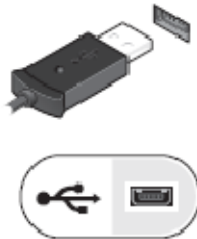

4. Connect IEEE 1394 devices, such as a DVD player.

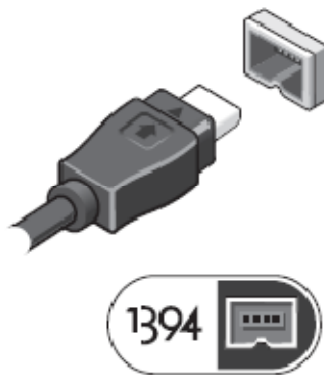

5. Open the computer display and press the power button to turn on the computer.

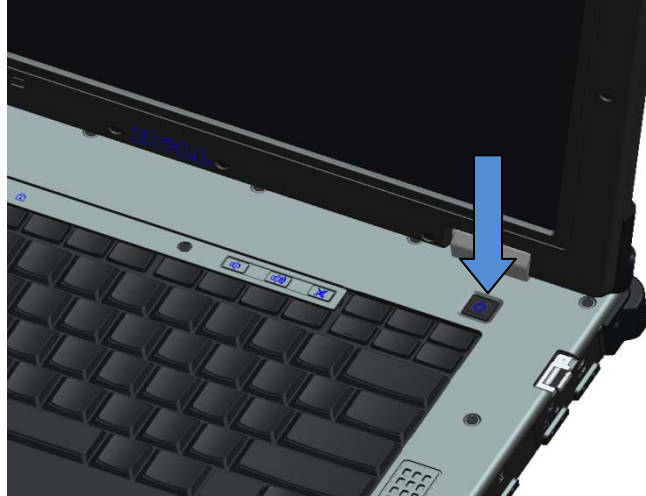

## Smart Cards

Smart (CAC) cards are laptop credit-card shaped devices with internal integrated circuits. Using smart cards can improve system security by combining something a user has (the smart card) with something only the user should know (a PIN) to provide more secure user-authentication than passwords alone.

There are two main types of Smart Cards:

- Contact Smart Cards — These cards have a contact area with many gold plated connection pads. When inserted into a card reader, the information from the chip can be read and written.
- Contactless Smart Cards — These cards do not require any physical contact with the reader. The chip communicates with the card reader through RFID induction technology. These cards require only close proximity to an antenna of a card reader to complete transaction.

## GPS

To be determined...

## RF Pass-Through

In the event the XTG notebook has an integrated WiFi and/or Broadband radio, the RF signals can be passed through a docking station to external TNC antenna connectors (LAN/WAN). This supports the connection and use of external, vehicle-mounted antennas (purchased separately) for improved radio performance.

## DirectVue™ Touch Display Information

If you purchased your E6400 XFR Fully Rugged Notebook with the optional DirectVue Touch Display please review the following user instructions and tips.

The E6400 XFR provides an optional touch screen display for entering and selecting data using an approved pointing device such as your finger, a passive stylus or any non-abrasive smooth blunt object that will not damage the touch display.

- ➡ **NOTICE:** To ensure you properly care for and maintain your touch display, adhere to the care instructions regarding the display.

 **CAUTION:** The optional DirectVue™ Touch Display has been designed to accept finger touch as well as passive stylus input directly onto the screen. With the optional DirectVue™ Touch Display, a stylus is included with the E6400 XFR for use in selecting items on the touch screen. Other pointing devices can be used with the touch screen such as any non-abrasive, smooth or blunt object that will not damage the touch screen display. The touch screen surface can be damaged by ink pens, marker pens or other pointed or abrasive objects. The use of non-approved input devices that cause damage to the digitizer or LCD may not be covered by the limited warranty.

The touch screen is pre-configured and pre-calibrated at the factory, but may require further calibration to improve accuracy for entering or selecting data on the touch display. Please see the [Tools](#) section for information on Calibrating your E6400 XFR Touch Display and using your stylus.

## Accessing Drivers and Documentation

Your E6400 XFR DirectVue Touch Display's drivers, touch-input parameters and documentation have been pre-loaded at the factory. For experienced users or IT administrators - if you need to re-install drivers, set up your E6400 XFR Touch Display or modify parameters please refer to the pre-loaded E6400 XFR *Touchkit* Utility documentation for detailed instructions and refer to the summary provided in [Touchkit Configuration Utility](#).

You can launch the pre-loaded documentation by selecting **Start -> Programs -> Touchkit -> Document**.

## Touchkit Configuration Utility

Your E6400 XFR DirectVue Touch Display system incorporates EETI technology. *Touchkit* is a software utility tool that allows you to configure various touch features. You can launch *Touchkit* by clicking **Start -> Programs -> Touchkit -> Configure Utility**.

 **NOTE:** The touch screen is pre-configured and pre-calibrated at the factory, but may require further calibration to improve accuracy for entering or selecting data on the touch display, or to further configure it to your specific application.

Please refer to the pre-loaded documentation for the *Touchkit* Configuration Utility for a complete description of all its capabilities and functionality.

You can launch the pre-loaded documentation for the *Touchkit* Configuration Utility by selecting **Start -> Programs -> Touchkit -> Document -> User Guide for Windows 2000/XP -> Touchkit Utility**.

The *Touchkit* software utility consists of tabs that allow you to determine the best settings for your touch screen configuration.

- The **General** tab shows all of the touchkit touch screen controllers installed in your system
- The **Tools** tab provides access to calibration and touch position tools.
- The **Setting** tab provides access to the configuration of beeps, clicks and mouse emulation as well as selection of 9 point or 25 point calibration for linearization.
- The **Display** tab provides the tools for mapping the touch screen area to specific areas of the display. The default is full screen.
- The **Edge Parameters** tab provides configuration for selecting items near the edge of the touch screen.
- The **Hardware** tab provides the model and firmware version of the Touchkit touch screen controller.
- The **About** tab provides the version of the Touchkit driver as well as providing a link for downloading the latest driver.

## General

The general property page shows all the *Touchkit* touch screen controllers installed including RS232, USB and PS2 interfaces. The E6400 XFR touch screen controller is a USB device.

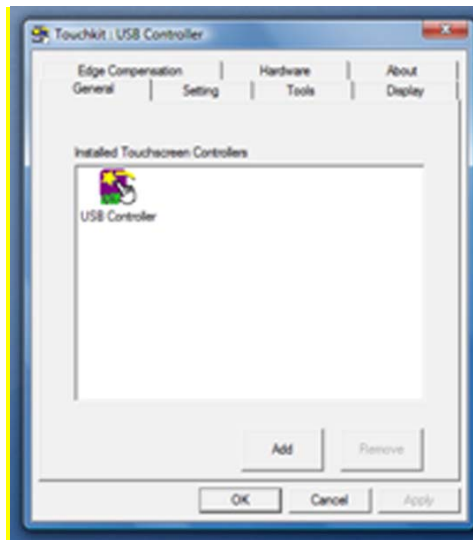

## Tools

The Tools property page provides the following information and functions which are selected by pressing the push buttons.

**NOTE:** Your touch screen is configured and calibrated at the factory. However, if you notice that the calibration is not as precise as you would like, you can use the 4 Points Calibration and/or the Linearization tool to provide a more accurate alignment of the touch screen.

- Graph of the **Linearization Curve** of the touch screen – for reference and troubleshooting purposes. See its usage in the discussion of the Linearization function.
- **4 Points Calibration** – Calibration aligns the touch panel with the video screen. The touch screen must be calibrated to allow for positional accuracy of the stylus or finger touch inputs.
- **Clear and Calibrate** – Clears the calibration/linearization parameters and allows you to perform the 4 points calibration again.
- **Linearization** (9 or 25 points linearization is set within the Setting tab) – the linearization function provides for more precise mapping of the stylus or finger touch inputs. After linearization is completed, the linearity of the touch screen will be shown in the Linearization Curve window.
- **Draw Test** - used for accuracy and performance checking.

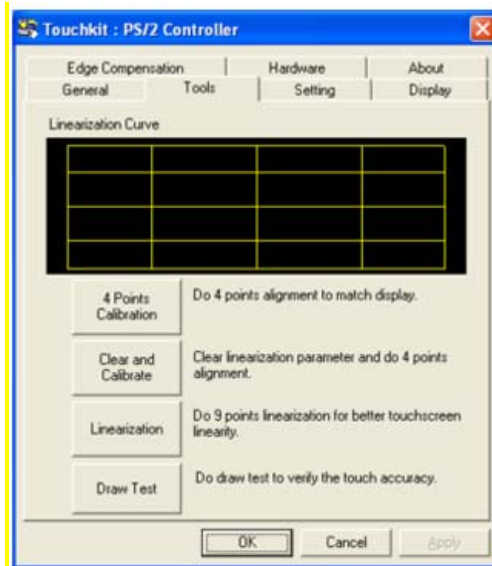

### 1. 4 Points Calibration

The touch screen must be calibrated before it can work accurately. This function pops up a new window to guide you through the 4 points calibration. You should follow the guide to touch and hold the blinking X symbol in the calibration window until it does not blink to make sure that the utility can gather enough data for computation. In addition, a time line bar is shown in the bottom of the window to indicate time elapsed. If the touch screen is not touched before the time line bar reaches the right end, the calibration task will be terminated automatically.



### 2. Linearization

This function provides for more accurate touch screen positional alignment. The linearization function pops up a new window to guide you through the 9 or 25 points calibration. Configuring the function for 9 or 25 points calibration is accessed in the [Setting](#) tab. You should follow the guide to touch and hold the blinking X symbol in the calibration window until it does not blink to make sure that the utility can gather enough data for computation. In addition, a time line bar is shown in the bottom of the window to indicate the time elapsed. If the touch screen is not touched before the time line bar reaches the right end, the calibration task will be terminated automatically.



### 3. Draw Test

This function is used for accuracy and performance checking. You can use the stylus or finger touch to draw or write across the displayed area.

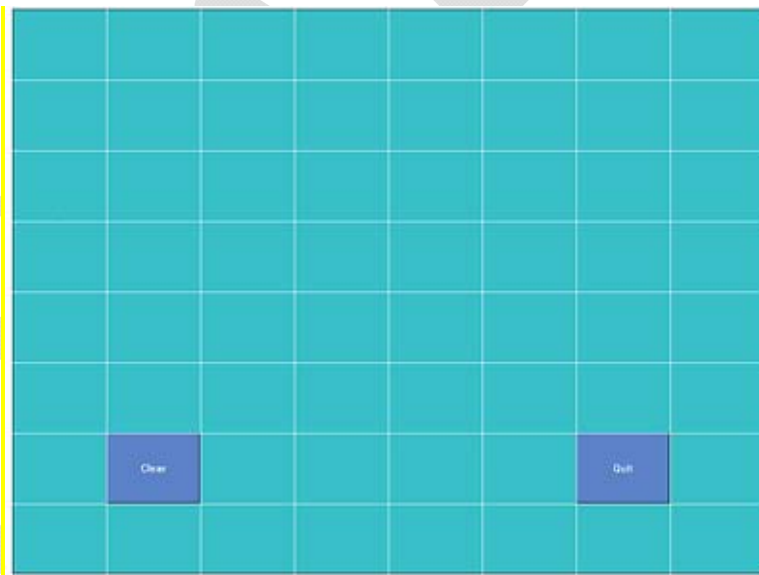

You can press the Clear button to clear the window. Press the Quit button to terminate the draw test.

## Setting

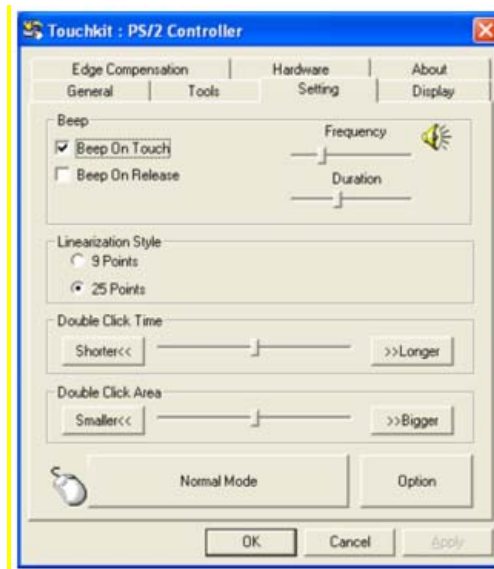

The Setting property page provides the following buttons and check boxes:

### 1. Beep

- **Beep On Touch**

Check this check box to enable driver to generate a beep sound when touch touchscreen state is switched from untouched to touched state.

- **Beep On Release**

Check this check box to enable driver to generate a beep sound when touchscreen state is switched from touched state to untouch state.

- **Frequency**

Adjust this frequency to control the beep sound frequency generated by the driver.

- **Duration**

Adjust this duration to control the beep sound duration.

### 2. Linearization Style

The *Touchkit* utility provides you with both 9 points and 25 points calibration for linearization. You can select the suitable kind of linearization type with this setting. The Linearization function is accessed under the Tools tab.

### 3. Double Click Time

The double Click Time group is used to set system double click time. Changing this value will affect the double click behavior for all of the mice devices in the system. Two continuous clicks at the same area within this specified time period will be recognized as a double click event.

### 4. Double Click Area

The double click area group is used to set the system double click area. Changing this value will affect the double click behavior for all of the mice devices in the system. Two continuous clicks within the specified area in the specified double click time will be recognized as a double click event.

### 5. Mouse Emulation mode

There are 5 mouse emulation modes for the *Touchkit* touch screen controllers. Press on the button to change the emulation mode.

- **Normal Mode**

You can select this mode to select objects, and drag objects.

- **Click On Touch**

With this Click On Touch mode, the driver emulates a mouse click event when the touch

screen state is switched from un-touched state to touched state. Then, the driver always generates a mouse move event and tracks the touch position until the touch screen state switches to the un-touch state.

- **Click On Release**

With this Click On Release mode, the driver emulates a mouse click event when the touch screen state is switched from touched state to un-touched state.

- **Click On Touch without moving cursor**

With this mode, the driver behaves similarly to the Click On Touch mode. The cursor does not move to the touch position except for the first touch point.

- **Click On Release without moving cursor**

With this mode, the driver behaves similarly to the Click On Release mode. The cursor does not move to the touch position except for the lift-off point.

## 6. Option

You can access advanced configuration functions with the Option button. Press the button, and the following window will appear.

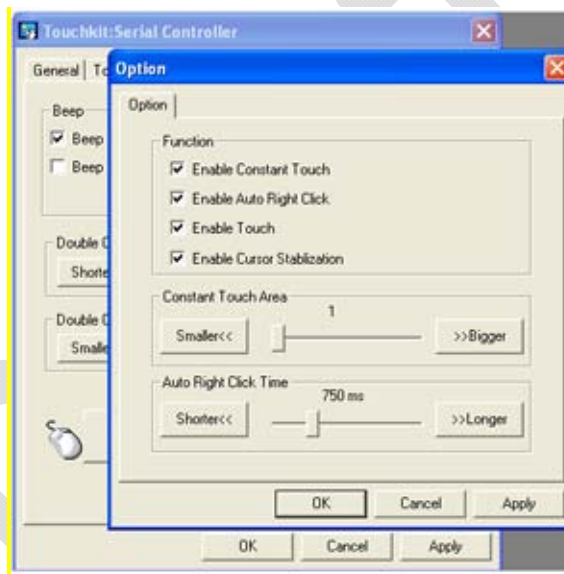

## Display

The *Touchkit* driver supports multiple monitor and display systems. To work with multiple monitor systems, you need to perform the proper configuration to map the touch screen working area to the correct system display area using the Display property page.



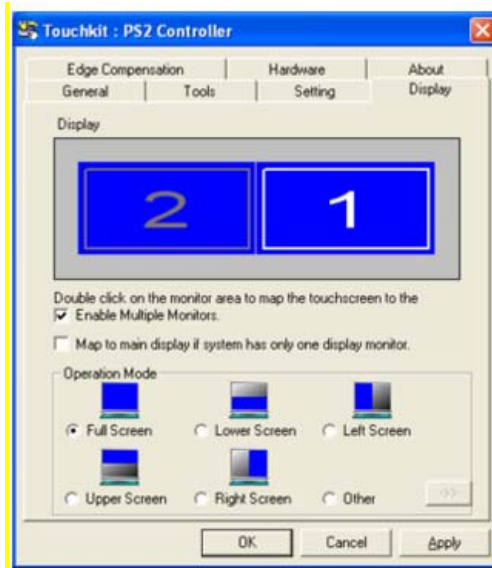

## Edge Parameters

For some special touch screen applications where the edge area of the full screen cannot be reached, *Touchkit* provides you with this edge compensation tool to solve the problem and allow for touching the edge area without accuracy loss.

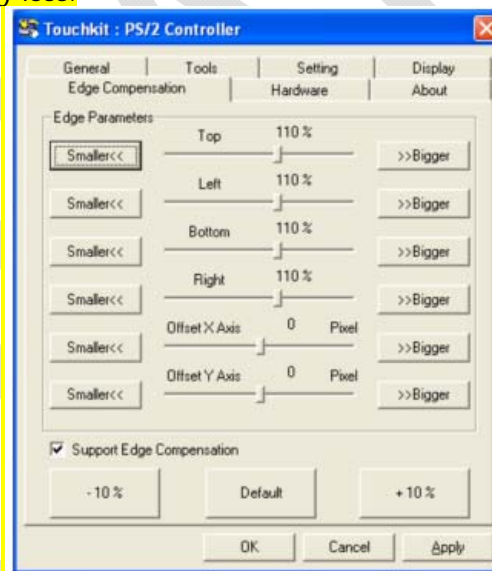

## Hardware

The Hardware property page shows the model and firmware version of the *Touchkit* controller. The software will query the hardware information from the controller and show the information as illustrated here.

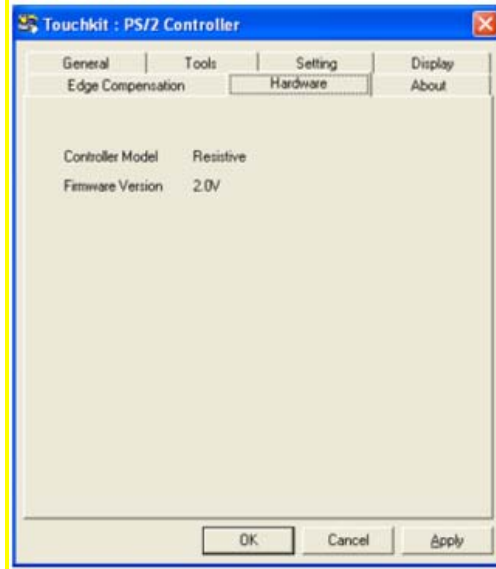

## About

The About property page shows information regarding the *Touchkit* driver, including providing a link to allow you to download the latest driver.

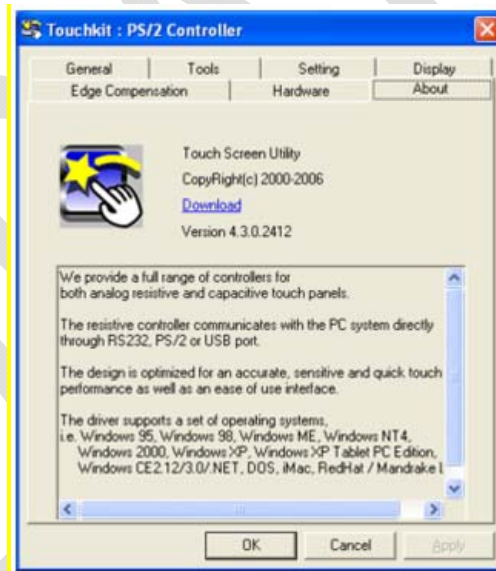

## Specifications

 **NOTE:** Offerings may vary by region. For more information regarding the configuration of your computer, click **Start** -> **Help and Support** and select the option to view information about your computer.

### Video

**NOTE:** Your Dell™ computer has both integrated and discrete video options.

Video type	Integrated and discrete on system board, hardware accelerated
Data bus	Integrated video or PCI-Express video x16
Video controller	Integrated video: Intel® Graphics Media Accelerator 4500 MHD Discrete video: nVIDIA Quadro NVS 160M
Video memory:	<p>Integrated video: Up to 1 GB (with 2 GB or more system memory – Microsoft® Windows® XP) Up to 1.7 GB (with 4GB or more system memory – Windows Vista®)</p> <p>Discrete video: 256 MB dedicated memory</p>

### Battery

Type	12-cell "smart" lithium ion prismatic rugged slice (84 Whr) 6-cell "smart" lithium ion (56 Whr) 4-cell "smart" lithium ion (35 Whr)
------	---

Dimensions:

4-cell and 6-cell lithium-ion batteries:

Depth	206 mm (8.11 inches)
Height	19.8 mm (0.78 inches)

12-cell lithium-ion rugged slice battery:

Depth	14.48 mm (0.57 inches)
Height	217.24 mm (8.55 inches)

Weight:

4-cell primary battery	0.24 kg (0.53 lb)
6-cell primary battery	0.33 kg (0.73 lb)
12-cell slice battery	0.85 kg (1.87 lb)

### Voltage

4-cell battery	14.8 VDC
6-cell battery	11.1 VDC
12-cell rugged slice battery	14.8 VDC

Temperature range:

Operating	-29° to 60°C (-20° to 140°F)
Storage	-51° to 71°C (-60° to 160°F)

Coin-cell battery CR-2032

**AC Adapter**

Input voltage 100-240 VAC

Input current (maximum) 1.5 A

Input frequency 50-60 Hz

Temperature range:

Operating 0° to 35°C (32° to 95°F)

Storage -40° to 65° (-40° to 149°F)

PA-12 65 W Travel AC adapter:

Output voltage 19.5 V DC

Output current 3.34 A

Height 15 mm (0.6 inches)

Width 66 mm (2.6 inches)

Depth 127 mm (5.0 inches)

Weight 0.29 kg (0.64 lb)

PA-10 90 W D-Series AC adapter:

Output voltage 19.5 V DC

Output current 4.62 A

Height 32 mm (1.3 inches)

Width 60 mm (2.4 inches)

Depth 140 mm (5.5 inches)

Weight 0.425 kg (0.9 lb)

PA-3E 90 E-Series AC adapter:

Output voltage 19.5 V DC

Output current 4.62 A

Height 15 mm (0.6 inches)

Width 70 mm (2.8 inches)

Length 147 mm (5.8 inches)

Weight 0.345 kg (0.76 lb)

**Information in this document is subject to change without notice.  
© 2008 Dell Inc. All rights reserved. Printed in the U.S.A.**

Reproduction in any manner whatsoever without the written permission of Dell Inc. is strictly forbidden.

Trademarks used in this text: *Dell*, *Latitude*, *Wi-Fi Catcher*, and the *DELL* logo are trademarks of Dell Inc.; *Augmentix* and *QuadCool* are registered trademarks, and *PR-481*, and *DirectVue* are trademarks of Augmentix Corporation; *Intel* is a registered trademark of Intel Corporation in the U.S. and other countries; *Microsoft*, *Windows*, and *Windows Vista* are either trademarks or registered trademarks of Microsoft Corporation in the United States and/or other countries.

Other trademarks and trade names may be used in this document to refer to either the entities claiming the marks and names or their products. Dell Inc. disclaims any proprietary interest in trademarks and trade names other than its own.

Model P02G

DRAFT