



FCC RADIO TEST REPORT

FCC ID : PKRISGMD2000
Equipment : Wireless Module
Brand Name : Inseego
Model Name : MD2000
Applicant : Inseego Corporation
9710 Scranton Road Suite 200, San Diego, CA 92121
Manufacturer : Inseego Corporation
9710 Scranton Road Suite 200, San Diego, CA 92121
Standard : FCC 47 CFR Part 2, Part 27(D)

The product was received on Sep. 14, 2020 and testing was started from Sep. 23, 2020 and completed on Oct. 01, 2020. We, SPORTON INTERNATIONAL INC. EMC & Wireless Communications Laboratory, would like to declare that the tested sample has been evaluated in accordance with the test procedures given in ANSI / TIA-603-E and has been in compliance with the applicable technical standards.

The test results in this report apply exclusively to the tested model / sample. Without written approval of SPORTON INTERNATIONAL INC. EMC & Wireless Communications Laboratory, the test report shall not be reproduced except in full.

Louis Wu

Approved by: Louis Wu

SPORTON INTERNATIONAL INC. EMC & Wireless Communications Laboratory

No. 52, Huaya 1st Rd., Guishan Dist., Taoyuan City, Taiwan (R.O.C.)



Table of Contents

History of this test report.....	3
Summary of Test Result.....	4
1 General Description	5
1.1 Product Feature of Equipment Under Test.....	5
1.2 Modification of EUT	5
1.3 Testing Site.....	5
1.4 Applied Standards	6
2 Test Configuration of Equipment Under Test	7
2.1 Test Mode.....	7
2.2 Connection Diagram of Test System.....	8
2.3 Support Unit used in test configuration and system	8
2.4 Measurement Results Explanation Example.....	8
2.5 Frequency List of Low/Middle/High Channels	9
3 Conducted Test Items.....	10
3.1 Measuring Instruments	10
3.2 Conducted Output Power Measurement and EIRP Measurement	11
3.3 Peak-to-Average Ratio	12
3.4 EIRP Power Density	13
3.5 Occupied Bandwidth.....	14
3.6 Conducted Band Edge	15
3.7 Conducted Spurious Emission	16
3.8 Frequency Stability	17
4 Radiated Test Items	18
4.1 Measuring Instruments	18
4.2 Radiated Spurious Emission Measurement	20
5 List of Measuring Equipment.....	21
6 Uncertainty of Evaluation.....	23
Appendix A. Test Results of Conducted Test	
Appendix B. Test Results of Radiated Test	
Appendix C. Test Setup Photographs	

**Summary of Test Result**

Report Clause	Ref Std. Clause	Test Items	Result (PASS/FAIL)	Remark
3.2	§2.1046	Conducted Output Power and Effective Isotropic Radiated Power	Reporting only	-
3.3	-	Peak-to-Average Ratio	Reporting only	-
3.4	§27.50 (a)(3)	EIRP Power Density	Pass	-
3.5	§2.1049	Occupied Bandwidth	Reporting only	-
3.6	§2.1051 §27.53 (a)(4)	Conducted Band Edge Measurement	Pass	-
3.7	§2.1051 §27.53 (a)(4)	Conducted Spurious Emission	Pass	-
3.8	§2.1055 §27.54	Frequency Stability Temperature & Voltage	Pass	-
4.2	§2.1053 §27.53 (a)(4)	Radiated Spurious Emission	Pass	Under limit 17.05 dB at 4614.000 MHz

Declaration of Conformity:

The test results with all measurement uncertainty excluded are presented in accordance with the regulation limits or requirements declared by manufacturers.

Comments and Explanations:

The declared of product specification for EUT presented in the report are provided by the manufacturer, and the manufacturer takes all the responsibilities for the accuracy of product specification.

Reviewed by: Wii Chang**Report Producer: Amy Chen**



1 General Description

1.1 Product Feature of Equipment Under Test

WCDMA/LTE/5G NR, Wi-Fi 2.4GHz 802.11b/g/n/ac/ax, Wi-Fi 5GHz 802.11a/n/ac/ax, and GNSS.

Product Specification subjective to this standard	
Antenna Type	WWAN: Monopole Antenna WLAN: <Ant. 0> Monopole Antenna <Ant. 1> Monopole Antenna GPS/Glonass/BDS/Galileo: Monopole Antenna

1.2 Modification of EUT

No modifications are made to the EUT during all test items.

1.3 Testing Site

Test Site	SPORTON INTERNATIONAL INC. EMC & Wireless Communications Laboratory
Test Site Location	No.52, Huaya 1st Rd., Guishan Dist., Taoyuan City, Taiwan (R.O.C.) TEL: +886-3-327-3456 FAX: +886-3-328-4978
Test Site No.	Sporton Site No.
	TH05-HY
Test Engineer	Benjamin Lin
Temperature	22.3 ~ 24.5 °C
Relative Humidity	48.9 ~ 50.2 %

Test Site	SPORTON INTERNATIONAL INC. EMC & Wireless Communications Laboratory
Test Site Location	No.58, Aly. 75, Ln. 564, Wenhua 3rd, Rd., Guishan Dist., Taoyuan City, Taiwan (R.O.C.) TEL: +886-3-327-0868 FAX: +886-3-327-0855
Test Site No.	Sporton Site No.
	03CH12-HY
Test Engineer	Jack Cheng, Lance Chiang and Chuan Chu
Temperature	24.3 ~ 26.4 °C
Relative Humidity	58 ~ 66 %

Note: The test site complies with ANSI C63.4 2014 requirement.

FCC Designation No.: TW1190 and TW0007



1.4 Applied Standards

According to the specifications of the manufacturer, the EUT must comply with the requirements of the following standards:

- ♦ ANSI C63.26-2015
- ♦ FCC 47 CFR Part 2, Part 27(D)
- ♦ ANSI / TIA-603-E
- ♦ FCC KDB 971168 Power Meas License Digital Systems D01 v03r01
- ♦ FCC KDB 412172 D01 Determining ERP and EIRP v01r01
- ♦ FCC KDB 414788 D01 Radiated Test Site v01r01

Remark:

1. All test items were verified and recorded according to the standards and without any deviation during the test.
2. This EUT has also been tested and complied with the requirements of FCC Part 15, Subpart B, recorded in a separate test report.
3. The TAF code is not including all the FCC KDB listed without accreditation.



2 Test Configuration of Equipment Under Test

2.1 Test Mode

Antenna port conducted and radiated test items listed below are performed according to KDB 971168 D01 Power Meas. License Digital Systems v03r01 with maximum output power.

For radiated measurement, pre-scanned in two config (Ant. Horizontal and Ant. Vertical). The worst cases (Ant. Horizontal) were recorded in this report.

Test Items	Band	Bandwidth (MHz)						Modulation			RB #			Test Channel				
		1.4	3	5	10	15	20	QPSK	16QAM	64QAM	256QAM	1	Half	Full	L	M	H	
Max. Output Power	30	-	-	v	v	-	-	v	v	v	v	v	v	v	v	v	v	v
Peak-to-Average Ratio	30	-	-		v	-	-	v	v	v	v	v		v			v	
E.I.R.P PSD	30	-	-	v	v	-	-	v	v	v	v	v	v	v	v	v	v	v
26dB and 99% Bandwidth	30	-	-	v	v	-	-	v	v	v	v			v	v	v	v	v
Conducted Band Edge	30	-	-	v	v	-	-	v	v	v	v	v		v			v	
Conducted Spurious Emission	30	-	-	v	v	-	-	v	v	v	v	v					v	v
Frequency Stability	30	-	-		v	-	-	v							v			v
Radiated Spurious Emission	30	Worst Case													v	v	v	
Remark	<ol style="list-style-type: none"> The mark "v" means that this configuration is chosen for testing The mark "-" means that this bandwidth is not supported. The device is investigated from 30MHz to 10 times of fundamental signal for radiated spurious emission test under different RB size/offset and modulations in exploratory test. Subsequently, only the worst case emissions are reported. 																	

2.2 Connection Diagram of Test System

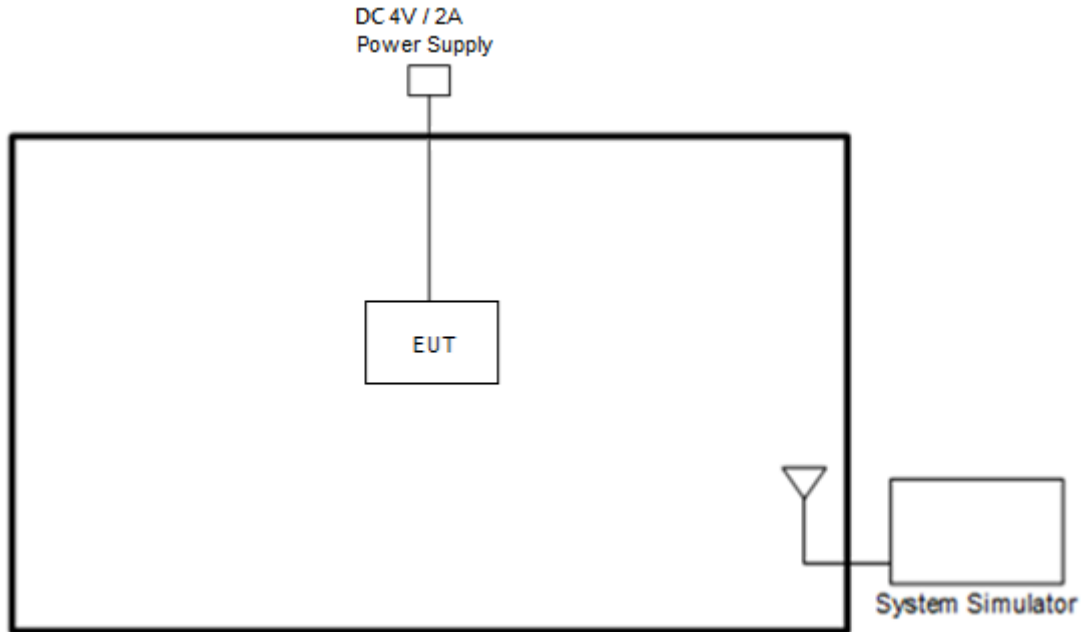

2.3 Support Unit used in test configuration and system

Item	Equipment	Brand Name	Model No.	FCC ID	Data Cable	Power Cord
1.	System Simulator	Anritsu	MT8821C	N/A	N/A	Unshielded, 1.8 m

2.4 Measurement Results Explanation Example

For all conducted test items:

The offset level is set in the spectrum analyzer to compensate the RF cable loss and attenuator factor between EUT conducted output port and spectrum analyzer. With the offset compensation, the spectrum analyzer reading level is exactly the EUT RF output level.

The spectrum analyzer offset is derived from RF cable loss and attenuator factor.

Offset = RF cable loss + attenuator factor.

Following shows an offset computation example with cable loss 4.2 dB and 10dB attenuator.

Example :

$$\begin{aligned} \text{Offset(dB)} &= \text{RF cable loss(dB)} + \text{attenuator factor(dB)}. \\ &= 4.2 + 10 = 14.2 \text{ (dB)} \end{aligned}$$



2.5 Frequency List of Low/Middle/High Channels

LTE Band 30 Channel and Frequency List				
BW [MHz]	Channel/Frequency(MHz)	Lowest	Middle	Highest
10	Channel	-	27710	-
	Frequency	-	2310	-
5	Channel	27685	27710	27735
	Frequency	2307.5	2310	2312.5

3 Conducted Test Items

3.1 Measuring Instruments

See list of measuring instruments of this test report.

3.1.1 Test Setup

3.1.2 Conducted Output Power

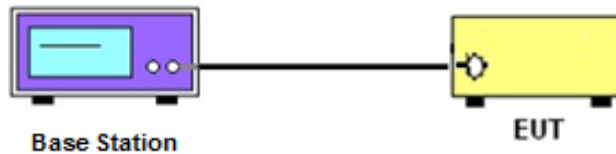

3.1.3 Peak-to-Average Ratio, Occupied Bandwidth, 26dB Bandwidth ,Band-Edge and Conducted Spurious Emission

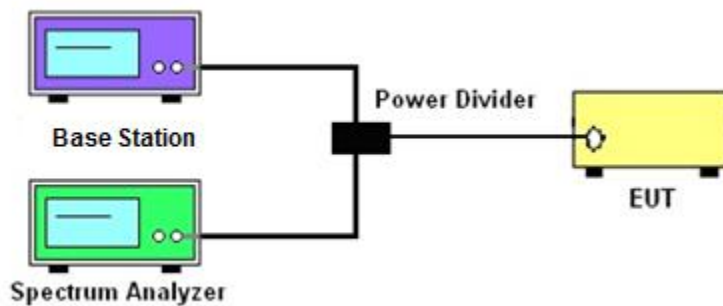

3.1.4 Frequency Stability

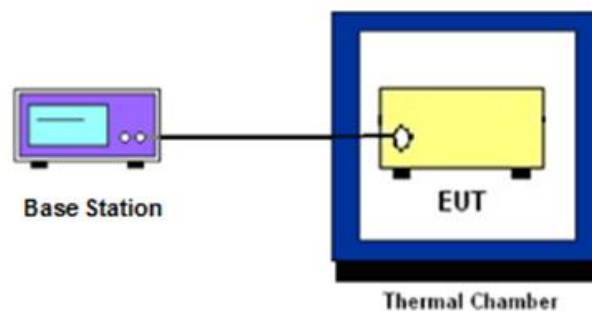

3.1.5 Test Result of Conducted Test

Please refer to Appendix A.



3.2 Conducted Output Power Measurement and EIRP Measurement

3.2.1 Description of the Conducted Output Power Measurement and EIRP Measurement

A base station simulator was used to establish communication with the EUT. Its parameters were set to transmit the maximum power on the EUT. The measured power in the radio frequency on the transmitter output terminals shall be reported.

According to KDB 412172 D01 Power Approach,

$EIRP = P_T + G_T - L_C$, where

P_T = transmitter output power in dBm

G_T = gain of the transmitting antenna in dBi

L_C = signal attenuation in the connecting cable between the transmitter and antenna in dB

3.2.2 Test Procedures

1. The transmitter output port was connected to the system simulator.
2. Set EUT at maximum power through the system simulator.
3. Select lowest, middle, and highest channels for each band and different modulation.
4. Measure and record the power level from the system simulator.



3.3 Peak-to-Average Ratio

3.3.1 Description of the PAR Measurement

Power Complementary Cumulative Distribution Function (CCDF) curves provide a means for characterizing the power peaks of a digitally modulated signal on a statistical basis. A CCDF curve depicts the probability of the peak signal amplitude exceeding the average power level. Most contemporary measurement instrumentation include the capability to produce CCDF curves for an input signal provided that the instrument's resolution bandwidth can be set wide enough to accommodate the entire input signal bandwidth. In measuring transmissions in this band using an average power technique, the peak-to-average ratio (PAR) of the transmission may not exceed 13 dB.

3.3.2 Test Procedures

The testing follows ANSI C63.26-2015 Section 5.2.6

1. The EUT was connected to spectrum and system simulator via a power divider.
2. Set the CCDF (Complementary Cumulative Distribution Function) option in spectrum analyzer.
3. The highest RF powers were measured and recorded the maximum PAPR level associated with a probability of 0.1 %.
4. Record the deviation as Peak to Average Ratio.



3.4 EIRP Power Density

3.4.1 Description of EIRP Power Density

For mobile and portable stations transmitting in the 2305-2315 MHz band or the 2350-2360 MHz band, the average EIRP must not exceed 50 milliwatts within any 1 megahertz of authorized bandwidth, *except that* for mobile and portable stations compliant with 3GPP LTE standards or another advanced mobile broadband protocol that avoids concentrating energy at the edge of the operating band the average EIRP must not exceed 250 milliwatts within any 5 megahertz of authorized bandwidth but may exceed 50 milliwatts within any 1 megahertz of authorized bandwidth. For mobile and portable stations using time division duplexing (TDD) technology, the duty cycle must not exceed 38 percent in the 2305-2315 MHz and 2350-2360 MHz bands. Mobile and portable stations using FDD technology are restricted to transmitting in the 2305-2315 MHz band. Power averaging shall not include intervals in which the transmitter is off.

3.4.2 Test Procedures

The testing follows ANSI C63.26-2015 Section 5.2.4.5

1. Set instrument center frequency to OBW center frequency.
2. Set span to at least 1.5 times the OBW.
3. Set the RBW to the specified reference bandwidth (5MHz).
4. Set VBW $\geq 3 \times$ RBW.
5. Detector = RMS (power averaging).
6. Ensure that the number of measurement points in the sweep $\geq 2 \times$ span/RBW.
7. Sweep time = auto couple.
8. Employ trace averaging (RMS) mode over a minimum of 100 traces.
9. Use the peak marker function to determine the maximum amplitude level within the reference bandwidth (PSD).
10. Determine the EIRP by adding the effective antenna gain to the adjusted power level.



3.5 Occupied Bandwidth

3.5.1 Description of Occupied Bandwidth Measurement

The occupied bandwidth is the width of a frequency band such that, below the lower and above the upper frequency limits, the mean powers emitted are each equal to a specified percentage 0.5% of the total mean transmitted power.

The 26 dB emission bandwidth is defined as the frequency range between two points, one above and one below the carrier frequency, at which the spectral density of the emission is attenuated 26 dB below the maximum in-band spectral density of the modulated signal. Spectral density (power per unit bandwidth) is to be measured with a detector of resolution bandwidth equal to approximately 1.0% of the emission bandwidth.

3.5.2 Test Procedures

The testing follows ANSI C63.26-2015 Section 5.4.3 (26dB) and Section 5.4.4 (99OB)

1. The EUT was connected to spectrum analyzer and system simulator via a power divider.
2. The spectrum analyzer center frequency is set to the nominal EUT channel center frequency. The span range for the spectrum analyzer shall be between two and five times the anticipated OBW.
3. The nominal resolution bandwidth (RBW) shall be in the range of 1 to 5 % of the anticipated OBW, and the VBW shall be at least 3 times the RBW.
4. Set the detection mode to peak, and the trace mode to max hold.
5. Determine the reference value: Set the EUT to transmit a modulated signal. Allow the trace to stabilize. Set the spectrum analyzer marker to the highest level of the displayed trace.
(this is the reference value)
6. Determine the “-26 dB down amplitude” as equal to (Reference Value – X).
7. Place two markers, one at the lowest and the other at the highest frequency of the envelope of the spectral display such that each marker is at or slightly below the “-X dB down amplitude” determined in step 6. If a marker is below this “-X dB down amplitude” value it shall be placed as close as possible to this value. The OBW is the positive frequency difference between the two markers.
8. Use the 99 % power bandwidth function of the spectrum analyzer and report the measured bandwidth.



3.6 Conducted Band Edge

3.6.1 Description of Conducted Band Edge Measurement

27.53 (a)(4)

For mobile and portable stations operating in the 2305-2315 MHz and 2350-2360 MHz bands:

- (i) By a factor of not less than: $43 + 10 \log (P)$ dB on all frequencies between 2305 and 2320 MHz and on all frequencies between 2345 and 2360 MHz that are outside the licensed band(s) of operation, not less than $55 + 10 \log (P)$ dB on all frequencies between 2320 and 2324 MHz and on all frequencies between 2341 and 2345 MHz, not less than $61 + 10 \log (P)$ dB on all frequencies between 2324 and 2328 MHz and on all frequencies between 2337 and 2341 MHz, and not less than $67 + 10 \log (P)$ dB on all frequencies between 2328 and 2337 MHz.
- (ii) By a factor of not less than $43 + 10 \log (P)$ dB on all frequencies between 2300 and 2305 MHz, $55 + 10 \log (P)$ dB on all frequencies between 2296 and 2300 MHz, $61 + 10 \log (P)$ dB on all frequencies between 2292 and 2296 MHz, $67 + 10 \log (P)$ dB on all frequencies between 2288 and 2292 MHz, and $70 + 10 \log (P)$ dB below 2288 MHz.
- (iii) By a factor of not less than $43 + 10 \log (P)$ dB on all frequencies between 2360 and 2365 MHz, and not less than $70 + 10 \log (P)$ dB above 2365 MHz.

3.6.2 Test Procedures

The testing follows FCC KDB 971168 D01 v03r01 Section 6.1.

1. The EUT was connected to spectrum analyzer and system simulator via a power divider.
2. The band edges of low and high channels for the highest RF powers were measured.
3. Set RBW \geq 1% EBW in the 1MHz band immediately outside and adjacent to the band edge.
4. Beyond the 1 MHz band from the band edge, RBW=1MHz was used.
5. Set spectrum analyzer with RMS detector.
6. The RF fundamental frequency should be excluded against the limit line in the operating frequency band.
7. Checked that all the results comply with the emission limit line.

The limit line is derived from $43 + 10\log(P)$ dB below the transmitter power P(Watts)



3.7 Conducted Spurious Emission

3.7.1 Description of Conducted Spurious Emission Measurement

The power of any emission outside of the authorized operating frequency ranges must be lower than the transmitter power (P) by a factor of at least $70 + 10 \log (P)$ dB.

It is measured by means of a calibrated spectrum analyzer and scanned from 9 kHz up to a frequency including its 10th harmonic.

3.7.2 Test Procedures

The testing follows FCC KDB 971168 D01 v03r01 Section 6.1.

1. The EUT was connected to spectrum analyzer and system simulator via a power divider.
2. The RF output of EUT was connected to the spectrum analyzer by RF cable and attenuator. The path loss was compensated to the results for each measurement.
3. The middle channel for the highest RF power within the transmitting frequency was measured.
4. The conducted spurious emission for the whole frequency range was taken.
5. Make the measurement with the spectrum analyzer's RBW = 1MHz, VBW = 3MHz.
6. Set spectrum analyzer with RMS detector.
7. Taking the record of maximum spurious emission.
8. The RF fundamental frequency should be excluded against the limit line in the operating frequency band.
9. The limit line is derived from $70 + 10\log(P)$ dB below the transmitter power P(Watts)



3.8 Frequency Stability

3.8.1 Description of Frequency Stability Measurement

The frequency stability shall be sufficient to ensure that the fundamental emission stays within the authorized frequency block.

3.8.2 Test Procedures for Temperature Variation

The testing follows FCC KDB 971168 D01 v03r01 Section 9.0.

1. The EUT was set up in the thermal chamber and connected with the system simulator.
2. With power OFF, the temperature was decreased to -30°C and the EUT was stabilized before testing. Power was applied and the maximum change in frequency was recorded within one minute.
3. With power OFF, the temperature was raised in 10°C step up to 50°C. The EUT was stabilized at each step for at least half an hour. Power was applied and the maximum frequency change was recorded within one minute.

3.8.3 Test Procedures for Voltage Variation

The testing follows FCC KDB 971168 D01 v03r01 Section 9.0.

1. The EUT was placed in a temperature chamber at 20±5° C and connected with the system simulator.
2. The power supply voltage to the EUT was varied from 85% to 115% of the nominal value measured at the input to the EUT.
3. The variation in frequency was measured for the worst case.

4 Radiated Test Items

4.1 Measuring Instruments

See list of measuring instruments of this test report.

4.1.1 Test Setup

For radiated test below 30MHz

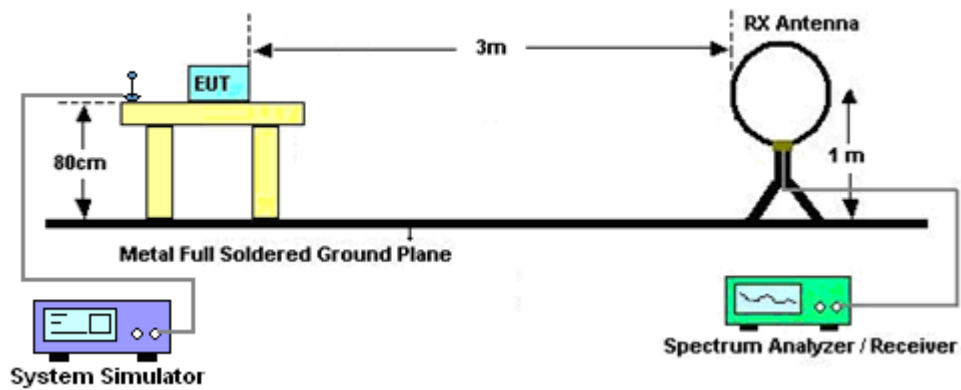

For radiated test from 30MHz to 1GHz

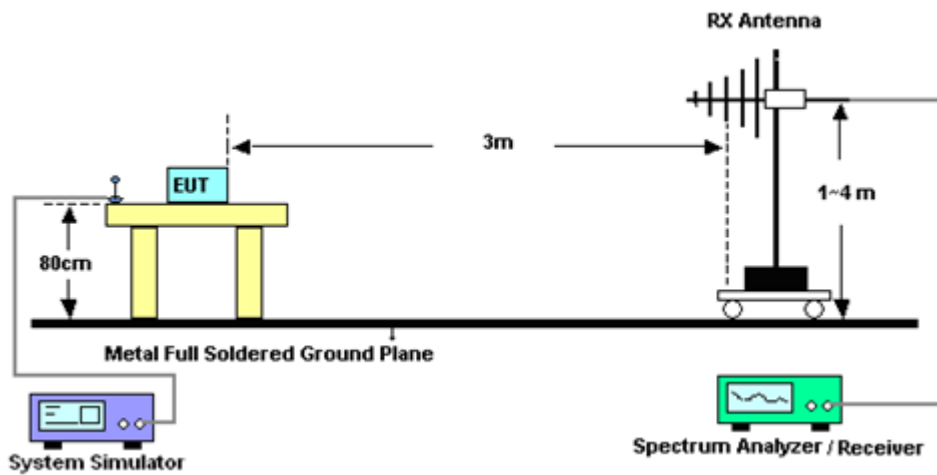

For radiated test from 1GHz to 18GHz

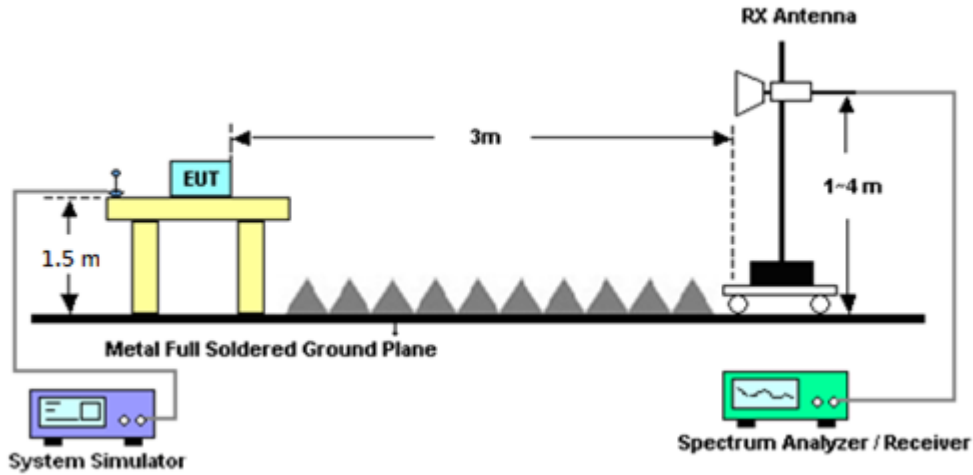

For radiated test above 18GHz

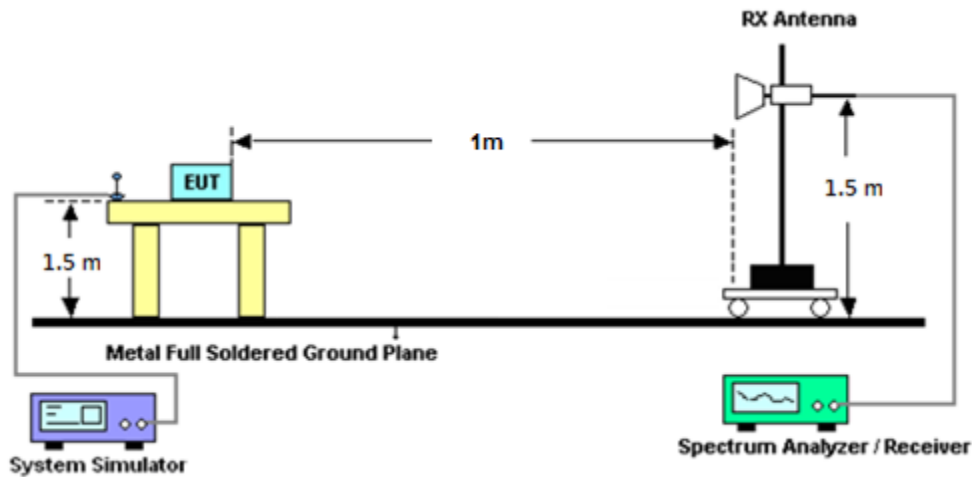

4.1.2 Test Result of Radiated Test

Please refer to Appendix B.

Note:

The low frequency, which started from 9 kHz to 30MHz, was pre-scanned and the result which was 20dB lower than the limit line was not reported.

There is a comparison data of both open-field test site and alternative test site - semi-Anechoic chamber according to 414788 D01 Radiated Test Site v01r01, and the result came out very similar.



4.2 Radiated Spurious Emission Measurement

4.2.1 Description of Radiated Spurious Emission Measurement

The radiated spurious emission was measured by substitution method according to ANSI / TIA-603-E
The power of any emission outside of the authorized operating frequency ranges must be attenuated below the transmitter power (P) by a factor of at least $70 + 10 \log (P)$ dB.
The spectrum is scanned from 30 MHz up to a frequency including its 10th harmonic.

4.2.2 Test Procedures

The testing follows FCC KDB 971168 D01 v03r01 Section 7 and ANSI / TIA-603-E Section 2.2.12.

1. The EUT was placed on a turntable with 0.8 meter height for frequency below 1GHz and 1.5 meter height for frequency above 1GHz respectively above ground.
2. The EUT was set 3 meters from the receiving antenna mounted on the antenna tower.
3. The table was rotated 360 degrees to determine the position of the highest spurious emission.
4. The height of the receiving antenna is varied between 1m to 4m to search the maximum spurious emission for both horizontal and vertical polarizations.
5. During the measurement, the system simulator parameters were set to force the EUT transmitting at maximum output power.
6. Make the measurement with the spectrum analyzer's RBW = 1MHz, VBW = 3MHz, taking the record of maximum spurious emission.
7. A horn antenna was substituted in place of the EUT and was driven by a signal generator.
8. Tune the output power of signal generator to the same emission level with EUT maximum spurious emission.

$$\text{EIRP (dBm)} = \text{S.G. Power} - \text{Tx Cable Loss} + \text{Tx Antenna Gain}$$

$$\text{ERP (dBm)} = \text{EIRP} - 2.15$$

4. The RF fundamental frequency should be excluded against the limit line in the operating frequency band.

The limit line is derived from $70 + 10\log(P)$ dB below the transmitter power P(Watts)

$$= P(W) - [70 + 10\log(P)] \text{ (dB)}$$

$$= [30 + 10\log(P)] \text{ (dBm)} - [70 + 10\log(P)] \text{ (dB)}$$

$$= -40\text{dBm.}$$



5 List of Measuring Equipment

Instrument	Brand Name	Model No.	Serial No.	Characteristics	Calibration Date	Test Date	Due Date	Remark
Loop Antenna	Rohde & Schwarz	HFH2-Z2	100315	9 kHz~30 MHz	Dec. 26, 2019	Sep. 24, 2020~ Oct. 01, 2020	Dec. 25, 2020	Radiation (03CH12-HY)
Bilog Antenna	TESEQ	CBL 6111D & 00800N1D0 1N-06	37059 & 01	30MHz~1GHz	Oct. 12, 2019	Sep. 24, 2020~ Oct. 01, 2020	Oct. 11, 2020	Radiation (03CH12-HY)
Horn Antenna	SCHWARZBE CK	BBHA 9120 D	9120D-1328	1GHz~18GHz	Nov. 14, 2019	Sep. 24, 2020~ Oct. 01, 2020	Nov. 13, 2020	Radiation (03CH12-HY)
Horn Antenna	SCHWARZBE CK	BBHA 9120D	9120D-1326	1GHz ~ 18GHz	Nov. 04, 2019	Sep. 24, 2020~ Oct. 01, 2020	Nov. 03, 2020	Radiation (03CH12-HY)
SHF-EHF Horn Antenna	SCHWARZBE CK	BBHA 9170	BBHA917058 4	18GHz~40GHz	Dec. 10, 2019	Sep. 24, 2020~ Oct. 01, 2020	Dec. 09, 2020	Radiation (03CH12-HY)
SHF-EHF Horn Antenna	SCHWARZBE CK	BBHA 9170	BBHA917098 0	18GHz ~ 40GHz	Jan. 10, 2019	Sep. 24, 2020~ Oct. 01, 2020	Jan. 09, 2021	Radiation (03CH12-HY)
Preamplifier	COM-POWE R	PA-103	161075	10MHz~1GHz	Mar. 25, 2020	Sep. 24, 2020~ Oct. 01, 2020	Mar. 24, 2021	Radiation (03CH12-HY)
Preamplifier	Keysight	83017A	MY57280120	1GHz~26.5GHz	Jul. 20, 2020	Sep. 24, 2020~ Oct. 01, 2020	Jul. 19, 2021	Radiation (03CH12-HY)
Preamplifier	Jet-Power	JPA0118-55- 303K	1710001800 054002	1GHz~18GHz	Feb. 07, 2020	Sep. 24, 2020~ Oct. 01, 2020	Feb. 06, 2021	Radiation (03CH12-HY)
Preamplifier	EMEC	EM18G40G	060715	18GHz~40GHz	Dec. 13, 2019	Sep. 24, 2020~ Oct. 01, 2020	Dec. 12, 2020	Radiation (03CH12-HY)
Spectrum Analyzer	Agilent	N9010A	MY54200485	10Hz~44GHz	Feb. 10, 2020	Sep. 24, 2020~ Oct. 01, 2020	Feb. 09, 2021	Radiation (03CH12-HY)
Signal Generator	Anritsu	MG3694C	163401	0.1Hz~40GHz	Feb. 15, 2020	Sep. 24, 2020~ Oct. 01, 2020	Feb. 14, 2021	Radiation (03CH12-HY)
RF Cable	HUBER + SUHNER	SUCOFLEX 104	MY9837/4PE	9kHz~30MHz	Mar. 12, 2020	Sep. 24, 2020~ Oct. 01, 2020	Mar. 11, 2021	Radiation (03CH12-HY)
RF Cable	HUBER + SUHNER	SUCOFLEX 126E	0058/126E	30MHz~18GHz	Dec. 12, 2019	Sep. 24, 2020~ Oct. 01, 2020	Dec. 11, 2020	Radiation (03CH12-HY)
RF Cable	HUBER + SUHNER	SUCOFLEX 102	505134/2	30MHz~40GHz	Feb. 25, 2020	Sep. 24, 2020~ Oct. 01, 2020	Feb. 24, 2021	Radiation (03CH12-HY)
RF Cable	HUBER + SUHNER	SUCOFLEX 102	800740/2	30MHz~40GHz	Feb. 25, 2020	Sep. 24, 2020~ Oct. 01, 2020	Feb. 24, 2021	Radiation (03CH12-HY)
Hygrometer	TECPEL	DTM-303B	TP140349	N/A	Oct. 25, 2019	Sep. 24, 2020~ Oct. 01, 2020	Oct. 24, 2020	Radiation (03CH12-HY)
Controller	EMEC	EM1000	N/A	Control Turn table & Ant Mast	N/A	Sep. 24, 2020~ Oct. 01, 2020	N/A	Radiation (03CH12-HY)
Antenna Mast	EMEC	AM-BS-4500 -B	N/A	1m~4m	N/A	Sep. 24, 2020~ Oct. 01, 2020	N/A	Radiation (03CH12-HY)
Turn Table	EMEC	TT2000	N/A	0~360 Degree	N/A	Sep. 24, 2020~ Oct. 01, 2020	N/A	Radiation (03CH12-HY)
Software	Audix	E3 6.2009-8-24	RK-000989	N/A	N/A	Sep. 24, 2020~ Oct. 01, 2020	N/A	Radiation (03CH12-HY)



Instrument	Brand Name	Model No.	Serial No.	Characteristics	Calibration Date	Test Date	Due Date	Remark
Base Station(Measure)	Anritsu	MT8821C	6262025280	GSM / GPRS /WCDMA / LTE FDD/TDD with 44) /LTE-3CC DLCA,2CC ULCA	Oct. 25, 2019	Sep. 23, 2020~ Sep. 30, 2020	Oct. 24, 2020	Conducted (TH05-HY)
Spectrum Analyzer	Rohde & Schwarz	FSV40	101908	10Hz~40GHz	May 13, 2020	Sep. 23, 2020~ Sep. 30, 2020	May 12, 2021	Conducted (TH05-HY)
Thermal Chamber	ESPEC	SU-241	92003713	-40℃~90℃	May 15, 2020	Sep. 23, 2020~ Sep. 30, 2020	May 14, 2021	Conducted (TH05-HY)
Programmable Power Supply	GW Instek	PSS-2005	EL890094	1V~20V 0.5A~5A	Oct. 09, 2019	Sep. 23, 2020~ Sep. 30, 2020	Oct. 08, 2020	Conducted (TH05-HY)
Coupler	Warison	20dB 25W SMA Directional Coupler	#A	1-18GHz	Jan. 13, 2020	Sep. 23, 2020~ Sep. 30, 2020	Jan. 12, 2021	Conducted (TH05-HY)



6 Uncertainty of Evaluation

Uncertainty of Radiated Emission Measurement (30 MHz ~ 1000 MHz)

Measuring Uncertainty for a Level of Confidence of 95% ($U = 2Uc(y)$)	3.07
---	------

Uncertainty of Radiated Emission Measurement (1 GHz ~ 18 GHz)

Measuring Uncertainty for a Level of Confidence of 95% ($U = 2Uc(y)$)	3.21
---	------

Uncertainty of Radiated Emission Measurement (18 GHz ~ 40 GHz)

Measuring Uncertainty for a Level of Confidence of 95% ($U = 2Uc(y)$)	3.80
---	------



Appendix A. Test Results of Conducted Test

Conducted Output Power(Average power)

LTE Band 30 Maximum Average Power [dBm]						
BW [MHz]	RB Size	RB Offset	Mod	Lowest	Middle	Highest
10	1	0	QPSK		23.93	
10	1	25			23.84	
10	1	49			23.88	
10	25	0			23.03	
10	25	12			22.96	
10	25	25			22.99	
10	50	0			22.90	
10	1	0	16-QAM	-	23.23	
10	1	25			23.25	
10	1	49			23.30	
10	25	0			22.11	
10	25	12			21.91	
10	25	25			21.99	
10	50	0			21.91	
10	1	0	64-QAM		21.63	
10	1	25			21.62	
10	1	49			22.05	
10	25	0			20.88	
10	25	12			20.78	
10	25	25			21.10	
10	50	0			20.96	
10	1	0	256-QAM		18.36	
10	1	25			19.03	
10	1	49			18.96	
10	25	0			18.40	
10	25	12			18.94	
10	25	25			18.60	
10	50	0			18.35	



LTE Band 30 Maximum Average Power [dBm]						
BW [MHz]	RB Size	RB Offset	Mod	Lowest	Middle	Highest
5	1	0	QPSK	23.79	23.84	23.85
5	1	12		23.84	23.93	23.87
5	1	24		23.90	23.82	23.75
5	12	0		22.95	22.98	22.88
5	12	7		22.96	22.87	22.93
5	12	13		22.89	22.87	22.86
5	25	0		23.00	22.96	22.88
5	1	0	16-QAM	23.22	23.28	23.18
5	1	12		23.17	23.16	23.22
5	1	24		23.26	23.07	23.15
5	12	0		21.96	21.97	21.95
5	12	7		21.97	21.96	22.00
5	12	13		21.95	21.95	21.86
5	25	0		21.98	21.89	21.90
5	1	0	64-QAM	21.68	21.80	22.21
5	1	12		21.73	21.68	22.16
5	1	24		21.68	21.83	21.85
5	12	0		20.35	20.94	20.67
5	12	7		20.55	20.79	20.61
5	12	13		20.43	20.68	20.90
5	25	0		20.29	20.64	20.95
5	1	0	256-QAM	18.38	18.69	18.52
5	1	12		18.61	18.64	19.05
5	1	24		18.75	18.75	18.63
5	12	0		18.70	18.73	18.29
5	12	7		18.52	18.47	18.45
5	12	13		18.81	18.97	18.58
5	25	0		18.69	18.65	18.80



LTE Band 30

Peak-to-Average Ratio

Mode	LTE Band 30 / 10MHz				
Mod.	QPSK		16QAM		Limit: 13dB
RB Size	1RB	Full RB	1RB	Full RB	Result
Lowest CH	-	-	-	-	PASS
Middle CH	3.65	5.01	5.57	5.88	
Highest CH	-	-	-	-	
Mode	LTE Band 30 / 10MHz				
Mod.	64QAM		256QAM		Limit: 13dB
RB Size	1RB	Full RB	1RB	Full RB	Result
Lowest CH	-	-	-	-	PASS
Middle CH	7.36	6.43	7.45	6.49	
Highest CH	-	-	-	-	



LTE Band 30 / 10MHz / QPSK

Middle Channel / 1RB

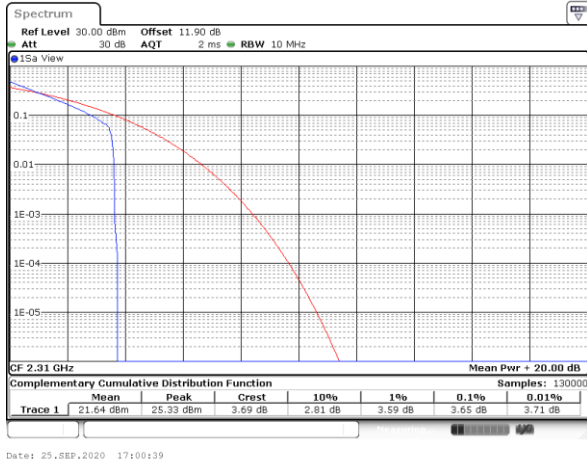

Date: 25_SEP.2020 17:00:39

Middle Channel / Full RB

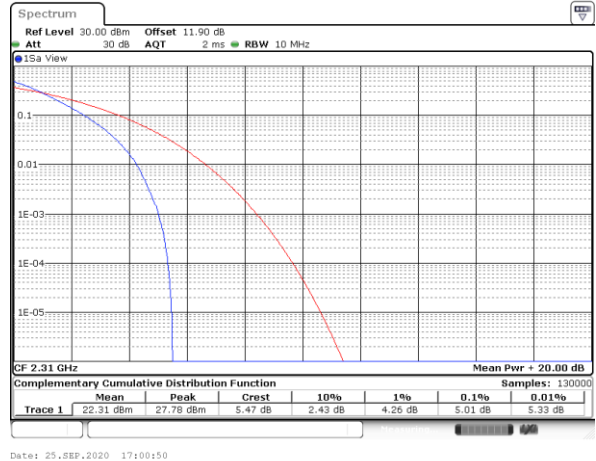

Date: 25_SEP.2020 17:00:50

LTE Band 30 / 10MHz / 16QAM

Middle Channel / 1RB

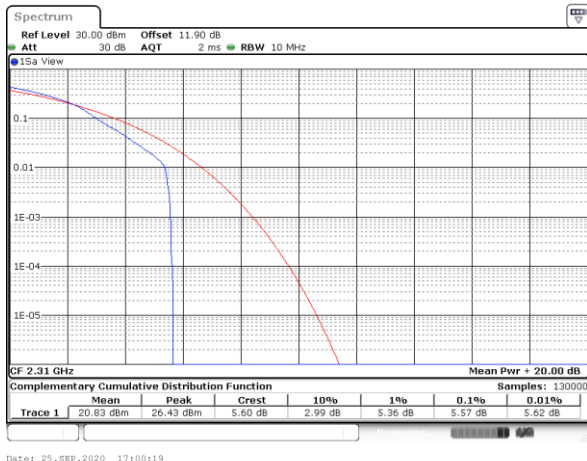

Date: 25_SEP.2020 17:00:19

Middle Channel / Full RB

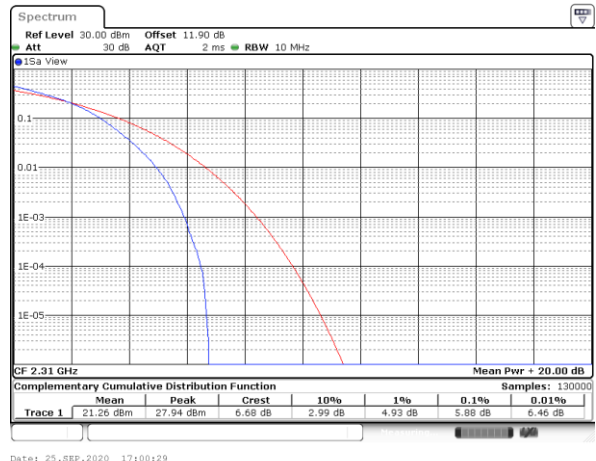

Date: 25_SEP.2020 17:00:29



LTE Band 30 / 10MHz / 64QAM

Middle Channel / 1RB

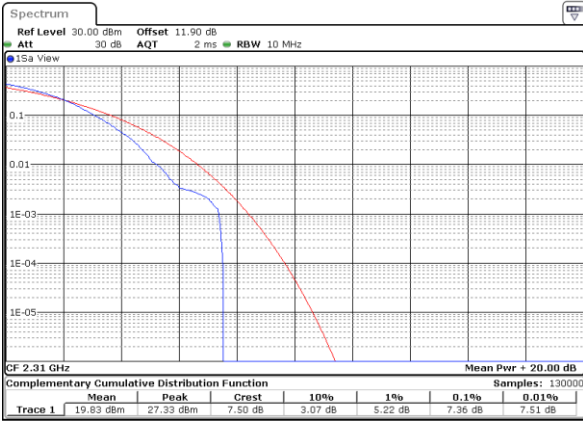

Date: 25_SEP.2020 16:59:50

Middle Channel / Full RB

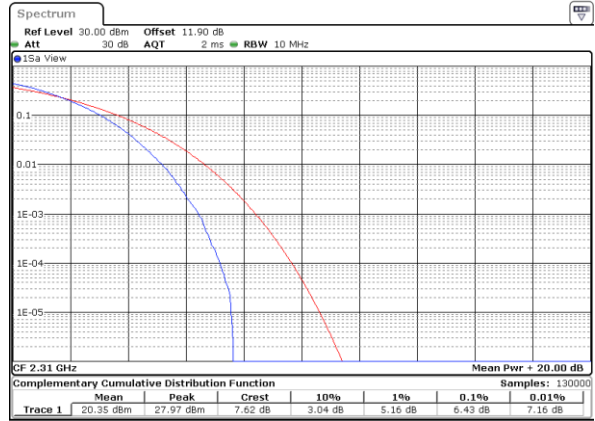

Date: 25_SEP.2020 17:00:08

LTE Band 30 / 10MHz / 256QAM

Middle Channel / 1RB

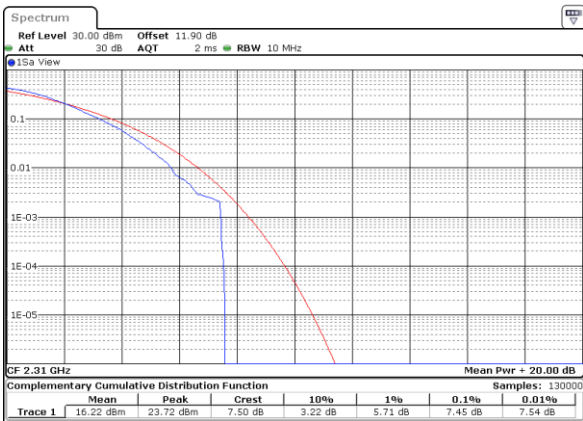

Date: 28_SEP.2020 15:51:26

Middle Channel / Full RB



Date: 28_SEP.2020 15:50:51



EIRP Power Density

Mode	LTE Band 30 : Conducted Power Density (dBm/5MHz)											
BW	-		-		5MHz		10MHz		-		-	
Mod.	-	-	-	-	QPSK	16QAM	QPSK	16QAM	-	-	-	-
Lowest CH	-	-	-	-	24.46	24.10	-	-	-	-	-	-
Middle CH	-	-	-	-	24.56	23.95	24.37	23.91	-	-	-	-
Highest CH	-	-	-	-	24.37	23.71	-	-	-	-	-	-

Mode	LTE Band 30 : Conducted Power Density (dBm/5MHz)											
BW	-		-		5MHz		10MHz		-		-	
Mod.	-	-	-	-	64QAM	256 QAM	64QAM	256 QAM	-	-	-	-
Lowest CH	-	-	-	-	23.09	19.05	-	-	-	-	-	-
Middle CH	-	-	-	-	22.94	18.50	22.80	18.64	-	-	-	-
Highest CH	-	-	-	-	22.59	18.71	-	-	-	-	-	-

Mode	LTE Band 30 : EIRP Power Density (dBm/5MHz)											
BW	-		-		5MHz		10MHz		-		-	
Mod.	-	-	-	-	QPSK	16QAM	QPSK	16QAM	-	-	-	-
Lowest CH	-	-	-	-	23.86	23.5	-	-	-	-	-	-
Middle CH	-	-	-	-	23.96	23.35	23.77	23.31	-	-	-	-
Highest CH	-	-	-	-	23.77	23.11	-	-	-	-	-	-

Mode	LTE Band 30 : EIRP Power Density (dBm/5MHz)											
BW	-		-		5MHz		10MHz		-		-	
Mod.	-	-	-	-	64QAM	256 QAM	64QAM	256 QAM	-	-	-	-
Lowest CH	-	-	-	-	22.49	18.45	-	-	-	-	-	-
Middle CH	-	-	-	-	22.34	17.9	22.2	18.04	-	-	-	-
Highest CH	-	-	-	-	21.99	18.11	-	-	-	-	-	-
Antenna Gain	-0.6 dBi											
Limit	250mW / 5MHz = 24dBm / 5MHz											
Result	Pass											



LTE Band 30 / 5MHz

Lowest Channel / 5MHz / 1RB0 / QPSK

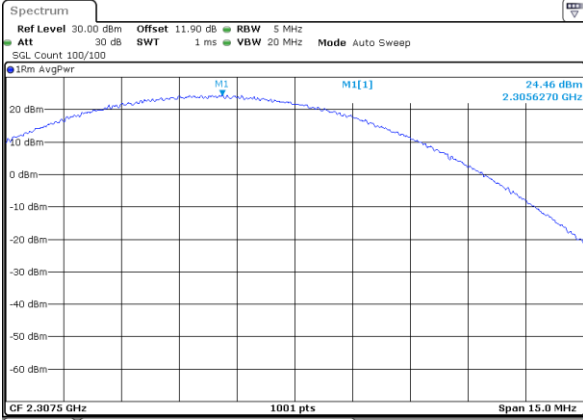

Date: 25_SEP.2020 17:02:04

Lowest Channel / 5MHz / 1RB0 / 16QAM

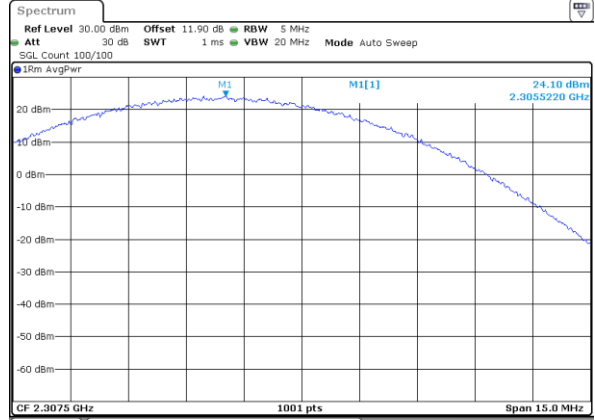

Date: 25_SEP.2020 17:02:22

Middle Channel / 5MHz / 1RB0 / QPSK

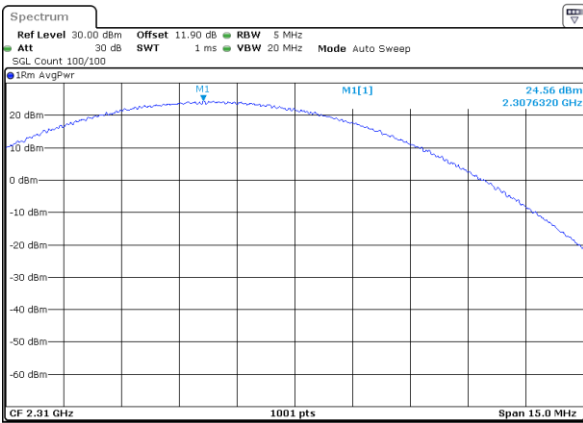

Date: 25_SEP.2020 17:02:58

Middle Channel / 5MHz / 1RB0 / 16QAM

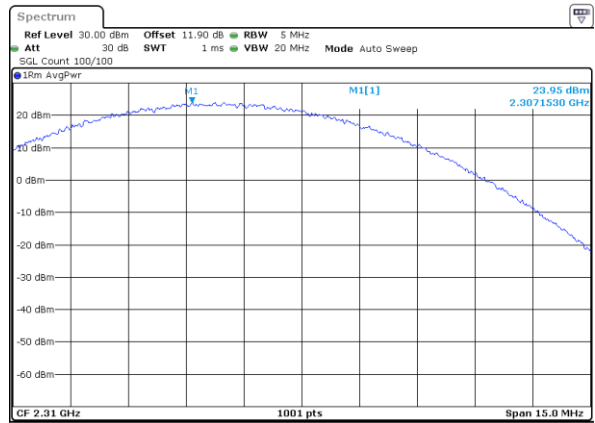

Date: 25_SEP.2020 17:03:16

Highest Channel / 5MHz / 1RB0 / QPSK

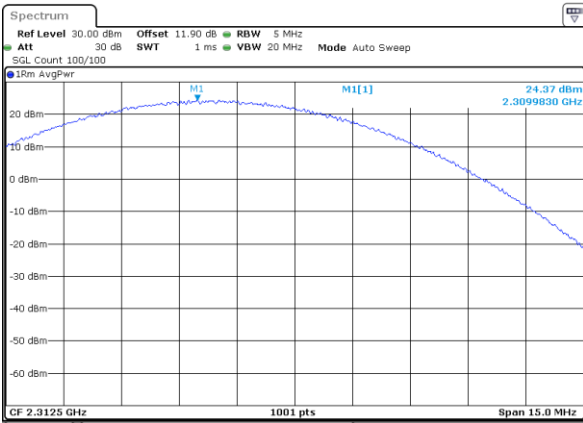

Date: 25_SEP.2020 17:03:52

Highest Channel / 5MHz / 1RB0 / 16QAM

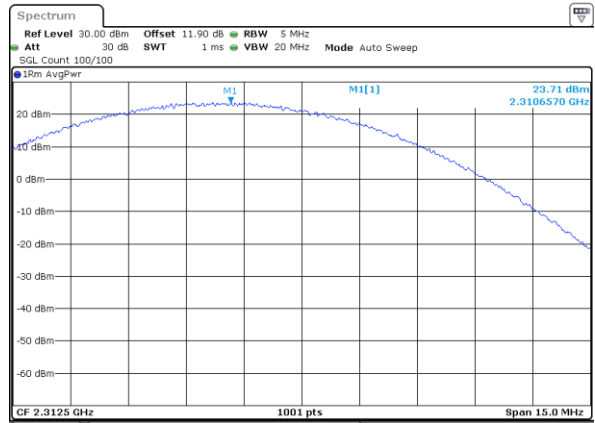

Date: 25_SEP.2020 17:04:11



LTE Band 30 / 5MHz

Lowest Channel / 5MHz / 1RB0 / 64QAM

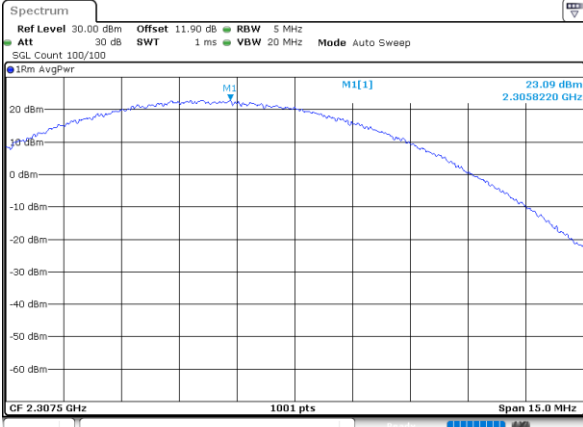

Date: 25_SEP.2020 17:02:40

Middle Channel / 5MHz / 1RB0 / 64QAM

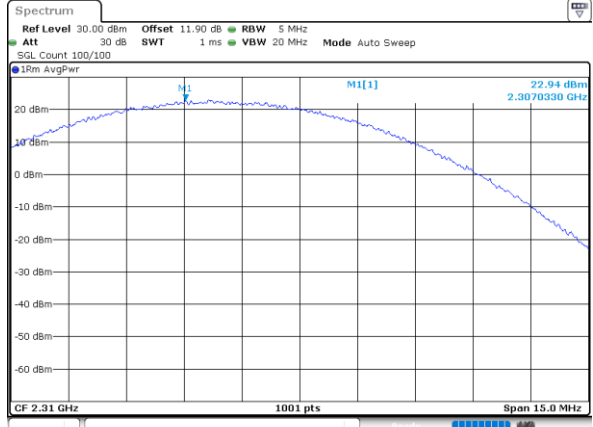

Date: 25_SEP.2020 17:03:34

Highest Channel / 5MHz / 1RB0 / 64QAM

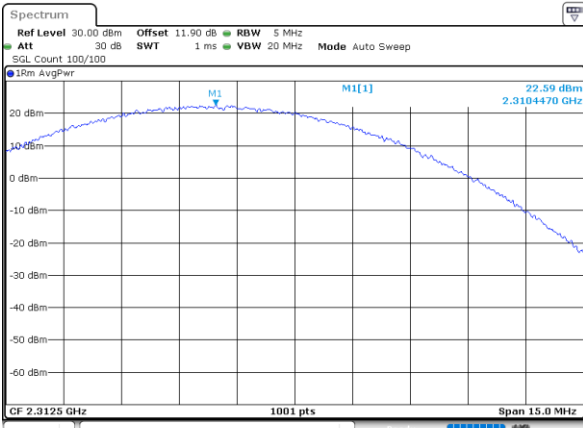

Date: 25_SEP.2020 17:04:29



LTE Band 30 / 5MHz

Lowest Channel / 5MHz / 1RB0 / 256QAM

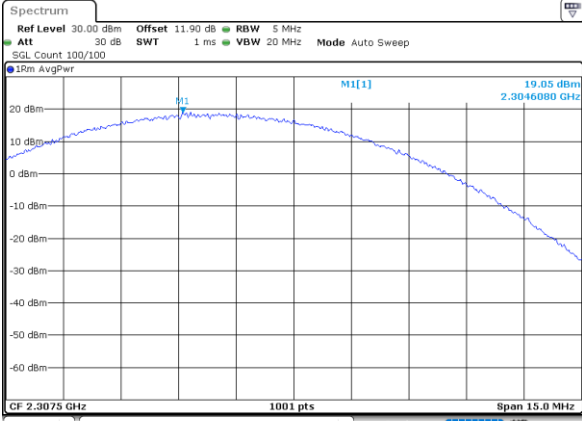

Date: 28_SEP.2020 15:46:06

Middle Channel / 5MHz / 1RB0 / 256QAM

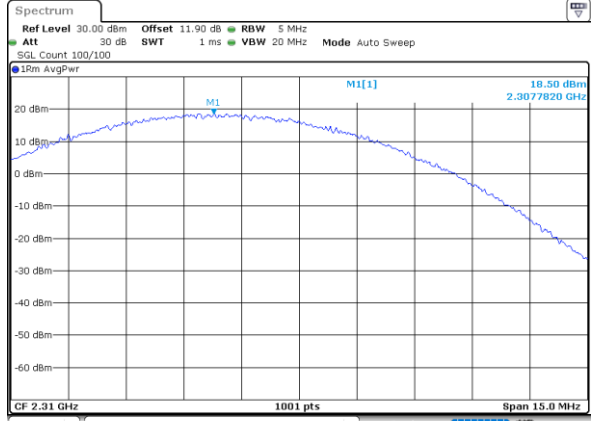

Date: 28_SEP.2020 15:44:10

Highest Channel / 5MHz / 1RB0 / 256QAM

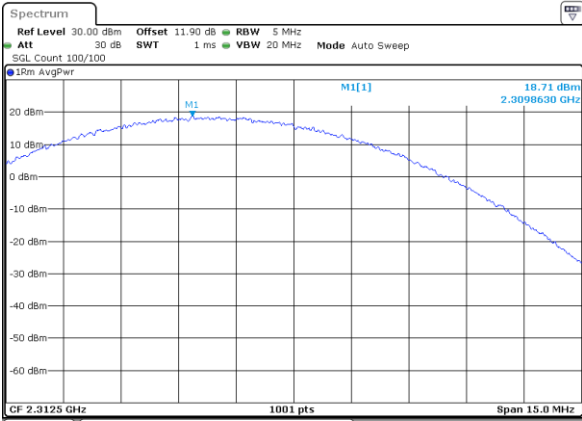

Date: 28_SEP.2020 15:48:39



LTE Band 30 / 10MHz

Lowest Channel / 10MHz / 1RB0 / QPSK

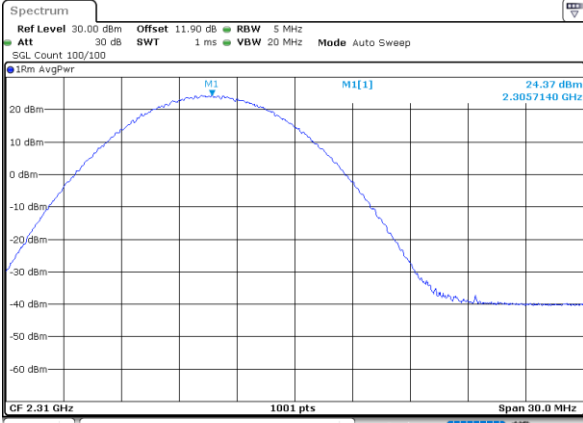

Date: 25_SEP.2020 17:04:48

Lowest Channel / 10MHz / 1RB0 / 16QAM

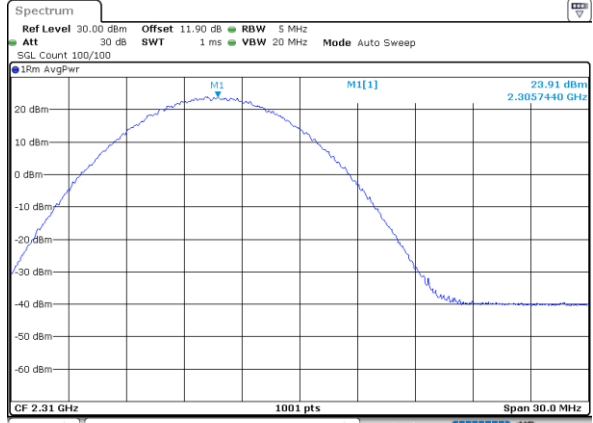

Date: 25_SEP.2020 17:05:06

Lowest Channel / 10MHz / 1RB0 / 64QAM

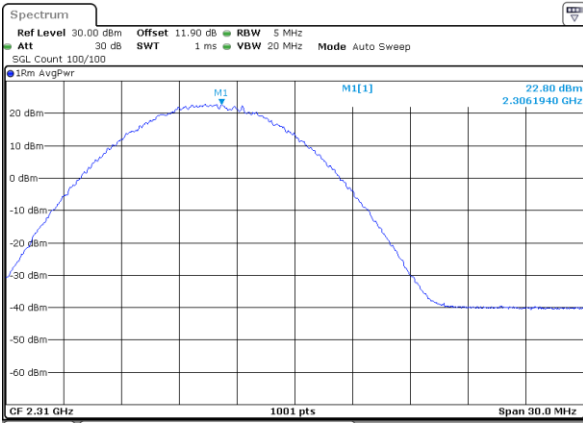

Date: 25_SEP.2020 17:05:24

Lowest Channel / 10MHz / 1RB0 / 256QAM

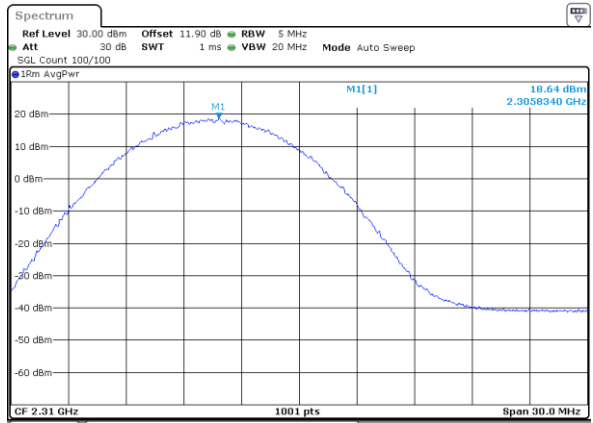

Date: 28_SEP.2020 15:51:41



26dB Bandwidth

Mode	LTE Band 30 : 26dB BW(MHz)											
BW	-		-		5MHz		10MHz		-		-	
Mod.	-	-	-	-	QPSK	16QAM	QPSK	16QAM	-	-	-	-
Lowest CH	-	-	-	-	4.92	4.87	-	-	-	-	-	-
Middle CH	-	-	-	-	4.84	4.91	9.89	9.73	-	-	-	-
Highest CH	-	-	-	-	4.90	4.90	-	-	-	-	-	-
Mode	LTE Band 30 : 26dB BW(MHz)											
BW	-		-		5MHz		10MHz		-		-	
Mod.	-	-	-	-	64QAM	256 QAM	64QAM	256 QAM	-	-	-	-
Lowest CH	-	-	-	-	4.90	4.90	-	-	-	-	-	-
Middle CH	-	-	-	-	4.90	4.83	9.79	9.73	-	-	-	-
Highest CH	-	-	-	-	4.89	4.96	-	-	-	-	-	-



LTE Band 30

Lowest Channel / 5MHz / QPSK

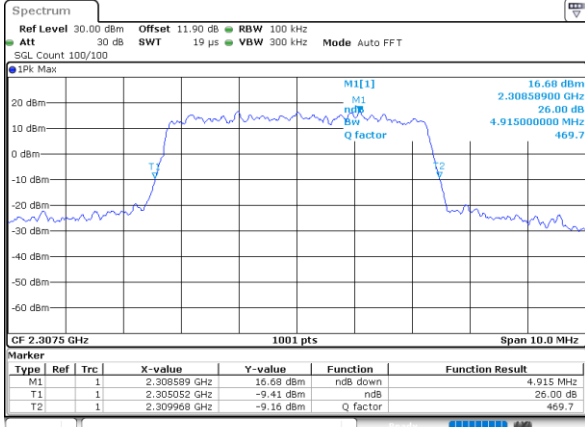

Date: 25_SEP.2020 16:54:20

Lowest Channel / 5MHz / 16QAM

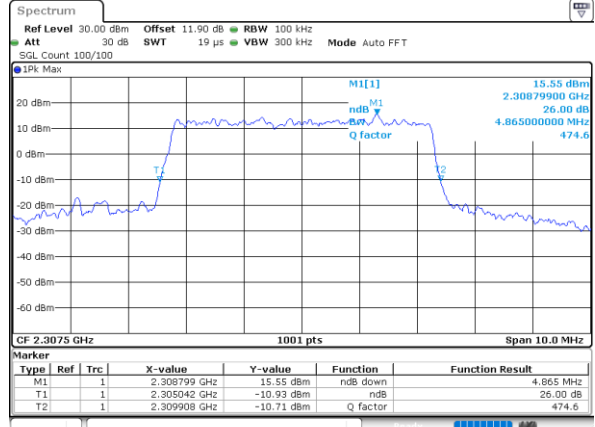

Date: 25_SEP.2020 16:54:31

Middle Channel / 5MHz / QPSK

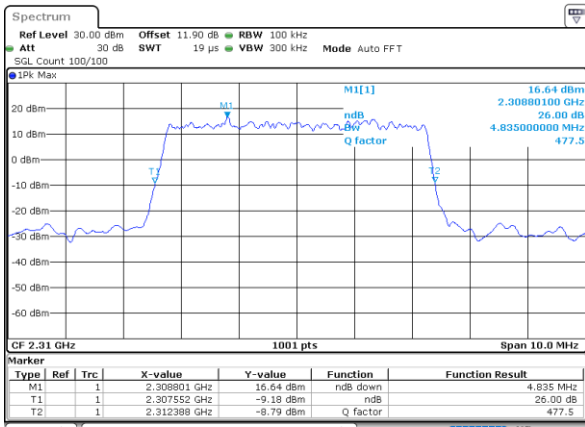

Date: 25_SEP.2020 16:55:05

Middle Channel / 5MHz / 16QAM

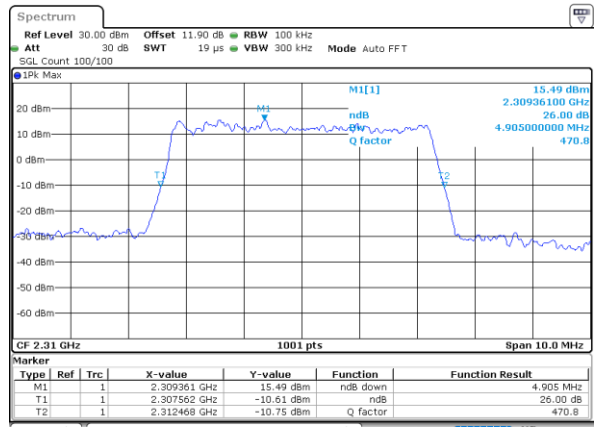

Date: 25_SEP.2020 16:55:17

Highest Channel / 5MHz / QPSK

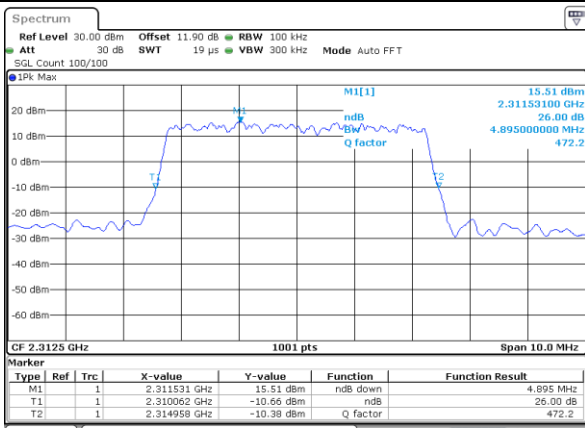

Date: 25_SEP.2020 16:55:52

Highest Channel / 5MHz / 16QAM

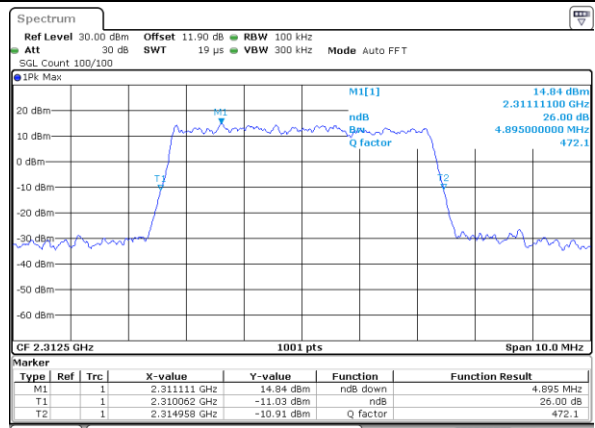

Date: 25_SEP.2020 16:56:04



LTE Band 30

Middle Channel / 10MHz / QPSK

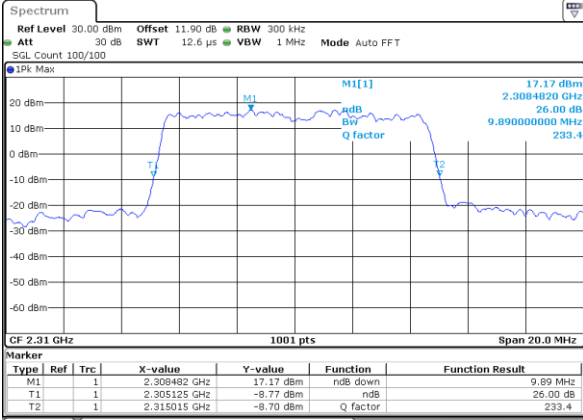

Date: 25_SEP_2020 16:56:38

Middle Channel / 10MHz / 16QAM

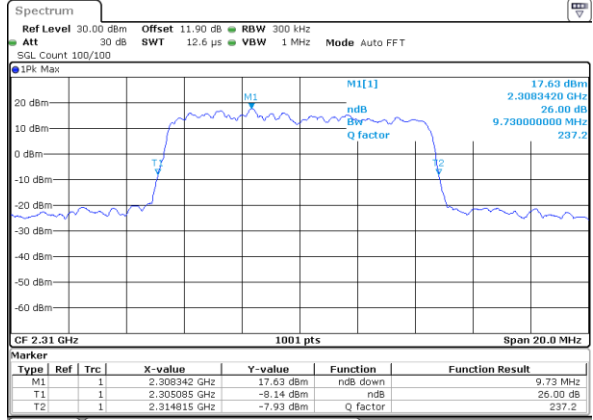

Date: 25_SEP_2020 16:56:49



LTE Band 30

Lowest Channel / 5MHz / 64QAM

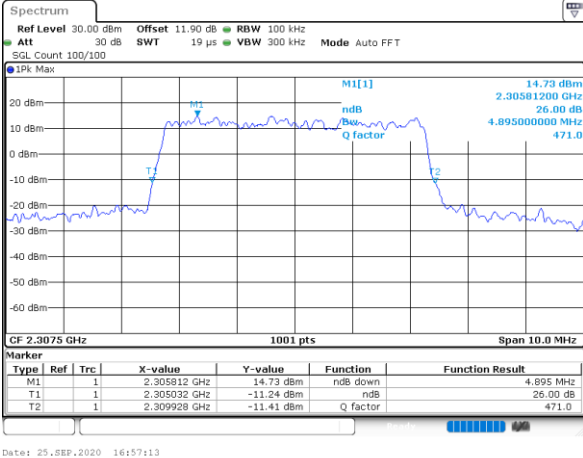

Middle Channel / 5MHz / 64QAM

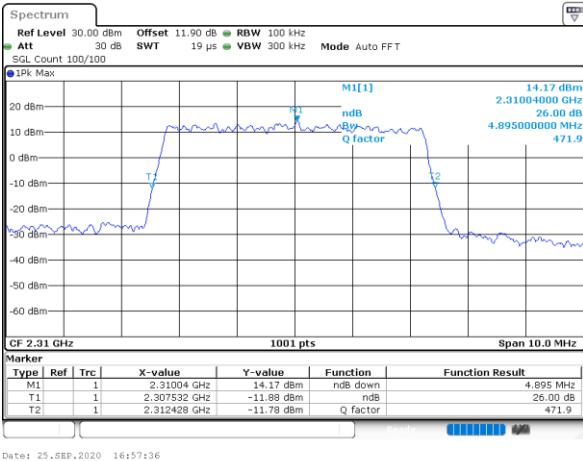

Middle Channel / 10MHz / 64QAM

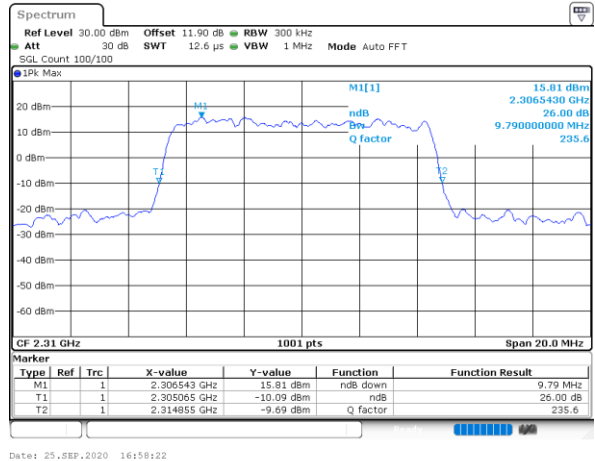

Highest Channel / 5MHz / 64QAM

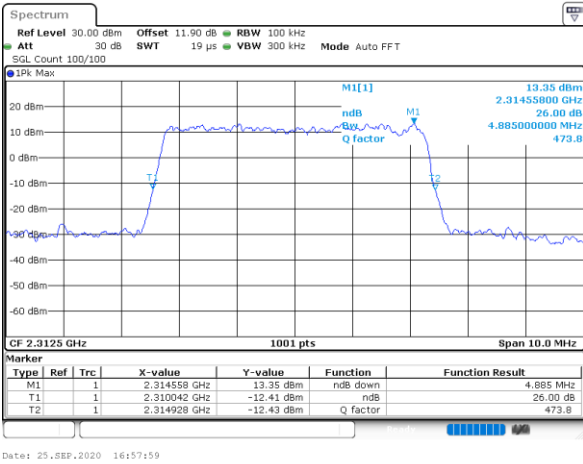



LTE Band 30

Lowest Channel / 5MHz / 256QAM

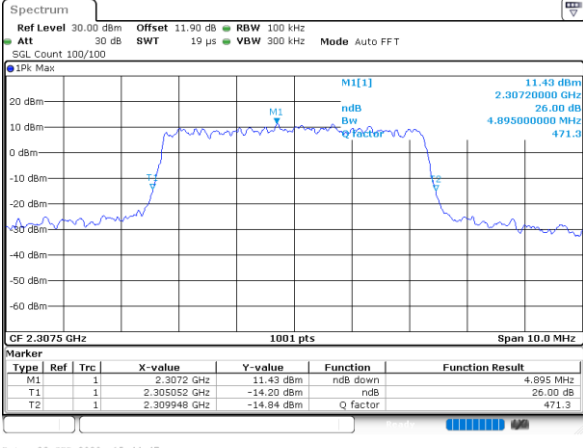

Date: 28_SEP.2020 15:44:47

Middle Channel / 5MHz / 256QAM

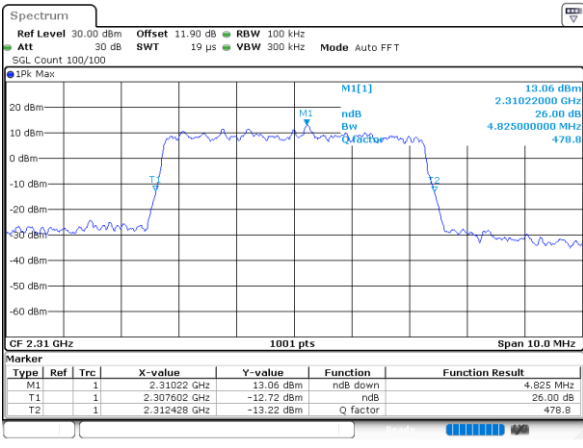

Date: 28_SEP.2020 15:14:02

Middle Channel / 10MHz / 256QAM

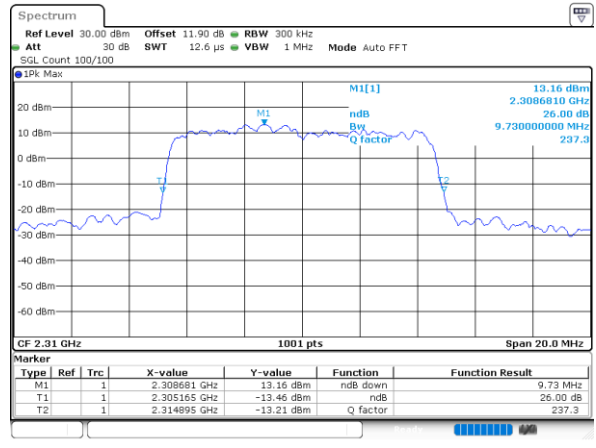

Date: 28_SEP.2020 15:50:44

Highest Channel / 5MHz / 256QAM

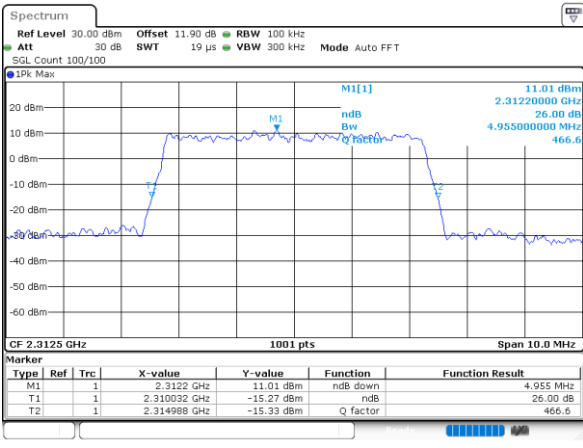

Date: 28_SEP.2020 15:47:34