



**Choose certainty.
Add value.**

Report On

Application for Grant of Equipment Authorization of the
Inseego Corp.
MD8800 Wireless Module

FCC CFR 47 Part 2 and 90: 2018
RSS-140 Issue 1 April 2018

Report No. 72140633C Rev 1.0

March 2019



REPORT ON Radio Testing of the
Inseego Corp.
MD8800 Wireless Module

TEST REPORT NUMBER 72140633C Rev 1.0

PREPARED FOR Inseego Corp.
9605 Scranton Road, Suite 300
San Diego, CA 92121
USA

CONTACT PERSON Roman Olmos
Senior Regulatory Engineer
(858) 812-0606
roman.olmos@inseego.com

PREPARED BY 
Xiaoying Zhang
Name
Authorized Signatory
Title: EMC/Wireless Test Engineer

APPROVED BY 
Ferdinand S. Custodio
Name
Authorized Signatory
Title: Senior EMC Test Engineer/Wireless Team Lead

DATED March 28, 2019



Revision History

72140633C Rev 1.0 Inseego Corp. MD8800 Wireless Module					
DATE	OLD REVISION	NEW REVISION	REASON	PAGES AFFECTED	APPROVED BY
12/28/2018	-	Initial Release			Ferdinand Custodio
03/28/2019	Initial Release	Rev 1.0	Changed FCC ID	All	Ferdinand Custodio



CONTENTS

Section	Page No
1	REPORT SUMMARY..... 5
1.1	Introduction 6
1.2	Brief Summary of Results..... 7
1.3	Product Information 8
1.4	EUT Test Configuration 10
1.5	Deviations from the Standard..... 12
1.6	Modification Record 12
1.7	Test Methodology..... 12
1.8	Test Facility Location..... 12
1.9	Test Facility Registration 12
1.10	Sample Calculations 14
2	TEST DETAILS 15
2.1	Transmitter Conducted Power Measurements 16
2.2	Effective Radiated Power 19
2.3	Occupied Bandwidth..... 21
2.4	Peak-Average Power Ratio..... 25
2.5	Band Edge 28
2.6	Conducted Spurious Emissions 34
2.7	Field Strength of Spurious Radiation 44
2.8	Frequency Stability 50
3	TEST EQUIPMENT USED 53
3.1	Test Equipment Used..... 54
3.2	Measurement Uncertainty 55
4	DIAGRAM OF TEST SETUP 57
4.1	Test Setup Diagram..... 58
5	ACCREDITATION, DISCLAIMERS AND COPYRIGHT 62
5.1	Accreditation, Disclaimers and Copyright..... 63



SECTION 1

REPORT SUMMARY

Radio Testing of the
Insego Corp.
MD8800 Wireless Module



1.1 INTRODUCTION

The information contained in this report is intended to show verification of the Inseego Corp. MD8800 Wireless Module to the requirements of the following:

- FCC CFR 47 Part 2 and 90: 2018
- RSS-Gen Issue 5 April 2018
- RSS-140 Issue 1 April 2018

Objective	To perform Radio Testing to determine the Equipment Under Test's (EUT's) compliance with the Test Specification, for the series of tests carried out.
Manufacturer	Inseego Corp.
Product Trademark/Brand	Inseego
Product Marketing Name	MD8800
Model Number(s)	MD8800
FCC ID Number	PKRISGMD8800
IC Number	3229A-MD8800
Serial Number(s)	AS190818B00021 AZ280418A00044 (Host Model MIFI8800L serial number)
Number of Samples Tested	2
Test Specification/Issue/Date	<ul style="list-style-type: none">• FCC CFR 47 Part 2 and 90 (October 1, 2018)• KDB412172 D01 Determining ERP and EIRP v01r01 August 07, 2015: Guidelines for determining the Effective Radiated Power (ERP) and Equivalent Isotropically Radiated Power (EIRP) of an RF transmitting system• KDB971168 D01 Power Meas License Digital Systems v03r01: April 9 2018: Measurement guidance for certification of licensed digital transmitters• RSS-140 Issue 1: April 2018 – Equipment Operating in the Public Safety Broadband Frequency Bands 758-768 MHz and 788-798 MHz• RSS-Gen Issue 5: April 2018 - General Requirements for Compliance of Radio Apparatus• ANSI C63.26-2015: American National Standard for Compliance Testing of Transmitters Used in Licensed Radio Services
Start of Test	June 11, 2018
Finish of Test	October 24, 2018
Name of Engineer(s)	Xiaoying Zhang
Related Document(s)	<ul style="list-style-type: none">• 72139211C_Novatel MIFI8800L_FCC Part 90_LTE Band 14_RSS 140_Test Report.pdf• Supporting document for Certification are separate exhibits.



1.2 BRIEF SUMMARY OF RESULTS

A brief summary of the tests carried out in accordance with FCC CFR 47 Part 2 and 90: 2018 with cross-reference to the corresponding ISED RSS standard is shown below.

Section	FCC Part Sections(s)	RSS Section(s)	Test Description	Result
2.1	2.1046	RSS-140 (4.3)	Transmitter Conducted Output Power	Compliant*
2.2	2.1046 90.542(a)(7)	RSS-140 (6.5)	Effective Radiated Power	Compliant*
2.3	2.1049	RSS-Gen (6.7)	Occupied Bandwidth	Compliant*
2.4	-	RSS-140 (4.3)	Peak-Average Ratio	Compliant*
2.5	2.1051 90.543(e)(3)(5)	RSS-140 (4.4)	Band Edge	Compliant*
2.6	2.1051 90.543(e)(2)(3)(4)(5) (f)	RSS-140 (4.4)	Conducted Spurious Emissions	Compliant*
2.7	2.1053 90.543(e)	RSS-140 (4.4)	Field Strength of Spurious Radiation	Compliant
2.8	2.1055 90.539	RSS-140 (4.2)	Frequency Stability	Compliant*
-	-	RSS-Gen 7.4	Receiver Spurious Emissions	N/A*

Compliant*: The module was previously tested in a host under Model Number MIFI8800L. All the conducted measurements for LTE Band 14 were from the host and covered under test report 72139211C_Novatel MIFI8800L_FCC Part 90_LTE Band 14_RSS 140_Test Report.pdf.

N/A*: *Not required as per RSS-GEN 5.2. EUT is not a Stand-Alone receiver.*



1.3 PRODUCT INFORMATION

1.3.1 EUT General Description

The Equipment Under Test (EUT) was an Inseego Corp. MD8800 Wireless Module. The EUT is a Wireless Module supporting 2G/3G/4G, Wi-Fi, and GPS/GLNSS Technologies. The EUT is mounted on a mini ground plane for the ease of testing. The EUT comes with a USB Port to connect to an AC Adaptor.

1.3.2 Technical Description

EUT Description	Wireless Module
Product Marketing Name	MD8800
Model Number(s)	MD8800
Rated Voltage	Input 100-240VAC, Output 5V (External AC-DC Power Adapter)
Mode Verified	LTE Band 14: 788-798 MHz
Capability	WCDMA Band 2, 5 and LTE Band 2, 4, 5, 7, 13, 14, 46, 48, 66
Primary Unit (EUT)	<input checked="" type="checkbox"/> Production <input type="checkbox"/> Pre-Production <input type="checkbox"/> Engineering

(Client declaration, max. antenna gain covered under this test report)

LTE Bands	Frequency(ies)	Antenna Gains
Band 14	788-798 MHz	-0.6 dBi



1.3.3 Transmit Frequency Table

LTE Band 14					
Modulation	Bandwidth (MHz)	Tx Frequency (MHz)	Emission Designator	ERP	
				Max Power (dBm)	Max Power (Watts)
QPSK	5	788 – 798	4M49G7D	21.13	0.13
	10		8M95G7D	21.1	0.13
16QAM	5		4M48W7D	20.23	0.11
	10		8M95W7D	20.22	0.11

1.4 EUT TEST CONFIGURATION

1.4.1 Test Configuration Description

Test Configuration	Description
A	Conducted antenna port measurement. EUT is powered via AC Adapter and controlled by a call box to transmit at max power.
B	Radiated test setup / case spurious emissions. The EUT is mounted on a mini ground plane for the ease of testing and powered via AC Adaptor. The Antenna port is terminated by the call box.

1.4.2 EUT Exercise Software

EUT is controlled by a CMW 500 Wideband Radio Communication Tester or a Keysight E7515A UXM Wireless Test Set. There are no other test software used during verification.

1.4.3 Support Equipment and I/O cables

Manufacturer	Equipment/Cable	Description
Inseego Corp.	USB Cable	Standard USB Type A to USB Type C
Inseego Corp.	External AC-DC Power Adapter	Model: SSW-2783, PN: 40123126.01 Input: 100-240VAC, 50/60Hz, 0.5A Output: 5VDC, max. 2A

1.4.4 Worst Case Configuration

Worst-case configuration used in this test report as per output power measurements:

Band	Channel BW	Modulation	RB Size/Offset
Band 14	5 MHz	QPSK	1/0

For radiated measurements X, Y, and Z orientations were verified. The verification was determined "X" as worst case configuration.

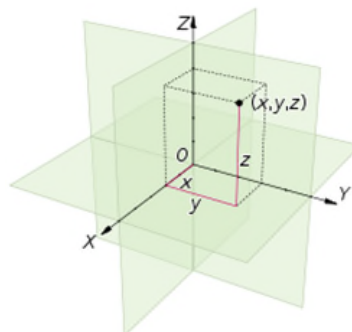

1.4.5 Simplified Test Configuration Diagram

Radiated Test Configuration/Conducted Emissions Test Configuration

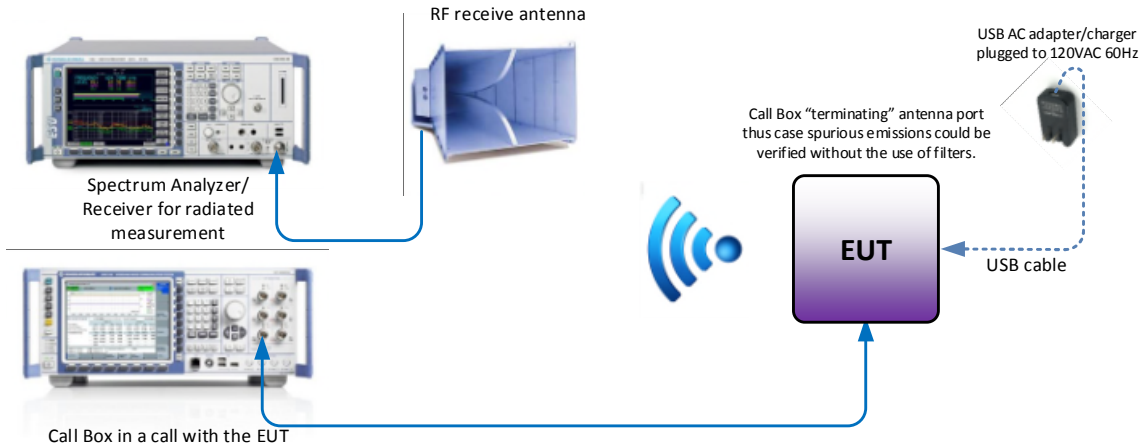

Conducted (Antenna Port) Test Configuration

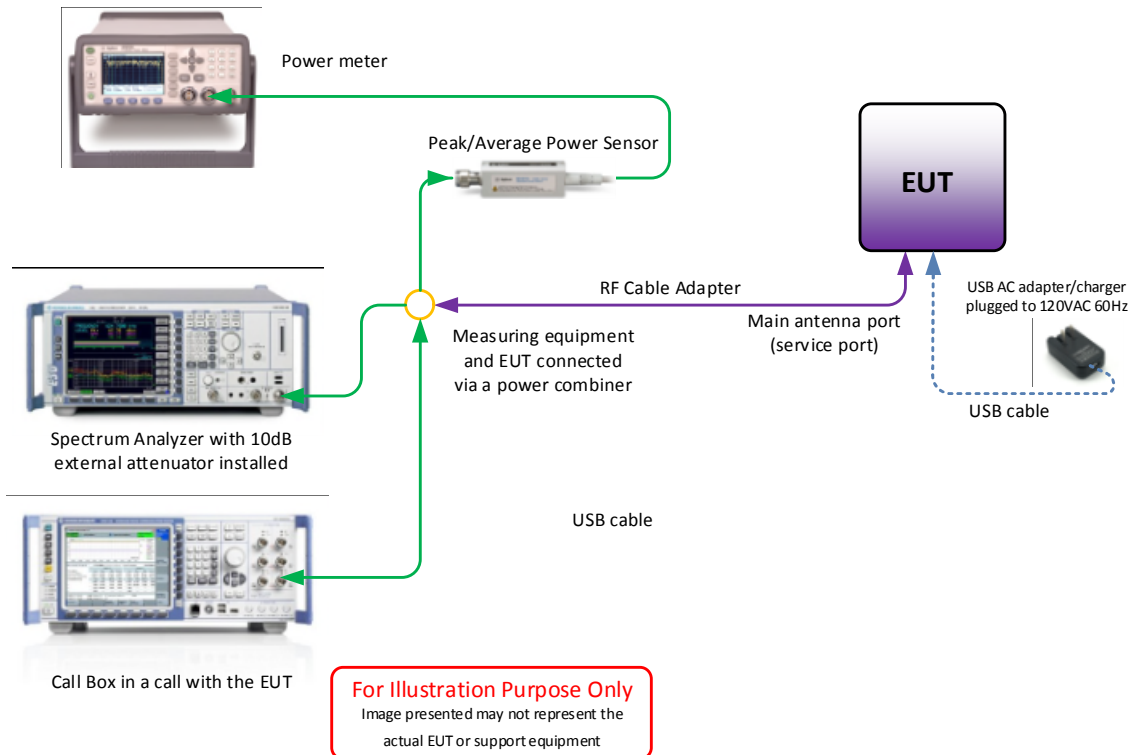



1.5 DEVIATIONS FROM THE STANDARD

No deviations from the applicable test standards or test plan were made during testing.

1.6 MODIFICATION RECORD

Description of Modification	Modification Fitted By	Date Modification Fitted
Serial Number: AS190818B00021, AZ280418A00044 (Host Model MIFI8800L serial number)		
None	—	—

The table above details modifications made to the EUT during the test programme. The modifications incorporated during each test (if relevant) are recorded on the appropriate test pages.

1.7 TEST METHODOLOGY

All measurements contained in this report were conducted with ANSI C63.26-2015, American National Standard for Compliance Testing of Transmitters Used in Licensed Radio Services.

For conducted and radiated emissions the equipment under test (EUT) was configured to measure its highest possible emission level. The test modes were adapted according to the Operating Instructions provided by the manufacturer/client.

1.8 TEST FACILITY LOCATION

1.8.1 TÜV SÜD America Inc. (Mira Mesa)

10040 Mesa Rim Road, San Diego, CA 92121-2912 (32.901268,-117.177681). Phone: 858 678 1400 FAX: 858 546 0364

1.8.2 TÜV SÜD America Inc. (Rancho Bernardo)

16936 Via Del Campo, San Diego, CA 92127-1708 (33.018644,-117.092409). Phone: (858) 678-1400 Fax: (858) 546-0364.

1.9 TEST FACILITY REGISTRATION

1.9.1 FCC – Designation No.: US1146

TUV SUD America Inc. (San Diego), is an accredited test facility with the site description report on file and has met all the requirements specified in §2.948 of the FCC rules. The acceptance letter from the FCC is maintained in our files and the Designation is US1146.



1.9.2 Innovation, Science and Economic Development Canada (IC) Registration No.: 3067A-1 & 22806-1

The 10m Semi-anechoic chamber of TUV SUD America Inc. (San Diego Rancho Bernardo) has been registered by Certification and Engineering Bureau of Innovation, Science and Economic Development Canada for radio equipment testing with Registration No. 3067A-1.

The 3m Semi-anechoic chamber of TUV SUD America Inc. (San Diego Mira Mesa) has been registered by Certification and Engineering Bureau of Innovation, Science and Economic Development Canada for radio equipment testing with Registration No. 22806-1.

1.9.3 BSMI – Laboratory Code: SL2-IN-E-028R (US0102)

TUV Product Service Inc. (San Diego) is a recognized EMC testing laboratory by the BSMI under the MRA (Mutual Recognition Arrangement) with the United States. Accreditation includes CNS 13438 up to 6GHz.

1.9.4 NCC (National Communications Commission - US0102)

TUV SUD America Inc. (San Diego) is listed as a Foreign Recognized Telecommunication Equipment Testing Laboratory and is accredited to ISO/IEC 17025 (A2LA Certificate No.2955.13) which under APEC TEL MRA Phase 1 was designated as a Conformity Assessment Body competent to perform testing of equipment subject to the Technical Regulations covered under its scope of accreditation including RTTE01, PLMN01 and PLMN08 for TTE type of testing and LP002 for Low-Power RF Device type of testing.

1.9.5 VCCI – Registration No. A-0280 and A-0281

TUV SUD America Inc. (San Diego) is a VCCI registered measurement facility which includes radiated field strength measurement, radiated field strength measurement above 1GHz, mains port interference measurement and telecommunication port interference measurement.

1.9.6 RRA – Identification No. US0102

TUV SUD America Inc. (San Diego) is National Radio Research Agency (RRA) recognized laboratory under Phase I of the APEC Tel MRA.

1.9.7 OFCA – U.S. Identification No. US0102

TUV SUD America Inc. (San Diego) is recognized by Office of the Communications Authority (OFCA) under Appendix B, Phase I of the APEC Tel MRA.



1.10 SAMPLE CALCULATIONS

1.10.1 LTE Emission Designator (QPSK)

Emission Designator = 4M51G7D
 G = Phase Modulation
 7= Quantized/Digital Info
 D = Data Transmission, telemetry, telecommand

1.10.2 LTE Emission Designator (16QAM)

Emission Designator = 4M50W7D
 W = Frequency Modulation
 7= Quantized/Digital Info
 D = Data Transmission, telemetry, telecommand

1.10.3 Spurious Radiated Emission (below 1GHz)

Measuring equipment raw measurement (dbμV) @ 30 MHz			24.4
Correction Factor (dB)	Asset# 1066 (cable)	0.3	-12.6
	Asset# 1172 (cable)	0.3	
	Asset# 1016 (preamplifier)	-30.7	
	Asset# 1175(cable)	0.3	
	Asset# 1002 (antenna)	17.2	
Reported QuasiPeak Final Measurement (dbμV/m) @ 30MHz			11.8

1.10.4 Spurious Radiated Emission – Substitution Method

Example = 84dBμV/m @ 1413 MHz (numerical sample only)

The field strength reading of 84dBμV/m @ 1413 MHz (2nd Harmonic of 706.5 MHz) is the maximized measurement when the EUT is on the turntable measured at 3 meters. The gain of the substituted antenna is 7.8dBi while the transmit cable loss is 1.0 dB (cable between signal generator and the substituted antenna). The signal generator level is adjusted until the 84dBμV/m level at the receiving end is replicated (identical test setup, i.e. same antenna, cable/s and preamp). If the adjusted signal generator level is -18dBm, then we have the following for both EIRP and ERP as required:

$$\begin{aligned}
 P_{EIRP} &= -18 \text{ dBm} + 7.8 \text{ dBi} - 1 \text{ dB} \\
 &= 11.2 \text{ dBm} \\
 P_{ERP} &= P_{EIRP} - 2.15 \text{ dB} \\
 &= 11.2 \text{ dBm} - 2.15 \text{ dB} \\
 &= 9.05 \text{ dBm}
 \end{aligned}$$



SECTION 2

TEST DETAILS

Radio Testing of the
Inseego Corp.
MD8800 Wireless Module



2.1 TRANSMITTER CONDUCTED POWER MEASUREMENTS

2.1.1 Specification Reference

FCC 47 CFR Part 2, Clause 2.1046
RSS-140, Clause 4.3

2.1.2 Standard Applicable

The conducted power measurements were made in accordance to FCC Part 2 Clause 2.1046 and RSS-140 Clause 4.3.

2.1.3 Equipment Under Test and Modification State

Serial No: AZ280418A00044 / Test Configuration A

2.1.4 Date of Test/Initial of test personnel who performed the test

June 20, 2018 / XYZ

2.1.5 Test Equipment Used

The major items of test equipment used for the above tests are identified in Section 3.1.

2.1.6 Environmental Conditions/ Test Location

Test performed at TÜV SÜD America Inc. Rancho Bernardo facility

Ambient Temperature	24.0 °C
Relative Humidity	44.0 %
ATM Pressure	99.1 kPa

2.1.7 Additional Observations

- This is a conducted test using Power Meter.
- The path loss were measured and entered as a level offset.
- Low, Middle and High channels for all bandwidths with different RB size and RB offset and modulations were verified and reported.



2.1.8 Test Results

LTE Band 14									
Bandwidth (MHz)	Channel	Frequency (MHz)	Modulation	No. RB	RB Start	Average Power (dBm)	Peak Power (dBm)		
5	23305	790.5	QPSK	1	0	23.88	27.25		
				1	13	23.82	26.87		
				1	24	23.68	27.02		
				25	0	22.98	26.22		
			16QAM	1	0	22.98	27.85		
				1	13	22.81	26.48		
				1	24	22.77	27.76		
				25	0	21.97	26.19		
			23330	793	QPSK	1	0	23.81	26.9
						1	13	23.61	26.77
						1	24	23.36	26.59
						25	0	23.01	26.93
	16QAM	1			0	22.98	27.27		
		1			13	22.97	27.63		
		1			24	22.81	27.43		
		25			0	21.94	26.99		
	23355	795.5			QPSK	1	0	23.73	26.97
						1	13	23.68	26.67
						1	24	23.58	26.81
						25	0	23.0	27.78
			16QAM	1	0	22.85	27.62		
				1	13	22.82	27.36		
				1	24	22.73	27.43		
				25	0	22.06	27.92		

LTE Band 14							
Bandwidth (MHz)	Channel	Frequency (MHz)	Modulation	No. RB	RB Start	Average Power (dBm)	Peak Power (dBm)
10	23330	793	QPSK	1	0	23.85	27.18
				1	25	23.52	26.68
				1	49	23.56	26.75
				50	0	23.08	27.74
			16QAM	1	0	22.97	26.87
				1	25	22.86	27.65
				1	49	22.72	27.45
				50	0	22.02	27.88

2.1.9 Sample Test Measurement Screen

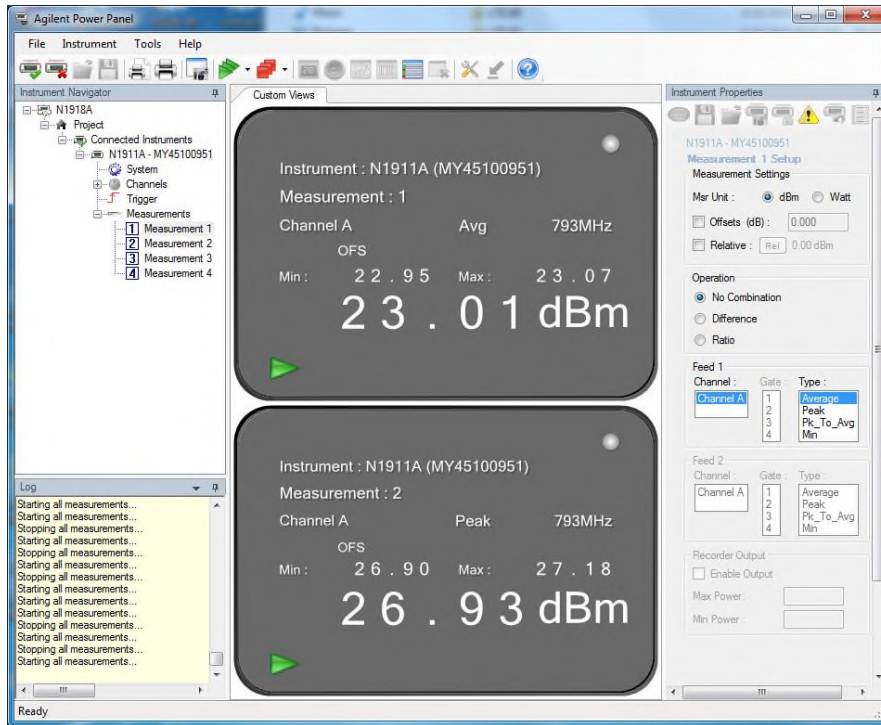

LTE Band 14 5M Bandwidth Middle Chanel QPSK Full RB



2.2 EFFECTIVE RADIATED POWER

2.2.1 Specification Reference

FCC 47 CFR Part 2, Clause 2.1046
FCC 47 CFR Part 90, Clause 90.542(a)(7)
RSS-140, Clause 4.3

2.2.2 Standard Applicable

FCC 47 CFR Part 90, Clause 90.542(a):
(7) Portable station (hand-held devices) transmitting in the 758-768 MHz band and the 788-798 MHz band are limited to 3 watts ERP.

RSS-140, Clause 4.3:

The e.r.p for portable equipment including handheld devices shall not exceed 3 W.

2.2.3 Equipment Under Test and Modification State

Serial No: AZ280418A00044 / Test Configuration (N/A, calculation only)

2.2.4 Date of Test/Initial of test personnel who performed the test

June 20, 2018 / XYZ

2.2.5 Test Equipment Used

The major items of test equipment used for the above tests are identified in Section 3.1.

2.2.6 Additional Observations

- ERP was calculated as per Section 1.2 and 1.3 of KDB412172 D01 (Determining ERP and EIRP v01r01).
- Calculation formula in logarithmic terms:

$$ERP = P_T + G_T - L_c - 2.15dB$$

Where:

P_T = transmitter conducted output power dBm (Section 2.1 of this test report)

G_T = gain of the transmitting antenna, in dBi (EIRP: the -2.15 in the formula is to convert EIRP to ERP);

L_c = signal attenuation in the connecting cable between the transmitter and antenna, in dB (EUT configuration during verification is mounted on an interface board with short direct connection to the antenna port. The loss between the EUT and the antenna port is considered negligible).



2.2.7 Test Results

LTE Band 14									
Modulation	Bandwidth (MHz)	RB Size/Offset	Channels	Frequency (MHz)	Tx Average Power (dBm)	Antenna Gain (dBi)	ERP (dBm)	Limit (dBm)	Margin (dBm)
QPSK	5	1 / 0	23305	790.5	23.88	-0.6	21.13	34.77	13.64
		1 / 0	23330	793	23.81	-0.6	21.06	34.77	13.71
		1 / 0	23355	795.5	23.73	-0.6	20.98	34.77	13.79
	10	-	-	-	-	-	-	-	-
		1 / 0	23330	793	23.85	-0.6	21.1	34.77	13.67
		-	-	-	-	-	-	-	-
16QAM	5	1 / 0	23305	790.5	22.98	-0.6	20.23	34.77	14.54
		1 / 13	23330	793	22.97	-0.6	20.22	34.77	14.55
		1 / 0	23355	795.5	22.85	-0.6	20.1	34.77	14.67
	10	-	-	-	-	-	-	-	-
		1 / 0	23330	793	22.97	-0.6	20.22	34.77	14.55
		-	-	-	-	-	-	-	-



2.3 OCCUPIED BANDWIDTH

2.3.1 Specification Reference

FCC 47 CFR Part 2, Clause 2.1049
RSS-GEN 6.7

2.3.2 Standard Applicable

The transmitted signal bandwidth shall be reported as the 99% emission bandwidth, that is the frequency bandwidth such that, below its lower and above its upper frequency limits, the mean powers radiated are each equal to 0.5 percent of the total mean power radiated by a given emission. 26dB Bandwidth is defined as the width of the signal between two points, one below the carrier center frequency and one above the carrier center frequency, outside of which all emissions are attenuated by at least 26 dB below the transmitter power.

Using the occupied bandwidth measurement function in the spectrum analyzer, the 99% occupied bandwidth was measured.

In addition, the 26dB bandwidth was measured in accordance with FCC KDB 971168 D01 V0202 Clause 4.1 using the ndB measurement function in the spectrum analyzer.

- The transmitter shall be operated at its maximum carrier power measured under normal test conditions.
- The span of the analyzer shall be set to capture all products of the modulation process, including the emission skirts.
- The resolution bandwidth (RBW) shall be in the range of 1% to 5% of the occupied bandwidth (OBW) and video bandwidth (VBW) shall be at least 3x RBW.

2.3.3 Equipment Under Test and Modification State

Serial No: AZ280418A00044 / Test Configuration A

2.3.4 Date of Test/Initial of test personnel who performed the test

June 11, 2018 / XYZ

2.3.5 Test Equipment Used

The major items of test equipment used for the above tests are identified in Section 3.1.

2.3.6 Environmental Conditions/ Test Location

Test performed at TÜV SÜD America Inc. Rancho Bernardo facility

Ambient Temperature	25.7 °C
Relative Humidity	51.3 %
ATM Pressure	98.5 kPa



2.3.7 Additional Observations

- This is a conducted test. Both 26dB bandwidth and 99% bandwidth presented.
- Using the occupied bandwidth measurement function in the spectrum analyzer, the 99% occupied bandwidth was measured.
- The 26dB bandwidth was measured in accordance with ANSI C63.26 clause 5.4.3 using the ndB measurement function in the spectrum analyzer.
- The transmitter shall be operated at its maximum carrier power measured under normal test conditions.
- The span of the analyzer shall be set to capture all products of the modulation process, including the emission skirts.
- The resolution bandwidth (RBW) shall be in the range of 1% of the occupied bandwidth (OBW) and video bandwidth (VBW) shall be at least 3x RBW.
- Low, Mid and High channels for all bandwidths and modulations were verified. Test results of Mid channel were presented as representative.

2.3.8 Test Results

LTE Band 14					
<i>Modulation</i>	<i>Bandwidth (MHz)</i>	<i>Channel</i>	<i>Frequency (MHz)</i>	<i>99% OBW (MHz)</i>	<i>26dB BW (MHz)</i>
QPSK	5	23330	793.0	4.49	4.95
	10			8.95	9.68
16QAM	5	23330	793.0	4.48	4.93
	10			8.95	9.64



2.3.9 Example Test Plots

LTE Band 14 (5 MHz BW) / Middle Channel 793.0 MHz / QPSK / 99%OBW



11:57:39 11.06.2018

LTE Band 14 (5 MHz BW) / Middle Channel 793.0 MHz / QPSK / 26dB BW

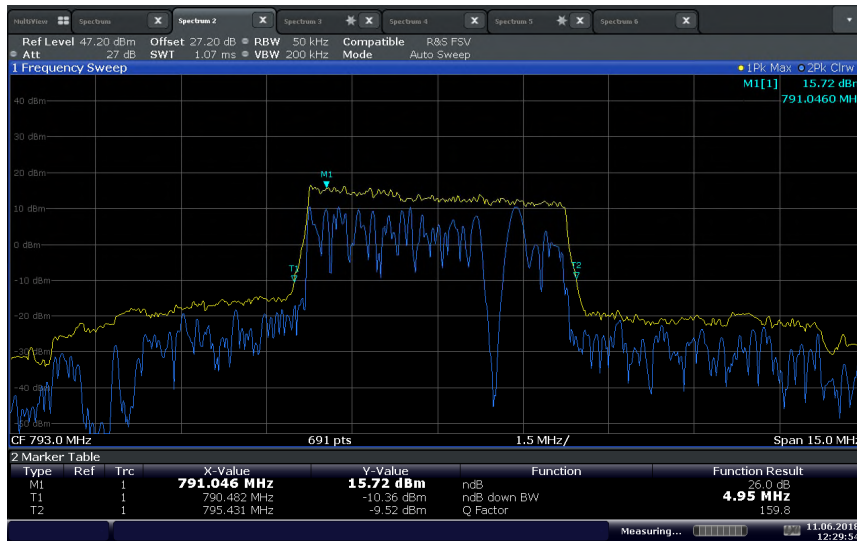

12:29:54 11.06.2018



LTE Band 14 (10 MHz BW) / Middle Channel 793.0 MHz / QPSK / 99%OBW

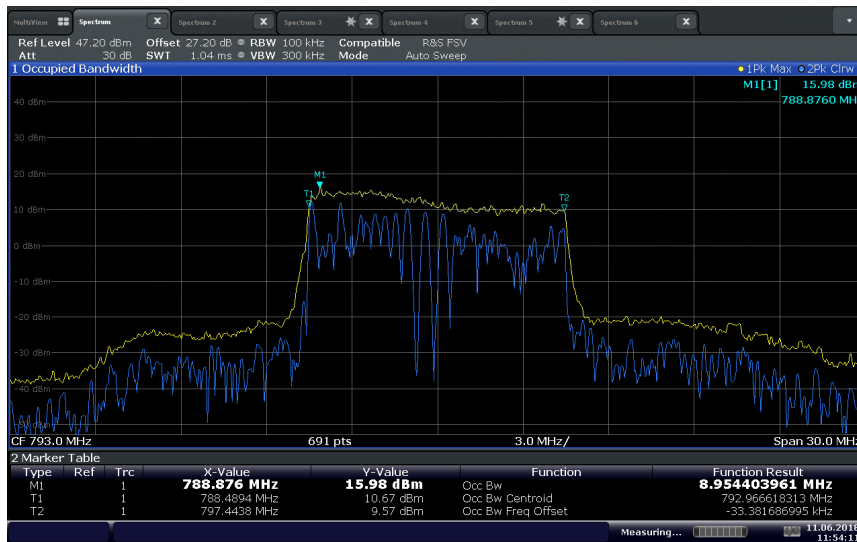

11:54:12 11.06.2018

LTE Band 14 (10 MHz BW) / Middle Channel 793.0 MHz / QPSK / 26dB BW



12:31:25 11.06.2018



2.4 PEAK-AVERAGE POWER RATIO

2.4.1 Specification Reference

RSS-140, Clause 4.3

2.4.2 Standard Applicable

RSS-140, Clause 4.3:

The equivalent radiated power (e.r.p.) for control and mobile equipment shall not exceed 30 W. The e.r.p. for portable equipment including handheld devices shall not exceed 3 W.

Fixed and base station equipment shall comply with the e.r.p limits in SRSP-540.

In addition, the peak-to-average power ratio (PAPR) of the equipment shall not exceed 13 dB for more than 0.1% of the time, using a signal that corresponds to the highest PAPR during periods of continuous transmission.

2.4.3 Equipment Under Test and Modification State

Serial No: AZ280418A00044 / Test Configuration A

2.4.4 Date of Test/Initial of test personnel who performed the test

June 13, 2018 / XYZ

2.4.5 Test Equipment Used

The major items of test equipment used for the above tests are identified in Section 3.1.

2.4.6 Environmental Conditions/ Test Location

Test performed at TÜV SÜD America Inc. Rancho Bernardo facility

Ambient Temperature	24.9 °C
Relative Humidity	54.2 %
ATM Pressure	98.5 kPa



2.4.7 Additional Observations

- This is a conducted test.
- As per FCC KDB 971168 D01 v03r01 clause 5.7, the PAPR was measured in accordance with ANSI C63.26 clause 5.2.3.4.
- Measurement was done using the Spectrum Analyzer’s Complementary Cumulative Distribution Function (CCDF) measurement profile. The built-in function is used to determine the largest deviation between the average and the peak power of the EUT in a given bandwidth (crest factor or peak-to-average ratio) A CCDF curve depicts the probability of the peak signal amplitude exceeding the average power level. Most contemporary measurement instrumentation include the capability to produce CCDF curves for an input signal provided that the instrument’s resolution bandwidth can be set wide enough to accommodate the entire input signal bandwidth.
- Low, Middle and High channels for all bandwidths and modulations were verified.
- The path loss for was measured and entered as a level offset.
- There are no measured PAR levels greater than 13dB.

2.4.8 Test Results

LTE Band 14					
Modulation	Bandwidth (MHz)	Channels	Frequency (MHz)	PAR (dB)	Limit for PAR (dB)
QPSK	5	23305	790.5	4.42	13
		23330	793	5.38	13
		23355	795.5	5.19	13
	10	-	-	-	13
		23330	793	5.37	13
		-	-	-	13
16QAM	5	23305	790.5	5.62	13
		23330	793	6.49	13
		23355	795.5	5.9	13
	10	-	-	-	13
		23330	793	6.66	13
		-	-	-	13



2.4.9 Example Test Plots

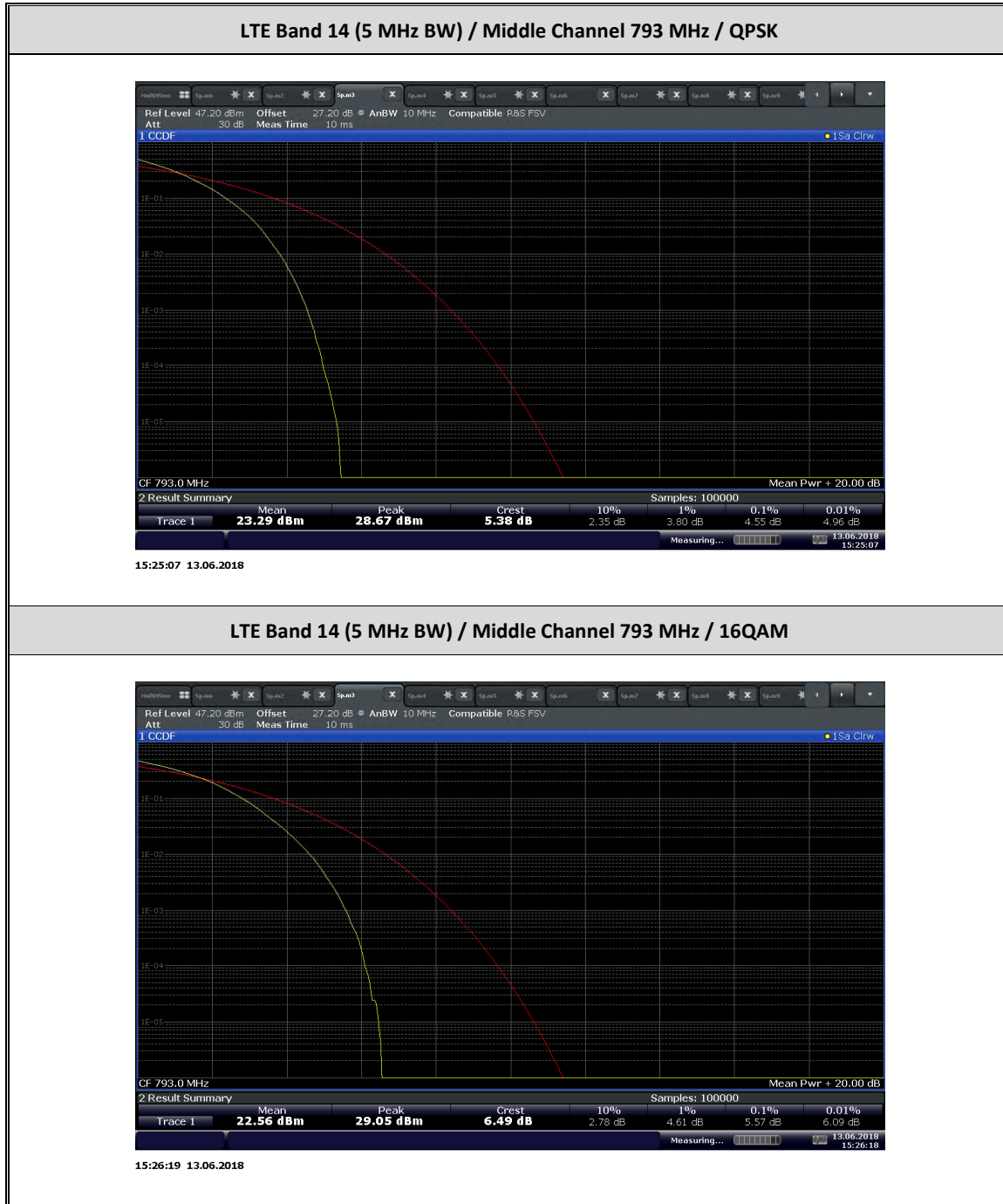



2.5 BAND EDGE

2.5.1 Specification Reference

FCC 47 CFR Part 2, Clause 2.1051
FCC 47 CFR Part 90, Clause 90.543 (e)(2)(3)(f)
RSS-140, Clause 6.6

2.5.2 Standard Applicable

FCC 47 CFR Part 90.543:

(e) For operations in the 758 – 768 MHz and the 788 – 798 MHz bands, the power of any emission outside the licensee's frequency band(s) of operation shall be attenuated below the transmitter power (P) within the licensed band(s) of operation, measured in watts, in accordance with the following:

- (1) On all frequencies between 769 – 775 MHz and 799 – 805 MHz, by a factor not less than $76 + 10 \log(P)$ dB in a 6.25 kHz band segment, for base and fixed stations.
- (2) On all frequency between 769 – 775 MHz and 799 – 805 MHz, by a factor not less than $65 + 10 \log(P)$ dB in a 6.25 kHz band segment, for mobile and portable stations.
- (3) On any frequency between 775 – 788 MHz, above 805 MHz, and below 758 MHz, by at least $43 + 10 \log(P)$ dB.

(f) For operations in the 758–775 MHz and 788–805 MHz bands, all emissions including harmonics in the band 1559–1610 MHz shall be limited to -70 dBW/MHz equivalent isotropically radiated power (EIRP) for wideband signals, and -80 dBW EIRP for discrete emissions of less than 700 Hz bandwidth. For the purpose of equipment authorization, a transmitter shall be tested with an antenna that is representative of the type that will be used with the equipment in normal operation.

RSS-140, Clause 4.4:

The power of any unwanted emission outside the bands 758-768 MHz band and the 788-798 MHz shall be attenuated below the transmitter output power P in dBw as follows, where p is the transmitter output power in watts:

- a) For any frequency between 769-775 MHz and 799-806 MHz:
 - ii) $65 + 10 \log(p)$, dB in a 6.25 kHz band for mobile and portable/hand-held equipment
- b) For any frequency between 775–788 MHz, above 806 MHz, and below 758 MHz:
 $43 + 10 \log(P)$, dB in a bandwidth of 100 kHz or greater. However, in the 100 kHz bands immediately outside and adjacent to the frequency bands 758-768 MHz and 788-798 MHz, a resolution bandwidth of 30 kHz may be employed.

In addition, the equivalent isotropically radiated power (e.i.r.p.) of all emissions, including harmonics in the band 1559-1610 MHz, shall not exceed -70 dBW/MHz for wideband emissions, and -80 dBW/kHz for discrete emissions of less than 700 Hz bandwidth.

2.5.3 Equipment Under Test and Modification State

Serial No: AZ280418A00044 / Test Configuration A

2.5.4 Date of Test/Initial of test personnel who performed the test

July 17, 2018 / XYZ



2.5.5 Test Equipment Used

The major items of test equipment used for the above tests are identified in Section 3.1.

2.5.6 Environmental Conditions/ Test Location

Test performed at TÜV SÜD America Inc. Rancho Bernardo facility

Ambient Temperature	24.9 °C
Relative Humidity	53.7 %
ATM Pressure	99.0 kPa

2.5.7 Additional Observations

- This is a conducted test.
- The path loss were measured and entered as a level offset.
- RBW is set to 30 kHz and VBW is set to 3 x RBW.
- All RB size available verified and only the worst case modulation (QPSK) for band edge verification presented in this test report.



2.5.8 Test Results

LTE Band 14 (5 MHz BW)/QPSK/Low Channel 790.5 MHz/Full RB Band Edge @788 MHz



11:15:38 17.07.2018

LTE Band 14 (5 MHz BW)/QPSK/High Channel 795.5 MHz/Full RB Band Edge @798 MHz



11:20:29 17.07.2018



LTE Band 14 (5 MHz BW)/QPSK/Low Channel 790.5 MHz/1 RB 0 offset Band Edge @777 MHz

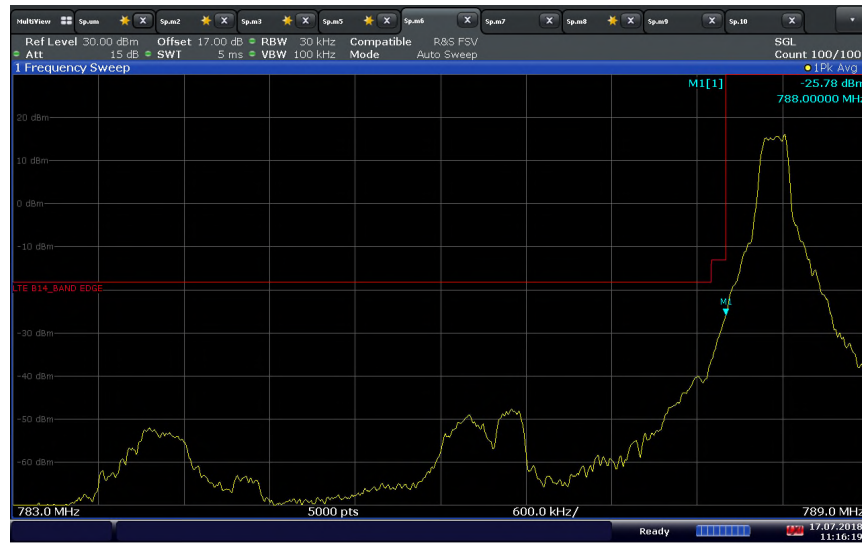

11:16:19 17.07.2018

LTE Band 14 (5 MHz BW)/QPSK/High Channel 795.5 MHz/1 RB 24 offset Band Edge @787 MHz



11:19:55 17.07.2018



LTE Band 14 (10 MHz BW)/QPSK/Middle Channel 793 MHz/1 RB 0 offset Low Band Edge @788 MHz

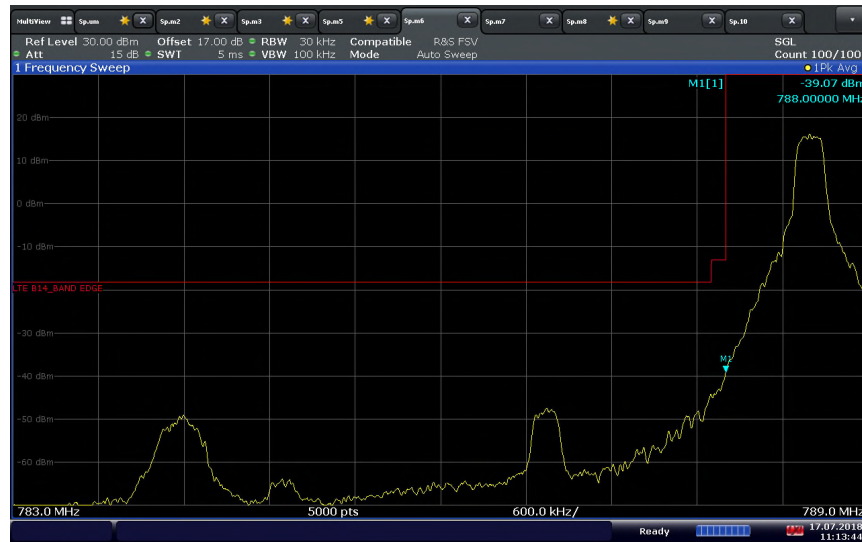

11:13:44 17.07.2018

LTE Band 14 (10 MHz BW)/QPSK/Middle Channel 793 MHz/1 RB 49 offset Low Band Edge @798 MHz



11:22:10 17.07.2018



2.6 CONDUCTED SPURIOUS EMISSIONS

2.6.1 Specification Reference

FCC 47 CFR Part 2, Clause 2.1051
FCC 47 CFR Part 90, Clause 90.543 (e)(2)(3)(f)
RSS-140, Clause 6.6

2.6.2 Standard Applicable

FCC 47 CFR Part 90.543:

(e) For operations in the 758 – 768 MHz and the 788 – 798 MHz bands, the power of any emission outside the licensee's frequency band(s) of operation shall be attenuated below the transmitter power (P) within the licensed band(s) of operation, measured in watts, in accordance with the following:

- (4) On all frequencies between 769 – 775 MHz and 799 – 805 MHz, by a factor not less than $76 + 10 \log(P)$ dB in a 6.25 kHz band segment, for base and fixed stations.
- (5) On all frequency between 769 – 775 MHz and 799 – 805 MHz, by a factor not less than $65 + 10 \log(P)$ dB in a 6.25 kHz band segment, for mobile and portable stations.
- (6) On any frequency between 775 – 788 MHz, above 805 MHz, and below 758 MHz, by at least $43 + 10 \log(P)$ dB.

(f) For operations in the 758–775 MHz and 788–805 MHz bands, all emissions including harmonics in the band 1559–1610 MHz shall be limited to -70 dBW/MHz equivalent isotropically radiated power (EIRP) for wideband signals, and -80 dBW EIRP for discrete emissions of less than 700 Hz bandwidth. For the purpose of equipment authorization, a transmitter shall be tested with an antenna that is representative of the type that will be used with the equipment in normal operation.

RSS-140, Clause 4.4:

The power of any unwanted emission outside the bands 758-768 MHz band and the 788-798 MHz shall be attenuated below the transmitter output power P in dBw as follows, where p is the transmitter output power in watts:

- c) For any frequency between 769-775 MHz and 799-806 MHz:
 - ii) $65 + 10 \log(p)$, dB in a 6.25 kHz band for mobile and portable/hand-held equipment
- d) For any frequency between 775–788 MHz, above 806 MHz, and below 758 MHz:
 $43 + 10 \log(P)$, dB in a bandwidth of 100 kHz or greater. However, in the 100 kHz bands immediately outside and adjacent to the frequency bands 758-768 MHz and 788-798 MHz, a resolution bandwidth of 30 kHz may be employed.

In addition, the equivalent isotropically radiated power (e.i.r.p.) of all emissions, including harmonics in the band 1559-1610 MHz, shall not exceed -70 dBW/MHz for wideband emissions, and -80 dBW/kHz for discrete emissions of less than 700 Hz bandwidth.

2.6.3 Equipment Under Test and Modification State

Serial No: AZ280418A00044 / Test Configuration A

2.6.4 Date of Test/Initial of test personnel who performed the test

June 23, 2018 / ZXY



2.6.5 Test Equipment Used

The major items of test equipment used for the above tests are identified in Section 3.1.

2.6.6 Environmental Conditions/ Test Location

Test performed at TÜV SÜD America Inc. Rancho Bernardo facility

Ambient Temperature 25.6 °C
Relative Humidity 51.6 %
ATM Pressure 98.6 kPa

2.6.7 Additional Observations

- This is a conducted test.
- The path loss was measured and entered as a transducer factor (TDF).
- The spectrum was searched from 30MHz to the 10th harmonic (10GHz).
- Low, Middle and High channels on all channel bandwidth and modulation are verified. Only the worst case channel of each band presented.

2.6.8 Test Results

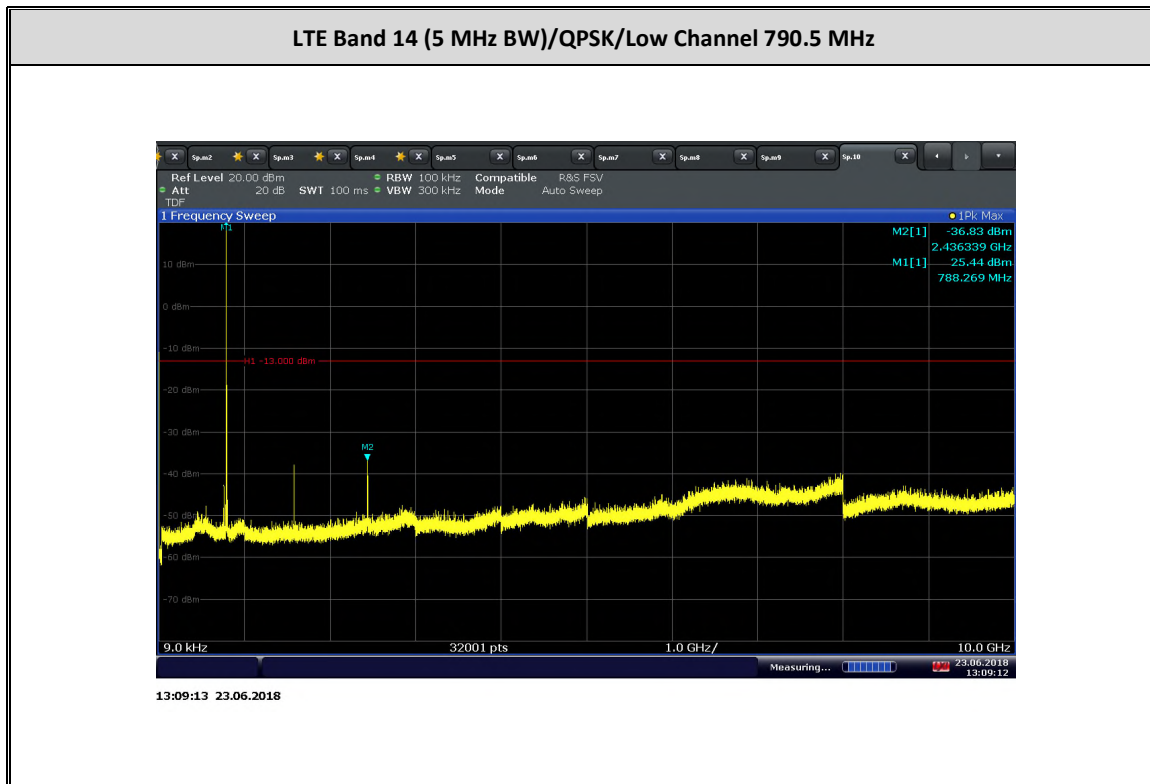



LTE Band 14 (5 MHz BW)/QPSK/Low Channel 790.5 MHz Conducted Spurious Emissions (769-775 MHz)

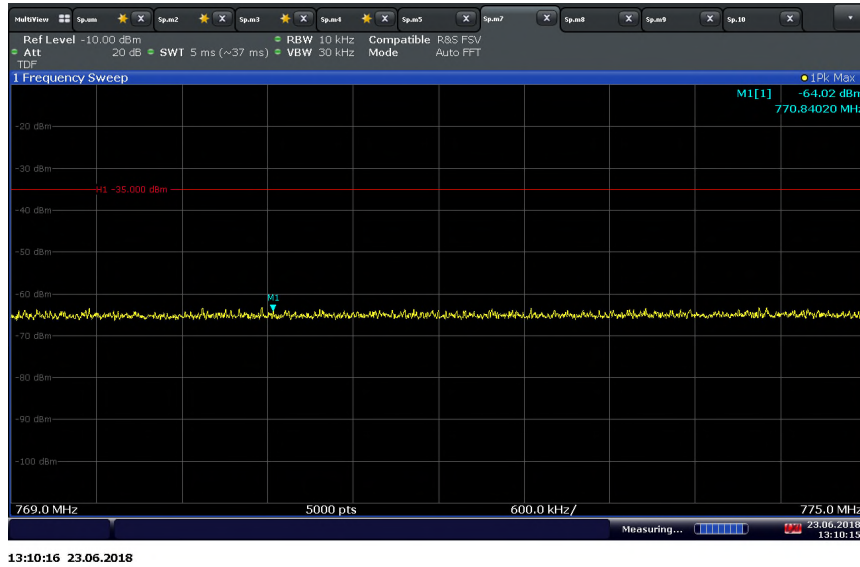

LTE Band 14 (5 MHz BW)/QPSK/Low Channel 790.5 MHz Conducted Spurious Emissions (799-806 MHz)

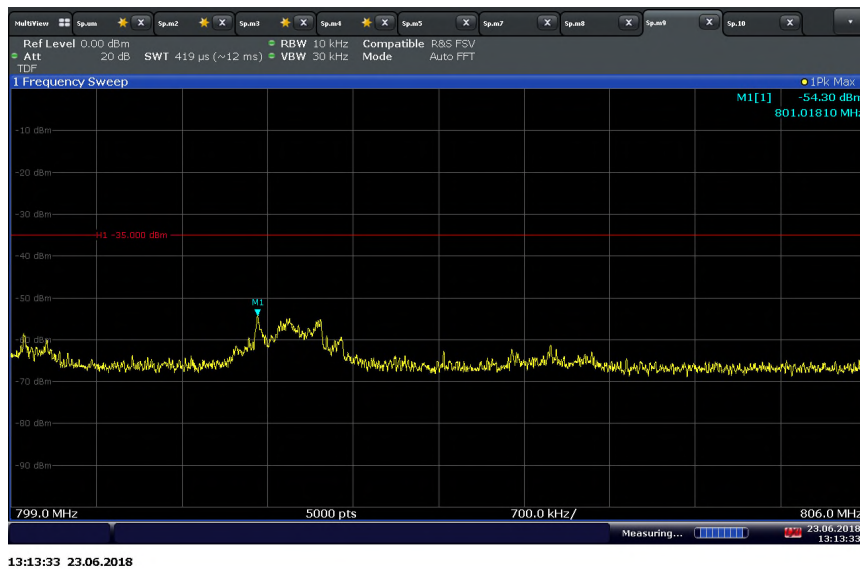



LTE Band 14 (5 MHz BW)/QPSK/Low Channel 790.5 MHz Conducted Spurious Emissions (1559-1610 MHz)

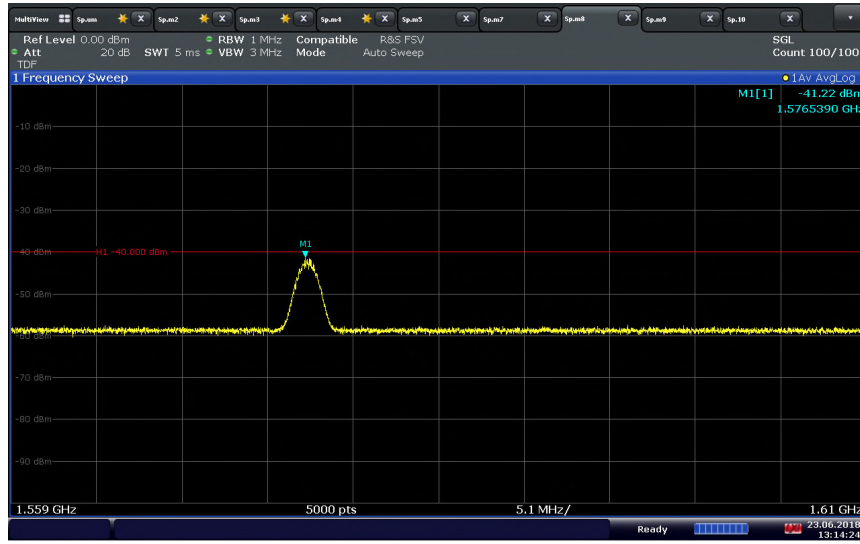

13:14:24 23.06.2018

LTE Band 14 (5 MHz BW)/QPSK/Middle Channel 793 MHz

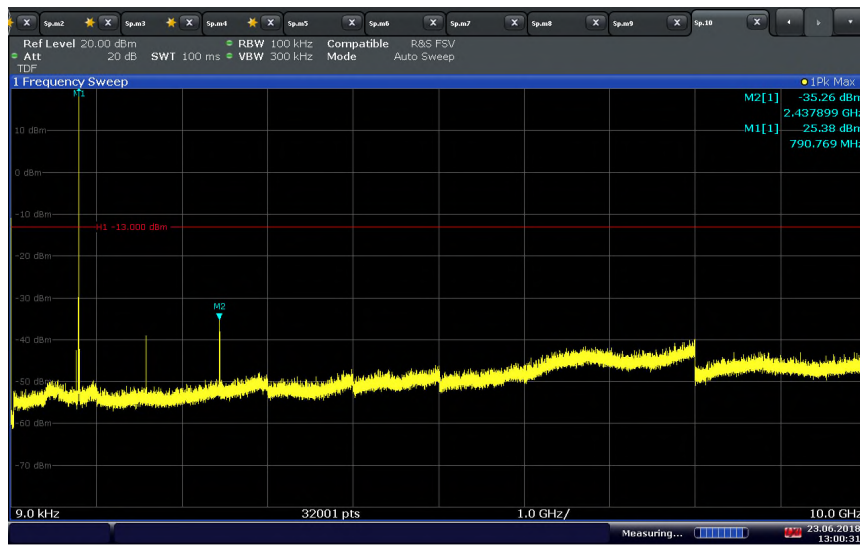

13:00:32 23.06.2018



LTE Band 14 (5 MHz BW)/QPSK/Middle Channel 793 MHz Conducted Spurious Emissions (769-775 MHz)

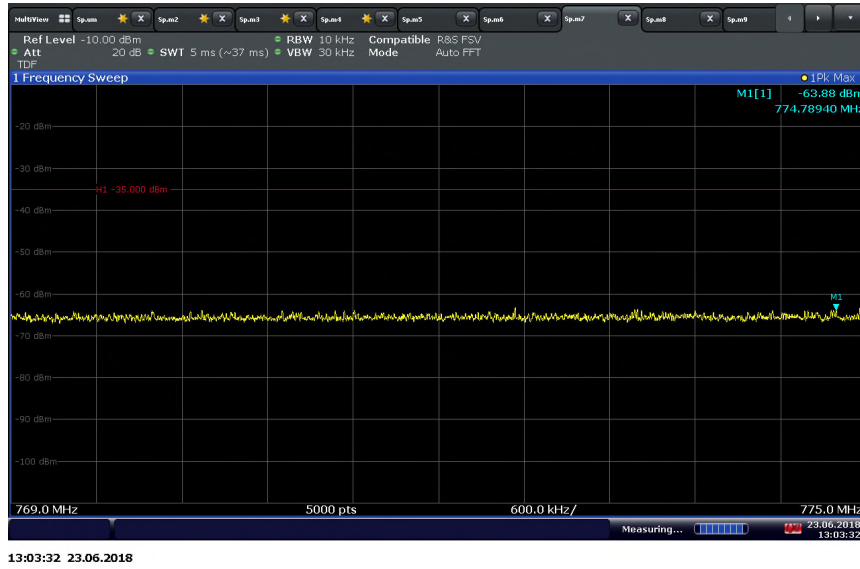

LTE Band 14 (5 MHz BW)/QPSK/Middle Channel 793 MHz Conducted Spurious Emissions (799-806 MHz)

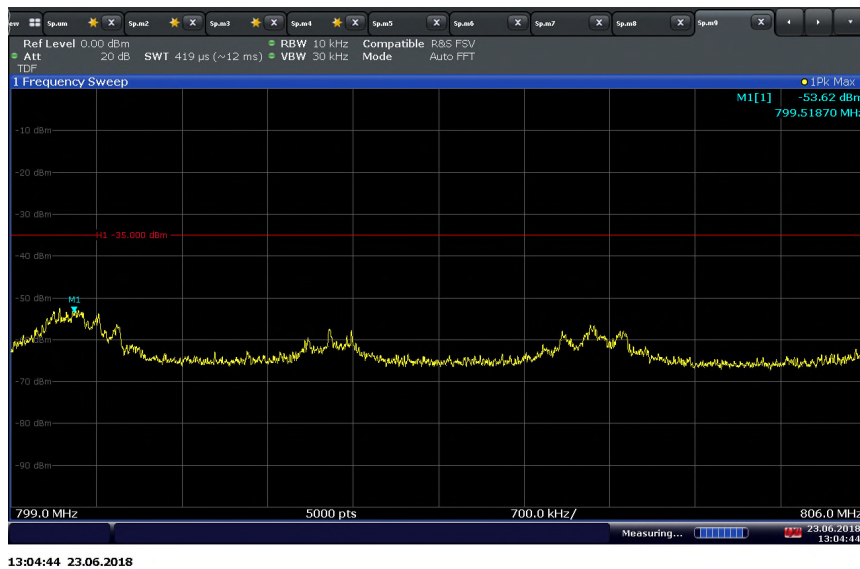

LTE Band 14 (5 MHz BW)/QPSK/Middle Channel 793 MHz Conducted Spurious Emissions (1559-1610 MHz)

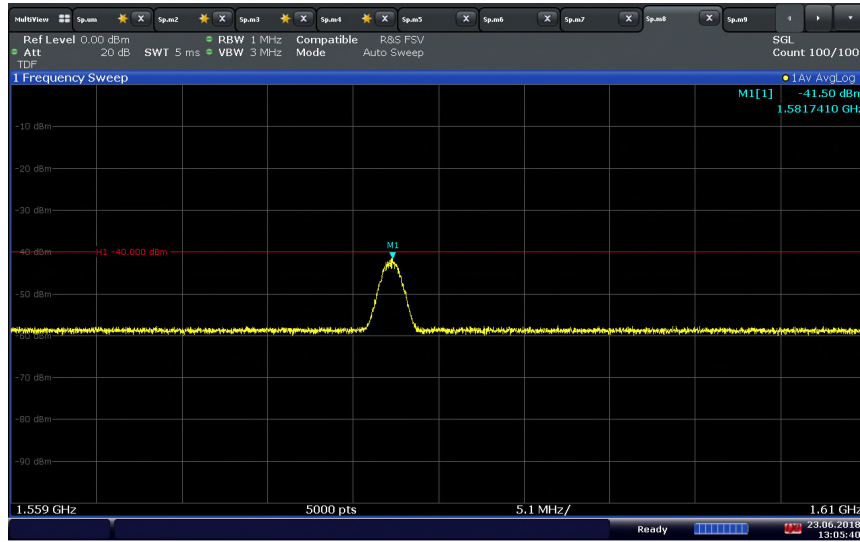

13:05:41 23.06.2018

LTE Band 14 (5 MHz BW)/QPSK/High Channel 795.5 MHz

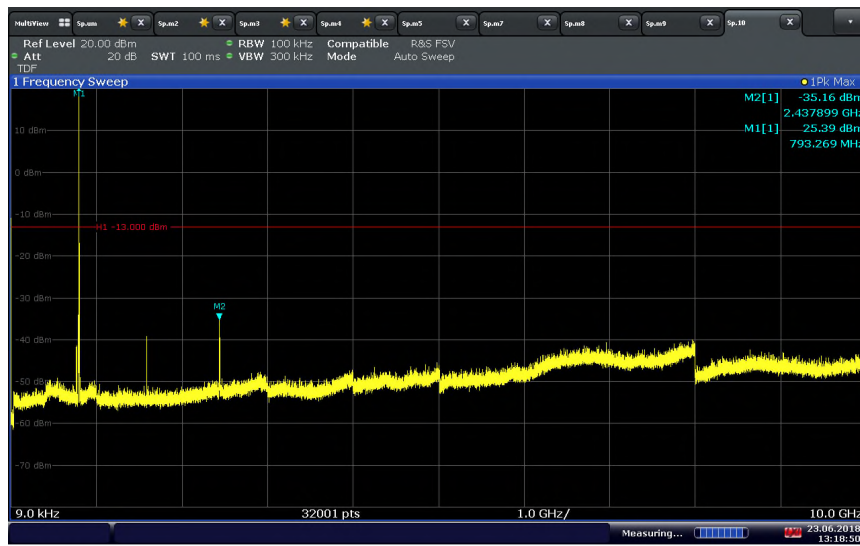

13:18:51 23.06.2018

LTE Band 14 (5 MHz BW)/QPSK/High Channel 795.5 MHz Conducted Spurious Emissions (769-775 MHz)

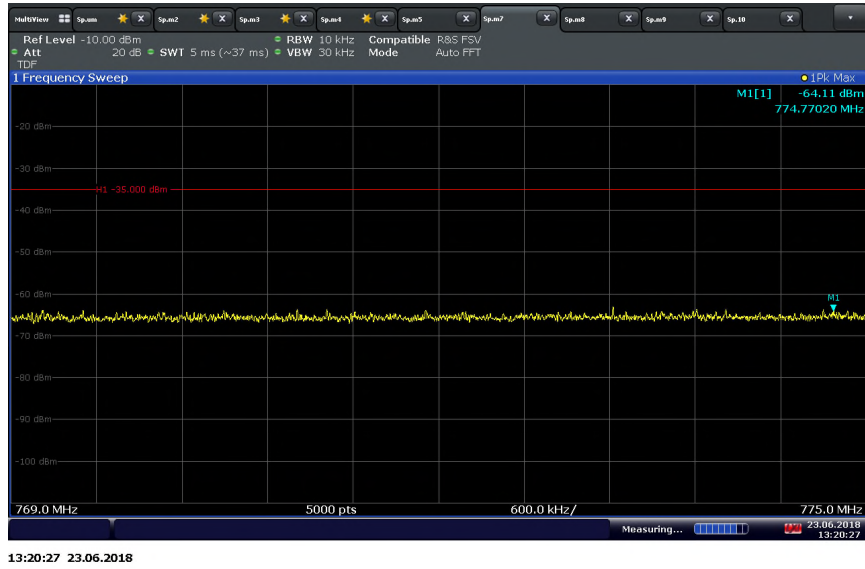

LTE Band 14 (5 MHz BW)/QPSK/High Channel 795.5 MHz Conducted Spurious Emissions (799-806 MHz)

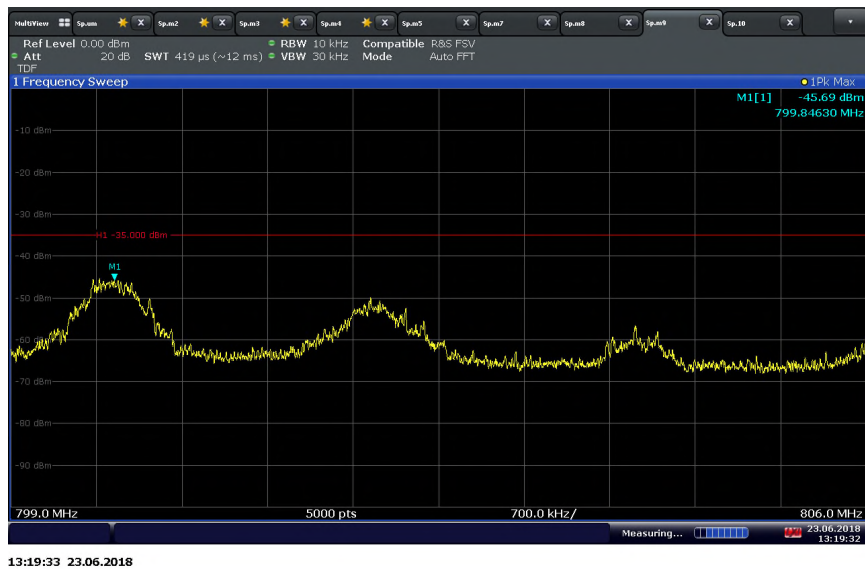

LTE Band 14 (5 MHz BW)/QPSK/High Channel 795.5 MHz Conducted Spurious Emissions (1559-1610 MHz)

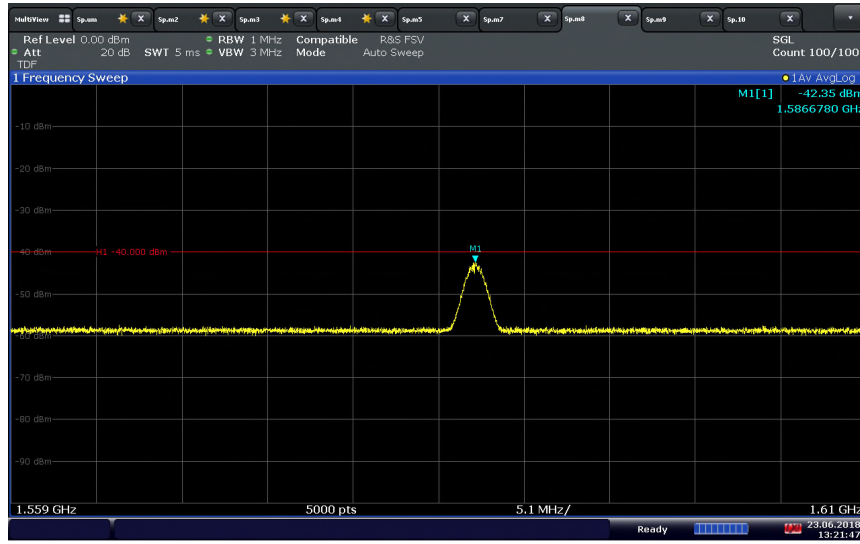

13:21:47 23.06.2018

LTE Band 14 (10 MHz BW)/QPSK/Middle Channel 793 MHz

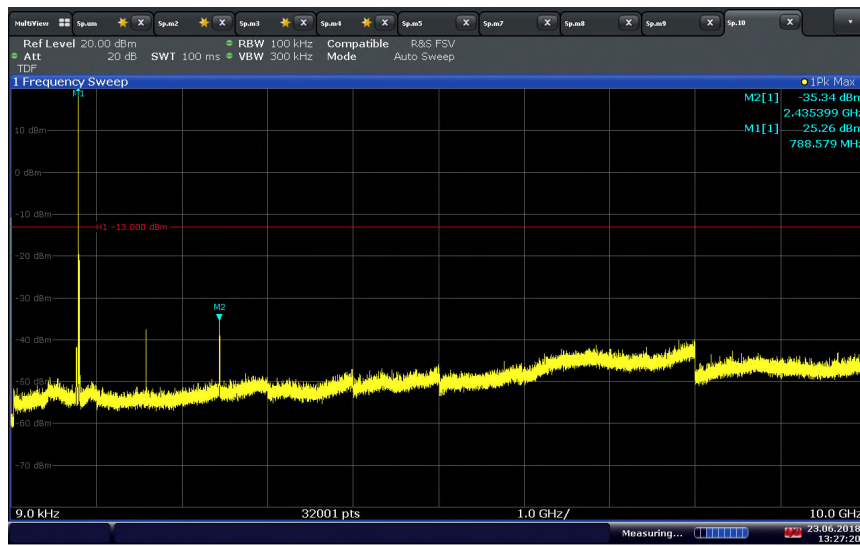

13:27:21 23.06.2018



LTE Band 14 (10 MHz BW)/QPSK/Middle Channel 793 MHz Conducted Spurious Emissions (769-775 MHz)

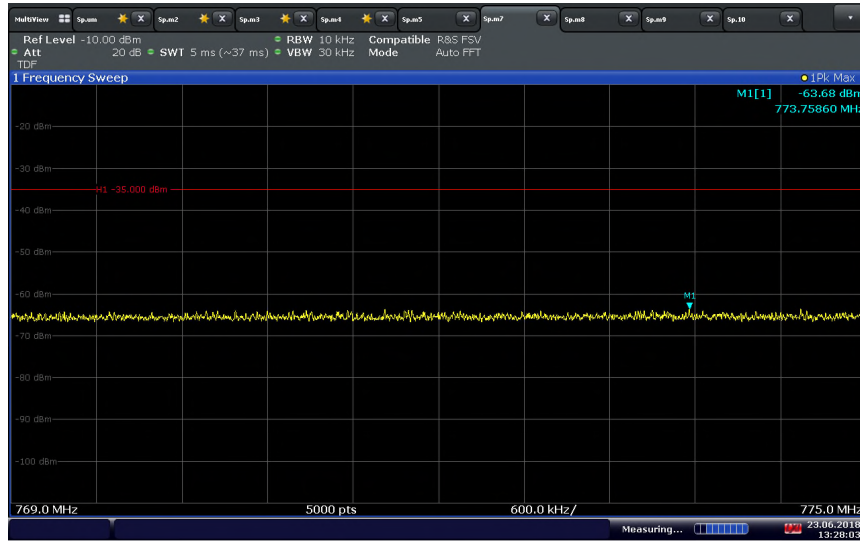

LTE Band 14 (10 MHz BW)/QPSK/Middle Channel 793 MHz Conducted Spurious Emissions (799-806 MHz)

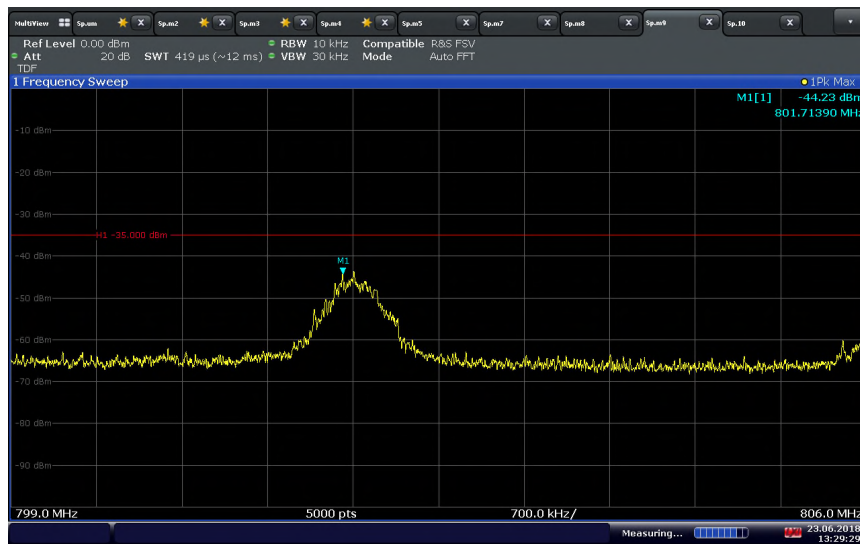

LTE Band 14 (10 MHz BW)/QPSK/Middle Channel 793 MHz Conducted Spurious Emissions (1559-1610 MHz)

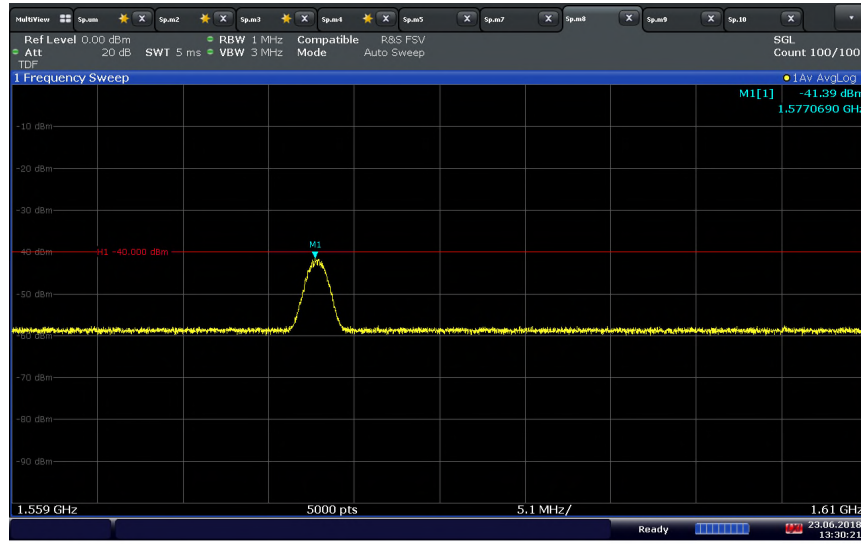

13:30:22 23.06.2018



2.7 FIELD STRENGTH OF SPURIOUS RADIATION

2.7.1 Specification Reference

FCC 47 CFR Part 2, Clause 2.1053
FCC 47 CFR Part 90, Clause 90.543(e)
RSS-140, Clause 4.4

2.7.2 Standard Applicable

FCC 47 CFR Part 90.543

(e) For operations in the 758 – 768 MHz and the 788 – 798 MHz bands, the power of any emission outside the licensee's frequency band(s) of operation shall be attenuated below the transmitter power (P) within the licensed band(s) of operation, measured in watts, in accordance with the following:

- (7) On all frequencies between 769 – 775 MHz and 799 – 805 MHz, by a factor not less than $76 + 10 \log(P)$ dB in a 6.25 kHz band segment, for base and fixed stations.
- (8) On all frequency between 769 – 775 MHz and 799 – 805 MHz, by a factor not less than $65 + 10 \log(P)$ dB in a 6.25 kHz band segment, for mobile and portable stations.
- (9) On any frequency between 775 – 788 MHz, above 805 MHz, and below 758 MHz, by at least $43 + 10 \log(P)$ dB.

RSS-140, Clause 4.4:

The power of any unwanted emission outside the bands 758 – 768 MHz and 788 – 798 MHz shall be attenuated below the transmitter output power P in dBW as follows, where p is the transmitter output power in watts:

- a) For any frequency between 769 – 775 MHz and 799 – 806 MHz:
 - i) $76 + 10 \log_{10} P$, dB in a 6.25 kHz band for fixed and base station equipment
 - ii) $65 + 10 \log_{10} P$, dB in a 6.25 kHz band for mobile and portable/hand-held equipment.
- b) For any frequency between 775 – 788 MHz, above 806 MHz, and below 758 MHz:
 $43 + 10 \log_{10}(P)$, dB in a bandwidth of 100 kHz or greater. However, in the 100 kHz bands immediately outside and adjacent to the frequency bands 758 – 768 MHz and 788 – 798 MHz, a resolution bandwidth of 30 kHz may be employed.

2.7.3 Equipment Under Test and Modification State

Serial No: AS190818B00021 / Test Configuration B

2.7.4 Date of Test/Initial of test personnel who performed the test

October 21 and 24, 2018 / XYZ

2.7.5 Test Equipment Used

The major items of test equipment used for the above tests are identified in Section 3.1.



2.7.6 Environmental Conditions/ Test Location

Test performed at TÜV SÜD America Inc. Rancho Bernardo facility

Ambient Temperature	23.4 - 23.5°C
Relative Humidity	32.3 - 59.0 %
ATM Pressure	98.8 kPa

2.7.7 Additional Observations

- This is a radiated test using substitution method as per Unwanted Emissions: Radiated Spurious method of measurement of ANSI/TIA/EIA-603-C 2004, August 17, 2004.
- Emissions within 6dB of the limit will be proven by substitution method.
- This is cabinet spurious emissions testing. Main antenna port was terminated during the test. Fundamental frequency measurement will be ignored for this test.
- Only the worst case configuration presented in this test report.
- There are no emissions found that doesn't comply with -13dBW limit in the 788-798 MHz frequency range. This limit corresponds to 84.4dB μ V/m @ 3 meters.
- Measurement was done using EMC32 V8.53 automated software. Reported level is the actual level with all the correction factors factored in. Correction Factor column is for informational purposes only.

2.7.8 Test Results

Compliant. See attached plots.



2.7.9 Radiated Emission Test Results Below 1GHz – Worst Case LTE Band 14_5MHz Bandwidth_Low Channel_1 RB 0 offset_QPSK

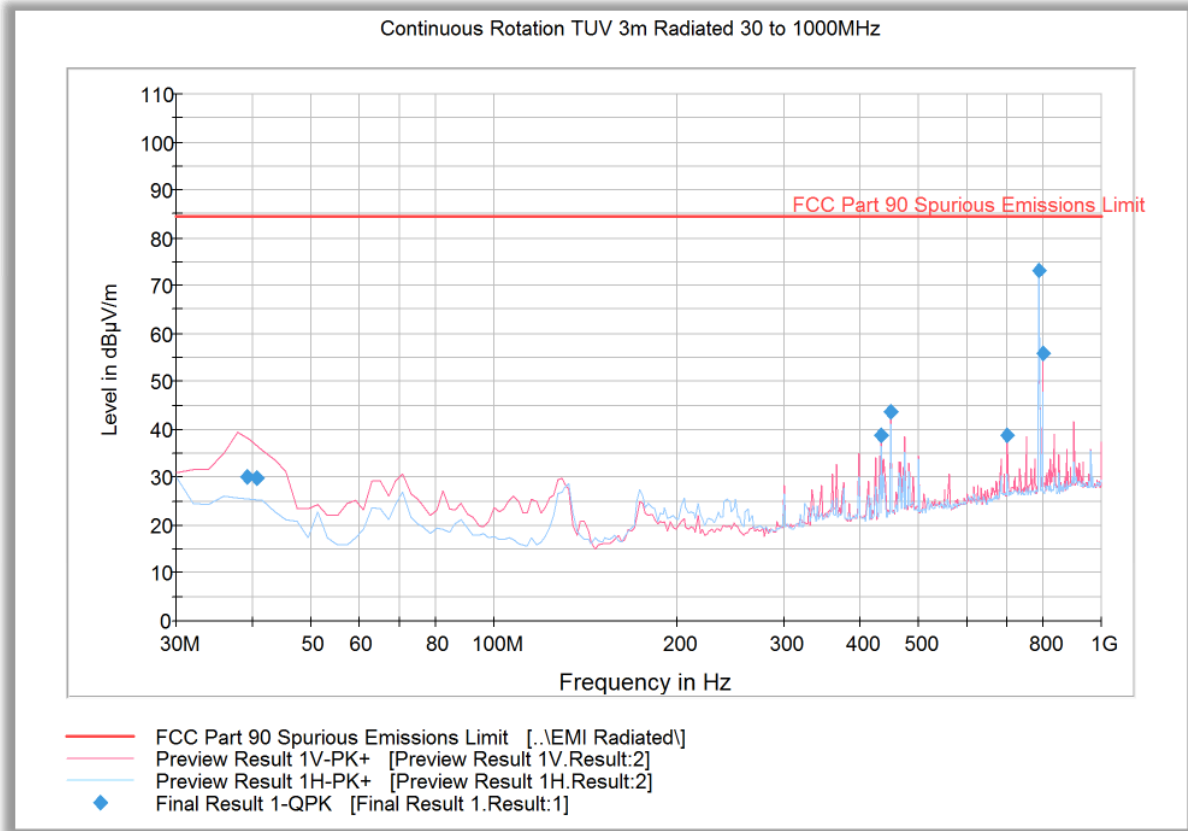

Quasi Peak Data

Frequency (MHz)	QuasiPeak (dBµV/m)	Meas. Time (ms)	Bandwidth (kHz)	Height (cm)	Polarization	Azimuth (deg)	Corr. (dB)	Margin (dB)	Limit (dBµV/m)
39.295551	30.0	1000.0	120.000	100.0	V	302.0	-11.7	54.4	84.4
40.727214	30.0	1000.0	120.000	100.0	V	245.0	-12.2	54.4	84.4
433.328657	38.9	1000.0	120.000	195.0	V	112.0	-3.9	45.5	84.4
449.999760	43.8	1000.0	120.000	170.0	V	131.0	-3.1	40.6	84.4
700.001283	38.7	1000.0	120.000	100.0	V	104.0	2.6	45.7	84.4
788.300120	73.3	1000.0	120.000	100.0	H	0.0	3.5	Fundamental Carrier*	
800.003447	56.0	1000.0	120.000	100.0	V	172.0	3.6	28.4	84.4

* This is the fundamental frequency not part of spurious emission evaluation. Data provided for information purpose only.



2.7.10 Radiated Emission Test Results Above 1GHz – Worst Case LTE Band 14_5MHz Bandwidth_Low Channel_1 RB 0 offset_QPSK

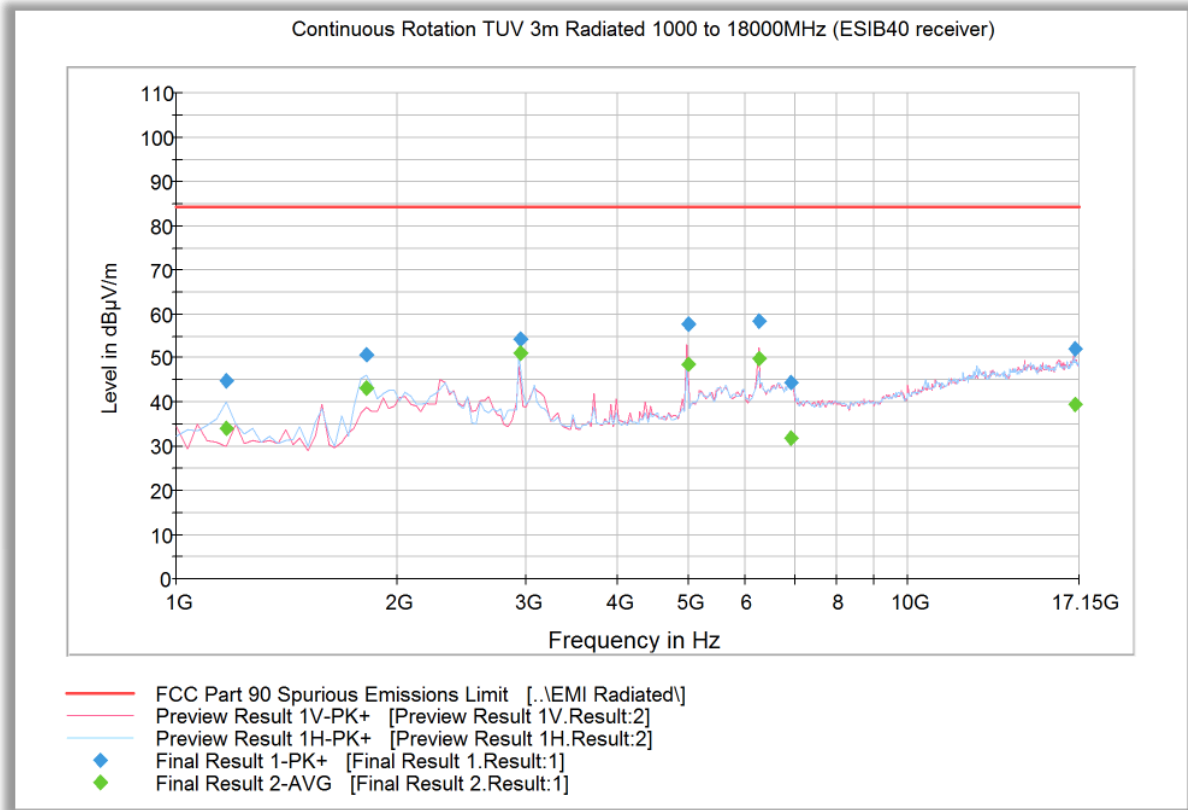

Peak Data

Frequency (MHz)	MaxPeak (dBµV/m)	Meas. Time (ms)	Bandwidth (kHz)	Height (cm)	Polarization	Azimuth (deg)	Corr. (dB)	Margin (dB)	Limit (dBµV/m)
1171.740681	44.7	1000.0	1000.000	103.7	H	285.0	-6.7	39.7	84.4
1816.635271	50.9	1000.0	1000.000	125.7	H	219.0	-3.2	33.5	84.4
2949.283768	54.1	1000.0	1000.000	117.7	H	241.0	0.3	30.3	84.4
4999.771944	57.7	1000.0	1000.000	241.3	V	240.0	3.7	26.7	84.4
6249.892986	58.2	1000.0	1000.000	293.2	V	285.0	5.8	26.2	84.4
6923.255711	44.4	1000.0	1000.000	184.5	V	121.0	6.3	40.0	84.4
16920.019639	52.0	1000.0	1000.000	250.5	H	219.0	17.9	32.4	84.4

Average Data

Frequency (MHz)	Average (dBµV/m)	Meas. Time (ms)	Bandwidth (kHz)	Height (cm)	Polarization	Azimuth (deg)	Corr. (dB)	Margin (dB)	Limit (dBµV/m)
1171.740681	34.2	1000.0	1000.000	103.7	H	285.0	-6.7	50.2	84.4
1816.635271	43.3	1000.0	1000.000	125.7	H	219.0	-3.2	41.1	84.4
2949.283768	51.0	1000.0	1000.000	117.7	H	241.0	0.3	33.4	84.4
4999.771944	48.6	1000.0	1000.000	241.3	V	240.0	3.7	35.8	84.4
6249.892986	49.7	1000.0	1000.000	293.2	V	285.0	5.8	34.7	84.4
6923.255711	32.1	1000.0	1000.000	184.5	V	121.0	6.3	52.3	84.4
16920.019639	39.3	1000.0	1000.000	250.5	H	219.0	17.9	45.1	84.4



2.7.11 Radiated Emission Test Results Above 1GHz – Worst Case LTE Band 14_5MHz Bandwidth_Middle Channel_1 RB 0 offset_QPSK

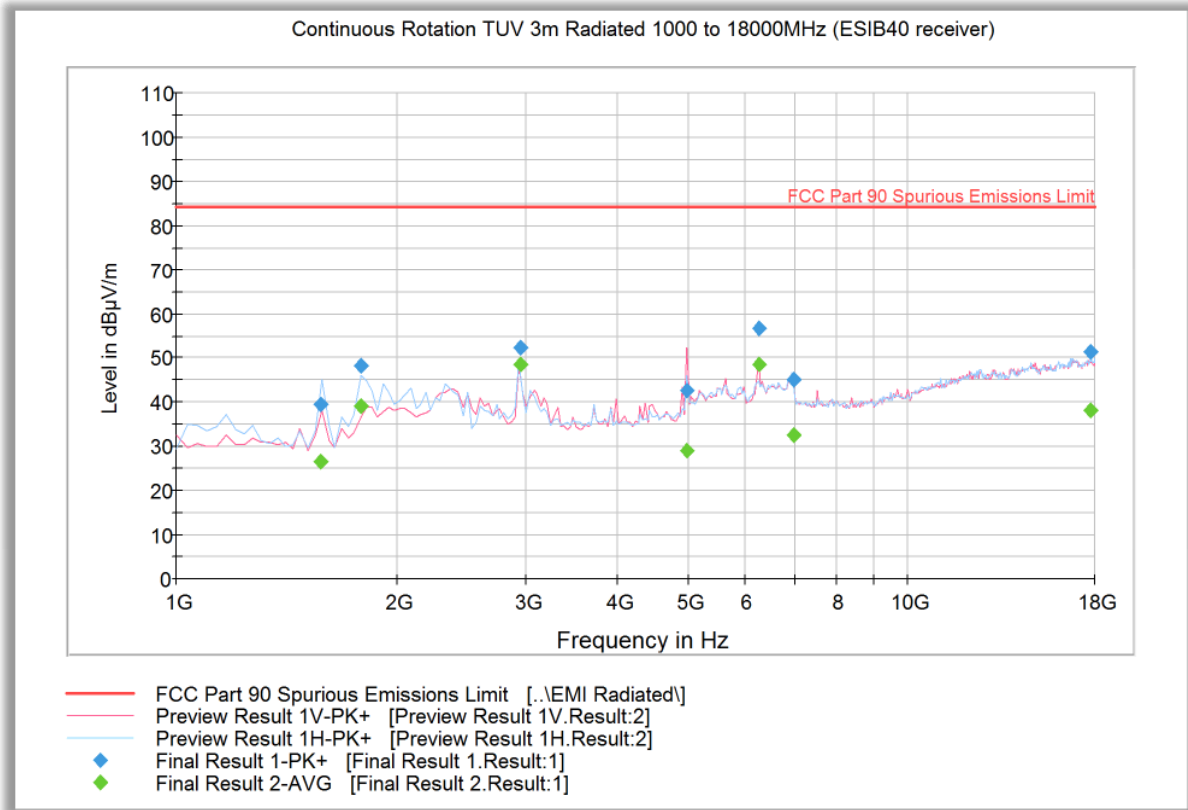

Peak Data

Frequency (MHz)	MaxPeak (dBµV/m)	Meas. Time (ms)	Bandwidth (kHz)	Height (cm)	Polarization	Azimuth (deg)	Corr. (dB)	Margin (dB)	Limit (dBµV/m)
1577.358317	39.6	1000.0	1000.000	252.3	H	125.0	-5.8	44.8	84.4
1790.567134	48.2	1000.0	1000.000	133.7	H	219.0	-3.6	36.2	84.4
2949.283768	52.5	1000.0	1000.000	152.2	H	239.0	0.3	31.9	84.4
4986.171944	42.7	1000.0	1000.000	250.5	V	241.0	3.6	41.7	84.4
6249.892986	56.6	1000.0	1000.000	221.4	V	241.0	5.8	27.8	84.4
6965.323848	45.2	1000.0	1000.000	152.2	H	291.0	6.3	39.2	84.4
17796.191182	51.3	1000.0	1000.000	233.4	H	264.0	17.7	33.1	84.4

Average Data

Frequency (MHz)	Average (dBµV/m)	Meas. Time (ms)	Bandwidth (kHz)	Height (cm)	Polarization	Azimuth (deg)	Corr. (dB)	Margin (dB)	Limit (dBµV/m)
1577.358317	26.6	1000.0	1000.000	252.3	H	125.0	-5.8	57.8	84.4
1790.567134	39.2	1000.0	1000.000	133.7	H	219.0	-3.6	45.2	84.4
2949.283768	48.5	1000.0	1000.000	152.2	H	239.0	0.3	35.9	84.4
4986.171944	29.3	1000.0	1000.000	250.5	V	241.0	3.6	55.1	84.4
6249.892986	48.6	1000.0	1000.000	221.4	V	241.0	5.8	35.9	84.4
6965.323848	32.5	1000.0	1000.000	152.2	H	291.0	6.3	51.9	84.4
17796.191182	38.4	1000.0	1000.000	233.4	H	264.0	17.7	46.0	84.4



2.7.12 Radiated Emission Test Results Above 1GHz – Worst Case LTE Band 14_5MHz Bandwidth_High Channel_1 RB 0 offset_QPSK

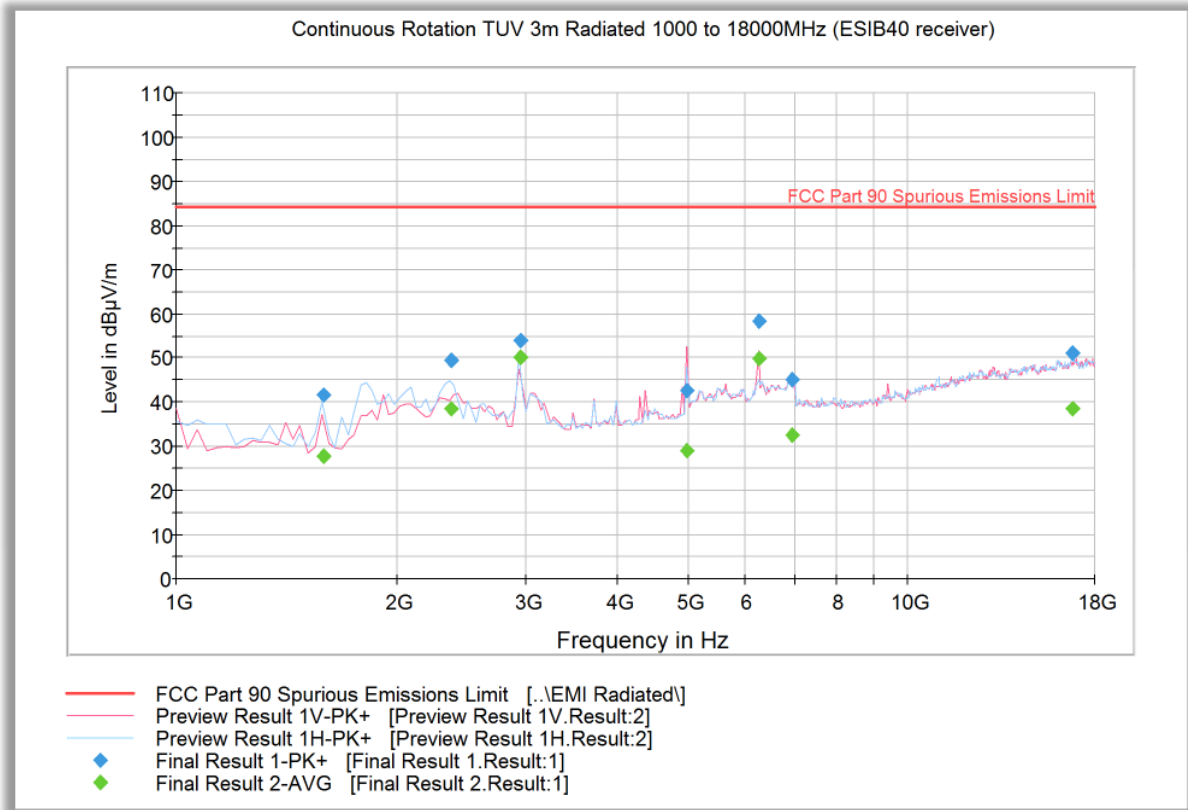

Peak Data

Frequency (MHz)	MaxPeak (dBµV/m)	Meas. Time (ms)	Bandwidth (kHz)	Height (cm)	Polarization	Azimuth (deg)	Corr. (dB)	Margin (dB)	Limit (dBµV/m)
1586.958317	41.7	1000.0	1000.000	212.4	H	171.0	-5.8	42.7	84.4
2370.125451	49.7	1000.0	1000.000	125.7	H	219.0	-1.0	34.7	84.4
2949.283768	53.9	1000.0	1000.000	133.7	H	241.0	0.3	30.5	84.4
4978.971944	42.6	1000.0	1000.000	231.3	V	241.0	3.6	41.8	84.4
6249.892986	58.3	1000.0	1000.000	293.2	V	283.0	5.8	26.1	84.4
6952.123848	45.2	1000.0	1000.000	338.1	V	348.0	6.3	39.2	84.4
16782.947094	51.2	1000.0	1000.000	184.5	H	243.0	17.8	33.2	84.4

Average Data

Frequency (MHz)	Average (dBµV/m)	Meas. Time (ms)	Bandwidth (kHz)	Height (cm)	Polarization	Azimuth (deg)	Corr. (dB)	Margin (dB)	Limit (dBµV/m)
1586.958317	27.9	1000.0	1000.000	212.4	H	171.0	-5.8	56.5	84.4
2370.125451	38.7	1000.0	1000.000	125.7	H	219.0	-1.0	45.7	84.4
2949.283768	50.1	1000.0	1000.000	133.7	H	241.0	0.3	34.3	84.4
4978.971944	29.2	1000.0	1000.000	231.3	V	241.0	3.6	55.2	84.4
6249.892986	49.8	1000.0	1000.000	293.2	V	283.0	5.8	34.6	84.4
6952.123848	32.7	1000.0	1000.000	338.1	V	348.0	6.3	51.7	84.4
16782.947094	38.5	1000.0	1000.000	184.5	H	243.0	17.8	45.9	84.4



2.8 FREQUENCY STABILITY

2.8.1 Specification Reference

FCC 47 CFR Part 2, Clause 2.1055
FCC 47 CFR Part 90, Clause 90.539
RSS-140, Clause 4.2

2.8.2 Standard Applicable

FCC Part 90, Clause 90.539:

(e) The frequency stability of mobile, portable, and control transmitters operating in the wideband segment must be 1.25 parts per million or better when AFC is locked to a ase staion, and 5 parts per million or better when AFC is not locked.

RSS-140, Clause 4.2:

The frequency stability shall be sufficient to ensure that the fundamental emissions stay within the operating frequency block when tested to the temperature and supply voltage variations specified in RSS-Gen.

2.8.3 Equipment Under Test and Modification State

Serial No: AZ280418A00044 / Test Configuration A

2.8.4 Date of Test/Initial of test personnel who performed the test

July 3, and 11, 2018 / XYZ

2.8.5 Test Equipment Used

The major items of test equipment used for the above tests are identified in Section 3.1.

2.8.6 Environmental Conditions/ Test Location

Test performed at TÜV SÜD America Inc. Rancho Bernardo facility

Ambient Temperature	25.7 - 26.8°C
Relative Humidity	44.4 - 54.1%
ATM Pressure	98.7 - 99.0 kPa



2.8.7 Additional Observations

- This is a conducted test. The EUT was operated at 3.7VDC nominal voltage and was placed in the temperature chamber for this evaluation. The EUT was controlled by a CMW500 and utilizing a spectrum analyzer for measurement.
- Test performed in 5 MHz Bandwidth Middle channel as the representative configuration.
- Measurement was done using the CMW 500 measurement function.
- The EUT was tested over the temperature -30°C to +50°C in 10°C steps and allowed to sit for 1 hour to allow the equipment and chamber temperature to stabilize. The measurements were then performed.
- Voltage variation was also performed at voltage 3.3VDC and higher 4.3VDC of the nominal voltage at 20°C.

2.8.8 Test Results

LTE Band 14 – QPSK 5 MHz BW-Middle Channel 793 MHz				
Voltage (VDC)	Temperature (°C)	Frequency Error (Hz)	Frequency Error (ppm)	Limit (ppm)
3.7	-30	-11.09	-0.014	± 1.25
	-20	8.71	0.011	± 1.25
	-10	11.72	0.015	± 1.25
	0	8.64	0.011	± 1.25
	+10	-6.59	-0.008	± 1.25
	+20	-6.07	-0.008	± 1.25
	+30	7.62	0.010	± 1.25
	+40	7.4	0.009	± 1.25
	+50	8.44	0.011	± 1.25
3.3	20	-8.37	-0.011	± 1.25
4.3		-6.84	-0.009	± 1.25

The frequency stability of the EUT is sufficient to keep it within the authorised frequency ranges at any temperature interval and voltage variations across the measured range.



2.8.9 Sample Test plot

CMW 500 V3.7.22 - LTE Measurement - V3.7.30 - TX Measurement

Multi Evaluation PRACH SRS

FDD Freq: 793.0 MHz Ref. Level: 41.00 dBm BW: 5.0 MHz CP: Normal Meas Subfr./Slot: 0 / All

TX Measurement

Detected Allocation	NoRB:		25OffsetRB:		0			
	Current	Average	Extreme	StdDev				
EVM RMS [%] I/h	3.52	3.66	3.70	3.86	3.91	4.09	0.19	0.21
EVM Peak [%] I/h	21.52	21.85	22.02	24.77	23.64	28.32	0.78	2.54
EVM DMRS [%] I/h	2.24	2.26	2.45	2.49	2.71	2.79	0.19	0.20
MErr RMS [%] I/h	3.04	3.17	3.23	3.38	3.44	3.62	0.19	0.21
MErr Peak [%] I/h	-21.41	-21.84	21.79	24.71	-23.22	-28.31	0.70	2.56
MErr DMRS [%] I/h	1.80	1.82	1.97	2.00	2.19	2.22	0.14	0.16
PhErr RMS [°] I/h	1.03	1.07	1.05	1.09	1.09	1.13	0.02	0.03
PhErr Peak [°] I/h	4.85	7.21	5.03	8.11	6.00	-10.40	0.25	1.53
PhErr DMRS [°] I/h	0.75	0.76	0.83	0.85	0.97	0.98	0.07	0.07
IQ Offset [dBc]		-48.19		-49.75		-47.36		1.68
IQ Gain Imbalance [dB]		-0.10		-0.12		-0.15		0.02
IQ Quadrature Error [°]		-0.01		0.08		0.21		0.08
Freq Error [Hz]		-1.70		0.51		-6.07		1.70
Timing Error [Ts]		3.01		3.03		7.41		0.18
OBW [MHz]		4.43		4.43		4.43		0.00
		Current		Average		Min		Max
TX Power [dBm]		22.34		22.30		22.06		22.47
Peak Power [dBm]		26.87		27.07		26.65		28.18
StdDev								0.20

Statistic Count: 20 / 20 Out of Tolerance: 0.00 % Detected Modulation: QPSK Detected Channel Type: PUSCH View Filter Throughput: 100.0 %

PS: Connection Established RRC State: Connected

Repetition ... Stop Condition ... Statistic Count ... Channel Bandwidth ... Measurement Subframes ... Assign Views Config ...

LTE Band 14_5 MHz Bandwidth_Middle Channel @20°C



SECTION 3

TEST EQUIPMENT USED



3.1 TEST EQUIPMENT USED

List of absolute measuring and other principal items of test equipment.

ID Number (SDGE/SDRB)	Test Equipment	Type	Serial Number	Manufacturer	Cal Date	Cal Due Date
Antenna Conducted Port Setup						
7662	P-Series Power Meter	N1911A	MY45100951	Agilent	06/15/18	06/15/19
7661	50MHz-18GHz Wideband Power Sensor	N1921A	MY45241383	Agilent	06/15/18	06/15/19
7608	Vector Signal Generator	SMBV100A	259021	Rhode & Schwarz	09/19/17	09/19/19
7582	Signal/Spectrum Analyzer	FSW26	101614	Rhode & Schwarz	12/14/17	12/14/18
-	Wideband Radio Communication Tester	CMW 500	158164	Rhode & Schwarz	04/04/18	04/04/19
8825	20dB Attenuator	46-20-34	BK5773	Weinschel Corp.	Verified by 7608 and 7582	
-	10dB Attenuator	VAT-10W2+2W	N/A	MCL	Verified by 7608 and 7582	
Radiated Test Setup						
7582	Signal/Spectrum Analyzer	FSW26	101614	Rhode & Schwarz	12/14/17	12/14/18
7608	Vector Signal Generator	SMBV100A	259021	Rhode & Schwarz	09/19/17	09/19/19
1002	Bilog Antenna	3142C	00058717	EMCO	11/20/17	11/20/18
7575	Double-ridged waveguide horn antenna	3117	00155511	EMCO	06/16/18	06/16/20
1193	Pre-amplifier	PAM-0202	185	A.H. Systems, Inc.	04/11/18	04/11/19
8921	High-frequency cable	SucoFlex 100 SX	N/A	Suhner	Verified by 7608 and 7582	
8923	High-frequency cable	Micropore 19057793	N/A	United Microwave Products	Verified by 7608 and 7582	
1040	EMI Test Receiver	ESIB40	100292	Rhode & Schwarz	10/15/18	10/15/19
8628	Pre-amplifier	QLI-01182835-JO	8986002	Quinstar	02/06/18	02/06/19
-	UXM Wireless Set	E7515A	MY56180375	Keysight	For signalling only	
-	Wideband Radio Communication Tester	CMW 500	158164	Rhode & Schwarz	For signalling only	
Miscellaneous						
6708	Multimeter	34401A	US36086974	Hewlett Packard	07/18/18	07/18/19
7579	Temperature Chamber	115	151617	TestQuity	08/24/18	08/24/19
11312	Mini Environmental Quality Meter	850027	CF099-56010-340	Sper Scientific	02/26/18	02/26/19
	Test Software	EMC32	V8.53	Rhode & Schwarz	N/A	



3.2 MEASUREMENT UNCERTAINTY

For a 95% confidence level, the measurement uncertainties for defined systems are:

3.2.1 Conducted Antenna Port Measurement

	Input Quantity (Contribution) X_i	Value	Prob. Dist.	Divisor	$u_i(x)$	$u_i(x)^2$
1	Receiver reading	0.10 dB	Normal, k=1	1.000	0.10	0.01
2	Cable attenuation	1.00 dB	Normal, k=2	2.000	0.50	0.25
3	Receiver sinewave accuracy	0.08 dB	Normal, k=2	2.000	0.04	0.00
4	Receiver pulse amplitude	0.00 dB	Rectangular	1.732	0.00	0.00
5	Receiver pulse repetition rate	0.00 dB	Rectangular	1.732	0.00	0.00
6	Noise floor proximity	0.00 dB	Rectangular	1.732	0.00	0.00
7	Frequency interpolation	0.10 dB	Rectangular	1.732	0.06	0.00
8	Mismatch	0.07 dB	U-shaped	1.414	0.05	0.00
Combined standard uncertainty			Normal		0.52 dB	
Expanded uncertainty			Normal, k=2		1.03 dB	

3.2.2 Radiated Emission Measurements (Below 1GHz)

	Input Quantity (Contribution) X_i	Value	Prob. Dist.	Divisor	$u_i(x)$	$u_i(x)^2$
1	Receiver reading	0.10 dB	Normal, k=1	1.000	0.10	0.01
2	Attenuation: antenna-receiver	0.20 dB	Normal, k=2	2.000	0.10	0.01
3	Antenna factor AF	0.75 dB	Normal, k=2	2.000	0.38	0.14
4	Receiver sinewave accuracy	0.45 dB	Normal, k=2	2.000	0.23	0.05
5	Receiver pulse amplitude	1.50 dB	Rectangular	1.732	0.87	0.75
6	Receiver pulse repetition rate	1.50 dB	Rectangular	1.732	0.87	0.75
7	Noise floor proximity	0.50 dB	Rectangular	1.732	0.29	0.08
8	Mismatch: antenna-receiver	0.95 dB	U-shaped	1.414	0.67	0.45
9	AF frequency interpolation	0.30 dB	Rectangular	1.732	0.17	0.03
10	AF height deviations	0.10 dB	Rectangular	1.732	0.06	0.00
11	Directivity difference at 3 m	3.12 dB	Rectangular	1.732	1.80	3.24
12	Phase center location at 3 m	1.00 dB	Rectangular	1.732	0.58	0.33
13	Cross-polarisation	0.90 dB	Rectangular	1.732	0.52	0.27
14	Balance	0.00 dB	Rectangular	1.732	0.00	0.00
15	Site imperfections	3.76 dB	Triangular	2.449	1.54	2.36
16	Separation distance at 3 m	0.30 dB	Rectangular	1.732	0.17	0.03
17	Effect of setup table material	0.77 dB	Rectangular	1.732	0.44	0.20
18	Table height at 3 m	0.10 dB	Normal, k=2	2.000	0.05	0.00
19	Near-field effects	0.00 dB	Triangular	2.449	0.00	0.00
20	Effect of ambient noise on OATS	0.00 dB				0.00
Combined standard uncertainty			Normal		2.95 dB	
Expanded uncertainty			Normal, k=2		5.90 dB	



3.2.3 Radiated Emission Measurements (Above 1GHz)

	Input Quantity (Contribution) X_i	Value	Prob. Dist.	Divisor	$u_i(x)$	$u_i(x)^2$
1	Receiver reading	0.10 dB	Normal, k=1	1.000	0.10	0.01
2	Attenuation: antenna-receiver	0.20 dB	Normal, k=2	2.000	0.10	0.01
3	Antenna factor AF	0.75 dB	Normal, k=2	2.000	0.38	0.14
4	Receiver sinewave accuracy	0.45 dB	Normal, k=2	2.000	0.23	0.05
5	Receiver pulse amplitude	1.50 dB	Rectangular	1.732	0.87	0.75
6	Receiver pulse repetition rate	1.50 dB	Rectangular	1.732	0.87	0.75
7	Noise floor proximity	0.50 dB	Rectangular	1.732	0.29	0.08
8	Mismatch: antenna-receiver	0.95 dB	U-shaped	1.414	0.67	0.45
9	AF frequency interpolation	0.30 dB	Rectangular	1.732	0.17	0.03
10	AF height deviations	0.10 dB	Rectangular	1.732	0.06	0.00
11	Directivity difference at 3 m	3.12 dB	Rectangular	1.732	1.80	3.24
12	Phase center location at 3 m	1.00 dB	Rectangular	1.732	0.58	0.33
13	Cross-polarisation	0.90 dB	Rectangular	1.732	0.52	0.27
14	Balance	0.00 dB	Rectangular	1.732	0.00	0.00
15	Site imperfections	3.25 dB	Triangular	2.449	1.33	1.76
16	Separation distance at 3 m	0.30 dB	Rectangular	1.732	0.17	0.03
17	Effect of setup table material	0.77 dB	Rectangular	1.732	0.44	0.20
18	Table height at 3 m	0.10 dB	Normal, k=2	2.000	0.05	0.00
19	Near-field effects	0.00 dB	Triangular	2.449	0.00	0.00
20	Effect of ambient noise on OATS	0.00 dB				0.00
Combined standard uncertainty				Normal	2.85 dB	
Expanded uncertainty				Normal, k=2	5.70 dB	

3.2.4 Conducted Measurements

	Input Quantity (Contribution) X_i	Value	Prob. Dist.	Divisor	$u_i(x)$	$u_i(x)^2$
1	Receiver reading	0.10 dB	Normal, k=1	1.000	0.10	0.01
2	LISN-receiver attenuation	0.10 dB	Normal, k=2	2.000	0.05	0.00
3	LISN voltage division factor	0.30 dB	Normal, k=2	2.000	0.15	0.02
4	Receiver sinewave accuracy	0.36 dB	Normal, k=2	2.000	0.18	0.03
5	Receiver pulse amplitude	1.50 dB	Rectangular	1.732	0.87	0.75
6	Receiver pulse repetition rate	1.50 dB	Rectangular	1.732	0.87	0.75
7	Noise floor proximity	0.00 dB	Rectangular	1.732	0.00	0.00
8	AMN VDF frequency interpolation	0.10 dB	Rectangular	1.732	0.06	0.00
9	Mismatch	0.07 dB	U-shaped	1.414	0.05	0.00
10	LISN impedance	2.65 dB	Triangular	2.449	1.08	1.17
11	Effect of mains disturbance	0.00 dB			0.00	0.00
12	Effect of the environment					
Combined standard uncertainty				Normal	1.66 dB	
Expanded uncertainty				Normal, k=2	3.31 dB	



SECTION 4

DIAGRAM OF TEST SETUP

4.1 TEST SETUP DIAGRAM

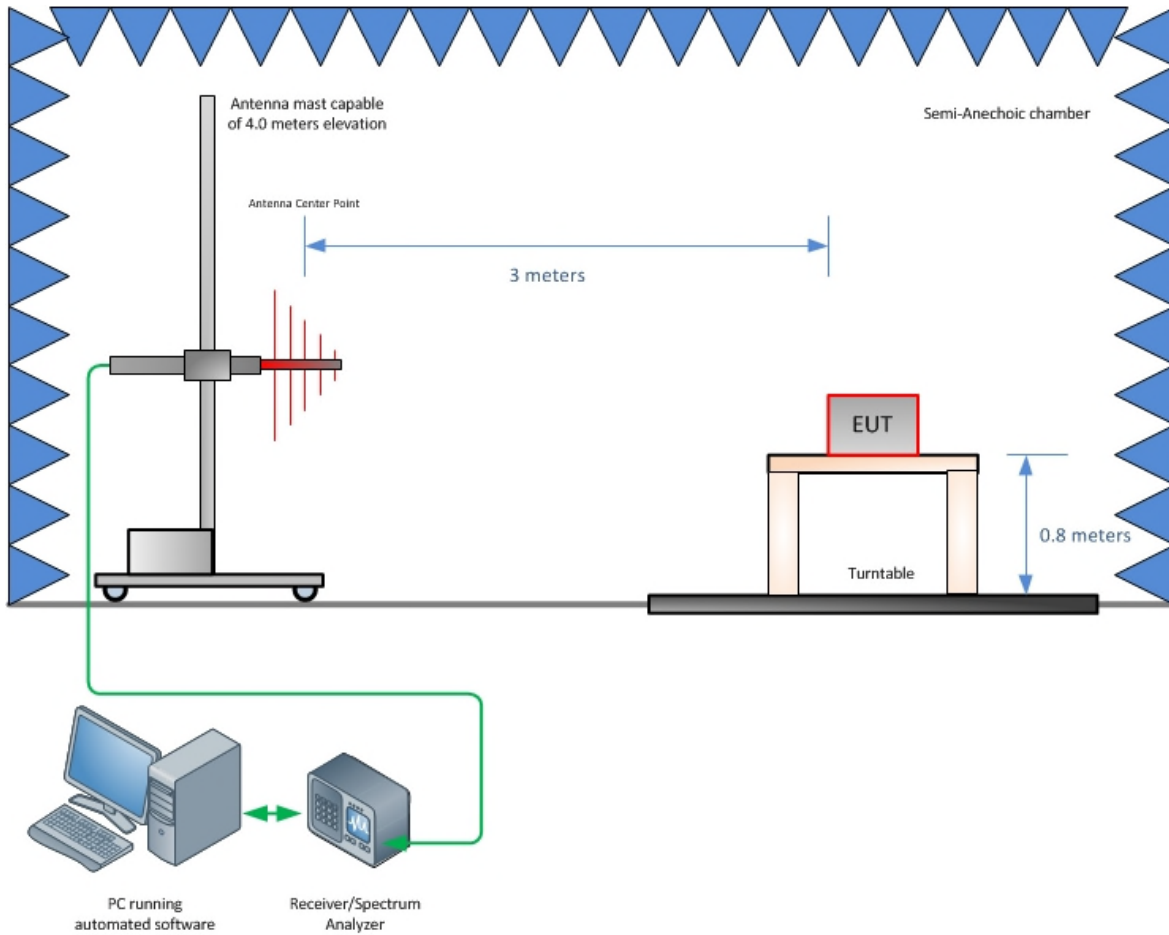

Radiated Emission Test Setup (Below 1GHz)

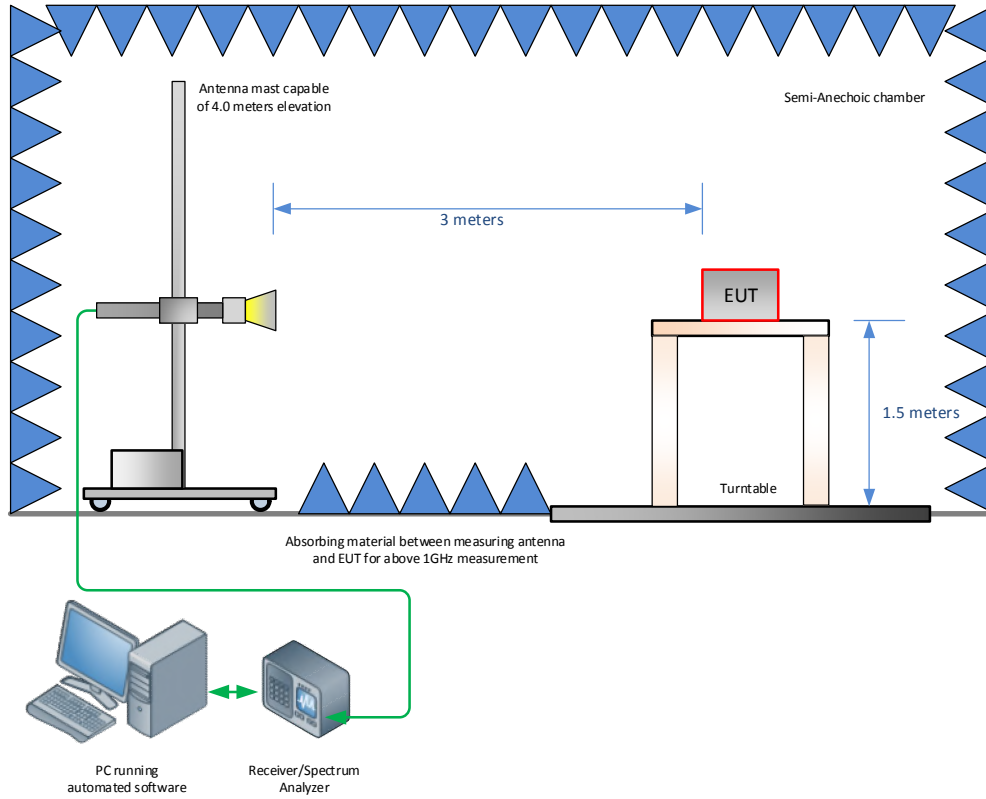

Radiated Emission Test Setup (Above 1GHz)



America

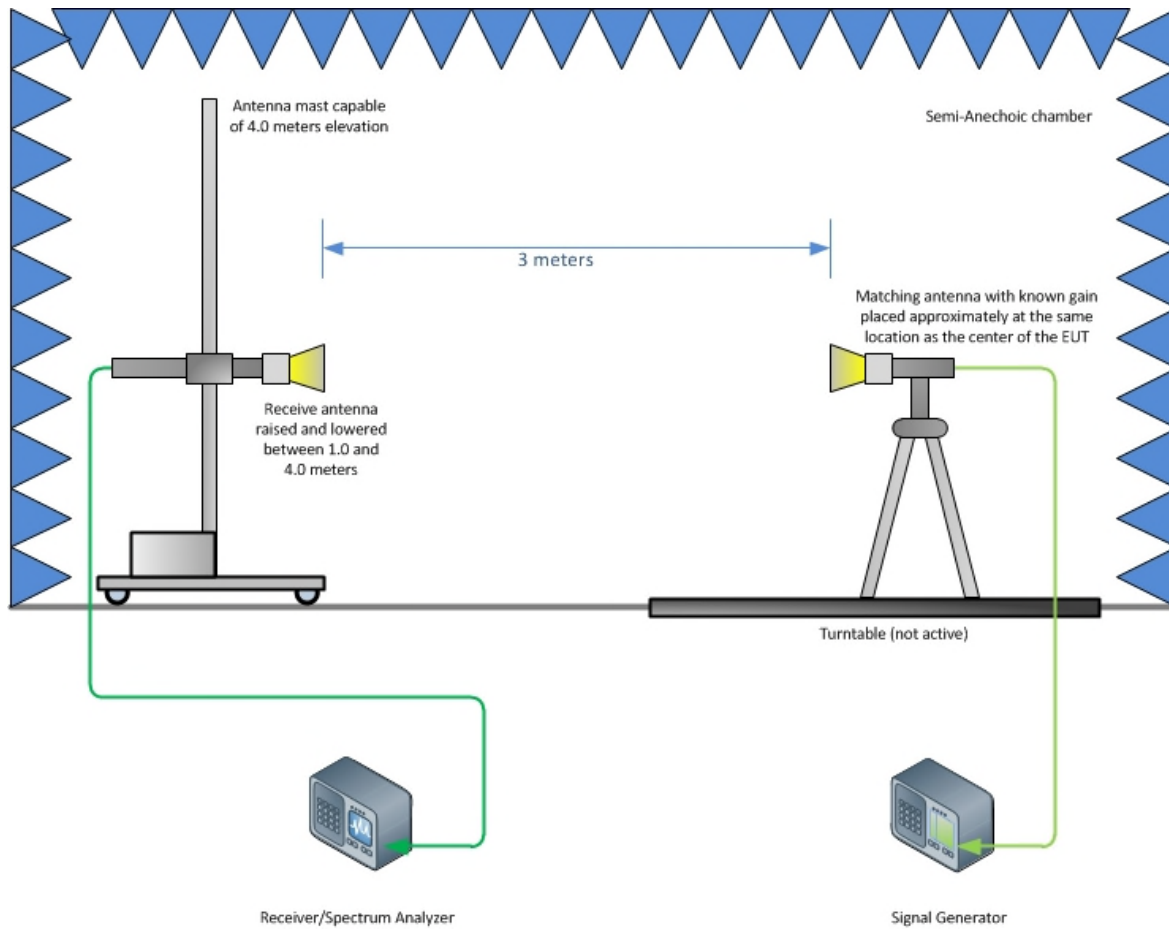

Substitution Test Method (Above 1GHz)

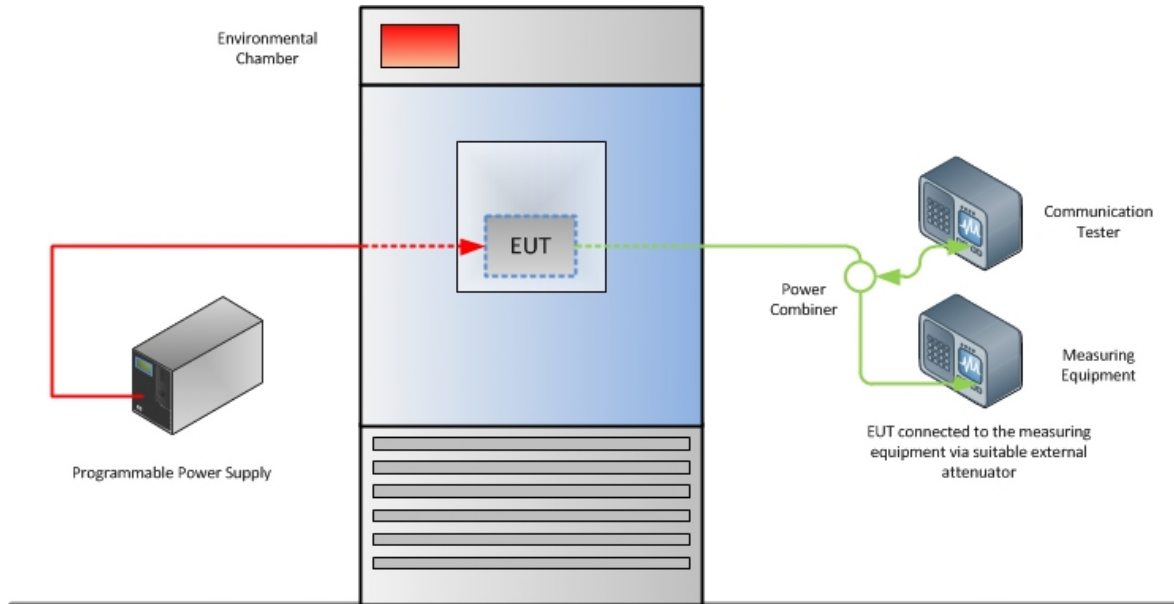

Frequency Stability Test Configuration



SECTION 5

ACCREDITATION, DISCLAIMERS AND COPYRIGHT



5.1 ACCREDITATION, DISCLAIMERS AND COPYRIGHT

TÜV SÜD America Inc.'s reports apply only to the specific sample tested under stated test conditions. It is the manufacturer's responsibility to assure the continued compliance of production units of this model. TÜV SÜD America, Inc. shall have no liability for any deductions, inferences or generalizations drawn by the client or others from TÜV SÜD America, Inc.'s issued reports.

This report is the confidential property of the client. As a mutual protection to our clients, the public and TÜV SÜD America, Inc., extracts from the test report shall not be reproduced, except in full without TÜV SÜD America, Inc.'s written approval.

This report must not be used to claim product certification, approval, or endorsement by A2LA, NIST, or any agency of the federal government.

TÜV SÜD America, Inc. and its professional staff hold government and professional organization certifications for AAMI, ACIL, AEA, ANSI, IEEE, A2LA, NIST and VCCI.

