



FCC RADIO TEST REPORT

FCC ID : PKRISGMD2000
Equipment : Wireless Module
Brand Name : Inseego
Model Name : MD2000
Applicant : Inseego Corporation
9710 Scranton Road Suite 200, San Diego, CA 92121
Manufacturer : Inseego Corporation
9710 Scranton Road Suite 200, San Diego, CA 92121
Standard : FCC 47 CFR Part 2, 22(H), 27

The product was received on Sep. 11, 2020 and testing was started from Sep. 15, 2020 and completed on Oct. 16, 2020. We, SPORTON INTERNATIONAL INC. EMC & Wireless Communications Laboratory, would like to declare that the tested sample has been evaluated in accordance with the test procedures given in ANSI / TIA-603-E and has been in compliance with the applicable technical standards.

The test results in this variant report apply exclusively to the tested model / sample. Without written approval of SPORTON INTERNATIONAL INC. EMC & Wireless Communications Laboratory, the test report shall not be reproduced except in full.

Louis Wu

Approved by: Louis Wu

SPORTON INTERNATIONAL INC. EMC & Wireless Communications Laboratory

No. 52, Huaya 1st Rd., Guishan Dist., Taoyuan City, Taiwan (R.O.C.)



Table of Contents

History of this test report.....	3
Summary of Test Result.....	4
1 General Description	5
1.1 Product Feature of Equipment Under Test.....	5
1.2 Modification of EUT	5
1.3 Testing Location	5
1.4 Applicable Standards.....	6
2 Test Configuration of Equipment Under Test	7
2.1 Test Mode.....	7
2.2 Connection Diagram of Test System.....	9
2.3 Support Unit used in test configuration and system	9
2.4 Measurement Results Explanation Example.....	9
2.5 Frequency List of Low/Middle/High Channels	10
3 Conducted Test Items.....	12
3.1 Measuring Instruments	12
3.2 Conducted Output Power and ERP/EIRP	13
3.3 Peak-to-Average Ratio	14
3.4 Occupied Bandwidth.....	15
3.5 Conducted Band Edge	16
3.6 Conducted Spurious Emission	17
3.7 Frequency Stability	18
4 Radiated Test Items	19
4.1 Measuring Instruments	19
4.2 Radiated Spurious Emission Measurement	21
5 List of Measuring Equipment.....	22
6 Uncertainty of Evaluation.....	24
Appendix A. Test Results of Conducted Test	
Appendix B. Test Results of ERP/EIRP and Radiated Test	
Appendix C. Test Setup Photographs	



History of this test report

Report No.	Version	Description	Issued Date
FG090125-01B	01	Initial issue of report	Oct. 22, 2020



Summary of Test Result

Table with 5 columns: Report Clause, Ref Std. Clause, Test Items, Result (PASS/FAIL), Remark. Rows include test cases for Conducted Output Power, Effective Radiated Power, Peak-to-Average Ratio, Occupied Bandwidth, and Spurious Emission.

Noe: This is a variant report by enable n5, n41 and n71 Band. All the test cases were performed on original report which can be referred to Sporton Report Number FG090125C. Based on the original report, the test cases were verified.

Declaration of Conformity: The test results with all measurement uncertainty excluded are presented in accordance with the regulation limits or requirements declared by manufacturers. Comments and Explanations: The declared of product specification for EUT presented in the report are provided by the manufacturer, and the manufacturer takes all the responsibilities for the accuracy of product specification.

Reviewed by: Wii Chang

Report Producer: Vivian Hsu



1 General Description

1.1 Product Feature of Equipment Under Test

WCDMA/LTE/5G NR, Wi-Fi 2.4GHz 802.11b/g/n/ac/ax, Wi-Fi 5GHz 802.11a/n/ac/ax, and GNSS.

Product Specification subjective to this standard	
Antenna Type	WWAN: Monopole Antenna WLAN: <Ant. 0>: Monopole Antenna <Ant. 1>: Monopole Antenna GPS/BDS/Galileo/GLONASS: Monopole Antenna

1.2 Modification of EUT

No modifications are made to the EUT during all test items.

1.3 Testing Location

Test Site	SPORTON INTERNATIONAL INC. EMC & Wireless Communications Laboratory
Test Site Location	No.52, Huaya 1st Rd., Guishan Dist., Taoyuan City, Taiwan (R.O.C.) TEL: +886-3-327-3456 FAX: +886-3-328-4978
Test Site No.	Sporton Site No. TH05-HY
Test Engineer	Richard Qiu and Ivy Yeh
Temperature	20~25°C
Relative Humidity	55~65%

Test Site	SPORTON INTERNATIONAL INC. EMC & Wireless Communications Laboratory
Test Site Location	No.58, Aly. 75, Ln. 564, Wenhua 3rd, Rd., Guishan Dist., Taoyuan City, Taiwan (R.O.C.) TEL: +886-3-327-0868 FAX: +886-3-327-0855
Test Site No.	Sporton Site No. 03CH12-HY
Test Engineer	Jack Cheng, Lance Chiang and Chuan Chu
Temperature	24.3~26.4°C
Relative Humidity	58~66%

Note: The test site complies with ANSI C63.4 2014 requirement.

FCC Designation No.: TW1190 and TW0007



1.4 Applicable Standards

According to the specifications of the manufacturer, the EUT must comply with the requirements of the following standards:

- ♦ ANSI C63.26-2015
- ♦ ANSI / TIA-603-E
- ♦ FCC 47 CFR Part 2, 22(H), 27
- ♦ FCC KDB 971168 D01 Power Meas. License Digital Systems v03r01
- ♦ FCC KDB 412172 D01 Determining ERP and EIRP v01r01
- ♦ FCC KDB 414788 D01 Radiated Test Site v01r01.

Remark:

1. All test items were verified and recorded according to the standards and without any deviation during the test.
2. This EUT has also been tested and complied with the requirements of FCC Part 15, Subpart B, recorded in a separate test report.
3. The TAF code is not including all the FCC KDB listed without accreditation.



2 Test Configuration of Equipment Under Test

2.1 Test Mode

Antenna port conducted and radiated test items listed below are performed according to KDB 971168 D01 Power Meas. License Digital Systems v03r01 with maximum output power.

For radiated measurement, pre-scanned in two config (Ant. Horizontal and Ant. Vertical). The worst cases (Ant. Horizontal for EN-DC 2A_n71A / EN-DC 2A_n5A / EN-DC 66A_n5A / EN-DC 2A_n41A / EN-DC 66A_n41A; Ant. Vertical for EN-DC 7A_n71A / EN-DC 66A_n71A / EN-DC 48A_n5A / EN-DC 25A_n41A / EN-DC 26A_n41A) were recorded in this report.

Test Items	NR Band	Bandwidth (MHz)						Modulation					RB #			Test Channel		
		5	10	15	20	40	50	PI/2 BPSK	QPSK	16QAM	64QAM	256QAM	1	Half	Full	L	M	H
Max. Output Power	n5	v	v	v	v	-	-	v	v	v	v	v	v	v	v	v	v	v
	n71	v	v	v	v	-	-	v	v	v	v	v	v	v	v	v	v	v
Peak-to-Average Ratio	n5				v	-	-	v	v	v	v	v			v		v	
	n71				v	-	-	v	v	v	v	v			v		v	
26dB and 99% Bandwidth	n5	v	v	v	v	-	-	v	v	v	v	v			v		v	
	n71	v	v	v	v	-	-	v	v	v	v	v			v		v	
Conducted Band Edge	n5	v	v	v	v	-	-	v	v	v	v	v	v		v	v		v
	n71	v	v	v	v	-	-	v	v	v	v	v	v		v	v		v
Conducted Spurious Emission	n5	v	v	v	v	-	-		v				v			v	v	v
	n71	v	v	v	v	-	-		v				v			v	v	v
Frequency Stability	n5				v	-	-		v						v		v	
	n71				v	-	-		v						v		v	
E.R.P / E.I.R.P	n5	v	v	v	v	-	-	v	v	v	v	v	v	v		v	v	v
	n71	v	v	v	v	-	-	v	v	v	v	v	v	v		v	v	v
Radiated Spurious Emission	n5	Worst Case														v	v	v
	n71	Worst Case														v	v	v
Remark	<ol style="list-style-type: none"> The mark "v" means that this configuration is chosen for testing The mark "-" means that this bandwidth is not supported. The device is investigated from 30MHz to 10 times of fundamental signal for radiated spurious emission test under different RB size/offset and modulations in exploratory test. Subsequently, only the worst case emissions are reported. Test combination is EN-DC 2A_n71A / EN-DC 2A_n5A / EN-DC 66A_n5A / EN-DC 7A_n71A / EN-DC 66A_n71A / EN-DC 48A_n5A For radiated measurement, pre-scanned in two modes, DFT-s OFDM and CP OFDM. The worst cases (DFT-s OFDM) were recorded in this report, and the worst modes of FR1 and LTE for simultaneous transmission were verified and compliant. The NR radio operation is controlled via software tool QRCT FTM mode (SW: Version 4.0.00153.0) under 100% duty cycle transmission, expect that the frequency stability is tested by system simulator. 																	



Test Items	NR Band	Bandwidth (MHz)									Modulation					RB #			Test Channel					
		10	15	20	40	50	60	80	90	100	PI/2 BPSK	QPSK	16QAM	64QAM	256QAM	1	Half	Full	L	M	H			
Max. Output Power	n41			v	v	v	v	v	v	v	v	v	v	v	v	v	v	v	v	v	v	v		
Peak-to-Average Ratio	n41			v							v	v	v	v	v	v		v			v			
26dB and 99% Bandwidth	n41			v	v	v	v	v	v	v	v	v	v	v	v					v		v		
Conducted Band Edge	n41			v	v	v	v	v	v	v	v	v	v	v	v	v			v	v		v		
Conducted Spurious Emission	n41			v	v	v	v	v	v	v		v									v	v	v	
Frequency Stability	n41			v								v								v		v		
E.R.P / E.I.R.P	n41			v	v	v	v	v	v	v	v	v	v	v	v	v	v				v	v	v	
Radiated Spurious Emission	n41	Worst Case																				v	v	v
Remark	<ol style="list-style-type: none"> The mark "v" means that this configuration is chosen for testing The mark "-" means that this bandwidth is not supported. The device is investigated from 30MHz to 10 times of fundamental signal for radiated spurious emission test under different RB size/offset and modulations in exploratory test. Subsequently, only the worst case emissions are reported. Test combination is EN-DC 2A_n41A / EN-DC 26A_n41A / EN-DC 25A_n41A / EN-DC 66A_n41A For radiated measurement, pre-scanned in two modes, DFT-s OFDM and CP OFDM. The worst cases (DFT-s OFDM) were recorded in this report, and the worst modes of FR1 and LTE for simultaneous transmission were verified and compliant. The NR radio operation is controlled via software tool QRCT FTM mode (SW: Version 4.0.00153.0) under 100% duty cycle transmission, expect that the frequency stability is tested by system simulator. 																							

2.2 Connection Diagram of Test System

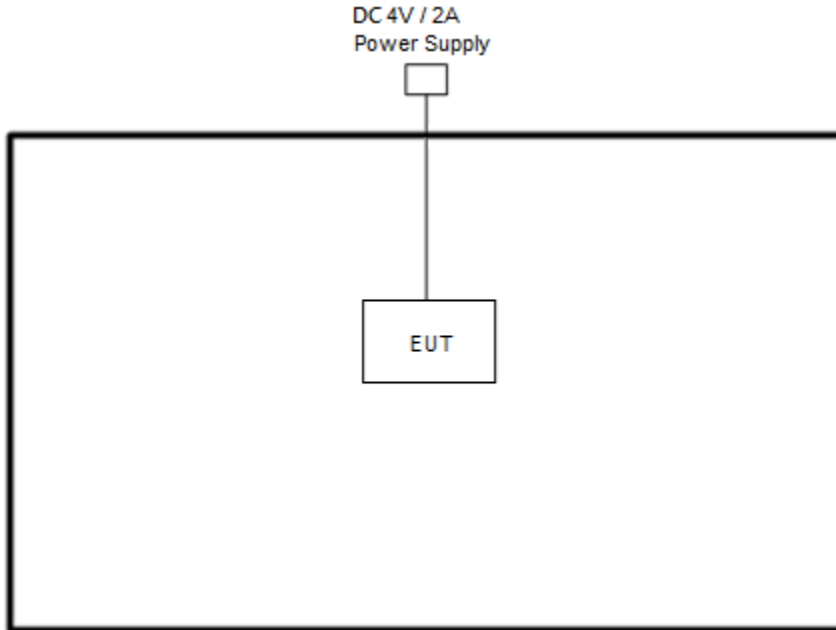

2.3 Support Unit used in test configuration and system

Item	Equipment	Brand Name	Model No.	FCC ID	Data Cable	Power Cord
1.	Power Supply	GW Instek	GPE-2323	N/A	N/A	Unshielded, 1.8 m

2.4 Measurement Results Explanation Example

For all conducted test items:

The offset level is set in the spectrum analyzer to compensate the RF cable loss and attenuator factor between EUT conducted output port and spectrum analyzer. With the offset compensation, the spectrum analyzer reading level is exactly the EUT RF output level.

The spectrum analyzer offset is derived from RF cable loss and attenuator factor.

Offset = RF cable loss + attenuator factor.

Following shows an offset computation example with cable loss 4.2 dB and 10dB attenuator.

Example :

Offset(dB) = RF cable loss(dB) + attenuator factor(dB).

$$= 4.2 + 10 = 14.2 \text{ (dB)}$$



2.5 Frequency List of Low/Middle/High Channels

5G NR Band n5 Channel and Frequency List				
BW [MHz]	Channel/Frequency(MHz)	Lowest	Middle	Highest
20	Channel	166800	167300	167800
	Frequency	834	836.5	839
15	Channel	166300	167300	168300
	Frequency	831.5	836.5	841.5
10	Channel	165800	167300	168800
	Frequency	829	836.5	844
5	Channel	165300	167300	169300
	Frequency	826.5	836.5	846.5

5G NR Band n41 Channel and Frequency List				
BW [MHz]	Channel/Frequency(MHz)	Lowest	Middle	Highest
100	Channel	509202	518598	528000
	Frequency	2546.01	2592.99	2640
90	Channel	508200	518598	528996
	Frequency	2541	2592.99	2644.98
80	Channel	507204	518598	529998
	Frequency	2536.02	2592.99	2649.99
60	Channel	505200	518598	531996
	Frequency	2526	2592.99	2659.98
50	Channel	504204	518598	532998
	Frequency	2521.02	2592.99	2664.99
40	Channel	503202	518598	534000
	Frequency	2516.01	2592.99	2670
20	Channel	501204	518598	535998
	Frequency	2506.02	2592.99	2679.99



5G NR Band n71 Channel and Frequency List				
BW [MHz]	Channel/Frequency(MHz)	Lowest	Middle	Highest
20	Channel	134600	136100	137600
	Frequency	673	680.5	688
15	Channel	134100	136100	138100
	Frequency	670.5	680.5	690.5
10	Channel	133600	136100	138600
	Frequency	668	680.5	693
5	Channel	133100	136100	139100
	Frequency	665.5	680.5	695.5

3 Conducted Test Items

3.1 Measuring Instruments

See list of measuring instruments of this test report.

3.1.1 Test Setup

3.1.2 Conducted Output Power

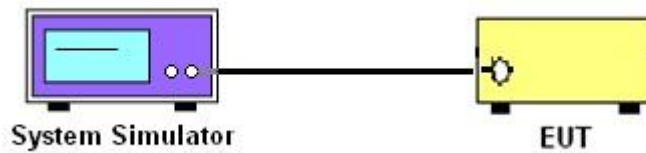

3.1.3 Peak-to-Average Ratio, Occupied Bandwidth ,Conducted Band-Edge and Conducted Spurious Emission

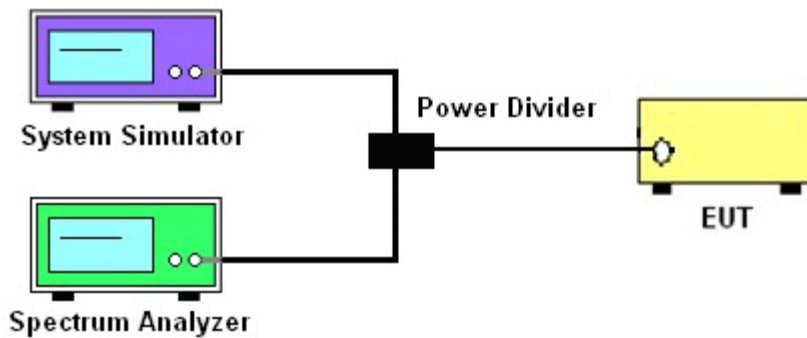

3.1.4 Frequency Stability

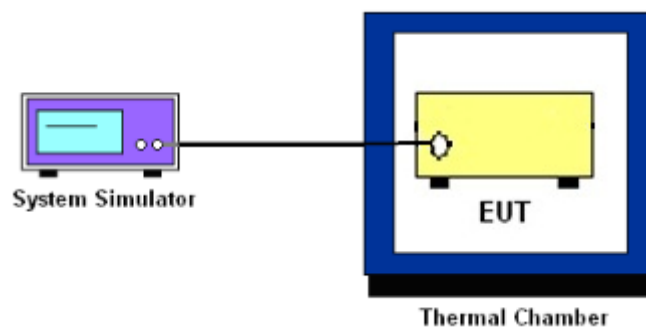

3.1.5 Test Result of Conducted Test

Please refer to Appendix A.



3.2 Conducted Output Power and ERP/EIRP

3.2.1 Description of the Conducted Output Power Measurement and ERP/EIRP Measurement

A system simulator was used to establish communication with the EUT. Its parameters were set to force the EUT transmitting at maximum output power. The measured power in the radio frequency on the transmitter output terminals shall be reported.

The ERP of mobile transmitters must not exceed 7 Watts for 5G NR n5

The ERP of mobile transmitters must not exceed 3 Watts for 5G NR n71

The EIRP of mobile transmitters must not exceed 2 Watts for 5G NR n41

According to KDB 412172 D01 Power Approach,

$EIRP = P_T + G_T - L_C$, $ERP = EIRP - 2.15$, where

P_T = transmitter output power in dBm

G_T = gain of the transmitting antenna in dBi

L_C = signal attenuation in the connecting cable between the transmitter and antenna in dB

3.2.2 Test Procedures

1. The transmitter output port was connected to the system simulator.
2. Set EUT at maximum power through the system simulator.
3. Select lowest, middle, and highest channels for each band and different modulation.
4. Measure and record the power level from the system simulator.



3.3 Peak-to-Average Ratio

3.3.1 Description of the PAR Measurement

Power Complementary Cumulative Distribution Function (CCDF) curves provide a means for characterizing the power peaks of a digitally modulated signal on a statistical basis. A CCDF curve depicts the probability of the peak signal amplitude exceeding the average power level. Most contemporary measurement instrumentation include the capability to produce CCDF curves for an input signal provided that the instrument's resolution bandwidth can be set wide enough to accommodate the entire input signal bandwidth. In measuring transmissions in this band using an average power technique, the peak-to-average ratio (PAR) of the transmission may not exceed 13 dB.

3.3.2 Test Procedures

The testing follows ANSI C63.26-2015 Section 5.2.6

1. The EUT was connected to spectrum and system simulator via a power divider.
2. Set the CCDF (Complementary Cumulative Distribution Function) option in spectrum analyzer.
3. The highest RF powers were measured and recorded the maximum PAPR level associated with a probability of 0.1 %.
4. Record the deviation as Peak to Average Ratio.



3.4 Occupied Bandwidth

3.4.1 Description of Occupied Bandwidth Measurement

The occupied bandwidth is the width of a frequency band such that, below the lower and above the upper frequency limits, the mean powers emitted are each equal to a specified percentage 0.5% of the total mean transmitted power.

The 26 dB emission bandwidth is defined as the frequency range between two points, one above and one below the carrier frequency, at which the spectral density of the emission is attenuated 26 dB below the maximum in-band spectral density of the modulated signal. Spectral density (power per unit bandwidth) is to be measured with a detector of resolution bandwidth equal to approximately 1.0% of the emission bandwidth.

3.4.2 Test Procedures

The testing follows ANSI C63.26-2015 Section 5.4.3 (26dB) and Section 5.4.4 (99OB)

1. The EUT was connected to spectrum analyzer and system simulator via a power divider.
2. The spectrum analyzer center frequency is set to the nominal EUT channel center frequency. The span range for the spectrum analyzer shall be between two and five times the anticipated OBW.
3. The nominal resolution bandwidth (RBW) shall be in the range of 1 to 5 % of the anticipated OBW, and the VBW shall be at least 3 times the RBW.
4. Set the detection mode to peak, and the trace mode to max hold.
5. Determine the reference value: Set the EUT to transmit a modulated signal. Allow the trace to stabilize. Set the spectrum analyzer marker to the highest level of the displayed trace.
(this is the reference value)
6. Determine the “-26 dB down amplitude” as equal to (Reference Value – X).
7. Place two markers, one at the lowest and the other at the highest frequency of the envelope of the spectral display such that each marker is at or slightly below the “-X dB down amplitude” determined in step 6. If a marker is below this “-X dB down amplitude” value it shall be placed as close as possible to this value. The OBW is the positive frequency difference between the two markers.
8. Use the 99 % power bandwidth function of the spectrum analyzer and report the measured bandwidth.



3.5 Conducted Band Edge

3.5.1 Description of Conducted Band Edge Measurement

22.917(a)

For operations in the 824 – 849 MHz band, the FCC limit is $43 + 10\log_{10}(P[\text{Watts}])$ dB below the transmitter power $P(\text{Watts})$ in a 100kHz bandwidth. However, in the 1MHz bands immediately outside and adjacent to the licensee's frequency block, a resolution bandwidth of at least one percent of the emission bandwidth of the fundamental emission of the transmitter may be employed.

27.53 (g)

For operations in the 600MHz band and 698-746 MHz band, the FCC limit is $43 + 10\log_{10}(P[\text{Watts}])$ dB below the transmitter power $P(\text{Watts})$ in a 100 kHz bandwidth. However, in the 100 kilohertz bands immediately outside and adjacent to a licensee's frequency block, a resolution bandwidth of at least 30 kHz may be employed.

27.53 (h)

For operations in the 1710 – 1755 MHz band, 1755-1780 MHz, the FCC limit is $43 + 10\log_{10}(P[\text{Watts}])$ dB below the transmitter power $P(\text{Watts})$ in a 1 MHz bandwidth. However, in the 1MHz bands immediately outside and adjacent to the licensee's frequency block, a resolution bandwidth of at least one percent of the emission bandwidth of the fundamental emission of the transmitter may be employed.

3.5.2 Test Procedures

The testing follows FCC KDB 971168 D01 v03r01 Section 6.1.

1. The EUT was connected to spectrum analyzer and system simulator via a power divider.
2. The band edges of low and high channels for the highest RF powers were measured.
3. Set RBW \geq 1% EBW in the 1MHz band immediately outside and adjacent to the band edge.
4. Beyond the 1 MHz band from the band edge, RBW=1MHz was used.
5. Set spectrum analyzer with RMS detector.
6. The RF fundamental frequency should be excluded against the limit line in the operating frequency band.
7. Checked that all the results comply with the emission limit line.

The limit line is derived from $43 + 10\log(P)\text{dB}$ below the transmitter power $P(\text{Watts})$

For 5G NR n7, n41

The other 40 dB, and 55 dB have additionally applied same calculation above.



3.6 Conducted Spurious Emission

3.6.1 Description of Conducted Spurious Emission Measurement

The power of any emission outside of the authorized operating frequency ranges must be lower than the transmitter power (P) by a factor of at least $43 + 10 \log (P)$ dB.

It is measured by means of a calibrated spectrum analyzer and scanned from 30 MHz up to a frequency including its 10th harmonic.

3.6.2 Test Procedures

The testing follows FCC KDB 971168 D01 v03r01 Section 6.1.

1. The EUT was connected to spectrum analyzer and system simulator via a power divider.
2. The RF output of EUT was connected to the spectrum analyzer by RF cable and attenuator. The path loss was compensated to the results for each measurement.
3. The middle channel for the highest RF power within the transmitting frequency was measured.
4. The conducted spurious emission for the whole frequency range was taken.
5. Make the measurement with the spectrum analyzer's RBW = 1MHz, VBW = 3MHz.
6. Set spectrum analyzer with RMS detector.
7. Taking the record of maximum spurious emission.
8. The RF fundamental frequency should be excluded against the limit line in the operating frequency band.
9. The limit line is derived from $43 + 10\log(P)$ dB below the transmitter power P(Watts)
For 5G NR n7, n41
The limit line is derived from $55 + 10\log(P)$ dB below the transmitter power P(Watts)



3.7 Frequency Stability

3.7.1 Description of Frequency Stability Measurement

22.355

The frequency stability shall be measured by variation of ambient temperature and variation of primary supply voltage to ensure that the fundamental emission stays within the authorized frequency block. The frequency stability of the transmitter shall be maintained within $\pm 0.00025\%$ ($\pm 2.5\text{ppm}$) of the center frequency.

27.54

The frequency stability shall be sufficient to ensure that the fundamental emission stays within the authorized frequency block.

3.7.2 Test Procedures for Temperature Variation

The testing follows FCC KDB 971168 D01 v03r01 Section 9.0.

1. The EUT was set up in the thermal chamber and connected with the system simulator.
2. With power OFF, the temperature was decreased to -30°C and the EUT was stabilized before testing. Power was applied and the maximum change in frequency was recorded within one minute.
3. With power OFF, the temperature was raised in 10°C step up to 50°C . The EUT was stabilized at each step for at least half an hour. Power was applied and the maximum frequency change was recorded within one minute.

3.7.3 Test Procedures for Voltage Variation

The testing follows FCC KDB 971168 D01 v03r01 Section 9.0.

1. The EUT was placed in a temperature chamber at $20\pm 5^{\circ}\text{C}$ and connected with the system simulator.
2. The power supply voltage to the EUT was varied from 85% to 115% of the nominal value measured at the input to the EUT.
3. The variation in frequency was measured for the worst case.

4 Radiated Test Items

4.1 Measuring Instruments

See list of measuring instruments of this test report.

4.1.1 Test Setup

For radiated emissions below 30MHz

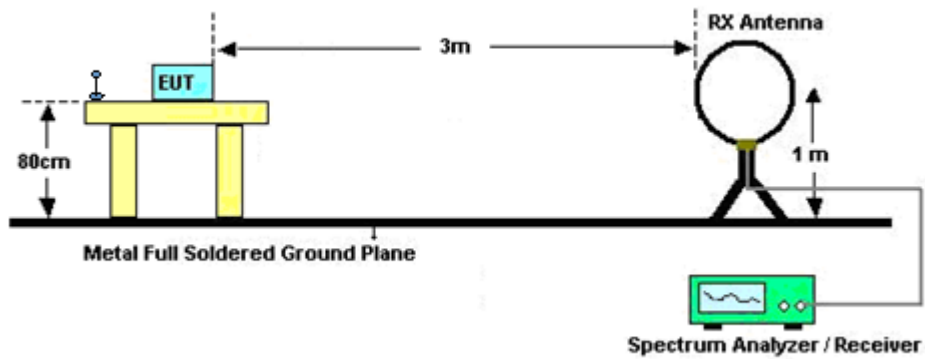

For radiated test from 30MHz to 1GHz

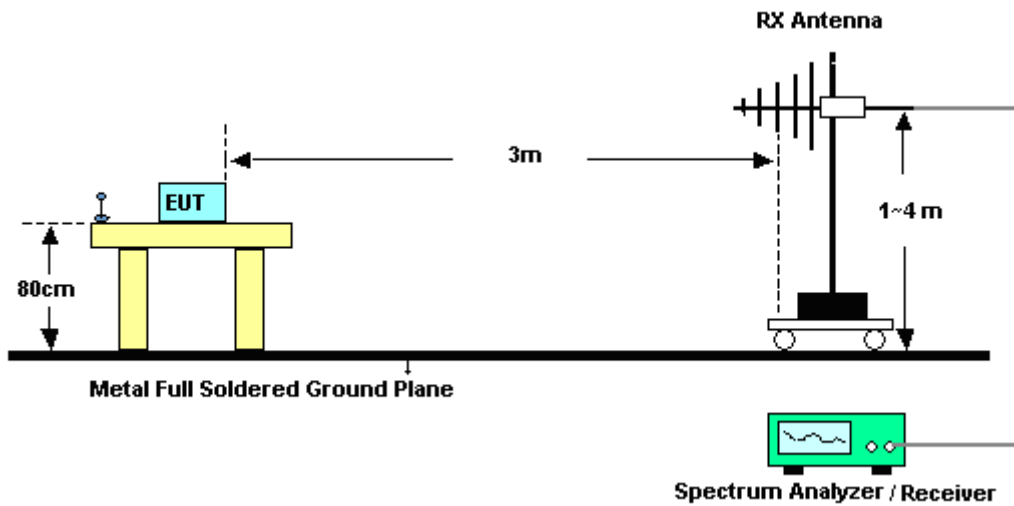

For radiated test from 1GHz to 18GHz

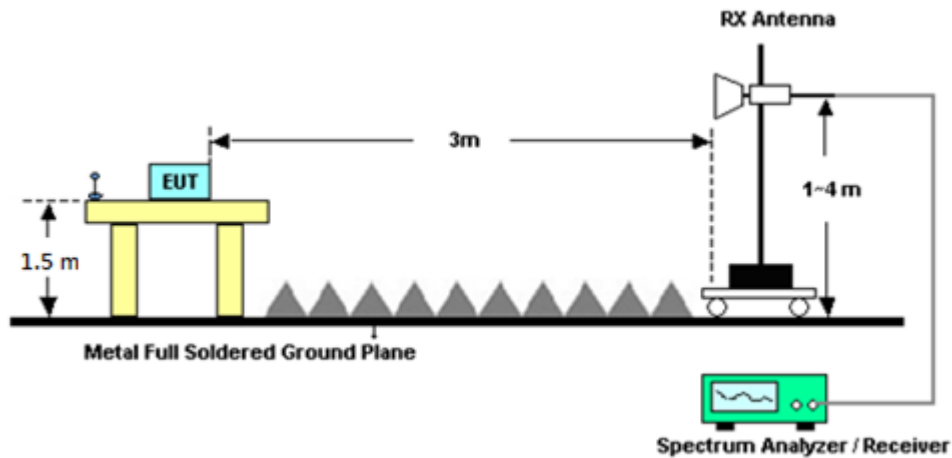

For radiated test above 18GHz

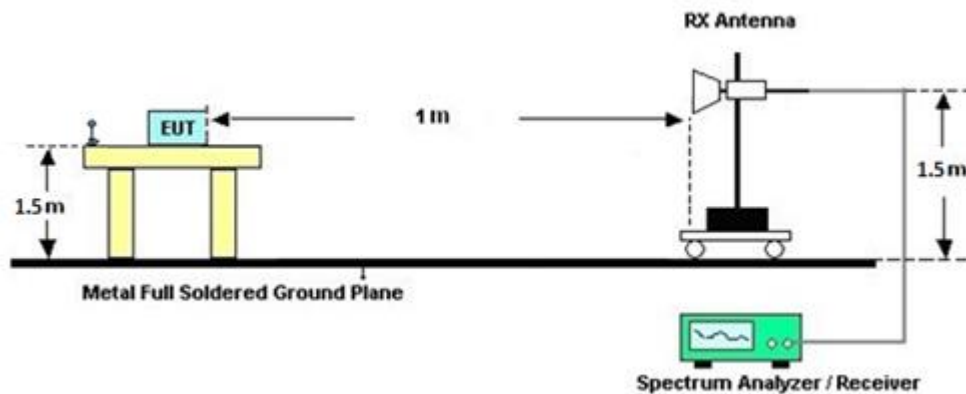

4.1.2 Test Result of Radiated Test

Please refer to Appendix B.

Note:

The low frequency, which started from 9 kHz to 30MHz, was pre-scanned and the result which was 20dB lower than the limit line was not reported.

There is a comparison data of both open-field test site and alternative test site - semi-Anechoic chamber according to 414788 D01 Radiated Test Site v01r01, and the result came out very similar.



4.2 Radiated Spurious Emission Measurement

4.2.1 Description of Radiated Spurious Emission Measurement

The radiated spurious emission was measured by substitution method according to ANSI / TIA-603-E. The power of any emission outside of the authorized operating frequency ranges must be attenuated below the transmitter power (P) by a factor of at least $43 + 10 \log (P)$ dB.

For 5G NR n7, n41

The power of any emission outside of the authorized operating frequency ranges must be attenuated below the transmitter power (P) by a factor of at least $55 + 10 \log (P)$ dB.

The spectrum is scanned from 30 MHz up to a frequency including its 10th harmonic.

4.2.2 Test Procedures

The testing follows FCC KDB 971168 D01 v03r01 Section 7 and ANSI / TIA-603-E Section 2.2.12.

1. The EUT was placed on a turntable with 0.8 meter for frequency below 1GHz and 1.5 meter for frequency above 1GHz respectively above ground.
2. The EUT was set 3 meters from the receiving antenna, which was mounted on the antenna tower.
3. The table was rotated 360 degrees to determine the position of the highest spurious emission.
4. The height of the receiving antenna is varied between one meter and four meters to search the maximum spurious emission for both horizontal and vertical polarizations.
5. Make the measurement with the spectrum analyzer's RBW = 1MHz, VBW = 3MHz, taking the record of maximum spurious emission.
6. A horn antenna was substituted in place of the EUT and was driven by a signal generator.
7. Tune the output power of signal generator to the same emission level with EUT maximum spurious emission.
8. Taking the record of output power at antenna port.
9. Repeat step 7 to step 8 for another polarization.
10. The RF fundamental frequency should be excluded against the limit line in the operating frequency band.

The limit line is derived from $43 + 10\log(P)$ dB below the transmitter power P(Watts)

For 5G NR n7, n41

The limit line is derived from $55 + 10\log(P)$ dB below the transmitter power P(Watts)

EIRP (dBm) = S.G. Power – Tx Cable Loss + Tx Antenna Gain

ERP (dBm) = EIRP - 2.15



5 List of Measuring Equipment

Instrument	Brand Name	Model No.	Serial No.	Characteristics	Calibration Date	Test Date	Due Date	Remark
Loop Antenna	Rohde & Schwarz	HFH2-Z2	100315	9 kHz~30 MHz	Dec. 26, 2019	Sep. 24, 2020~ Oct. 15, 2020	Dec. 25, 2020	Radiation (03CH12-HY)
Bilog Antenna	TESEQ	CBL 6111D & 00800N1D01N -06	40103 & 07	30MHz~1GHz	Apr. 29, 2020	Sep. 24, 2020~ Oct. 15, 2020	Apr. 28, 2021	Radiation (03CH12-HY)
Horn Antenna	SCHWARZBE CK	BBHA 9120 D	9120D-1328	1GHz~18GHz	Nov. 14, 2019	Sep. 24, 2020~ Oct. 15, 2020	Nov. 13, 2020	Radiation (03CH12-HY)
Horn Antenna	SCHWARZBE CK	BBHA 9120D	9120D-1241	1GHz ~ 18GHz	Jul. 15, 2020	Sep. 24, 2020~ Oct. 15, 2020	Jul. 14, 2021	Radiation (03CH12-HY)
SHF-EHF Horn Antenna	SCHWARZBE CK	BBHA 9170	BBHA917058 4	18GHz~40GHz	Dec. 10, 2019	Sep. 24, 2020~ Oct. 15, 2020	Dec. 09, 2020	Radiation (03CH12-HY)
SHF-EHF Horn Antenna	SCHWARZBE CK	BBHA 9170	BBHA917098 0	18GHz ~ 40GHz	Jan. 10, 2019	Sep. 24, 2020~ Oct. 15, 2020	Jan. 09, 2021	Radiation (03CH12-HY)
Preamplifier	COM-POWER	PA-103	161075	10MHz~1GHz	Mar. 25, 2020	Sep. 24, 2020~ Oct. 15, 2020	Mar. 24, 2021	Radiation (03CH12-HY)
Preamplifier	Keysight	83017A	MY57280120	1GHz~26.5GHz	Jul. 20, 2020	Sep. 24, 2020~ Oct. 15, 2020	Jul. 19, 2021	Radiation (03CH12-HY)
Preamplifier	Jet-Power	JPA0118-55-3 03K	1710001800 054002	1GHz~18GHz	Feb. 07, 2020	Sep. 24, 2020~ Oct. 15, 2020	Feb. 06, 2021	Radiation (03CH12-HY)
Preamplifier	EMEC	EM18G40G	060715	18GHz~40GHz	Dec. 13, 2019	Sep. 24, 2020~ Oct. 15, 2020	Dec. 12, 2020	Radiation (03CH12-HY)
Spectrum Analyzer	Agilent	N9010A	MY54200485	10Hz~44GHz	Feb. 10, 2020	Sep. 24, 2020~ Oct. 15, 2020	Feb. 09, 2021	Radiation (03CH12-HY)
Signal Generator	Anritsu	MG3694C	163401	0.1Hz~40GHz	Feb. 15, 2020	Sep. 24, 2020~ Oct. 15, 2020	Feb. 14, 2021	Radiation (03CH12-HY)
RF Cable	HUBER + SUHNER	SUCOFLEX 104	MY9837/4PE	9kHz~30MHz	Mar. 12, 2020	Sep. 24, 2020~ Oct. 15, 2020	Mar. 11, 2021	Radiation (03CH12-HY)
RF Cable	HUBER + SUHNER	SUCOFLEX 126E	0058/126E	30MHz~18GHz	Dec. 12, 2019	Sep. 24, 2020~ Oct. 15, 2020	Dec. 11, 2020	Radiation (03CH12-HY)
RF Cable	HUBER + SUHNER	SUCOFLEX 102	505134/2	30MHz~40GHz	Feb. 25, 2020	Sep. 24, 2020~ Oct. 15, 2020	Feb. 24, 2021	Radiation (03CH12-HY)
RF Cable	HUBER + SUHNER	SUCOFLEX 102	800740/2	30MHz~40GHz	Feb. 25, 2020	Sep. 24, 2020~ Oct. 15, 2020	Feb. 24, 2021	Radiation (03CH12-HY)
Hygrometer	TECPEL	DTM-303B	TP140349	N/A	Oct. 25, 2019	Sep. 24, 2020~ Oct. 15, 2020	Oct. 24, 2020	Radiation (03CH12-HY)
Controller	EMEC	EM1000	N/A	Control Turn table & Ant Mast	N/A	Sep. 24, 2020~ Oct. 15, 2020	N/A	Radiation (03CH12-HY)
Antenna Mast	EMEC	AM-BS-4500-B	N/A	1m~4m	N/A	Sep. 24, 2020~ Oct. 15, 2020	N/A	Radiation (03CH12-HY)
Turn Table	EMEC	TT2000	N/A	0~360 Degree	N/A	Sep. 24, 2020~ Oct. 15, 2020	N/A	Radiation (03CH12-HY)
Software	Audix	E3 6.2009-8-24	RK-000989	N/A	N/A	Sep. 24, 2020~ Oct. 15, 2020	N/A	Radiation (03CH12-HY)



Instrument	Brand Name	Model No.	Serial No.	Characteristics	Calibration Date	Test Date	Due Date	Remark
Programmable Power Supply	GW Instek	PSS-2005	EL883644	Voltage:0~20V; Current:0~5A	Aug. 19, 2020	Sep. 15, 2020~ Oct. 16, 2020	Aug. 18, 2021	Conducted (TH05-HY)
Spectrum Analyzer	Rohde & Schwarz	FSV40	101397	10Hz~40GHz	Nov. 15, 2019	Sep. 15, 2020~ Oct. 16, 2020	Nov. 14, 2020	Conducted (TH05-HY)
Power Sensor	DARE	RPR3006W	15I0041SN0 09	10MHz~6GHz	Jan. 22, 2020	Sep. 15, 2020~ Oct. 16, 2020	Jan. 21, 2021	Conducted (TH05-HY)
Temperature Chamber	ESPEC	SU-241	92003713	-30℃ ~95℃	May 15, 2020	Sep. 15, 2020~ Oct. 16, 2020	May 14, 2021	Conducted (TH05-HY)
Hygrometer	Testo	HTC-1	2	15℃~35℃	Mar. 02, 2020	Sep. 15, 2020~ Oct. 16, 2020	Mar. 01, 2021	Conducted (TH05-HY)
Base Station (Measure)	Anritsu	MT8821C	6262044657	LTE(FDD)	Jan. 16, 2020	Sep. 15, 2020~ Oct. 16, 2020	Jan. 15, 2021	Conducted (TH05-HY)
Base Station (Measure)	Anritsu	MT8000A	6262012917	5G NR	Jan. 20, 2020	Sep. 15, 2020~ Oct. 16, 2020	Jan. 19, 2021	Conducted (TH05-HY)



6 Uncertainty of Evaluation

Uncertainty of Radiated Emission Measurement (30 MHz ~ 1000 MHz)

Measuring Uncertainty for a Level of Confidence of 95% ($U = 2Uc(y)$)	3.07
-------------------------------------------------------------------------	------

Uncertainty of Radiated Emission Measurement (1 GHz ~ 18 GHz)

Measuring Uncertainty for a Level of Confidence of 95% ($U = 2Uc(y)$)	3.21
-------------------------------------------------------------------------	------

Uncertainty of Radiated Emission Measurement (18 GHz ~ 40 GHz)

Measuring Uncertainty for a Level of Confidence of 95% ($U = 2Uc(y)$)	3.80
-------------------------------------------------------------------------	------



Appendix A. Test Results of Conducted Test

Conducted Output Power(Average power)

<DFT-s-OFDM>

NR n5 Maximum Average Power [dBm]						
BW [MHz]	RB Size	RB Offset	Mod	Lowest	Middle	Highest
5	1	1	PI/2 BPSK	23.76	23.76	23.46
5	1	23		23.36	23.56	23.26
5	12	6		23.46	23.76	23.36
5	1	0		23.66	23.76	22.56
5	1	24		23.06	23.56	22.96
5	25	0		23.16	23.76	22.66
5	1	1	QPSK	23.76	23.76	23.16
5	1	23		23.66	23.56	23.36
5	12	6		23.76	23.76	23.36
5	1	0		23.16	23.66	22.16
5	1	24		22.66	23.56	22.56
5	25	0		23.26	23.66	23.06
5	1	1	16-QAM	23.26	23.66	22.26
5	1	1	64-QAM	21.86	22.16	20.76
5	1	1	256-QAM	20.46	20.36	19.46

NR n5 Maximum Average Power [dBm]						
BW [MHz]	RB Size	RB Offset	Mod	Lowest	Middle	Highest
10	1	1	PI/2 BPSK	23.76	23.76	23.56
10	1	50		23.46	23.56	23.36
10	25	12		23.36	23.66	23.06
10	1	0		23.26	23.46	23.36
10	1	51		22.96	22.96	22.26
10	50	0		22.96	23.16	22.96
10	1	1	QPSK	23.76	23.66	23.56
10	1	50		23.76	23.56	23.26
10	25	12		23.66	23.66	22.96
10	1	0		23.76	23.56	23.46
10	1	51		23.66	23.46	22.86
10	50	0		23.36	23.66	23.16
10	1	1	16-QAM	22.96	23.16	23.36
10	1	1	64-QAM	22.16	22.06	22.06
10	1	1	256-QAM	20.56	20.26	20.36



NR n5 Maximum Average Power [dBm]						
BW [MHz]	RB Size	RB Offset	Mod	Lowest	Middle	Highest
15	1	1	PI/2 BPSK	23.76	23.76	23.76
15	1	77		23.66	23.26	23.46
15	36	18		23.66	23.66	23.66
15	1	0		23.76	23.66	23.76
15	1	78		23.66	22.86	23.46
15	75	0		23.66	23.56	23.66
15	1	1	QPSK	23.76	23.66	23.76
15	1	77		23.76	23.16	23.56
15	36	18		23.66	23.66	23.66
15	1	0		23.66	23.36	23.56
15	1	78		23.56	22.66	22.96
15	75	0		23.56	23.56	23.56
15	1	1	16-QAM	23.46	23.16	23.56
15	1	1	64-QAM	22.06	21.96	21.96
15	1	1	256-QAM	20.56	20.46	20.46

NR n5 Maximum Average Power [dBm]						
BW [MHz]	RB Size	RB Offset	Mod	Lowest	Middle	Highest
20	1	1	PI/2 BPSK	23.76	23.78	23.76
20	1	104		22.86	23.36	23.56
20	50	25		23.66	23.66	23.66
20	1	0		23.76	23.56	23.06
20	1	105		22.56	23.16	22.66
20	100	0		23.66	23.66	23.66
20	1	1	QPSK	23.66	23.56	23.66
20	1	104		22.86	23.16	23.46
20	50	25		23.56	23.66	23.76
20	1	0		23.66	23.66	23.56
20	1	105		22.66	23.36	23.26
20	100	0		23.46	23.36	23.46
20	1	1	16-QAM	23.36	22.76	22.76
20	1	1	64-QAM	21.96	21.96	21.96
20	1	1	256-QAM	20.46	20.46	20.56



NR n71 Maximum Average Power [dBm]						
BW [MHz]	RB Size	RB Offset	Mod	Lowest	Middle	Highest
5	1	1	PI/2 BPSK	23.77	23.53	23.33
5	1	23		23.53	23.23	23.03
5	12	6		23.73	23.43	23.23
5	1	0		23.73	23.53	23.33
5	1	24		23.53	23.23	23.13
5	25	0		23.73	23.53	23.23
5	1	1	QPSK	23.73	23.73	23.43
5	1	23		23.73	23.43	23.23
5	12	6		23.73	23.43	23.33
5	1	0		23.73	23.43	23.23
5	1	24		23.53	23.23	23.03
5	25	0		23.73	23.43	23.23
5	1	1	16-QAM	23.73	23.63	23.43
5	1	1	64-QAM	22.93	22.43	22.23
5	1	1	256-QAM	20.43	20.03	19.93

NR n71 Maximum Average Power [dBm]						
BW [MHz]	RB Size	RB Offset	Mod	Lowest	Middle	Highest
10	1	1	PI/2 BPSK	23.73	23.53	23.33
10	1	50		23.43	23.33	23.13
10	25	12		23.73	23.53	23.33
10	1	0		21.63	23.53	23.33
10	1	51		21.73	23.23	23.13
10	50	0		22.33	23.43	23.23
10	1	1	QPSK	23.73	23.53	23.43
10	1	50		23.43	23.23	23.23
10	25	12		23.73	23.53	23.43
10	1	0		23.63	23.43	23.33
10	1	51		23.33	23.13	23.13
10	50	0		23.63	23.43	23.23
10	1	1	16-QAM	22.63	23.33	23.43
10	1	1	64-QAM	22.43	22.03	22.33
10	1	1	256-QAM	20.23	19.93	19.83



NR n71 Maximum Average Power [dBm]						
BW [MHz]	RB Size	RB Offset	Mod	Lowest	Middle	Highest
15	1	1	PI/2 BPSK	23.73	23.63	23.33
15	1	77		23.33	23.33	23.03
15	36	18		23.63	23.43	23.23
15	1	0		23.73	23.63	23.33
15	1	78		23.43	23.33	23.03
15	75	0		23.63	23.33	23.23
15	1	1	QPSK	23.73	23.63	23.43
15	1	77		23.43	23.33	23.03
15	36	18		23.53	23.53	23.33
15	1	0		23.73	23.53	23.33
15	1	78		23.33	23.13	22.93
15	75	0		23.53	23.33	23.23
15	1	1	16-QAM	23.53	23.43	23.13
15	1	1	64-QAM	22.63	22.13	22.33
15	1	1	256-QAM	20.03	20.03	19.83

NR n71 Maximum Average Power [dBm]						
BW [MHz]	RB Size	RB Offset	Mod	Lowest	Middle	Highest
20	1	1	PI/2 BPSK	23.78	23.53	23.43
20	1	104		23.23	23.23	23.03
20	50	25		23.53	23.43	23.33
20	1	0		23.73	23.63	23.43
20	1	105		23.23	23.23	23.03
20	100	0		23.53	23.43	23.33
20	1	1	QPSK	23.73	23.63	23.43
20	1	104		23.33	23.23	23.03
20	50	25		23.63	23.53	23.33
20	1	0		23.73	23.53	23.33
20	1	105		23.23	23.13	23.03
20	100	0		23.43	23.33	23.23
20	1	1	16-QAM	22.73	23.33	23.23
20	1	1	64-QAM	22.63	22.43	22.33
20	1	1	256-QAM	20.23	19.93	19.83



NR n41 Maximum Average Power [dBm]						
BW [MHz]	RB Size	RB Offset	Mod	Lowest	Middle	Highest
20	1	1	PI/2 BPSK	23.47	23.67	23.67
20	1	49		23.07	23.47	23.47
20	25	12		23.47	23.57	23.57
20	1	0		23.57	23.57	23.27
20	1	50		23.27	23.37	23.17
20	50	0		23.07	23.47	23.47
20	1	1	QPSK	23.67	23.57	23.57
20	1	49		23.47	23.47	23.37
20	25	12		23.57	23.57	23.47
20	1	0		23.57	23.57	23.47
20	1	50		23.47	23.47	23.47
20	50	0		23.47	23.57	23.47
20	1	1	16-QAM	23.67	23.67	23.47
20	1	1	64-QAM	23.77	22.17	22.17
20	1	1	256-QAM	22.37	20.17	20.17

NR n41 Maximum Average Power [dBm]						
BW [MHz]	RB Size	RB Offset	Mod	Lowest	Middle	Highest
40	1	1	PI/2 BPSK	23.97	23.97	23.87
40	1	104		23.97	23.77	23.57
40	50	25		23.87	23.77	23.87
40	1	0		23.47	23.87	23.47
40	1	105		22.97	23.67	22.97
40	100	0		23.57	22.57	23.26
40	1	1	QPSK	23.97	23.97	23.97
40	1	104		23.97	23.77	23.47
40	50	25		23.87	23.77	23.67
40	1	0		23.97	23.97	23.97
40	1	105		23.97	23.77	23.27
40	100	0		23.27	23.87	23.77
40	1	1	16-QAM	23.77	23.97	23.77
40	1	1	64-QAM	23.17	22.57	22.47
40	1	1	256-QAM	21.97	20.57	20.57



NR n41 Maximum Average Power [dBm]						
BW [MHz]	RB Size	RB Offset	Mod	Lowest	Middle	Highest
50	1	1	PI/2 BPSK	23.57	23.57	23.47
50	1	131		23.17	23.37	23.47
50	64	32		23.57	23.37	23.47
50	1	0		23.67	23.57	23.47
50	1	132		23.97	23.37	22.87
50	128	0		23.32	23.37	23.37
50	1	1	QPSK	23.67	23.57	23.47
50	1	131		23.17	23.37	23.47
50	64	32		23.57	23.37	23.37
50	1	0		23.27	23.67	23.47
50	1	132		23.97	23.27	22.97
50	128	0		23.77	23.37	23.37
50	1	1	16-QAM	23.17	23.57	23.57
50	1	1	64-QAM	22.17	22.17	22.07
50	1	1	256-QAM	21.07	20.17	20.07

NR n41 Maximum Average Power [dBm]						
BW [MHz]	RB Size	RB Offset	Mod	Lowest	Middle	Highest
60	1	1	PI/2 BPSK	23.47	23.57	23.27
60	1	160		23.97	23.17	23.37
60	81	40		23.67	23.37	23.47
60	1	0		23.47	23.57	23.27
60	1	161		23.97	23.17	23.07
60	162	0		23.77	23.37	23.37
60	1	1	QPSK	23.57	23.47	23.27
60	1	160		23.57	23.17	22.87
60	81	40		23.27	23.37	23.37
60	1	0		23.27	23.57	23.27
60	1	161		23.77	23.17	23.17
60	162	0		23.77	23.37	23.17
60	1	1	16-QAM	23.57	23.77	23.27
60	1	1	64-QAM	23.67	22.47	21.87
60	1	1	256-QAM	22.27	20.17	19.87



NR n41 Maximum Average Power [dBm]						
BW [MHz]	RB Size	RB Offset	Mod	Lowest	Middle	Highest
80	1	1	PI/2 BPSK	23.47	23.67	23.47
80	1	215		23.87	23.17	23.37
80	108	54		23.97	23.37	23.37
80	1	0		23.47	23.67	23.57
80	1	216		23.87	23.17	23.37
80	216	0		23.87	23.47	23.37
80	1	1	QPSK	23.57	23.67	23.47
80	1	215		23.97	23.07	23.27
80	108	54		23.97	23.37	23.37
80	1	0		23.57	23.67	23.47
80	1	216		23.87	23.07	23.27
80	216	0		23.87	23.47	23.37
80	1	1	16-QAM	23.67	23.87	23.77
80	1	1	64-QAM	22.77	22.57	22.37
80	1	1	256-QAM	21.17	20.37	20.07

NR n41 Maximum Average Power [dBm]						
BW [MHz]	RB Size	RB Offset	Mod	Lowest	Middle	Highest
90	1	1	PI/2 BPSK	23.67	23.77	23.57
90	1	243		23.57	23.27	23.37
90	120	60		23.97	23.77	23.37
90	1	0		23.67	23.77	23.57
90	1	244		23.17	23.17	23.37
90	240	0		23.97	23.37	23.37
90	1	1	QPSK	23.77	23.77	23.47
90	1	243		23.77	23.17	23.37
90	120	60		23.97	23.37	23.37
90	1	0		23.77	23.77	23.47
90	1	244		23.27	23.17	22.77
90	240	0		23.97	23.37	23.37
90	1	1	16-QAM	23.87	23.87	23.77
90	1	1	64-QAM	23.17	22.57	22.37
90	1	1	256-QAM	21.57	20.37	20.17



NR n41 Maximum Average Power [dBm]						
BW [MHz]	RB Size	RB Offset	Mod	Lowest	Middle	Highest
100	1	1	PI/2 BPSK	23.57	23.77	23.47
100	1	271		23.37	23.17	23.37
100	135	67		23.97	23.27	23.27
100	1	0		23.57	23.67	23.57
100	1	272		23.47	23.17	23.07
100	270	0		23.97	23.37	23.37
100	1	1	QPSK	23.57	23.67	23.47
100	1	271		23.37	23.07	23.37
100	135	67		23.97	23.27	23.27
100	1	0		23.57	23.67	23.47
100	1	272		23.37	23.17	22.77
100	270	0		23.97	23.37	23.37
100	1	1	16-QAM	23.67	23.87	23.77
100	1	1	64-QAM	23.57	22.57	22.27
100	1	1	256-QAM	21.97	20.37	20.17



<CP-OFDM>

NR n5 Maximum Average Power [dBm]						
BW [MHz]	RB Size	RB Offset	Mod	Lowest	Middle	Highest
5	1	1	QPSK	22.76	23.06	21.46
5	1	1	16-QAM	22.06	22.46	20.86
5	1	1	64-QAM	20.96	21.06	19.66
5	1	1	256-QAM	18.36	18.26	17.36

BW [MHz]	RB Size	RB Offset	Mod	Lowest	Middle	Highest
10	1	1	QPSK	22.46	22.36	22.56
10	1	1	16-QAM	21.76	21.66	21.86
10	1	1	64-QAM	20.66	20.96	21.06
10	1	1	256-QAM	18.56	18.16	18.26

NR n5 Maximum Average Power [dBm]						
BW [MHz]	RB Size	RB Offset	Mod	Lowest	Middle	Highest
15	1	1	QPSK	22.86	22.46	23.16
15	1	1	16-QAM	22.46	22.06	22.56
15	1	1	64-QAM	21.26	21.06	21.16
15	1	1	256-QAM	18.36	18.16	18.26

NR n5 Maximum Average Power [dBm]						
BW [MHz]	RB Size	RB Offset	Mod	Lowest	Middle	Highest
20	1	1	QPSK	22.65	22.35	22.05
20	1	1	16-QAM	22.55	22.25	21.95
20	1	1	64-QAM	21.05	20.95	20.95
20	1	1	256-QAM	18.05	18.15	18.15



NR n71 Maximum Average Power [dBm]						
BW [MHz]	RB Size	RB Offset	Mod	Lowest	Middle	Highest
5	1	1	QPSK	23.33	23.03	22.73
5	1	1	16-QAM	22.93	22.63	22.43
5	1	1	64-QAM	21.83	21.33	21.23
5	1	1	256-QAM	18.63	18.13	18.03

NR n71 Maximum Average Power [dBm]						
BW [MHz]	RB Size	RB Offset	Mod	Lowest	Middle	Highest
10	1	1	QPSK	22.93	22.73	22.73
10	1	1	16-QAM	22.83	22.63	22.43
10	1	1	64-QAM	21.53	21.23	21.23
10	1	1	256-QAM	18.23	17.93	18.03

NR n71 Maximum Average Power [dBm]						
BW [MHz]	RB Size	RB Offset	Mod	Lowest	Middle	Highest
15	1	1	QPSK	23.23	22.83	22.73
15	1	1	16-QAM	22.73	22.73	22.33
15	1	1	64-QAM	21.33	21.33	20.93
15	1	1	256-QAM	18.23	18.03	18.03

NR n71 Maximum Average Power [dBm]						
BW [MHz]	RB Size	RB Offset	Mod	Lowest	Middle	Highest
20	1	1	QPSK	22.13	22.93	22.73
20	1	1	16-QAM	21.83	22.63	22.43
20	1	1	64-QAM	20.93	21.13	21.13
20	1	1	256-QAM	18.23	18.03	18.03



NR n41 Maximum Average Power [dBm]						
BW [MHz]	RB Size	RB Offset	Mod	Lowest	Middle	Highest
20	1	1	QPSK	23.47	22.77	22.87
20	1	1	16-QAM	23.37	22.67	22.77
20	1	1	64-QAM	22.67	21.37	21.37
20	1	1	256-QAM	20.37	17.97	17.97

NR n41 Maximum Average Power [dBm]						
BW [MHz]	RB Size	RB Offset	Mod	Lowest	Middle	Highest
40	1	1	QPSK	23.77	23.17	23.07
40	1	1	16-QAM	23.47	23.17	22.97
40	1	1	64-QAM	22.77	21.77	21.67
40	1	1	256-QAM	20.37	18.37	18.37

NR n41 Maximum Average Power [dBm]						
BW [MHz]	RB Size	RB Offset	Mod	Lowest	Middle	Highest
50	1	1	QPSK	22.67	22.87	22.67
50	1	1	16-QAM	22.37	22.67	22.47
50	1	1	64-QAM	21.57	21.37	21.37
50	1	1	256-QAM	19.57	17.97	17.97

NR n41 Maximum Average Power [dBm]						
BW [MHz]	RB Size	RB Offset	Mod	Lowest	Middle	Highest
60	1	1	QPSK	23.37	22.97	22.47
60	1	1	16-QAM	23.67	22.77	23.47
60	1	1	64-QAM	22.97	21.07	21.07
60	1	1	256-QAM	20.67	18.27	17.67



NR n41 Maximum Average Power [dBm]						
BW [MHz]	RB Size	RB Offset	Mod	Lowest	Middle	Highest
80	1	1	QPSK	23.07	23.07	22.77
80	1	1	16-QAM	22.77	22.97	22.67
80	1	1	64-QAM	22.07	21.17	20.97
80	1	1	256-QAM	19.67	18.47	18.17

NR n41 Maximum Average Power [dBm]						
BW [MHz]	RB Size	RB Offset	Mod	Lowest	Middle	Highest
90	1	1	QPSK	23.57	23.17	22.87
90	1	1	16-QAM	23.57	22.97	22.77
90	1	1	64-QAM	22.87	21.27	21.07
90	1	1	256-QAM	20.57	18.47	18.27

NR n41 Maximum Average Power [dBm]						
BW [MHz]	RB Size	RB Offset	Mod	Lowest	Middle	Highest
100	1	1	QPSK	23.47	23.07	22.87
100	1	1	16-QAM	23.47	22.87	22.84
100	1	1	64-QAM	22.77	21.17	20.97
100	1	1	256-QAM	20.37	18.37	18.17



FR1 n5

Peak-to-Average Ratio

Mode	FR1 n5 / 20MHz / DFT-S OFDM				
Mod.	PI/2 BPSK	QPSK	16QAM	64QAM	Limit: 13dB
RB Size	Full RB	Full RB	Full RB	Full RB	Result
Middle CH	3.28	4.49	5.62	5.94	PASS
Mode	FR1 n5 / 20MHz / DFT-S OFDM				
Mod.	256QAM				Limit: 13dB
RB Size	Full RB				Result
Middle CH	6.61				PASS



FR1 n5 / 20MHz / DFT-S OFDM / Middle Channel / Full RB

PI/2 BPSK

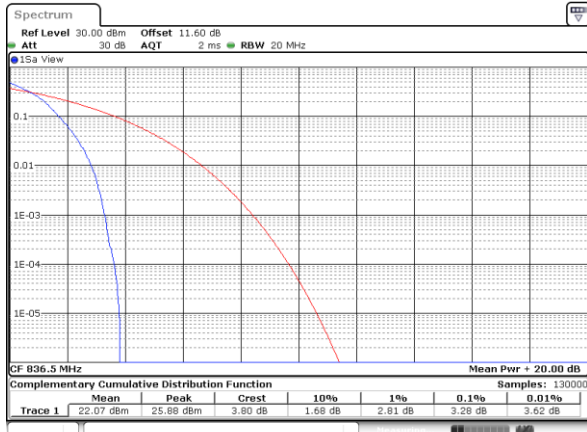

Date: 16.OCT.2020 11:41:03

QPSK

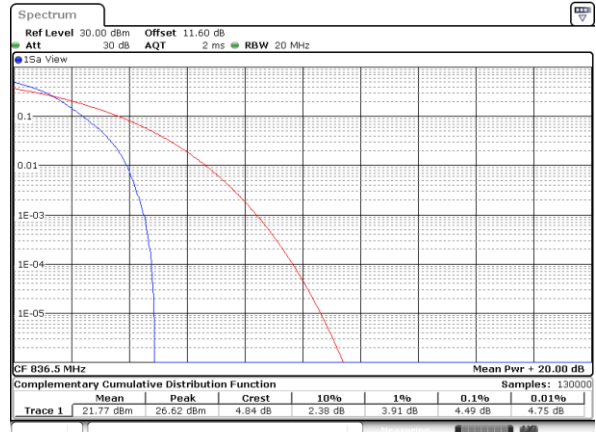

Date: 16.OCT.2020 11:39:27

16QAM

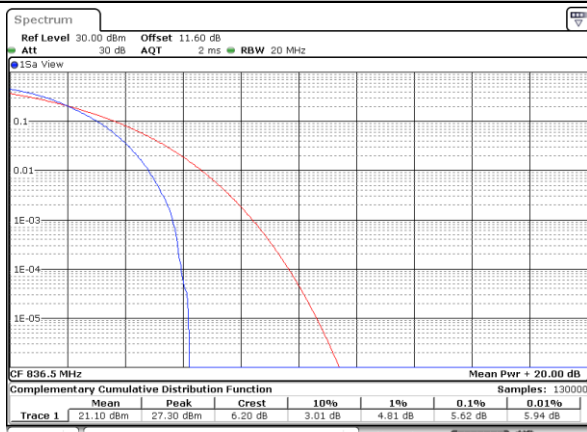

Date: 16.OCT.2020 11:39:42

64QAM

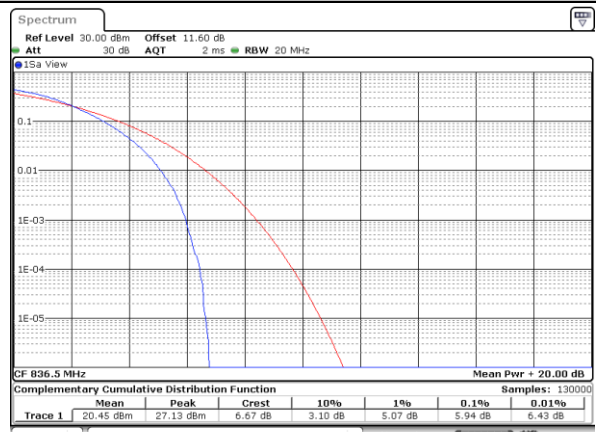

Date: 16.OCT.2020 11:39:55

256QAM

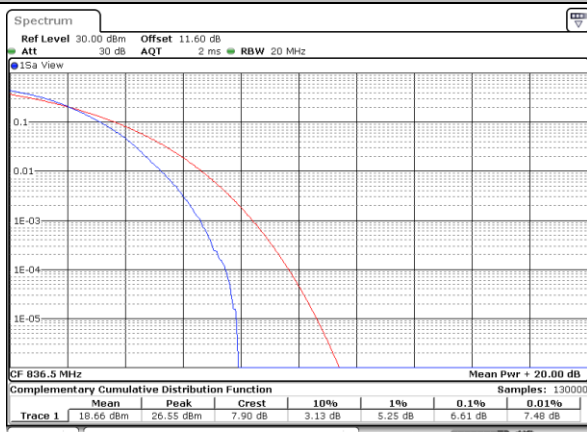

Date: 16.OCT.2020 11:40:09



26dB Bandwidth

Mode	FR1 n5 : 26dB BW(MHz) / DFT-S OFDM							
BW	5MHz		10MHz		15MHz		20MHz	
Mod.	PI/2 BPSK		PI/2 BPSK		PI/2 BPSK		PI/2 BPSK	
Middle CH	5.06		9.41		14.30		18.74	

Mode	FR1 n5 : 26dB BW(MHz) / CP OFDM							
BW	5MHz		10MHz		15MHz		20MHz	
Mod.	QPSK	16QAM	QPSK	16QAM	QPSK	16QAM	QPSK	16QAM
Middle CH	5.05	4.89	9.87	9.87	14.99	15.17	19.78	19.74
Mod.	64QAM	256QAM	64QAM	256QAM	64QAM	256QAM	64QAM	256QAM
Middle CH	4.99	4.96	9.71	9.93	14.90	14.90	19.74	19.74



FR1 n5 / 5MHz / DFT-S OFDM / Middle Channel

PI/2 BPSK

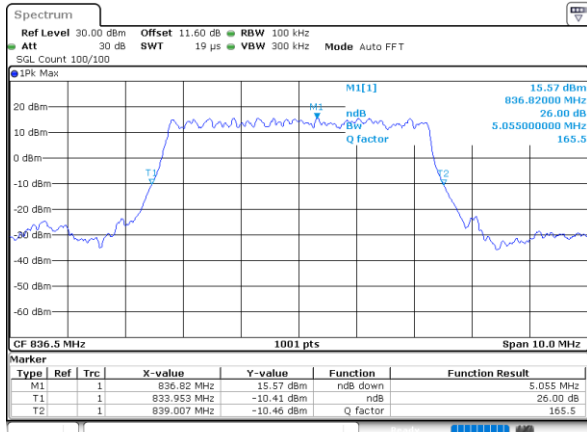

Date: 16.OCT.2020 14:53:36

FR1 n5 / 5MHz / CP OFDM / Middle Channel

QPSK

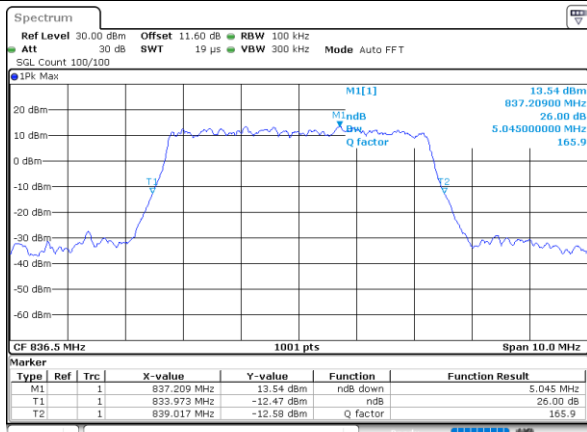

Date: 16.OCT.2020 14:54:09

16QAM

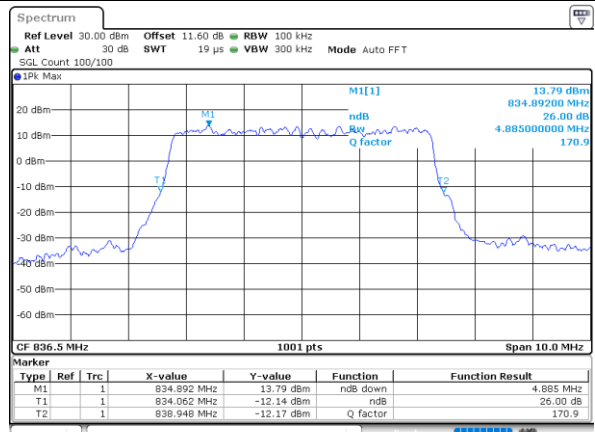

Date: 16.OCT.2020 14:54:28

64QAM

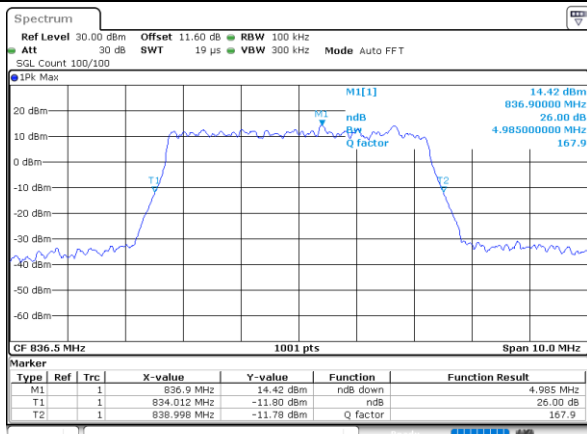

Date: 16.OCT.2020 14:54:50

256QAM

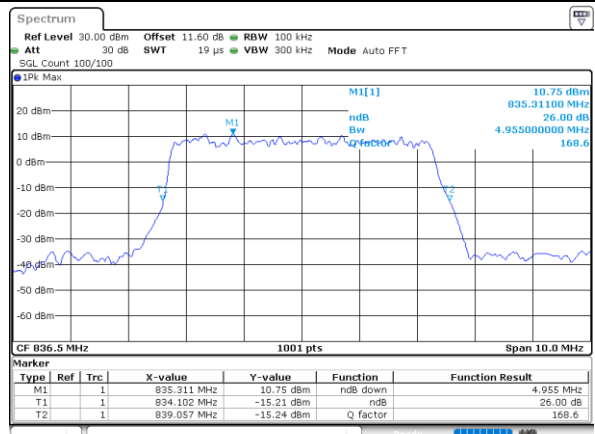

Date: 16.OCT.2020 14:55:11



FR1 n5 / 10MHz / DFT-S OFDM / Middle Channel

PI/2 BPSK

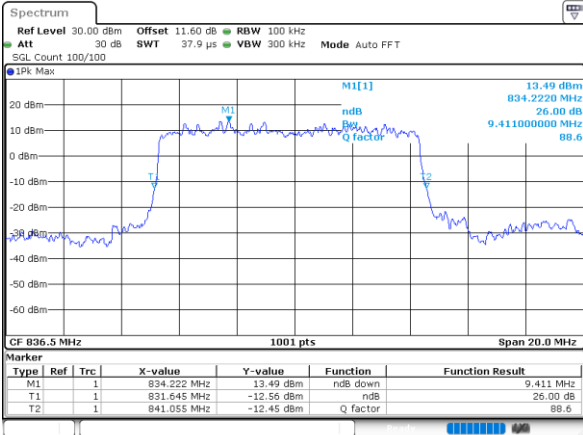

Date: 16.OCT.2020 14:28:59

FR1 n5 / 10MHz / CP OFDM / Middle Channel

QPSK

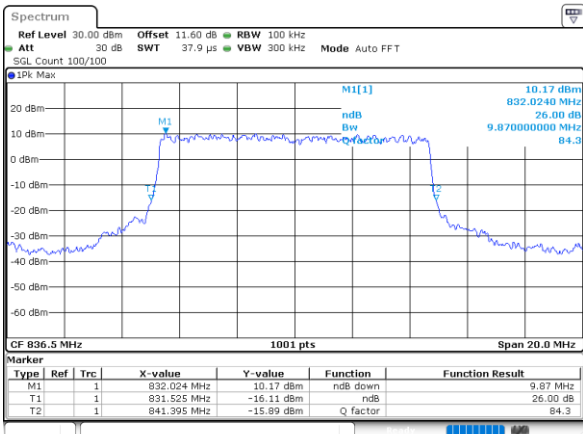

Date: 16.OCT.2020 14:29:43

16QAM

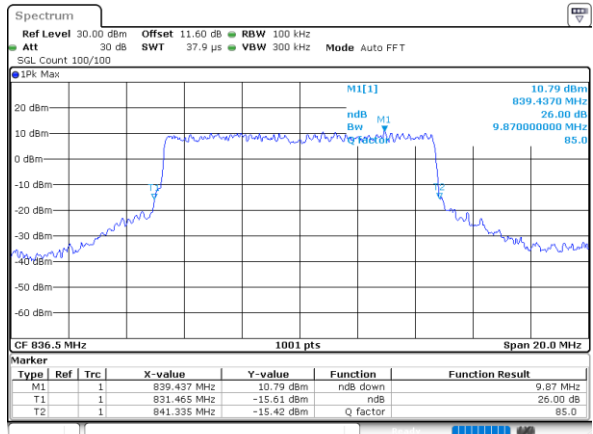

Date: 16.OCT.2020 14:30:03

64QAM

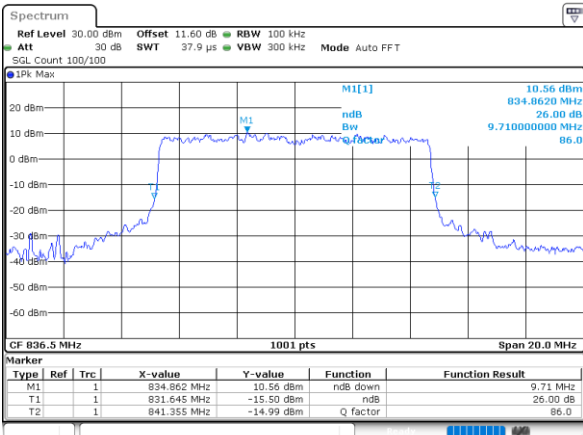

Date: 16.OCT.2020 14:30:28

256QAM

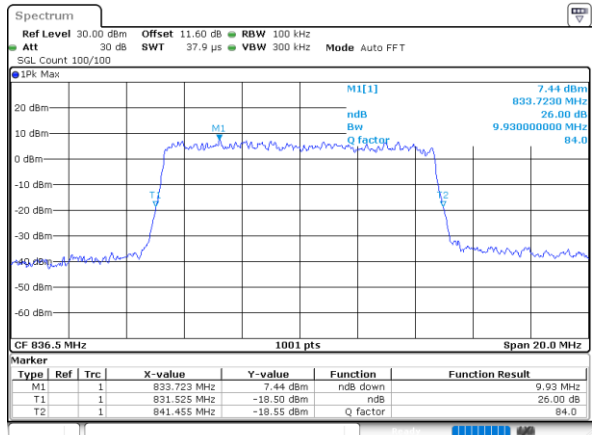

Date: 16.OCT.2020 14:30:47



FR1 n5 / 15MHz / DFT-S OFDM / Middle Channel

PI/2 BPSK

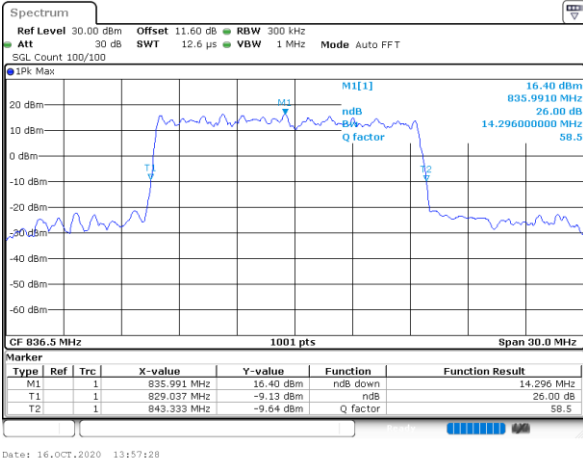

Date: 16.OCT.2020 13:57:28

FR1 n5 / 15MHz / CP OFDM / Middle Channel

QPSK

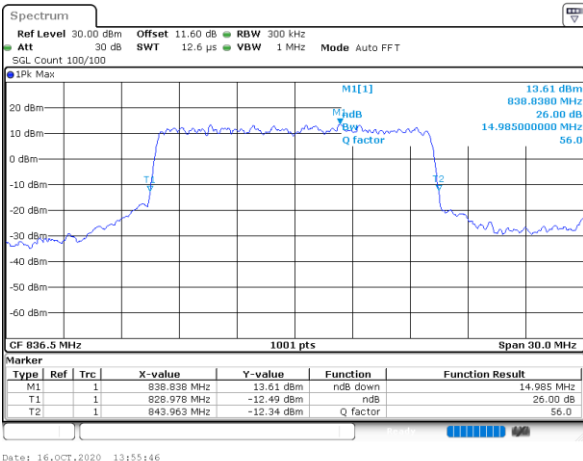

Date: 16.OCT.2020 13:55:46

16QAM

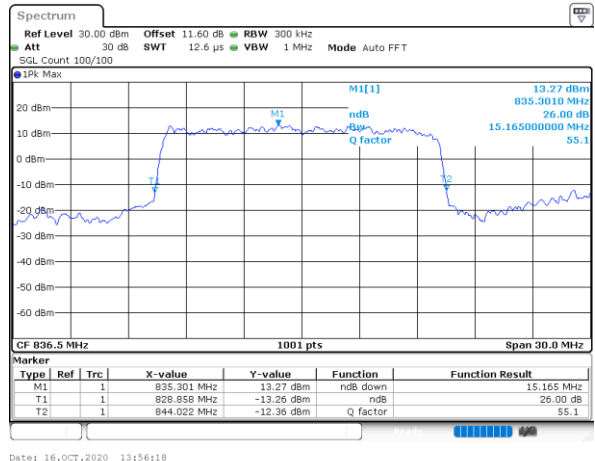

Date: 16.OCT.2020 13:56:18

64QAM

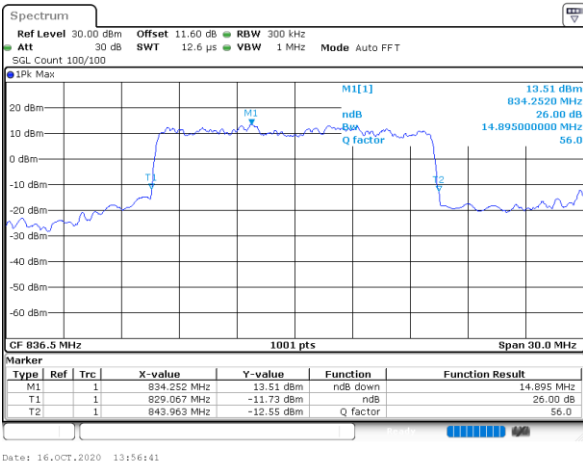

Date: 16.OCT.2020 13:56:41

256QAM

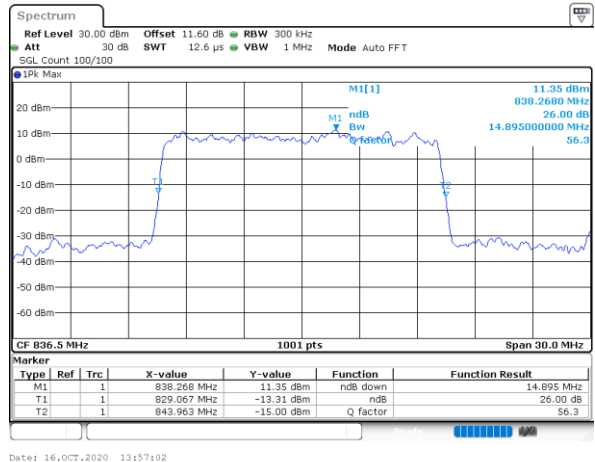

Date: 16.OCT.2020 13:57:02



FR1 n5 / 20MHz / DFT-S OFDM / Middle Channel

PI/2 BPSK

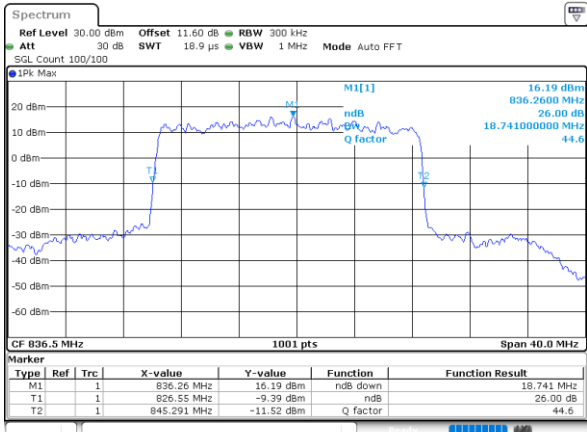

Date: 16.OCT.2020 11:41:58

FR1 n5 / 20MHz / CP OFDM

QPSK

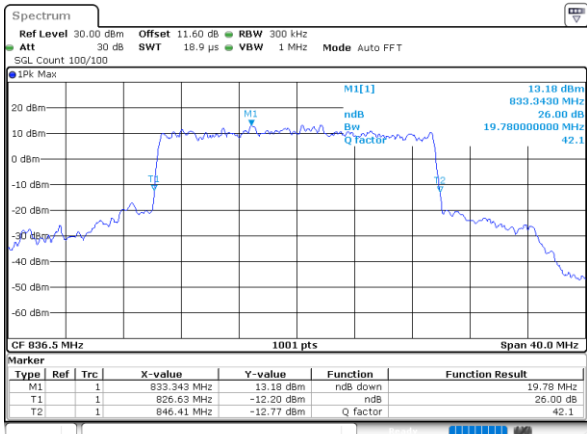

Date: 16.OCT.2020 11:42:37

16QAM

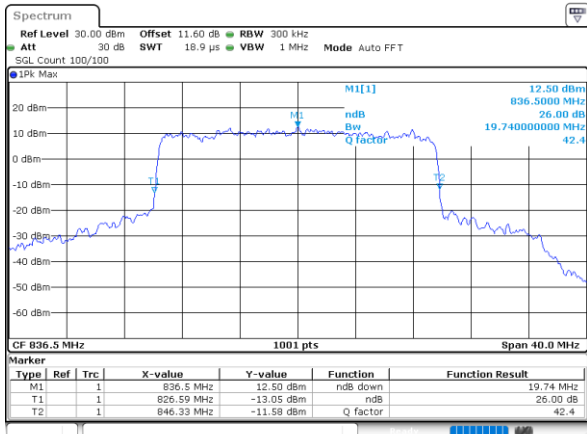

Date: 16.OCT.2020 11:42:57

64QAM

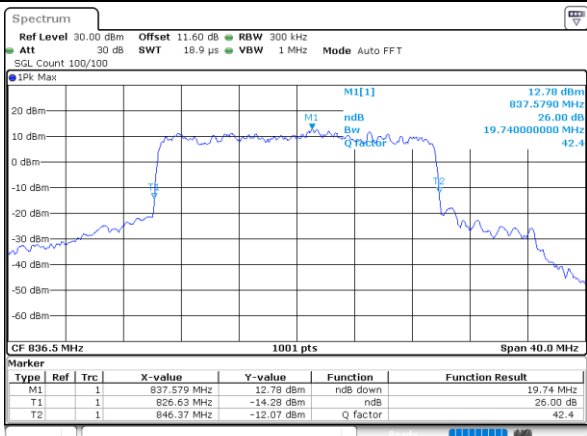

Date: 16.OCT.2020 11:43:17

256QAM

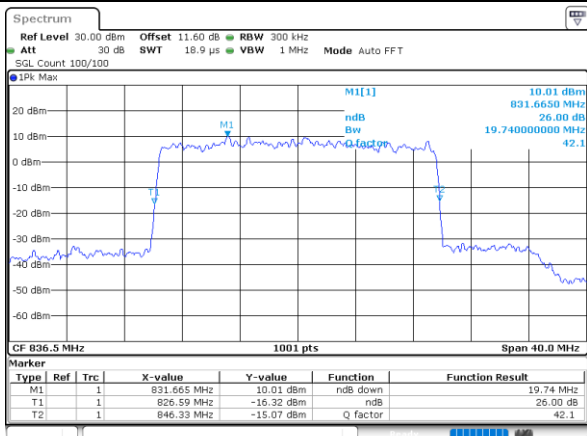

Date: 16.OCT.2020 11:43:38



Occupied Bandwidth

Mode	FR1 n5 : 99%OBW(MHz) / DFT-S OFDM							
BW	5MHz		10MHz		15MHz		20MHz	
Mod.	PI/2 BPSK		PI/2 BPSK		PI/2 BPSK		PI/2 BPSK	
Middle CH	4.49		8.89		13.34		17.86	

Mode	FR1 n5 : 99%OBW (MHz) / CP OFDM							
BW	5MHz		10MHz		15MHz		20MHz	
Mod.	QPSK	16QAM	QPSK	16QAM	QPSK	16QAM	QPSK	16QAM
Middle CH	4.49	4.50	9.29	9.25	14.15	14.21	18.82	18.94
Mod.	64QAM	256QAM	64QAM	256QAM	64QAM	256QAM	64QAM	256QAM
Middle CH	4.48	4.50	9.27	9.27	14.18	14.06	18.86	18.90



FR1 n5 / 5MHz / DFT-S OFDM / Middle Channel

PI/2 BPSK

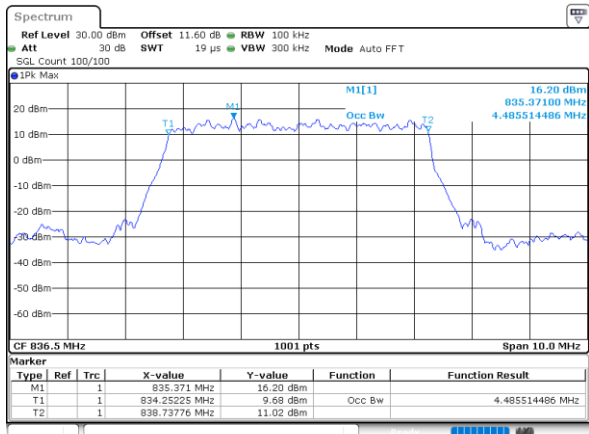

Date: 16.OCT.2020 14:53:22

FR1 n5 / 5MHz / CP OFDM

QPSK

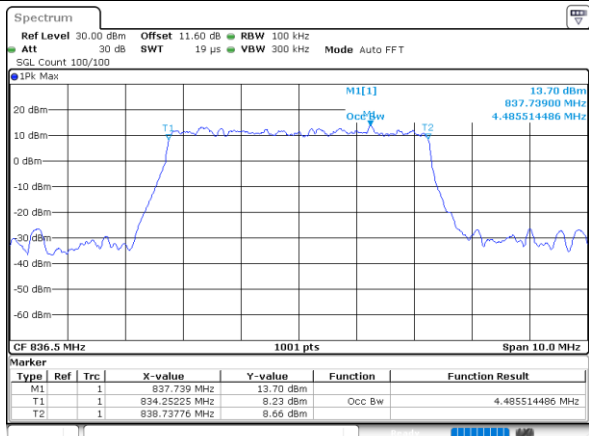

Date: 16.OCT.2020 14:54:03

16QAM

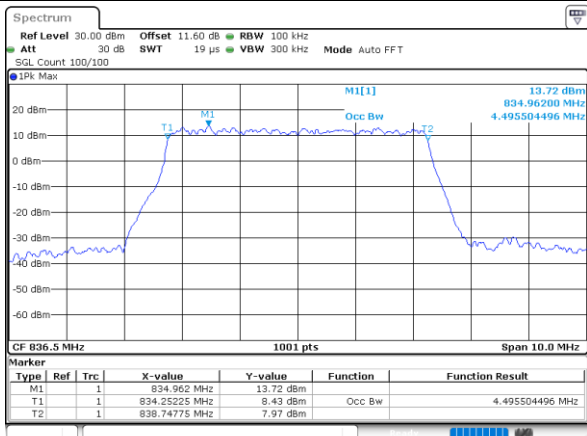

Date: 16.OCT.2020 14:54:22

64QAM

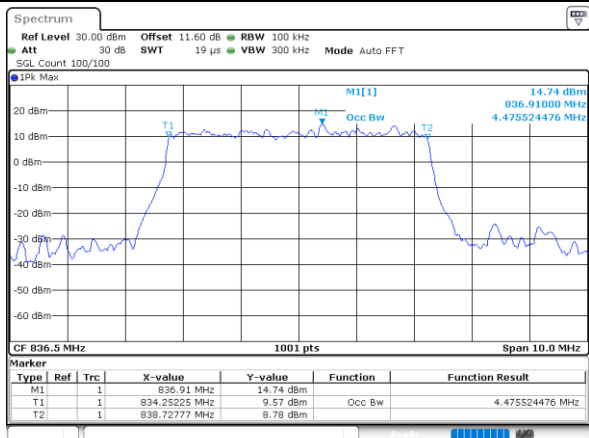

Date: 16.OCT.2020 14:54:43

256QAM

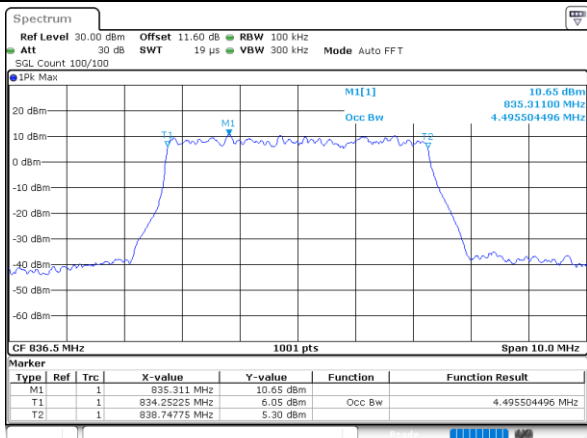

Date: 16.OCT.2020 14:55:06



FR1 n5 / 10MHz / DFT-S OFDM / Middle Channel

PI/2 BPSK

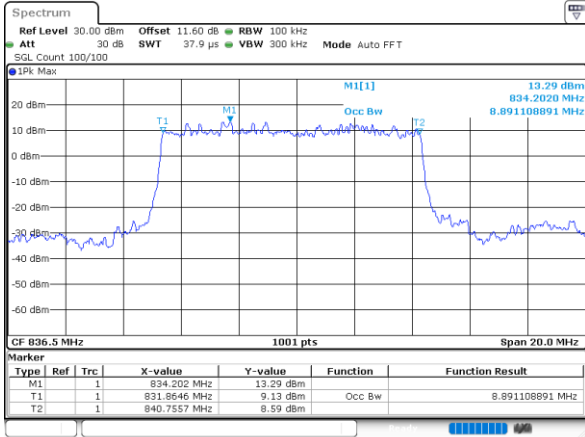

Date: 16.OCT.2020 14:28:43

FR1 n5 / 10MHz / CP OFDM

QPSK

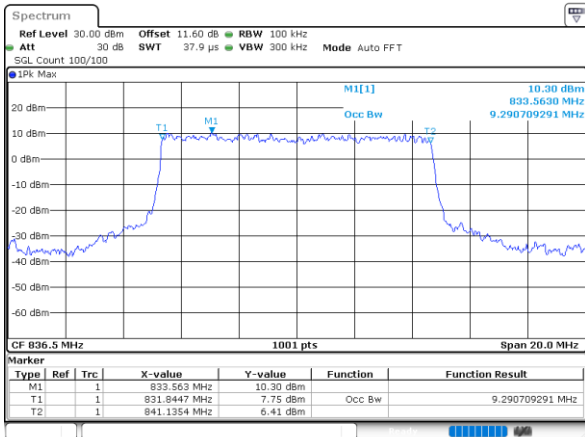

Date: 16.OCT.2020 14:29:36

16QAM

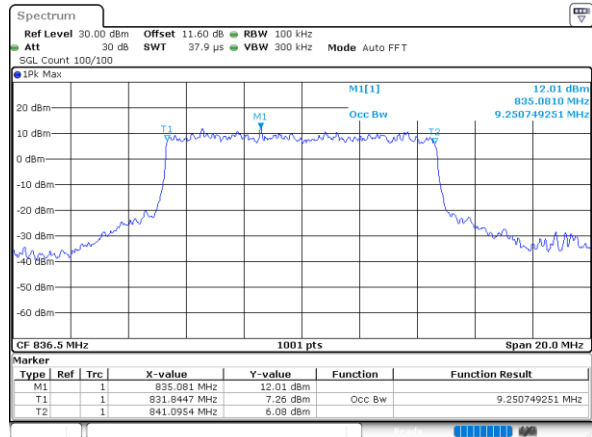

Date: 16.OCT.2020 14:29:56

64QAM

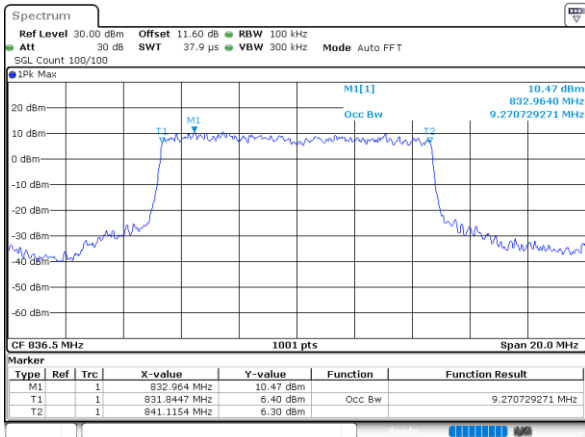

Date: 16.OCT.2020 14:30:19

256QAM

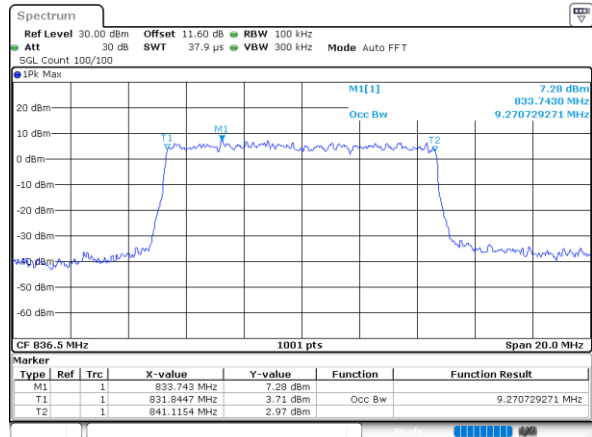

Date: 16.OCT.2020 14:30:41



FR1 n5 / 15MHz / DFT-S OFDM / Middle Channel

PI/2 BPSK

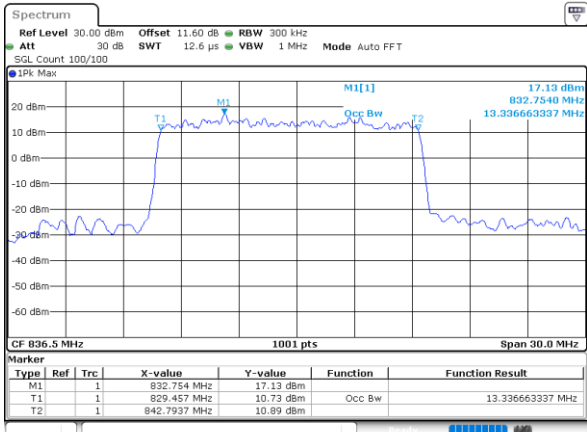

Date: 16.OCT.2020 13:57:34

FR1 n5 / 15MHz / CP OFDM

QPSK

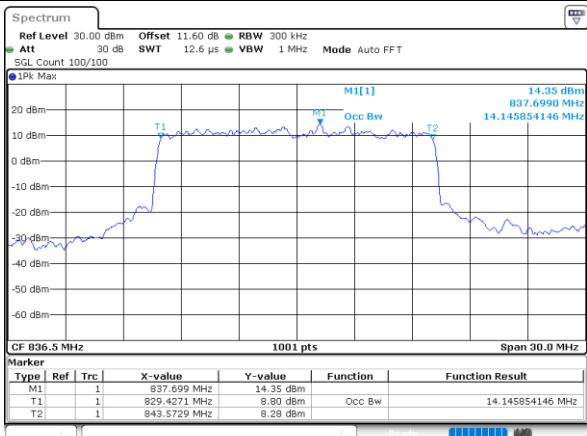

Date: 16.OCT.2020 13:55:39

16QAM

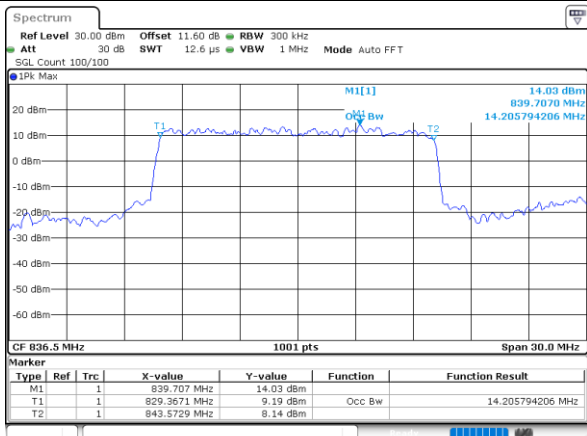

Date: 16.OCT.2020 13:56:11

64QAM

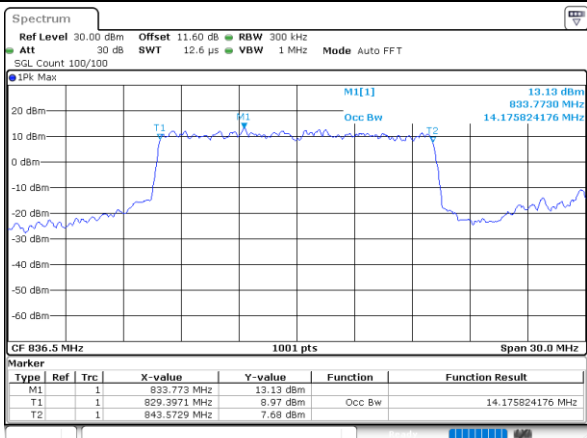

Date: 16.OCT.2020 13:56:34

256QAM

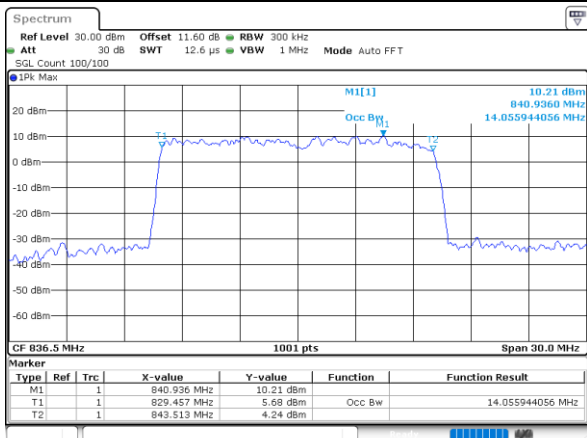

Date: 16.OCT.2020 13:56:55



FR1 n5 / 20MHz / DFT-S OFDM / Middle Channel

PI/2 BPSK

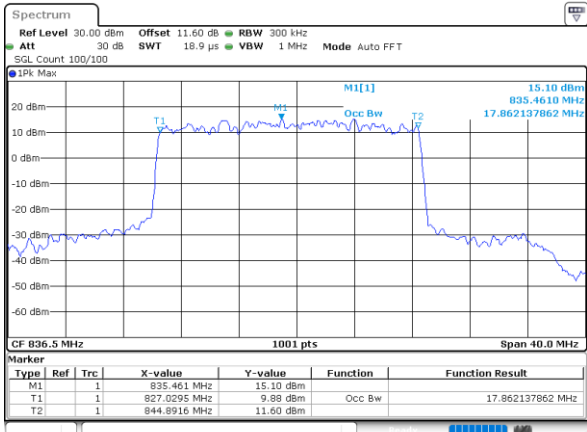

Date: 16.OCT.2020 11:41:48

FR1 n5 / 20MHz / CP OFDM

QPSK

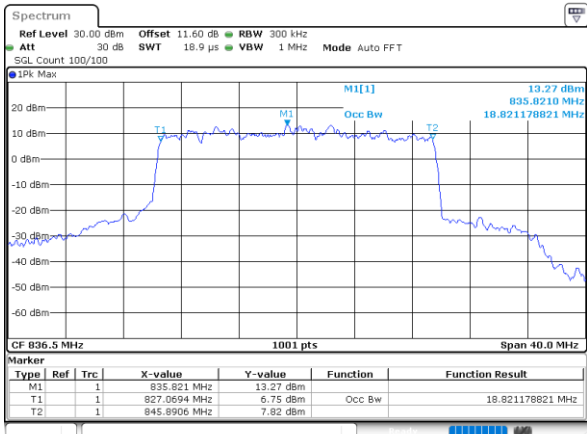

Date: 16.OCT.2020 11:42:30

16QAM

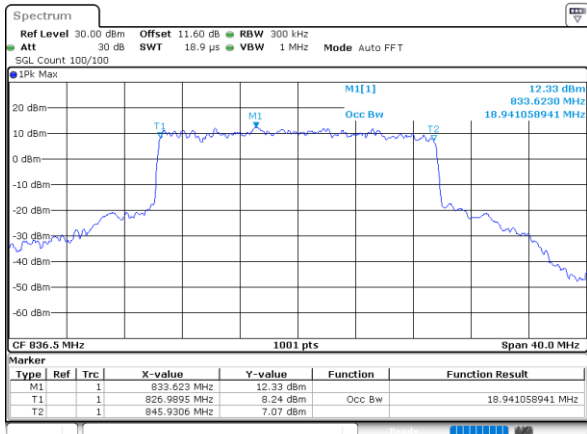

Date: 16.OCT.2020 11:42:51

64QAM

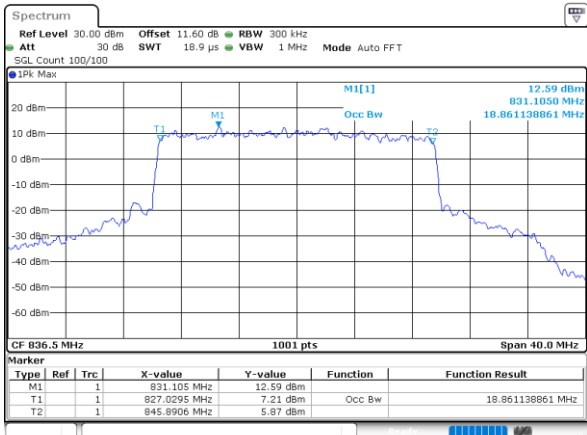

Date: 16.OCT.2020 11:43:10

256QAM

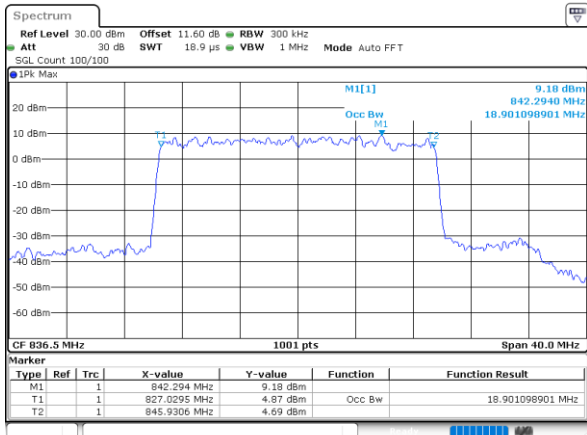

Date: 16.OCT.2020 11:43:31



Conducted Band Edge

FR1 n5 / 5MHz / DFT-S OFDM / PI/2 BPSK

Lowest Band Edge / 1RB0

Highest Band Edge / 1RBmax

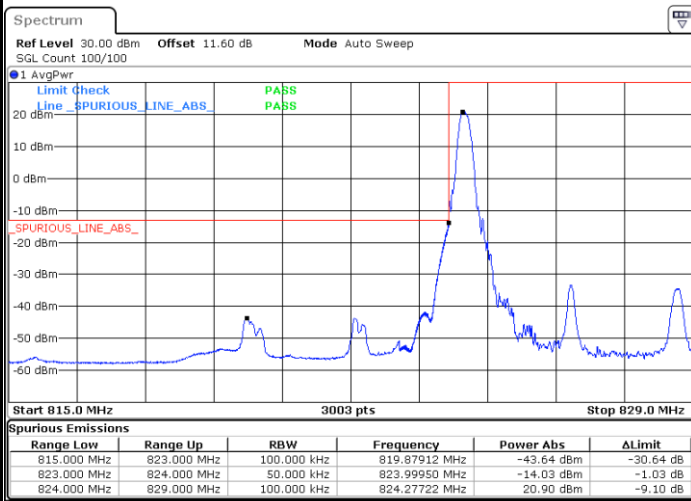

Date: 16.OCT.2020 15:00:42

Date: 16.OCT.2020 14:44:50

Lowest Band Edge / Full RB

Highest Band Edge / Full RB

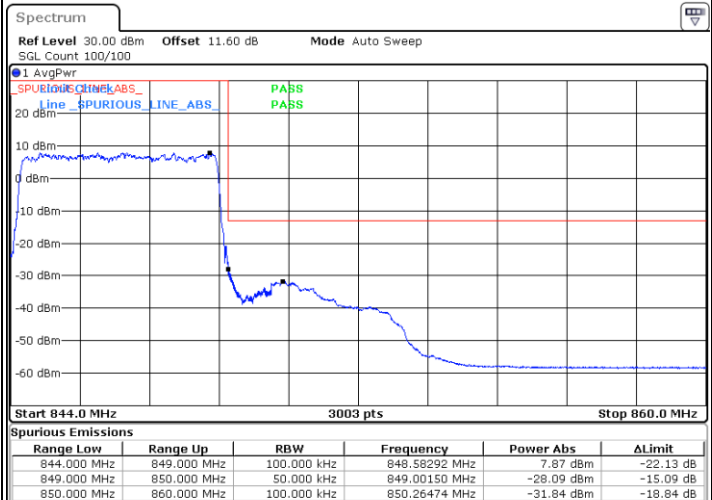
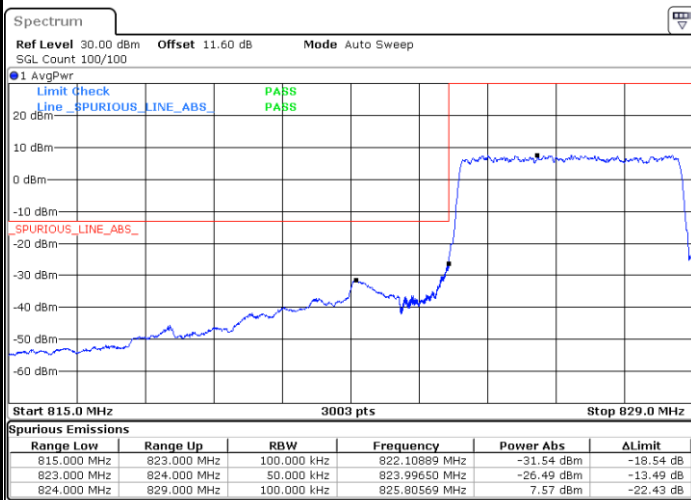

Date: 16.OCT.2020 15:06:30

Date: 16.OCT.2020 14:52:25



FR1 n5 / 5MHz / DFT-S OFDM / QPSK

Lowest Band Edge / 1RB0

Highest Band Edge / 1RBmax

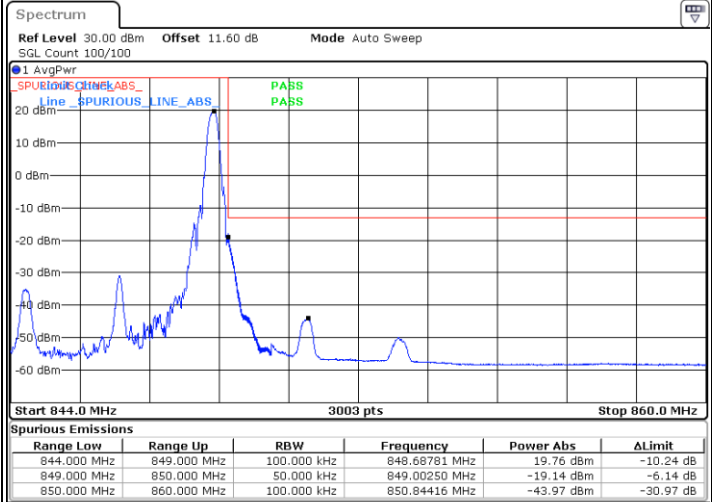
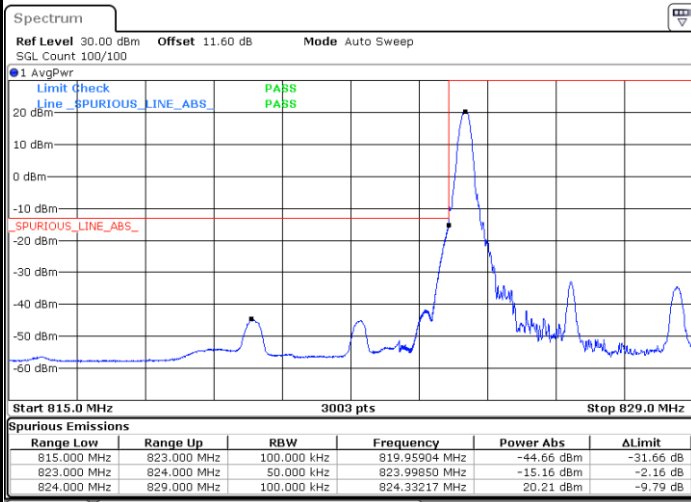

Date: 16.OCT.2020 14:59:49

Date: 16.OCT.2020 14:43:44

Lowest Band Edge / Full RB

Highest Band Edge / Full RB

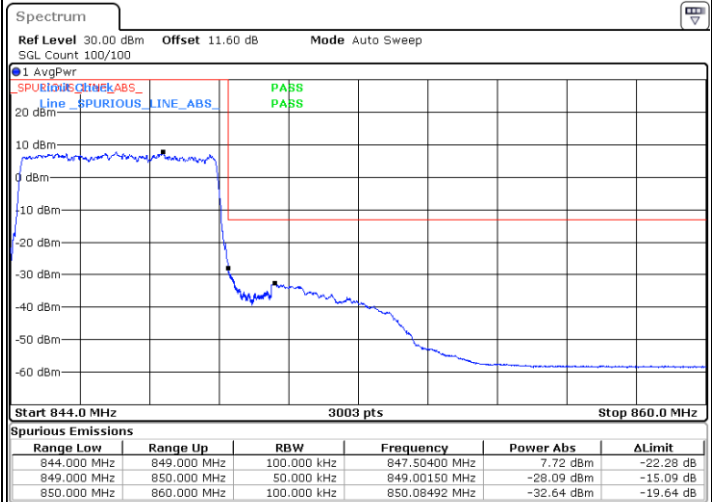
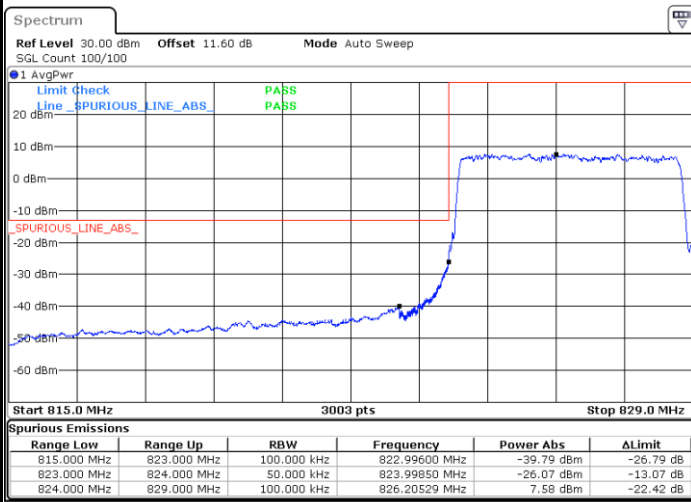

Date: 16.OCT.2020 15:05:48

Date: 16.OCT.2020 14:51:36



FR1 n5 / 5MHz / DFT-S OFDM / 16QAM

Lowest Band Edge / 1RB0

Highest Band Edge / 1RBmax

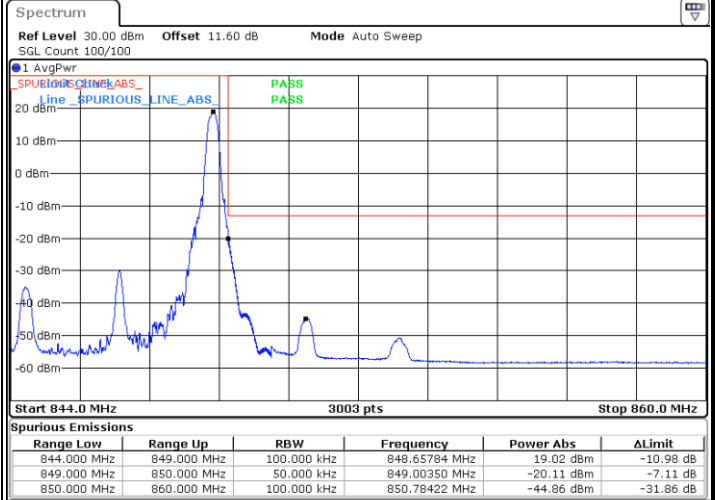
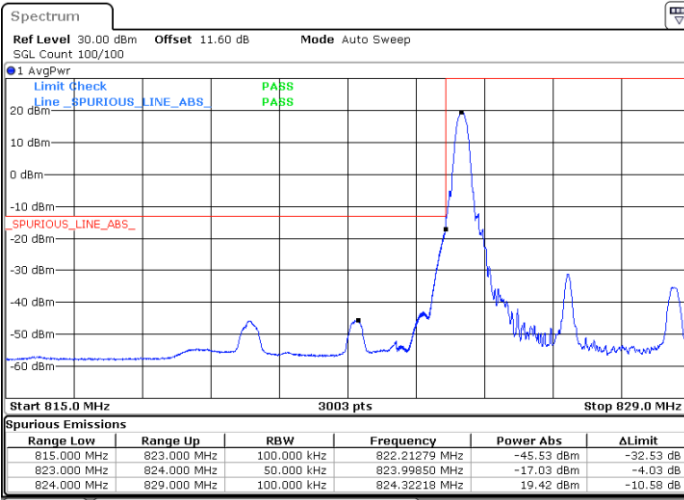

Date: 16.OCT.2020 15:01:26

Date: 16.OCT.2020 14:45:54

Lowest Band Edge / Full RB

Highest Band Edge / Full RB

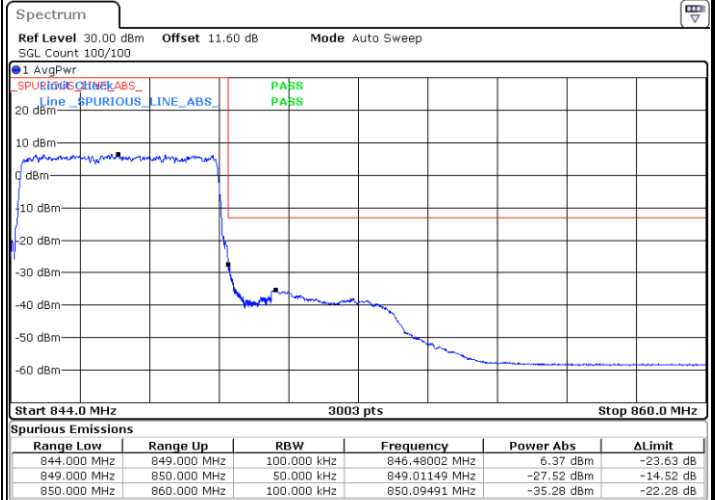
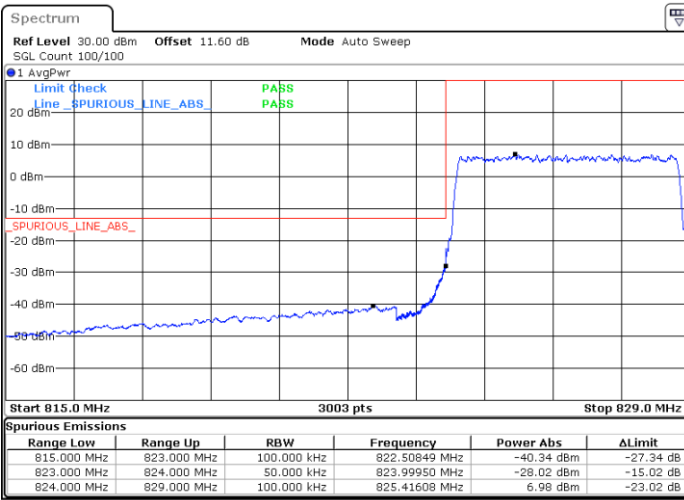

Date: 16.OCT.2020 15:05:08

Date: 16.OCT.2020 14:50:44



FR1 n5 / 5MHz / DFT-S OFDM / 64QAM

Lowest Band Edge / 1RB0

Highest Band Edge / 1RBmax

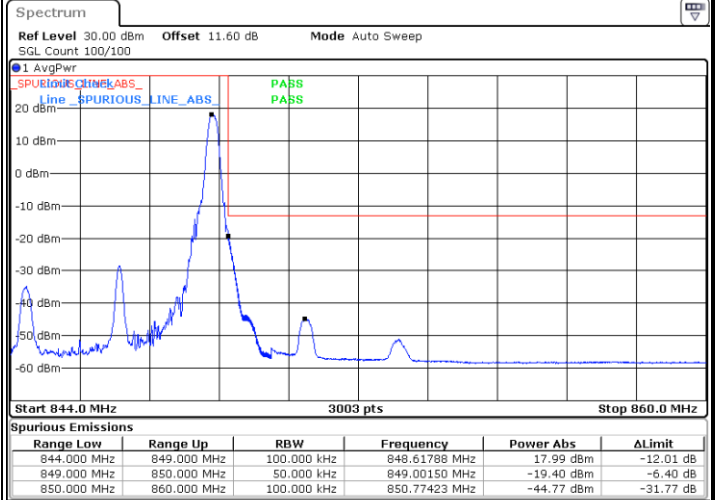
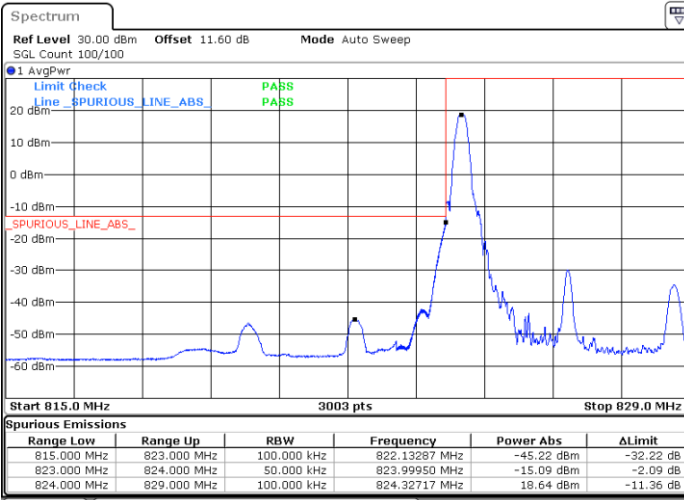

Date: 16.OCT.2020 15:02:14

Date: 16.OCT.2020 14:46:44

Lowest Band Edge / Full RB

Highest Band Edge / Full RB

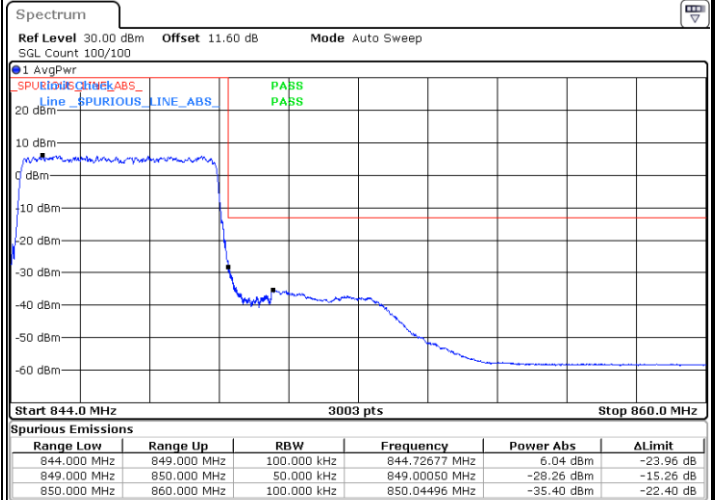
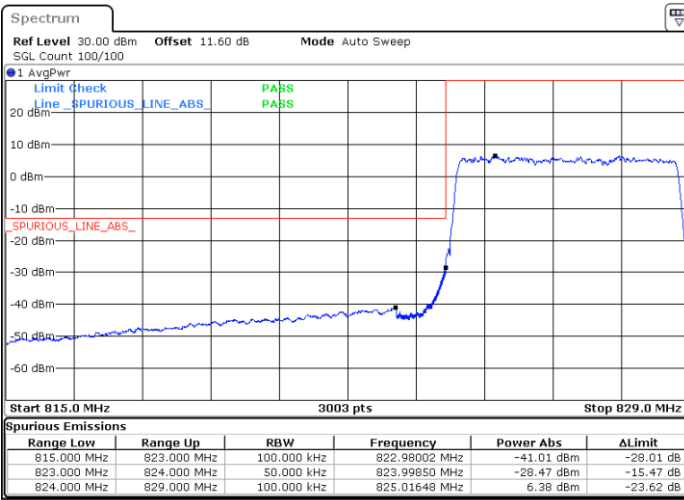

Date: 16.OCT.2020 15:04:25

Date: 16.OCT.2020 14:49:58



FR1 n5 / 5MHz / DFT-S OFDM / 256Q

Lowest Band Edge / 1RB0

Highest Band Edge / 1RBmax

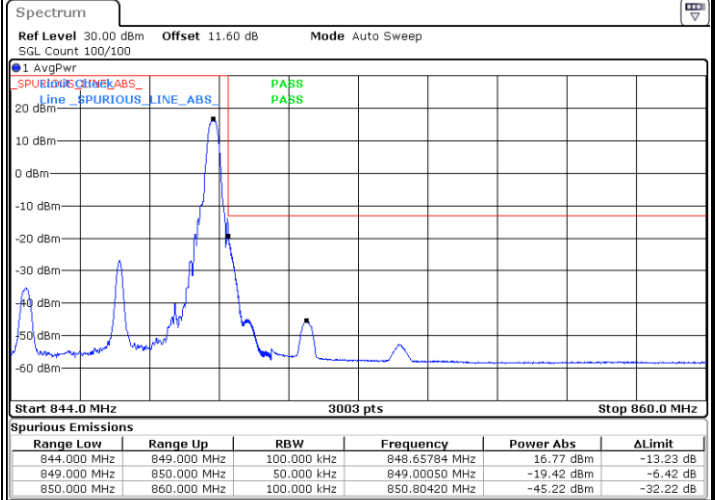
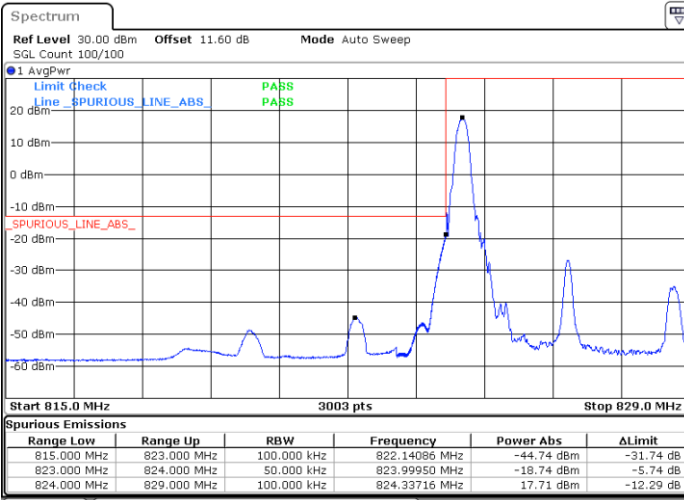

Date: 16.OCT.2020 15:02:54

Date: 16.OCT.2020 14:47:31

Lowest Band Edge / Full RB

Highest Band Edge / Full RB

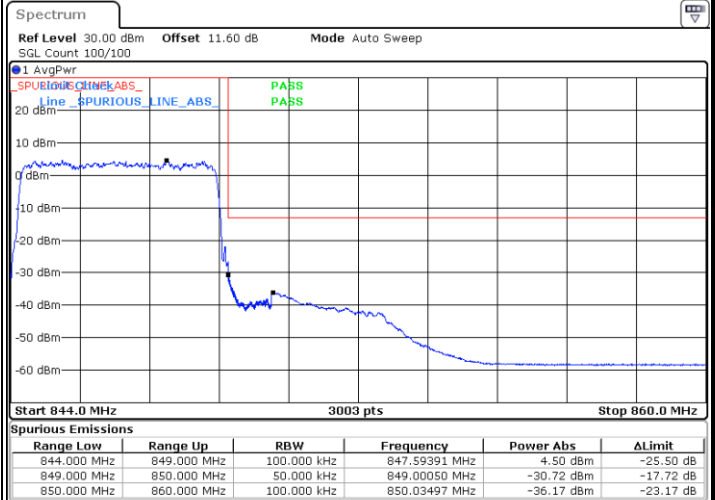
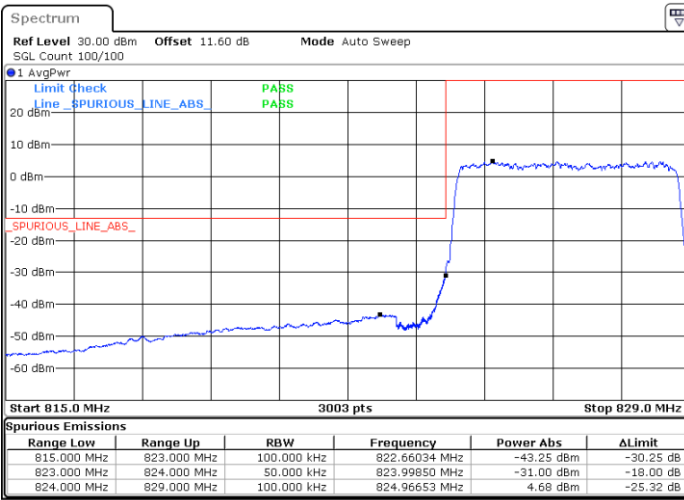

Date: 16.OCT.2020 15:03:45

Date: 16.OCT.2020 14:49:09

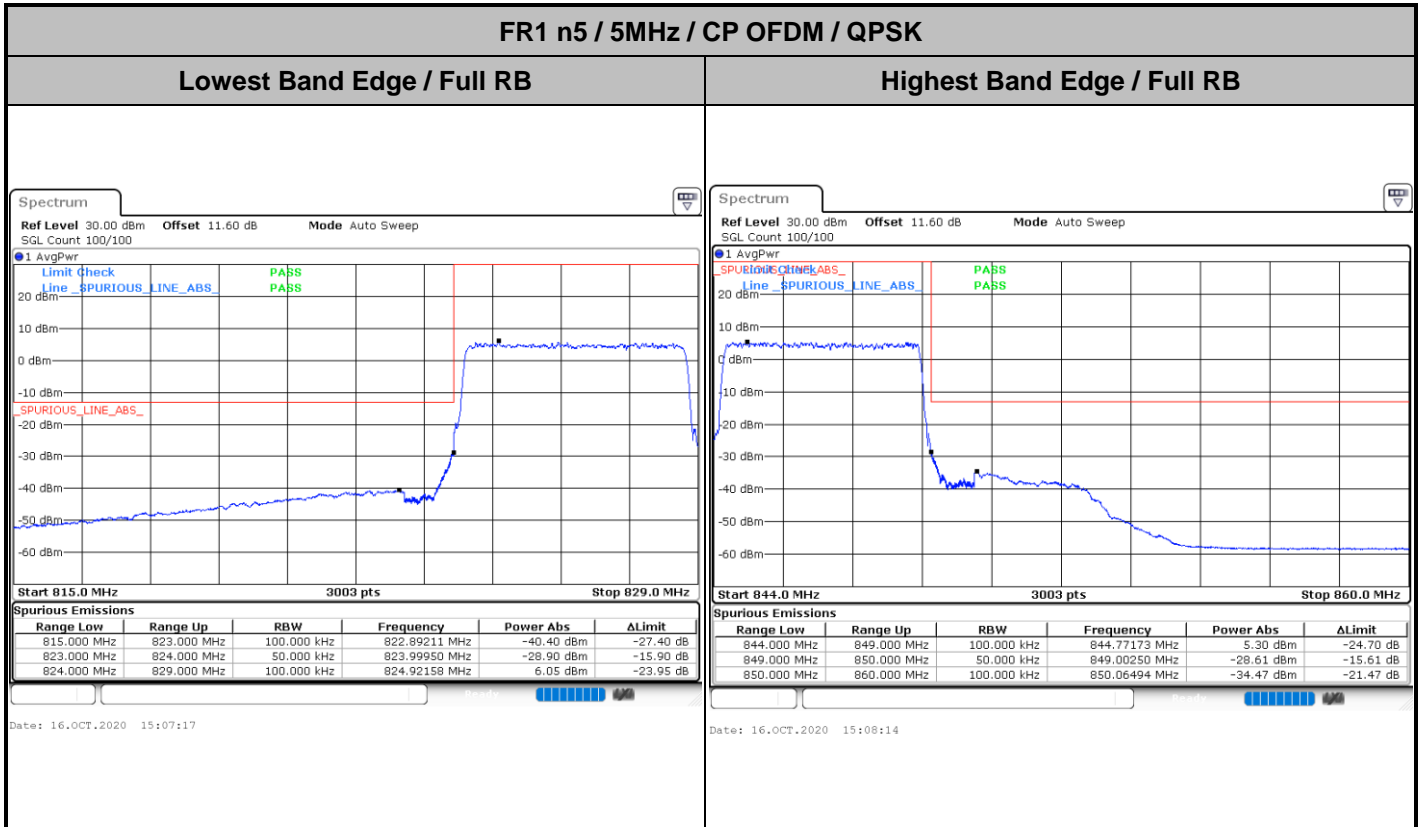



FR1 n5 / 10MHz / DFT-s-OFDM / PI/2 BPSK

Lowest Band Edge / 1RB0

Highest Band Edge / 1RBmax

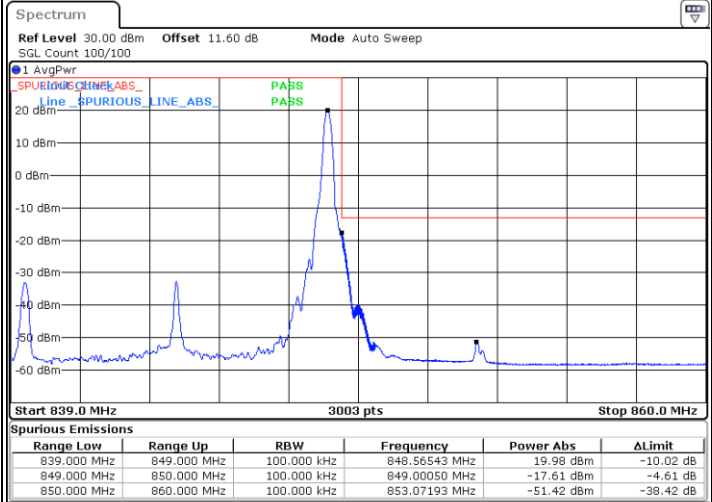
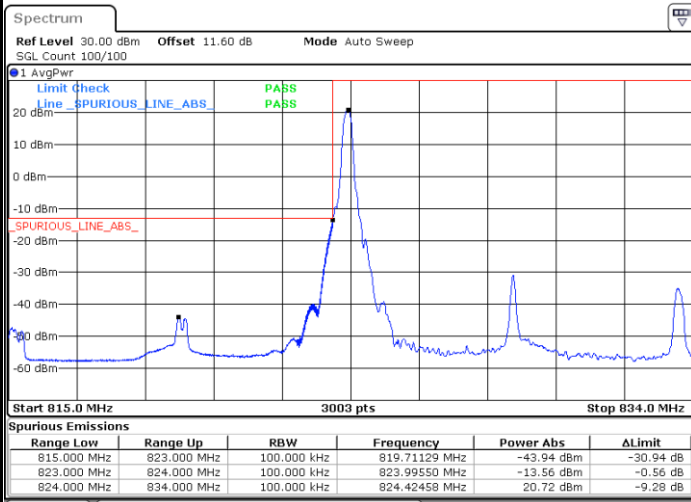

Date: 16.OCT.2020 14:21:57

Date: 16.OCT.2020 14:37:07

Lowest Band Edge / Full RB

Highest Band Edge / Full RB

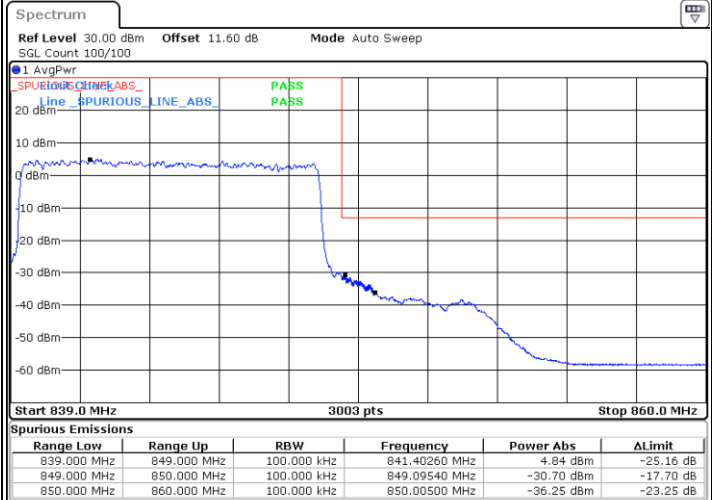
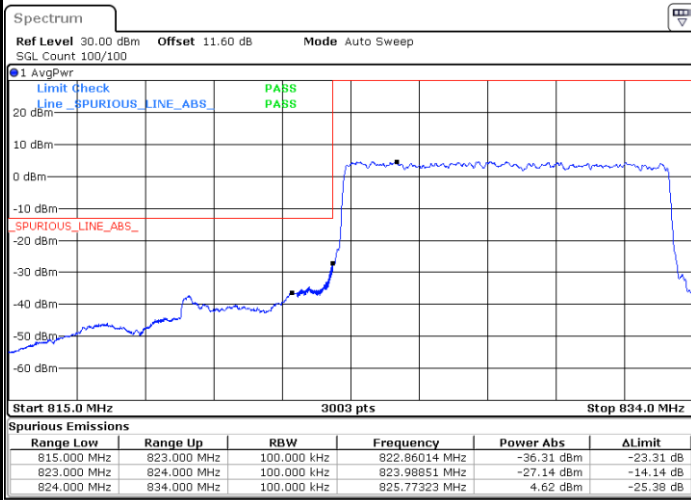

Date: 16.OCT.2020 14:11:48

Date: 16.OCT.2020 14:36:17



FR1 n5 / 10MHz / DFT-s-OFDM / QPSK

Lowest Band Edge / 1RB0

Highest Band Edge / 1RBmax

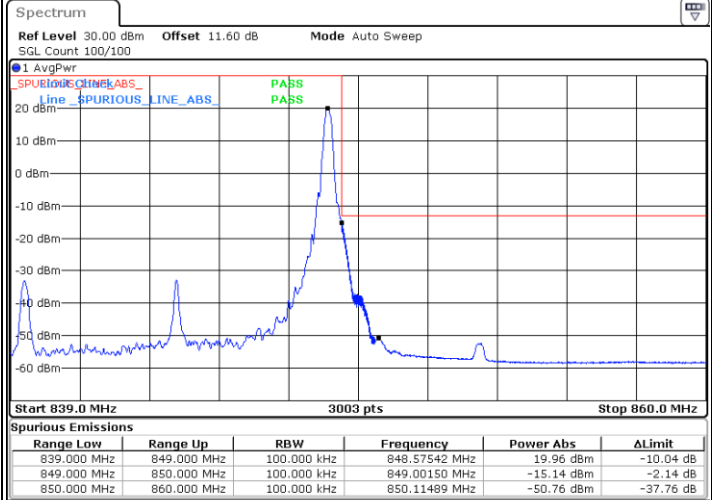
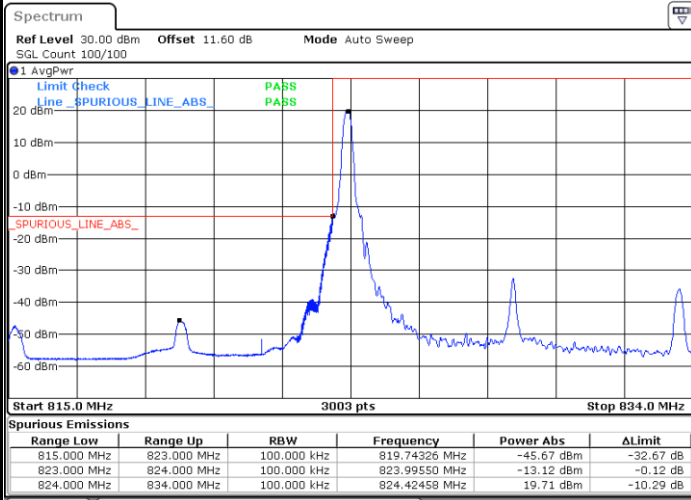

Date: 16.OCT.2020 14:21:14

Date: 16.OCT.2020 14:37:49

Lowest Band Edge / Full RB

Highest Band Edge / Full RB

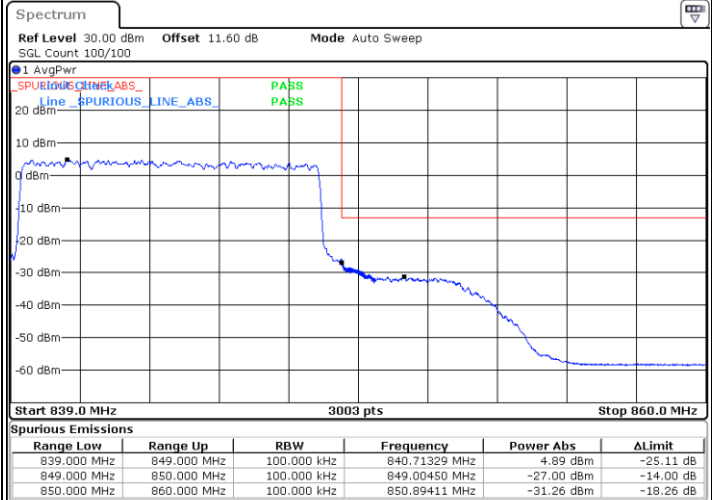
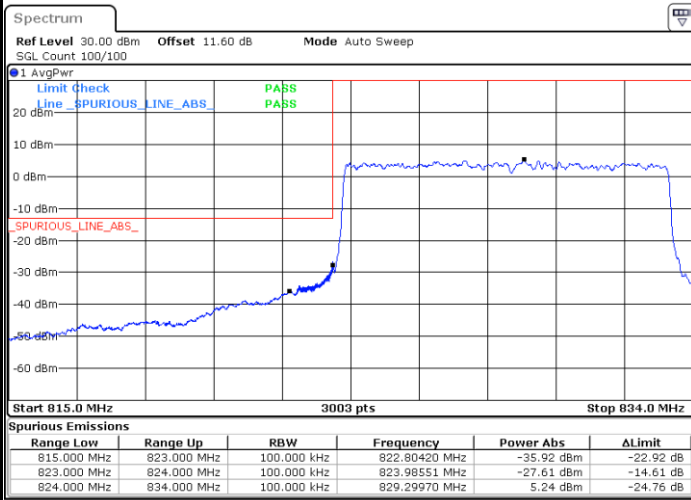

Date: 16.OCT.2020 14:10:49

Date: 16.OCT.2020 14:33:38



FR1 n5 / 10MHz / DFT-s-OFDM / 16QAM

Lowest Band Edge / 1RB0

Highest Band Edge / 1RBmax

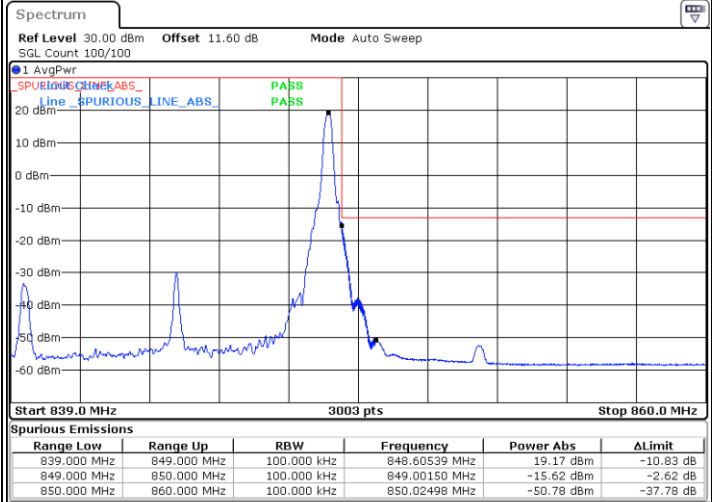
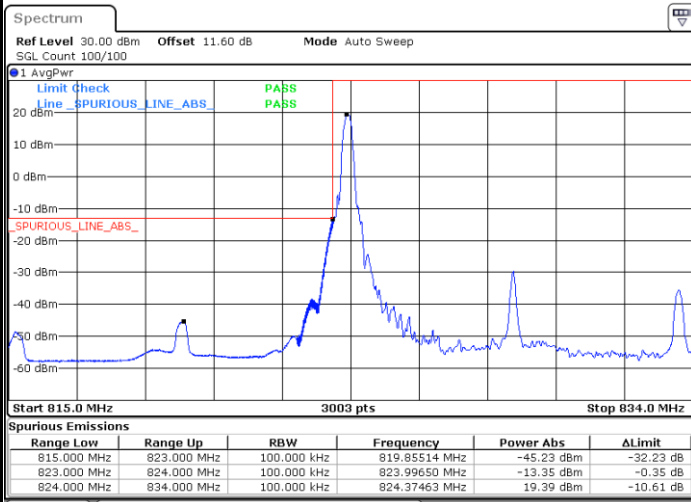

Date: 16.OCT.2020 14:20:00

Date: 16.OCT.2020 14:38:27

Lowest Band Edge / Full RB

Highest Band Edge / Full RB

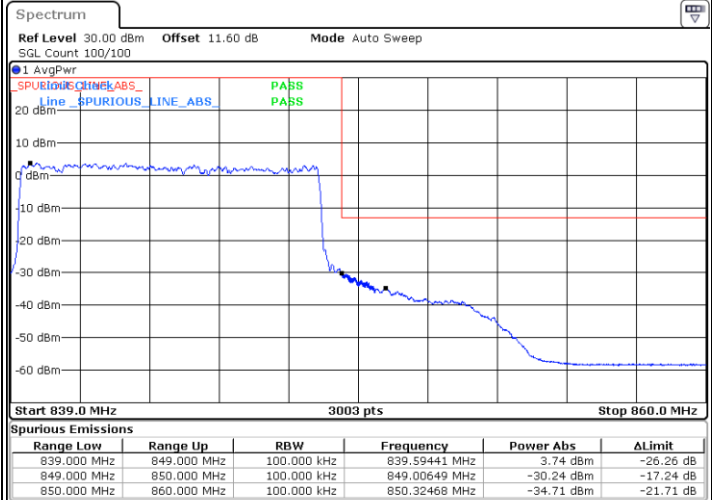
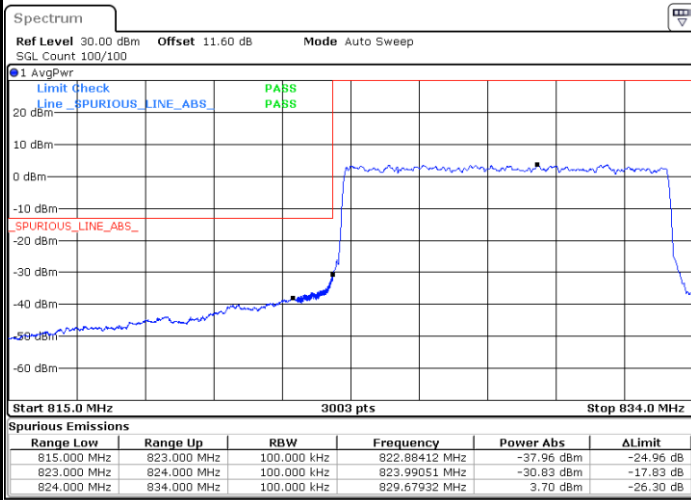

Date: 16.OCT.2020 14:12:24

Date: 16.OCT.2020 14:34:17



FR1 n5 / 10MHz / DFT-s-OFDM / 64QAM

Lowest Band Edge / 1RB0

Highest Band Edge / 1RBmax

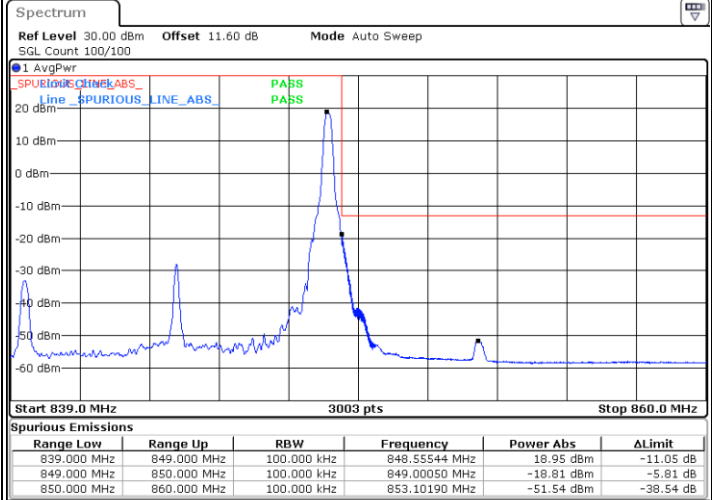
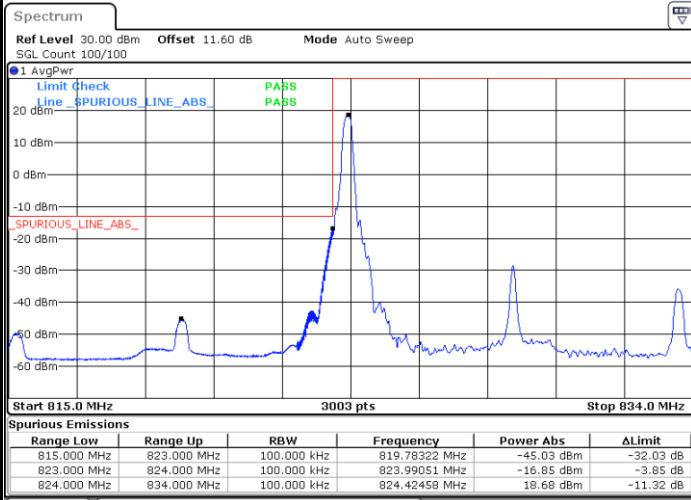

Date: 16.OCT.2020 14:19:10

Date: 16.OCT.2020 14:39:07

Lowest Band Edge / Full RB

Highest Band Edge / Full RB

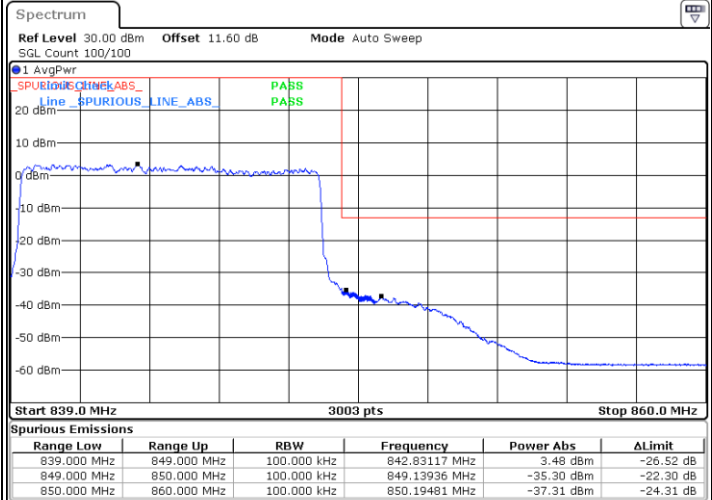
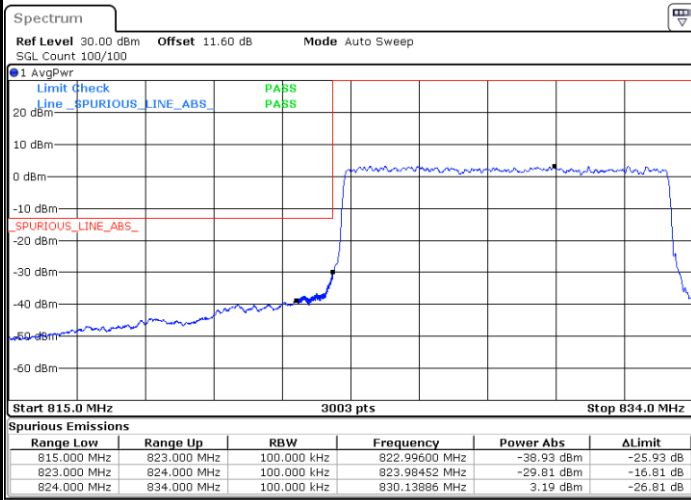

Date: 16.OCT.2020 14:13:27

Date: 16.OCT.2020 14:34:56



FR1 n5 / 10MHz / DFT-s-OFDM / 256QAM

Lowest Band Edge / 1RB0

Highest Band Edge / 1RBmax

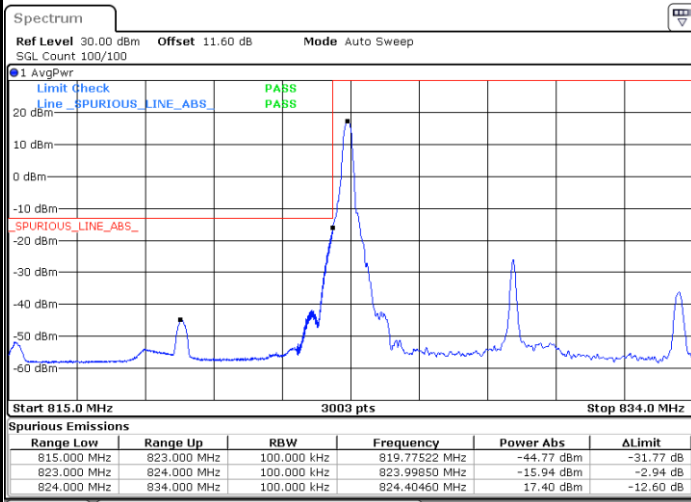

Date: 16.OCT.2020 14:18:38

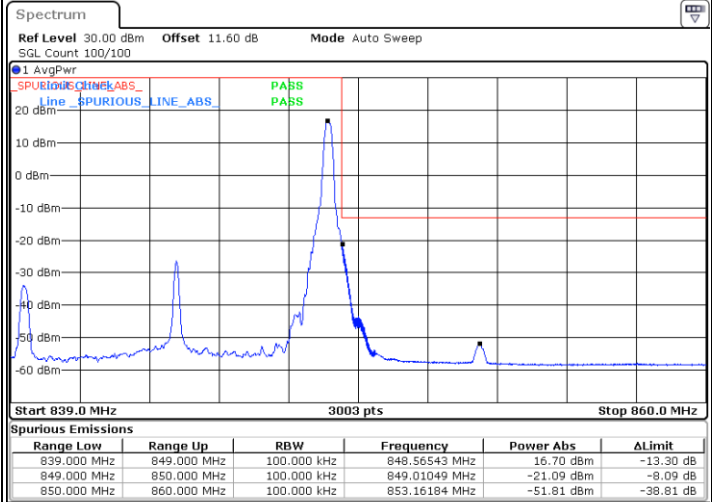

Date: 16.OCT.2020 14:39:46

Lowest Band Edge / Full RB

Highest Band Edge / Full RB

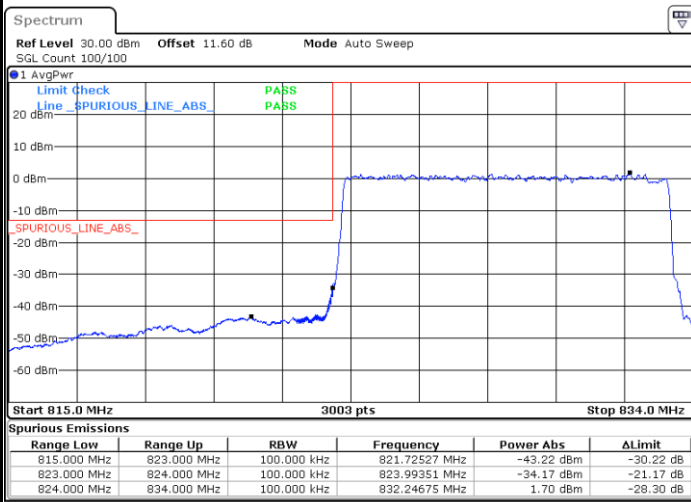

Date: 16.OCT.2020 14:14:19

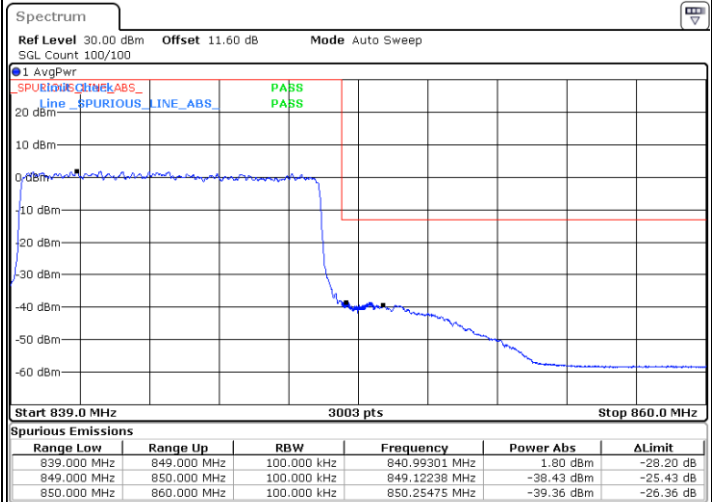

Date: 16.OCT.2020 14:35:38



FR1 n5 / 10MHz / CP OFDM / QPSK

Lowest Band Edge / Full RB

Highest Band Edge / Full RB

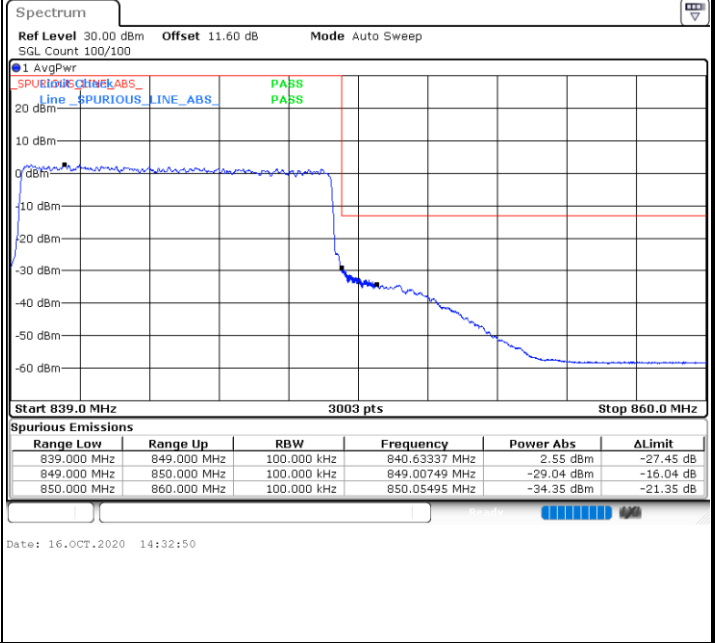
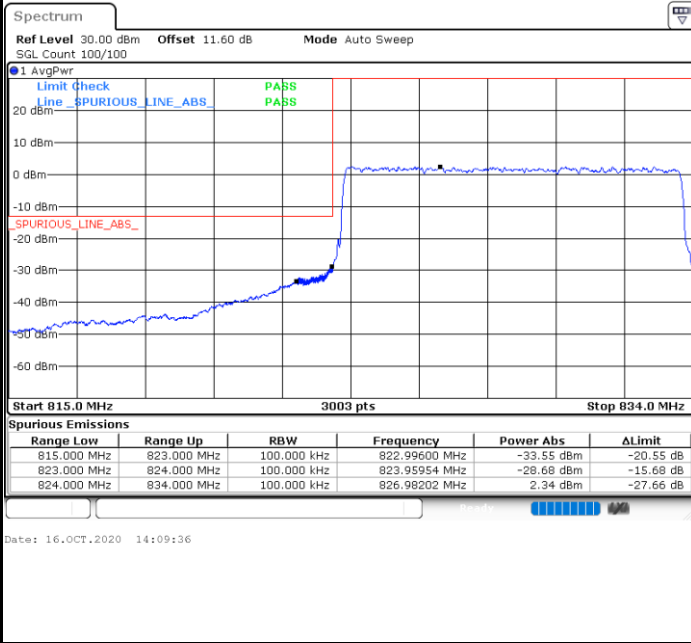



FR1 n5 / 15MHz / DFT-s-OFDM / PI/2 BPSK

Lowest Band Edge / 1RB0

Highest Band Edge / 1RBmax

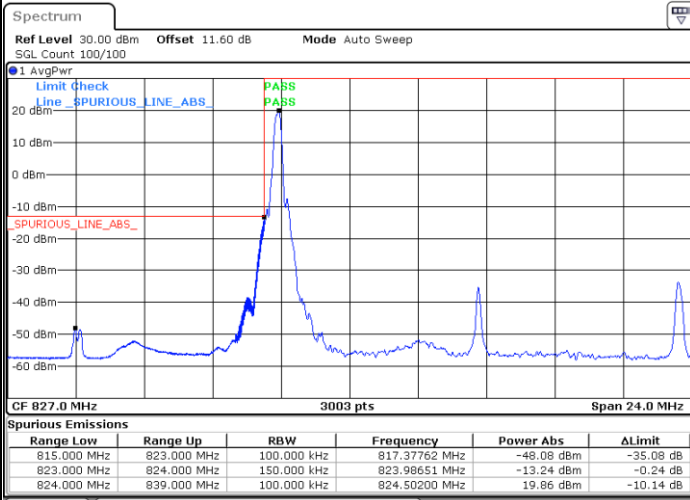

Date: 16.OCT.2020 13:42:13

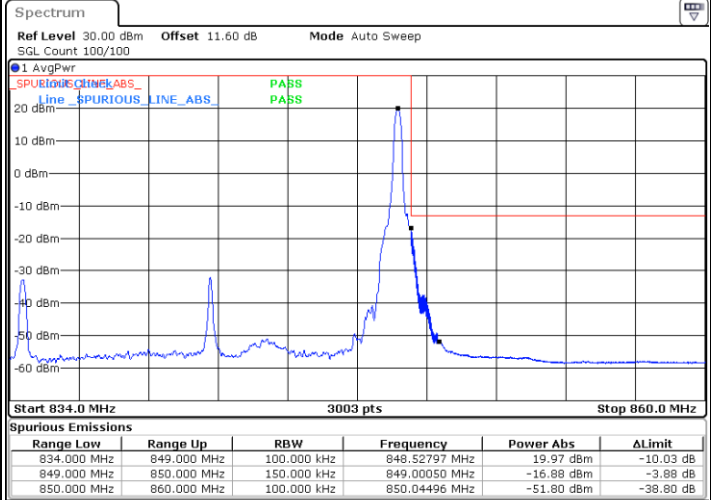

Date: 16.OCT.2020 14:00:59

Lowest Band Edge / Full RB

Highest Band Edge / Full RB

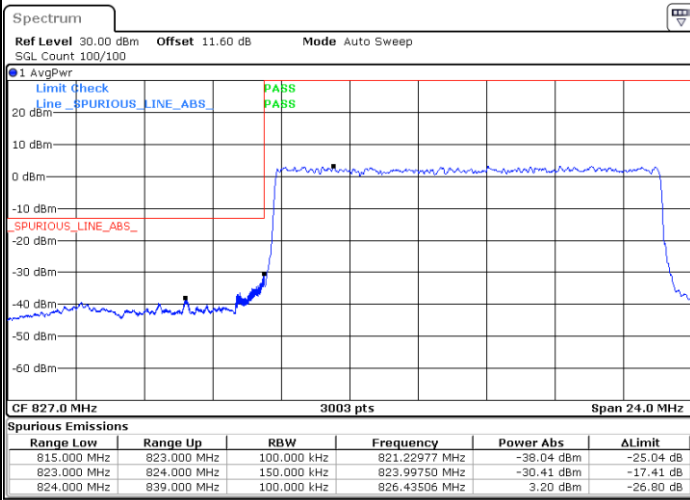

Date: 16.OCT.2020 13:49:50

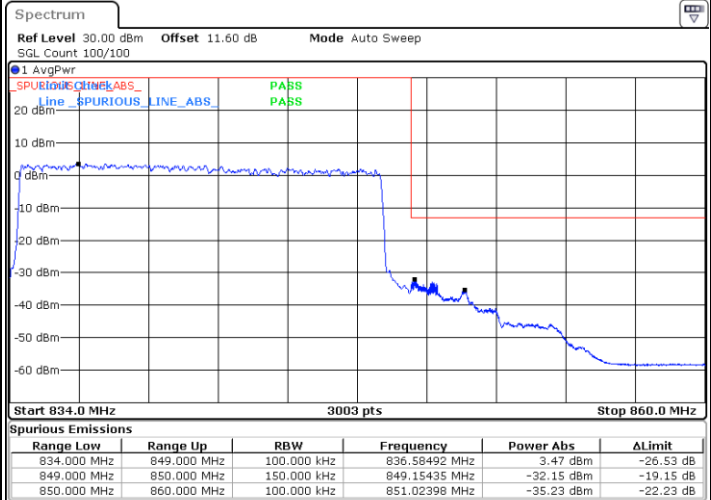

Date: 16.OCT.2020 14:06:49



FR1 n5 / 15MHz / DFT-s-OFDM / QPSK

Lowest Band Edge / 1RB0

Highest Band Edge / 1RBmax

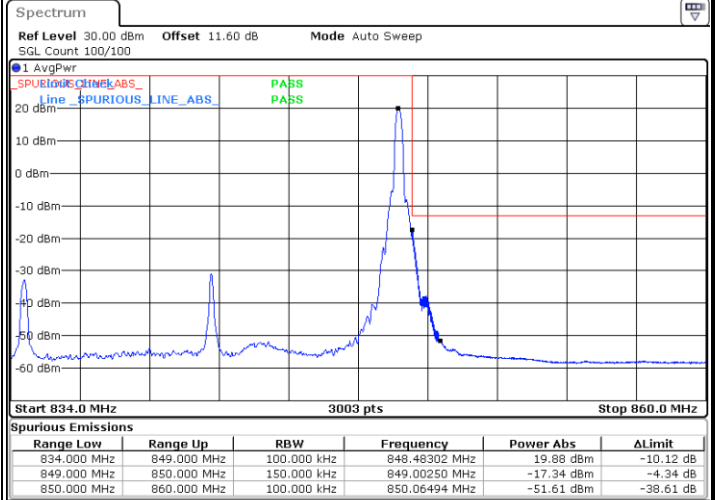
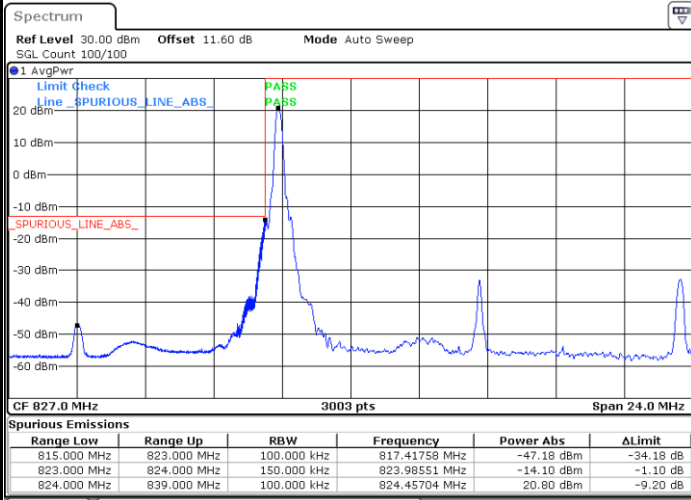

Date: 16.OCT.2020 13:40:22

Date: 16.OCT.2020 14:00:21

Lowest Band Edge / Full RB

Highest Band Edge / Full RB

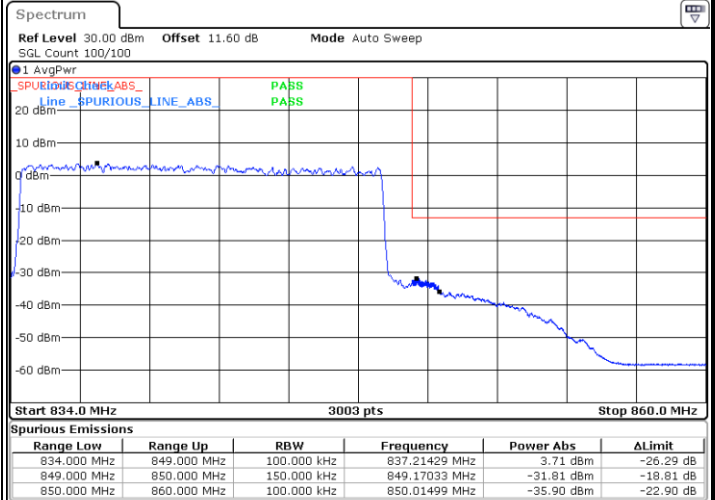
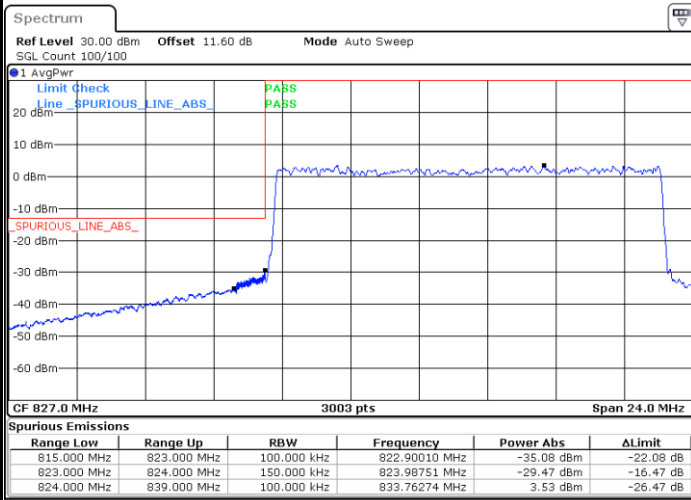

Date: 16.OCT.2020 13:49:14

Date: 16.OCT.2020 14:06:07



FR1 n5 / 15MHz / DFT-s-OFDM / 16QAM

Lowest Band Edge / 1RB0

Highest Band Edge / 1RBmax

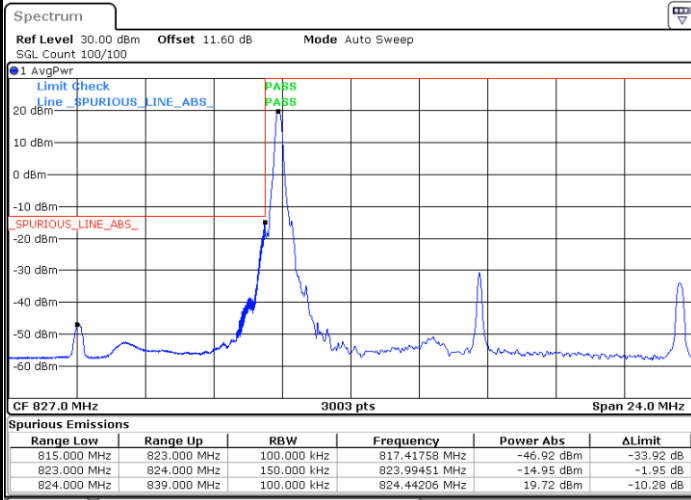

Date: 16.OCT.2020 13:44:05

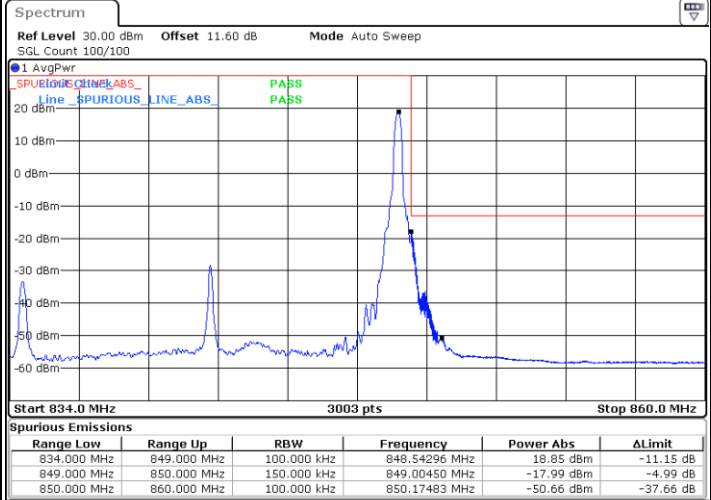

Date: 16.OCT.2020 14:01:43

Lowest Band Edge / Full RB

Highest Band Edge / Full RB

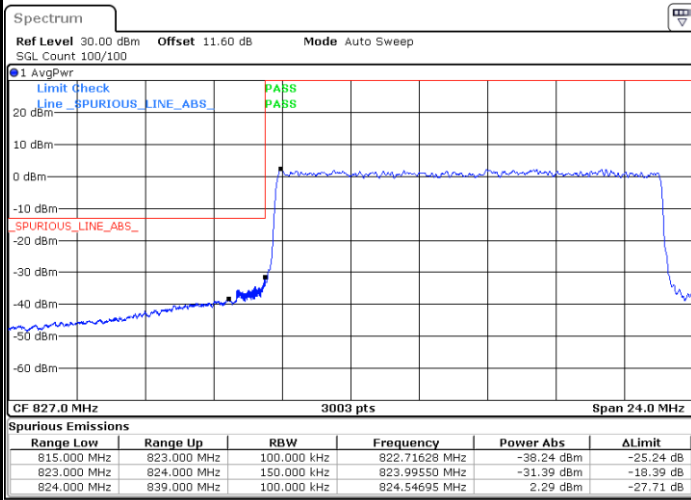

Date: 16.OCT.2020 13:48:09

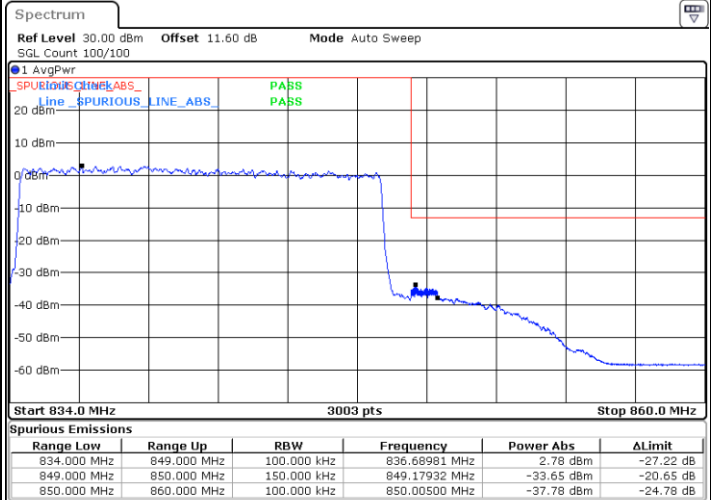

Date: 16.OCT.2020 14:05:26



FR1 n5 / 15MHz / DFT-s-OFDM / 64QAM

Lowest Band Edge / 1RB0

Highest Band Edge / 1RBmax

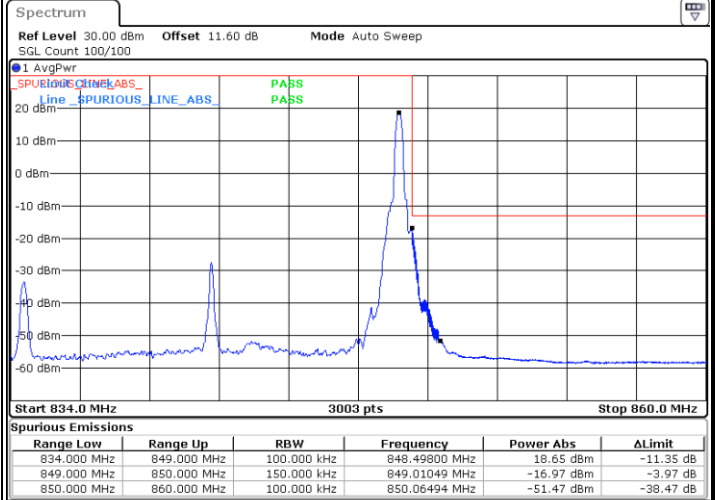
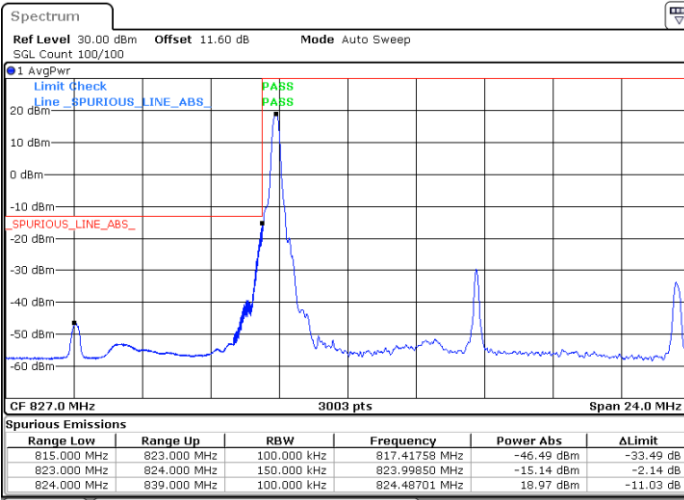

Date: 16.OCT.2020 13:44:49

Date: 16.OCT.2020 14:02:28

Lowest Band Edge / Full RB

Highest Band Edge / Full RB

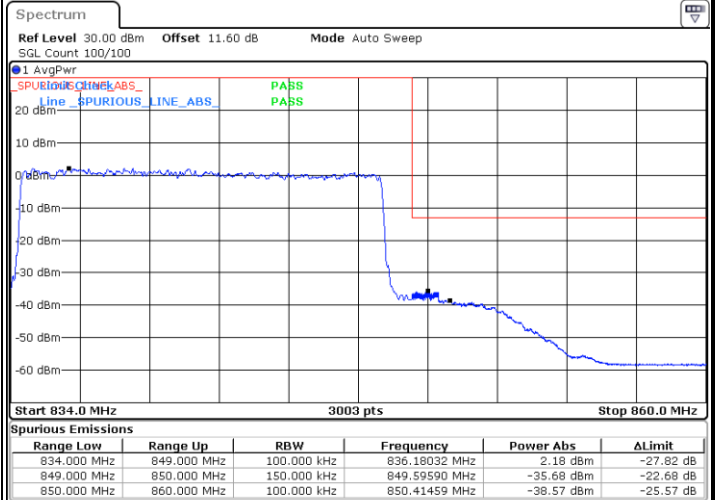
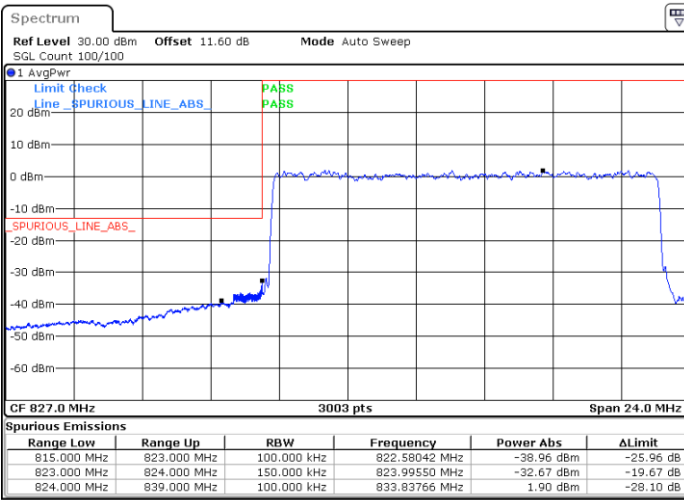

Date: 16.OCT.2020 13:47:08

Date: 16.OCT.2020 14:04:48