



FCC RADIO TEST REPORT

FCC ID : PKRISGM3000A
Equipment : Phone
Brand Name : Inseego
Model Name : M3000A
Marketing Name : M3000
Applicant : Inseego Corp.
9710 Scranton Road Suite 200, San Diego, CA 92121
Manufacturer : Inseego Corp.
9710 Scranton Road Suite 200, San Diego, CA 92121
Standard : FCC 47 CFR Part 2, 96

The product was received on Jun. 18, 2022 and testing was performed from Jun. 26, 2022 to Jun. 29, 2022. We, Sporton International (USA) Inc., would like to declare that the tested sample has been evaluated in accordance with the test procedures given in ANSI / TIA-603-E and has been in compliance with the applicable technical standards.

The test results in this partial report apply exclusively to the tested model / sample. Without written approval of Sporton International (USA) Inc., the test report shall not be reproduced except in full.

Approved by: Neil Kao

Sporton International (USA) Inc.
1175 Montague Expressway, Milpitas, CA 95035



Table of Contents

History of this test report.....	3
Summary of Test Result.....	4
1 General Description	5
1.1 Product Feature of Equipment Under Test	5
1.2 Modification of EUT	5
1.3 Testing Location	5
1.4 Applied Standards	5
2 Test Configuration of Equipment Under Test	6
2.1 Test Mode.....	6
2.2 Connection Diagram of Test System	6
2.3 Support Unit used in test configuration	7
2.4 Frequency List of Low/Middle/High Channels.....	7
3 Radiated Test Items	8
3.1 Measuring Instruments.....	8
3.2 Test Setup	8
3.3 Test Result of Radiated Test.....	9
3.4 Radiated Spurious Emission	10
4 List of Measuring Equipment.....	11
5 Uncertainty of Evaluation	12
Appendix A. Test Results of Radiated Test	
Appendix B. Test Setup Photographs	



History of this test report

Report No.	Version	Description	Issued Date
FG211223003C	01	Initial issue of report	Jul. 03, 2022



Summary of Test Result

Report Clause	Ref Std. Clause	Test Items	Result (PASS/FAIL)	Remark
3.4	§2.1051 §96.41	Radiated Spurious Emission	Pass	Under limit 6.03 dB at 7105.000 MHz

Conformity Assessment Condition:

1. The test results (PASS/FAIL) with all measurement uncertainty excluded are presented against the regulation limits or in accordance with the requirements stipulated by the applicant/manufacturer who shall bear all the risks of non-compliance that may potentially occur if measurement uncertainty is taken into account.
2. Please refer to the section " Uncertainty of Evaluation " for measurement uncertainty.

Comments and Explanations:

The product specifications of the EUT presented in the report are declared by the manufacturer who shall take full responsibility for the authenticity.



1 General Description

1.1 Product Feature of Equipment Under Test

3G-WCDMA, 4G-LTE, 5G-FR1 & FR2, Wi-Fi 2.4GHz 802.11b/g/n/ax, Wi-Fi 5GHz 802.11a/n/ac/ax and GNSS.

Product Feature	
Test Antenna Type	WWAN: Fixed Internal Antenna
Test Antenna Gain	<Ant. 4>: 1.5 dBi <Ant. 5>: 0.8 dBi <Ant. 6>: 3.8 dBi <Ant. 7>: 2.2 dBi

Remark: The EUT's information above is declared by manufacturer. Please refer to Comments and Explanations in report summary.

1.2 Modification of EUT

No modifications are made to the EUT during all test items.

1.3 Testing Location

Test Site	Sporton International (USA) Inc.
Test Site Location	1175 Montague Expressway, Milpitas, CA 95035 TEL : 408 9043300
Test Site No.	Sporton Site No. 03CH01-CA
Test Engineer	Yuan Lee
Temperature (°C)	21~25
Relative Humidity (%)	42~46

Note: The test site complies with ANSI C63.4 2014 requirement.

1.4 Applied Standards

According to the specifications of the manufacturer, the EUT must comply with the requirements of the following standards:

- ♦ ANSI C63.26-2015
- ♦ ANSI / TIA-603-E
- ♦ FCC 47 CFR Part 2, 96
- ♦ FCC KDB 971168 D01 Power Meas. License Digital Systems v03r01
- ♦ FCC KDB 940660 D01 Part 96 CBRS Eqpt v03
- ♦ FCC KDB 412172 D01 Determining ERP and EIRP v01r01
- ♦ FCC KDB 414788 D01 Radiated Test Site v01r01

Remark:

1. All test items were verified and recorded according to the standards and without any deviation during the test.
2. The A2LA code is not including all the FCC KDB listed without accreditation.

2 Test Configuration of Equipment Under Test

2.1 Test Mode

Antenna port conducted and radiated test items listed below are performed according to KDB 971168 D01 Power Meas. License Digital Systems v03r01 with maximum output power.

For radiated measurement, the measured emission level of the EUT was maximized by rotating the EUT on a turntable, adjusting the orientation of the EUT and EUT antenna in three orthogonal axis (X: flat, Y: portrait, Z: landscape) and accessory (Adapter or Earphone), and adjusting the measurement antenna orientation, following C63.26 exploratory test procedures and find X plane as worst plane.

Test Items	Band	Bandwidth (MHz)				Modulation					RB #			Test Channel		
		10	15	20	40	PI/2 BPSK	QPSK	16QAM	64QAM	256QAM	1	Half	Full	L	M	H
Radiated Spurious Emission	n48				v		v							v	v	v
Remark	<ol style="list-style-type: none"> The mark "v" means that this configuration is chosen for testing The mark "-" means that this bandwidth is not supported. The device is investigated from 30MHz to 10 times of fundamental signal for radiated spurious emission test under different RB size/offset and modulations in exploratory test. Subsequently, only the worst case emissions are reported. For radiated measurement, pre-scanned in two modes, DFT-s OFDM and CP OFDM. The worst cases (DFT-s OFDM) were recorded in this report 															

2.2 Connection Diagram of Test System

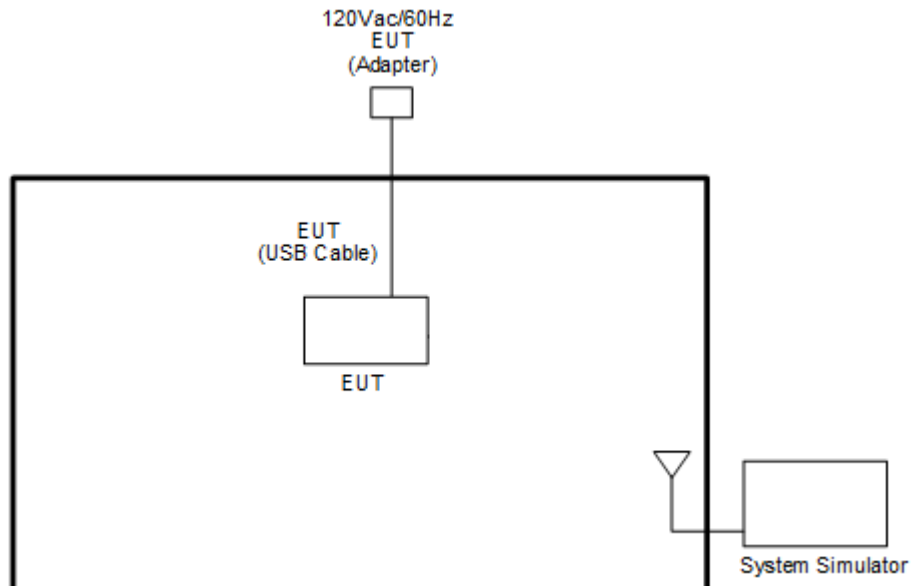



2.3 Support Unit used in test configuration

Item	Equipment	Brand Name	Model No.	FCC ID	Data Cable	Power Cord
1.	System Simulator	Keysight	UXM	N/A	N/A	Unshielded, 1.8 m
2.	System Simulator	R&S	CMW500	N/A	N/A	Unshielded, 1.8 m

2.4 Frequency List of Low/Middle/High Channels

5G NR n48 Channel and Frequency List				
BW [MHz]	Channel/Frequency(MHz)	Lowest	Middle	Highest
40	Channel	638000	641666	645332
	Frequency	3570	3624.99	3679.98

3 Radiated Test Items

3.1 Measuring Instruments

See list of measuring instruments of this test report.

3.2 Test Setup

For radiated emissions from 30MHz to 1GHz

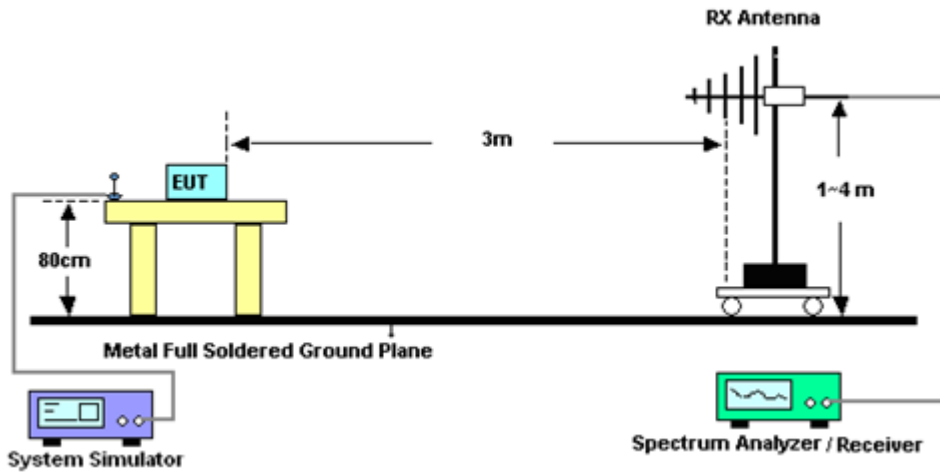

For radiated emissions from 1GHz to 18GHz

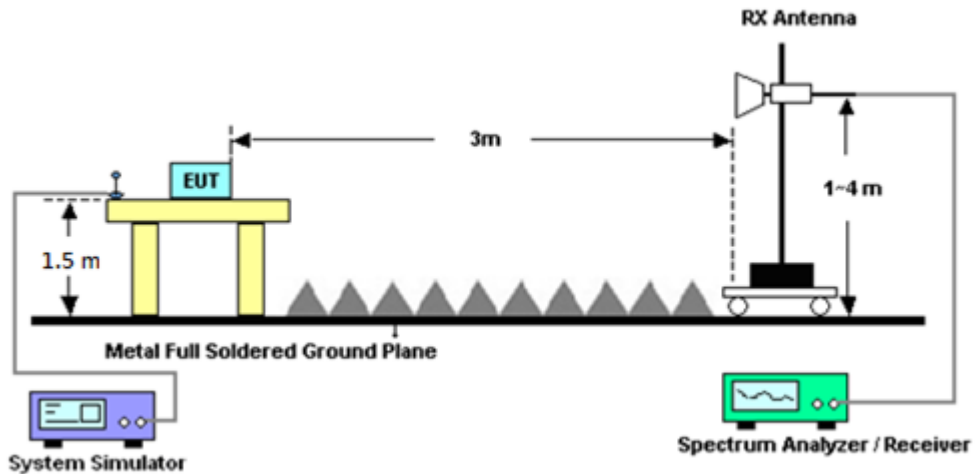

For radiated emissions above 18GHz

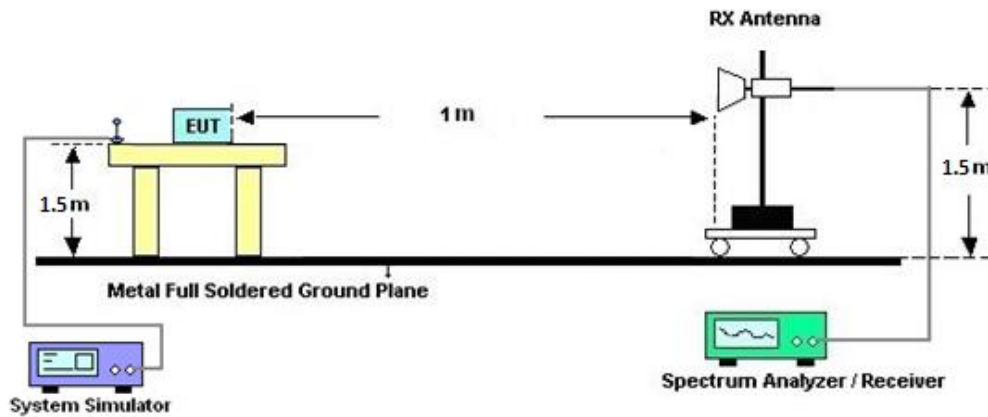

3.3 Test Result of Radiated Test

Please refer to Appendix A.

Note:

The low frequency, which started from 9 kHz to 30MHz, was pre-scanned and the result which was 20dB lower than the limit line was not reported.

There is adequate comparison measurement of both open-field test site and alternative test site - semi-Anechoic chamber according to 414788 D01 Radiated Test Site v01r01, and the result came out very similar.



3.4 Radiated Spurious Emission

3.4.1 Description of Radiated Spurious Emission Measurement

The radiated spurious emission was measured by substitution method according to ANSI / TIA-603-E. The power of any emission outside of the authorized operating frequency ranges must be attenuated below the transmitter power (P) by a factor of at least -40dBm / MHz .

The spectrum is scanned from 30 MHz up to a frequency including its 10th harmonic.

3.4.2 Test Procedures

The testing follows FCC KDB 971168 D01 v03r01 Section 7 and ANSI / TIA-603-E Section 2.2.12.

1. The EUT was placed on a turntable with 0.8 meter height for frequency below 1GHz and 1.5 meter height for frequency above 1GHz respectively above ground.
2. The EUT was set 3 meters from the receiving antenna mounted on the antenna tower.
3. The table was rotated 360 degrees to determine the position of the highest spurious emission.
4. The height of the receiving antenna is varied between 1m to 4m to search the maximum spurious emission for both horizontal and vertical polarizations.
5. During the measurement, the system simulator parameters were set to force the EUT transmitting at maximum output power.
6. Make the measurement with the spectrum analyzer's RBW = 1MHz, VBW = 3MHz, taking the record of maximum spurious emission.
7. Measure the burst average result by setting trace = average with duty cycle factor when margin is not enough
8. A horn antenna was substituted in place of the EUT and was driven by a signal generator. Tune the output power of signal generator to the same emission level with EUT maximum spurious emission.
$$\text{EIRP (dBm)} = \text{S.G. Power} - \text{Tx Cable Loss} + \text{Tx Antenna Gain}$$
$$\text{ERP (dBm)} = \text{EIRP} - 2.15$$
9. The RF fundamental frequency should be excluded against the limit line in the operating frequency band.



4 List of Measuring Equipment

Instrument	Brand Name	Model No.	Serial No.	Characteristics	Calibration Date	Test Date	Due Date	Remark
Bilog Antenna	TESEQ	6111D	54683	30MHz~1GHz	Oct. 15, 2021	Jun. 26, 2022~ Jun. 29, 2022	Oct. 14, 2022	Radiation (03CH01-CA)
Bilog Antenna	TESEQ	6111D	50391	30MHz~1GHz	Jul. 19, 2021	Jun. 26, 2022~ Jun. 29, 2022	Jul. 18, 2022	Radiation (03CH01-CA)
Horn Antenna	SCHWARZBE CK	BBHA 9120D	02140	1GHz~18GHz	Sep. 30, 2021	Jun. 26, 2022~ Jun. 29, 2022	Sep. 29, 2022	Radiation (03CH01-CA)
Horn Antenna	SCHWARZBE CK	BBHA 9120D	01895	1GHz~18GHz	Aug. 25, 2021	Jun. 26, 2022~ Jun. 29, 2022	Aug. 24, 2022	Radiation (03CH01-CA)
Horn Antenna	SCHWARZBE CK	BBHA 9170D	00842	18GHz~40GHz	Jul. 20, 2021	Jun. 26, 2022~ Jun. 29, 2022	Jul. 19, 2022	Radiation (03CH01-CA)
Horn Antenna	SCHWARZBE CK	BBHA 9170D	00841	18GHz~40GHz	Aug. 26, 2021	Jun. 26, 2022~ Jun. 29, 2022	Aug. 25, 2022	Radiation (03CH01-CA)
Preamplifier	SONOMA	310N	372241	9kHz~1GHz	May 09, 2022	Jun. 26, 2022~ Jun. 29, 2022	May. 08, 2023	Radiation (03CH01-CA)
Preamplifier	E-instrument	ERA-100M-18 G-56-01-A70	EC1900252	1GHz~18GHz	May 09, 2022	Jun. 26, 2022~ Jun. 29, 2022	May 08, 2023	Radiation (03CH01-CA)
Preamplifie	EMEC	EMC18G40G	060725	18G-40G	May 10, 2022	Jun. 26, 2022~ Jun. 29, 2022	May 09, 2023	Radiation (03CH01-CA)
EMI Test Receiver	R&S	ESU26	100123	20Hz~26.5GHz	May 31, 2022	Jun. 26, 2022~ Jun. 29, 2022	May 30, 2023	Radiation (03CH01-CA)
Signal Generator	Rohde & Schwarz	FSV	101089	10Hz~40GHz	Jun. 01, 2022	Jun. 26, 2022~ Jun. 29, 2022	May 31, 2023	Radiation (03CH01-CA)
RF Cable	HUBER+SUH NER	SUCOFLEX 102	8015932/2, 8015762/2, 6015772/2	N/A	Aug. 09, 2021	Jun. 26, 2022~ Jun. 29, 2022	Aug. 08, 2022	Radiation (03CH01-CA)
Filter	Wainwright	WHKX8-5872. 5-6750-18000- 40ST	SN8	6.75GHz High Pass Filter	Jul. 22, 2021	Jun. 26, 2022~ Jun. 29, 2022	Jul. 21, 2022	Radiation (03CH01-CA)
Hygrometer	TESTO	608-H1	45141354	N/A	Jul. 30, 2021	Jun. 26, 2022~ Jun. 29, 2022	Jul. 29, 2022	Radiation (03CH01-CA)
Controller	Chaintek	EM-1000	060881	Control Turn Table & Antenna Mast	N/A	Jun. 26, 2022~ Jun. 29, 2022	N/A	Radiation (03CH01-CA)
Antenna Mast	ChainTek	MBS-520-1	N/A	1m~4m	N/A	Jun. 26, 2022~ Jun. 29, 2022	N/A	Radiation (03CH01-CA)
Turn Table	ChainTek	T-200-S-1	N/A	0~360 Degree	N/A	Jun. 26, 2022~ Jun. 29, 2022	N/A	Radiation (03CH01-CA)
Test Software	Audix E3	E6.2009-8-24d	PK-002093	N/A	N/A	Jun. 26, 2022~ Jun. 29, 2022	N/A	Radiation (03CH01-CA)



5 Uncertainty of Evaluation

Uncertainty of Radiated Emission Measurement (30 MHz ~ 1000 MHz)

Measuring Uncertainty for a Level of Confidence of 95% ($U = 2Uc(y)$)	3.40 dB
---	---------

Uncertainty of Radiated Emission Measurement (1 GHz ~ 18 GHz)

Measuring Uncertainty for a Level of Confidence of 95% ($U = 2Uc(y)$)	3.60 dB
---	---------

Uncertainty of Radiated Emission Measurement (18 GHz ~ 40 GHz)

Measuring Uncertainty for a Level of Confidence of 95% ($U = 2Uc(y)$)	4.30 dB
---	---------



Appendix A. Test Results of Radiated Test

<Ant. 4>

5G NR n48

5GNR n48/ 40MHz / QPSK									
Channel	Frequency (MHz)	EIRP (dBm)	Limit (dBm)	Margin (dB)	SPA Reading (dBm)	S.G. Power (dBm)	TX Cable loss (dB)	TX Antenna Gain (dBi)	Polarization (H/V)
Lowest	7105	-52.14	-40	-12.14	-47.63	-62.24	1.15	11.25	H
	10655	-54.92	-40	-14.92	-52.68	-64.33	1.39	10.79	H
	17762	-50.45	-40	-10.45	-55.7	-58.49	1.85	9.88	H
									H
									H
									H
	7105	-46.03	-40	-6.03	-42.19	-56.11	1.15	11.22	V
	10655	-53.48	-40	-13.48	-51.12	-62.93	1.39	10.84	V
	17762	-48.70	-40	-8.70	-55.91	-56.76	1.85	9.90	V
									V
									V
									V
Middle	7215	-55.56	-40	-15.56	-51.22	-65.50	1.15	11.09	H
	10820	-55.65	-40	-15.65	-53.67	-64.93	1.37	10.65	H
	18033	-60.68	-40	-20.68	-73.63	-64.52	13.93	17.77	H
									H
									H
									H
	7215	-47.55	-40	-7.55	-44.29	-57.63	1.15	11.22	V
	10820	-51.83	-40	-11.83	-49.8	-61.15	1.37	10.69	V
	18033	-55.63	-40	-15.63	-68.99	-59.40	13.93	17.71	V
	25248	-56.46	-40	-16.46	-75.87	-58.93	16.57	19.03	V
									V
									V
								V	



Highest	7395	-56.06	-40	-16.06	-50.35	-65.77	1.30	11.01	H
	11095	-54.91	-40	-14.91	-53.65	-64.32	1.41	10.82	H
	25892	-64.12	-40	-24.12	-78.48	-66.75	16.81	19.44	H
									H
									H
									H
	7395	-47.97	-40	-7.97	-42.59	-57.69	1.30	11.01	V
	11095	-54.21	-40	-14.21	-53.05	-63.68	1.41	10.88	V
	25892	-53.96	-40	-13.96	-73.08	-56.50	16.81	19.35	V
									V
									V
									V

Remark: Spurious emissions within 30-1000MHz were found more than 20dB below limit line.



MIMO <Ant. 4+6>

5GNR n48 MIMO

5GNR n48 MIMO/ 40MHz / QPSK									
Channel	Frequency (MHz)	EIRP (dBm)	Limit (dBm)	Margin (dB)	SPA Reading (dBm)	S.G. Power (dBm)	TX Cable loss (dB)	TX Antenna Gain (dBi)	Polarization (H/V)
Lowest	7105	-57.86	-40	-17.86	-53.35	-67.96	1.15	11.25	H
	10655	-56.14	-40	-16.14	-53.9	-65.55	1.39	10.79	H
	14211	-56.43	-40	-16.43	-57.73	-66.40	1.52	11.48	H
									H
									H
									H
	7105	-50.16	-40	-10.16	-46.32	-60.24	1.15	11.22	V
	10655	-56.17	-40	-16.17	-53.81	-65.62	1.39	10.84	V
	14211	-55.84	-40	-15.84	-57.9	-65.94	1.52	11.61	V
									V
									V
									V
Middle	7214	-57.78	-40	-17.78	-53.44	-67.72	1.15	11.09	H
	10820	-56.21	-40	-16.21	-54.23	-65.49	1.37	10.65	H
	14425	-55.25	-40	-15.25	-56.1	-64.91	1.54	11.20	H
									H
									H
									H
	7214	-50.26	-40	-10.26	-47.02	-60.34	1.15	11.22	V
	10820	-56.25	-40	-16.25	-54.22	-65.57	1.37	10.69	V
	14425	-53.69	-40	-13.69	-56.05	-63.39	1.54	11.23	V
									V
									V
									V



Highest	7395	-57.20	-40	-17.20	-51.49	-66.91	1.30	11.01	H
	11090	-55.19	-40	-15.19	-53.92	-64.59	1.41	10.80	H
	14791	-55.23	-40	-15.23	-56.95	-65.02	1.63	11.42	H
									H
									H
									H
	7395	-49.92	-40	-9.92	-44.54	-59.64	1.30	11.01	V
	11090	-55.37	-40	-15.37	-54.2	-64.82	1.41	10.85	V
	14791	-53.39	-40	-13.39	-57.26	-63.11	1.63	11.35	V
									V
									V
									V

Remark: Spurious emissions within 30-1000MHz were found more than 20dB below limit line.



Appendix B. Duty Cycle Plots

<Ant. 4>

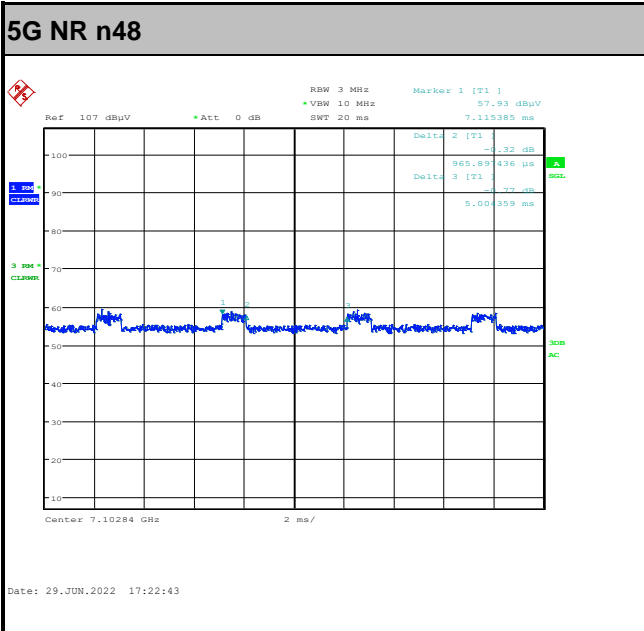

Note: Duty cycle = 19.30 %, Variation <2%

MIMO <Ant. 4+6>

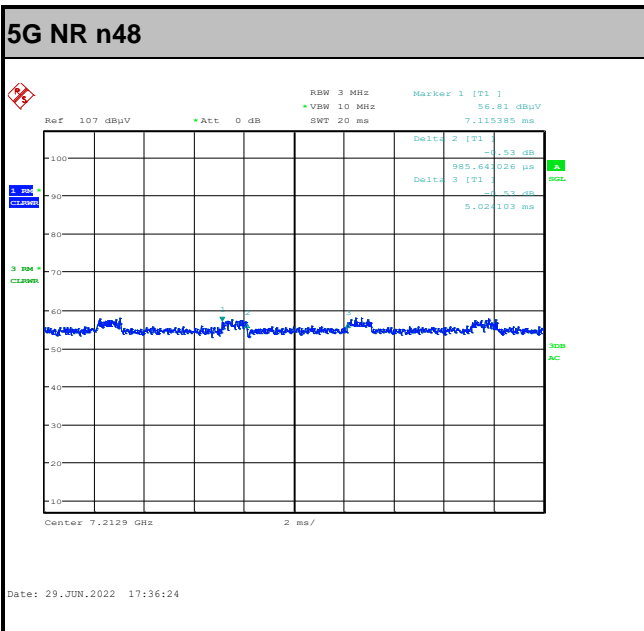

Note: Duty cycle = 19.62 %, Variation <2%

Appendix C. Setup Photographs

<Radiated Emission>

X Plane

LF

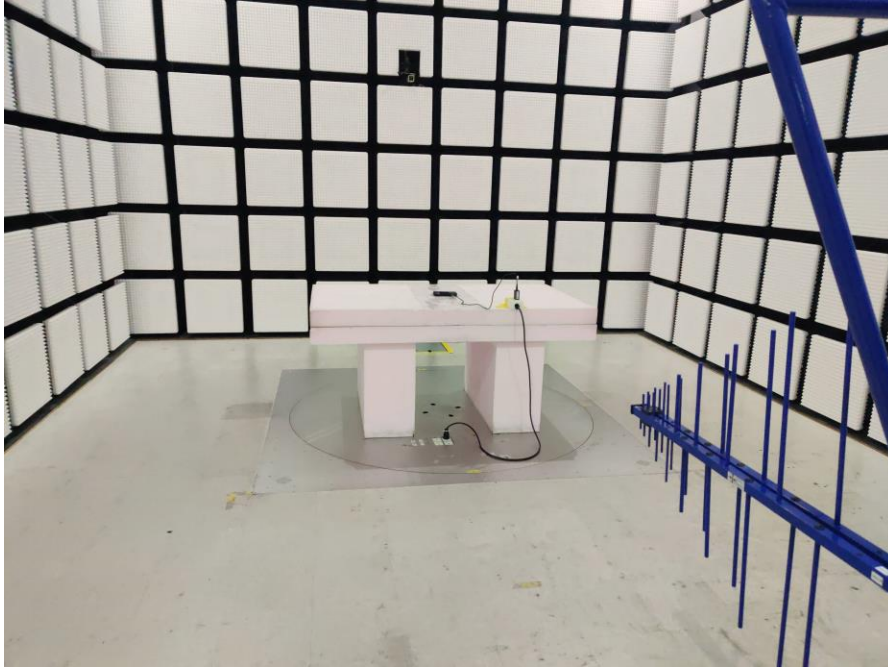

HF

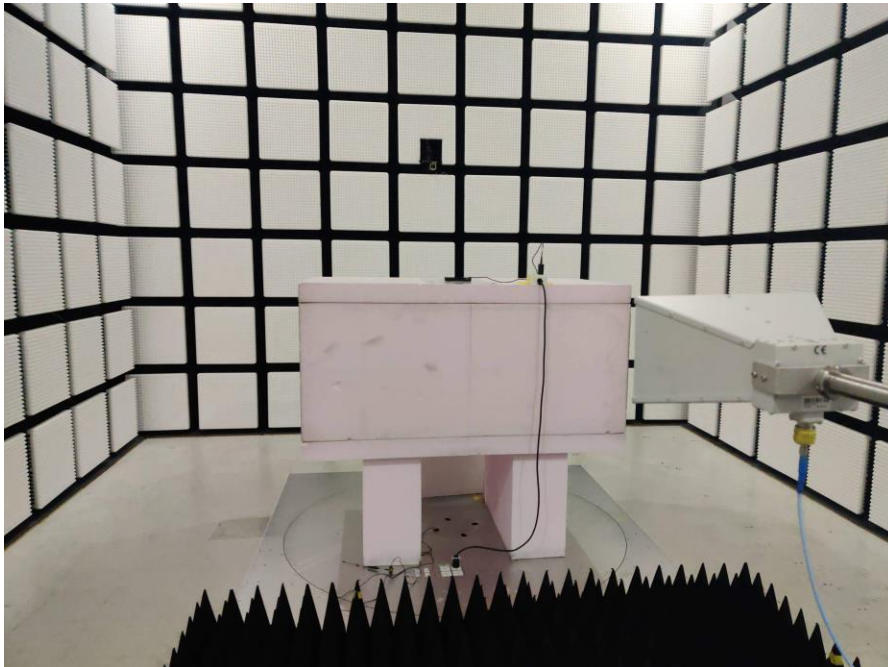

SHF



————THE END————