



FCC CO-LOCATION RADIO TEST REPORT

FCC ID : PKRISGM3000A
Equipment : M3000A
Brand Name : Inseego
Model Name : M3000A
Marketing Name : M3000
Applicant : Inseego Corp.
9710 Scranton Road Suite 200, San Diego,, CA 92121
Manufacturer : Inseego Corp.
9710 Scranton Road Suite 200, San Diego,, CA 92121
Standard : FCC Part 15 Subpart C §15.247
FCC Part 15 Subpart E §15.407

The product was received on Mar. 29, 2022 and testing was performed from Apr. 29, 2022 to May 13, 2022. We, Sporton International Inc. EMC & Wireless Communications Laboratory, would like to declare that the tested sample has been evaluated in accordance with the test procedures and has been in compliance with the applicable technical standards.

The test results in this report apply exclusively to the tested model / sample. Without written approval from Sporton International Inc. EMC & Wireless Communications Laboratory, the test report shall not be reproduced except in full.

Louis Wu

Approved by: Louis Wu

Sporton International Inc. EMC & Wireless Communications Laboratory

No. 52, Huaya 1st Rd., Guishan Dist., Taoyuan City 333, Taiwan (R.O.C.)



Table of Contents

History of this test report.....	3
Summary of Test Result.....	4
1 General Description	5
1.1 Product Feature of Equipment Under Test.....	5
1.2 Modification of EUT	5
1.3 Testing Location	5
1.4 Applicable Standards.....	6
2 Test Configuration of Equipment Under Test	7
2.1 Carrier Frequency and Channel	7
2.2 Connection Diagram of Test System.....	8
2.3 EUT Operation Test Setup	8
3 Test Result	9
3.1 Unwanted Emissions Measurement.....	9
3.2 Antenna Requirements.....	14
4 List of Measuring Equipment.....	15
5 Uncertainty of Evaluation.....	16
Appendix A. Radiated Spurious Emission	
Appendix B. Radiated Spurious Emission Plots	
Appendix C. Duty Cycle Plots	
Appendix D. Setup Photographs	



History of this test report

Report No.	Version	Description	Issue Date
FR1D2414E	01	Initial issue of report	Jun. 20, 2022



Summary of Test Result

Report Clause	Ref Std. Clause	Test Items	Result (PASS/FAIL)	Remark
3.1	15.247(d) 15.407(b)	Unwanted Emissions	Pass	2.80 dB under the limit at 5149.500 MHz
3.2	15.203 15.247(b) 15.407(a)	Antenna Requirement	Pass	-

Declaration of Conformity:

1. The test results (PASS/FAIL) with all measurement uncertainty excluded are presented in accordance with the regulation limits or requirements declared by manufacturers. It's means measurement values may risk exceeding the limit of regulation standards, if measurement uncertainty is include in test results.
2. The measurement uncertainty please refer to this report "Uncertainty of Evaluation".

Comments and Explanations:

The product specifications of the EUT presented in the report are declared by the manufacturer who shall take full responsibility for the authenticity.

Reviewed by: William Chen

Report Producer: Clio Lo



1 General Description

1.1 Product Feature of Equipment Under Test

3G-WCDMA, 4G-LTE, 5G-FR1 & FR2, Wi-Fi 2.4GHz 802.11b/g/n/ax, Wi-Fi 5GHz 802.11a/n/ac/ax and GNSS.

Product Feature	
Antenna Type	WWAN: Fixed Internal Antenna WLAN <Ant. 0>: Internal Antenna <Ant. 1>: Internal Antenna GPS / Glonass / BDS / Galileo: Internal Antenna

Remark: The EUT's information above is declared by manufacturer. Please refer to Comments and Explanations in report summary.

1.2 Modification of EUT

No modifications made to the EUT during the testing.

1.3 Testing Location

Test Site	Sporton International Inc. EMC & Wireless Communications Laboratory
Test Site Location	No.52, Huaya 1st Rd., Guishan Dist., Taoyuan City 333, Taiwan (R.O.C.) TEL: +886-3-327-3456 FAX: +886-3-328-4978
Test Site No.	Sporton Site No. 03CH07-HY

Note: The test site complies with ANSI C63.4 2014 requirement.

FCC designation No.: TW1190



1.4 Applicable Standards

According to the specifications declared by the manufacturer, the EUT must comply with the requirements of the following standards:

- ♦ FCC Part 15 Subpart E
- ♦ FCC Part 15 Subpart C §15.247
- ♦ FCC KDB 789033 D02 General UNII Test Procedures New Rules v02r01.
- ♦ FCC KDB Publication No. 558074 D01 DTS Meas. Guidance v05r02
- ♦ FCC KDB 414788 D01 Radiated Test Site v01r01.
- ♦ ANSI C63.10-2013

Remark:

1. All the test items were validated and recorded in accordance with the standards without any modification during the testing.
2. The TAF code is not including all the FCC KDB listed without accreditation.
3. This EUT has also been tested and complied with the requirements of FCC Part 15, Subpart B, recorded in a separate test report.



2 Test Configuration of Equipment Under Test

- a. The EUT has been associated with peripherals and configuration operated in a manner tended to maximize its emission characteristics in a typical application. Frequency range investigated: radiation emission (9 kHz to the 10th harmonic of the highest fundamental frequency or to 40 GHz, whichever is lower). For radiated measurement, the measured emission level of the EUT was maximized by rotating the EUT on a turntable, adjusting the orientation of the EUT and EUT antenna in three orthogonal axis (X: flat, Y: portrait, Z: landscape), and adjusting the measurement antenna orientation, following C63.10 exploratory test procedures and find X plane as worst plane.

2.1 Carrier Frequency and Channel

2502.5 MHz ~ 2567.5 MHz
LTE BW 20MHz

2400-2483.5 MHz		5150-5250 MHz	
802.11ax HE20		802.11ax HE80	
Channel	Freq. (MHz)	Channel	Freq. (MHz)
11	2462	42	5210

Remark: During the Radiated Spurious Emission test, the EUT turn on the WWAN functions simultaneously.

<Co-Location>

Test Mode	Modulation	Data Rate
Mode 1	WLAN 2.4GHz 802.11ax HE20 for MIMO <Ant. 1+2> + LTE Band 7	MCS0 + QPSK
Mode 2	WLAN 5GHz 802.11ax HE80 for MIMO <Ant. 1+2> + LTE Band 7	MCS0 + QPSK

2.2 Connection Diagram of Test System

<Co-Location Tx Mode>

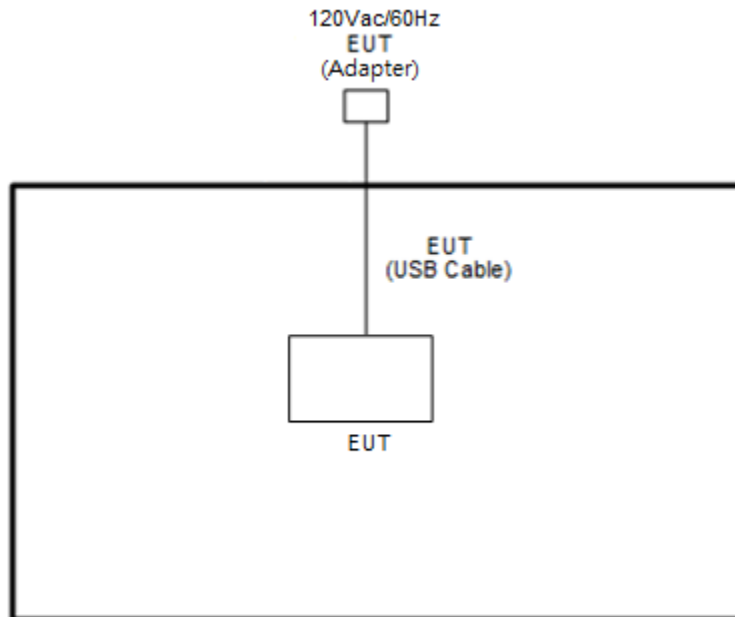

2.3 EUT Operation Test Setup

The RF test items, utility "QRCT 4.0.00195.0" was installed in Notebook which was programmed in order to make the EUT get into the engineering modes to provide channel selection, power level, data rate and the application type and for continuous transmitting signals.



3 Test Result

3.1 Unwanted Emissions Measurement

This section is to measure unwanted emissions through radiated measurement for band edge spurious emissions and out of band emissions measurement.

3.1.1 Limit of Unwanted Emissions

(1) Unwanted spurious emissions fallen in restricted bands shall comply with the general field strength limits as below table:

Frequency (MHz)	Field Strength (microvolts/meter)	Measurement Distance (meters)
0.009 – 0.490	2400/F(kHz)	300
0.490 – 1.705	24000/F(kHz)	30
1.705 – 30.0	30	30
30 – 88	100	3
88 – 216	150	3
216 - 960	200	3
Above 960	500	3

Note: The following formula is used to convert the EIRP to field strength.

$$E = \frac{1000000\sqrt{30P}}{3} \text{ } \mu\text{V/m, where P is the eirp (Watts)}$$

EIRP (dBm)	Field Strength at 3m (dBμV/m)
- 27	68.3

(2) KDB789033 D02 v02r01 G)2)c)

(i) Sections 15.407(b)(1-3) specifies the unwanted emissions limit for the U-NII-1 and U-NII-2 bands. As specified, emissions above 1000 MHz that are outside of the restricted bands are subject to a peak emission limit of -27 dBm/MHz.

(ii) Section 15.407(b)(4) specifies the unwanted emissions limit for the U-NII-3 band. A band emissions mask is specified in Section 15.407(b)(4)(i). The emission limits are based on the use of a peak detector.

3.1.2 Measuring Instruments

Please refer to the measuring equipment list in this test report.



3.1.3 Test Procedures

1. The testing follows FCC KDB 789033 D02 General UNII Test Procedures New Rules v02r01. Section G) Unwanted emissions measurement.
 - (1) Procedure for Unwanted Emissions Measurements Below 1000 MHz
 - RBW = 120 kHz
 - VBW = 300 kHz
 - Detector = Peak
 - Trace mode = max hold
 - (2) Procedure for Peak Unwanted Emissions Measurements Above 1000 MHz
 - RBW = 1 MHz
 - VBW \geq 3 MHz
 - Detector = Peak
 - Sweep time = auto
 - Trace mode = max hold
 - (3) Procedures for Average Unwanted Emissions Measurements Above 1000 MHz
 - RBW = 1 MHz
 - VBW = 10 Hz, when duty cycle is no less than 98 percent.
 - VBW \geq 1/T, when duty cycle is less than 98 percent where T is the minimum transmission duration over which the transmitter is on and is transmitting at its maximum power control level for the tested mode of operation.
2. The EUT is placed on a turntable with 0.8 meter for frequency below 1 GHz and 1.5 meter for frequency above 1 GHz respectively above ground.
3. The EUT is set 3 meters away from the receiving antenna which is mounted on the top of a variable height antenna tower.
4. The antenna is a broadband antenna and its height is adjusted between one meter and four meters above ground to find the maximum value of the field strength for both horizontal polarization and vertical polarization of the antenna.
5. For each suspected emission, the EUT is arranged to its worst case and then adjust the antenna tower (from 1 m to 4 m) and turntable (from 0 degree to 360 degrees) to find the maximum reading.
6. Radiated testing below 1 GHz is performed by adjusting the antenna tower from 1 m to 4 m and by rotating the turn table from 0 degree to 360 degrees to find the peak maximum hold reading. When there is no suspected emission found and the emission level is with at least 6 dB margin against QP limit line, the position is marked as "-".

7. Radiated testing above 1 GHz is performed by adjusting the antenna tower from 1 m to 4 m and by rotating the turn table from 0 degree to 360 degrees to find the peak maximum hold reading for scanning all frequencies. When there is no suspected emission found and the harmonic emission level is with at least 6 dB margin against average limit line, the position is marked as “-”.

3.1.4 Test Setup

For radiated emissions below 30MHz

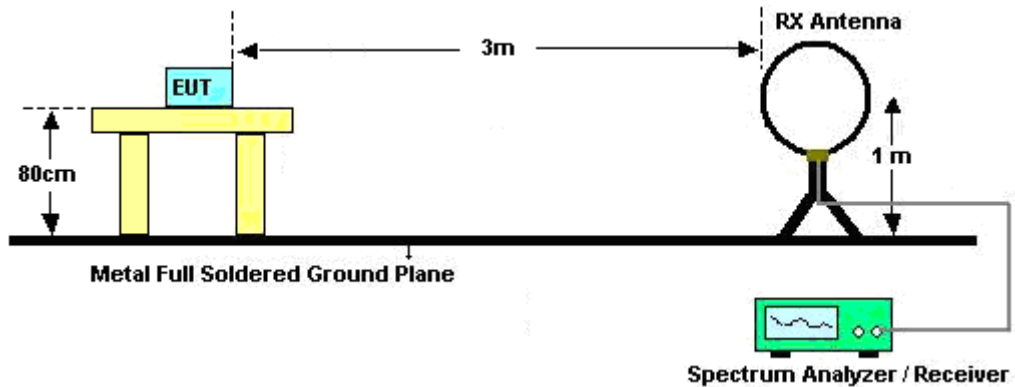

For radiated emissions from 30MHz to 1GHz

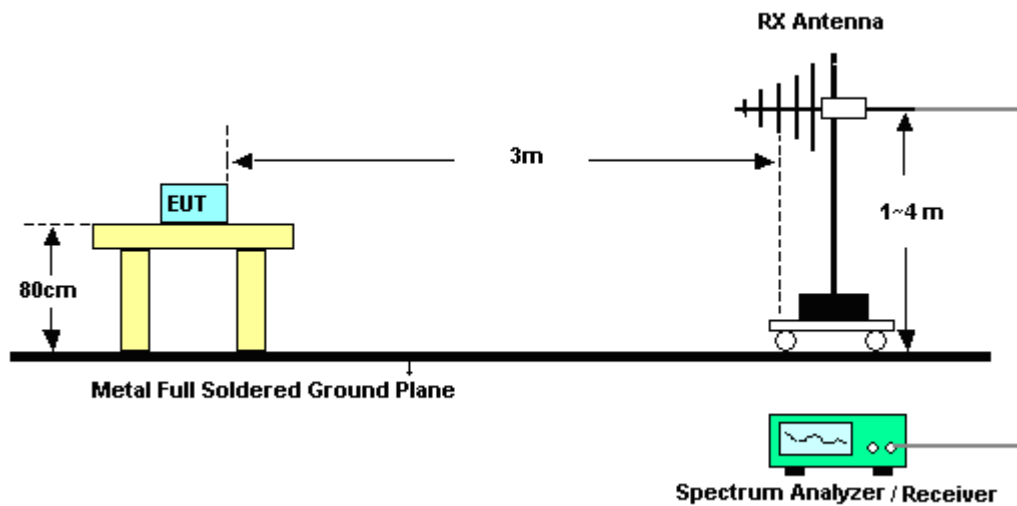

For radiated test from 1GHz to 18GHz

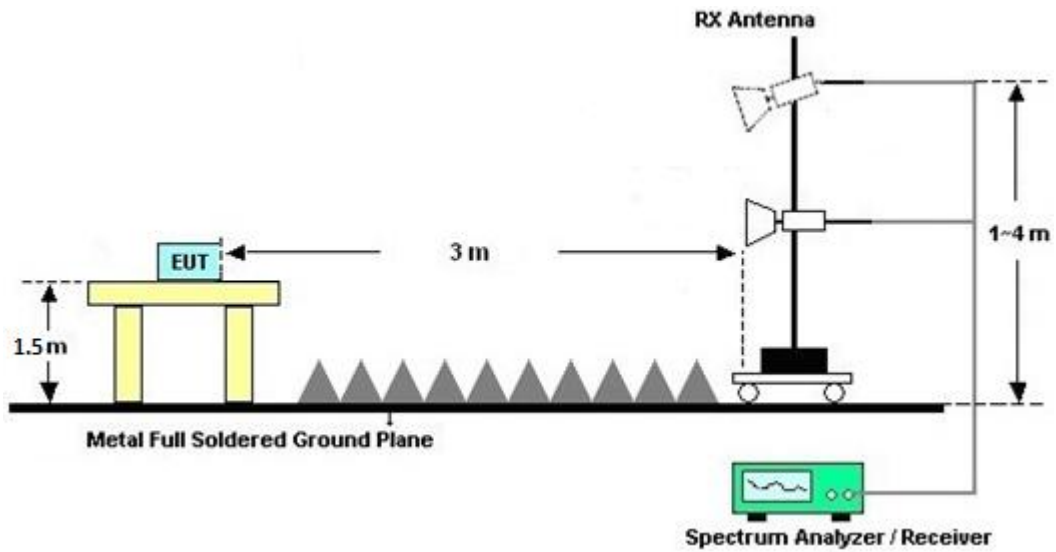

For radiated test above 18GHz

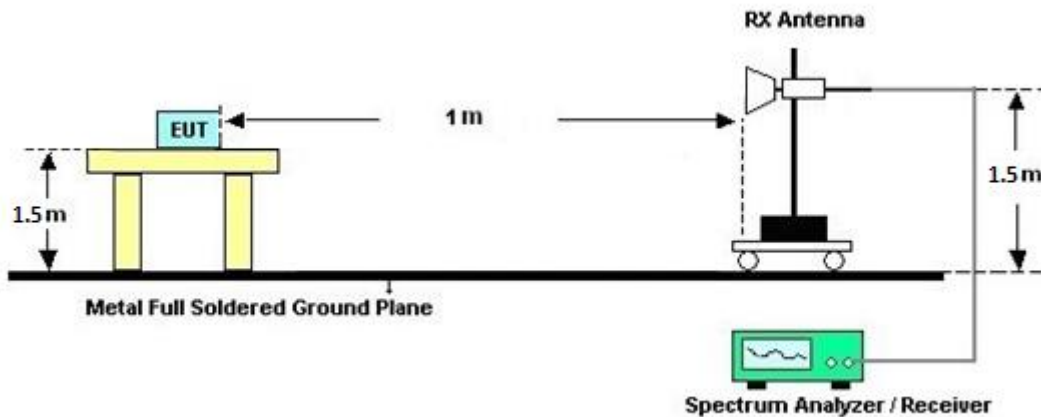

3.1.5 Test Results of Radiated Spurious Emissions (9 kHz ~ 30 MHz)

The low frequency, which starts from 9 kHz to 30 MHz, is pre-scanned and the result which is 20 dB lower than the limit line is not reported.

There is adequate comparison measurement of both open-field test site and alternative test site - semi-Anechoic chamber according to 414788 D01 Radiated Test Site v01r01, and the result came out very similar.



3.1.6 Test Result of Radiated Spurious at Band Edges

Please refer to Appendix A and B.

3.1.7 Duty Cycle

Please refer to Appendix C.

3.1.8 Test Result of Radiated Spurious Emissions (30MHz ~ 10th Harmonic)

Please refer to Appendix A and B.



3.2 Antenna Requirements

3.2.1 Standard Applicable

If transmitting antenna directional gain is greater than 6 dBi, both the peak transmit power and the peak power spectral density shall be reduced by the amount in dB that the directional gain of the antenna exceeds 6 dBi.

3.2.2 Antenna Anti-Replacement Construction

An embedded-in antenna design is used.

3.2.3 Antenna Gain

The antenna peak gain of EUT is less than 6 dBi. Therefore, it is not necessary to reduce maximum peak output power limit.



4 List of Measuring Equipment

Instrument	Brand Name	Model No.	Serial No.	Characteristics	Calibration Date	Test Date	Due Date	Remark
Loop Antenna	Rohde & Schwarz	HFH2-Z2	100315	9 kHz~30 MHz	Jan. 07, 2022	Apr. 29, 2022~ May 13, 2022	Jan. 06, 2023	Radiation (03CH07-HY)
Bilog Antenna	TESEQ	CBL 6111D & 00800N1D01N -06	35419 & 03	30MHz~1GHz	Apr. 24, 2022	Apr. 29, 2022~ May 13, 2022	Apr. 23, 2023	Radiation (03CH07-HY)
Double Ridge Horn Antenna	ESCO	3117	00075962	1GHz ~ 18GHz	Dec. 03, 2021	Apr. 29, 2022~ May 13, 2022	Dec. 02, 2022	Radiation (03CH07-HY)
SHF-EHF Horn Antenna	SCHWARZBE CK	BBHA 9170	BBHA917025 1	18GHz~40GHz	Nov. 30, 2021	Apr. 29, 2022~ May 13, 2022	Nov. 29, 2022	Radiation (03CH07-HY)
Preamplifier	MITEQ	AMF-7D-0010 1800-30-10P	1590075	1GHz~18GHz	Apr. 21, 2022	Apr. 29, 2022~ May 13, 2022	Apr. 20, 2023	Radiation (03CH07-HY)
Preamplifier	COM-POWER	PA-103A	161241	10MHz~1GHz	Oct. 04, 2021	Apr. 29, 2022~ May 13, 2022	Oct. 03, 2022	Radiation (03CH07-HY)
Preamplifier	Agilent	8449B	3008A02362	1GHz~26.5GHz	Oct. 04, 2021	Apr. 29, 2022~ May 13, 2022	Oct. 03, 2022	Radiation (03CH07-HY)
Preamplifier	EMEC	EM18G40G	0600789	18-40GHz	Jul. 23, 2021	Apr. 29, 2022~ May 13, 2022	Jul. 22, 2022	Radiation (03CH07-HY)
Spectrum Analyzer	Agilent	N9030A	MY52350276	3Hz~44GHz	Jul. 22, 2021	Apr. 29, 2022~ May 13, 2022	Jul. 21, 2022	Radiation (03CH07-HY)
RF Cable	HUBER + SUHNER	SUCOFLEX 104	MY15682/4	30MHz to 18GHz	Feb. 23, 2022	Apr. 29, 2022~ May 13, 2022	Feb. 22, 2023	Radiation (03CH07-HY)
RF Cable	HUBER + SUHNER	SUCOFLEX 104	MY24971/4	9kHz to 18GHz	Feb. 23, 2022	Apr. 29, 2022~ May 13, 2022	Feb. 22, 2023	Radiation (03CH07-HY)
RF Cable	HUBER + SUHNER	SUCOFLEX 104	MY28655/4	9kHz to 18GHz	Feb. 23, 2022	Apr. 29, 2022~ May 13, 2022	Feb. 22, 2023	Radiation (03CH07-HY)
RF Cable	HUBER + SUHNER	SUCOFLEX 126	532078/126E	30MHz~18GHz	Sep. 17, 2021	Apr. 29, 2022~ May 13, 2022	Sep. 16, 2022	Radiation (03CH07-HY)
RF Cable	HUBER + SUHNER	SUCOFLEX 102	MY2858/2	18GHz~40GHz	Feb. 23, 2022	Apr. 29, 2022~ May 13, 2022	Feb. 22, 2023	Radiation (03CH07-HY)
RF Cable	HUBER + SUHNER	SUCOFLEX 102	801606/2	9KHz ~ 40GHz	Apr. 14, 2022	Apr. 29, 2022~ May 13, 2022	Apr. 13, 2023	Radiation (03CH07-HY)
Antenna Mast	EMEC	AM-BS-4500E	N/A	Boresight mast 1M~4M	N/A	Apr. 29, 2022~ May 13, 2022	N/A	Radiation (03CH07-HY)
Turn Table	ChainTek	Chaintek 3000	N/A	0~360 Degree	N/A	Apr. 29, 2022~ May 13, 2022	N/A	Radiation (03CH07-HY)
Software	Audix	E3	N/A	N/A	N/A	Apr. 29, 2022~ May 13, 2022	N/A	Radiation (03CH07-HY)
USB Data Logger	TECPEL	TR-32	HE17XB1148	N/A	Oct. 25, 2021	Apr. 29, 2022~ May 13, 2022	Oct. 24, 2022	Radiation (03CH07-HY)



5 Uncertainty of Evaluation

Uncertainty of Radiated Emission Measurement (30 MHz ~ 1000 MHz)

Measuring Uncertainty for a Level of Confidence of 95% ($U = 2Uc(y)$)	5.1 dB
---	--------

Uncertainty of Radiated Emission Measurement (1000 MHz ~ 18000 MHz)

Measuring Uncertainty for a Level of Confidence of 95% ($U = 2Uc(y)$)	5.8 dB
---	--------

Uncertainty of Radiated Emission Measurement (18000 MHz ~ 40000 MHz)

Measuring Uncertainty for a Level of Confidence of 95% ($U = 2Uc(y)$)	4.0 dB
---	--------



Appendix A. Radiated Spurious Emission

Test Engineer :	Jesse Wang, Stan Hsieh and Ken Wu	Temperature :	20~26.9°C
		Relative Humidity :	54.1~67.6%

2.4GHz 2400~2483.5MHz

MIMO <Ant. 1+2>_11ax HE20_TX_CH11 +LTE Band 7_20M (Band Edge @ 3m)

WIFI Ant.	Note	Frequency (MHz)	Level (dBμV/m)	Margin (dB)	Limit Line (dBμV/m)	Read Level (dBμV)	Antenna Factor (dB/m)	Path Loss (dB)	Preamp Factor (dB)	Ant Pos (cm)	Table Pos (deg)	Peak Avg. (P/A)	Pol. (H/V)
Simultaneously 802.11ax HE20 Full CH 11 2462MHz	*	2462	108.21	-	-	93.18	31.9	18.57	35.44	100	89	P	H
	*	2462	99.07	-	-	84.04	31.9	18.57	35.44	100	89	A	H
		2483.72	56.45	-17.55	74	41.23	32.07	18.6	35.45	100	89	P	H
		2483.52	46.37	-7.63	54	31.15	32.07	18.6	35.45	100	89	A	H
													H
													H
	*	2462	103.94	-	-	88.91	31.9	18.57	35.44	384	61	P	V
	*	2462	96.26	-	-	81.23	31.9	18.57	35.44	384	61	A	V
		2498.28	55.59	-18.41	74	40.23	32.19	18.63	35.46	384	61	P	V
		2483.6	44.28	-9.72	54	29.06	32.07	18.6	35.45	384	61	A	V
													V
													V
Remark	1. No other spurious found. 2. All results are PASS against Peak and Average limit line.												



2.4GHz 2400~2483.5MHz

MIMO <Ant. 1+2>_11ax HE20_TX_CH11 + LTE Band 7_20M(Harmonic @ 3m)

WIFI Ant. Simultaneously	Note	Frequency (MHz)	Level (dBμV/m)	Margin (dB)	Limit Line (dBμV/m)	Read Level (dBμV)	Antenna Factor (dB/m)	Path Loss (dB)	Preamp Factor (dB)	Ant Pos (cm)	Table Pos (deg)	Peak Avg. (P/A)	Pol. (H/V)
		4924	39.75	-34.25	74	51.69	34.05	12.79	58.78	-	-	P	H
		7386	40.95	-33.05	74	47.63	35.87	15	57.55	-	-	P	H
		14499	47.97	-26.03	74	44.23	39.6	21.66	57.52	-	-	P	H
		16110	48.76	-25.24	74	40.95	41.2	22.67	56.06	-	-	P	H
		16110	39.02	-14.98	54	31.21	41.2	22.67	56.06	-	-	A	H
		17865	50.69	-23.31	74	40.69	41.47	23.64	55.11	-	-	P	H
		17865	40.52	-13.48	54	30.52	41.47	23.64	55.11	-	-	A	H
													H
													H
													H
													H
													H
802.11ax													H
HE20 Full													H
CH 11													H
2462MHz		4924	40.3	-33.7	74	52.24	34.05	12.79	58.78	-	-	P	V
		7386	40.61	-33.39	74	47.29	35.87	15	57.55	-	-	P	V
		14499	47.14	-26.86	74	43.4	39.6	21.66	57.52	-	-	P	V
		15690	48.63	-25.37	74	42.34	40.38	22.41	56.5	-	-	P	V
		15690	38.04	-15.96	54	31.75	40.38	22.41	56.5	-	-	A	V
		17715	50.92	-23.08	74	41.04	41.51	23.55	55.18	-	-	P	V
		17715	40.53	-13.47	54	30.65	41.51	23.55	55.18	-	-	A	V
													V
													V
													V
													V
													V
													V

Remark

- No other spurious found.
- All results are PASS against Peak and Average limit line.
- The emission position marked as "-" means no suspected emission found with sufficient margin against limit line or noise floor only.
- The emission level close to 18GHz is checked that the average emission level is noise floor only.



Emission above 18GHz

MIMO <Ant. 1+2>_11ax HE20_TX_CH11 + LTE Band 7_20M (SHF)

WIFI	Note	Frequency	Level	Margin	Limit	Read	Antenna	Path	Preamp	Ant	Table	Peak	Pol.
Ant.					Line	Level	Factor	Loss	Factor	Pos	Pos	Avg.	
Simultaneously		(MHz)	(dBμV/m)	(dB)	(dBμV/m)	(dBμV)	(dB/m)	(dB)	(dB)	(cm)	(deg)	(P/A)	(H/V)
2.4GHz 802.11ax HE20 SHF		24951	39.12	-34.88	74	48.33	38.95	9.28	57.44	-	-	P	H
													H
													H
													H
													H
													H
													H
													H
													H
													H
													H
													H
													H
													H
													H
													H
													H
													H
													H
			24958	39.39	-34.61	74	48.59	38.95	9.28	57.43	-	-	P
													V
													V
													V
													V
													V
													V
													V
													V
													V
													V
													V
													V
													V
Remark	1. No other spurious found. 2. All results are PASS against limit line. 3. The emission position marked as "-" means no suspected emission found with sufficient margin against limit line or noise floor only.												



Emission below 1GHz

MIMO <Ant. 1+2>_11ax HE20 + LTE Band 7_20M (LF)

WIFI	Note	Frequency	Level	Margin	Limit	Read	Antenna	Path	Preamp	Ant	Table	Peak	Pol.	
Ant.					Line	Level	Factor	Loss	Factor	Pos	Pos	Avg.		
Simultaneously		(MHz)	(dBμV/m)	(dB)	(dBμV/m)	(dBμV)	(dB/m)	(dB)	(dB)	(cm)	(deg)	(P/A)	(H/V)	
2.4GHz 802.11ax HE20 LF		82.38	28.07	-11.93	40	42.74	13.73	1.64	30.04	-	-	P	H	
		93.45	33.08	-10.42	43.5	46.17	15.19	1.72	30	-	-	P	H	
		166.08	29.01	-14.49	43.5	40.64	15.93	2.3	29.86	-	-	P	H	
		864.2	31.94	-14.06	46	26.8	28.91	5.22	28.99	-	-	P	H	
		939.1	35.05	-10.95	46	28.53	29.67	5.53	28.68	-	-	P	H	
		957.3	34.53	-11.47	46	26.91	30.67	5.58	28.63	-	-	P	H	
														H
														H
														H
														H
														H
														H
			30	32.49	-7.51	40	37.02	24.57	1.01	30.11	-	-	P	V
			92.37	35.01	-8.49	43.5	48.3	15.01	1.71	30.01	-	-	P	V
			168.78	27.73	-15.77	43.5	39.57	15.69	2.33	29.86	-	-	P	V
			840.4	31.43	-14.57	46	26.99	28.43	5.11	29.1	-	-	P	V
			904.1	32.77	-13.23	46	27.48	28.62	5.47	28.8	-	-	P	V
			958	33.73	-12.27	46	26.07	30.71	5.58	28.63	-	-	P	V
														V
														V
													V	
													V	
													V	
													V	
Remark	<ol style="list-style-type: none"> No other spurious found. All results are PASS against limit line. The emission position marked as "-" means no suspected emission found and emission level has at least 6dB margin against limit or emission is noise floor only. 													



Band 1 - 5150~5250MHz

MIMO <Ant. 1+2>_11ax HE80_Tx_CH42 + LTE Band 7_20M (Band Edge @ 3m)

WIFI	Note	Frequency	Level	Margin	Limit	Read	Antenna	Path	Preamp	Ant	Table	Peak	Pol.
Ant.					Line	Level	Factor	Loss	Factor	Pos	Pos	Avg.	
Simultaneously		(MHz)	(dBμV/m)	(dB)	(dBμV/m)	(dBμV)	(dB/m)	(dB)	(dB)	(cm)	(deg)	(P/A)	(H/V)
802.11ax HE80 Full CH 42 5210MHz		5146.64	60.02	-13.98	74	49.36	34.1	11.84	35.28	100	21	P	H
		5149.24	50.16	-3.84	54	39.5	34.1	11.84	35.28	100	21	P	H
	*	5210	100.39	-	-	89.39	34.34	11.91	35.25	100	21	P	H
	*	5210	92.09	-	-	81.09	34.34	11.91	35.25	100	21	A	H
		5435.64	48.8	-25.2	74	37.19	34.7	12.05	35.14	100	21	P	H
		5457.76	39.38	-14.62	54	27.73	34.7	12.08	35.13	100	21	A	H
		5148.72	61.9	-12.1	74	51.24	34.1	11.84	35.28	108	254	P	V
		5149.5	51.2	-2.8	54	40.54	34.1	11.84	35.28	108	254	A	V
	*	5210	101.36	-	-	90.36	34.34	11.91	35.25	108	254	P	V
	*	5210	92.38	-	-	81.38	34.34	11.91	35.25	108	254	A	V
		5362.28	48.68	-25.32	74	37.25	34.62	11.99	35.18	108	254	P	V
		5350.8	39.34	-14.66	54	27.94	34.6	11.98	35.18	108	254	A	V
Remark	1. No other spurious found. 2. All results are PASS against Peak and Average limit line.												



MIMO <Ant. 1+2>_11ax HE80_Tx_CH42 + LTE Band 7_20M (Harmonic @ 3m)

WIFI Ant. Simultaneously	Note	Frequency (MHz)	Level (dBμV/m)	Margin (dB)	Limit Line (dBμV/m)	Read Level (dBμV)	Antenna Factor (dB/m)	Path Loss (dB)	Preamp Factor (dB)	Ant Pos (cm)	Table Pos (deg)	Peak Avg. (P/A)	Pol. (H/V)	
802.11ax HE80 Full CH 42 5210MHz		10420	44.21	-23.99	68.2	47.02	37.46	18.47	58.74	-	-	P	H	
		13358	47.51	-26.49	74	45.32	39.08	21.05	57.94	-	-	P	H	
		14480	47.23	-26.77	74	43.24	39.56	21.96	57.53	-	-	P	H	
		15630	46.68	-27.32	74	40.37	40.26	22.65	56.6	-	-	P	H	
		17813	51.15	-22.85	74	40.35	41.57	24.37	55.14	-	-	P	H	
		17813	41.29	-12.71	54	30.49	41.57	24.37	55.14	-	-	A	H	
														H
														H
														H
														H
														H
														H
			10420	44.51	-23.69	68.2	47.32	37.46	18.47	58.74	-	-	P	V
			13369	47.75	-26.25	74	45.57	39.06	21.06	57.94	-	-	P	V
			14502	47.8	-20.4	68.2	43.74	39.6	21.98	57.52	-	-	P	V
			15630	46.1	-27.9	74	39.79	40.26	22.65	56.6	-	-	P	V
			17846	51.25	-22.75	74	40.47	41.51	24.39	55.12	-	-	P	V
			17846	41.53	-12.47	54	30.75	41.51	24.39	55.12	-	-	A	V
														V
														V
													V	
													V	
													V	
													V	
Remark	<ol style="list-style-type: none"> No other spurious found. All results are PASS against Peak and Average limit line. The emission position marked as "-" means no suspected emission found with sufficient margin against limit line or noise floor only. The emission level close to 18GHz is checked that the average emission level is noise floor only. 													



Emission above 18GHz
MIMO <Ant. 1+2>_11ax HE80_Tx_CH42 + LTE Band 7_20M (SHF @ 1m)

WIFI	Note	Frequency	Level	Margin	Limit	Read	Antenna	Path	Preamp	Ant	Table	Peak	Pol.
Ant.					Line	Level	Factor	Loss	Factor	Pos	Pos	Avg.	
Simultaneously		(MHz)	(dBμV/m)	(dB)	(dBμV/m)	(dBμV)	(dB/m)	(dB)	(dB)	(cm)	(deg)	(P/A)	(H/V)
802.11ax HE80 Full SHF		39912	41.76	-32.24	74	40.74	44.6	14.8	58.38	-	-	P	H
													H
													H
													H
													H
													H
													H
													H
													H
													H
													H
													H
													H
													H
													H
													H
													H
													H
													H
			38988	41.01	-32.99	74	42.51	44.27	14.44	60.21	-	-	P
													V
													V
													V
													V
													V
													V
													V
													V
													V
													V
													V
													V
													V
Remark	1. No other spurious found. 2. All results are PASS against limit line. 3. The emission position marked as "-" means no suspected emission found with sufficient margin against limit line or noise floor only.												



Emission below 1GHz
MIMO <Ant. 1+2>_11ax HE80_Tx_CH42 + LTE Band 7_20M (LF @ 3m)

WIFI	Note	Frequency	Level	Margin	Limit	Read	Antenna	Path	Preamp	Ant	Table	Peak	Pol.	
Ant.					Line	Level	Factor	Loss	Factor	Pos	Pos	Avg.		
Simultaneously		(MHz)	(dBμV/m)	(dB)	(dBμV/m)	(dBμV)	(dB/m)	(dB)	(dB)	(cm)	(deg)	(P/A)	(H/V)	
802.11ax HE80 Full LF		30.27	22.84	-17.16	40	27.57	24.37	1.01	30.11	-	-	P	H	
		93.18	34.97	-8.53	43.5	48.08	15.17	1.72	30	-	-	P	H	
		167.7	32.14	-11.36	43.5	43.89	15.79	2.32	29.86	-	-	P	H	
		830.6	31.64	-14.36	46	27.85	27.83	5.09	29.13	-	-	P	H	
		879.6	32.11	-13.89	46	26.98	28.72	5.32	28.91	-	-	P	H	
		950.3	33.9	-12.1	46	26.67	30.33	5.55	28.65	-	-	P	H	
														H
														H
														H
														H
														H
			30	32.52	-7.48	40	37.05	24.57	1.01	30.11	-	-	P	V
			66.99	26.41	-13.59	40	43.07	11.97	1.4	30.03	-	-	P	V
			92.1	34.76	-8.74	43.5	48.11	14.95	1.71	30.01	-	-	P	V
			853.7	32.16	-13.84	46	27.28	28.77	5.15	29.04	-	-	P	V
			913.9	32.84	-13.16	46	27.31	28.82	5.48	28.77	-	-	P	V
			951.7	33.9	-12.1	46	26.59	30.39	5.56	28.64	-	-	P	V
														V
														V
														V
													V	
													V	
													V	
Remark	1. No other spurious found. 2. All results are PASS against limit line. 3. The emission position marked as "-" means no suspected emission found and emission level has at least 6dB margin against limit or emission is noise floor only.													



Note symbol

*	Fundamental Frequency which can be ignored. However, the level of any unwanted emissions shall not exceed the level of the fundamental frequency.
!	Test result is over limit line.
P/A	Peak or Average
H/V	Horizontal or Vertical



A calculation example for radiated spurious emission is shown as below:

WIFI	Note	Frequency	Level	Margin	Limit	Read	Antenna	Path	Preamp	Ant	Table	Peak	Pol.
Ant.					Line	Level	Factor	Loss	Factor	Pos	Pos	Avg.	
1+2		(MHz)	(dBμV/m)	(dB)	(dBμV/m)	(dBμV)	(dB/m)	(dB)	(dB)	(cm)	(deg)	(P/A)	(H/V)
802.11b		2390	55.45	-18.55	74	54.51	32.22	4.58	35.86	103	308	P	H
CH 01													
2412MHz		2390	43.54	-10.46	54	42.6	32.22	4.58	35.86	103	308	A	H

1. Path Loss(dB) = Cable loss(dB) + Filter loss(dB) + Attenuator loss(dB)
2. Level(dBμV/m) =
Antenna Factor(dB/m) + Path Loss(dB) + Read Level(dBμV) - Preamp Factor(dB)
3. Over Limit(dB) = Level(dBμV/m) – Limit Line(dBμV/m)

For Peak Limit @ 2390MHz:

1. Level(dBμV/m)
= Antenna Factor(dB/m) + Path Loss(dB) + Read Level(dBμV) - Preamp Factor(dB)
= 32.22(dB/m) + 4.58(dB) + 54.51(dBμV) – 35.86 (dB)
= 55.45 (dBμV/m)
2. Over Limit(dB)
= Level(dBμV/m) – Limit Line(dBμV/m)
= 55.45(dBμV/m) – 74(dBμV/m)
= -18.55(dB)

For Average Limit @ 2390MHz:

1. Level(dBμV/m)
= Antenna Factor(dB/m) + Path Loss(dB) + Read Level(dBμV) - Preamp Factor(dB)
= 32.22(dB/m) + 4.58(dB) + 42.6(dBμV) – 35.86 (dB)
= 43.54 (dBμV/m)
2. Over Limit(dB)
= Level(dBμV/m) – Limit Line(dBμV/m)
= 43.54(dBμV/m) – 54(dBμV/m)
= -10.46(dB)

Both peak and average measured complies with the limit line, so test result is "PASS".



Appendix B. Radiated Spurious Emission Plots

Test Engineer :	Jesse Wang, Stan Hsieh and Ken Wu	Temperature :	20~26.9°C
		Relative Humidity :	54.1~67.6%

Note symbol

-L	Low channel location
-R	High channel location



2.4GHz 2400~2483.5MHz

MIMO <Ant. 1+2>_11ax HE20_TX_CH11 + LTE Band 7_20M (Band Edge @ 3m)

WIFI	2.4GHz 2400~2483.5MHz Band Edge @ 3m	
ANT	802.11ax HE20 Full CH11 2462MHz	
Simultaneously	Horizontal	Fundamental
Peak	<p>Site : 03CH07-HY Condition : PEAK_BE_74 3m HF_ANT_00075962 HORIZONTAL : RBW:1000.000kHz VBW:3000.000kHz SWT:Auto</p>	<p>Site : 03CH07-HY Condition : PEAK_74 3m HF_ANT_00075962 HORIZONTAL : RBW:1000.000kHz VBW:3000.000kHz SWT:Auto</p>
Avg.	<p>Site : 03CH07-HY Condition : AVG_BE_54 3m HF_ANT_00075962 HORIZONTAL : RBW:1000.000kHz VBW:3000.000kHz SWT:Auto</p>	<p>Site : 03CH07-HY Condition : AVG_54 3m HF_ANT_00075962 HORIZONTAL : RBW:1000.000kHz VBW:3000.000kHz SWT:Auto</p>

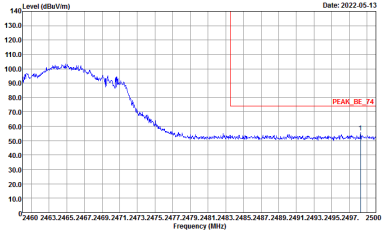
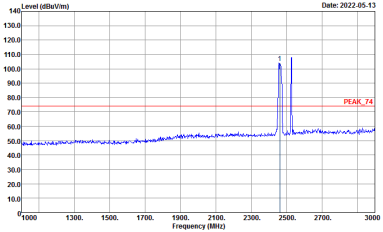
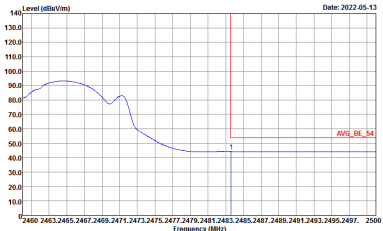
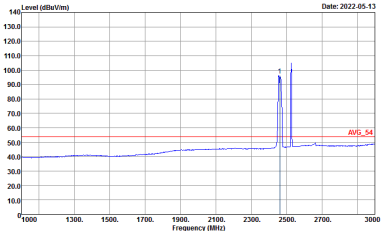

WIFI	2.4GHz 2400~2483.5MHz Band Edge @ 3m	
ANT	802.11ax HE20 Full CH11 2462MHz	
Simultaneously	Vertical	Fundamental
<p>Peak</p>	 <p>Date: 2022-05-13</p> <p>Site : 03CH07-HY Condition : PEAK_BE_74 3m HF_ANT_00075962 VERTICAL : RBW:1000.000KHz VBW:3000.000KHz SWT:Auto</p>	 <p>Date: 2022-05-13</p> <p>Site : 03CH07-HY Condition : PEAK_74 3m HF_ANT_00075962 VERTICAL : RBW:1000.000KHz VBW:3000.000KHz SWT:Auto</p>
<p>Avg.</p>	 <p>Date: 2022-05-13</p> <p>Site : 03CH07-HY Condition : AVG_BE_54 3m HF_ANT_00075962 VERTICAL : RBW:1000.000KHz VBW:0.010KHz SWT:Auto</p>	 <p>Date: 2022-05-13</p> <p>Site : 03CH07-HY Condition : AVG_54 3m HF_ANT_00075962 VERTICAL : RBW:1000.000KHz VBW:0.010KHz SWT:Auto</p>



2.4GHz 2400~2483.5MHz

MIMO <Ant. 1+2>_11ax HE20_TX_CH11 + LTE Band 7_20M (Harmonic @ 3m)

WIFI	2.4GHz 2400~2483.5MHz Harmonic @ 3m	
ANT	802.11 ax HE20 Full CH11 2462MHz	
Simultaneously	Horizontal	Vertical
<p>Peak</p> <p>Avg.</p>	<p>Site : 03CH07-HY Condition : PEAK_74 3m HF_ANT_00075962 HORIZONTAL</p>	<p>Site : 03CH07-HY Condition : PEAK_74 3m HF_ANT_00075962 VERTICAL</p>



Emission above 18GHz

MIMO <Ant. 1+2>_11ax HE20_TX_CH11 + LTE Band 7_20M (SHF @ 1m)

WIFI	2.4GHz 2400~2483.5MHz	
ANT	802.11ax HE20 Full SHF	
Simultaneously	Horizontal	Vertical
<p>Peak</p> <p>Avg.</p>	<p>Site : 03CH07-HY Condition : PEAK_T4 1m SHF-EHF_9170251 HORIZONTAL</p>	<p>Site : 03CH07-HY Condition : PEAK_T4 1m SHF-EHF_9170251 VERTICAL</p>



Emission below 1GHz

MIMO <Ant. 1+2>_11ax HE20_TX_CH11 + LTE Band 7_20M (LF)

WIFI	2.4GHz 2400~2483.5MHz	
ANT	802.11ax HE20 Full LF	
Simultaneously	Horizontal	Vertical
QP / Peak	<p>Site : 03CH07-HY Condition : QP 3m LF-ANT-35419(6) HORIZONTAL</p>	<p>Site : 03CH07-HY Condition : QP 3m LF-ANT-35419(6) VERTICAL</p>



Band 1 - 5150~5250MHz

MIMO <Ant. 1+2>_11ax HE80_Tx_CH42 + LTE Band 7_20M (Band Edge @ 3m)

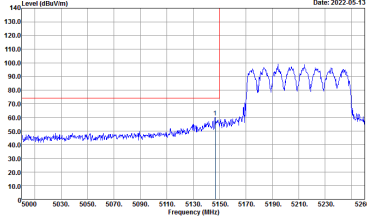
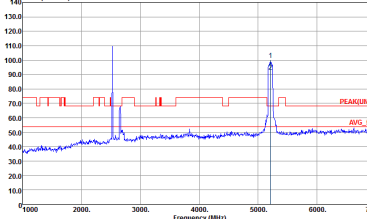
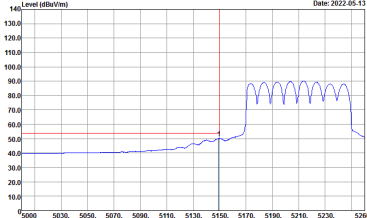
WIFI	Band 1 5150~5250MHz Band Edge @ 3m	
ANT	802.11ax HE80 Full CH42 5210MHz - L	
Simultaneously	Horizontal	Fundamental
<p style="text-align: center;">Peak</p>	 <p style="font-size: small;">Date: 2022-05-13 Site : 03CH07-HY Condition : PEAK_BE_24 3m HF_ANT_00075962 HORIZONTAL : RBW:1000.000kHz VBW:3000.000kHz SWT:Auto</p>	 <p style="font-size: small;">Date: 2022-05-13 Site : 03CH07-HY Condition : PEAK(LIN) 3m HF_ANT_00075962 HORIZONTAL : RBW:1000.000kHz VBW:3000.000kHz SWT:Auto</p>
<p style="text-align: center;">Avg.</p>	 <p style="font-size: small;">Date: 2022-05-13 Site : 03CH07-HY Condition : AVG_BE_24 3m HF_ANT_00075962 HORIZONTAL : RBW:1000.000kHz VBW:3000.000kHz SWT:Auto</p>	<p style="text-align: center;">Left blank</p>

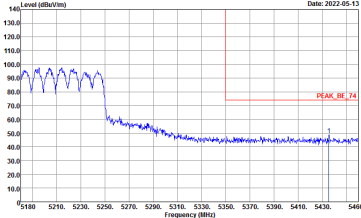
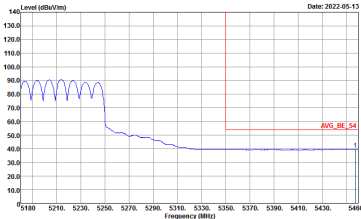

WIFI	Band 1 5150~5250MHz Band Edge @ 3m	
ANT	802.11ax HE80 Full CH42 5210MHz - R	
Simultaneously	Horizontal	Fundamental
<p style="text-align: center;">Peak</p>	 <p style="font-size: small;">Date: 2022-05-13 Site : 03CH07-HY Condition : PEAK_BE_74 3m HF_ANT_00075962 HORIZONTAL : RBW:1000.000kHz VBW:3000.000kHz SWT:Auto</p>	<p style="text-align: center;">Left blank</p>
<p style="text-align: center;">Avg.</p>	 <p style="font-size: small;">Date: 2022-05-13 Site : 03CH07-HY Condition : AVG_BE_54 3m HF_ANT_00075962 HORIZONTAL : RBW:1000.000kHz VBW:0.010kHz SWT:Auto</p>	<p style="text-align: center;">Left blank</p>

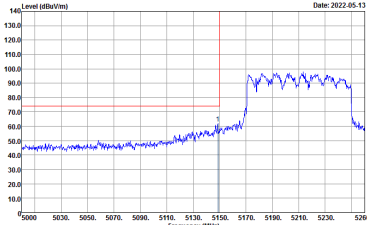
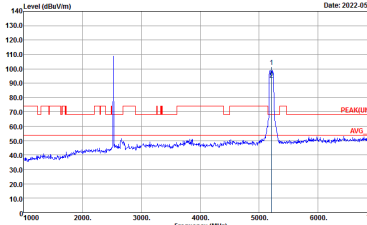
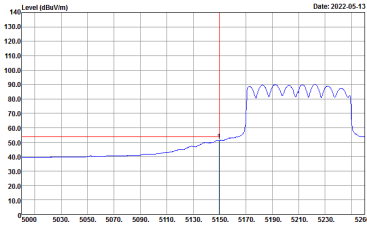

WIFI	Band 1 5150~5250MHz Band Edge @ 3m	
ANT	802.11ax HE80 Full CH42 5210MHz - L	
Simultaneously	Vertical	Fundamental
<p style="text-align: center;">Peak</p>	 <p>Site : 03CH7-HY Condition : PEAK_BE_74 3m HF_ANT_00075962 VERTICAL : RBW:1000.000kHz VBW:3000.000kHz SWT:Auto</p>	 <p>Site : 03CH7-HY Condition : PEAK(LIN1) 3m HF_ANT_00075962 VERTICAL : RBW:1000.000kHz VBW:3000.000kHz SWT:Auto</p>
<p style="text-align: center;">Avg.</p>	 <p>Site : 03CH7-HY Condition : AVG_BE_54 3m HF_ANT_00075962 VERTICAL : RBW:1000.000kHz VBW:3.010kHz SWT:Auto</p>	<p style="text-align: center;">Left blank</p>

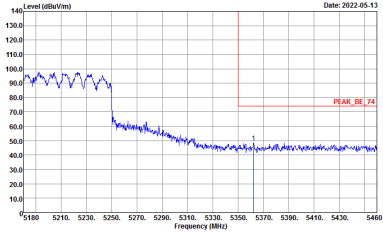
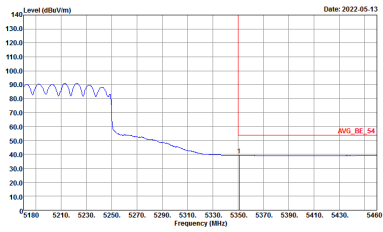

WIFI	Band 1 5150~5250MHz Band Edge @ 3m	
ANT	802.11ax HE80 Full CH42 5210MHz - R	
Simultaneously	Vertical	Fundamental
<p style="text-align: center;">Peak</p>	 <p style="font-size: small;">Date: 2022-05-13 Site : 03CH07-HY Condition : PEAK_BE_74 3m HF_ANT_00075962 VERTICAL : RBW:1000.000kHz VBW:3000.000kHz SWT:Auto</p>	<p style="text-align: center;">Left blank</p>
<p style="text-align: center;">Avg.</p>	 <p style="font-size: small;">Date: 2022-05-13 Site : 03CH07-HY Condition : AVG_BE_54 3m HF_ANT_00075962 VERTICAL : RBW:1000.000kHz VBW:0.010kHz SWT:Auto</p>	<p style="text-align: center;">Left blank</p>



Band 1 - 5150~5250MHz

MIMO <Ant. 1+2>_11ax HE80_Tx_CH42 + LTE Band 7_20M (Harmonic @ 3m)

WIFI	Band 1 5150~5250MHz Harmonic @ 3m	
ANT	802.11ax HE80 Full CH42 5210MHz	
Simultaneously	Horizontal	Vertical
<p>Peak Avg.</p>		



Emission above 18GHz

MIMO <Ant. 1+2>_11ax HE80_Tx_CH42 + LTE Band 7_20M (SHF @ 1m)

WIFI	5GHz WIFI	
ANT	802.11ax HE80 Full SHF	
Simultaneously	Horizontal	Vertical
<p>Peak</p> <p>Avg.</p>	<p>Site : 03CH07-HY Condition : PEAK(U/NII) 1m SHF-EHF_9170251 HORIZONTAL</p>	<p>Site : 03CH07-HY Condition : PEAK(U/NII) 1m SHF-EHF_9170251 VERTICAL</p>



Emission below 1GHz

MIMO <Ant. 1+2>_11ax HE80_Tx_CH42 + LTE Band 7_20M (LF)

WIFI	5GHz WIFI	
ANT	802.11ax HE80 Full LF	
Simultaneously	Horizontal	Vertical
QP / Peak	<p>Site : 03CH07-HY Condition : QP 3m LF-ANT-35412(S) HORIZONTAL</p>	<p>Site : 03CH07-HY Condition : QP 3m LF-ANT-35412(S) VERTICAL</p>



Appendix C. Duty Cycle Plots

Band	Duty Cycle(%)	T(us)	1/T(kHz)	VBW Setting
2.4GHz 802.11ax HE20	99.63	-	-	10Hz
5GHz 802.11ax HE80	99.63	-	-	10Hz

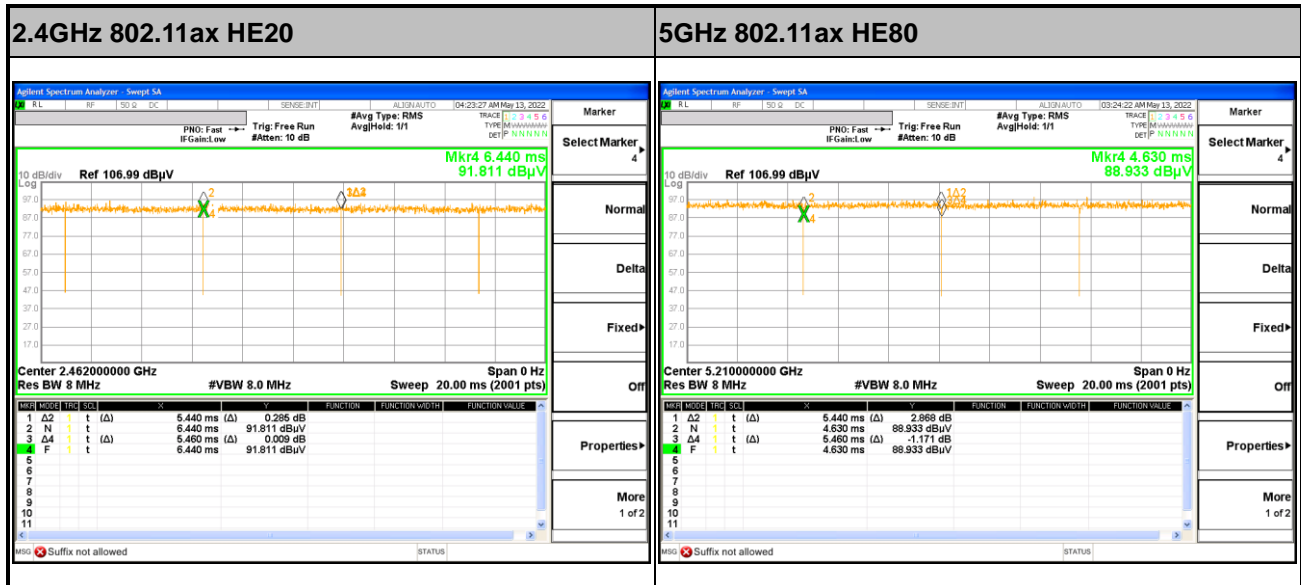

Appendix D. Setup Photographs

<Radiated Emission>

X Plane

LF

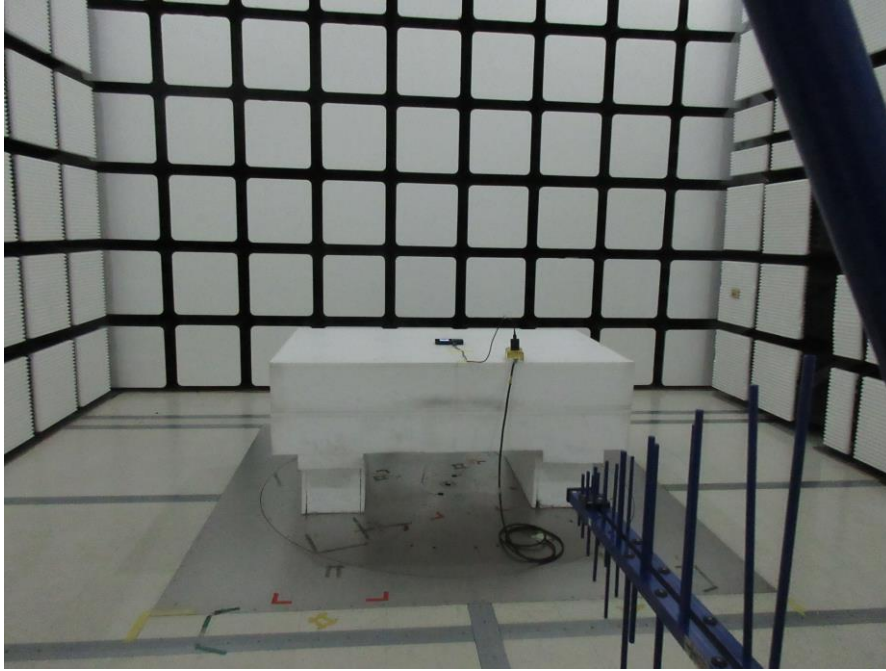

HF

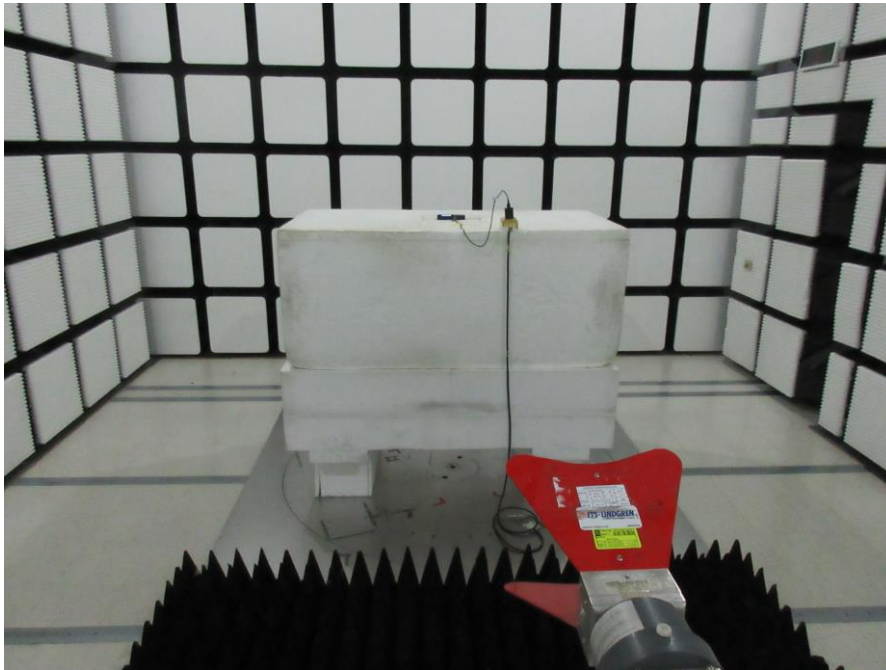

SHF



————THE END————