



**Portable Hotspot
FCC ID: PKRISGM3000A
&
FCC ID: PKRISGM3100**

**Band n261
Power Density Simulation Report**

May 17, 2022

Revision 1.0

Table of Contents

Contents

1 GENERAL	3
1.1 SCOPE	3
2 THEORY OF OPERATION	4
2.1 BEAM FORMING	4
2.0 TX DUTY CYCLE	4
3 SIMULATION METHODOLOGY	4
3.1 ELECTROMAGNETIC SIMULATION	4
3.1.1 Tool Description	4
3.1.2 Solver Description	5
3.1.3 Power Density Calculation	5
3.1.4 Power Averaging	6
3.1.5 3D Modeling	6
3.1.6 Antenna source excitation.....	7
3.1.7 Power Density evaluation surfaces	7
3.1.8 Simulation to Find worst case value	8
4 SIMULATION SETUP	9
4.1 SIMULATED SETUP OVER THE PRE-DEFINED PLANE	9
4.2 INPUT POWER.....	10
5 VALIDATION OF SIMULATION MODEL	10
5.1 COMPARISON BETWEEN SIMULATED AND MEASURED	10
5.2 SUMMARIZED SIMULATED PD VS MEASURED PD TEST RESULTS.....	10
6 SIMULATION RESULTS	19
6.1 POWER DENSITY FOR BAND N261:.....	19
6.1.1 Ant-0 – Simulated Power Density	19
6.1.2 Ant-1 – Simulated Power Density	20
7 SUMMARY	21
7.1 UNCERTAINTY	21

1 General

1.1 Scope

This report is intended to support FCC compliance for the mobile hotspot using millimeter Wave (mmW) antenna modules.

Per the location of the antenna modules inside the hotspot platform, the distance between the antenna to the body of an end user, at the closest contact point, will be in the near field.

Near field power density calculations were estimated using EM simulation that includes the antenna module embedded inside the hotspot 3D model. These results are documented in the following sections of this report.

To prove the validity of these results, we will show how the results of the simulations are well correlated, to lab measurements of the antenna module inside the hotspot platform, for transition field to far field distances, where the theoretical far field boundary is calculated for reference. The near field simulation results are also presented in this document.

Chapter 2 provides relevant background on the antenna module. Chapter 3 describes the simulation methodology to determine RF exposure (power density) levels. Chapter 4 describes simulation setup. Chapter 5 covers validation and correlation between simulation and lab measurements. Chapter 6 shows simulated PD results. Chapter 7 provides a summary of the RF-Exposure analysis.

2 Theory of Operation

2.1 Beam Forming

Due to the high path loss of the mmW signal travelling between the transmitting and receiving points, 5G communication can be achieved by employing antenna arrays with directionally high gain to compensate for the high path loss. Only one antenna module can be functional at any given time.

In the antenna module, such an electronic steering antenna array with approximately ± 45 -degree steering angles being used. Beam forming is used to find the right direction for setting both the Rx and Tx beam directions. Many individual beams can be formed from a single module. This is accomplished by changing polarization, phase, or combinations thereof.

The number of antenna ports of the antenna array module consists of 20 ports (4 for each patch antenna), 10 vertically polarized ports and 10 horizontally polarized ports, respectively. The antenna ports are controlled by firmware (FW). The phase, polarization and number of ports used can change. The ports are selected per the created “code book” and is custom for each product. The code book lists the phase, polarization, and combinations to be used for beamforming. In the 20 ports available in each patch antenna array, 10 ports are used to excite bands n257, n258 and n261, and 10 ports are used to excite band n260.

The ideal array structure is constructed to achieve the highest gain when the port combinations of the patch array elements are fed in phase to form a forward-looking high gain beam to the antenna origin (AZ, EL) = (0, 0).

2.0 Tx Duty Cycle

To capture worst-case power density conditions, simulations and measurements were performed assuming a 100% duty cycle. The TX-Duty-Cycle is established based on hardware (HW) and FW implementation.

3 Simulation Methodology

3.1 Electromagnetic Simulation

3.1.1 Tool Description

For the EM simulation to calculate power density (PD) for mobile hotspot using qty. 2, MMW antenna modules, we use the commercially available ANSYS HFSS 2021 R2 (previously known as HFSS). ANSYS HFSS is widely used in industry for simulating 3D full-wave electromagnetic fields for antenna and RF radiation problem of high frequency component. ANSYS HFSS is implemented based on the Finite Element Method (FEM) operates in the frequency domain.

3.1.2 Solver Description

The HFSS tool is employing Finite Element Method in frequency domain to solve the EM fields in 3D space which is based on an accurate direct solver with first or second order basis functions. To start solving the problem, a volume containing the objects will be subdivided into electrically small regions that are called finite elements as the unknown functions. To subdivide system, the adaptive mesh method in HFSS is used. Then, HFSS starts to refine the initial mesh based on the designed wavelength and calculate the error for each iteration process with adaptive mesh refinement. The determination parameter of the number of iterations in HFSS is defined as convergence criteria, delta S, and the iterative adaptive mesh process repeats until the delta S is met. The accuracy of converged results depends on the delta S. The default setting in the HFSS for delta S is 2%. Depending on the nature of problem, smaller delta S can be set during the solving stage. Fig. 1 is an example of final adaptive mesh of the antenna modules used in the simulation.

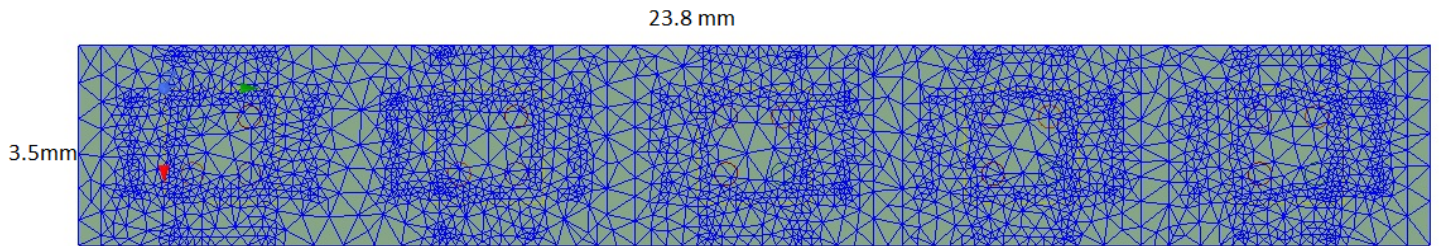

Fig. 1 Example of the adaptive mesh used in HFSS

3.1.3 Power Density Calculation

After simulation, HFSS can generate the electric and magnetic fields in each surface. For power density calculation, the electric field (\vec{E}) and magnetic field (\vec{H}) are needed. The actual consumption power can be expressed as the real part of the Poynting vector (\vec{P}) from the cross product of \vec{E} and the complex conjugation of \vec{H} as shown below:

$$\vec{P} = \frac{1}{2} \text{Re}(\vec{E} \times \vec{H}^*) \quad (1)$$

\vec{P} can be expressed as the localized power density based on a peak value of each spatial point on mesh grids and obtained directly from ANSYS HFSS simulation results. From the localized power density, the average power density can be evaluated over a 4 cm² square on any surfaces. The power density is calculated in the relevant plan (10 mm away from the hotspot plastic housing) over a surface of 4 cm² square.

3.1.4 Power Averaging

After the simulation has completed the E and H fields, power density can be calculated for the predefined surfaces. The figure shown below is an example of the power density for an antenna module at a predefined surface

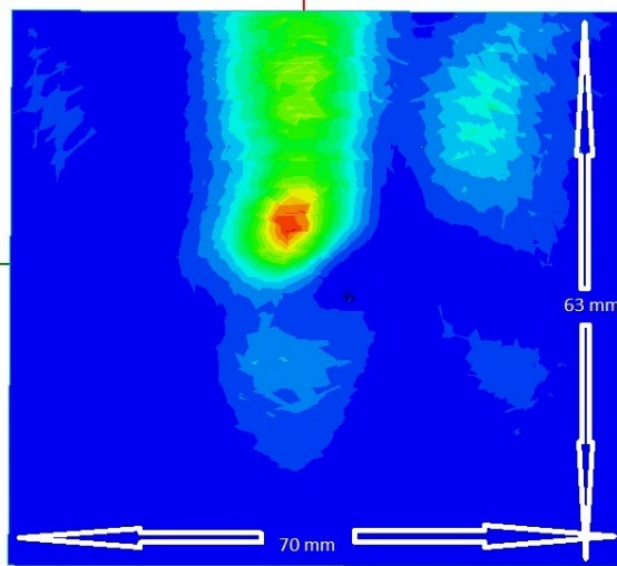

Fig. 2 – Example of calculated power density from HFSS

3.1.5 3D Modeling

Figure 3 and 4 show the 3D simulation model using mm Wave antenna modules. The simulation modeling includes all the major components of the hotspot. These include items such as the Housing, PCB, metal antenna holder, display, touch panel, battery, legacy antennas and two QTM545 antenna modules 0 (Ant-0) and 1 (Ant-1), etc. This device level simulation model for PD calculations is constructed according to our best engineering practices. Due to the non-availability of material properties in the mm wave range, the material properties used in the model are to the best of our engineering knowledges. Some material properties are shown in table 1.

Table 1 – Material Properties

Model Components	Dielectric Material	Dielectric Constant	Loss Tangent
Display, Heatsink, RJ45 & Shields	Aluminum	1.0	0
Battery & Touch Screen	Copper	1.0	0
PCB	FR4	4.4	0.02
Touch Panel Glass	Glass	5.5	0.4
Battery Door, Top & Bottom Housings	PC/ABS	3.6	0.1

All the material properties used in the simulation model are chosen to be as close to the real device.

Fig. 3 – 3D model details

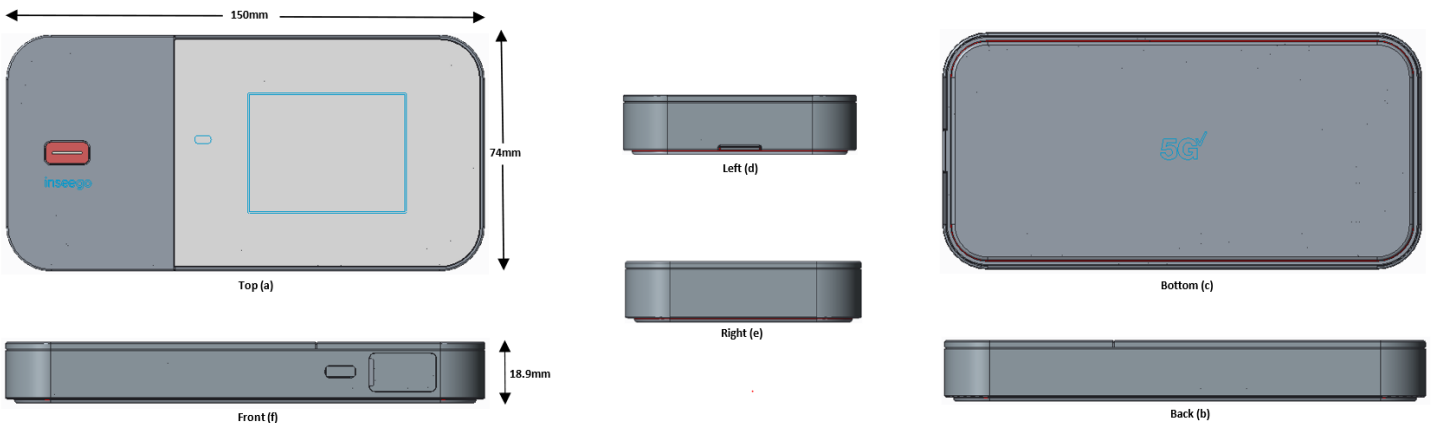

Both antenna modules are mounted above the PCB top layer and legacy antennas around the perimeter of the housing. Per figure 3, the antenna modules are positioned in the following way, Ant-0 faces the top side (a), Ant-1 faces the front side (f)

3.1.6 Antenna source excitation

The number of ports of each antenna module consists of 20 ports. The antenna module divides into 20 ports evenly for the 1x5 patch array. 4 ports included in each patch element, 4 ports are divided into 2 vertical polarization, and 2 horizontal polarization feedings. In each patch element, 2 ports are used for low band (n257, n258, and n261 with frequency 24.25 to 29.5 GHz), 2 ports are used for high band (n260 with frequency 37 to 40 GHz). The patch array antenna consists of 5 patch elements. Each uses four ports as a source excitation. The input power and phase of each port are fed according to the “Code Book” when in operation.

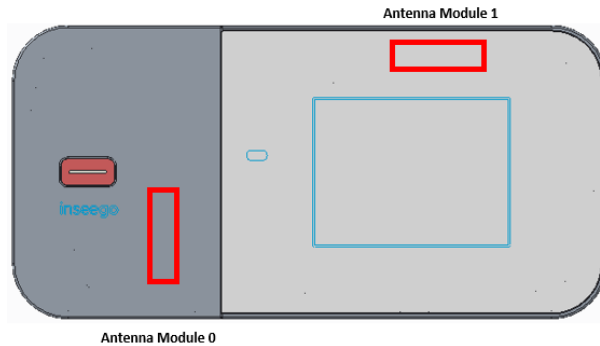

Fig. 4 – Simulation model showing the mounted locations of the antenna modules

3.1.7 Power Density evaluation planes

Each antenna module is individually evaluated for worst case PD using multiple evaluation surfaces. Surfaces S1, S2, S3, S4 and S5 are for antenna module 0 (Ant-0) and surfaces S6, S7, S8 and S9 are for antenna module 1 (Ant-1). These Surfaces, S1 through S9, are positioned 10mm away from the hotspot housing surface. All the

material properties used in the simulation model are chosen to be as close to the real device. Since PD values on S4 and S8 are much smaller than the other surfaces, their PD will not be used for verification. Table 2 shows the PD evaluation surfaces for each antenna module and Figures 5 and 5b illustrate the PD evaluation surfaces and truncation areas of the simulation model which are used to find the worst-case beamforming cases.

Table 2 - PD Simulation evaluation planes

Antenna Module	TOP	BOTTOM	FRONT	RIGHT	LEFT
0	S1	S3	S2	S5	S4
1	S6	S8	S7	X	S9

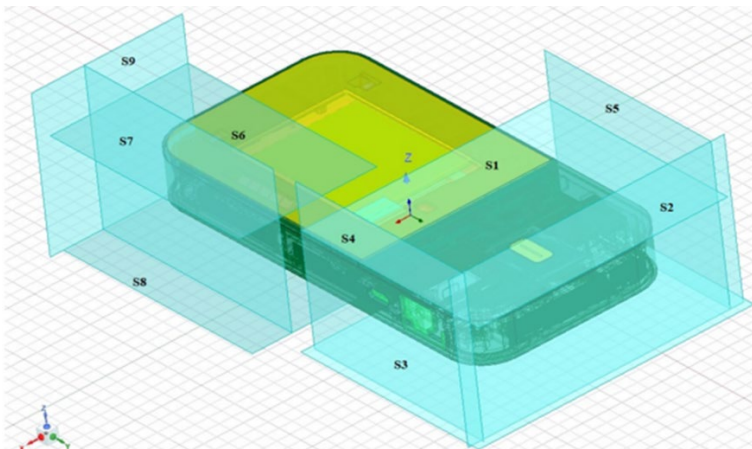

Fig. 5 – power density evaluation planes and truncation areas

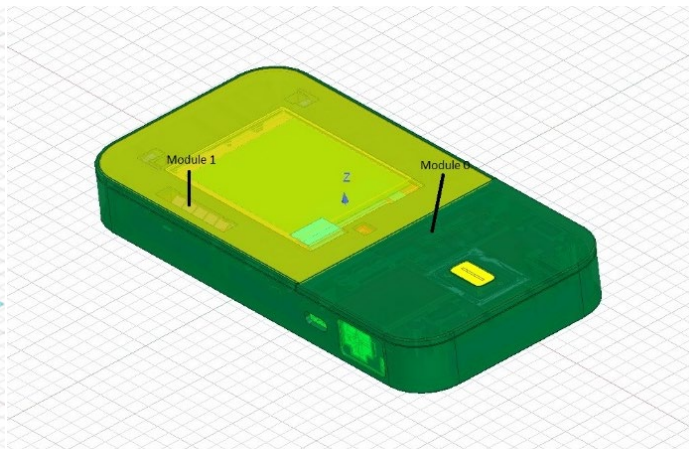

Fig. 5b – antenna modules in simulation model

3.1.8 Simulation to locate worst case value

To find the maximum power density value, firstly, power density is calculated and displayed on all evaluation surfaces. The power concentration areas for each evaluation surface are then identified. Second, a 2 cm x 2 cm square plane is moved in both horizontal and vertical directions across the entire surface and power density is calculated for each location. Third, the resulted maximum power density is divided by the area of the plane to get the average maximum power density over the 2 cm x 2 cm square area.

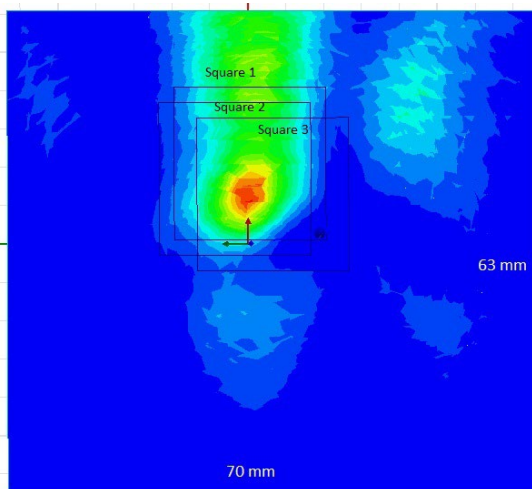

Fig. 6 – maximum value of average power density

Fig. 6 shows three 2 cm x 2 cm squares, square 1, 2 and 3, positioned over the highest power density areas. These areas are obtained from the simulation results and illustrates the process of locating the area of highest average power density

4 Simulation Setup

4.1 Simulated Setup over the Pre-defined Plane

From the E-Field and H-Field generated by simulations, we can calculate the local power density by employing Poynting theorem. Figure 7 shows the local power density of the computed complex E-field and H-field for the worst case in the pre-defined plane surface. The excited power for the antenna module is set to maximum input power for each active port. A 4cm² square can then be placed around the high intensity zones to find the worst case of average power density as shown in above Figure 6.

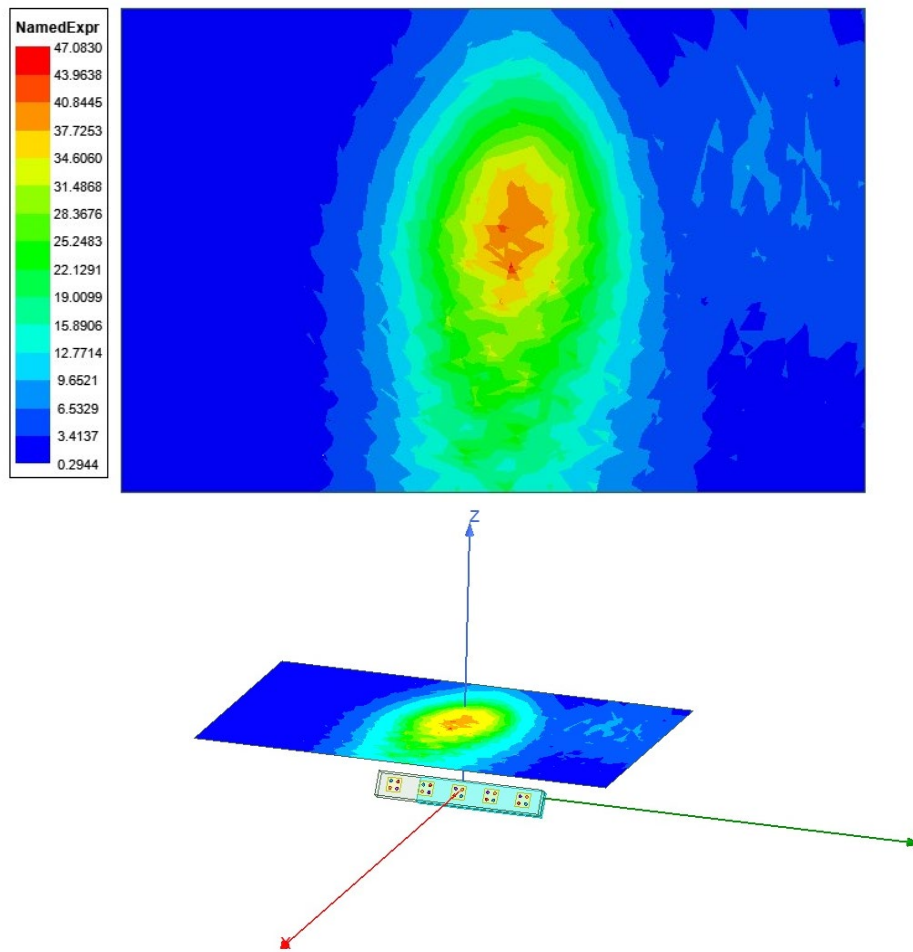

Fig. 7 - Local power density at pre-defined surface plane

Figure 7 shows an example of the simulated power density at a 10 mm distance from the top surface. Due to the time-consuming method used in measuring near field power density in the mm mmW spectrum, the most practical method is to use simulation results to find the antenna beam and surface with worst-case power

density. Once the surface and beam are located, the power density measurements are performed on the worst-case power density surface or surfaces.

4.2 Input Power

Table 3 shows the input powers used for each active port for both Simulation and Measurement. For measurements, the hotspot is configured to Factory Test Mode and input power values are entered via FW for each active port. For simulations, these values were entered directly into the HFSS setup parameters.

Table 3 – Measured and Simulated input powers used for each active port

Mode/Band	Antenna	Input Power (dBm/mW) SISO	Input Power (dBm) MIMO
5G NR n261	0	6/3.98	6/3.98
	1	6/3.98	6/3.98

5 Validation of Simulation Model

5.1 Comparison between Simulated and Measured

The beam characterization code book provides the relative phase between each input port of the antenna module and therefore defines all beams formed in real-world operation. Simulated and measured power density distributions for the antenna modules are shown in the below data. Based on these comparisons, the simulated and measured power densities have good correlation. Measurement uncertainty in mm Wave frequency simulation has measurement inaccuracy for material properties and are considered as error factors. Validation of simulations were measured in FTM (Factory Test Mode).

Surfaces required to be evaluated for Power Density according to FCC KDB 447498 D04 Interim General RF Exposure Guidance.

5.2 Summarized Simulated PD vs Measured PD Test Results

Power Density 4cm2 Avg. PD (mW/cm2)										
	Surface Side	Surface ID	Polarization	Element Type	Mid Channel	Antenna	Beam ID	Simulated mW/cm ²	Measured mW/cm ²	Sim. vs Meas. Δ dB
n261	Top	S1	H	Patch	2077917	0	159	1.092	0.879	0.94
	Top	S1	V	Patch	2077917		40	1.157	0.754	1.86
	Right	S5	H	Patch	2077917		160	0.089	0.063	0.67
	Right	S5	V	Patch	2077917		39	0.110	0.096	0.58
	Top	S6	H	Patch	2077917	1	154	0.660	0.354	2.71
	Top	S6	V	Patch	2077917		26	0.711	0.460	1.89
	Front	S7	H	Patch	2077917		153	0.302	0.241	0.99
	Front	S7	V	Patch	2077917		27	0.372	0.306	0.84

4cm2 Averaged Power Density

- ANT-0, n261, Channel 2077917, 27925.0 MHz, Top Surface (S1), Beam 40

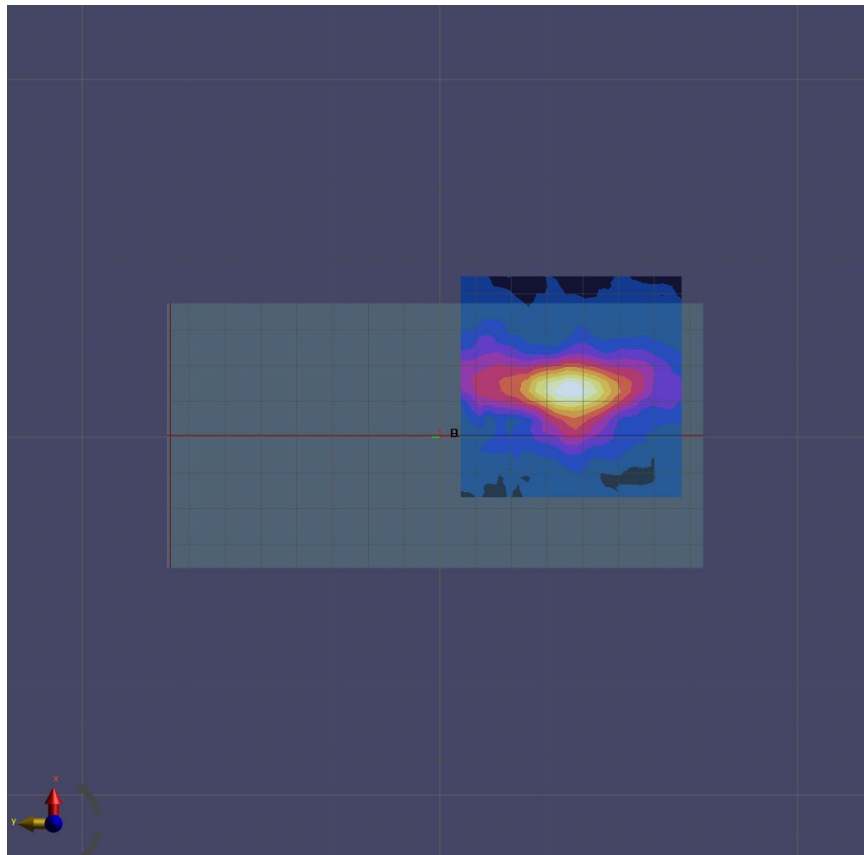

(a) Measurement

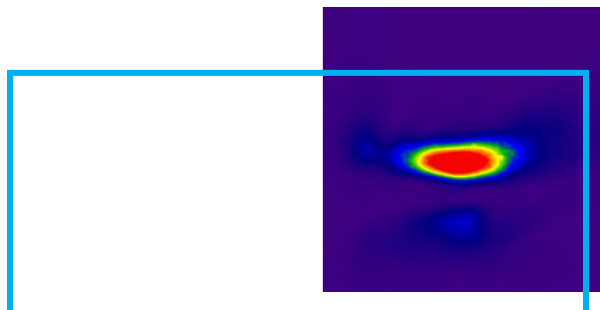

(b) Simulation

4cm2 Averaged Power Density

- ANT-0, n261, Channel 2077917, 27925.0 MHz, Top Surface (S1), Beam 159

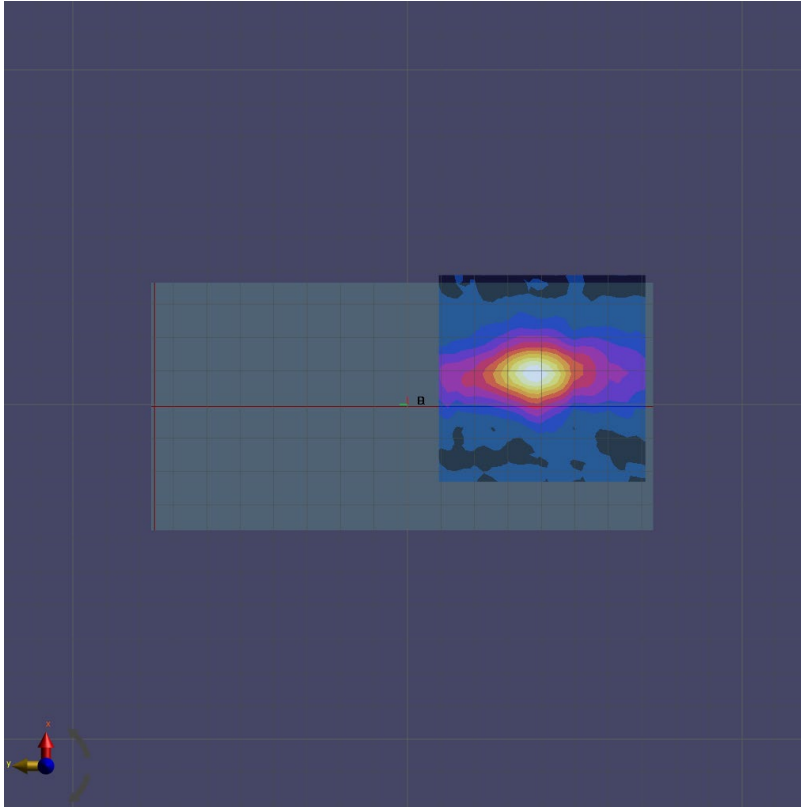

(a) Measurement

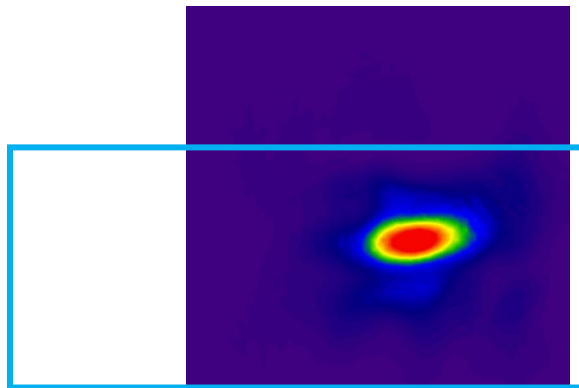

(b) Simulation

4cm2 Averaged Power Density

- ANT-0, n261, Channel 2077917, 27925.0 MHz, Right Surface (S5), Beam 39

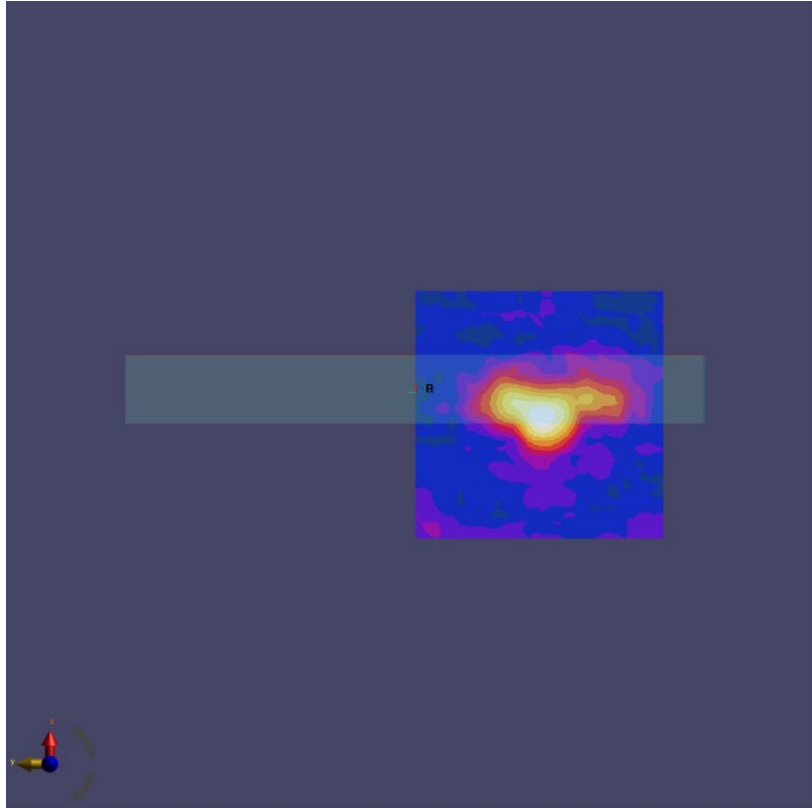

(a) Measurement

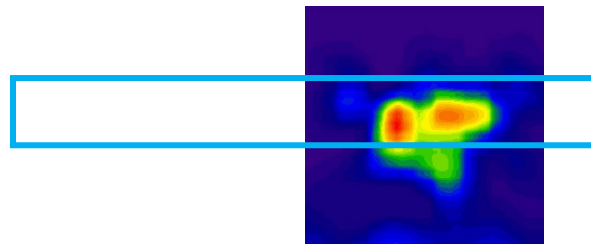

(b) Simulation

4cm2 Averaged Power Density

- ANT-0, n261, Channel 2077917, 27925.0 MHz, Right Surface (S5), Beam 160

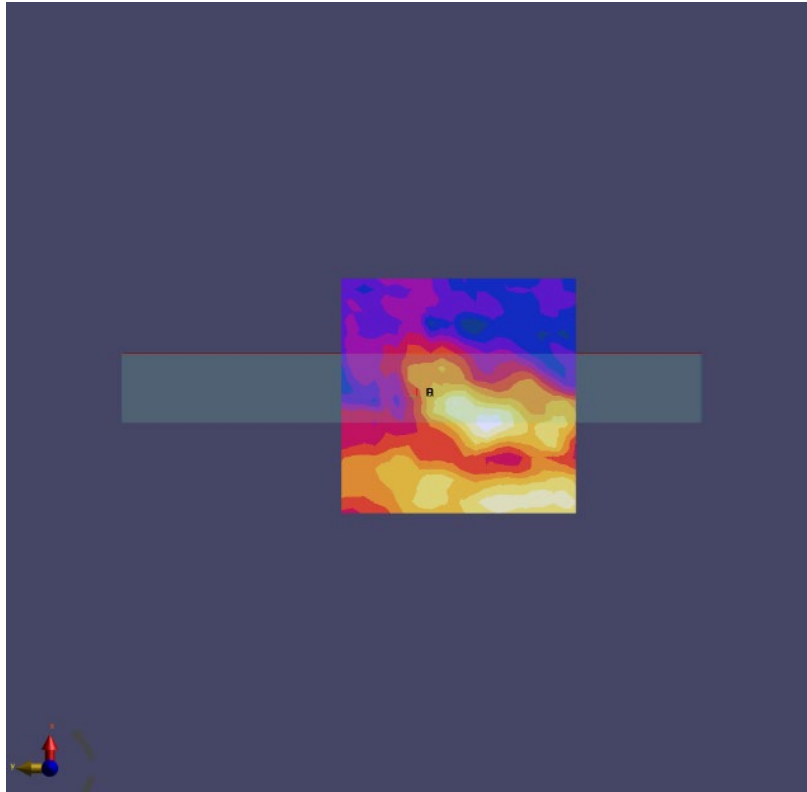

(a) Measurement

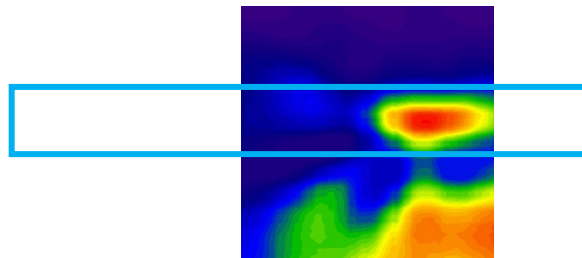

(b) Simulation

4cm2 Averaged Power Density

- ANT-1, n261, Channel 2077917, 27925.0 MHz, Top Surface (S6), Beam 26

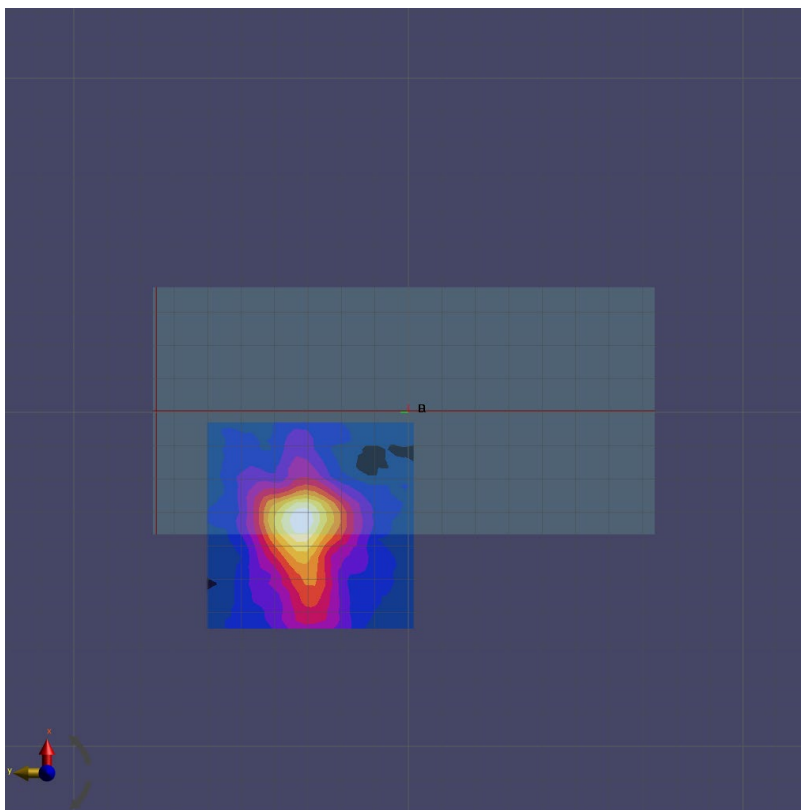

(a) Measurement

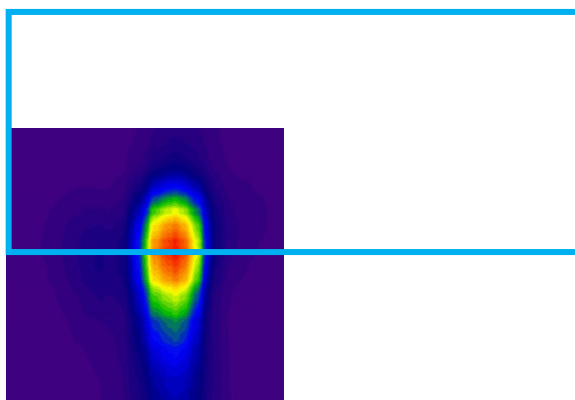

(b) Simulation

4cm2 Averaged Power Density

- ANT-1, n261, Channel 2077917, 27925.0 MHz, Top Surface (S6), Beam 154

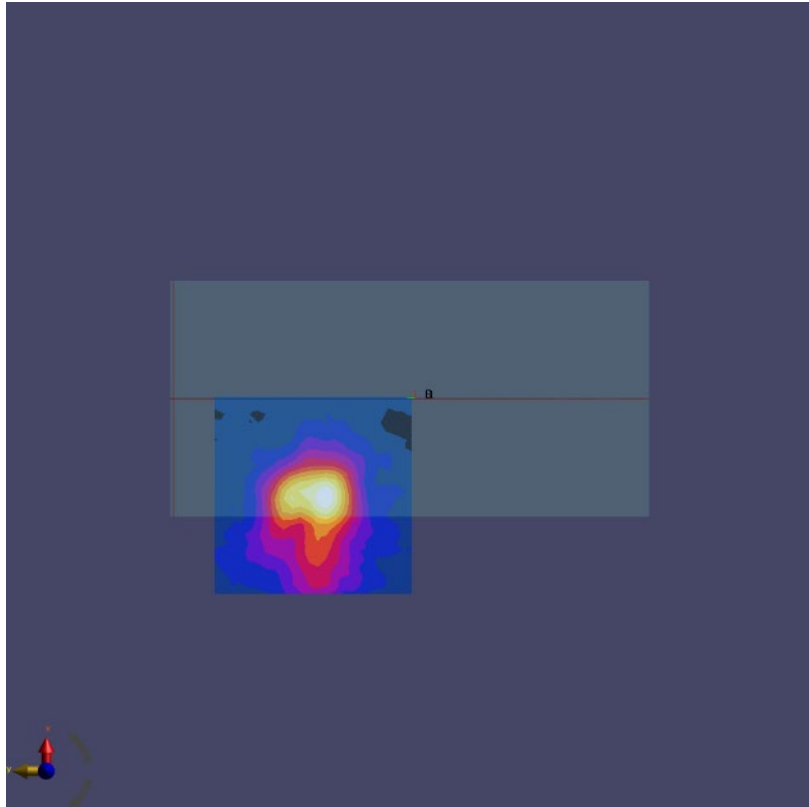

(a) Measurement

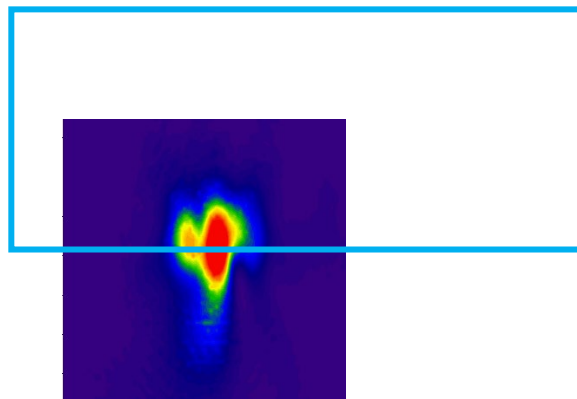

(b) Simulation

4cm2 Averaged Power Density

- ANT-1, n261, Channel 2077917, 27925.0 MHz, Front Surface (S7), Beam 153

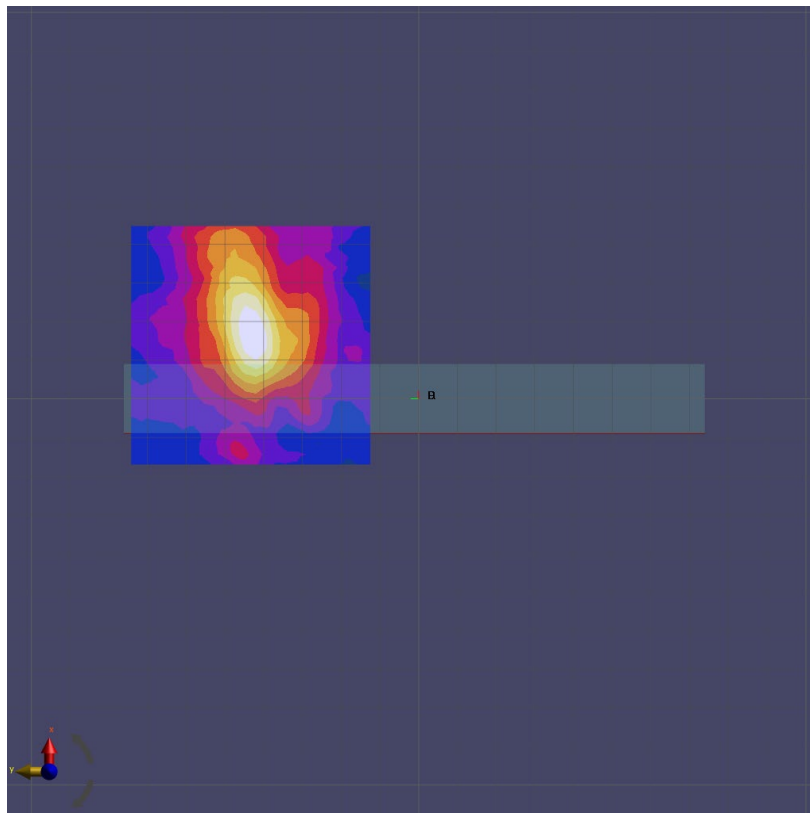

(a) Measurement

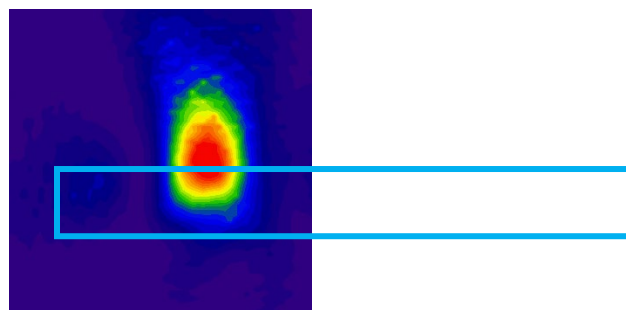

(b) Simulation

4cm2 Averaged Power Density

- ANT-1, n261, Channel 2077917, 27925.0 MHz, Front Surface (S7), Beam 27

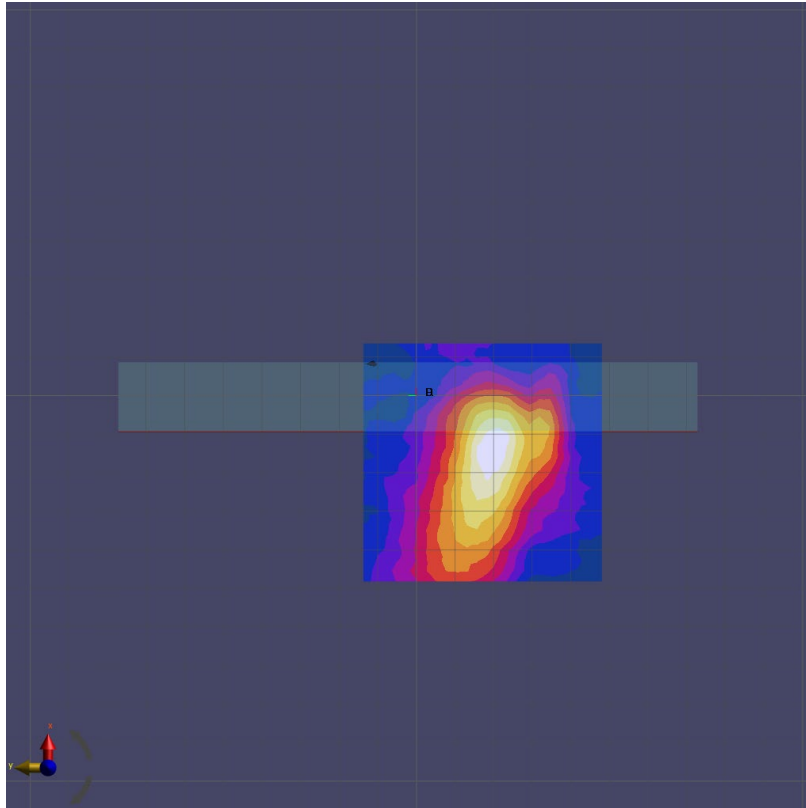

(a) Measurement

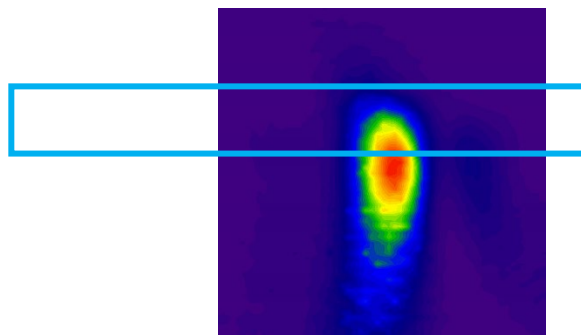

(b) Simulation

6 Simulation Results

6.1 Power Density for Band n261:

Table 4 & 5 show the PD simulations of Ant 0 and Ant 1 for evaluation surface planes specified in Table 2. Band n261 Simulation Frequencies: Low 27.50GHz, Mid 27.925GHz, High 28.350GHz

6.1.1 Ant-0 – Simulated Power Density

Table 4 – PD Simulations

n261 PD Simulation				Top Surface (S1)			Bottom Surface (S3)			Right Surface (S5)			Front Surface (S2)			Left Surface (S4)		
Ant Module	Ant Type	Polarization	Beam ID	4cm2 Avg. PD (mW/cm2) @ 6dBm														
				Channel														
				Low	Mid	High	Low	Mid	High	Low	Mid	High	Low	Mid	High	Low	Mid	High
0	Patch	Single Beam H-Pol	129	0.12344	0.15145	0.14753	0.00160	0.00160	0.00214	0.00628	0.00461	0.00545	0.00704	0.00968	0.00990	0.00315	0.00245	0.00350
			131	0.17596	0.17158	0.14529	0.00267	0.00178	0.00196	0.01047	0.01047	0.01089	0.00704	0.00748	0.00770	0.00455	0.00455	0.00385
			133	0.17684	0.17684	0.14455	0.00107	0.00107	0.00125	0.00712	0.00880	0.01005	0.00682	0.00682	0.00638	0.00490	0.00560	0.00630
			135	0.18209	0.17684	0.14455	0.00196	0.00196	0.00178	0.01508	0.01257	0.01508	0.00418	0.00528	0.00638	0.00455	0.00315	0.00315
			137	0.19872	0.19435	0.16914	0.00249	0.00249	0.00160	0.01257	0.01508	0.01466	0.00264	0.00308	0.00330	0.00385	0.00490	0.00455
			142	0.48431	0.48729	0.46941	0.00152	0.00167	0.00227	0.00713	0.00499	0.00499	0.00767	0.00973	0.01160	0.00714	0.00595	0.00447
			143	0.39490	0.42545	0.41949	0.00212	0.00227	0.00439	0.01676	0.01783	0.02317	0.01198	0.01516	0.01684	0.01369	0.01161	0.01042
			144	0.49474	0.47388	0.47239	0.00242	0.00379	0.00394	0.00570	0.00820	0.00856	0.02021	0.02246	0.02171	0.01310	0.01607	0.00953
			145	0.36361	0.36286	0.42396	0.00561	0.00470	0.00591	0.01176	0.00891	0.00891	0.02246	0.02864	0.02938	0.00327	0.00476	0.00417
			149	0.25855	0.31368	0.33753	0.00242	0.00273	0.00318	0.01533	0.02103	0.02032	0.01086	0.01273	0.01366	0.01250	0.01459	0.01488
			150	0.51709	0.49623	0.47611	0.00212	0.00288	0.00333	0.01283	0.01426	0.01462	0.01441	0.01778	0.01909	0.00149	0.00238	0.00357
			151	0.52455	0.51262	0.49325	0.00758	0.00773	0.00879	0.04813	0.04528	0.04064	0.00599	0.00618	0.00786	0.00357	0.00595	0.00744
			157	0.79129	0.81215	0.82705	0.00576	0.00697	0.00773	0.03102	0.03494	0.03815	0.02283	0.02246	0.02265	0.03840	0.03304	0.02411
			158	0.89635	0.92392	0.92094	0.00652	0.00758	0.00803	0.06096	0.07308	0.07736	0.02302	0.02714	0.02826	0.01816	0.01131	0.00863
			159	1.02599	1.09231	1.02525	0.00712	0.00530	0.01030	0.04635	0.05098	0.05811	0.02658	0.02901	0.02957	0.01637	0.01637	0.01905
			160	0.72200	0.73019	0.71082	0.01136	0.01106	0.00894	0.10232	0.08913	0.08164	0.02938	0.04192	0.04473	0.01935	0.01846	0.02024
			161	0.64674	0.64749	0.66760	0.00500	0.00455	0.00621	0.03601	0.04599	0.06061	0.02639	0.02845	0.02733	0.02054	0.02054	0.02262
			166	0.73466	0.78086	0.79129	0.00606	0.00712	0.00682	0.03993	0.04848	0.05276	0.02246	0.02358	0.02452	0.03602	0.03274	0.02560
			167	0.94552	0.99172	0.93211	0.00545	0.00864	0.01061	0.07594	0.05419	0.08235	0.02957	0.03088	0.03182	0.02233	0.02054	0.02203
			168	0.89709	0.89784	0.85239	0.01030	0.00652	0.00652	0.06916	0.07629	0.07950	0.03294	0.03556	0.03556	0.01965	0.01191	0.01280
			169	0.70039	0.71380	0.71752	0.00833	0.00758	0.00833	0.03315	0.02923	0.04635	0.02508	0.03706	0.04249	0.01637	0.01965	0.02322
		1	0.12824	0.16907	0.18623	0.00064	0.00073	0.00055	0.01539	0.01539	0.01613	0.00608	0.00684	0.00735	0.00268	0.00192	0.00249	
		3	0.15029	0.15764	0.16907	0.00091	0.00082	0.00046	0.01613	0.01906	0.01979	0.00532	0.00507	0.00481	0.00383	0.00479	0.00383	
		5	0.16499	0.15764	0.13722	0.00109	0.00118	0.00109	0.00513	0.01686	0.01759	0.00862	0.00963	0.00912	0.00345	0.00345	0.00383	
		7	0.16744	0.16091	0.15682	0.00100	0.00100	0.00100	0.00586	0.02052	0.01906	0.00507	0.00481	0.00532	0.00249	0.00287	0.00287	
		9	0.21400	0.21563	0.23932	0.00128	0.00155	0.00182	0.04765	0.03958	0.04398	0.00938	0.01039	0.01292	0.00613	0.00460	0.00441	
		14	0.46925	0.46994	0.46369	0.00264	0.00271	0.00233	0.00437	0.01185	0.00998	0.01618	0.01769	0.01725	0.00212	0.00310	0.00261	
		15	0.35246	0.40946	0.45117	0.00101	0.00171	0.00186	0.00936	0.02620	0.03307	0.01553	0.01898	0.02049	0.00343	0.00375	0.00440	
		16	0.31631	0.31214	0.30658	0.00240	0.00248	0.00233	0.01560	0.09046	0.08610	0.00927	0.00669	0.01057	0.00734	0.00799	0.00767	
		17	0.46925	0.47411	0.47968	0.00419	0.00426	0.00411	0.01622	0.05740	0.05677	0.01876	0.02135	0.02351	0.00228	0.00277	0.00310	
		21	0.42615	0.42893	0.41850	0.00364	0.00326	0.00310	0.01373	0.03868	0.03681	0.01424	0.01596	0.01833	0.00310	0.00294	0.00294	
		22	0.39973	0.45326	0.51374	0.00085	0.00186	0.00163	0.00499	0.01560	0.01622	0.01574	0.01920	0.02006	0.00391	0.00310	0.00245	
		23	0.35524	0.34968	0.34412	0.00171	0.00147	0.00155	0.02932	0.02807	0.02870	0.01035	0.01359	0.01208	0.01076	0.01191	0.01403	
		29	0.98646	1.02887	1.09005	0.01008	0.01109	0.01039	0.06925	0.07799	0.08734	0.05371	0.05004	0.06320	0.01272	0.00962	0.01060	
		30	1.04277	1.11368	1.02539	0.00496	0.00527	0.00566	0.05553	0.04430	0.05303	0.05953	0.06880	0.07937	0.01191	0.01044	0.01256	
		31	1.03165	1.05598	1.17208	0.00566	0.00737	0.00907	0.05802	0.06301	0.06052	0.05198	0.05586	0.05306	0.00718	0.00587	0.00538	
		32	1.05112	1.06641	1.08240	0.00543	0.00488	0.00473	0.01684	0.04929	0.06052	0.03688	0.03429	0.02718	0.01696	0.01664	0.01533	
		33	0.56518	0.67502	0.71256	0.00240	0.00341	0.00264	0.06364	0.08235	0.06987	0.01725	0.01855	0.02243	0.03735	0.03800	0.03931	
		38	1.11229	1.10256	1.05459	0.00644	0.00651	0.00636	0.04055	0.03244	0.03556	0.05931	0.06255	0.07441	0.01288	0.00946	0.01484	
		39	0.90026	1.04834	1.03652	0.00473	0.00830	0.00868	0.10544	0.10980	0.10668	0.06384	0.07398	0.07722	0.00881	0.00897	0.01125	
		40	1.04764	1.15678	1.17625	0.00512	0.00426	0.00551	0.07736	0.02308	0.02558	0.04163	0.04033	0.03667	0.00620	0.00767	0.00979	
		41	0.85716	0.90860	0.90235	0.00357	0.00372	0.00426	0.01310	0.06239	0.07175	0.02394	0.02610	0.02394	0.02561	0.02332	0.02283	
		157	29	1.83751	1.81602	1.89368	0.00788	0.00855	0.00848	0.14324	0.11765	0.14374	0.05048	0.05948	0.07414	0.06417	0.06834	0.06834
		158	30	2.22373	2.25424	2.07119	0.00376	0.00364	0.00382	0.08784	0.25312	0.11679	0.09278	0.10933	0.11855	0.04043	0.03690	0.03626
		159	31	2.10516	2.16618	2.23414	0.00600	0.00855	0.01012	0.07736	0.09269	0.07487	0.08629	0.09425	0.08985	0.03529	0.03337	0.03433
		160	32	1.62672	1.84722	1.90616	0.00745	0.00612	0.00758	0.20264	0.14973	0.13226	0.06765	0.06493	0.05341	0.03722	0.03561	0.04749
		161	33	1.00890	1.03733	1.08725	0.00570	0.00618	0.00636	0.05889	0.17201	0.07387	0.04901	0.04775	0.04922	0.05551	0.06000	0.07925
166	38	2.21541	2.15301	2.00393	0.00624	0.00582	0.00612	0.07187	0.17736	0.08834	0.07331	0.07708	0.07456	0.08053	0.06898	0.06160		
167	39	1.99977	2.06495	1.90477	0.00873	0.01206	0.01236	0.08235	0.18716	0.07137	0.10389	0.12148	0.12441	0.03626	0.04332	0.06738		
168	40	2.08713	2.25424	2.34577	0.00661	0.00539	0.00552	0.16570	0.09932	0.10381	0.07393	0.07226	0.06283	0.04877	0.04556	0.04428		
169	41	1.32439	1.52756	1.73350	0.00721	0.00655	0.00697	0.12428	0.10481	0.09383	0.04964	0.04587	0.04461	0.05358	0.05807	0.06770		

6.1.2 Ant-1 – Simulated Power Density

Table 5 – PD Simulations

n261 PD Simulation				Top Surface (S6)			Bottom Surface (S8)			Front Surface (S7)			Left Surface (S9)		
Ant Module	Ant Type	Polarization	Beam ID	4cm2 Avg. PD (mW/cm2) @ 6dBm											
				Channel											
				Low	Mid	High	Low	Mid	High	Low	Mid	High	Low	Mid	High
1	Patch	Single Beam H-Pol	128	0.11416	0.10914	0.10726	0.00270	0.00270	0.00281	0.04555	0.04611	0.04330	0.00183	0.00153	0.00199
			130	0.09597	0.10287	0.11416	0.00129	0.00094	0.00117	0.03936	0.04442	0.04611	0.00275	0.00199	0.00214
			132	0.09095	0.10099	0.10851	0.00176	0.00141	0.00106	0.05230	0.05173	0.04555	0.00245	0.00168	0.00168
			134	0.10161	0.11165	0.12043	0.00164	0.00152	0.00129	0.05286	0.05061	0.05286	0.00275	0.00245	0.00214
			136	0.09534	0.10475	0.11541	0.00152	0.00141	0.00082	0.02587	0.02474	0.02530	0.00382	0.00290	0.00260
			138	0.24344	0.28081	0.30057	0.00389	0.00329	0.00299	0.14550	0.15650	0.15459	0.00390	0.00247	0.00247
			139	0.30857	0.33580	0.36890	0.00439	0.00349	0.00270	0.17421	0.17469	0.16943	0.00104	0.00078	0.00078
			140	0.28028	0.30857	0.33527	0.00409	0.00369	0.00279	0.14262	0.13784	0.13162	0.00325	0.00260	0.00234
			141	0.17297	0.18258	0.18205	0.00479	0.00579	0.00689	0.09046	0.09668	0.10194	0.00651	0.00390	0.00429
			146	0.11104	0.12653	0.15162	0.00379	0.00369	0.00359	0.09381	0.09811	0.09668	0.00911	0.00755	0.00716
			147	0.13614	0.15215	0.15856	0.00329	0.00369	0.00329	0.05025	0.05743	0.06222	0.00898	0.00625	0.00638
			148	0.23810	0.25465	0.28562	0.00419	0.00359	0.00289	0.12109	0.11439	0.11199	0.00312	0.00351	0.00377
			152	0.40307	0.45806	0.49116	0.00659	0.00689	0.00689	0.21633	0.24361	0.20772	0.02772	0.01939	0.01744
			153	0.46980	0.50877	0.52479	0.01298	0.01088	0.00988	0.28238	0.30248	0.31349	0.00976	0.00794	0.00755
			154	0.59473	0.66039	0.71805	0.00918	0.01058	0.01098	0.23643	0.25462	0.25893	0.01197	0.01028	0.00937
			155	0.44257	0.47461	0.50931	0.00679	0.00699	0.00838	0.25558	0.25414	0.25414	0.01848	0.01210	0.01431
			156	0.29042	0.32352	0.35342	0.00769	0.00789	0.00779	0.15555	0.16416	0.16895	0.01978	0.01405	0.01444
			162	0.45645	0.49756	0.50824	0.01268	0.01188	0.01158	0.26515	0.28573	0.30679	0.01444	0.01223	0.01015
		163	0.53867	0.59953	0.67481	0.00829	0.00679	0.00789	0.27137	0.30056	0.29482	0.01627	0.01067	0.01041	
		164	0.52586	0.58779	0.59900	0.00819	0.00799	0.00809	0.22686	0.24361	0.24313	0.00846	0.00781	0.00859	
		165	0.31071	0.35609	0.38598	0.00589	0.00609	0.00609	0.18618	0.19384	0.20245	0.02941	0.02134	0.01939	
		0	0.09972	0.10760	0.11436	0.00168	0.00157	0.00126	0.02581	0.02839	0.02788	0.00361	0.00409	0.00409	
		2	0.07944	0.08451	0.08958	0.00115	0.00094	0.00094	0.04595	0.05059	0.04956	0.00265	0.00289	0.00313	
		4	0.10141	0.10591	0.11098	0.00115	0.00115	0.00094	0.03407	0.03356	0.03407	0.00169	0.00193	0.00241	
		6	0.09465	0.09859	0.11042	0.00105	0.00157	0.00105	0.04130	0.04337	0.04853	0.00289	0.00265	0.00289	
		8	0.11493	0.10253	0.10084	0.00220	0.00209	0.00188	0.03511	0.03614	0.03872	0.00723	0.00819	0.00674	
		10	0.22153	0.23016	0.23975	0.00330	0.00357	0.00383	0.05405	0.05976	0.06415	0.00533	0.00512	0.00738	
		11	0.30640	0.32558	0.34284	0.00241	0.00214	0.00250	0.10501	0.11468	0.11951	0.00123	0.00143	0.00143	
		12	0.27044	0.29010	0.30640	0.00276	0.00241	0.00214	0.11732	0.12127	0.12083	0.00369	0.00225	0.00287	
		13	0.17502	0.20283	0.22393	0.00276	0.00232	0.00232	0.11995	0.12347	0.11292	0.00984	0.00943	0.00943	
		18	0.23064	0.24550	0.26324	0.00357	0.00348	0.00303	0.11073	0.11424	0.11292	0.00307	0.00287	0.00389	
		19	0.27811	0.29729	0.31215	0.00276	0.00250	0.00258	0.11380	0.11644	0.11688	0.00287	0.00164	0.00246	
		20	0.22153	0.20570	0.22393	0.00303	0.00294	0.00339	0.08480	0.08964	0.09930	0.00410	0.00410	0.00451	
		24	0.36442	0.38600	0.41812	0.01150	0.01141	0.01070	0.17532	0.17444	0.16873	0.01722	0.01783	0.01353	
		25	0.62335	0.64540	0.69959	0.00998	0.00891	0.00891	0.25485	0.25704	0.27989	0.01230	0.01394	0.01517	
		26	0.68712	0.71062	0.74802	0.00954	0.00784	0.00775	0.28385	0.30450	0.30362	0.01045	0.00758	0.00738	
		27	0.60561	0.64972	0.70246	0.01310	0.01141	0.00989	0.36426	0.37172	0.37304	0.01107	0.01230	0.00881	
		28	0.40566	0.38887	0.43826	0.00900	0.00766	0.00660	0.25309	0.25836	0.25968	0.02296	0.01681	0.01496	
		34	0.50683	0.53704	0.57012	0.01328	0.01203	0.01381	0.23991	0.22277	0.20476	0.01230	0.01763	0.01681	
		35	0.64253	0.66794	0.72164	0.01034	0.00891	0.00829	0.27857	0.27945	0.28385	0.01086	0.01189	0.01025	
		36	0.63294	0.64492	0.69719	0.01132	0.00998	0.00963	0.31548	0.32427	0.32032	0.01332	0.01558	0.01373	
		37	0.51450	0.53224	0.58163	0.01185	0.00865	0.00873	0.31153	0.31416	0.31592	0.01353	0.01107	0.00922	
		152	24	0.69849	0.71722	0.76814	0.02326	0.02396	0.02535	0.35223	0.37446	0.34616	0.02804	0.01551	0.00930
		153	25	1.10922	1.15341	1.23508	0.02366	0.01966	0.01827	0.32898	0.37345	0.38709	0.01098	0.01111	0.01279
		154	26	1.25189	1.33981	1.41763	0.01867	0.01507	0.01717	0.37497	0.41034	0.42904	0.01331	0.01202	0.00918
155	27	1.19953	1.31002	1.40226	0.01757	0.01617	0.01497	0.42247	0.42398	0.46188	0.00737	0.00646	0.00659		
156	28	0.69993	0.68936	0.82723	0.02256	0.02276	0.01996	0.25671	0.24257	0.22387	0.01822	0.01499	0.01680		
162	34	0.92571	0.93244	0.98720	0.02366	0.02226	0.02466	0.35829	0.32393	0.34111	0.01434	0.01163	0.01266		
163	35	1.16735	1.23172	1.28984	0.02286	0.01817	0.01787	0.33605	0.36486	0.40124	0.02003	0.01228	0.00982		
164	36	1.15678	1.24229	1.34269	0.01577	0.01338	0.01098	0.41944	0.43864	0.45380	0.01060	0.01176	0.01137		
165	37	0.83828	0.88680	0.98624	0.01637	0.01547	0.01517	0.26126	0.28704	0.32645	0.02300	0.01796	0.01964		
		Paired Beams													

7 Summary

7.1 Uncertainty

The amplitude level of power density simulation is biased due to material property parameters and the internal configuration at mm Wave frequencies. Therefore, it is not possible to assign an exact uncertainty for the simulation results. However, for the RF exposure evaluation, simulation results were only used to select the highest worst-case beam ID for measurements. Power density results for measurement and simulation show similar results to justify the selection of the Beam ID used for measurements. All final power density evaluations were performed on a measurement system with uncertainty of approximately 1.5dB.