



# FCC RADIO TEST REPORT

**FCC ID** : PKRISGM2000A  
**Equipment** : Wireless Hotspot Modem  
**Brand Name** : Inseego  
**Model Name** : M2000A  
**Marketing Name** : M2000  
**Applicant** : Inseego Corporation  
9710 Scranton Road Suite 200, San Diego, CA 92121  
**Manufacturer** : Inseego Corporation  
9710 Scranton Road Suite 200, San Diego, CA 92121  
**Standard** : FCC 47 CFR Part 2, 22(H), 24(E), 27(L)

The product was received on Jul. 09, 2020 and testing was started from Jul. 23, 2020 and completed on Sep. 02, 2020. We, SPORTON INTERNATIONAL INC. EMC & Wireless Communications Laboratory, would like to declare that the tested sample has been evaluated in accordance with the test procedures given in ANSI / TIA-603-E and has been in compliance with the applicable technical standards.

The test results in this report apply exclusively to the tested model / sample. Without written approval of SPORTON INTERNATIONAL INC. EMC & Wireless Communications Laboratory, the test report shall not be reproduced except in full.

*Louis Wu*

Approved by: Louis Wu

**SPORTON INTERNATIONAL INC. EMC & Wireless Communications Laboratory**  
No. 52, Huaya 1st Rd., Guishan Dist., Taoyuan City, Taiwan (R.O.C.)



# Table of Contents

**History of this test report.....3**

**Summary of Test Result.....4**

**1 General Description .....5**

    1.1 Product Feature of Equipment Under Test .....5

    1.2 Modification of EUT .....5

    1.3 Testing Location .....5

    1.4 Applicable Standards .....6

**2 Test Configuration of Equipment Under Test .....7**

    2.1 Test Mode.....7

    2.2 Connection Diagram of Test System .....7

    2.3 Support Unit used in test configuration .....8

    2.4 Measurement Results Explanation Example .....8

    2.5 Frequency List of Low/Middle/High Channels.....8

**3 Conducted Test Result .....9**

    3.1 Measuring Instruments.....9

    3.2 Conducted Output Power and ERP/EIRP .....10

    3.3 Peak-to-Average Ratio .....11

    3.4 99% Occupied Bandwidth and 26dB Bandwidth Measurement.....12

    3.5 Conducted Band Edge .....13

    3.6 Conducted Spurious Emission .....14

    3.7 Frequency Stability.....15

**4 Radiated Test Items .....16**

    4.1 Measuring Instruments.....16

    4.2 Test Setup .....16

    4.3 Test Result of Radiated Test.....17

    4.4 Field Strength of Spurious Radiation Measurement .....18

**5 List of Measuring Equipment.....19**

**6 Uncertainty of Evaluation.....20**

**Appendix A. Test Results of Conducted Test**

**Appendix B. Test Results of ERP/EIRP and Radiated Test**

**Appendix C. Test Setup Photographs**



### History of this test report

Report No.	Version	Description	Issued Date
FG041657-01A	01	Initial issue of report	Sep. 16, 2020



### Summary of Test Result

Report Clause	Ref Std. Clause	Test Items	Result (PASS/FAIL)	Remark
3.2	§2.1046	Conducted Output Power	Pass	-
	§22.913 (a)(2)	Effective Radiated Power (WCDMA Band V)		
	§24.232 (c)	Equivalent Isotropic Radiated Power (WCDMA Band II)		
	§27.50 (d)(4)	Equivalent Isotropic Radiated Power (WCDMA Band IV)		
3.3	§24.232 (d)	Peak-to-Average Ratio	Pass	
3.4	§2.1049 §22.917 (b) §24.238 (b) §27.53 (g)	Occupied Bandwidth (WCDMA Band V) (WCDMA Band II) (WCDMA Band IV)	Pass	-
3.5	§2.1051 §22.917 (a) §24.238 (a) §27.53 (g)	Band Edge Measurement (WCDMA Band V) (WCDMA Band II) (WCDMA Band IV)	Pass	-
3.6	§2.1051 §22.917 (a) §24.238 (a) §27.53 (g)	Conducted Emission (WCDMA Band V) (WCDMA Band II) (WCDMA Band IV)	Pass	-
3.7	§2.1055 §22.355 §24.235 §27.54	Frequency Stability Temperature & Voltage	Pass	-
4.4	§2.1053 §22.917 (a) §24.238 (a) §27.53 (h)	Field Strength of Spurious Radiation (WCDMA Band V) (WCDMA Band II) (WCDMA Band IV)	Pass	Under limit 33.00 dB at 7515.000 MHz

**Declaration of Conformity:**  
The test results with all measurement uncertainty excluded are presented in accordance with the regulation limits or requirements declared by manufacturers.

**Comments and Explanations:**  
The declared of product specification for EUT presented in the report are provided by the manufacturer, and the manufacturer takes all the responsibilities for the accuracy of product specification.

Reviewed by: Wii Chang

Report Producer: Ruby Zou



# 1 General Description

## 1.1 Product Feature of Equipment Under Test

WCDMA/LTE/5G NR, Wi-Fi 2.4GHz 802.11b/g/n/ax, Wi-Fi 5GHz 802.11a/n/ac/ax and GNSS.

Product Specification subjective to this standard	
Antenna Type	WWAN: Fixed Internal Antenna WLAN: <Ant. 1>: Fixed Internal Antenna <Ant. 2>: Fixed Internal Antenna GPS: Fixed Internal Antenna

## 1.2 Modification of EUT

No modifications are made to the EUT during all test items.

## 1.3 Testing Location

Test Site	SPORTON INTERNATIONAL INC. EMC & Wireless Communications Laboratory
Test Site Location	No.52, Huaya 1st Rd., Guishan Dist., Taoyuan City, Taiwan (R.O.C.) TEL: +886-3-327-3456 FAX: +886-3-328-4978
Test Site No.	<b>Sporton Site No.</b> TH03-HY
Test Engineer	Oscar Chi
Temperature	19.9°C
Relative Humidity	41.9%

Test Site	SPORTON INTERNATIONAL INC. EMC & Wireless Communications Laboratory
Test Site Location	No.58, Aly. 75, Ln. 564, Wenhua 3rd, Rd., Guishan Dist., Taoyuan City, Taiwan (R.O.C.) TEL: +886-3-327-0868 FAX: +886-3-327-0855
Test Site No.	<b>Sporton Site No.</b> 03CH12-HY
Test Engineer	Jack Cheng, Lance Chiang and Chuan Chu
Temperature	23.8~25.6°C
Relative Humidity	56~68%

**Note:** The test site complies with ANSI C63.4 2014 requirement.

FCC Designation No.: TW1190 and TW0007



## **1.4 Applicable Standards**

According to the specifications of the manufacturer, the EUT must comply with the requirements of the following standards:

- ♦ ANSI C63.26-2015
- ♦ ANSI / TIA-603-E
- ♦ FCC 47 CFR Part 2, 22(H), 24(E), 27(L)
- ♦ FCC KDB 971168 D01 Power Meas. License Digital Systems v03r01
- ♦ FCC KDB 412172 D01 Determining ERP and EIRP v01r01
- ♦ FCC KDB 414788 D01 Radiated Test Site v01r01

**Remark:**

1. All test items were verified and recorded according to the standards and without any deviation during the test.
2. The TAF code is not including all the FCC KDB listed without accreditation.

## 2 Test Configuration of Equipment Under Test

### 2.1 Test Mode

Antenna port conducted and radiated test items were performed according to KDB 971168 D01 Power Meas. License Digital Systems v03r01 with maximum output power.

For radiated measurement, pre-scanned in three orthogonal panels, X, Y, Z. The worst cases (Y Plane with Adapter for Cellular Band, PCS Band and AWS Band) were recorded in this report.

Radiated emissions were investigated as following frequency range:

1. 30 MHz to 9000 MHz for WCDMA Band V
2. 30 MHz to 18000 MHz for WCDMA Band IV
3. 30 MHz to 19100 MHz for WCDMA Band II

All modes and data rates and positions were investigated.

Test modes are chosen to be reported as the worst case configuration below:

Test Modes		
Band	Radiated TCs	Conducted TCs
WCDMA Band V	■ RMC 12.2Kbps Link	■ RMC 12.2Kbps Link
WCDMA Band II	■ RMC 12.2Kbps Link	■ RMC 12.2Kbps Link
WCDMA Band IV	■ RMC 12.2Kbps Link	■ RMC 12.2Kbps Link

Remark: All the radiated test cases were performed with Battery 2.

### 2.2 Connection Diagram of Test System

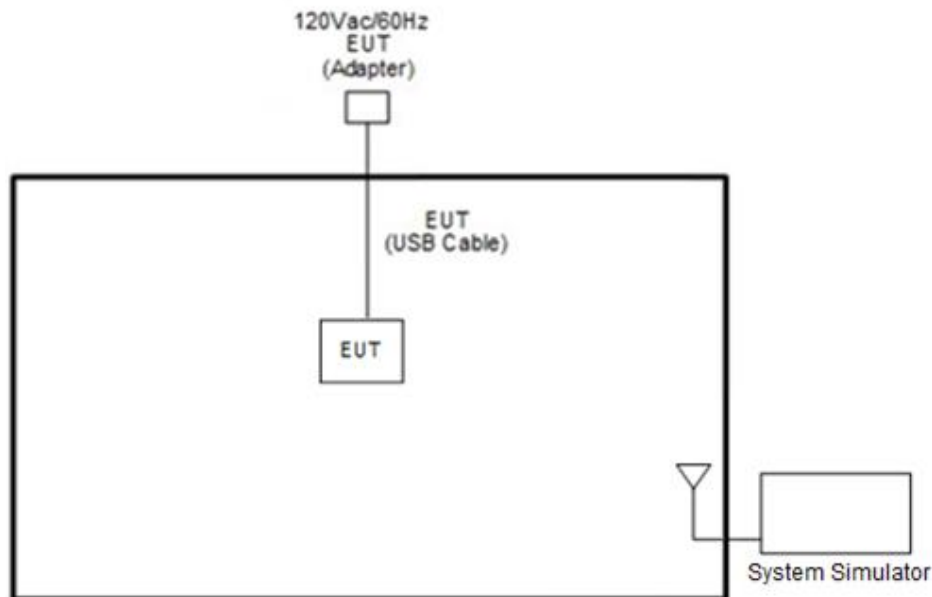



### 2.3 Support Unit used in test configuration

Item	Equipment	Brand Name	Model No.	FCC ID	Data Cable	Power Cord
1.	System Simulator	R&S	CMU 200	N/A	N/A	Unshielded, 1.8 m

### 2.4 Measurement Results Explanation Example

**For all conducted test items:**

The offset level is set in the spectrum analyzer to compensate the RF cable loss and attenuator factor between RF conducted output port and spectrum analyzer. With the offset compensation, the spectrum analyzer reading level will be exactly the RF output level.

The spectrum analyzer offset is derived from RF cable loss and attenuator factor.

$$Offset = RF\ cable\ loss + attenuator\ factor.$$

The following shows an offset computation example with RF cable loss 4.2 dB and a 10dB attenuator.

Example:

$$\begin{aligned}
 Offset(dB) &= RF\ cable\ loss(dB) + attenuator\ factor(dB) \\
 &= 4.2 + 10 = 14.2\ (dB)
 \end{aligned}$$

### 2.5 Frequency List of Low/Middle/High Channels

Frequency List				
Band	Channel/Frequency(MHz)	Lowest	Middle	Highest
WCDMA Band V	Channel	4132	4182	4233
	Frequency	826.4	836.4	846.6
WCDMA Band II	Channel	9262	9400	9538
	Frequency	1852.4	1880.0	1907.6
WCDMA Band IV	Channel	1312	1413	1513
	Frequency	1712.4	1732.6	1752.6



### 3 Conducted Test Result

#### 3.1 Measuring Instruments

See list of measuring instruments of this test report.

##### 3.1.1 Test Setup

##### 3.1.2 Conducted Output Power

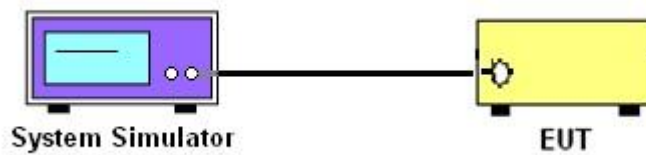

##### 3.1.3 Peak-to-Average Ratio, Occupied Bandwidth, Conducted Band-Edge and Conducted Spurious Emission

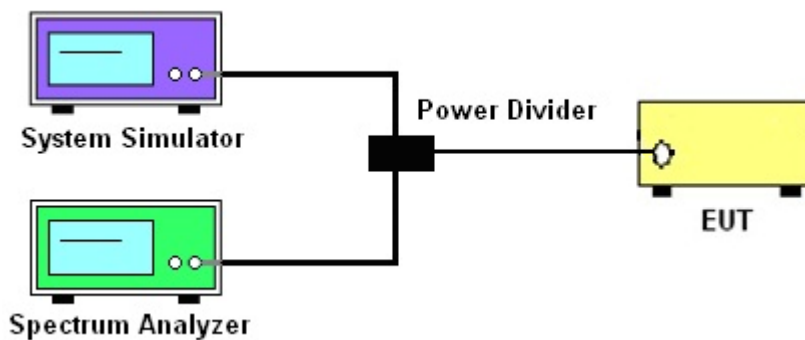

##### 3.1.4 Frequency Stability

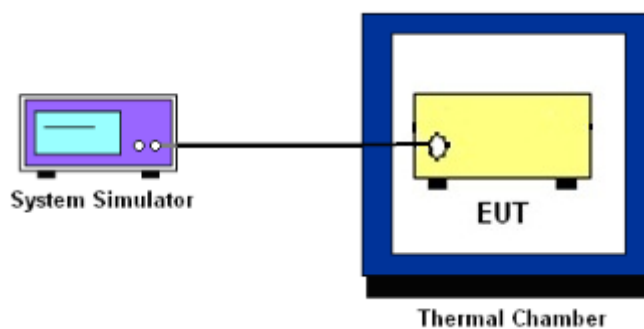

##### 3.1.5 Test Result of Conducted Test

Please refer to Appendix A.



## 3.2 Conducted Output Power and ERP/EIRP

### 3.2.1 Description of the Conducted Output Power and ERP/EIRP

A system simulator was used to establish communication with the EUT. Its parameters were set to enforce EUT transmitting at the maximum power. The measured power in the radio frequency on the transmitter output terminals shall be reported.

The ERP of mobile transmitters must not exceed 7 Watts for WCDMA Band V

The EIRP of mobile transmitters must not exceed 2 Watts for WCDMA Band II

The EIRP of mobile transmitters must not exceed 1 Watts for WCDMA Band IV

According to KDB 412172 D01 Power Approach,

$EIRP = P_T + G_T - L_C$ ,  $ERP = EIRP - 2.15$ , where

$P_T$  = transmitter output power in dBm

$G_T$  = gain of the transmitting antenna in dBi

$L_C$  = signal attenuation in the connecting cable between the transmitter and antenna in dB

### 3.2.2 Test Procedures

1. The transmitter output port was connected to the system simulator.
2. Set EUT at maximum power through system simulator.
3. Select lowest, middle, and highest channels for each band and different modulation.
4. Measure the maximum burst average power for GSM and maximum average power for other modulation signal.



### **3.3 Peak-to-Average Ratio**

#### **3.3.1 Description of the PAR Measurement**

The peak-to-average ratio (PAR) of the transmission may not exceed 13 dB.

#### **3.3.2 Test Procedures**

The testing follows ANSI C63.26-2015 Section 5.2.6

1. The EUT was connected to spectrum analyzer and system simulator via a power divider.
2. Set EUT to transmit at maximum output power.
3. When the duty cycle is less than 98%, then signal gating will be implemented on the spectrum analyzer by triggering from the system simulator.
4. Set the CCDF (Complementary Cumulative Distribution Function) option of the spectrum analyzer.
5. Record the maximum PAPR level associated with a probability of 0.1%.



### 3.4 99% Occupied Bandwidth and 26dB Bandwidth Measurement

#### 3.4.1 Description of 99% Occupied Bandwidth and 26dB Bandwidth Measurement

The occupied bandwidth is the width of a frequency band such that, below the lower and above the upper frequency limits, the mean powers emitted are each equal to a specified percentage 0.5% of the total mean transmitted power.

The 26 dB emission bandwidth is defined as the frequency range between two points, one above and one below the carrier frequency, at which the spectral density of the emission is attenuated 26 dB below the maximum in-band spectral density of the modulated signal. Spectral density (power per unit bandwidth) is to be measured with a detector of resolution bandwidth equal to approximately 1.0% of the emission bandwidth.

#### 3.4.2 Test Procedures

The testing follows ANSI C63.26-2015 Section 5.4.3 (26dB) and Section 5.4.4 (99OB)

1. The EUT was connected to spectrum analyzer and system simulator via a power divider.
2. The spectrum analyzer center frequency is set to the nominal EUT channel center frequency. The span range for the spectrum analyzer shall be between two and five times the anticipated OBW.
3. The nominal resolution bandwidth (RBW) shall be in the range of 1 to 5 % of the anticipated OBW, and the VBW shall be at least 3 times the RBW.
4. Set the detection mode to peak, and the trace mode to max hold.
5. Determine the reference value: Set the EUT to transmit a modulated signal. Allow the trace to stabilize. Set the spectrum analyzer marker to the highest level of the displayed trace.  
(this is the reference value)
6. Determine the “-26 dB down amplitude” as equal to (Reference Value – X).
7. Place two markers, one at the lowest and the other at the highest frequency of the envelope of the spectral display such that each marker is at or slightly below the “-X dB down amplitude” determined in step 6. If a marker is below this “-X dB down amplitude” value it shall be placed as close as possible to this value. The OBW is the positive frequency difference between the two markers.
8. Use the 99 % power bandwidth function of the spectrum analyzer and report the measured bandwidth.



## **3.5 Conducted Band Edge**

### **3.5.1 Description of Conducted Band Edge Measurement**

The power of any emission outside of the authorized operating frequency ranges must be lower than the transmitter power (P) by a factor of at least  $43 + 10 \log (P)$  dB.

### **3.5.2 Test Procedures**

The testing follows FCC KDB 971168 D01 v03r01 Section 6.1.

1. The EUT was connected to the spectrum analyzer and system simulator via a power divider.
2. The RF output of EUT was connected to the spectrum analyzer by an RF cable and attenuator. The path loss was compensated to the results for each measurement.
3. The band edges of low and high channels for the highest RF powers were measured.
4. The RF fundamental frequency should be excluded against the limit line in the operating frequency band.
5. The limit line is derived from  $43 + 10\log(P)$  dB below the transmitter power P(Watts)



## **3.6 Conducted Spurious Emission**

### **3.6.1 Description of Conducted Spurious Emission Measurement**

The power of any emission outside of the authorized operating frequency ranges must be lower than the transmitter power (P) by a factor of at least  $43 + 10 \log (P)$  dB.

It is measured by means of a calibrated spectrum analyzer and scanned from 30 MHz up to a frequency including its 10<sup>th</sup> harmonic.

### **3.6.2 Test Procedures**

The testing follows FCC KDB 971168 D01 v03r01 Section 6.1.

1. The EUT was connected to the spectrum analyzer and system simulator via a power divider.
2. The RF output of EUT was connected to the spectrum analyzer by an RF cable and attenuator. The path loss was compensated to the results for each measurement.
3. The middle channel for the highest RF power within the transmitting frequency was measured.
4. The conducted spurious emission for the whole frequency range was taken.
5. The RF fundamental frequency should be excluded against the limit line in the operating frequency band.
6. The limit line is derived from  $43 + 10\log(P)$  dB below the transmitter power P(Watts)



### 3.7 Frequency Stability

#### 3.7.1 Description of Frequency Stability Measurement

22.355

The frequency stability shall be measured by variation of ambient temperature and variation of primary supply voltage to ensure that the fundamental emission stays within the authorized frequency block. The frequency stability of the transmitter shall be maintained within  $\pm 0.00025\%$  ( $\pm 2.5\text{ppm}$ ) of the center frequency.

24.235 & 27.54

The frequency stability shall be sufficient to ensure that the fundamental emission stays within the authorized frequency block.

#### 3.7.2 Test Procedures for Temperature Variation

The testing follows FCC KDB 971168 D01 v03r01 Section 9.0.

1. The EUT was set up in the thermal chamber and connected with the system simulator.
2. With power OFF, the temperature was decreased to  $-30^{\circ}\text{C}$  and the EUT was stabilized before testing. Power was applied and the maximum change in frequency was recorded within one minute.
3. With power OFF, the temperature was raised in  $10^{\circ}\text{C}$  steps up to  $50^{\circ}\text{C}$ . The EUT was stabilized at each step for at least half an hour. Power was applied and the maximum frequency change was recorded within one minute.

#### 3.7.3 Test Procedures for Voltage Variation

The testing follows FCC KDB 971168 D01 v03r01 Section 9.0.

1. The EUT was placed in a temperature chamber at  $20\pm 5^{\circ}\text{C}$  and connected with the system simulator.
2. The power supply voltage to the EUT was varied from 85% to 115% of the nominal value measured at the input to the EUT.
3. The variation in frequency was measured for the worst case.

## 4 Radiated Test Items

### 4.1 Measuring Instruments

See list of measuring instruments of this test report.

### 4.2 Test Setup

For radiated emissions below 30MHz

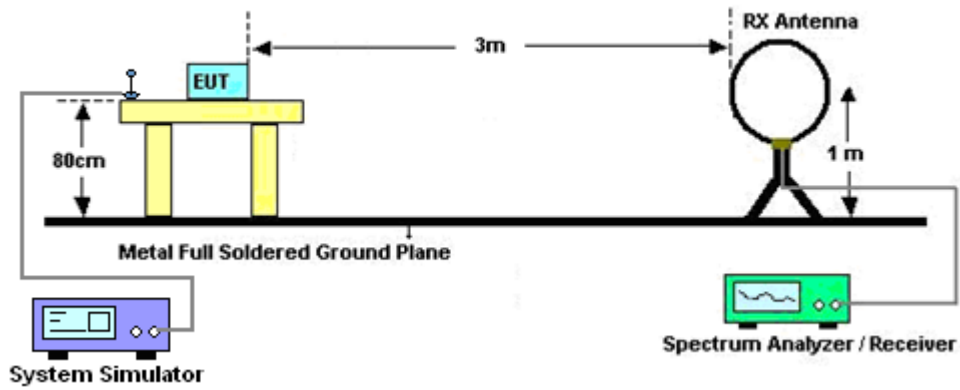

For radiated test from 30MHz to 1GHz

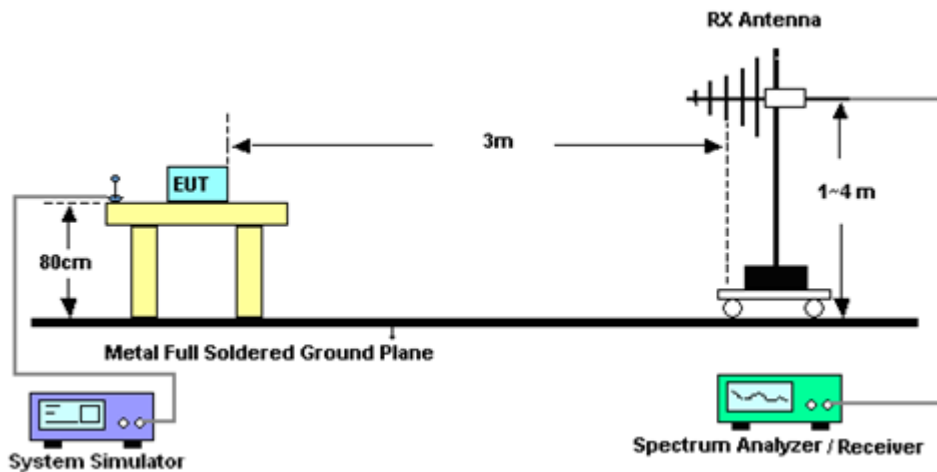



For radiated test from 1GHz to 18GHz

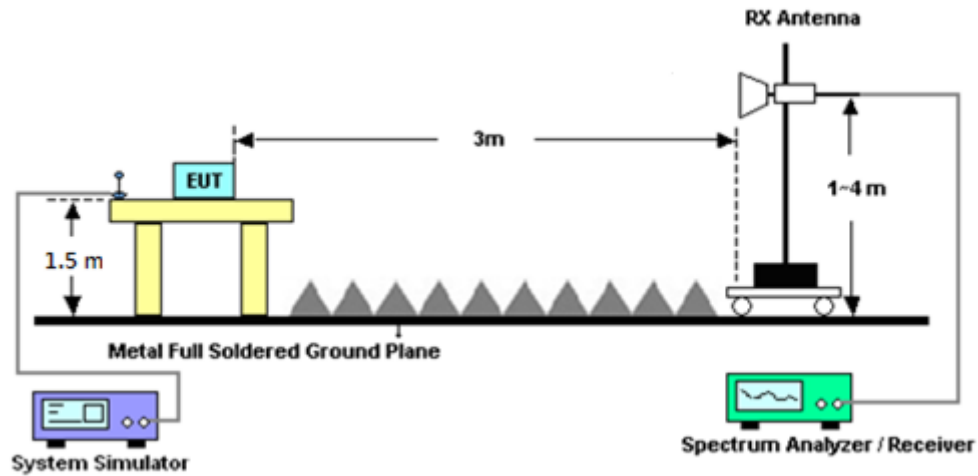

For radiated test above 18GHz

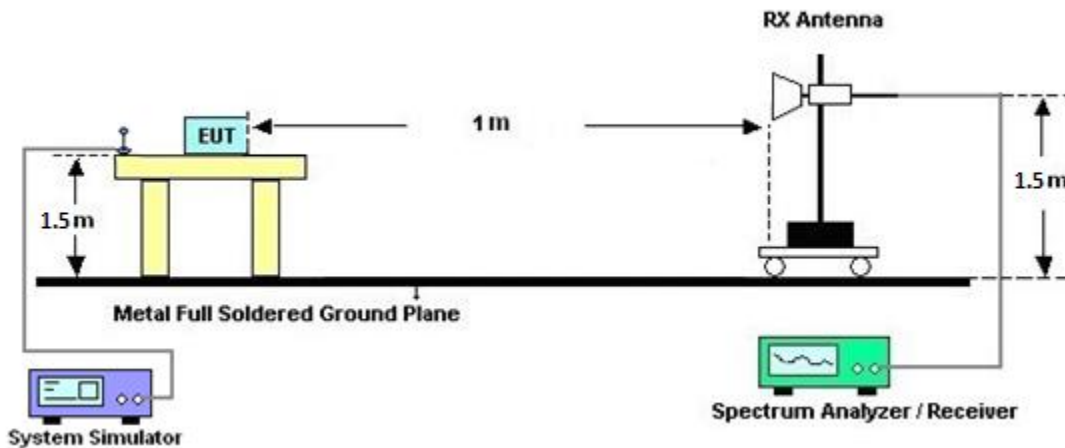

### 4.3 Test Result of Radiated Test

Please refer to Appendix B.

**Note:**

The low frequency, which started from 9 kHz to 30MHz, was pre-scanned and the result which was 20dB lower than the limit line was not reported.

There is a comparison data of both open-field test site and alternative test site - semi-Anechoic chamber according to 414788 D01 Radiated Test Site v01r01, and the result came out very similar.



## **4.4 Field Strength of Spurious Radiation Measurement**

### **4.4.1 Description of Field Strength of Spurious Radiated Measurement**

The power of any emission outside of the authorized operating frequency ranges must be attenuated below the transmitter power (P) by a factor of at least  $43 + 10 \log (P)$  dB. The spectrum is scanned from 30 MHz up to a frequency including its 10th harmonic.

### **4.4.2 Test Procedures**

The testing follows FCC KDB 971168 D01 v03r01 Section 7 and ANSI / TIA-603-E Section 2.2.12.

1. The EUT was placed on a rotatable wooden table 0.8 meters for frequency below 1GHz and 1.5 meter for frequency above 1GHz above the ground.
2. The EUT was set 3 meters from the receiving antenna, which was mounted on the antenna tower.
3. The table was rotated 360 degrees to determine the position of the highest spurious emission.
4. The height of the receiving antenna is varied between one meter and four meters to search for the maximum spurious emission for both horizontal and vertical polarizations.
5. Make the measurement with the spectrum analyzer's RBW = 1MHz, VBW = 3MHz, taking record of maximum spurious emission.
6. A horn antenna was substituted in place of the EUT and was driven by a signal generator.
7. Tune the output power of signal generator to the same emission level with EUT maximum spurious emission.
8. Taking the record of output power at antenna port.
9. Repeat step 7 to step 8 for another polarization.
10.  $EIRP (dBm) = S.G. Power - Tx Cable Loss + Tx Antenna Gain$
11.  $ERP (dBm) = EIRP - 2.15$
12. The RF fundamental frequency should be excluded against the limit line in the operating frequency band.
13. The limit line is derived from  $43 + 10\log(P)$  dB below the transmitter power P(Watts)



## 5 List of Measuring Equipment

Instrument	Brand Name	Model No.	Serial No.	Characteristics	Calibration Date	Test Date	Due Date	Remark
Hygrometer	Testo	608-H1	34893241	N/A	Mar. 26, 2020	Jul. 23, 2020~ Jul. 24, 2020	Mar. 25, 2021	Conducted (TH03-HY)
Spectrum Analyzer	Rohde & Schwarz	FSP30	101329	9kHz~30GHz	Sep. 04, 2019	Jul. 23, 2020~ Jul. 24, 2020	Sep. 03, 2020	Conducted (TH03-HY)
Temperature Chamber	ESPEC	SU-641	92013721	-30℃ ~-70℃	Nov. 26, 2019	Jul. 23, 2020~ Jul. 24, 2020	Nov. 25, 2020	Conducted (TH03-HY)
Programmable Power Supply	GW Instek	PSS-2005	EL890001	1V~20V 0.5A~4A	Oct. 09, 2019	Jul. 23, 2020~ Jul. 24, 2020	Oct. 08, 2020	Conducted (TH03-HY)
Base Station (Measure)	Rohde & Schwarz	CMU200	117995	GSM / GPRS / WCDMA / CDMA	Aug. 23, 2019	Jul. 23, 2020~ Jul. 24, 2020	Aug. 22, 2020	Conducted (TH03-HY)
Power Divider	Warison	WCOU-0.4-26.5S-20	#A	N/A	Nov. 06, 2019	Jul. 23, 2020~ Jul. 24, 2020	Nov. 05, 2020	Conducted (TH03-HY)
Loop Antenna	Rohde & Schwarz	HFH2-Z2	100315	9 kHz~30 MHz	Dec. 26, 2019	Aug. 14, 2020~ Sep. 02, 2020	Dec. 25, 2020	Radiation (03CH12-HY)
Bilog Antenna	TESEQ	CBL 6111D & 00800N1D01N-06	37059 & 01	30MHz~1GHz	Oct. 12, 2019	Aug. 14, 2020~ Sep. 02, 2020	Oct. 11, 2020	Radiation (03CH12-HY)
Horn Antenna	SCHWARZBECK	BBHA 9120 D	9120D-1328	1GHz~18GHz	Nov. 14, 2019	Aug. 14, 2020~ Sep. 02, 2020	Nov. 13, 2020	Radiation (03CH12-HY)
Horn Antenna	SCHWARZBECK	BBHA 9120D	9120D-1522	1GHz ~ 18GHz	Sep. 19, 2019	Aug. 14, 2020~ Sep. 02, 2020	Sep. 18, 2020	Radiation (03CH12-HY)
SHF-EHF Horn Antenna	SCHWARZBECK	BBHA 9170	BBHA9170584	18GHz~40GHz	Dec. 10, 2019	Aug. 14, 2020~ Sep. 02, 2020	Dec. 09, 2020	Radiation (03CH12-HY)
SHF-EHF Horn Antenna	SCHWARZBECK	BBHA 9170	BBHA9170980	18GHz ~ 40GHz	Jan. 10, 2019	Aug. 14, 2020~ Sep. 02, 2020	Jan. 09, 2021	Radiation (03CH12-HY)
Preamplifier	COM-POWER	PA-103	161075	10MHz~1GHz	Mar. 25, 2020	Aug. 14, 2020~ Sep. 02, 2020	Mar. 24, 2021	Radiation (03CH12-HY)
Preamplifier	Keysight	83017A	MY57280120	1GHz~26.5GHz	Jul. 20, 2020	Aug. 14, 2020~ Sep. 02, 2020	Jul. 19, 2021	Radiation (03CH12-HY)
Preamplifier	Jet-Power	JPA0118-55-303K	1710001800054002	1GHz~18GHz	Feb. 07, 2020	Aug. 14, 2020~ Sep. 02, 2020	Feb. 06, 2021	Radiation (03CH12-HY)
Preamplifier	EMEC	EM18G40G	060715	18GHz~40GHz	Dec. 13, 2019	Aug. 14, 2020~ Sep. 02, 2020	Dec. 12, 2020	Radiation (03CH12-HY)
Spectrum Analyzer	Agilent	N9010A	MY54200485	10Hz~44GHz	Feb. 10, 2020	Aug. 14, 2020~ Sep. 02, 2020	Feb. 09, 2021	Radiation (03CH12-HY)
Signal Generator	Anritsu	MG3694C	163401	0.1Hz~40GHz	Feb. 15, 2020	Aug. 14, 2020~ Sep. 02, 2020	Feb. 14, 2021	Radiation (03CH12-HY)
RF Cable	HUBER + SUHNER	SUCOFLEX 104	MY9837/4PE	9kHz~30MHz	Mar. 12, 2020	Aug. 14, 2020~ Sep. 02, 2020	Mar. 11, 2021	Radiation (03CH12-HY)
RF Cable	HUBER + SUHNER	SUCOFLEX 126E	0058/126E	30MHz~18GHz	Dec. 12, 2019	Aug. 14, 2020~ Sep. 02, 2020	Dec. 11, 2020	Radiation (03CH12-HY)
RF Cable	HUBER + SUHNER	SUCOFLEX 102	505134/2	30MHz~40GHz	Feb. 25, 2020	Aug. 14, 2020~ Sep. 02, 2020	Feb. 24, 2021	Radiation (03CH12-HY)
RF Cable	HUBER + SUHNER	SUCOFLEX 102	800740/2	30MHz~40GHz	Feb. 25, 2020	Aug. 14, 2020~ Sep. 02, 2020	Feb. 24, 2021	Radiation (03CH12-HY)
Hygrometer	TECPEL	DTM-303B	TP140349	N/A	Oct. 25, 2019	Aug. 14, 2020~ Sep. 02, 2020	Oct. 24, 2020	Radiation (03CH12-HY)
Controller	EMEC	EM1000	N/A	Control Turn table & Ant Mast	N/A	Aug. 14, 2020~ Sep. 02, 2020	N/A	Radiation (03CH12-HY)
Antenna Mast	EMEC	AM-BS-4500-B	N/A	1m~4m	N/A	Aug. 14, 2020~ Sep. 02, 2020	N/A	Radiation (03CH12-HY)
Turn Table	EMEC	TT2000	N/A	0~360 Degree	N/A	Aug. 14, 2020~ Sep. 02, 2020	N/A	Radiation (03CH12-HY)
Software	Audix	E3 6.2009-8-24	RK-000989	N/A	N/A	Aug. 14, 2020~ Sep. 02, 2020	N/A	Radiation (03CH12-HY)



## 6 Uncertainty of Evaluation

### Uncertainty of Radiated Emission Measurement (30 MHz ~ 1000 MHz)

Measuring Uncertainty for a Level of Confidence of 95% ( $U = 2Uc(y)$ )	3.07
---	------

### Uncertainty of Radiated Emission Measurement (1 GHz ~ 18 GHz)

Measuring Uncertainty for a Level of Confidence of 95% ( $U = 2Uc(y)$ )	3.21
---	------

### Uncertainty of Radiated Emission Measurement (18 GHz ~ 40 GHz)

Measuring Uncertainty for a Level of Confidence of 95% ( $U = 2Uc(y)$ )	3.80
---	------



### Appendix A. Test Results of Conducted Test

#### Conducted Output Power(Average power)

Conducted Power (*Unit: dBm)						
Band	WCDMA Band V			WCDMA Band II		
Channel	4132	4182	4233	9262	9400	9538
Frequency	826.4	836.4	846.6	1852.4	1880	1907.6
RMC 12.2K	23.47	23.63	<b>23.82</b>	23.82	<b>23.89</b>	23.79
HSDPA Subtest-1	22.47	22.60	22.81	22.84	22.93	22.83
HSDPA Subtest-2	22.49	22.63	22.82	22.85	22.89	22.86
HSDPA Subtest-3	21.96	22.10	22.34	22.34	22.41	22.37
HSDPA Subtest-4	21.96	22.11	22.34	22.33	22.40	22.33
HSUPA Subtest-1	22.28	22.48	22.65	22.87	22.96	22.88
HSUPA Subtest-2	20.27	20.41	20.63	20.89	20.81	20.85
HSUPA Subtest-3	21.30	21.43	21.69	21.87	21.95	21.82
HSUPA Subtest-4	20.26	20.39	20.66	20.93	20.97	20.88
HSUPA Subtest-5	22.30	22.40	22.70	22.80	23.00	22.90



Conducted Power (*Unit: dBm)			
Band	WCDMA Band IV		
Channel	1312	1413	1513
Frequency	1712.4	1732.6	1752.6
RMC 12.2K	23.94	23.87	23.65
HSDPA Subtest-1	22.92	22.40	22.66
HSDPA Subtest-2	22.94	22.86	22.67
HSDPA Subtest-3	22.46	22.36	22.16
HSDPA Subtest-4	22.44	22.34	22.16
HSUPA Subtest-1	22.97	22.83	22.70
HSUPA Subtest-2	20.94	20.81	20.68
HSUPA Subtest-3	21.92	21.84	21.68
HSUPA Subtest-4	20.94	20.81	20.77
HSUPA Subtest-5	22.90	22.90	22.30



## A2. WCDMA

### Peak-to-Average Ratio

Mode	WCDMA Band V	WCDMA Band II	WCDMA Band IV	Limit: 13dB
Mod.	RMC 12.2Kbps	RMC 12.2Kbps	RMC 12.2Kbps	Result
Lowest CH	3.00	2.96	3.00	<b>PASS</b>
Middle CH	2.96	2.96	2.96	
Highest CH	2.96	2.96	3.00	

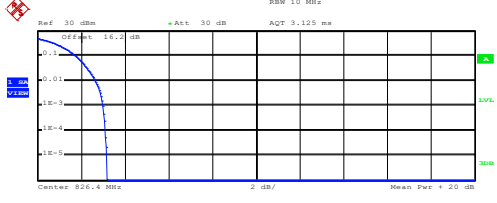
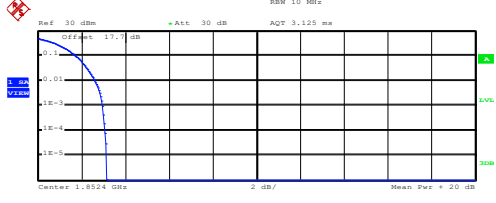
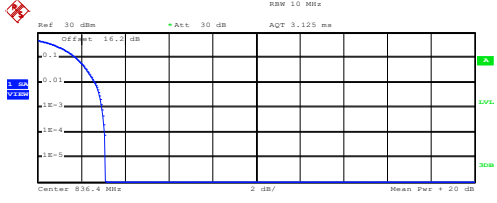
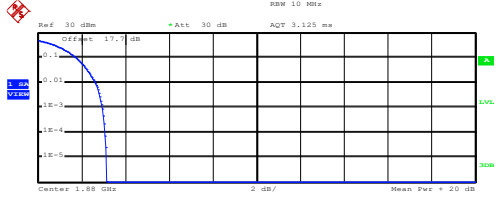
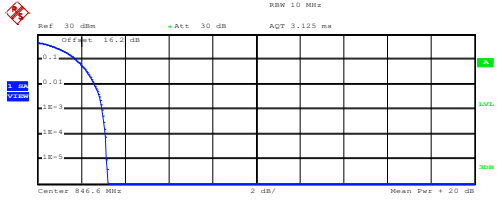
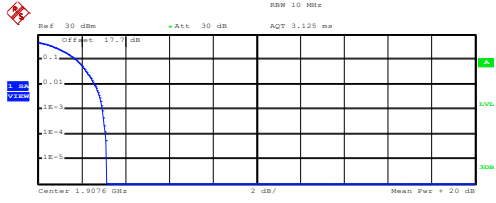

WCDMA Band V (RMC 12.2Kbps)	WCDMA Band II (RMC 12.2Kbps)
<p align="center"><b>Lowest Channel</b></p>  <p>Center: 826.4 MHz      2 dB/      Mean Pwr + 20 dB</p> <p>Complementary Cumulative Distribution Function (100000 samples)</p> <p>Trace 1</p> <p>Mean 23.19 dBm Peak 26.37 dBm Crest 3.18 dB</p> <p>10 % 1.76 dB 1 % 2.64 dB .1 % 3.00 dB .01 % 3.12 dB</p> <p>Date: 23.JUL.2020 18:22:37</p>	<p align="center"><b>Lowest Channel</b></p>  <p>Center: 1.8524 GHz      2 dB/      Mean Pwr + 20 dB</p> <p>Complementary Cumulative Distribution Function (100000 samples)</p> <p>Trace 1</p> <p>Mean 22.73 dBm Peak 25.88 dBm Crest 3.15 dB</p> <p>10 % 1.72 dB 1 % 2.60 dB .1 % 2.96 dB .01 % 3.08 dB</p> <p>Date: 23.JUL.2020 17:45:28</p>
<p align="center"><b>Middle Channel</b></p>  <p>Center: 836.4 MHz      2 dB/      Mean Pwr + 20 dB</p> <p>Complementary Cumulative Distribution Function (100000 samples)</p> <p>Trace 1</p> <p>Mean 23.33 dBm Peak 26.44 dBm Crest 3.11 dB</p> <p>10 % 1.76 dB 1 % 2.64 dB .1 % 2.96 dB .01 % 3.08 dB</p> <p>Date: 23.JUL.2020 18:23:00</p>	<p align="center"><b>Middle Channel</b></p>  <p>Center: 1.88 GHz      2 dB/      Mean Pwr + 20 dB</p> <p>Complementary Cumulative Distribution Function (100000 samples)</p> <p>Trace 1</p> <p>Mean 22.66 dBm Peak 25.81 dBm Crest 3.15 dB</p> <p>10 % 1.76 dB 1 % 2.64 dB .1 % 2.96 dB .01 % 3.08 dB</p> <p>Date: 23.JUL.2020 17:45:57</p>
<p align="center"><b>Highest Channel</b></p>  <p>Center: 846.6 MHz      2 dB/      Mean Pwr + 20 dB</p> <p>Complementary Cumulative Distribution Function (100000 samples)</p> <p>Trace 1</p> <p>Mean 23.15 dBm Peak 26.37 dBm Crest 3.22 dB</p> <p>10 % 1.76 dB 1 % 2.60 dB .1 % 2.96 dB .01 % 3.12 dB</p> <p>Date: 23.JUL.2020 18:23:17</p>	<p align="center"><b>Highest Channel</b></p>  <p>Center: 1.9076 GHz      2 dB/      Mean Pwr + 20 dB</p> <p>Complementary Cumulative Distribution Function (100000 samples)</p> <p>Trace 1</p> <p>Mean 23.08 dBm Peak 26.23 dBm Crest 3.15 dB</p> <p>10 % 1.76 dB 1 % 2.60 dB .1 % 2.96 dB .01 % 3.08 dB</p> <p>Date: 23.JUL.2020 17:46:19</p>





WCDMA Band IV (RMC 12.2Kbps)

Lowest Channel

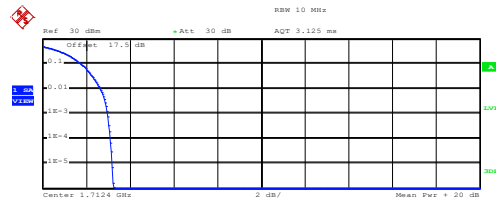

Complementary Cumulative Distribution Function (100000 samples)

Trace 1

Mean 22.84 dBm

Peak 26.09 dBm

Crest 3.25 dB

10 %	1.76 dB
1 %	2.64 dB
.1 %	3.00 dB
.01 %	3.12 dB

Date: 23.JUL.2020 18:03:38

Middle Channel

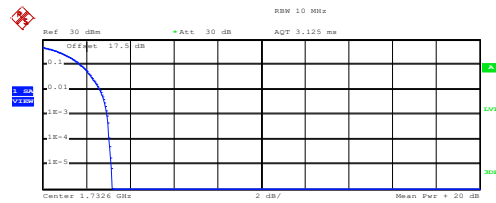

Complementary Cumulative Distribution Function (100000 samples)

Trace 1

Mean 22.91 dBm

Peak 26.09 dBm

Crest 3.18 dB

10 %	1.76 dB
1 %	2.64 dB
.1 %	2.96 dB
.01 %	3.04 dB

Date: 23.JUL.2020 18:04:01

Highest Channel

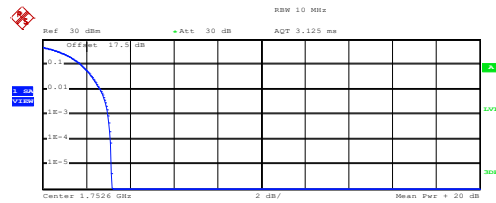

Complementary Cumulative Distribution Function (100000 samples)

Trace 1

Mean 22.72 dBm

Peak 25.88 dBm

Crest 3.16 dB

10 %	1.76 dB
1 %	2.64 dB
.1 %	3.00 dB
.01 %	3.12 dB

Date: 23.JUL.2020 18:04:22



**26dB Bandwidth**

Mode	WCDMA Band V 26dB BW(MHz)	WCDMA Band II 26dB BW(MHz)	WCDMA Band IV 26dB BW(MHz)
Mod.	RMC 12.2Kbps	RMC 12.2Kbps	RMC 12.2Kbps
Lowest CH	4.72	4.72	4.71
Middle CH	4.71	4.72	4.70
Highest CH	4.74	4.72	4.70



WCDMA Band V (RMC 12.2Kbps)	WCDMA Band II (RMC 12.2Kbps)
<p style="text-align: center;"><b>Lowest Channel</b></p> <p>Ref: 30 dBm, Att: 30 dB, BW: 4.72000000 MHz, Span: 10 MHz, Center: 826.4 MHz. Peak level: -7.81 dBm.</p> <p>Date: 23.JUL.2020 18:08:41</p>	<p style="text-align: center;"><b>Lowest Channel</b></p> <p>Ref: 30 dBm, Att: 30 dB, BW: 4.72000000 MHz, Span: 10 MHz, Center: 1.8524 GHz. Peak level: -7.98 dBm.</p> <p>Date: 23.JUL.2020 17:24:33</p>
<p style="text-align: center;"><b>Middle Channel</b></p> <p>Ref: 30 dBm, Att: 30 dB, BW: 4.71000000 MHz, Span: 10 MHz, Center: 836.4 MHz. Peak level: -6.55 dBm.</p> <p>Date: 23.JUL.2020 18:09:24</p>	<p style="text-align: center;"><b>Middle Channel</b></p> <p>Ref: 30 dBm, Att: 30 dB, BW: 4.72000000 MHz, Span: 10 MHz, Center: 1.88 GHz. Peak level: -7.79 dBm.</p> <p>Date: 23.JUL.2020 17:25:48</p>
<p style="text-align: center;"><b>Highest Channel</b></p> <p>Ref: 30 dBm, Att: 30 dB, BW: 4.74000000 MHz, Span: 10 MHz, Center: 846.6 MHz. Peak level: -7.81 dBm.</p> <p>Date: 23.JUL.2020 18:10:03</p>	<p style="text-align: center;"><b>Highest Channel</b></p> <p>Ref: 30 dBm, Att: 30 dB, BW: 4.72000000 MHz, Span: 10 MHz, Center: 1.9076 GHz. Peak level: -7.21 dBm.</p> <p>Date: 23.JUL.2020 17:26:30</p>



WCDMA Band IV (RMC 12.2Kbps)

Lowest Channel

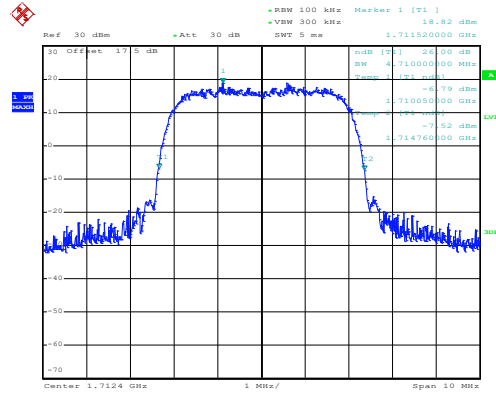

Date: 23.JUL.2020 17:48:57

Middle Channel

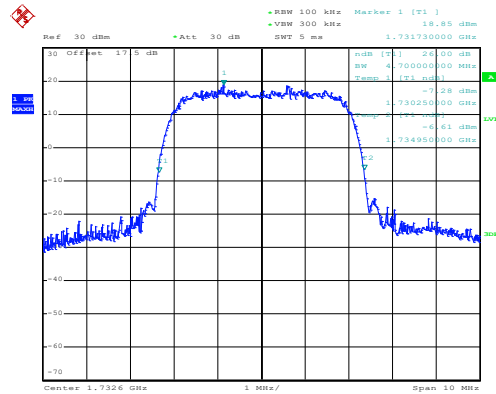

Date: 23.JUL.2020 17:49:37

Highest Channel

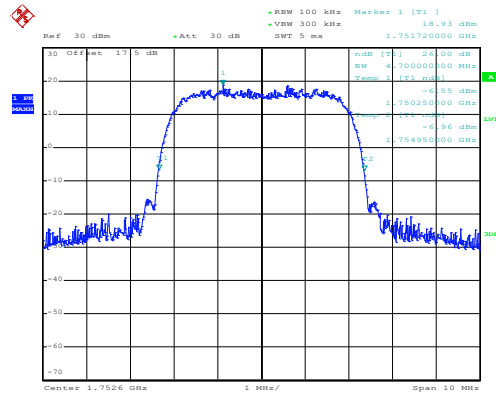

Date: 23.JUL.2020 17:50:17



**Occupied Bandwidth**

Mode	WCDMA Band V 99% OBW(MHz)	WCDMA Band II 99% OBW(MHz)	WCDMA Band IV 99% OBW(MHz)
Mod.	RMC 12.2Kbps	RMC 12.2Kbps	RMC 12.2Kbps
Lowest CH	4.14	4.15	4.14
Middle CH	4.15	4.14	4.15
Highest CH	4.15	4.15	4.14



WCDMA Band V (RMC 12.2Kbps)	WCDMA Band II (RMC 12.2Kbps)
<p style="text-align: center;"><b>Lowest Channel</b></p> <p>Date: 23.JUL.2020 18:14:58</p>	<p style="text-align: center;"><b>Lowest Channel</b></p> <p>Date: 23.JUL.2020 17:31:34</p>
<p style="text-align: center;"><b>Middle Channel</b></p> <p>Date: 23.JUL.2020 18:15:38</p>	<p style="text-align: center;"><b>Middle Channel</b></p> <p>Date: 23.JUL.2020 17:32:32</p>
<p style="text-align: center;"><b>Highest Channel</b></p> <p>Date: 23.JUL.2020 18:16:18</p>	<p style="text-align: center;"><b>Highest Channel</b></p> <p>Date: 23.JUL.2020 17:33:23</p>



### WCDMA Band IV (RMC 12.2Kbps)

#### Lowest Channel

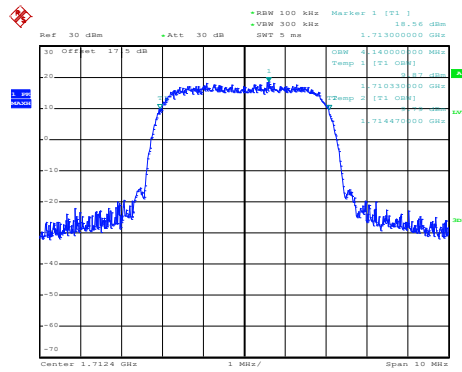

Date: 23.JUL.2020 17:54:17

#### Middle Channel

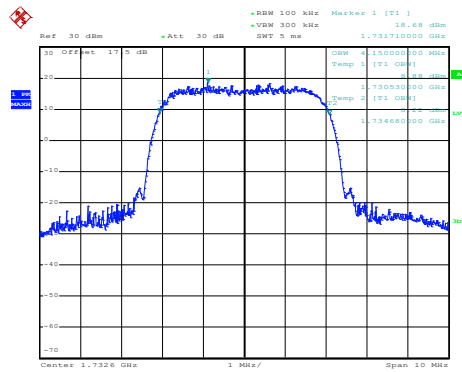

Date: 23.JUL.2020 17:54:57

#### Highest Channel

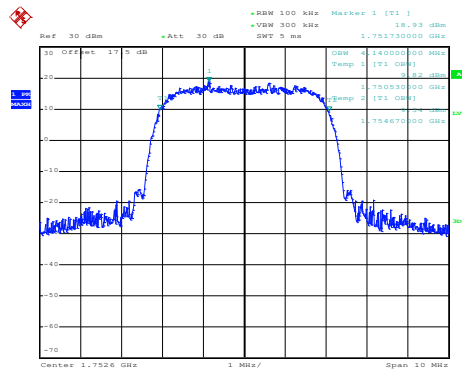

Date: 23.JUL.2020 17:55:38



# Conducted Band Edge

## WCDMA Band V (RMC 12.2Kbps)

### Lowest Band Edge

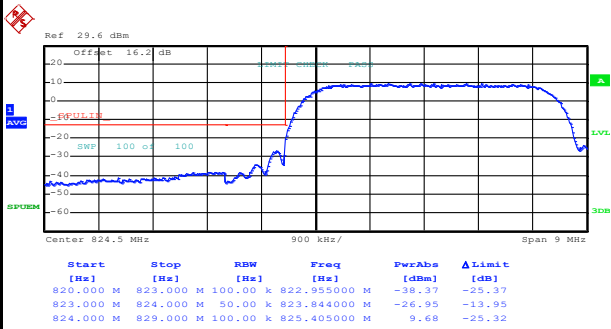

Date: 23.JUL.2020 18:19:19

### Highest Band Edge

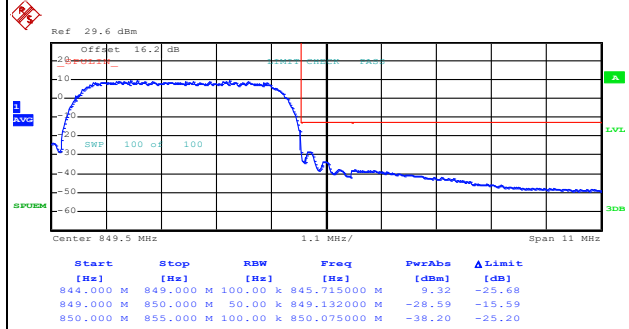

Date: 23.JUL.2020 18:22:11

## WCDMA Band II (RMC 12.2Kbps)

### Lowest Band Edge

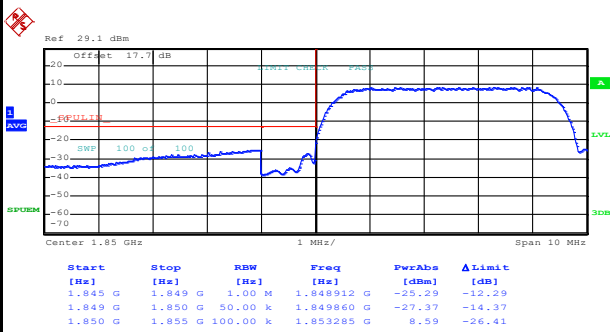

Date: 23.JUL.2020 17:36:31

### Highest Band Edge

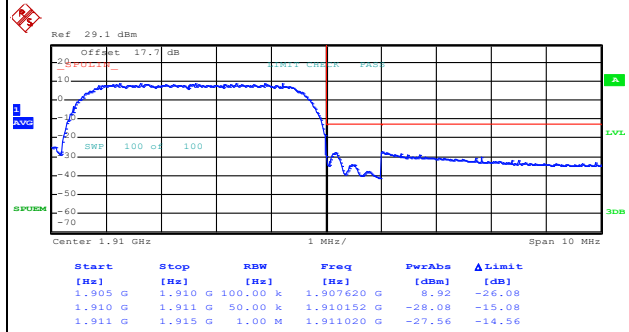

Date: 23.JUL.2020 17:39:26





WCDMA Band IV (RMC 12.2Kbps)

Lowest Band Edge

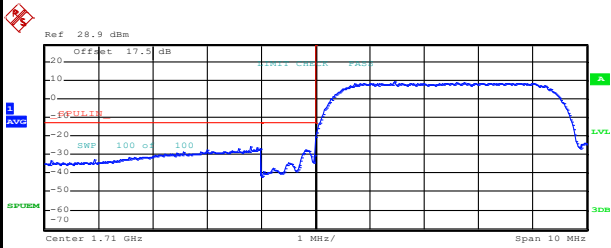

Start [Hz]	Stop [Hz]	RBW [Hz]	Freq [Hz]	PwrAbs [dBm]	ΔLimit [dB]
1.709 G	1.709 G	1.00 M	1.708792 G	-25.82	-12.82
1.709 G	1.710 G	50.00 k	1.709816 G	-27.68	-14.68
1.710 G	1.715 G	100.00 k	1.711450 G	9.18	-25.82

Date: 23.JUL.2020 17:59:29

Highest Band Edge

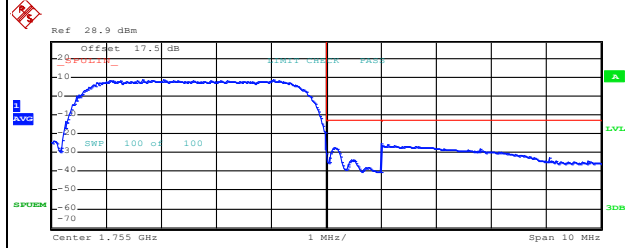

Start [Hz]	Stop [Hz]	RBW [Hz]	Freq [Hz]	PwrAbs [dBm]	ΔLimit [dB]
1.750 G	1.755 G	100.00 k	1.751660 G	8.93	-26.07
1.755 G	1.756 G	50.00 k	1.755156 G	-27.40	-14.40
1.756 G	1.760 G	1.00 M	1.756004 G	-25.40	-12.40

Date: 23.JUL.2020 18:02:24

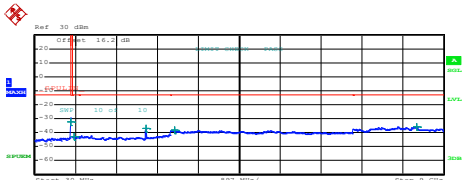
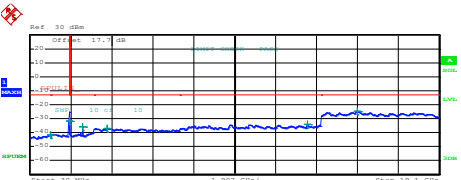
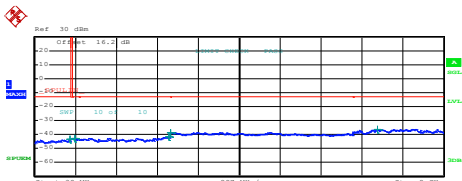
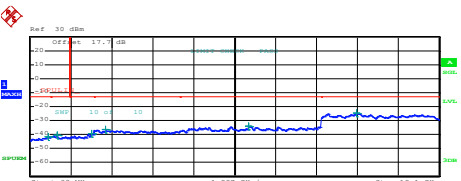

**Conducted Spurious Emission**

WCDMA Band V (RMC 12.2Kbps)	WCDMA Band II (RMC 12.2Kbps)																																																																														
Lowest Channel	Lowest Channel																																																																														
 <table border="1" data-bbox="223 660 654 750"> <thead> <tr> <th>Start [Hz]</th> <th>Stop [Hz]</th> <th>RBW [Hz]</th> <th>Freq [Hz]</th> <th>PwrAbs [dBm]</th> <th>ΔLimit [dB]</th> </tr> </thead> <tbody> <tr> <td>30.000 M</td> <td>820.000 M</td> <td>1.00 M</td> <td>816.223500 M</td> <td>-32.17</td> <td>-19.17</td> </tr> <tr> <td>855.000 M</td> <td>1.000 G</td> <td>1.00 M</td> <td>884.362502 M</td> <td>-42.60</td> <td>-29.60</td> </tr> <tr> <td>1.000 G</td> <td>3.000 G</td> <td>1.00 M</td> <td>2.461000 G</td> <td>-37.11</td> <td>-24.11</td> </tr> <tr> <td>3.000 G</td> <td>7.000 G</td> <td>1.00 M</td> <td>3.092000 G</td> <td>-38.32</td> <td>-25.32</td> </tr> <tr> <td>7.000 G</td> <td>9.000 G</td> <td>1.00 M</td> <td>8.416500 G</td> <td>-35.76</td> <td>-22.76</td> </tr> </tbody> </table> <p>Date: 23.JUL.2020 18:11:09</p>	Start [Hz]	Stop [Hz]	RBW [Hz]	Freq [Hz]	PwrAbs [dBm]	ΔLimit [dB]	30.000 M	820.000 M	1.00 M	816.223500 M	-32.17	-19.17	855.000 M	1.000 G	1.00 M	884.362502 M	-42.60	-29.60	1.000 G	3.000 G	1.00 M	2.461000 G	-37.11	-24.11	3.000 G	7.000 G	1.00 M	3.092000 G	-38.32	-25.32	7.000 G	9.000 G	1.00 M	8.416500 G	-35.76	-22.76	 <table border="1" data-bbox="877 660 1308 750"> <thead> <tr> <th>Start [Hz]</th> <th>Stop [Hz]</th> <th>RBW [Hz]</th> <th>Freq [Hz]</th> <th>PwrAbs [dBm]</th> <th>ΔLimit [dB]</th> </tr> </thead> <tbody> <tr> <td>30.000 M</td> <td>1.000 G</td> <td>1.00 M</td> <td>905.000000 M</td> <td>-41.43</td> <td>-28.43</td> </tr> <tr> <td>1.000 G</td> <td>1.845 G</td> <td>1.00 M</td> <td>1.842465 G</td> <td>-31.89</td> <td>-18.89</td> </tr> <tr> <td>1.915 G</td> <td>3.000 G</td> <td>1.00 M</td> <td>2.463396 G</td> <td>-35.78</td> <td>-22.78</td> </tr> <tr> <td>3.000 G</td> <td>7.000 G</td> <td>1.00 M</td> <td>3.623000 G</td> <td>-36.90</td> <td>-23.90</td> </tr> <tr> <td>7.000 G</td> <td>13.600 G</td> <td>1.00 M</td> <td>12.973000 G</td> <td>-34.06</td> <td>-21.06</td> </tr> <tr> <td>13.600 G</td> <td>19.100 G</td> <td>1.00 M</td> <td>15.295375 G</td> <td>-24.86</td> <td>-11.86</td> </tr> </tbody> </table> <p>Date: 23.JUL.2020 17:27:43</p>	Start [Hz]	Stop [Hz]	RBW [Hz]	Freq [Hz]	PwrAbs [dBm]	ΔLimit [dB]	30.000 M	1.000 G	1.00 M	905.000000 M	-41.43	-28.43	1.000 G	1.845 G	1.00 M	1.842465 G	-31.89	-18.89	1.915 G	3.000 G	1.00 M	2.463396 G	-35.78	-22.78	3.000 G	7.000 G	1.00 M	3.623000 G	-36.90	-23.90	7.000 G	13.600 G	1.00 M	12.973000 G	-34.06	-21.06	13.600 G	19.100 G	1.00 M	15.295375 G	-24.86	-11.86
Start [Hz]	Stop [Hz]	RBW [Hz]	Freq [Hz]	PwrAbs [dBm]	ΔLimit [dB]																																																																										
30.000 M	820.000 M	1.00 M	816.223500 M	-32.17	-19.17																																																																										
855.000 M	1.000 G	1.00 M	884.362502 M	-42.60	-29.60																																																																										
1.000 G	3.000 G	1.00 M	2.461000 G	-37.11	-24.11																																																																										
3.000 G	7.000 G	1.00 M	3.092000 G	-38.32	-25.32																																																																										
7.000 G	9.000 G	1.00 M	8.416500 G	-35.76	-22.76																																																																										
Start [Hz]	Stop [Hz]	RBW [Hz]	Freq [Hz]	PwrAbs [dBm]	ΔLimit [dB]																																																																										
30.000 M	1.000 G	1.00 M	905.000000 M	-41.43	-28.43																																																																										
1.000 G	1.845 G	1.00 M	1.842465 G	-31.89	-18.89																																																																										
1.915 G	3.000 G	1.00 M	2.463396 G	-35.78	-22.78																																																																										
3.000 G	7.000 G	1.00 M	3.623000 G	-36.90	-23.90																																																																										
7.000 G	13.600 G	1.00 M	12.973000 G	-34.06	-21.06																																																																										
13.600 G	19.100 G	1.00 M	15.295375 G	-24.86	-11.86																																																																										
Middle Channel	Middle Channel																																																																														
 <table border="1" data-bbox="223 1198 654 1288"> <thead> <tr> <th>Start [Hz]</th> <th>Stop [Hz]</th> <th>RBW [Hz]</th> <th>Freq [Hz]</th> <th>PwrAbs [dBm]</th> <th>ΔLimit [dB]</th> </tr> </thead> <tbody> <tr> <td>30.000 M</td> <td>820.000 M</td> <td>1.00 M</td> <td>805.385000 M</td> <td>-43.15</td> <td>-30.15</td> </tr> <tr> <td>855.000 M</td> <td>1.000 G</td> <td>1.00 M</td> <td>916.335004 M</td> <td>-42.70</td> <td>-29.70</td> </tr> <tr> <td>1.000 G</td> <td>3.000 G</td> <td>1.00 M</td> <td>2.968500 G</td> <td>-42.81</td> <td>-28.81</td> </tr> <tr> <td>3.000 G</td> <td>7.000 G</td> <td>1.00 M</td> <td>3.003000 G</td> <td>-38.56</td> <td>-25.56</td> </tr> <tr> <td>7.000 G</td> <td>9.000 G</td> <td>1.00 M</td> <td>7.538000 G</td> <td>-36.14</td> <td>-23.14</td> </tr> </tbody> </table> <p>Date: 23.JUL.2020 18:12:20</p>	Start [Hz]	Stop [Hz]	RBW [Hz]	Freq [Hz]	PwrAbs [dBm]	ΔLimit [dB]	30.000 M	820.000 M	1.00 M	805.385000 M	-43.15	-30.15	855.000 M	1.000 G	1.00 M	916.335004 M	-42.70	-29.70	1.000 G	3.000 G	1.00 M	2.968500 G	-42.81	-28.81	3.000 G	7.000 G	1.00 M	3.003000 G	-38.56	-25.56	7.000 G	9.000 G	1.00 M	7.538000 G	-36.14	-23.14	 <table border="1" data-bbox="877 1198 1308 1288"> <thead> <tr> <th>Start [Hz]</th> <th>Stop [Hz]</th> <th>RBW [Hz]</th> <th>Freq [Hz]</th> <th>PwrAbs [dBm]</th> <th>ΔLimit [dB]</th> </tr> </thead> <tbody> <tr> <td>30.000 M</td> <td>1.000 G</td> <td>1.00 M</td> <td>853.045000 M</td> <td>-41.62</td> <td>-28.62</td> </tr> <tr> <td>1.000 G</td> <td>1.845 G</td> <td>1.00 M</td> <td>1.273790 G</td> <td>-40.53</td> <td>-27.53</td> </tr> <tr> <td>1.915 G</td> <td>3.000 G</td> <td>1.00 M</td> <td>2.896925 G</td> <td>-39.94</td> <td>-26.94</td> </tr> <tr> <td>3.000 G</td> <td>7.000 G</td> <td>1.00 M</td> <td>3.552000 G</td> <td>-36.62</td> <td>-23.62</td> </tr> <tr> <td>7.000 G</td> <td>13.600 G</td> <td>1.00 M</td> <td>10.214200 G</td> <td>-34.20</td> <td>-21.20</td> </tr> <tr> <td>13.600 G</td> <td>19.100 G</td> <td>1.00 M</td> <td>15.258875 G</td> <td>-24.97</td> <td>-11.97</td> </tr> </tbody> </table> <p>Date: 23.JUL.2020 17:28:52</p>	Start [Hz]	Stop [Hz]	RBW [Hz]	Freq [Hz]	PwrAbs [dBm]	ΔLimit [dB]	30.000 M	1.000 G	1.00 M	853.045000 M	-41.62	-28.62	1.000 G	1.845 G	1.00 M	1.273790 G	-40.53	-27.53	1.915 G	3.000 G	1.00 M	2.896925 G	-39.94	-26.94	3.000 G	7.000 G	1.00 M	3.552000 G	-36.62	-23.62	7.000 G	13.600 G	1.00 M	10.214200 G	-34.20	-21.20	13.600 G	19.100 G	1.00 M	15.258875 G	-24.97	-11.97
Start [Hz]	Stop [Hz]	RBW [Hz]	Freq [Hz]	PwrAbs [dBm]	ΔLimit [dB]																																																																										
30.000 M	820.000 M	1.00 M	805.385000 M	-43.15	-30.15																																																																										
855.000 M	1.000 G	1.00 M	916.335004 M	-42.70	-29.70																																																																										
1.000 G	3.000 G	1.00 M	2.968500 G	-42.81	-28.81																																																																										
3.000 G	7.000 G	1.00 M	3.003000 G	-38.56	-25.56																																																																										
7.000 G	9.000 G	1.00 M	7.538000 G	-36.14	-23.14																																																																										
Start [Hz]	Stop [Hz]	RBW [Hz]	Freq [Hz]	PwrAbs [dBm]	ΔLimit [dB]																																																																										
30.000 M	1.000 G	1.00 M	853.045000 M	-41.62	-28.62																																																																										
1.000 G	1.845 G	1.00 M	1.273790 G	-40.53	-27.53																																																																										
1.915 G	3.000 G	1.00 M	2.896925 G	-39.94	-26.94																																																																										
3.000 G	7.000 G	1.00 M	3.552000 G	-36.62	-23.62																																																																										
7.000 G	13.600 G	1.00 M	10.214200 G	-34.20	-21.20																																																																										
13.600 G	19.100 G	1.00 M	15.258875 G	-24.97	-11.97																																																																										



Highest Channel

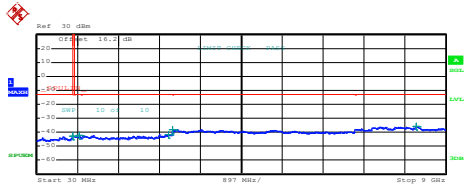

Start [Hz]	Stop [Hz]	RBW [Hz]	Freq [Hz]	PwrAve [dBm]	ΔLimit [dB]
30,000 M	820,000 M	1,000 M	818,232300 M	-42.73	-29.73
855,000 M	1,000 G	1,000 M	960,197507 M	-42.33	-29.33
1,000 G	3,000 G	1,000 M	2,918000 G	-43.35	-28.35
3,000 G	7,000 G	1,000 M	3,007000 G	-38.03	-25.03
7,000 G	9,000 G	1,000 M	8,361000 G	-35.84	-22.84

Date: 23.JUL.2020 18:13:23

Highest Channel

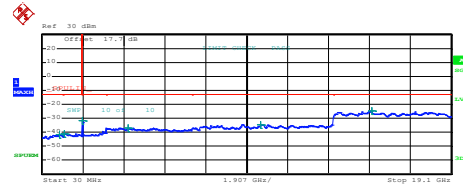

Start [Hz]	Stop [Hz]	RBW [Hz]	Freq [Hz]	PwrAve [dBm]	ΔLimit [dB]
30,000 M	2,000 G	1,000 M	846,230300 M	-43.30	-28.30
1,000 G	3,845 G	1,000 M	1,066544 G	-40.91	-27.91
1,915 G	3,000 G	1,000 M	1,937370 G	-31.69	-18.69
3,000 G	7,000 G	1,000 M	4,043200 G	-36.81	-23.81
7,000 G	13,600 G	1,000 M	10,238325 G	-34.56	-21.56
13,600 G	19,100 G	1,000 M	15,399188 G	-24.93	-11.93

Date: 23.JUL.2020 17:30:10



WCDMA Band IV (RMC 12.2Kbps)

Lowest Channel

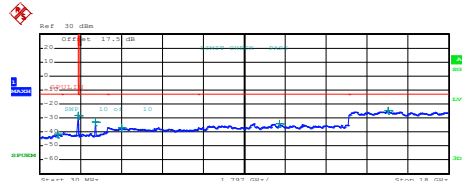

Start [MHz]	Stop [MHz]	RBW [Hz]	Freq [MHz]	PwrAve [dBm]	Limt [dB]
30.000 M	1.000 G	1.00 M	810.365000 M	-41.91	-28.91
1.000 G	1.705 G	1.00 M	1.704848 G	-27.97	-14.97
1.760 G	3.000 G	1.00 M	2.461530 G	-32.86	-19.86
3.000 G	7.000 G	1.00 M	3.611000 G	-36.74	-23.74
7.000 G	13.600 G	1.00 M	10.365000 G	-33.98	-20.98
13.600 G	18.000 G	1.00 M	15.329750 G	-24.57	-11.57

Date: 23.JUL.2020 17:51:29

Middle Channel

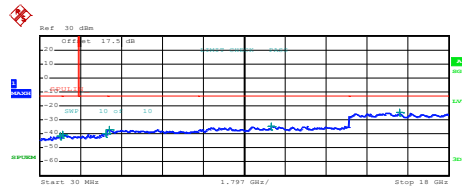

Start [MHz]	Stop [MHz]	RBW [Hz]	Freq [MHz]	PwrAve [dBm]	Limt [dB]
30.000 M	1.000 G	1.00 M	810.380000 M	-41.84	-28.84
1.000 G	1.705 G	1.00 M	1.040000 G	-40.55	-27.55
1.760 G	3.000 G	1.00 M	2.935500 G	-40.05	-27.05
3.000 G	7.000 G	1.00 M	3.089000 G	-36.70	-23.70
7.000 G	13.600 G	1.00 M	10.209250 G	-34.45	-21.45
13.600 G	18.000 G	1.00 M	15.859400 G	-24.86	-11.86

Date: 23.JUL.2020 17:52:24

Highest Channel

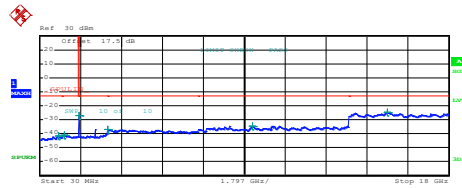

Start [MHz]	Stop [MHz]	RBW [Hz]	Freq [MHz]	PwrAve [dBm]	Limt [dB]
30.000 M	1.000 G	1.00 M	863.280000 M	-41.70	-28.70
1.000 G	1.705 G	1.00 M	1.097995 G	-41.00	-28.00
1.760 G	3.000 G	1.00 M	1.765260 G	-27.06	-14.06
3.000 G	7.000 G	1.00 M	3.024000 G	-36.99	-23.99
7.000 G	13.600 G	1.00 M	9.378475 G	-34.55	-21.55
13.600 G	18.000 G	1.00 M	15.300000 G	-24.51	-11.51

Date: 23.JUL.2020 17:53:21



Frequency Stability

Test Conditions	Middle Channel	WCDMA Band V (RMC 12.2Kbps)	Limit 2.5ppm
Temperature (°C)	Voltage (Volt)	Deviation (ppm)	Result
50	Normal Voltage	0.0012	PASS
40	Normal Voltage	0.0012	
30	Normal Voltage	0.0000	
20(Ref.)	Normal Voltage	0.0000	
10	Normal Voltage	0.0012	
0	Normal Voltage	0.0000	
-10	Normal Voltage	0.0012	
-20	Normal Voltage	0.0120	
-30	Normal Voltage	0.0143	
20	Maximum Voltage	0.0036	
20	Normal Voltage	0.0000	
20	Battery End Point	0.0012	

Test Conditions	Middle Channel	WCDMA Band II (RMC 12.2Kbps)	Limit Note 2.
Temperature (°C)	Voltage (Volt)	Deviation (ppm)	Result
50	Normal Voltage	0.0011	PASS
40	Normal Voltage	0.0005	
30	Normal Voltage	0.0011	
20(Ref.)	Normal Voltage	0.0000	
10	Normal Voltage	0.0000	
0	Normal Voltage	0.0011	
-10	Normal Voltage	0.0005	
-20	Normal Voltage	0.0005	
-30	Normal Voltage	0.0000	
20	Maximum Voltage	0.0005	
20	Normal Voltage	0.0000	
20	Battery End Point	0.0011	



Test Conditions	Middle Channel	WCDMA Band IV (RMC 12.2Kbps)	Limit Note 2.
Temperature (°C)	Voltage (Volt)	Deviation (ppm)	Result
50	Normal Voltage	0.0046	PASS
40	Normal Voltage	0.0040	
30	Normal Voltage	0.0023	
20(Ref.)	Normal Voltage	0.0000	
10	Normal Voltage	0.0000	
0	Normal Voltage	0.0012	
-10	Normal Voltage	0.0017	
-20	Normal Voltage	0.0162	
-30	Normal Voltage	0.0167	
20	Maximum Voltage	0.0006	
20	Normal Voltage	0.0000	
20	Battery End Point	0.0000	

**Note:**

1. Normal Voltage = 3.85V. ; Battery End Point (BEP) = 3.3 V. ; Maximum Voltage =4.25 V
2. The frequency fundamental emissions stay within the authorized frequency block.



## Appendix B. Test Results of ERP/EIRP and Radiated Test

### ERP/EIRP

Channel	Mode	Conducted		ERP	
		Power (dBm)	Power (Watts)	ERP(dBm)	ERP(W)
Lowest	WCDMA Band V	23.47	0.2223	21.52	0.1419
Middle	RMC 12.2Kbps	23.63	0.2307	21.68	0.1472
Highest	(GT - LC = 0.2 dB)	23.82	0.2410	21.87	0.1538
Limit	ERP < 7W	Result		PASS	

Channel	Mode	Conducted		EIRP	
		Power (dBm)	Power (Watts)	EIRP(dBm)	EIRP(W)
Lowest	WCDMA Band II	23.82	0.2410	27.42	0.5521
Middle	RMC 12.2Kbps	23.89	0.2449	27.49	0.5610
Highest	(GT - LC = 3.6 dB)	23.79	0.2393	27.39	0.5483
Limit	EIRP < 2W	Result		PASS	

Channel	Mode	Conducted		EIRP	
		Power (dBm)	Power (Watts)	EIRP(dBm)	EIRP(W)
Lowest	WCDMA Band IV	23.94	0.2477	27.24	0.5297
Middle	RMC 12.2Kbps	23.87	0.2438	27.17	0.5212
Highest	(GT - LC = 3.3 dB)	23.65	0.2317	26.95	0.4955
Limit	EIRP < 1W	Result		PASS	



**Radiated Spurious Emission**

**WCDMA 850**

WCDMA 850									
Channel	Frequency ( MHz )	ERP ( dBm )	Limit ( dBm )	Over Limit ( dB )	SPA Reading (dBm)	S.G. Power ( dBm )	TX Cable loss ( dB )	TX Antenna Gain (dBi)	Polarization (H/V)
Lowest	1656	-62.64	-13	-49.64	-71.09	-68.26	0.92	8.69	H
	2480	-58.57	-13	-45.57	-72.06	-65.95	1.15	10.67	H
	3304	-57.34	-13	-44.34	-72.65	-65.89	1.32	12.03	H
									H
									H
									H
									H
	1656	-63.12	-13	-50.12	-71	-68.74	0.92	8.69	V
	2480	-58.29	-13	-45.29	-71.95	-65.67	1.15	10.67	V
	3304	-56.93	-13	-43.93	-72.71	-65.48	1.32	12.03	V
									V
	Middle	1672	-62.69	-13	-49.69	-71.18	-68.37	0.93	8.75
2512		-58.72	-13	-45.72	-72.23	-66.13	1.15	10.71	H
3344		-57.21	-13	-44.21	-72.43	-65.85	1.33	12.13	H
									H
									H
									H
									H
1672		-63.39	-13	-50.39	-71.25	-69.07	0.93	8.75	V
2512		-58.68	-13	-45.68	-72.38	-66.09	1.15	10.71	V
3344		-56.83	-13	-43.83	-72.5	-65.47	1.33	12.13	V
									V
									V





Highest	1696	-62.24	-13	-49.24	-70.8	-68.00	0.94	8.84	H
	2536	-58.60	-13	-45.60	-72.11	-66.03	1.16	10.74	H
	3384	-57.46	-13	-44.46	-72.59	-66.19	1.34	12.22	H
									H
									H
									H
									H
	1696	-63.22	-13	-50.22	-71.07	-68.98	0.94	8.84	V
	2536	-58.62	-13	-45.62	-72.26	-66.05	1.16	10.74	V
	3384	-57.18	-13	-44.18	-72.75	-65.91	1.34	12.22	V
									V
									V
									V
									V

Remark: Spurious emissions within 30-1000MHz were found more than 20dB below limit line.



**WCDMA 1700**

WCDMA 1700									
Channel	Frequency ( MHz )	EIRP ( dBm )	Limit ( dBm )	Over Limit ( dB )	SPA Reading (dBm)	S.G. Power ( dBm )	TX Cable loss ( dB )	TX Antenna Gain (dBi)	Polarization (H/V)
Lowest	3427	-56.78	-13	-43.78	-72.85	-67.76	1.35	12.32	H
	5135	-52.29	-13	-39.29	-74.2	-63.43	1.65	12.79	H
	6850	-48.08	-13	-35.08	-73.48	-58.45	1.74	12.11	H
									H
									H
									H
									H
	3427	-55.98	-13	-42.98	-72.46	-66.96	1.35	12.32	V
	5135	-52.86	-13	-39.86	-74.52	-64.00	1.65	12.79	V
	6850	-48.71	-13	-35.71	-73.7	-59.08	1.74	12.11	V
									V
									V
									V
									V
Middle	3465	-56.10	-13	-43.10	-72.52	-67.16	1.35	12.41	H
	5198	-52.41	-13	-39.41	-74.37	-63.63	1.66	12.88	H
	6927	-47.42	-13	-34.42	-73.19	-57.69	1.73	12.00	H
									H
									H
									H
									H
	3465	-55.91	-13	-42.91	-72.72	-66.97	1.35	12.42	V
	5198	-52.46	-13	-39.46	-74.26	-63.68	1.66	12.88	V
	6930	-47.95	-13	-34.95	-73.27	-58.22	1.73	12.00	V
									V
									V
									V
									V



Highest	3504	-55.78	-13	-42.78	-72.59	-66.92	1.36	12.50	H
	5261	-52.32	-13	-39.32	-74.51	-63.61	1.68	12.97	H
	7011	-47.84	-13	-34.84	-74.01	-58.00	1.73	11.88	H
									H
									H
									H
									H
	3504	-54.78	-13	-41.78	-71.94	-65.92	1.36	12.50	V
	5261	-52.27	-13	-39.27	-74.23	-63.56	1.68	12.97	V
	7011	-48.19	-13	-35.19	-73.87	-58.35	1.73	11.88	V
									V
									V
									V
									V

Remark: Spurious emissions within 30-1000MHz were found more than 20dB below limit line.



**WCDMA 1900**

WCDMA 1900									
Channel	Frequency ( MHz )	EIRP ( dBm )	Limit ( dBm )	Over Limit ( dB )	SPA Reading (dBm)	S.G. Power ( dBm )	TX Cable loss ( dB )	TX Antenna Gain (dBi)	Polarization (H/V)
Lowest	3702	-52.54	-13	-39.54	-70.5	-63.75	1.41	12.62	H
	5555	-50.47	-13	-37.47	-73.7	-62.03	1.74	13.30	H
	7410	-46.81	-13	-33.81	-73.66	-56.11	1.94	11.24	H
									H
									H
									H
									H
	3702	-52.38	-13	-39.38	-70.48	-63.59	1.41	12.62	V
	5555	-50.86	-13	-37.86	-73.62	-62.42	1.74	13.30	V
	7410	-46.80	-13	-33.80	-73.5	-56.10	1.94	11.24	V
									V
									V
									V
									V
Middle	3763	-53.63	-13	-40.63	-71.83	-64.86	1.43	12.66	H
	5640	-50.05	-13	-37.05	-73.3	-61.62	1.73	13.30	H
	7515	-46.00	-13	-33.00	-72.33	-55.11	1.99	11.10	H
									H
									H
									H
									H
	3763	-53.15	-13	-40.15	-71.57	-64.38	1.43	12.66	V
	5640	-50.45	-13	-37.45	-73.3	-62.02	1.73	13.30	V
	7515	-46.70	-13	-33.70	-73	-55.81	1.99	11.10	V
									V
									V
									V
									V



Highest	3819	-52.23	-13	-39.23	-70.61	-63.48	1.44	12.69	H
	5723	-50.35	-13	-37.35	-73.99	-61.92	1.73	13.30	H
	7634	-46.77	-13	-33.77	-72.64	-55.89	2.01	11.13	H
									H
									H
									H
									H
	3819	-52.25	-13	-39.25	-70.87	-63.50	1.44	12.69	V
	5723	-50.85	-13	-37.85	-73.86	-62.42	1.73	13.30	V
	7634	-47.02	-13	-34.02	-72.8	-56.14	2.01	11.13	V
									V
									V
									V
									V

Remark: Spurious emissions within 30-1000MHz were found more than 20dB below limit line.