



FCC/ISED RADIO TEST REPORT

FCC ID : PKRISGM1000
IC : 3229A-M1000
Equipment : M1000
Brand Name : inseego
Model Name : M1000
Marketing Name : 5G MiFi M1000
HVIN : M1000
PMN : 5G MiFi M1000
Applicant : Inseego Corp.
9605 Scranton Road, Suite 300, San Diego, CA 92121
Manufacturer : Inseego Corp.
9605 Scranton Road, Suite 300, San Diego, CA 92121
Standard : 47 CFR Part 2, 27H
ISED RSS-139 Issue 3

The product was received on May 03, 2019 and testing was started from Jun. 12, 2019 and completed on Jul. 02, 2019. We, SPORTON INTERNATIONAL INC. EMC & Wireless Communications Laboratory, would like to declare that the tested sample has been evaluated in accordance with the test procedures given in ANSI / TIA-603-E and has been in compliance with the applicable technical standards.

The report must not be used by the client to claim product certification, approval, or endorsement by TAF or any agency of government.

The test results in this partial report apply exclusively to the tested model / sample. Without written approval of SPORTON INTERNATIONAL INC. EMC & Wireless Communications Laboratory, the test report shall not be reproduced except in full.

Approved by: Jones Tsai

SPORTON INTERNATIONAL INC. EMC & Wireless Communications Laboratory
No. 52, Huaya 1st Rd., Guishan Dist., Taoyuan City, Taiwan (R.O.C.)



Table of Contents

History of this test report.....	3
Summary of Test Result.....	4
1 General Description	5
1.1 Product Feature of Equipment Under Test.....	5
1.2 Modification of EUT	5
1.3 Testing Location	5
1.4 Applicable Standards.....	6
2 Test Configuration of Equipment Under Test	7
2.1 Test Mode.....	7
2.2 Connection Diagram of Test System.....	8
2.3 Support Unit used in test configuration and system	8
2.4 Measurement Results Explanation Example.....	8
3 Conducted Test Items.....	9
3.1 Measuring Instruments	9
3.2 Conducted Output Power and EIRP.....	10
3.3 Peak-to-Average Ratio	11
3.4 Occupied Bandwidth.....	12
3.5 Conducted Band Edge	13
3.6 Conducted Spurious Emission	14
3.7 Frequency Stability	15
4 Radiated Test Items	16
4.1 Measuring Instruments	16
4.2 Radiated Spurious Emission Measurement	17
5 List of Measuring Equipment.....	18
6 Uncertainty of Evaluation.....	20
Appendix A. Test Results of Conducted Test	
Appendix B. Test Results of Radiated Test	
Appendix C. Test Setup Photographs	



History of this test report

Report No.	Version	Description	Issued Date
FG950301-01C	01	Initial issue of report	Jul. 03, 2019



Summary of Test Result

Report Clause	Ref Std. Clause	Ref Std. Clause	Test Items	Result (PASS/FAIL)	Remark
3.2	§2.1046	RSS-Gen 6.12 RSS-139 6.5	Conducted Output Power	Reporting only	-
	§27.50 (d)(4)	RSS-139 6.5 SRSP-513 5.1.2	Equivalent Isotropic Radiated Power (Band 66)	Pass	
3.3	§27.50 (d)(5)	RSS-139 6.5	Peak-to-Average Ratio	Reporting only	-
3.4	§2.1049	RSS-Gen 6.7 RSS-139 3.1	Occupied Bandwidth	Reporting only	-
3.5	§2.1051 §27.53 (h)	§2.1051RSS- 139 6.6	Conducted Band Edge Measurement (Band 66)	Pass	-
3.6	§2.1051 §27.53 (h)	§2.1051RSS- 139 6.6	Conducted Spurious Emission (Band 66)	Pass	-
3.7	§2.1055 §27.54	RSS-Gen 6.11 RSS-139 6.4	Frequency Stability Temperature & Voltage	Pass	-
4.2	§2.1053 §27.53 (h)	§2.1051RSS- 139 6.6	Radiated Spurious Emission (Band 66)	Pass	Under limit 26.11 dB at 5261.000 MHz

Declaration of Conformity:

The test results with all measurement uncertainty excluded are presented in accordance with the regulation limits or requirements declared by manufacturers.

Comments and Explanations:

The declared of product specification for EUT presented in the report are provided by the manufacturer, and the manufacturer takes all the responsibilities for the accuracy of product specification.

Reviewed by: William Chen

Report Producer: Yung Hsu



1 General Description

1.1 Product Feature of Equipment Under Test

The EUT supports UMTS/LTE/NR/WiFi. The details please find the Operating Description.

1.2 Modification of EUT

No modifications are made to the EUT during all test items.

1.3 Testing Location

Test Site	SPORTON INTERNATIONAL INC. EMC & Wireless Communications Laboratory	
Test Site Location	No.52, Huaya 1st Rd., Guishan Dist., Taoyuan City, Taiwan (R.O.C.) TEL: +886-3-327-3456 FAX: +886-3-328-4978	
Test Site No.	Sporton Site No.	
	TH05-HY	
Test Engineer	Chester Chen	
Temperature	23~25°C	
Relative Humidity	51~56%	

Note: The test site complies with ANSI C63.4 2014 requirement.

Test Site	SPORTON INTERNATIONAL INC. EMC & Wireless Communications Laboratory		
Test Site Location	No.58, Huaya 1st Rd., Guishan Dist., Taoyuan City, Taiwan (R.O.C.) TEL: +886-3-327-3456 FAX: +886-3-328-4978		
Test Site No.	Sporton Site No.	ISED Registration No.	
	03CH12-HY	4086B	
Test Engineer	Jack Cheng, Lance Chiang, Chuan Chu		
Temperature	22~26°C		
Relative Humidity	54~60%		

Note: The test site complies with ANSI C63.4 2014 requirement.

FCC Designation No.: TW1190 and TW0007



1.4 Applicable Standards

According to the specifications of the manufacturer, the EUT must comply with the requirements of the following standards:

- ♦ ANSI C63.26-2015
- ♦ ANSI / TIA-603-E
- ♦ 47 CFR Part 2, 27H
- ♦ FCC KDB 971168 D01 Power Meas. License Digital Systems v03r01
- ♦ FCC KDB 412172 D01 Determining ERP and EIRP v01r01
- ♦ ISED RSS-139 Issue 3

Remark: All test items were verified and recorded according to the standards and without any deviation during the test.



2 Test Configuration of Equipment Under Test

2.1 Test Mode

Antenna port conducted and radiated test items listed below are performed according to KDB 971168 D01 Power Meas. License Digital Systems v03r01 with maximum output power.

For LTE Band 66 Uplink 2CA, all the modulation and bandwidth combination are evaluated to determine the worst case 10MHz +10MHz and 20MHz + 20MHz for reporting.

For radiated measurement, pre-scanned in three orthogonal panels, X, Y, Z. The worst cases (Y plane) were recorded in this report.

The device is investigated from 30MHz to 10 times of fundamental signal for radiated spurious emission test under different RB size/offset and modulations in exploratory test. Subsequently, only the worst case emissions are reported.

2.2 Connection Diagram of Test System

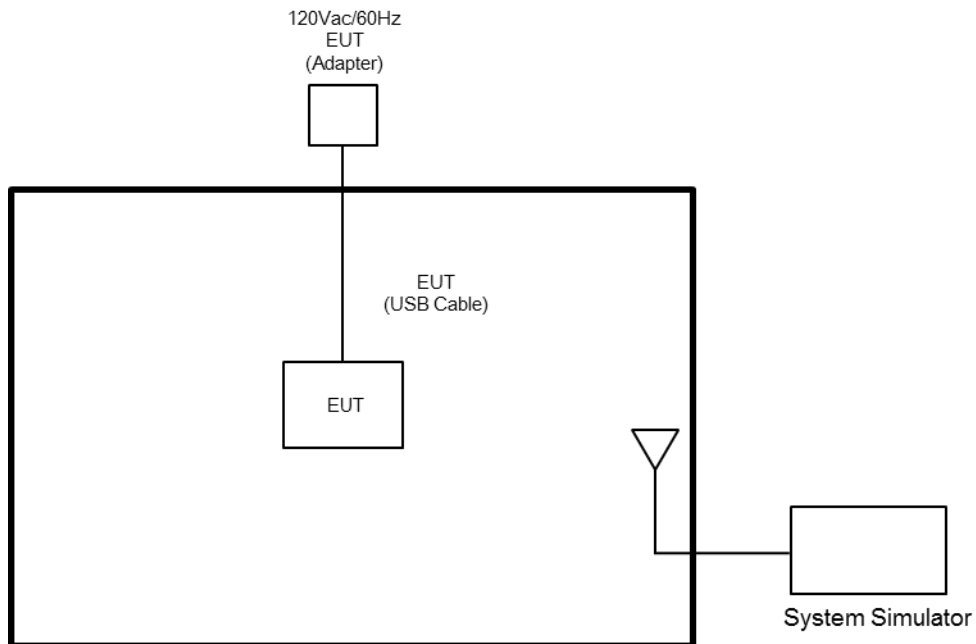

2.3 Support Unit used in test configuration and system

Item	Equipment	Trade Name	Model No.	FCC ID	Data Cable	Power Cord
1.	LTE Base Station	Anritsu	MT8821C	N/A	N/A	Unshielded, 1.8 m

2.4 Measurement Results Explanation Example

For all conducted test items:

The offset level is set in the spectrum analyzer to compensate the RF cable loss and attenuator factor between EUT conducted output port and spectrum analyzer. With the offset compensation, the spectrum analyzer reading level is exactly the EUT RF output level.

The spectrum analyzer offset is derived from RF cable loss and attenuator factor.

Offset = RF cable loss + attenuator factor.

Following shows an offset computation example with cable loss 4.2 dB and 10dB attenuator.

Example :

$$\begin{aligned} \text{Offset(dB)} &= \text{RF cable loss(dB)} + \text{attenuator factor(dB)}. \\ &= 4.2 + 10 = 14.2 \text{ (dB)} \end{aligned}$$

3 Conducted Test Items

3.1 Measuring Instruments

See list of measuring instruments of this test report.

3.1.1 Test Setup

3.1.2 Conducted Output Power

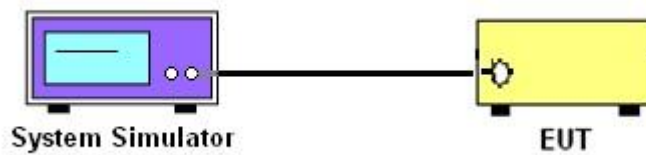

3.1.3 Peak-to-Average Ratio, Occupied Bandwidth ,Conducted Band-Edge and Conducted Spurious Emission

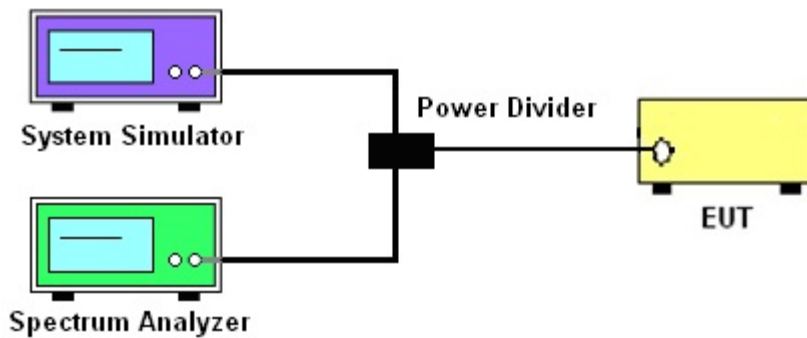

3.1.4 Frequency Stability

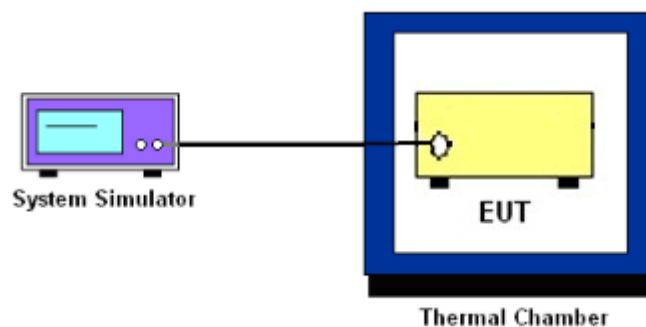

3.1.5 Test Result of Conducted Test

Please refer to Appendix A.



3.2 Conducted Output Power and EIRP

3.2.1 Description of the Conducted Output Power Measurement and EIRP Measurement

A system simulator was used to establish communication with the EUT. Its parameters were set to force the EUT transmitting at maximum output power. The measured power in the radio frequency on the transmitter output terminals shall be reported.

The EIRP of mobile transmitters must not exceed 1 Watts for LTE Band 66.

According to KDB 412172 D01 Power Approach,

$EIRP = P_T + G_T - L_C$, $ERP = EIRP - 2.15$, where

P_T = transmitter output power in dBm

G_T = gain of the transmitting antenna in dBi

L_C = signal attenuation in the connecting cable between the transmitter and antenna in dB

3.2.2 Test Procedures

1. The transmitter output port was connected to the system simulator.
2. Set EUT at maximum power through the system simulator.
3. Select lowest, middle, and highest channels for each band and different modulation.
4. Measure and record the power level from the system simulator.



3.3 Peak-to-Average Ratio

3.3.1 Description of the PAR Measurement

Power Complementary Cumulative Distribution Function (CCDF) curves provide a means for characterizing the power peaks of a digitally modulated signal on a statistical basis. A CCDF curve depicts the probability of the peak signal amplitude exceeding the average power level. Most contemporary measurement instrumentation include the capability to produce CCDF curves for an input signal provided that the instrument's resolution bandwidth can be set wide enough to accommodate the entire input signal bandwidth. In measuring transmissions in this band using an average power technique, the peak-to-average ratio (PAR) of the transmission may not exceed 13 dB.

3.3.2 Test Procedures

The testing follows ANSI C63.26-2015 Section 5.2.6

1. The EUT was connected to spectrum and system simulator via a power divider.
2. Set the CCDF (Complementary Cumulative Distribution Function) option in spectrum analyzer.
3. The highest RF powers were measured and recorded the maximum PAPR level associated with a probability of 0.1 %.
4. Record the deviation as Peak to Average Ratio.



3.4 Occupied Bandwidth

3.4.1 Description of Occupied Bandwidth Measurement

The occupied bandwidth is the width of a frequency band such that, below the lower and above the upper frequency limits, the mean powers emitted are each equal to a specified percentage 0.5% of the total mean transmitted power.

The 26 dB emission bandwidth is defined as the frequency range between two points, one above and one below the carrier frequency, at which the spectral density of the emission is attenuated 26 dB below the maximum in-band spectral density of the modulated signal. Spectral density (power per unit bandwidth) is to be measured with a detector of resolution bandwidth equal to approximately 1.0% of the emission bandwidth.

3.4.2 Test Procedures

The testing follows ANSI C63.26-2015 Section 5.4.3 (26dB) and Section 5.4.4 (99OB)

1. The EUT was connected to spectrum analyzer and system simulator via a power divider.
2. The spectrum analyzer center frequency is set to the nominal EUT channel center frequency. The span range for the spectrum analyzer shall be between two and five times the anticipated OBW.
3. The nominal resolution bandwidth (RBW) shall be in the range of 1 to 5 % of the anticipated OBW, and the VBW shall be at least 3 times the RBW.
4. Set the detection mode to peak, and the trace mode to max hold.
5. Determine the reference value: Set the EUT to transmit a modulated signal. Allow the trace to stabilize. Set the spectrum analyzer marker to the highest level of the displayed trace.
(this is the reference value)
6. Determine the “-26 dB down amplitude” as equal to (Reference Value – X).
7. Place two markers, one at the lowest and the other at the highest frequency of the envelope of the spectral display such that each marker is at or slightly below the “-X dB down amplitude” determined in step 6. If a marker is below this “-X dB down amplitude” value it shall be placed as close as possible to this value. The OBW is the positive frequency difference between the two markers.
8. Use the 99 % power bandwidth function of the spectrum analyzer and report the measured bandwidth.



3.5 Conducted Band Edge

3.5.1 Description of Conducted Band Edge Measurement

27.53 (h) / RSS-139

For operations in the 1710 – 1755 MHz band, the FCC limit is $43 + 10\log_{10}(P[\text{Watts}])$ dB below the transmitter power $P(\text{Watts})$ in a 1 MHz bandwidth. However, in the 1MHz bands immediately outside and adjacent to the licensee's frequency block, a resolution bandwidth of at least one percent of the emission bandwidth of the fundamental emission of the transmitter may be employed.

3.5.2 Test Procedures

The testing follows FCC KDB 971168 D01 v03r01 Section 6.1.

1. The EUT was connected to spectrum analyzer and system simulator via a power divider.
2. The band edges of low and high channels for the highest RF powers were measured.
3. Set RBW \geq 1% EBW in the 1MHz band immediately outside and adjacent to the band edge.
4. Beyond the 1 MHz band from the band edge, RBW=1MHz was used.
5. Set spectrum analyzer with RMS detector.
6. The RF fundamental frequency should be excluded against the limit line in the operating frequency band.
7. Checked that all the results comply with the emission limit line.

The limit line is derived from $43 + 10\log(P)\text{dB}$ below the transmitter power $P(\text{Watts})$



3.6 Conducted Spurious Emission

3.6.1 Description of Conducted Spurious Emission Measurement

The power of any emission outside of the authorized operating frequency ranges must be lower than the transmitter power (P) by a factor of at least $43 + 10 \log (P)$ dB.

It is measured by means of a calibrated spectrum analyzer and scanned from 30 MHz up to a frequency including its 10th harmonic.

3.6.2 Test Procedures

The testing follows FCC KDB 971168 D01 v03r01 Section 6.1.

1. The EUT was connected to spectrum analyzer and system simulator via a power divider.
2. The RF output of EUT was connected to the spectrum analyzer by RF cable and attenuator.
The path loss was compensated to the results for each measurement.
3. The middle channel for the highest RF power within the transmitting frequency was measured.
4. The conducted spurious emission for the whole frequency range was taken.
5. Make the measurement with the spectrum analyzer's RBW = 1MHz, VBW = 3MHz.
6. Set spectrum analyzer with RMS detector.
7. Taking the record of maximum spurious emission.
8. The RF fundamental frequency should be excluded against the limit line in the operating frequency band.
9. The limit line is derived from $43 + 10\log(P)$ dB below the transmitter power P(Watts)



3.7 Frequency Stability

3.7.1 Description of Frequency Stability Measurement

27.54 / RSS-139

The frequency stability shall be sufficient to ensure that the fundamental emission stays within the authorized frequency block.

3.7.2 Test Procedures for Temperature Variation

The testing follows FCC KDB 971168 D01 v03r01 Section 9.0.

1. The EUT was set up in the thermal chamber and connected with the system simulator.
2. With power OFF, the temperature was decreased to -30°C and the EUT was stabilized before testing. Power was applied and the maximum change in frequency was recorded within one minute.
3. With power OFF, the temperature was raised in 10°C step up to 50°C . The EUT was stabilized at each step for at least half an hour. Power was applied and the maximum frequency change was recorded within one minute.

3.7.3 Test Procedures for Voltage Variation

The testing follows FCC KDB 971168 D01 v03r01 Section 9.0.

1. The EUT was placed in a temperature chamber at $20\pm 5^{\circ}\text{C}$ and connected with the system simulator.
2. The power supply voltage to the EUT was varied from 85% to 115% of the nominal value measured at the input to the EUT.
3. The variation in frequency was measured for the worst case.

4 Radiated Test Items

4.1 Measuring Instruments

See list of measuring instruments of this test report.

4.1.1 Test Setup

For radiated test from 30MHz to 1GHz

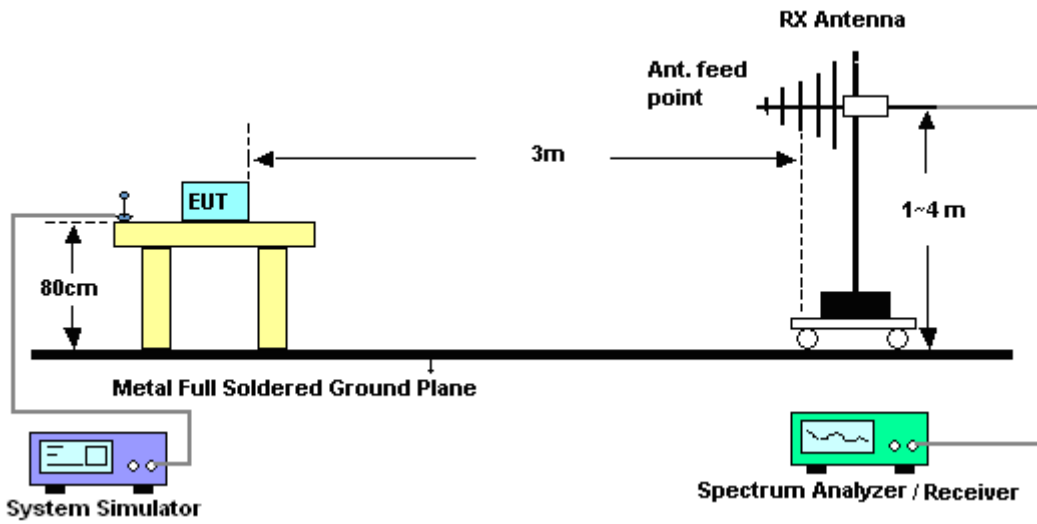

For radiated test above 1GHz

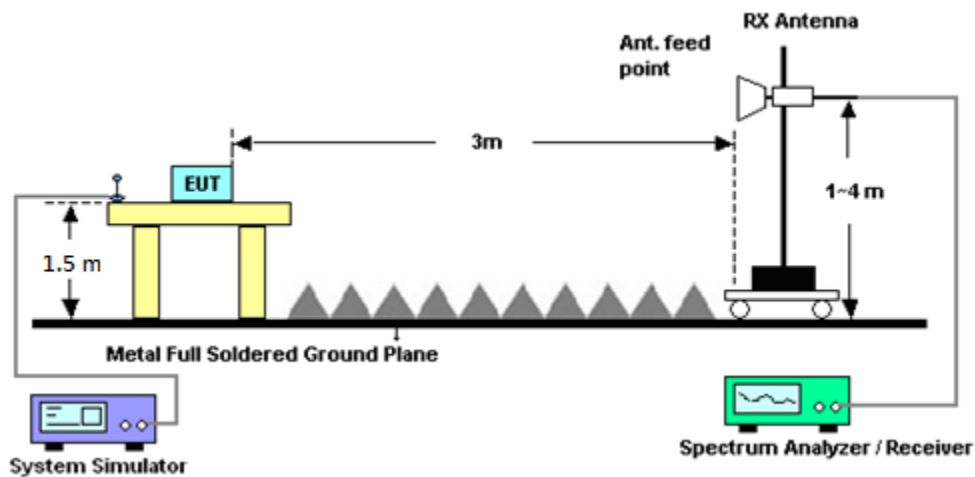

4.1.2 Test Result of Radiated Test

Please refer to Appendix B.



4.2 Radiated Spurious Emission Measurement

4.2.1 Description of Radiated Spurious Emission Measurement

The radiated spurious emission was measured by substitution method according to ANSI / TIA-603-E. The power of any emission outside of the authorized operating frequency ranges must be attenuated below the transmitter power (P) by a factor of at least $43 + 10 \log (P)$ dB.

The spectrum is scanned from 30 MHz up to a frequency including its 10th harmonic.

4.2.2 Test Procedures

The testing follows FCC KDB 971168 D01 v03r01 Section 7 and ANSI / TIA-603-E Section 2.2.12.

1. The EUT was placed on a turntable with 0.8 meter for frequency below 1GHz and 1.5 meter for frequency above 1GHz respectively above ground.
2. The EUT was set 3 meters from the receiving antenna, which was mounted on the antenna tower.
3. The table was rotated 360 degrees to determine the position of the highest spurious emission.
4. The height of the receiving antenna is varied between one meter and four meters to search the maximum spurious emission for both horizontal and vertical polarizations.
5. Make the measurement with the spectrum analyzer's RBW = 1MHz, VBW = 3MHz, taking the record of maximum spurious emission.
6. A horn antenna was substituted in place of the EUT and was driven by a signal generator.
7. Tune the output power of signal generator to the same emission level with EUT maximum spurious emission.
8. Taking the record of output power at antenna port.
9. Repeat step 7 to step 8 for another polarization.
10. The RF fundamental frequency should be excluded against the limit line in the operating frequency band.

The limit line is derived from $43 + 10\log(P)$ dB below the transmitter power P(Watts)



5 List of Measuring Equipment

Instrument	Manufacturer	Model No.	Serial No.	Characteristics	Calibration Date	Test Date	Due Date	Remark
Loop Antenna	Rohde & Schwarz	HFH2-Z2	100488	9 kHz~30 MHz	Jan. 07, 2019	Jun. 13, 2019~ Jun. 14, 2019	Jan. 06, 2020	Radiation (03CH12-HY)
Bilog Antenna	TESEQ	CBL 6111D&00802 N1D01N-06	47020&06	30MHz to 1GHz	Oct. 13, 2018	Jun. 13, 2019~ Jun. 14, 2019	Oct. 12, 2019	Radiation (03CH12-HY)
Horn Antenna	SCHWARZBE CK	BBHA 9120D	9120D-1212	1GHz ~ 18GHz	Oct. 19, 2018	Jun. 13, 2019~ Jun. 14, 2019	Oct. 18, 2019	Radiation (03CH12-HY)
Horn Antenna	SCHWARZBE CK	BBHA 9120D	9120D-1326	1GHz ~ 18GHz	Oct. 30, 2018	Jun. 13, 2019~ Jun. 14, 2019	Oct. 29, 2019	Radiation (03CH12-HY)
SHF-EHF Horn Antenna	SCHWARZBE CK	BBHA 9170	BBHA917058 4	18GHz ~ 40GHz	Dec. 05, 2018	Jun. 13, 2019~ Jun. 14, 2019	Dec. 04, 2019	Radiation (03CH12-HY)
Preamplifier	COM-POWER	PA-103	161075	10MHz~1GHz	Mar. 25, 2019	Jun. 13, 2019~ Jun. 14, 2019	Mar. 24, 2020	Radiation (03CH12-HY)
Preamplifier	Agilent	8449B	3008A02375	1GHz~26.5Ghz	May 28, 2018	Jun. 13, 2019~ Jun. 14, 2019	May 26, 2020	Radiation (03CH12-HY)
Preamplifier	Jet-Power	JPA0118-55-30 3	17100018000 55007	1GHz~18GHz	Apr. 01, 2019	Jun. 13, 2019~ Jun. 14, 2019	Mar. 31, 2020	Radiation (03CH12-HY)
Preamplifier	EMEC	EM18G40G	060715	18GHz ~ 40GHz	Dec. 06, 2018	Jun. 13, 2019~ Jun. 14, 2019	Dec. 05, 2019	Radiation (03CH12-HY)
EMI Test Receiver	Rohde & Schwarz	ESU26	100390	20Hz~26.5GHz	Dec. 26, 2018	Jun. 13, 2019~ Jun. 14, 2019	Dec. 25, 2019	Radiation (03CH12-HY)
Spectrum Analyzer	Keysight	N9010A	MY54200486	10Hz~44GHz	Dec. 19, 2018	Jun. 13, 2019~ Jun. 14, 2019	Dec. 18, 2019	Radiation (03CH12-HY)
Hygrometer	TECPEL	DTM-303B	TP161243	N/A	May 11, 2019	Jun. 13, 2019~ Jun. 14, 2019	May 10, 2020	Radiation (03CH12-HY)
Signal Generator	Rohde & Schwarz	SMB100A	175727	100kHz~40GHz	Dec. 23, 2018	Jun. 13, 2019~ Jun. 14, 2019	Dec. 23, 2019	Radiation (03CH12-HY)
Base Station	Anritsu	MT8821C	6201432816	LTE-3CC DLCA,2CC ULCA	May 05, 2019	Jun. 13, 2019~ Jun. 14, 2019	May 04, 2020	Radiation (03CH12-HY)
Filter	Wainwright	WLK4-1000-15 30-6000-40SS	SN11	1 GHz Lowpass	Sep. 16, 2018	Jun. 13, 2019~ Jun. 14, 2019	Sep. 15, 2019	Radiation (03CH12-HY)
Filter	Wainwright	WHKX12-1080 -1200-1500-60 SS	SN2	1.2G High Pass	Sep. 16, 2018	Jun. 13, 2019~ Jun. 14, 2019	Sep. 15, 2019	Radiation (03CH12-HY)
Filter	Wainwright	WHKX12-2700 -3000-18000-6 0ST	SN2	3GHz High Pass	Mar. 20, 2019	Jun. 13, 2019~ Jun. 14, 2019	Mar. 19, 2020	Radiation (03CH12-HY)
Notch Filter	EWT	EWT-14-0041	D1	DCS 1800	Nov. 01, 2018	Jun. 13, 2019~ Jun. 14, 2019	Oct. 31, 2019	Radiation (03CH12-HY)
Notch Filter	Wainwright	WRCT698/798 -10/40 8SSK	SN1	AWS Band	Nov. 01, 2018	Jun. 13, 2019~ Jun. 14, 2019	Oct. 31, 2019	Radiation (03CH12-HY)
Notch Filter	Wainwright	WRCG824/849 -40/8SS	SN35	CDMA 850	Nov. 07, 2018	Jun. 13, 2019~ Jun. 14, 2019	Nov. 06, 2019	Radiation (03CH12-HY)
RF Cable	HUBER + SUHNER	SUCOFLEX 126E	0058/126E	30M-18G	Mar. 13, 2019	Jun. 13, 2019~ Jun. 14, 2019	Mar. 12, 2020	Radiation (03CH12-HY)
RF Cable	HUBER + SUHNER	SUCOFLEX 102	505134/2	30M~40GHz	Oct. 16, 2018	Jun. 13, 2019~ Jun. 14, 2019	Oct. 15, 2019	Radiation (03CH12-HY)
RF Cable	HUBER + SUHNER	SUCOFLEX 102	800740/2	30M~40GHz	Oct. 16, 2018	Jun. 13, 2019~ Jun. 14, 2019	Oct. 15, 2019	Radiation (03CH12-HY)
Controller	EMEC	EM1000	N/A	Control Turn table & Ant Mast	N/A	Jun. 13, 2019~ Jun. 14, 2019	N/A	Radiation (03CH12-HY)
Antenna Mast	EMEC	AM-BS-4500-B	N/A	1m~4m	N/A	Jun. 13, 2019~ Jun. 14, 2019	N/A	Radiation (03CH12-HY)
Turn Table	EMEC	TT2000	N/A	0~360 Degree	N/A	Jun. 13, 2019~ Jun. 14, 2019	N/A	Radiation (03CH12-HY)
Software	Audix	E3 6.2009-8-24	RK-000989	N/A	N/A	Jun. 13, 2019~ Jun. 14, 2019	N/A	Radiation (03CH12-HY)



Instrument	Manufacturer	Model No.	Serial No.	Characteristics	Calibration Date	Test Date	Due Date	Remark
Base Station	Anritsu	MT8821C	6201664755	/LTE-3CC DLCA,2CC ULCA	Mar. 03, 2019	Jun. 12, 2019~ Jul. 02, 2019	Mar. 02, 2020	Conducted (TH05-HY)
Spectrum Analyzer	Rohde & Schwarz	FSV40	101397	10Hz~40GHz	Nov. 13, 2018	Jun. 12, 2019~ Jul. 02, 2019	Nov. 12, 2019	Conducted (TH05-HY)
Coupler	Warison	20dB 25W SMA Directional Coupler	#A	1-18GHz	Jan. 14, 2019	Jun. 12, 2019~ Jul. 02, 2019	Jan. 13, 2020	Conducted (TH05-HY)



6 Uncertainty of Evaluation

Uncertainty of Radiated Emission Measurement (30 MHz ~ 1000 MHz)

Measuring Uncertainty for a Level of Confidence of 95% ($U = 2Uc(y)$)	3.36
---	------

Uncertainty of Radiated Emission Measurement (1 GHz ~ 18 GHz)

Measuring Uncertainty for a Level of Confidence of 95% ($U = 2Uc(y)$)	3.70
---	------

Uncertainty of Radiated Emission Measurement (18 GHz ~ 40 GHz)

Measuring Uncertainty for a Level of Confidence of 95% ($U = 2Uc(y)$)	3.98
---	------



LTE Band 66

Conducted Output Power

LTE Band 66_CA Maximum Average Power [dBm]								
BW [MHz]	PCC		SCC		Mod	Lowest	Middle	Highest
	RB Size	RB Offset	RB Size	RB Offset				
20+20	100	0	100	0	QPSK	19.42	18.88	19.45
20+20	1	0	1	99		13.13	13.36	13.44
20+20	1	99	1	0		21.64	21.49	21.99
20+20	100	0	100	0	16-QAM	18.69	18.06	18.24
20+20	1	0	1	99		13.08	13.21	13.62
20+20	1	99	1	0		20.61	20.93	20.84
20+20	100	0	100	0	64-QAM	18.67	18.21	18.09
20+20	1	0	1	99		13.01	13.29	13.34
20+20	1	99	1	0		18.58	18.89	18.88

LTE Band 66_CA Maximum Average Power [dBm]								
BW [MHz]	PCC		SCC		Mod	Lowest	Middle	Highest
	RB Size	RB Offset	RB Size	RB Offset				
20+15	100	0	75	0	QPSK	19.89	20.59	20.11
20+15	1	0	1	74		13.19	13.53	13.58
20+15	1	99	1	0		21.98	22.15	22.36
20+15	100	0	75	0	16-QAM	18.86	19.56	20.08
20+15	1	0	1	74		13.45	13.95	14.09
20+15	1	99	1	0		20.81	21.23	21.53
20+15	100	0	75	0	64-QAM	18.64	19.54	20.06
20+15	1	0	1	74		13.35	13.71	13.98
20+15	1	99	1	0		18.92	19.36	19.34



LTE Band 66_CA Maximum Average Power [dBm]								
BW [MHz]	PCC		SCC		Mod	Lowest	Middle	Highest
	RB Size	RB Offset	RB Size	RB Offset				
15+20	75	0	100	0	QPSK	19.67	20.68	20.10
15+20	1	0	1	99		13.46	13.58	13.61
15+20	1	74	1	0		22.07	22.19	22.18
15+20	75	0	100	0	16-QAM	19.64	19.21	20.08
15+20	1	0	1	99		13.85	13.98	14.16
15+20	1	74	1	0		21.19	21.32	21.32
15+20	75	0	100	0	64-QAM	19.77	18.97	19.91
15+20	1	0	1	99		13.68	13.95	13.94
15+20	1	74	1	0		18.65	19.33	19.36

LTE Band 66_CA Maximum Average Power [dBm]								
BW [MHz]	PCC		SCC		Mod	Lowest	Middle	Highest
	RB Size	RB Offset	RB Size	RB Offset				
20+10	100	0	50	0	QPSK	20.08	19.87	20.19
20+10	1	0	1	49		12.71	13.76	13.74
20+10	1	99	1	0		22.06	22.28	22.67
20+10	100	0	50	0	16-QAM	19.18	19.12	19.75
20+10	1	0	1	49		13.28	14.13	14.12
20+10	1	99	1	0		21.21	21.42	21.68
20+10	100	0	50	0	64-QAM	19.21	18.85	19.79
20+10	1	0	1	49		13.21	13.79	13.84
20+10	1	99	1	0		19.08	19.34	19.55



LTE Band 66_CA Maximum Average Power [dBm]								
BW [MHz]	PCC		SCC		Mod	Lowest	Middle	Highest
	RB Size	RB Offset	RB Size	RB Offset				
10+20	50	0	100	0	QPSK	20.65	20.27	20.37
10+20	1	0	1	99		12.54	13.26	13.61
10+20	1	49	1	0		21.99	22.06	22.13
10+20	50	0	100	0	16-QAM	19.85	20.42	19.68
10+20	1	0	1	99		13.01	13.33	14.16
10+20	1	49	1	0		21.21	21.22	21.36
10+20	50	0	100	0	64-QAM	19.79	19.49	19.73
10+20	1	0	1	99		12.67	13.19	13.95
10+20	1	49	1	0		18.97	19.16	19.43

LTE Band 66_CA Maximum Average Power [dBm]								
BW [MHz]	PCC		SCC		Mod	Lowest	Middle	Highest
	RB Size	RB Offset	RB Size	RB Offset				
20+5	100	0	25	0	QPSK	20.01	20.14	20.01
20+5	1	0	1	24		12.92	13.45	13.23
20+5	1	99	1	0		21.73	22.91	21.56
20+5	100	0	25	0	16-QAM	18.74	19.15	19.04
20+5	1	0	1	24		13.26	13.96	13.46
20+5	1	99	1	0		21.22	22.31	20.86
20+5	100	0	25	0	64-QAM	18.95	19.13	19.27
20+5	1	0	1	24		13.13	13.93	13.33
20+5	1	99	1	0		19.56	20.71	19.39



LTE Band 66_CA Maximum Average Power [dBm]								
BW [MHz]	PCC		SCC		Mod	Lowest	Middle	Highest
	RB Size	RB Offset	RB Size	RB Offset				
5+20	25	0	100	0	QPSK	20.17	20.05	20.26
5+20	1	0	1	99		12.78	13.52	14.66
5+20	1	24	1	0		22.00	22.05	22.47
5+20	25	0	100	0	16-QAM	19.99	19.66	19.77
5+20	1	0	1	99		13.02	13.31	14.33
5+20	1	24	1	0		21.03	21.19	21.63
5+20	25	0	100	0	64-QAM	20.20	19.53	19.85
5+20	1	0	1	99		12.89	13.86	14.49
5+20	1	24	1	0		19.05	19.14	19.59

LTE Band 66_CA Maximum Average Power [dBm]								
BW [MHz]	PCC		SCC		Mod	Lowest	Middle	Highest
	RB Size	RB Offset	RB Size	RB Offset				
15+10	75	0	50	0	QPSK	21.06	20.26	20.02
15+10	1	0	1	49		12.87	13.76	13.76
15+10	1	74	1	0		22.12	22.16	22.38
15+10	75	0	50	0	16-QAM	19.22	19.37	20.61
15+10	1	0	1	49		13.42	13.43	14.02
15+10	1	74	1	0		21.18	21.42	21.44
15+10	75	0	50	0	64-QAM	18.88	18.89	19.01
15+10	1	0	1	49		13.19	13.86	14.04
15+10	1	74	1	0		19.12	19.47	19.56



LTE Band 66_CA Maximum Average Power [dBm]								
BW [MHz]	PCC		SCC		Mod	Lowest	Middle	Highest
	RB Size	RB Offset	RB Size	RB Offset				
10+15	50	0	75	0	QPSK	20.89	20.82	21.26
10+15	1	0	1	74		21.92	22.37	22.54
10+15	1	49	1	0		12.70	14.01	14.78
10+15	50	0	75	0	16-QAM	20.22	19.55	20.21
10+15	1	0	1	74		21.02	21.51	21.68
10+15	1	49	1	0		13.24	14.14	14.89
10+15	50	0	75	0	64-QAM	20.13	19.67	20.28
10+15	1	0	1	74		19.06	19.54	19.71
10+15	1	49	1	0		13.18	13.85	14.67

LTE Band 66_CA Maximum Average Power [dBm]								
BW [MHz]	PCC		SCC		Mod	Lowest	Middle	Highest
	RB Size	RB Offset	RB Size	RB Offset				
15+15	75	0	75	0	QPSK	19.36	19.54	19.58
15+15	1	0	1	74		12.82	13.56	13.54
15+15	1	74	1	0		22.08	22.14	22.18
15+15	75	0	75	0	16-QAM	19.28	18.06	18.55
15+15	1	0	1	74		13.49	13.86	13.99
15+15	1	74	1	0		21.15	21.46	21.64
15+15	75	0	75	0	64-QAM	18.23	18.01	18.53
15+15	1	0	1	74		12.95	13.85	14.05
15+15	1	74	1	0		19.04	19.51	19.38



LTE Band 66_CA Maximum Average Power [dBm]								
BW [MHz]	PCC		SCC		Mod	Lowest	Middle	Highest
	RB Size	RB Offset	RB Size	RB Offset				
10+10	50	0	50	0	QPSK	19.54	19.73	19.82
10+10	1	0	1	49		10.97	11.27	11.08
10+10	1	49	1	0		21.76	21.74	22.02
10+10	50	0	50	0	16-QAM	18.54	18.62	18.77
10+10	1	0	1	49		11.08	11.32	11.58
10+10	1	49	1	0		20.58	21.07	21.04
10+10	50	0	50	0	64-QAM	18.38	18.82	18.84
10+10	1	0	1	49		11.01	11.23	11.56
10+10	1	49	1	0		18.59	18.72	18.72

LTE Band 66_CA Maximum Average Power [dBm]								
BW [MHz]	PCC		SCC		Mod	Lowest	Middle	Highest
	RB Size	RB Offset	RB Size	RB Offset				
15+5	75	0	25	0	QPSK	19.40	19.69	20.14
15+5	1	0	1	24		11.03	10.74	11.36
15+5	1	74	1	0		21.45	22.67	21.97
15+5	75	0	25	0	16-QAM	18.40	18.61	19.25
15+5	1	0	1	24		11.29	11.31	11.29
15+5	1	74	1	0		20.45	22.32	21.46
15+5	75	0	25	0	64-QAM	18.20	18.71	19.19
15+5	1	0	1	24		11.16	11.22	11.35
15+5	1	74	1	0		18.65	20.42	20.19



LTE Band 66_CA Maximum Average Power [dBm]								
BW [MHz]	PCC		SCC		Mod	Lowest	Middle	Highest
	RB Size	RB Offset	RB Size	RB Offset				
5+15	25	0	75	0	QPSK	19.35	19.74	19.96
5+15	1	0	1	74		10.82	11.65	11.65
5+15	1	24	1	0		21.42	21.76	22.28
5+15	25	0	75	0	16-QAM	18.36	18.69	19.06
5+15	1	0	1	74		11.42	11.63	11.55
5+15	1	24	1	0		20.56	21.11	21.29
5+15	25	0	75	0	64-QAM	18.35	18.77	19.1
5+15	1	0	1	74		11.21	11.71	11.62
5+15	1	24	1	0		18.42	18.94	19.25

LTE Band 66_CA Maximum Average Power [dBm]								
BW [MHz]	PCC		SCC		Mod	Lowest	Middle	Highest
	RB Size	RB Offset	RB Size	RB Offset				
10+5	50	0	25	0	QPSK	21.62	22.01	22.16
10+5	1	0	1	24		13.88	14.16	13.81
10+5	1	49	1	0		23.56	23.89	24.14
10+5	50	0	25	0	16-QAM	20.61	21.06	21.07
10+5	1	0	1	24		13.92	14.21	13.95
10+5	1	49	1	0		22.85	23.03	22.85
10+5	50	0	25	0	64-QAM	20.58	20.97	21.06
10+5	1	0	1	24		13.74	14.12	13.77
10+5	1	49	1	0		20.65	21.19	21.23



LTE Band 66_CA Maximum Average Power [dBm]								
BW [MHz]	PCC		SCC		Mod	Lowest	Middle	Highest
	RB Size	RB Offset	RB Size	RB Offset				
5+10	25	0	50	0	QPSK	21.65	22.01	22.11
5+10	1	0	1	49		13.88	14.56	14.36
5+10	1	24	1	0		23.74	23.98	24.06
5+10	25	0	50	0	16-QAM	20.69	20.91	21.12
5+10	1	0	1	49		13.92	14.33	14.33
5+10	1	24	1	0		22.86	23.17	23.36
5+10	25	0	50	0	64-QAM	20.72	20.97	20.93
5+10	1	0	1	49		13.81	14.28	14.25
5+10	1	24	1	0		20.67	20.83	21.72

LTE Band 66_CA Maximum Average Power [dBm]								
BW [MHz]	PCC		SCC		Mod	Lowest	Middle	Highest
	RB Size	RB Offset	RB Size	RB Offset				
5+5	25	0	25	0	QPSK	21.41	21.94	22.12
5+5	1	0	1	24		13.51	13.62	13.99
5+5	1	24	1	0		23.46	23.81	23.90
5+5	25	0	25	0	16-QAM	20.33	20.75	20.81
5+5	1	0	1	24		13.53	13.75	14.26
5+5	1	24	1	0		22.65	22.86	23.07
5+5	25	0	25	0	64-QAM	20.49	21.03	21.01
5+5	1	0	1	24		13.68	13.63	14.16
5+5	1	24	1	0		20.10	20.91	20.99



LTE Band 66

26dB Bandwidth

Mode	LTE Band 66C : 26dB BW(MHz)		
BW	20MHz+20MHz		
	QPSK	16QAM	64QAM
Lowest CH	72.24	71.76	67.13
Middle CH	69.29	67.69	69.61
Highest CH	66.97	68.09	69.21



LTE Band 66C

QPSK

16QAM

Lowest Channel / 20MHz+20MHz

Lowest Channel / 20MHz+20MHz

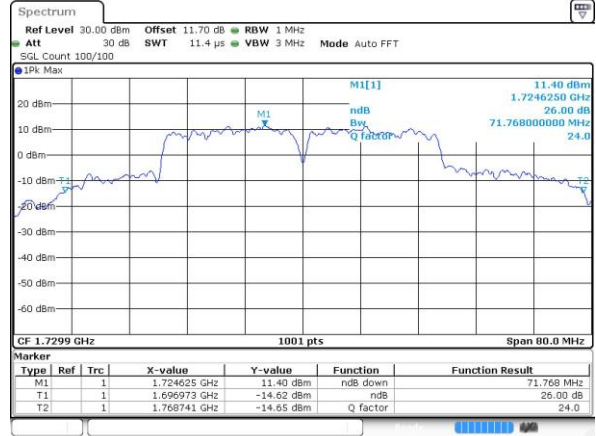
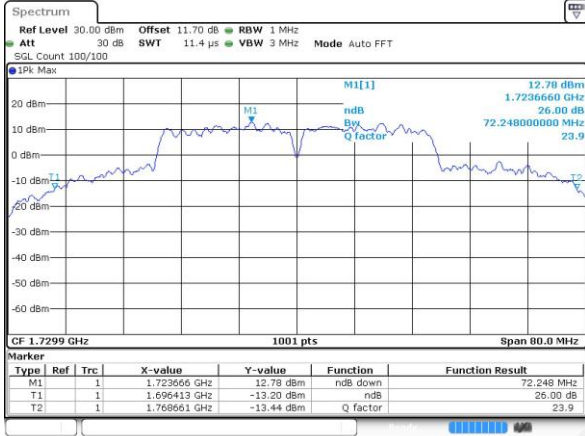

Date: 12 JUN 2019 01:11:16

Date: 12 JUN 2019 01:10:49

Middle Channel / 20MHz+20MHz

Middle Channel / 20MHz+20MHz

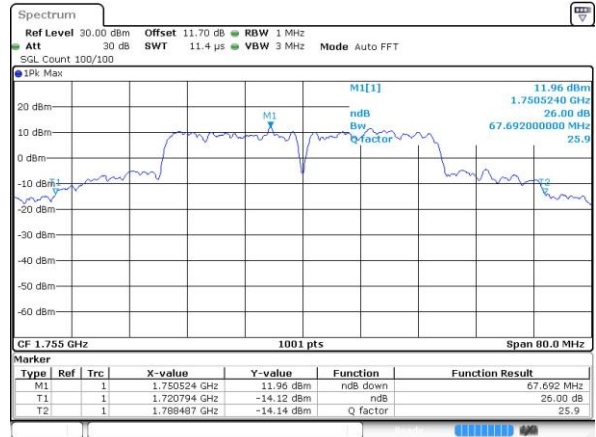
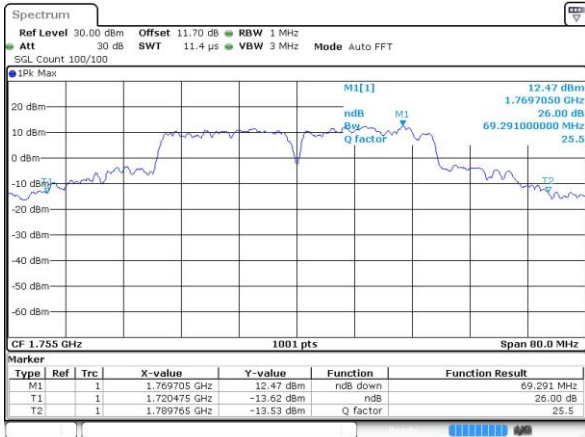

Date: 12 JUN 2019 03:35:22

Date: 12 JUN 2019 02:33:45

Highest Channel / 20MHz+20MHz

Highest Channel / 20MHz+20MHz

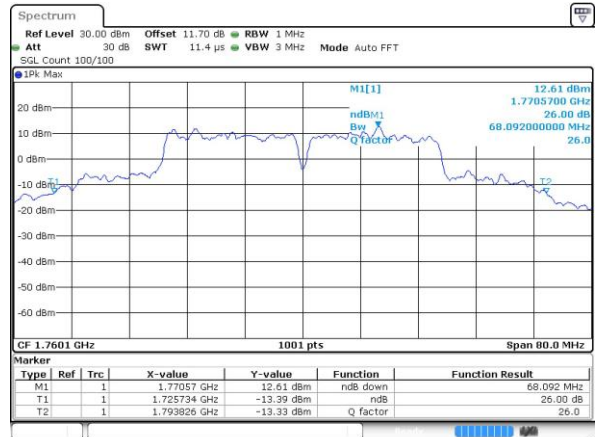
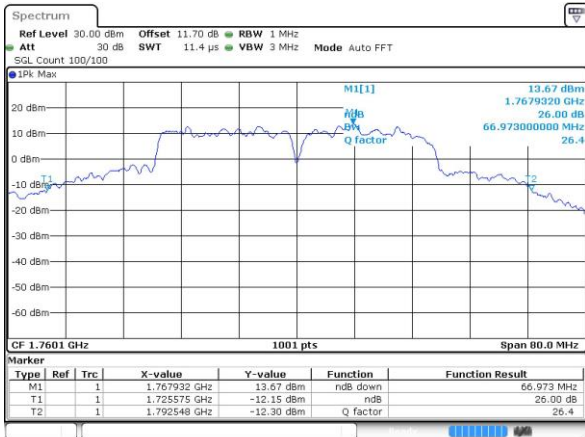

Date: 12 JUN 2019 02:52:47

Date: 12 JUN 2019 02:53:36



LTE Band 66C

64QAM

Lowest Channel / 20MHz+20MHz

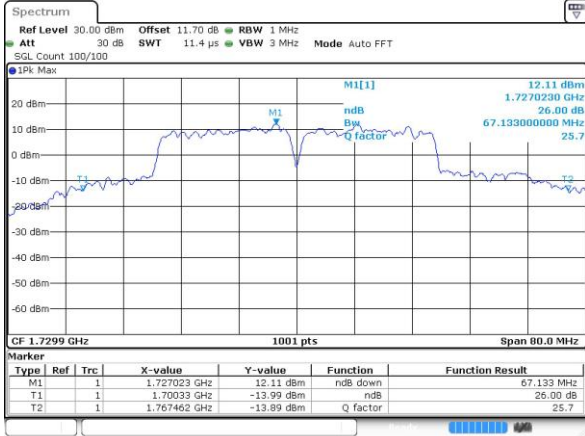

Date: 12 JUN 2019 01:10:24

Middle Channel / 20MHz+20MHz



Date: 12 JUN 2019 03:36:15

Highest Channel / 20MHz+20MHz

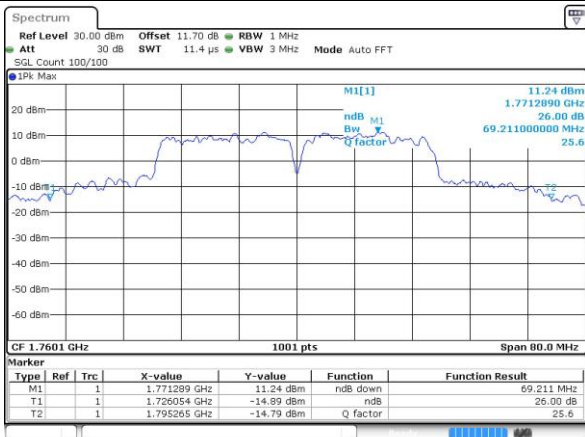

Date: 12 JUN 2019 02:54:24



Occupied Bandwidth

Mode	LTE Band 66C : 99%OBW(MHz)		
BW	20MHz+20MHz		
	QPSK	16QAM	64QAM
Lowest CH	44.51	43.23	45.87
Middle CH	49.39	49.07	48.27
Highest CH	48.51	50.66	47.31



LTE Band 66C

QPSK

16QAM

Lowest Channel / 20MHz+20MHz

Lowest Channel / 20MHz+20MHz

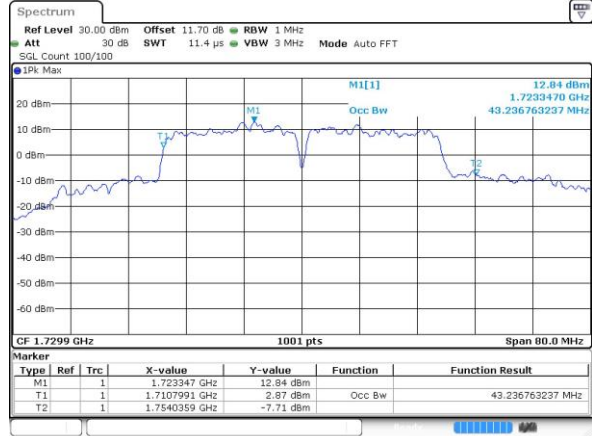
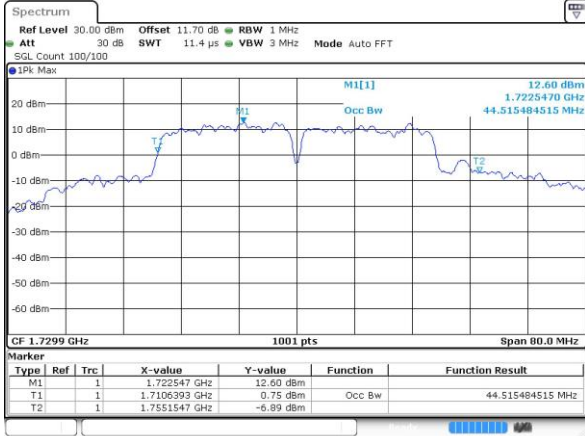

Date: 12 JUN 2019 01:09:11

Date: 12 JUN 2019 01:09:35

Middle Channel / 20MHz+20MHz

Middle Channel / 20MHz+20MHz

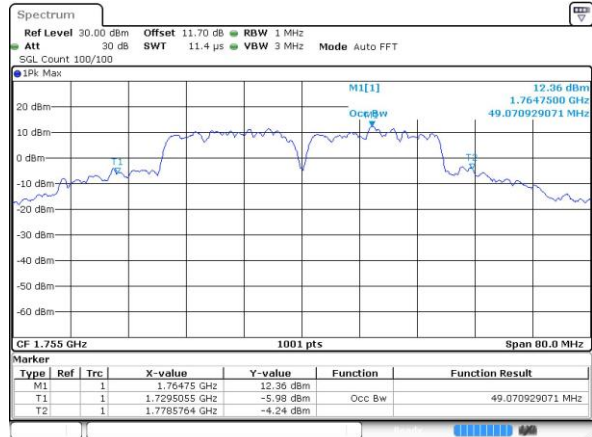
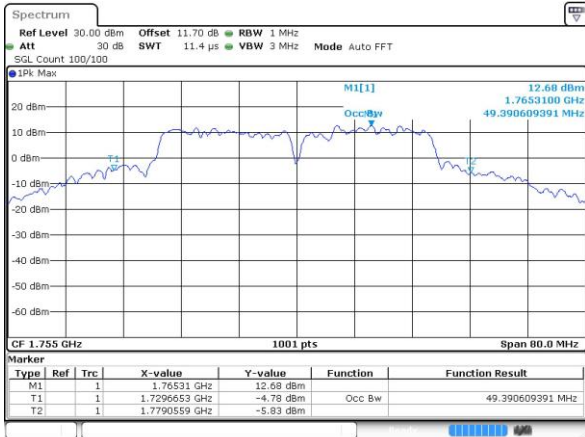

Date: 12 JUN 2019 02:30:28

Date: 12 JUN 2019 02:31:17

Highest Channel / 20MHz+20MHz

Highest Channel / 20MHz+20MHz

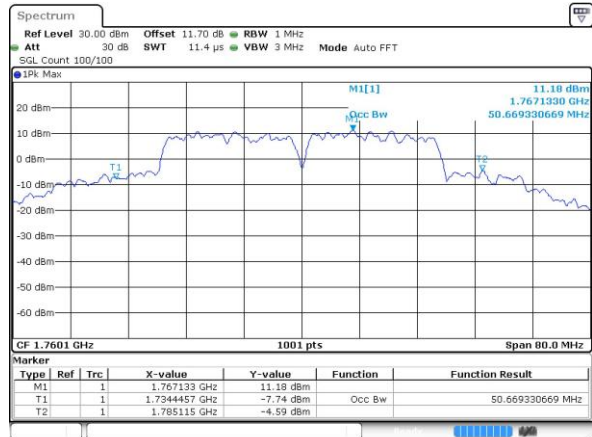
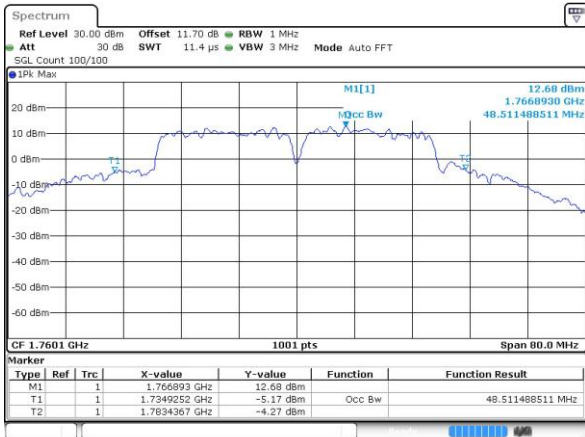

Date: 12 JUN 2019 02:52:00

Date: 12 JUN 2019 02:51:11



LTE Band 66C

64QAM

Lowest Channel / 20MHz+20MHz

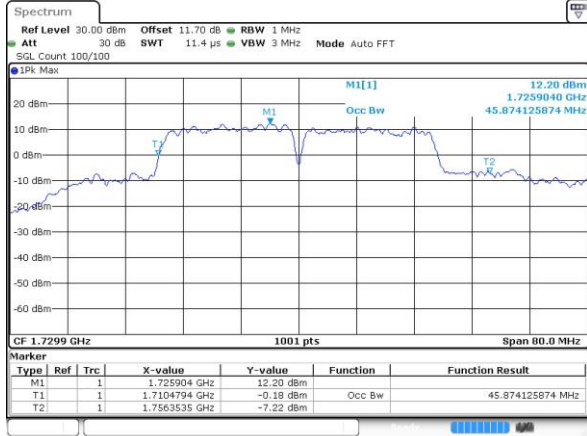

Date: 12 JUN 2019 01:27:12

Middle Channel / 20MHz+20MHz

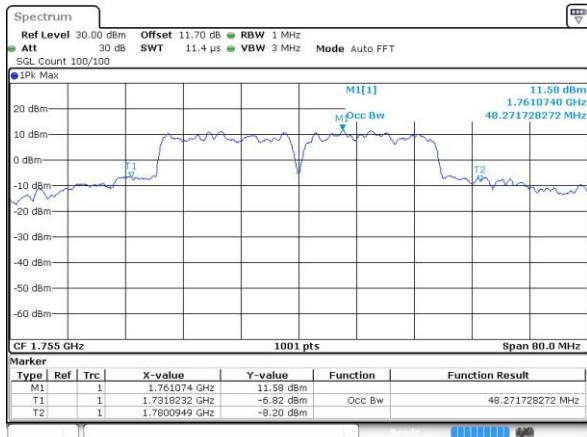

Date: 12 JUN 2019 02:32:06

Highest Channel / 20MHz+20MHz

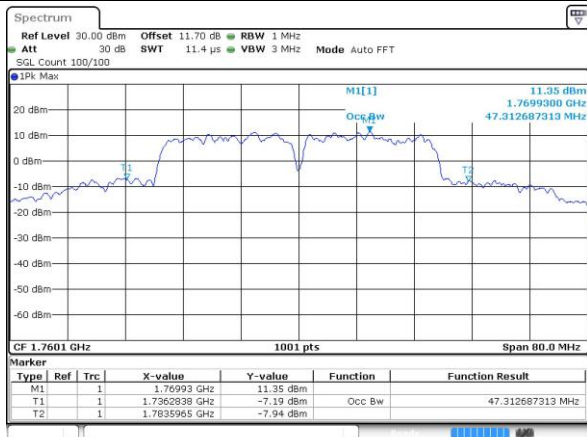

Date: 12 JUN 2019 02:50:23



Conducted Band Edge

LTE Band 66C / 20MHz+20MHz

QPSK

Lowest Band Edge / 1RB0 and 1RB99

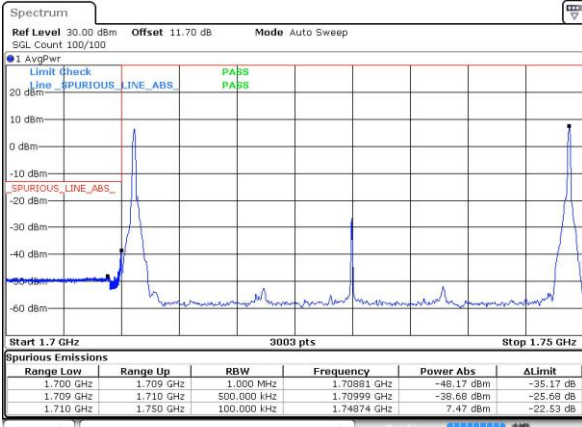

Date: 12 JUN 2019 01:15:59

Highest Band Edge / 1RB0 and 1RB99

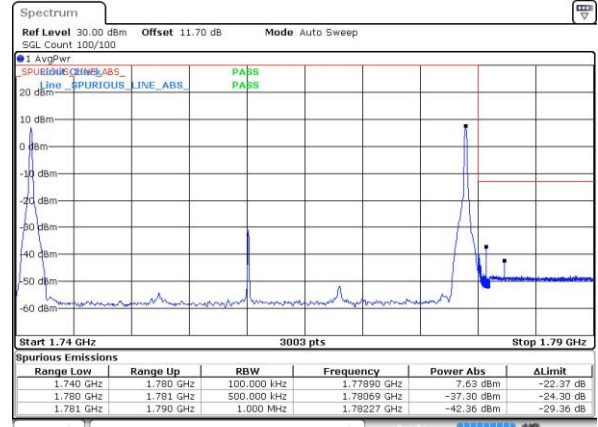

Date: 12 JUN 2019 02:59:14

Lowest Band Edge / 1RB99 and 1RB0

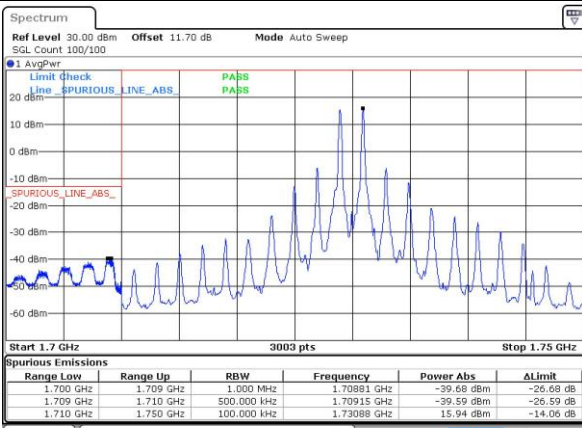

Date: 12 JUN 2019 01:16:46

Highest Band Edge / 1RB99 and 1RB0

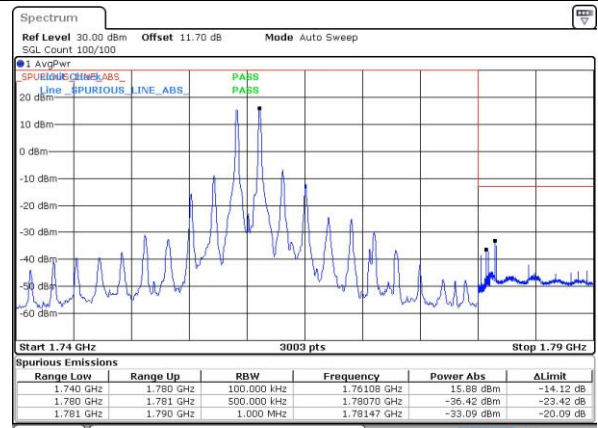

Date: 12 JUN 2019 03:05:16

Lowest Band Edge / Full RB

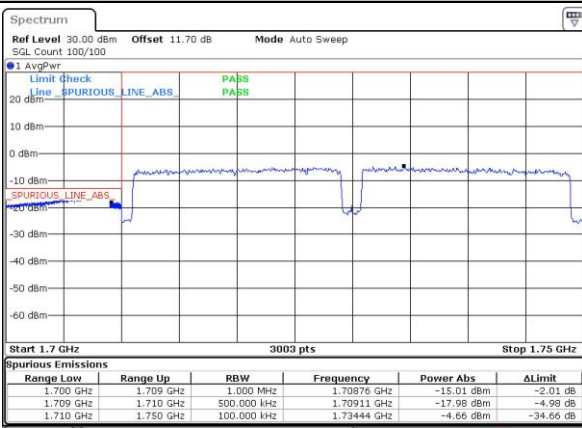

Date: 12 JUN 2019 10:01:21

Highest Band Edge / Full RB

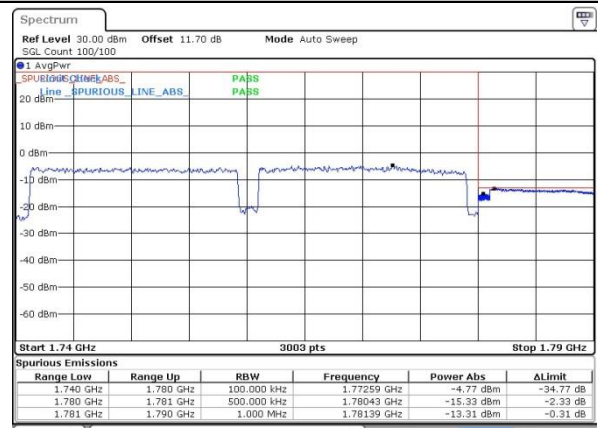

Date: 2 JUL 2019 13:53:26



LTE Band 66C / 20MHz+20MHz

16QAM

Lowest Band Edge / 1RB0 and 1RB9

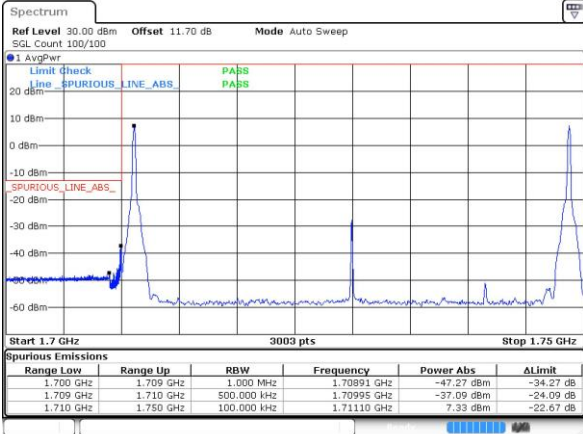

Date: 12 JUN 2019 01:15:12

Highest Band Edge / 1RB0 and 1RB9

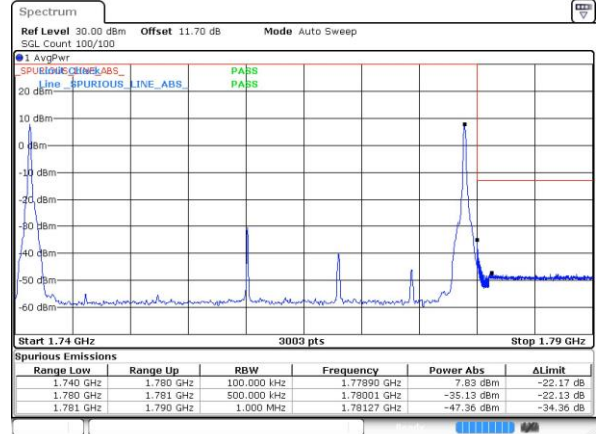

Date: 12 JUN 2019 03:00:27

Lowest Band Edge / 1RB99 and 1RB0

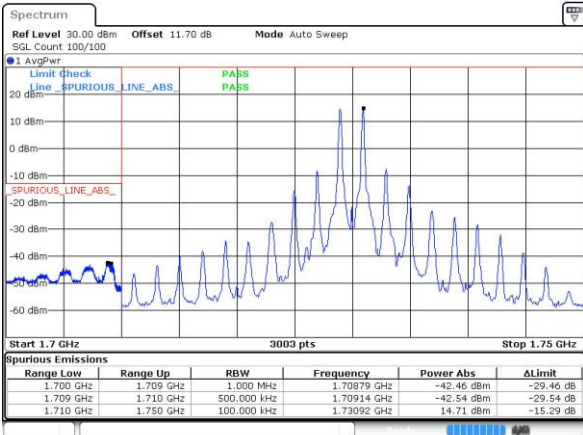

Date: 12 JUN 2019 01:17:33

Highest Band Edge / 1RB99 and 1RB0

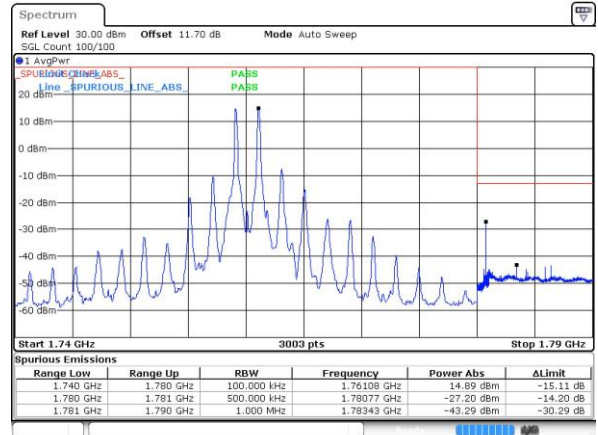

Date: 12 JUN 2019 03:04:03

Lowest Band Edge / Full RB



Date: 12 JUN 2019 10:04:01

Highest Band Edge / Full RB

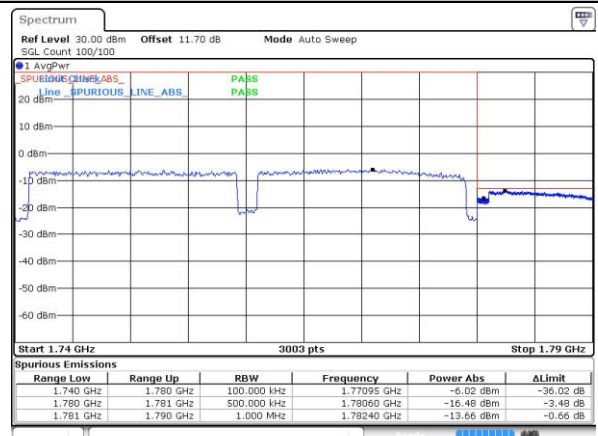

Date: 2 JUL 2019 13:56:13



LTE Band 66C / 20MHz+20MHz

64QAM

Lowest Band Edge / 1RB0 and 1RB9

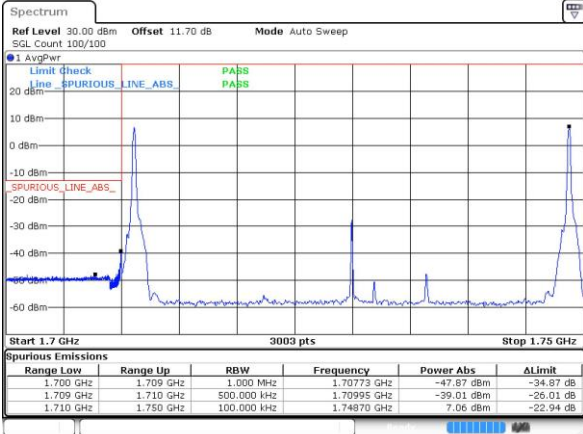

Date: 12 JUN 2019 01:14:25

Highest Band Edge / 1RB0 and 1RB9

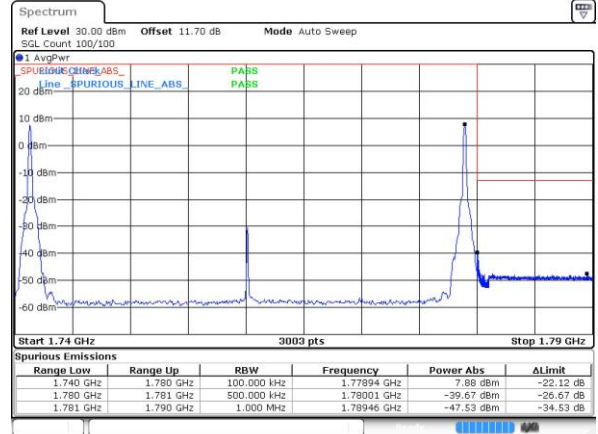

Date: 12 JUN 2019 03:01:39

Lowest Band Edge / 1RB99 and 1RB0

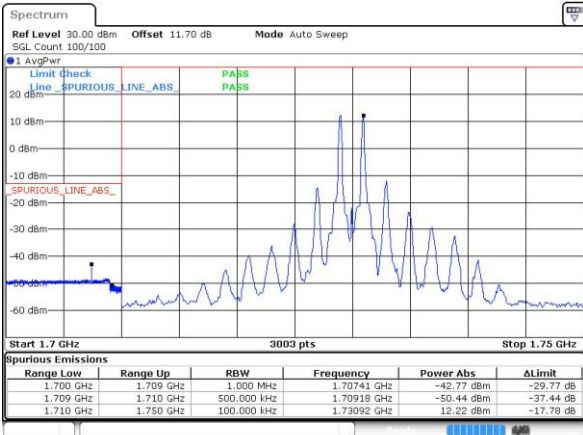

Date: 12 JUN 2019 01:18:21

Highest Band Edge / 1RB99 and 1RB0

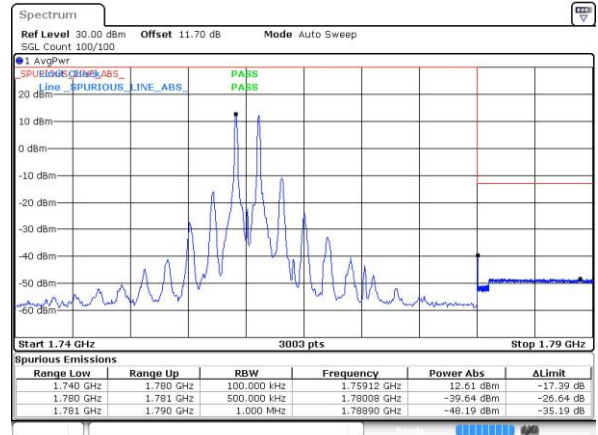

Date: 12 JUN 2019 03:02:51

Lowest Band Edge / Full RB

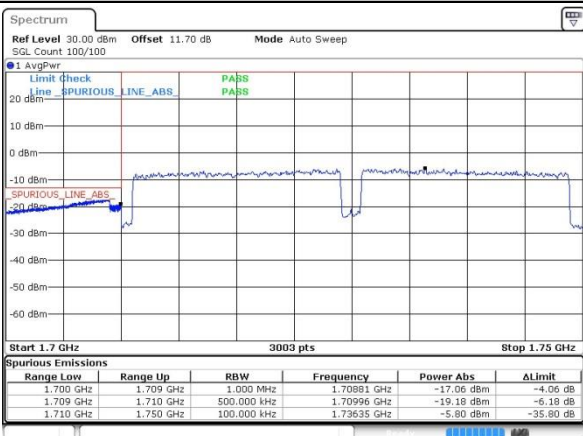

Date: 12 JUN 2019 10:02:31

Highest Band Edge / Full RB

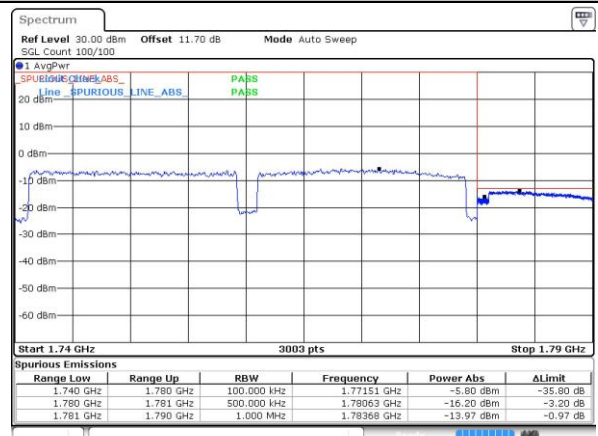

Date: 2 JUL 2019 13:56:46



Conducted Spurious Emission

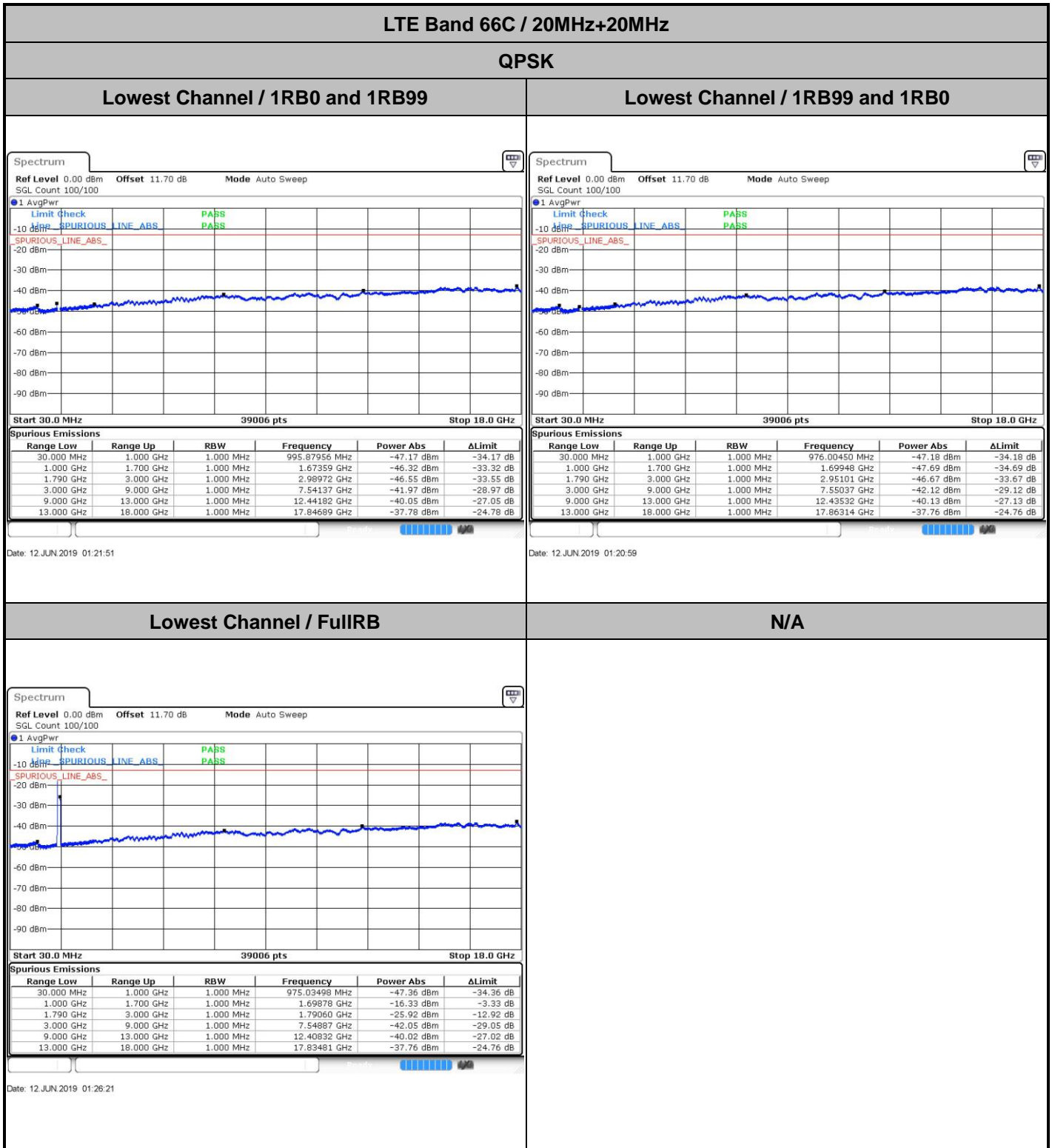



LTE Band 66C / 20MHz+20MHz

QPSK

MiddleChannel / 1RB0 and 1RB99

Middle Channel / 1RB99 and 1RB0

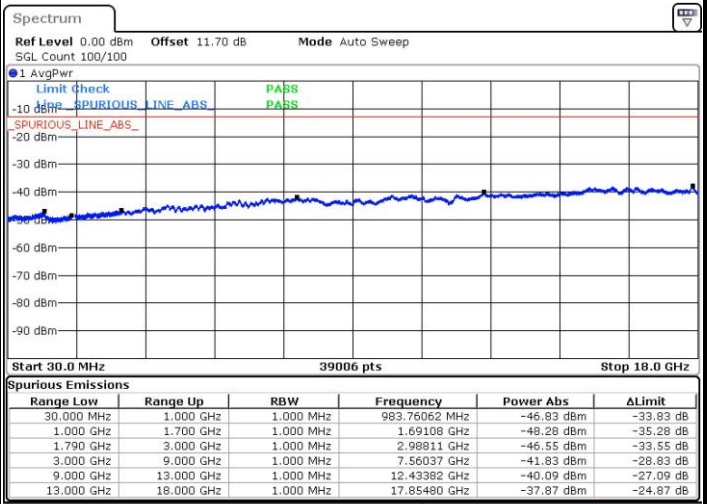
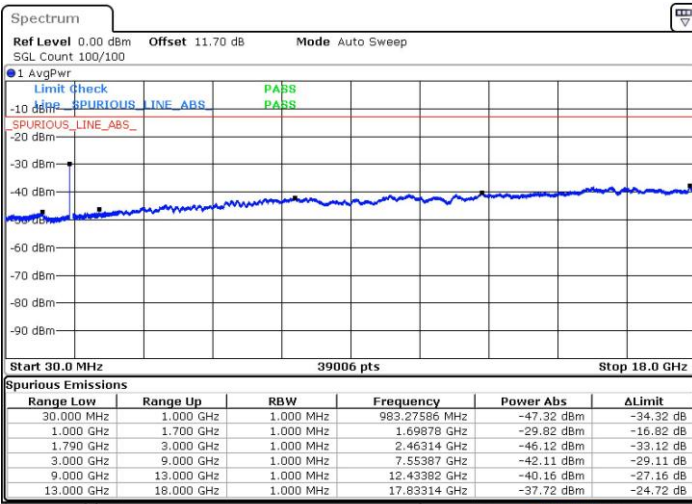

Date: 12 JUN 2019 02:42:28

Date: 12 JUN 2019 02:43:45

Middle Channel / FullIRB

N/A

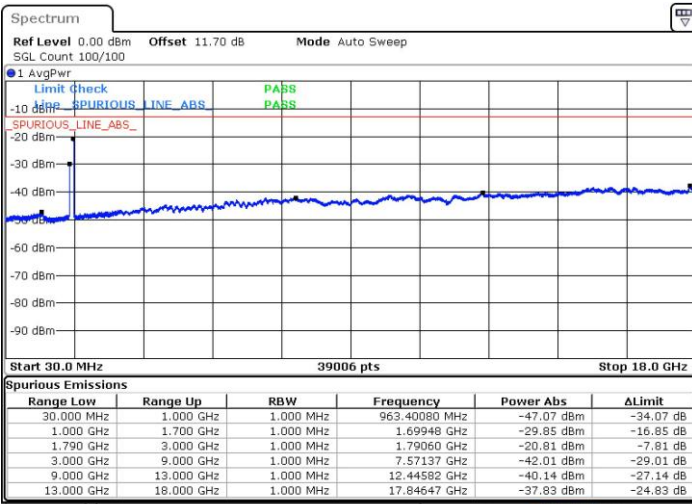

Date: 12 JUN 2019 02:35:50



LTE Band 66C / 20MHz+20MHz

QPSK

Highest Channel / 1RB0 and 1RB99

Highest Channel / 1RB99 and 1RB0

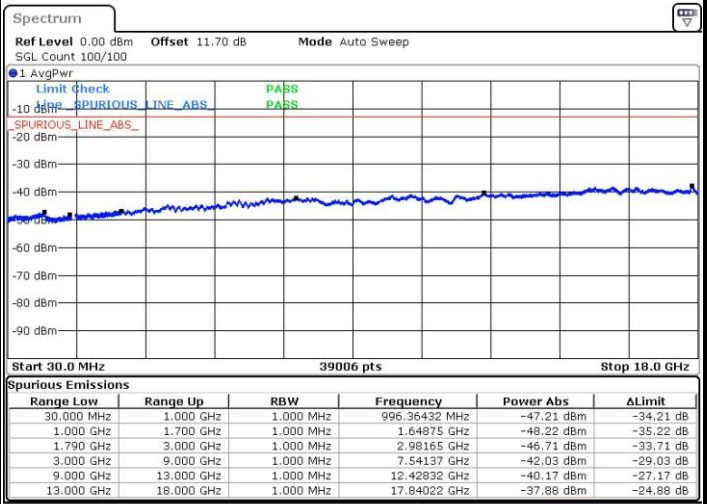
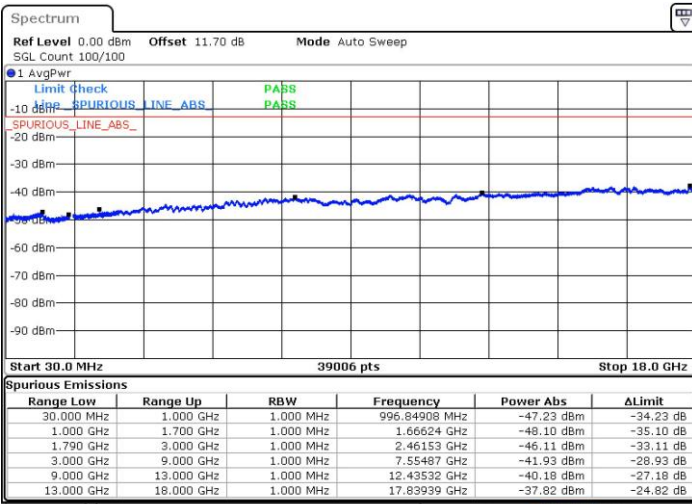

Date: 12 JUN 2019 03:13:03

Date: 12 JUN 2019 03:06:32

Highest Channel / FullIRB

N/A

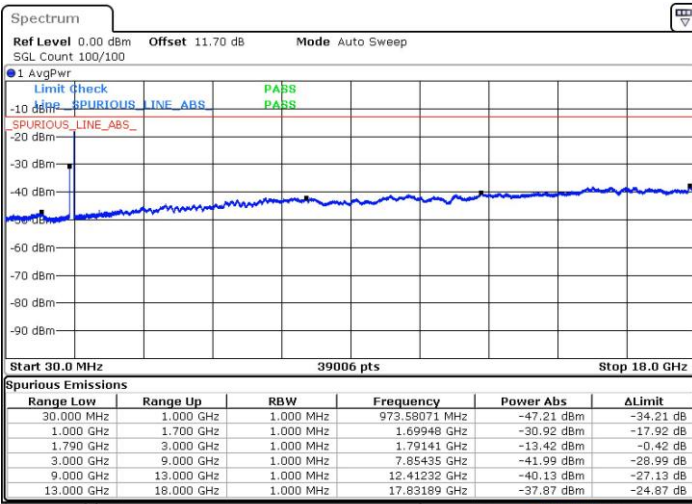

Date: 12 JUN 2019 03:14:22



LTE Band 66C / 20MHz+20MHz

16QAM

Lowest Channel / 1RB0 and 1RB99

Lowest Channel / 1RB99 and 1RB0

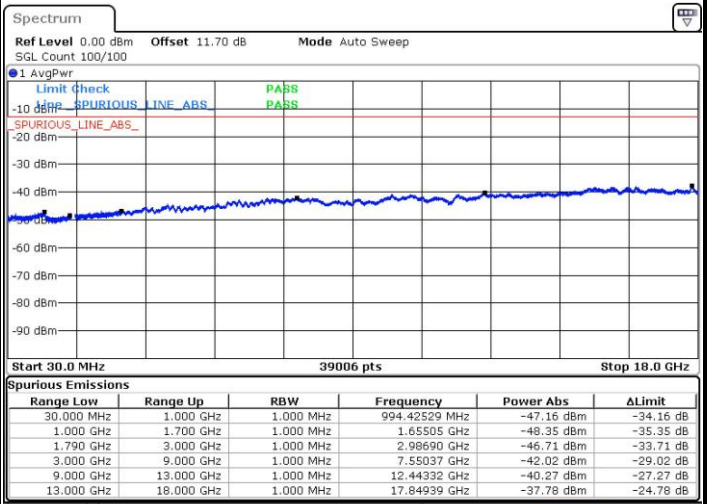
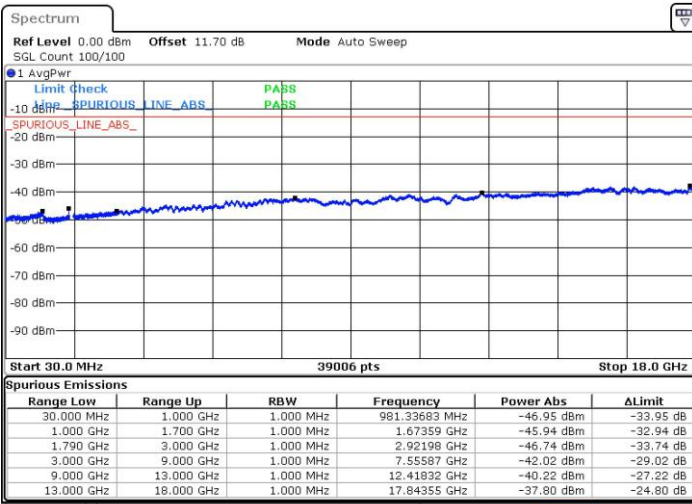

Date: 12 JUN 2019 01:22:45

Date: 12 JUN 2019 01:20:05

Lowest Channel / FullIRB

N/A

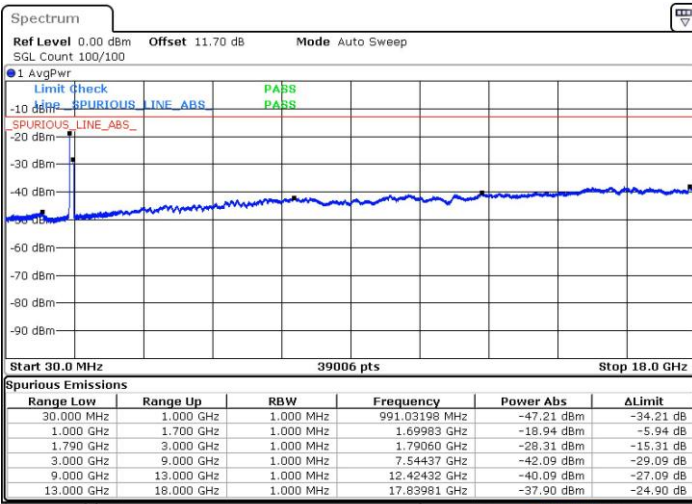

Date: 12 JUN 2019 01:25:27



LTE Band 66C / 20MHz+20MHz

16QAM

MiddleChannel / 1RB0 and 1RB99

Middle Channel / 1RB99 and 1RB0

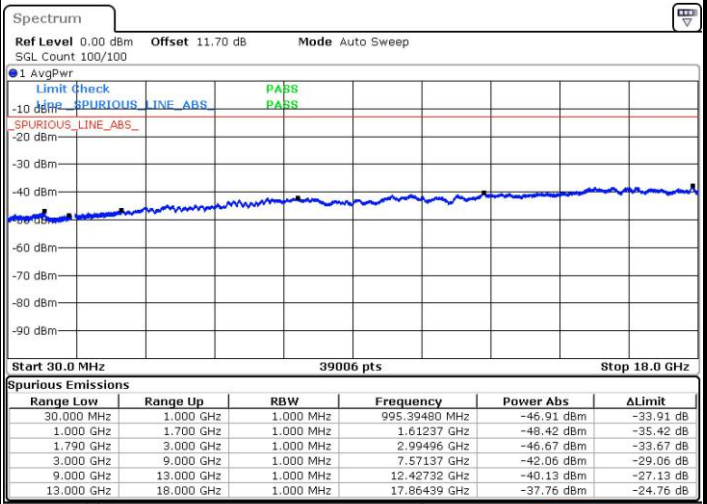
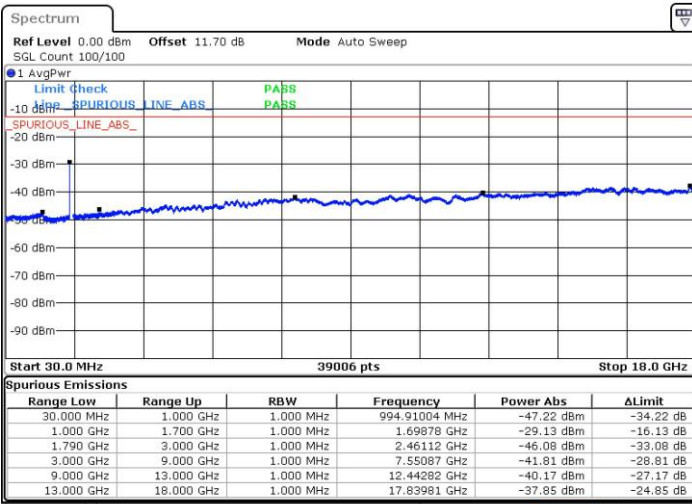

Date: 12 JUN 2019 02:41:08

Date: 12 JUN 2019 02:45:03

Middle Channel / FullIRB

N/A

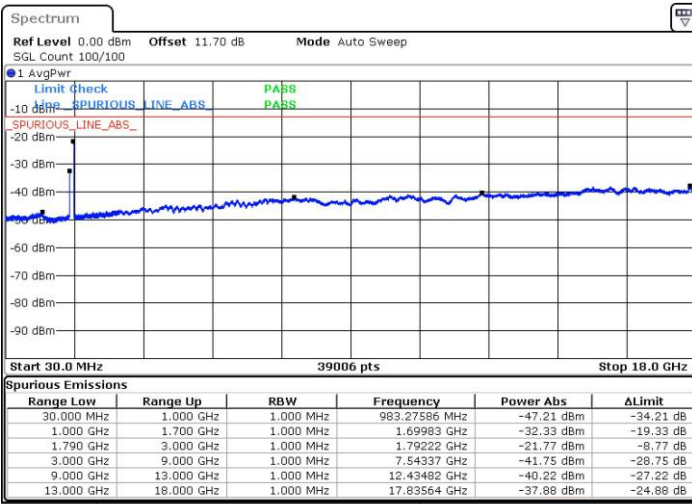

Date: 12 JUN 2019 02:37:10



LTE Band 66C / 20MHz+20MHz

16QAM

Highest Channel / 1RB0 and 1RB99

Highest Channel / 1RB99 and 1RB0

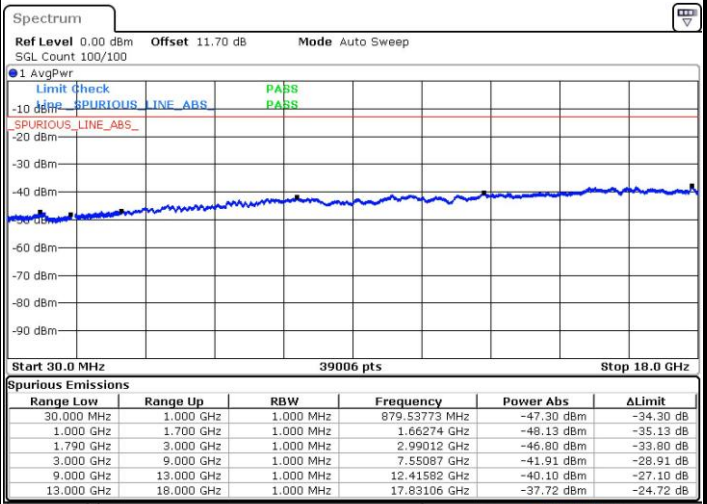
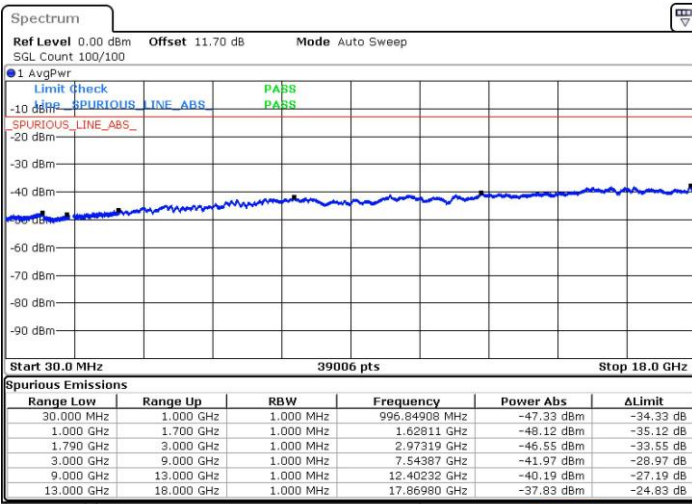

Date: 12 JUN 2019 03:11:45

Date: 12 JUN 2019 03:07:51

Highest Channel / FullIRB

N/A

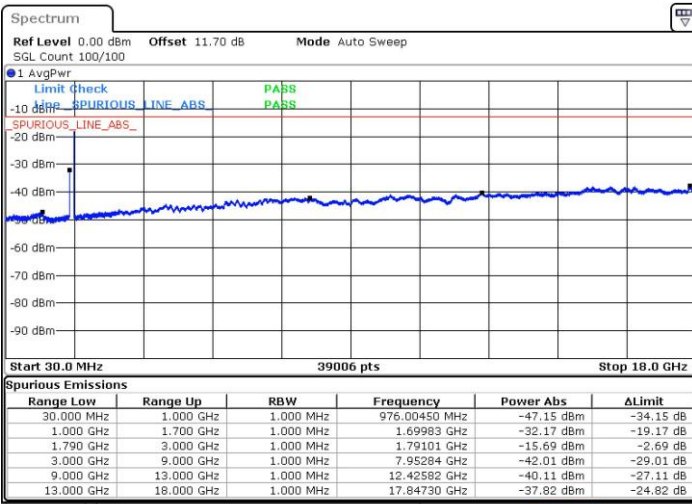

Date: 12 JUN 2019 03:15:40



LTE Band 66C / 20MHz+20MHz

64QAM

Lowest Channel / 1RB0 and 1RB99

Lowest Channel / 1RB99 and 1RB0

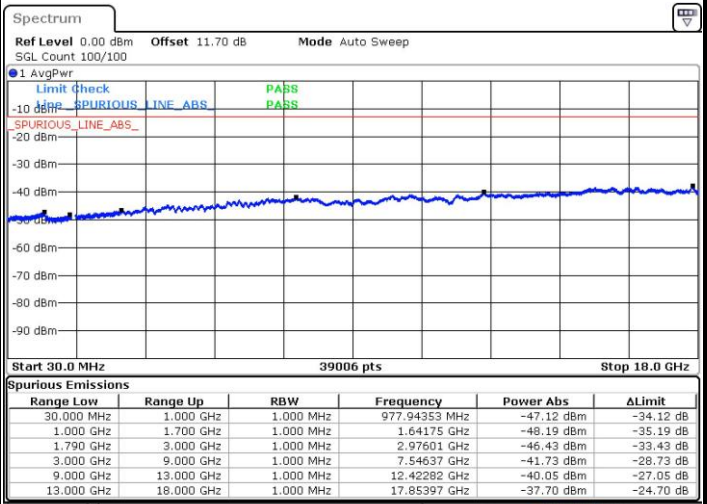
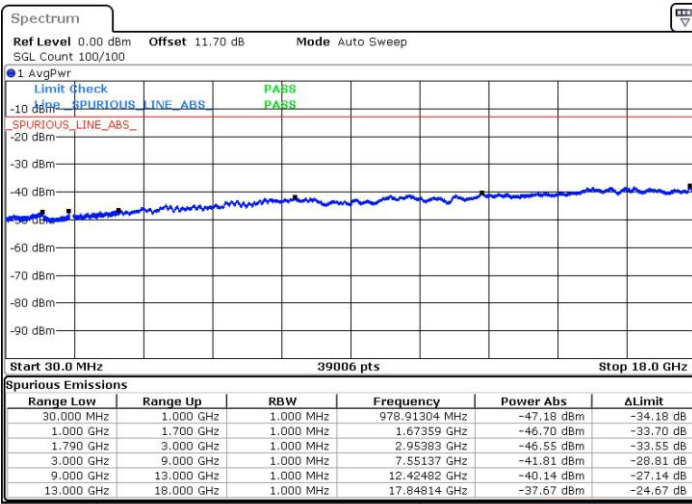

Date: 12 JUN 2019 01:23:39

Date: 12 JUN 2019 01:19:12

Lowest Channel / FullIRB

N/A

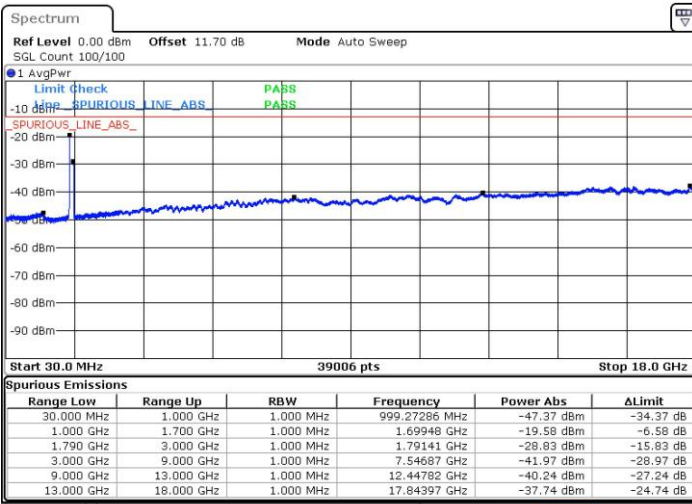

Date: 12 JUN 2019 01:24:32



LTE Band 66C / 20MHz+20MHz

64QAM

MiddleChannel / 1RB0 and 1RB99

Middle Channel / 1RB99 and 1RB0

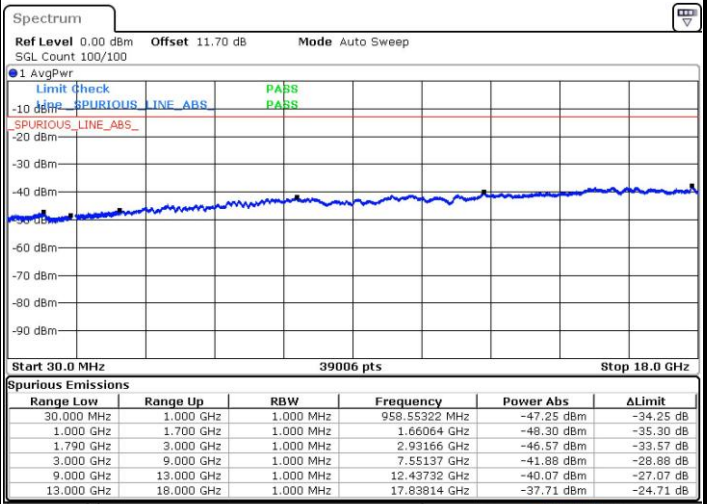
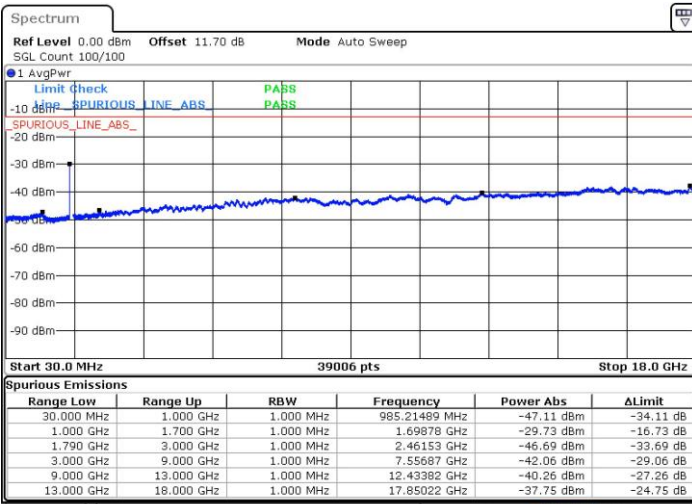

Date: 12 JUN 2019 02:39:48

Date: 12 JUN 2019 02:46:22

Middle Channel / FullIRB

N/A

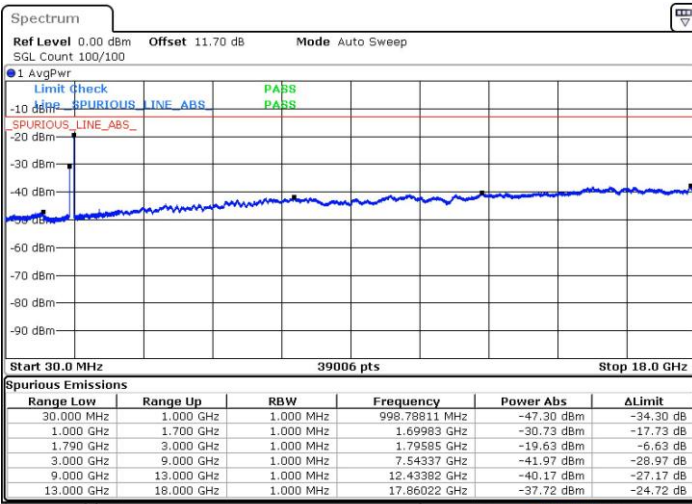

Date: 12 JUN 2019 02:38:29



LTE Band 66C / 20MHz+20MHz

64QAM

Highest Channel / 1RB0 and 1RB99

Highest Channel / 1RB99 and 1RB0

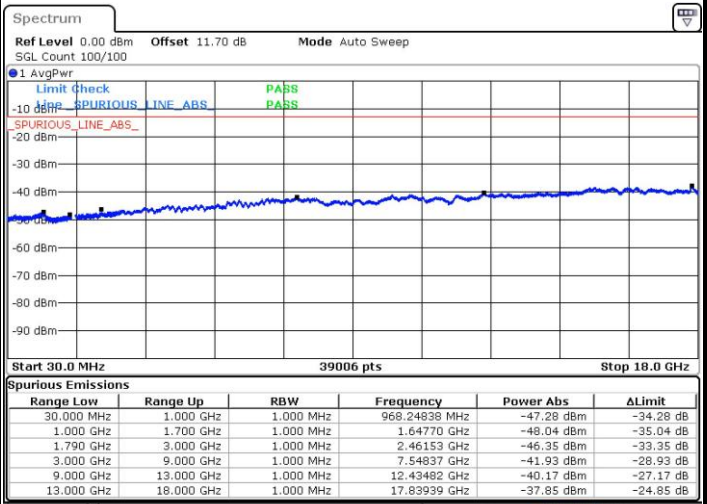
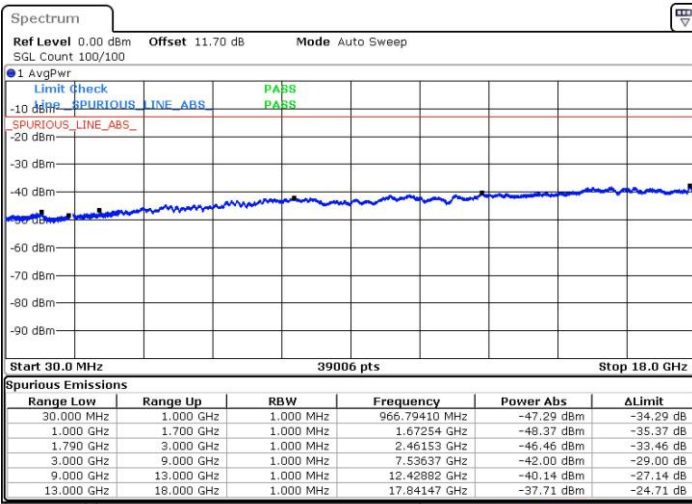

Date: 12 JUN 2019 03:10:27

Date: 12 JUN 2019 03:09:09

Highest Channel / FullIRB

N/A

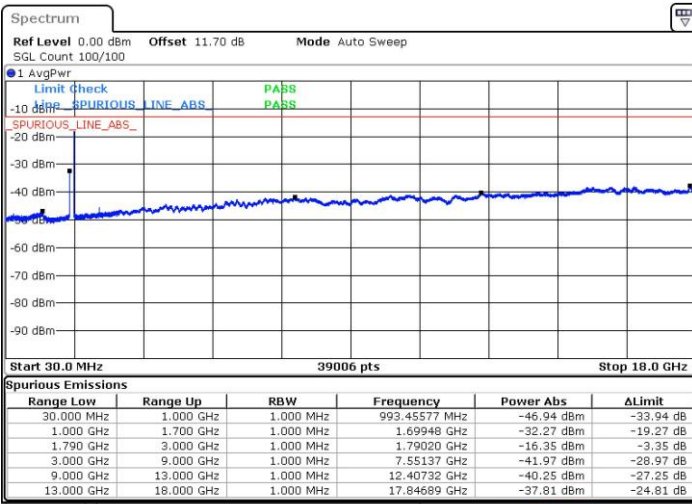

Date: 12 JUN 2019 03:16:59



Radiated Spurious Emission

LTE ULCA B66 20M 1RB99 QPSK + 20M 1RB0 QPSK

LTE ULCA_B66_20M 1RB99 QPSK+20M 1RB0 QPSK									
Channel	Frequency (MHz)	EIRP (dBm)	Limit (dBm)	Over Limit (dB)	SPA Reading (dBm)	S.G. Power (dBm)	TX Cable loss (dB)	TX Antenna Gain (dBi)	Polarization (H/V)
Low	3455	-53.52	-13	-40.52	-70.01	-63.95	1.83	12.27	H
	5191	-41.37	-13	-28.37	-63.1	-51.23	2.28	12.14	H
	6913	-46.08	-13	-33.08	-71.88	-54.68	2.39	10.99	H
	3455	-55.86	-13	-42.86	-72.74	-66.29	1.83	12.27	V
	5191	-47.42	-13	-34.42	-68.99	-57.28	2.28	12.14	V
	6913	-48.25	-13	-35.25	-73.6	-56.85	2.39	10.99	V
Middle	3511	-52.74	-13	-39.74	-69.82	-63.26	1.88	12.39	H
	5261	-39.11	-13	-26.11	-61.07	-49.01	2.25	12.15	H
	7015	-45.37	-13	-32.37	-71.66	-53.83	2.41	10.87	H
	3511	-54.97	-13	-41.97	-72.36	-65.49	1.88	12.39	V
	5261	-46.13	-13	-33.13	-67.85	-56.03	2.25	12.15	V
	7015	-47.35	-13	-34.35	-73.16	-55.81	2.41	10.87	V
High	3518	-53.07	-13	-40.07	-70.14	-63.58	1.88	12.39	H
	5275	-40.94	-13	-27.94	-62.9	-50.85	2.25	12.16	H
	7039	-45.91	-13	-32.91	-72.26	-54.34	2.40	10.83	H
	3483	-55.43	-13	-42.43	-72.81	-65.92	1.86	12.35	V
	5226	-47.73	-13	-34.73	-69.45	-57.61	2.27	12.15	V
	6964	-47.97	-13	-34.97	-73.85	-56.50	2.41	10.94	V

Remark: Spurious emissions within 30-1000MHz were found more than 20dB below limit line.

Appendix B. Setup Photographs

<Radiated Emission>

Y Plane

LF



HF

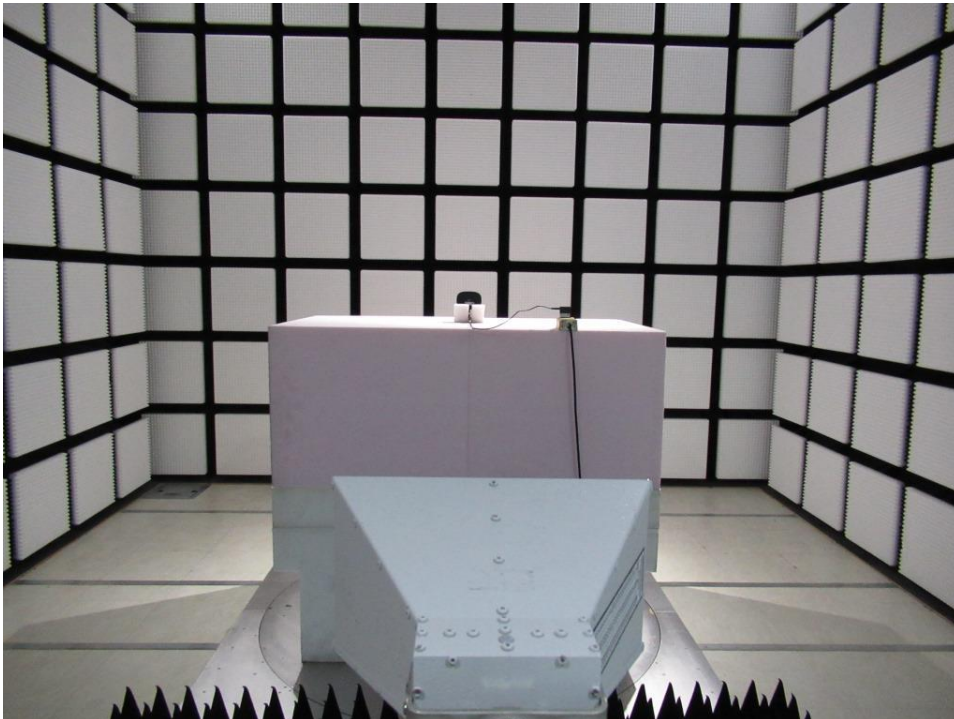

————THE END————