



America

**Choose certainty.
Add value.**

Report On

Application for Grant of Equipment Authorization of the
Inseego Corp.

M1000 Wireless Hotspot Modem

FCC CFR 47 Part 2, Part 22 and Part 24: 2018
RSS-132 issue 3: 2013 and RSS-133 issue 6: 2018

Report No. 72146272A

May 2019





REPORT ON Radio Testing of the
Inseego Corp.
M1000 Wireless Hotspot Modem

TEST REPORT NUMBER 72146272A

PREPARED FOR Inseego Corp.
9605 Scranton Road, Suite 300
San Diego, CA 92121
USA

CONTACT PERSON Roman Olmos
Senior Regulatory Engineer
(858) 812-0606
roman.olmos@inseego.com

PREPARED BY 
Xiaoying Zhang
Name
Authorized Signatory
Title: EMC/Wireless Test Engineer

APPROVED BY 
Ferdinand S. Custodio
Name
Authorized Signatory
Title: Senior EMC Test Engineer/Wireless Team Lead

DATED May 10, 2019



Revision History

72146272A Inseego Corp. M1000 Wireless Hotspot Modem					
DATE	OLD REVISION	NEW REVISION	REASON	PAGES AFFECTED	APPROVED BY
05/10/2019	-	Initial Release			Ferdinand Custodio



CONTENTS

Section	Page No
1	REPORT SUMMARY..... 5
1.1	Introduction 6
1.2	Brief Summary of Results..... 7
1.3	Product Information 8
1.4	EUT Test Configuration 10
1.5	Deviations from the Standard..... 12
1.6	Modification Record 12
1.7	Test Methodology..... 12
1.8	Test Facility Location..... 12
1.9	Test Facility Registration 12
1.10	Sample Calculations 14
2	TEST DETAILS 16
2.1	Transmitter Conducted Power Measurements 17
2.2	Effective Radiated Power..... 23
2.3	Equivalent Isotropic Radiated Power..... 25
2.4	Peak-Average Ratio..... 29
2.5	Occupied Bandwidth..... 44
2.6	Spurious Emission at Band Edge 51
2.7	Conducted Spurious Emissions 74
2.8	Field Strength of Spurious Radiation 81
2.9	Frequency Stability 98
2.10	Conducted Emissions..... 104
3	TEST EQUIPMENT USED 108
3.1	Test Equipment Used..... 109
3.2	Measurement Uncertainty 111
4	DIAGRAM OF TEST SETUP 113
4.1	Test Setup Diagram..... 114
5	ACCREDITATION, DISCLAIMERS AND COPYRIGHT 118
5.1	Accreditation, Disclaimers and Copyright..... 119



SECTION 1

REPORT SUMMARY

Radio Testing of the
Insego Corp.
M1000 Wireless Hotspot Modem



1.1 INTRODUCTION

The information contained in this report is intended to show verification of the Inseego Corp. M1000 Wireless Hotspot Modem to the requirements of the following:

- FCC CFR 47 Part 2, Part 22 and Part 24: 2018
- RSS-132 issue 3: 2013 and RSS-133 issue 6: 2018

Objective	To perform Radio Testing to determine the Equipment Under Test's (EUT's) compliance with the Test Specification, for the series of tests carried out.
Manufacturer	Inseego Corp.
Product Marketing Name	5G MiFi 1000
Model Number(s)	M1000
FCC ID Number	PKRISGM1000
IC Number	3229A-M1000
Serial Number(s)	FF161218B00106 FF130219B00478 FF130219B00600
Number of Samples Tested	3
Test Specification/Issue/Date	<ul style="list-style-type: none">• FCC CRF 47 Part 2, Part 22 and Part 24 (October 1, 2018)• KDB412172 D01 Determining ERP and EIRP v01r01 August 07, 2015: Guidelines for determining the Effective Radiated Power (ERP) and Equivalent Isotropically Radiated Power (EIRP) of an RF transmitting system• KDB971168 D01 Power Meas License Digital Systems v03r01: April 9 2018: Measurement guidance for certification of licensed digital transmitters• RSS-132 issue 3 January 2013: Cellular Telephone Systems Operating in the Bands 824-849 MHz and 869-894 MHz• RSS-133 issue 6 January 2018 Amendment: 2 GHz Personal Communications Services• RSS-Gen Issue 5 Amendment 1: March 2019 - General Requirements for Compliance of Radio Apparatus• ANSI C63.26-2015: American National Standard for Compliance Testing of Transmitters Used in Licensed Radio Services
Start of Test	March 04, 2019
Finish of Test	April 26, 2019
Name of Engineer(s)	Xiaoying Zhang
Related Document(s)	Supporting documents for EUT certification are separate exhibits.



1.2 BRIEF SUMMARY OF RESULTS

A brief summary of the tests carried out in accordance with FCC CFR 47 Part 2, Part 22 and Part 24: 2018 with cross-reference to the corresponding ISED RSS standard is shown below.

Section	FCC Part Sections(s)	ISED Sections	Test Description	Result
2.1	2.1046	RSS-132: 5.4 RSS-133: 6.4	Transmitter Conducted Output Power	Compliant
2.2	2.1046 22.913(a)(5)	-	Effective Radiated Power	Compliant
2.3	2.1046 24.232(c)	RSS-132: 5.4 RSS-133: 6.4	Equivalent Isotropic Radiated Power	Compliant
2.4	24.232(d)	RSS-132: 5.4, RSS-133: 6.4	Peak-Average Ratio	Compliant
2.5	2.1049 22.917(b) 24.238(b)	RSS-GEN 6.7 RSS-132: 5.5 RSS-133: 6.5	Occupied Bandwidth	Compliant
2.6	2.1051, 22.917(a)(b) 24.238(a)(b)	RSS-132: 5.5 RSS-133: 6.5	Band Edge	Compliant
2.7	2.1051 22.917(a)(b) 24.238(a)(b)	RSS-132: 5.5 RSS-133: 6.5	Conducted Spurious Emissions	Compliant
2.8	2.1053 22.917(a) 24.238(a)	RSS-132: 5.5 RSS-133: 6.5	Field Strength of Spurious Radiation	Compliant
2.9	2.1055 22.355 24.235	RSS-132: 5.3 RSS-133: 6.3	Frequency Stability	Compliant
-	-	RSS-132: 5.6 RSS-133: 6.6 RSS-Gen 7.4	Receiver Spurious Emissions	N/A*
2.11	-	RSS-GEN 8.8	Power Line Conducted Emissions	Compliant

N/A* Not Applicable. No stand-alone receiver.



1.3 PRODUCT INFORMATION

1.3.1 EUT General Description

The Equipment Under Test (EUT) was a Inseego Corp. M1000 Wireless Hotspot Modem. The EUT is a Wireless Hotspot Modem supporting 3G/4G/5G/WLAN Technologies. The EUT is also equipped with a USB Port and AC Wall Power Adaptor.

1.3.2 Technical Description

EUT Description	Wireless Hotspot Modem
Product Marketing Name	5G MiFi 1000
Model Number(s)	M1000
Rated Voltage	3.8V, 4400mAh (Rechargeable Li-Ion battery pack) Input 100-240VAC, Output 5V (External AC-DC Power Adapter)
Mode Verified (Frequency Bands)	WCDMA Band 2: 1850-1910 MHz WCDMA Band 5: 824-849 MHz LTE Band 2: 1850-1910 MHz LTE Band 5: 824-849 MHz
Capability	WCDMA Band 2, 4, 5, LTE Band 2, 4, 5, 13, 66, 5G Band n261, and 802.11 a/b/g/n/ac
Primary Unit (EUT)	<input type="checkbox"/> Production <input checked="" type="checkbox"/> Pre-Production <input type="checkbox"/> Engineering
Frequency Tolerance	±0.00025% (2.5ppm)
Manufacturer Declared Voltage Range	3.3 V – 4.2 VDC

(Client declaration, max. antenna gain covered under this test report)

Technologies / Bands	Frequency	Antenna Gains
WCDMA/LTE Band 2	1850-1910 MHz	1.9 dBi
WCDMA/LTE Band 5	824-849 MHz	0 dBi



1.3.3 Transmit Frequency Table

Technology / Band	Tx Frequency (MHz)	Emission Designator	ERP (Part 22) / EIRP (RSS-132 and Part 24/RSS-133)			
			ERP Max. Power		EIRP Max. Power	
			dBm	mW	dBm	mW
WCDMA Band 2	1850-1910	4M14F9W	—	—	25.82	381.94
WCDMA Band 5	824-849	4M22F9W	21.09	128.53	23.24	210.84

Technology / Band	Modulation	Bandwidth (MHz)	Tx Frequency (MHz)	Emission Designator	ERP (Part 22) / EIRP (RSS-132 and Part 24/RSS-133)			
					ERP Max. Power		EIRP Max. Power	
					dBm	mW	dBm	mW
LTE Band 2	QPSK	1.4	1850-1910	1M09G7D	—	—	24.68	293.76
		3	1850-1910	2M70G7D	—	—	25.70	371.54
		5	1850-1910	4M49G7D	—	—	25.69	370.68
		10	1850-1910	8M97G7D	—	—	25.66	368.13
		15	1850-1910	13M5G7D	—	—	25.70	371.54
		20	1850-1910	17M9G7D	—	—	25.74	374.97
	16QAM	1.4	1850-1910	1M09W7D	—	—	24.72	296.48
		3	1850-1910	2M69W7D	—	—	24.81	302.69
		5	1850-1910	4M87W7D	—	—	24.92	310.46
		10	1850-1910	8M97W7D	—	—	24.75	298.54
		15	1850-1910	13M5W7D	—	—	24.77	299.92
		20	1850-1910	17M9W7D	—	—	24.81	302.69
LTE Band 5	QPSK	1.4	824-849	1M09G7D	21.73	148.94	23.88	244.34
		3	824-849	2M69G7D	21.71	148.25	23.86	243.22
		5	824-849	4M48G7D	21.78	150.66	23.93	247.17
		10	824-849	8M94G7D	21.81	151.71	23.96	248.89
	16QAM	1.4	824-849	1M09W7D	20.76	119.12	22.91	195.43
		3	824-849	2M69W7D	20.95	124.45	23.10	204.17
		5	824-849	4M48W7D	20.88	122.46	23.03	200.91
		10	824-849	8M96W7D	20.98	125.31	23.13	205.59

1.4 EUT TEST CONFIGURATION

1.4.1 Test Configuration Description

Test Configuration	Description
A	Conducted antenna port measurement. EUT Transmits at maximum power and is powered by the internal battery and/or USB via AC Adapter.
B	Radiated test setup / case spurious emissions. The EUT is connected to the call box in radiated way or connect to the call box with antenna port terminated by the call box.

1.4.2 EUT Exercise Software

EUT is controlled by a CMW 500 Wideband Radio Communication Tester. There are no other test software used during verification.

1.4.3 Support Equipment and I/O cables

Manufacturer	Equipment/Cable	Description
Inseego Corp.	USB Cable	Type A to Type C USB Cable. M/N: NOV7000USB
Inseego Corp.	External AC-DC Power Adapter	Model: SSW-2783, PN: 40123126.01 Input: 100-240VAC, 50/60Hz, 0.5A Output: 5VDC, max. 2A

1.4.4 Worst Case Configuration

Worst-case configuration used in this test report:

Technology / Band	Test Configuration
WCDMA Band 2 and 5	Connection Setup: Test Mode, Type: RMC, Test Mode: No Loop

Band	Channel BW	Modulation	RB Size/Offset
LTE Band 2	20 MHz	QPSK	1/49
LTE Band 5	10 MHz	QPSK	1/0

For radiated measurements X, Y, and Z orientations were verified. The verification was determined "Y" as worst case configuration.

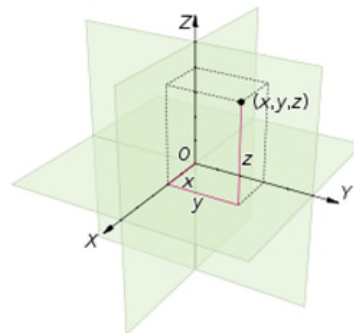

1.4.5 Simplified Test Configuration Diagram

Radiated Test Configuration

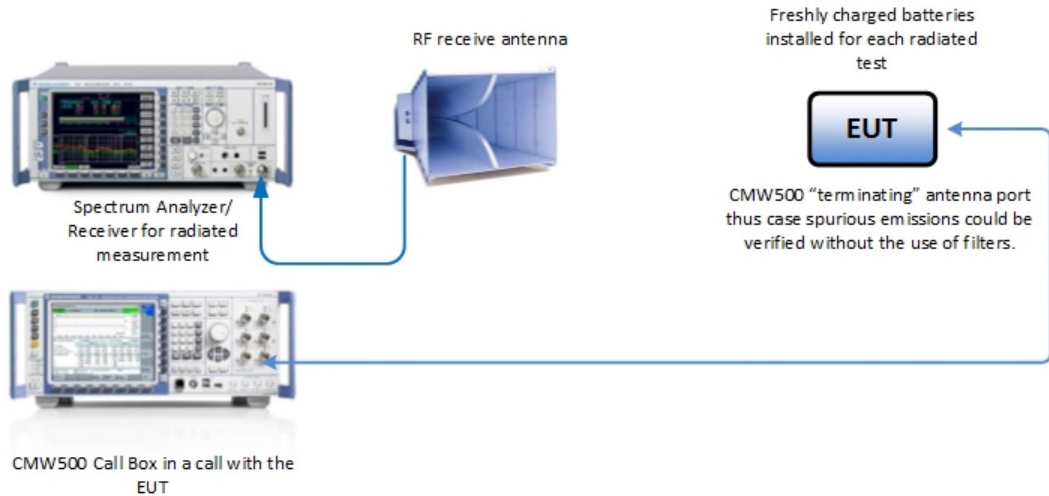

Conducted (Antenna Port) Test Configuration

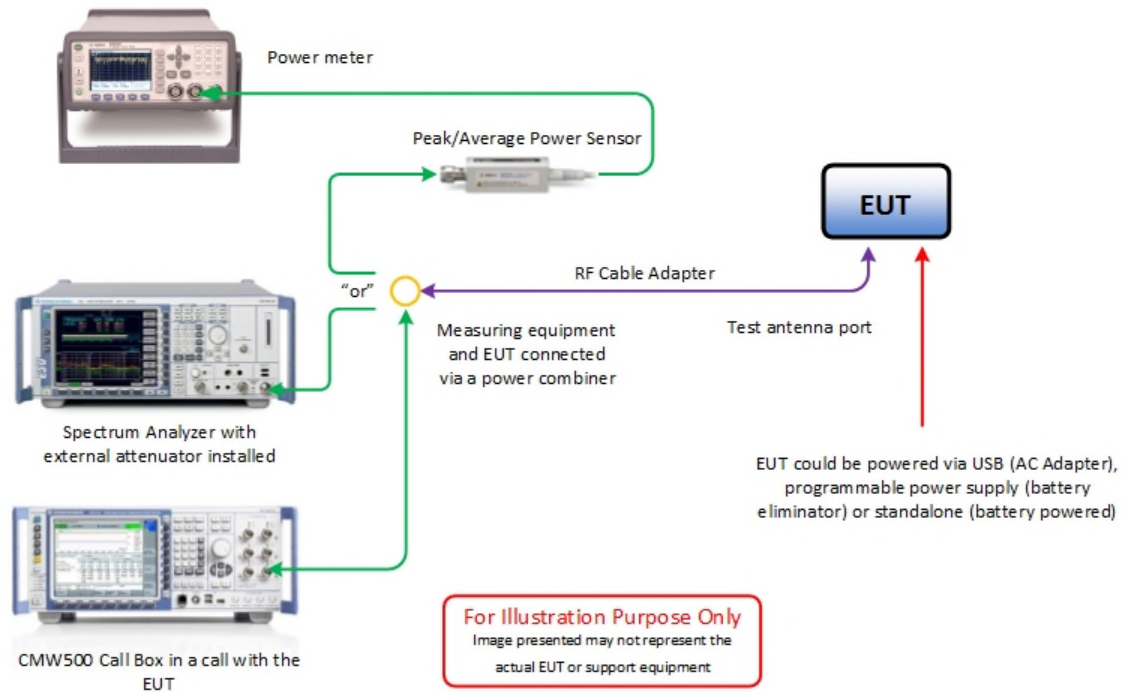



1.5 DEVIATIONS FROM THE STANDARD

No deviations from the applicable test standards or test plan were made during testing.

1.6 MODIFICATION RECORD

Description of Modification	Modification Fitted By	Date Modification Fitted
Serial Number: FF161218B00106, FF130219B00478, and FF130219B00600		
None	—	—

The table above details modifications made to the EUT during the test programme. The modifications incorporated during each test (if relevant) are recorded on the appropriate test pages.

1.7 TEST METHODOLOGY

All measurements contained in this report were conducted with ANSI C63.26-2015, American National Standard for Compliance Testing of Transmitters Used in Licensed Radio Services.

For conducted and radiated emissions the equipment under test (EUT) was configured to measure its highest possible emission level. The test modes were adapted according to the Operating Instructions provided by the manufacturer/client.

1.8 TEST FACILITY LOCATION

1.8.1 TÜV SÜD America Inc. (Mira Mesa)

10040 Mesa Rim Road, San Diego, CA 92121-2912 (32.901268,-117.177681). Phone: 858 678 1400 FAX: 858 546 0364

1.8.2 TÜV SÜD America Inc. (Rancho Bernardo)

16936 Via Del Campo, San Diego, CA 92127-1708 (33.018644,-117.092409). Phone: (858) 678-1400 Fax: (858) 546-0364.

1.9 TEST FACILITY REGISTRATION

1.9.1 FCC – Designation No.: US1146

TUV SUD America Inc. (San Diego), is an accredited test facility with the site description report on file and has met all the requirements specified in §2.948 of the FCC rules. The acceptance letter from the FCC is maintained in our files and the Designation is US1146.



1.9.2 Innovation, Science and Economic Development Canada (IC) Registration No.: 3067A-1 & 22806-1

The 10m Semi-anechoic chamber of TUV SUD America Inc. (San Diego Rancho Bernardo) has been registered by Certification and Engineering Bureau of Innovation, Science and Economic Development Canada for radio equipment testing with Registration No. 3067A-1.

The 3m Semi-anechoic chamber of TUV SUD America Inc. (San Diego Mira Mesa) has been registered by Certification and Engineering Bureau of Innovation, Science and Economic Development Canada for radio equipment testing with Registration No. 22806-1.

1.9.3 BSMI – Laboratory Code: SL2-IN-E-028R (US0102)

TUV Product Service Inc. (San Diego) is a recognized EMC testing laboratory by the BSMI under the MRA (Mutual Recognition Arrangement) with the United States. Accreditation includes CNS 13438 up to 6GHz.

1.9.4 NCC (National Communications Commission - US0102)

TUV SUD America Inc. (San Diego) is listed as a Foreign Recognized Telecommunication Equipment Testing Laboratory and is accredited to ISO/IEC 17025 (A2LA Certificate No.2955.13) which under APEC TEL MRA Phase 1 was designated as a Conformity Assessment Body competent to perform testing of equipment subject to the Technical Regulations covered under its scope of accreditation including RTTE01, PLMN01 and PLMN08 for TTE type of testing and LP002 for Low-Power RF Device type of testing.

1.9.5 VCCI – Registration No. A-0280 and A-0281

TUV SUD America Inc. (San Diego) is a VCCI registered measurement facility which includes radiated field strength measurement, radiated field strength measurement above 1GHz, mains port interference measurement and telecommunication port interference measurement.

1.9.6 RRA – Identification No. US0102

TUV SUD America Inc. (San Diego) is National Radio Research Agency (RRA) recognized laboratory under Phase I of the APEC Tel MRA.

1.9.7 OFCA – U.S. Identification No. US0102

TUV SUD America Inc. (San Diego) is recognized by Office of the Communications Authority (OFCA) under Appendix B, Phase I of the APEC Tel MRA.



1.10 SAMPLE CALCULATIONS

1.10.1 GSM Emission Designator

Emission Designator = 250KGXW
GSM BW = 250 kHz
G = Phase Modulation
X = Cases not otherwise covered
W = Combination (Audio/Data)

1.10.2 WCDMA Emission Designator

Emission Designator = 4M15F9W
WCDMA BW = 4.15 MHz
F = Frequency Modulation
9= Composite Digital Info
W = Combination (Audio/Data)

1.10.3 CDMA Emission Designator

Emission Designator = 1M30F9W
F = Frequency Modulation
9= Composite Digital Info
W = Combination (Audio/Data)

1.10.4 LTE Emission Designator (QPSK)

Emission Designator = 4M51G7D
G = Phase Modulation
7= Quantized/Digital Info
D = Combination (Audio/Data)

1.10.5 LTE Emission Designator (16QAM)

Emission Designator = 4M52W7D
W = Frequency Modulation
7= Quantized/Digital Info
D = Combination (Audio/Data)



1.10.6 Spurious Radiated Emission (below 1GHz)

Measuring equipment raw measurement (dBµV/m) @ 30 MHz		24.4
Correction Factor (dB)	Asset# 1066 (cable)	0.3
	Asset# 1172 (cable)	0.3
	Asset# 1016 (preamplifier)	-30.7
	Asset# 1175(cable)	0.3
	Asset# 1002 (antenna)	17.2
Reported QuasiPeak Final Measurement (dBµV/m) @ 30MHz		11.8

1.10.7 Spurious Radiated Emission – Substitution Method

Example = 84dBµV/m @ 1413 MHz (numerical sample only)

The field strength reading of 84dBµV/m @ 1413 MHz (2nd Harmonic of 706.5 MHz) is the maximized measurement when the EUT is on the turntable measured at 3 meters. The gain of the substituted antenna is 7.8dBi while the transmit cable loss is 1.0 dB (cable between signal generator and the substituted antenna). The signal generator level is adjusted until the 84dBµV/m level at the receiving end is replicated (identical test setup, i.e. same antenna, cable/s and preamp). If the adjusted signal generator level is -18dBm, then we have the following for both EIRP and ERP as required:

$$\begin{aligned}
 P_{EIRP} &= -18 \text{ dBm} + 7.8 \text{ dBi} - 1 \text{ dB} \\
 &= 11.2 \text{ dBm} \\
 P_{ERP} &= P_{EIRP} - 2.15 \text{ dB} \\
 &= 11.2 \text{ dBm} - 2.15 \text{ dB} \\
 &= 9.05 \text{ dBm}
 \end{aligned}$$



SECTION 2

TEST DETAILS

Radio Testing of the
Insego Corp.
M1000 Wireless Hotspot Modem



2.1 TRANSMITTER CONDUCTED POWER MEASUREMENTS

2.1.1 Specification Reference

FCC 47 CFR Part 2, Clause 2.1046
RSS-132, Clause 5.4
RSS-133, Clause 6.4

2.1.2 Standard Applicable

The conducted power measurements were made in accordance to FCC Part 2 Clause 2.1046 and RSS-132 Clause 5.4 and RSS-133 Clause 6.4.

FCC 47 CFR Part 2.1046:

(a) For transmitters other than single sideband, independent sideband and controlled carrier radiotelephone, power output shall be measured at the RF output terminals when the transmitter is adjusted in accordance with the tune-up procedure to give the values of current and voltage on the circuit elements specified in § 2.1033(c)(8). The electrical characteristics of the radio frequency load attached to the output terminals when this test is made shall be stated.

(c) For measurements conducted pursuant to paragraphs (a) and (b) of this section, all calculations and methods used by the applicant for determining carrier power or peak envelope power, as appropriate, on the basis of measured power in the radio frequency load attached to the transmitter output terminals shall be shown. Under the test conditions specified, no components of the emission spectrum shall exceed the limits specified in the applicable rule parts as necessary for meeting occupied bandwidth or emission limitations.

2.1.3 Equipment Under Test and Modification State

Serial No: FF161218B00106 and FF130219B00478 / Test Configuration A

2.1.4 Date of Test/Initial of test personnel who performed the test

March 05 and 06, 2019 / XYZ

2.1.5 Test Equipment Used

The major items of test equipment used for the above tests are identified in Section 3.1.



2.1.6 Environmental Conditions

Test performed at TÜV SÜD America Inc. Rancho Bernardo facility

Ambient Temperature 21.8 – 22.3 °C
 Relative Humidity 43.2 – 48.8 %
 ATM Pressure 99.0 – 99.1 kPa

2.1.7 Additional Observations

- This is a conducted test using Power Meter.
- The path loss was measured and entered as a level offset.
- Low, Middle and High channels for all bandwidths with different RB size and RB offset and modulations were verified and reported, and for LTE Bands, only worst case RB size and RB offset test result presented.

2.1.8 Test Results

Band	Channel	Frequency (MHz)	Average Max Power (dBm)	Peak Max Power (dBm)
WCDMA Band 2	9262	1852.4	23.38	26.49
	9400	1880.0	23.83	27.37
	9538	1907.6	23.92	27.04
WCDMA Band 5	4132	826.4	23.22	26.34
	4183	836.6	23.24	26.51
	4233	846.6	23.13	26.62



LTE Band 2							
Bandwidth (MHz)	Channel	Frequency (MHz)	Modulation	No. RB	RB Start	Average Power (dBm)	Peak Power (dBm)
1.4	18607	1850.7	QPSK	1	3	22.78	25.93
	18900	1880		1	3	23.72	27.13
	19193	1909.3		1	3	22.35	25.76
	18607	1850.7	16QAM	1	3	21.98	25.95
	18900	1880		1	3	22.82	27.14
	19193	1909.3		1	3	21.36	25.81
3	18615	1851.5	QPSK	1	7	22.78	25.86
	18900	1880		1	7	23.80	27.09
	19185	1908.5		1	7	22.68	26.02
	18615	1851.5	16QAM	1	7	21.99	25.87
	18900	1880		1	7	22.91	27.12
	19185	1908.5		1	7	21.89	26.07
5	18625	1852.5	QPSK	1	12	22.74	25.84
	18900	1880		1	12	23.79	27.11
	19175	1907.5		1	12	22.92	26.32
	18625	1852.5	16QAM	1	12	22.07	25.86
	18900	1880		1	12	23.02	27.12
	19175	1907.5		1	12	22.06	26.35
10	18650	1855	QPSK	1	25	22.64	25.80
	18900	1880		1	25	23.76	27.14
	19150	1905		1	25	22.94	26.51
	18650	1855	16QAM	1	25	21.83	25.78
	18900	1880		1	25	22.85	27.14
	19150	1905		1	25	22.10	26.43
15	18675	1857.5	QPSK	1	37	22.62	25.82
	18900	1880		1	37	23.80	27.17
	19125	1902.5		1	37	22.51	26.04
	18675	1857.5	16QAM	1	37	21.84	25.82
	18900	1880		1	37	22.87	27.17
	19125	1902.5		1	37	21.66	26.01
20	18700	1860	QPSK	1	49	22.77	25.98
	18900	1880		1	49	23.84	27.22
	19100	1900		1	49	22.17	25.61
	18700	1860	16QAM	1	49	22.04	25.97
	18900	1880		1	49	22.91	27.23
	19100	1900		1	49	21.24	25.59



LTE Band 5							
Bandwidth (MHz)	Channel	Frequency (MHz)	Modulation	No. RB	RB Start	Average Power (dBm)	Peak Power (dBm)
1.4	20407	824.7	QPSK	1	3	23.72	27.03
	20525	836.5		1	3	23.88	27.31
	20643	848.3		1	3	23.45	26.75
	20407	824.7	16QAM	1	3	22.76	26.83
	20525	836.5		1	3	22.91	27.04
	20643	848.3		1	3	22.54	26.64
3	20415	825.5	QPSK	1	0	23.65	27.01
	20525	836.5		1	0	23.86	27.27
	20635	847.5		1	0	23.53	27.12
	20415	825.5	16QAM	1	7	22.89	26.89
	20525	836.5		1	7	23.10	27.04
	20635	847.5		1	7	22.68	26.80
5	20425	826.5	QPSK	1	12	23.83	27.15
	20525	836.5		1	12	23.93	27.22
	20625	846.5		1	12	23.56	27.09
	20425	826.5	16QAM	1	12	23.03	26.97
	20525	836.5		1	12	22.99	27.0
	20625	846.5		1	12	22.83	26.91
10	20450	829	QPSK	1	0	23.90	27.20
	20525	836.5		1	0	23.96	27.55
	20600	844		1	0	23.96	27.21
	20450	829	16QAM	1	25	23.02	27.47
	20525	836.5		1	25	23.13	27.39
	20600	844		1	25	23.05	27.09



America

2.1.9 Sample Test Measurement Screen

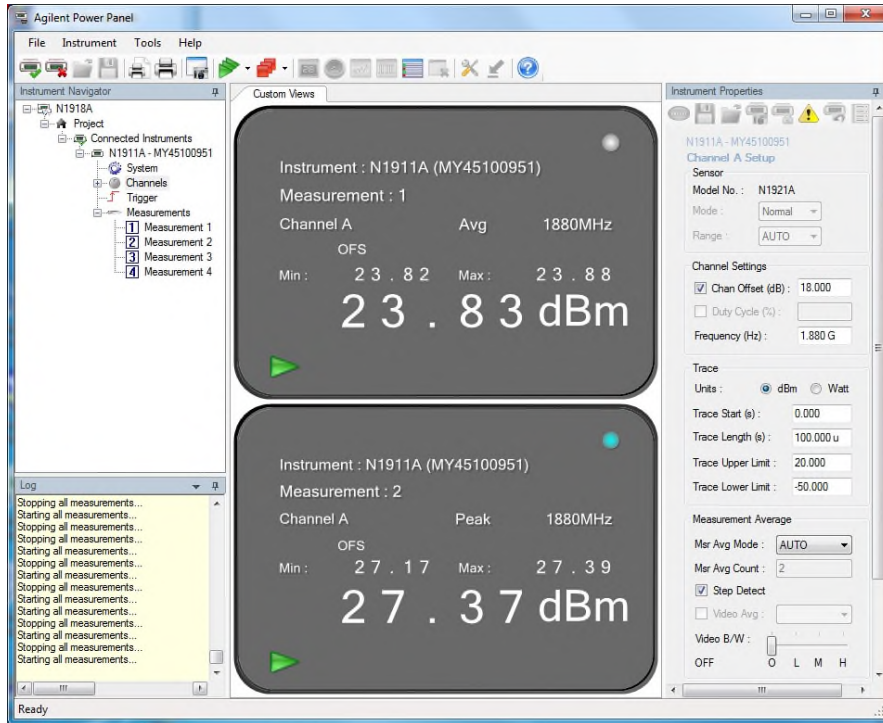

WCDMA Band 2 Middle Channel

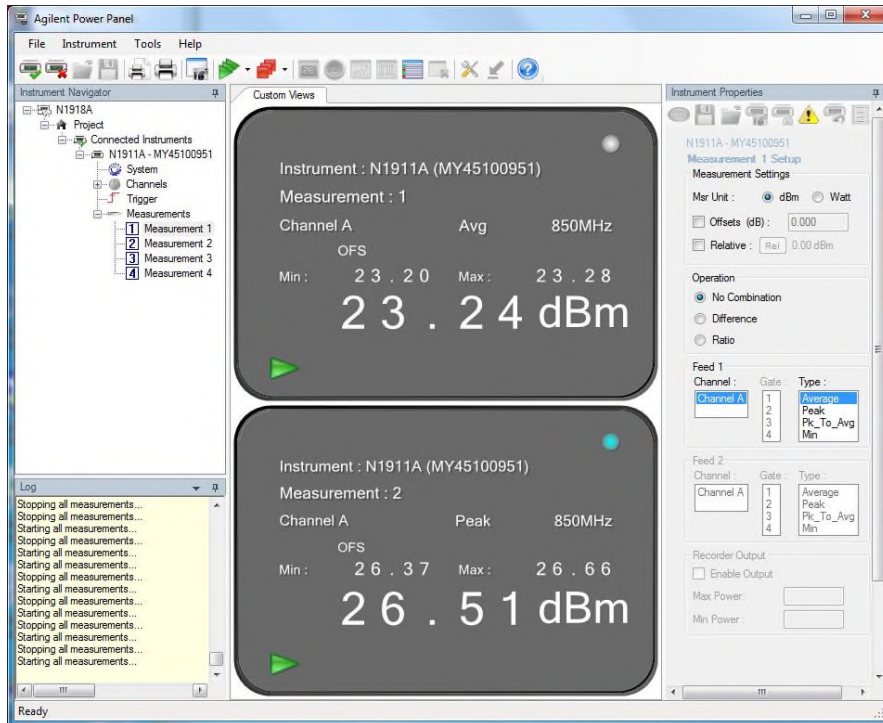

WCDMA Band 5 Middle Channel

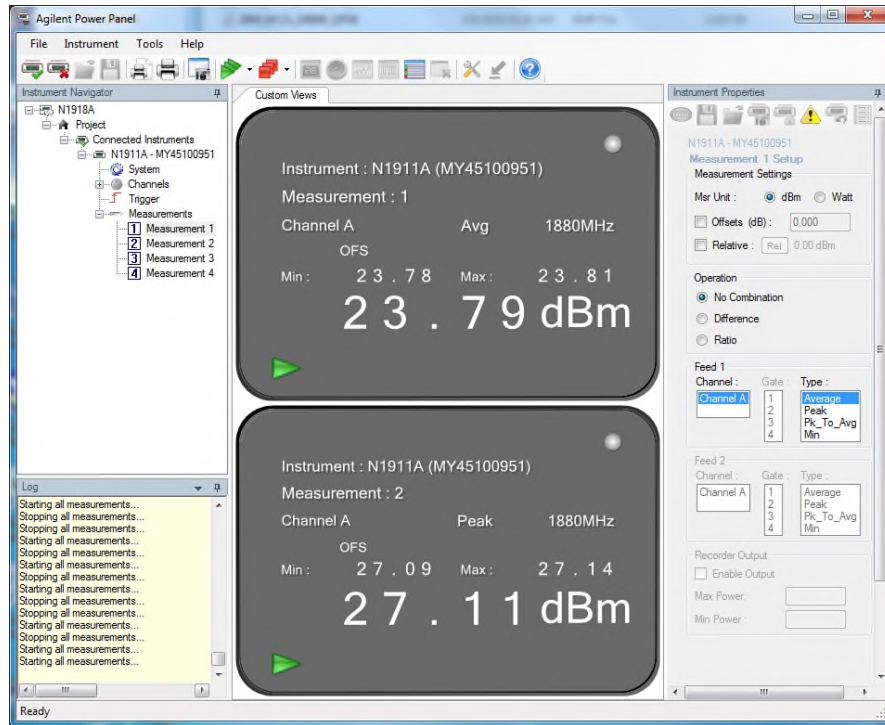

LTE Band 2_5M Bandwidth Middle Chanel QPSK 1 RB 12 offset

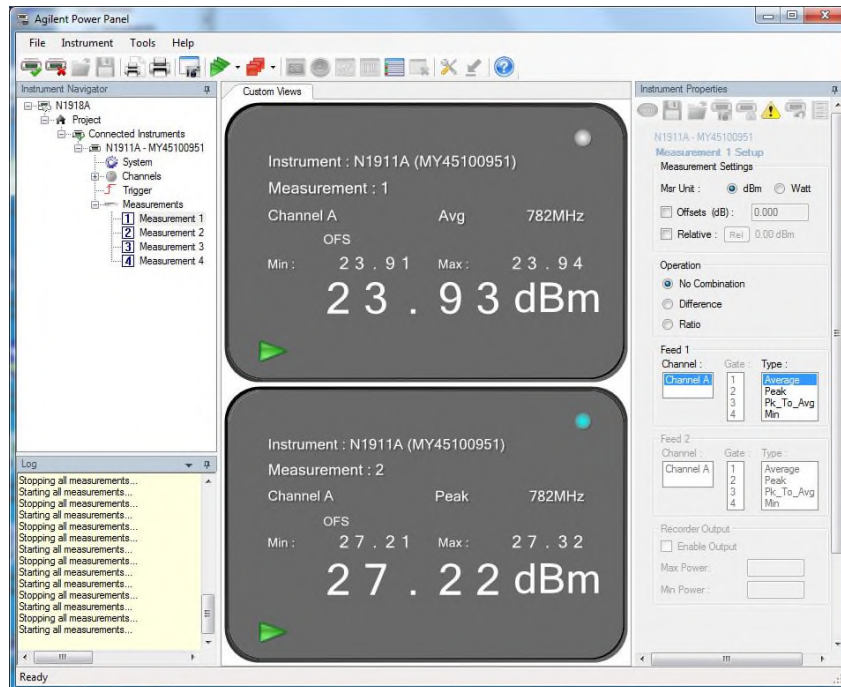

LTE Band 5_5M Bandwidth Middle Chanel QPSK 1 RB 12 offset



2.2 EFFECTIVE RADIATED POWER

2.2.1 Specification Reference

FCC 47 CFR Part 2, Clause 2.1046
FCC 47 CFR Part 22, Clause 22.913(a)(5)

2.2.2 Standard Applicable

FCC 47 CFR Part 22.913(a):
(5) The ERP of mobile transmitters and auxiliary test transmitters must not exceed 7 Watts.

2.2.3 Equipment Under Test and Modification State

Serial No: FF161218B00106 and FF130219B00478 / Test Configuration (N/A, calculation only)

2.2.4 Date of Test/Initial of test personnel who performed the test

March 05 and 06, 2019 / XYZ

2.2.5 Test Equipment Used

The major items of test equipment used for the above tests are identified in Section 3.1.

2.2.6 Additional Observations

- ERP was calculated as per Section 1.2 and 1.3 of KDB412172 D01 (Determining ERP and EIRP v01r01).
- Calculation formula in logarithmic terms:

$$\text{ERP} = P_T + G_T - L_c - 2.15\text{dB}$$

Where:

P_T = transmitter conducted output power dBm (Section 2.1 of this test report)

G_T = gain of the transmitting antenna, in dBi (EIRP: the -2.15 in the formula is to convert EIRP to ERP);

L_c = signal attenuation in the connecting cable between the transmitter and antenna, in dB (EUT configuration during verification is mounted on an interface board with short direct connection to the antenna port. The loss between the EUT and the antenna port is considered negligible).



2.2.7 Test Results

WCDMA Band 5						
Frequency (MHz)	Max Power Average (dBm)	Antenna Gain (dBi)	ERP			
			(dBm)	(mW)	ERP Limit (dBm)	Margin (dB)
826.4	23.22	0	21.07	127.94	38.45	17.38
836.6	23.24	0	21.09	128.53	38.45	17.36
846.6	23.13	0	20.98	125.31	38.45	17.47

LTE Band 5									
Modulation	Bandwidth (MHz)	RB Size/Offset	Channels	Frequency (MHz)	Tx Average Power (dBm)	Antenna Gain (dBi)	ERP (dBm)	Limit (dBm)	Margin (dBm)
QPSK	1.4	1 / 3	20407	824.7	23.72	0	21.57	38.45	16.88
		1 / 3	20525	836.5	23.88	0	21.73	38.45	16.72
		1 / 3	20643	848.3	23.45	0	21.30	38.45	17.15
	3	1 / 0	20415	825.5	23.65	0	21.50	38.45	16.95
		1 / 0	20525	836.5	23.86	0	21.71	38.45	16.74
		1 / 0	20635	847.5	23.53	0	21.38	38.45	17.07
	5	1 / 12	20425	826.5	23.83	0	21.68	38.45	16.77
		1 / 12	20525	836.5	23.93	0	21.78	38.45	16.67
		1 / 12	20625	846.5	23.56	0	21.41	38.45	17.04
	10	1 / 0	20450	829	23.90	0	21.75	38.45	16.7
		1 / 0	20525	836.5	23.96	0	21.81	38.45	16.64
		1 / 0	20600	844	23.96	0	21.81	38.45	16.64
16QAM	1.4	1 / 3	20407	824.7	22.76	0	20.61	38.45	17.84
		1 / 3	20525	836.5	22.91	0	20.76	38.45	17.69
		1 / 3	20643	848.3	22.54	0	20.39	38.45	18.06
	3	1 / 7	20415	825.5	22.89	0	20.74	38.45	17.71
		1 / 7	20525	836.5	23.10	0	20.95	38.45	17.5
		1 / 7	20635	847.5	22.68	0	20.53	38.45	17.92
	5	1 / 12	20425	826.5	23.03	0	20.88	38.45	17.57
		1 / 12	20525	836.5	22.99	0	20.84	38.45	17.61
		1 / 12	20625	846.5	22.83	0	20.68	38.45	17.77
	10	1 / 25	20450	829	23.02	0	20.87	38.45	17.58
		1 / 25	20525	836.5	23.13	0	20.98	38.45	17.47
		1 / 25	20600	844	23.05	0	20.90	38.45	17.55



2.3 EQUIVALENT ISOTROPIC RADIATED POWER

2.3.1 Specification Reference

FCC 47 CFR Part 2, Clause 2.1046
FCC 47 CFR Part 24, Clause 24.232(c)
RSS-132, Clause 5.4
RSS-133, Clause 6.4

2.3.2 Standard Applicable

FCC 47 CFR Part 24.232:
(c) Mobile and portable stations are limited to 2 watts EIRP and the equipment must employ a means for limiting power to the minimum necessary for successful communications.

RSS-132, Clause 5.4:
The EIRP for mobile equipment shall not exceed 11.5 watts

RSS-133, Clause 6.4:
The equivalent isotropically radiated power (e.i.r.p.) for Mobile stations and hand-held portables are limited to 2 watts maximum e.i.r.p.

2.3.3 Equipment Under Test and Modification State

Serial No: FF161218B00106 and FF130219B00478 / Test Configuration A

2.3.4 Date of Test/Initial of test personnel who performed the test

March 05 and 06, 2019 / XYZ

2.3.5 Test Equipment Used

The major items of test equipment used for the above tests are identified in Section 3.1.

2.3.6 Additional Observations

- EIRP was calculated as per Section 1.2 and 1.3 of KDB412172 D01 (Determining ERP and EIRP v01r01).
- Calculation formula in logarithmic terms:

$$\text{EIRP} = P_T + G_T - L_c$$

Where:

P_T = transmitter conducted output power dBm (Section 2.1 of this test report)
 G_T = gain of the transmitting antenna, in dBi (EIRP);
 L_c = signal attenuation in the connecting cable between the transmitter and antenna, in dB (EUT poses an internal Antenna. The loss between the EUT and the antenna port is considered negligible).



2.3.7 Test Results

WCDMA Band 2						
Frequency (MHz)	Max Power Average (dBm)	Antenna Gain (dBi)	EIRP			
			(dBm)	(mW)	Limit (dBm)	Margin (dB)
1852.4	23.38	1.9	25.28	337.29	33	7.72
1880.0	23.83	1.9	25.73	374.11	33	7.27
1907.6	23.92	1.9	25.82	381.94	33	7.18

WCDMA Band 5						
Frequency (MHz)	Max Power Average (dBm)	Antenna Gain (dBi)	EIRP			
			(dBm)	(mW)	EIRP Limit (dBm)	Margin (dB)
826.4	23.22	0	23.22	209.89	40.61	17.39
836.6	23.24	0	23.24	210.86	40.61	17.37
846.6	23.13	0	23.13	205.59	40.61	17.48



LTE Band 2									
Modulation	Bandwidth (MHz)	RB Size/Offset	Channels	Frequency (MHz)	Tx Average Power (dBm)	Antenna Gain (dBi)	EIRP (dBm)	Limit (dBm)	Margin (dBm)
QPSK	1.4	1 / 3	18607	1850.7	22.78	1.9	24.68	33	8.32
		1 / 3	18900	1880.0	23.72	1.9	25.62	33	7.38
		1 / 3	19193	1909.3	22.35	1.9	24.25	33	8.75
	3	1 / 7	18615	1851.5	22.78	1.9	24.68	33	8.32
		1 / 7	18900	1880.0	23.80	1.9	25.70	33	7.3
		1 / 7	19185	1908.5	22.68	1.9	24.58	33	8.42
	5	1 / 12	18625	1852.5	22.74	1.9	24.64	33	8.36
		1 / 12	18900	1880.0	23.79	1.9	25.69	33	7.31
		1 / 12	19175	1907.5	22.92	1.9	24.82	33	8.18
	10	1 / 25	18650	1855.0	22.64	1.9	24.54	33	8.46
		1 / 25	18900	1880.0	23.76	1.9	25.66	33	7.34
		1 / 25	19150	1905.0	22.94	1.9	24.84	33	8.16
	15	1 / 37	18675	1857.5	22.62	1.9	24.52	33	8.48
		1 / 37	18900	1880.0	23.80	1.9	25.70	33	7.3
		1 / 37	19125	1902.5	22.51	1.9	24.41	33	8.59
	20	1 / 49	18700	1860.0	22.77	1.9	24.67	33	8.33
		1 / 49	18900	1880.0	23.84	1.9	25.74	33	7.26
		1 / 49	19100	1900.0	22.17	1.9	24.07	33	8.93
16QAM	1.4	1 / 3	18607	1850.7	21.98	1.9	23.88	33	9.12
		1 / 3	18900	1880.0	22.82	1.9	24.72	33	8.28
		1 / 3	19193	1909.3	21.36	1.9	23.26	33	9.74
	3	1 / 7	18615	1851.5	21.99	1.9	23.89	33	9.11
		1 / 7	18900	1880.0	22.91	1.9	24.81	33	8.19
		1 / 7	19185	1908.5	21.89	1.9	23.79	33	9.21
	5	1 / 12	18625	1852.5	22.07	1.9	23.97	33	9.03
		1 / 12	18900	1880.0	23.02	1.9	24.92	33	8.08
		1 / 12	19175	1907.5	22.06	1.9	23.96	33	9.04
	10	1 / 25	18650	1855.0	21.83	1.9	23.73	33	9.27
		1 / 25	18900	1880.0	22.85	1.9	24.75	33	8.25
		1 / 25	19150	1905.0	22.10	1.9	24.0	33	9
	15	1 / 37	18675	1857.5	21.84	1.9	23.74	33	9.26
		1 / 37	18900	1880.0	22.87	1.9	24.77	33	8.23
		1 / 37	19125	1902.5	21.66	1.9	23.56	33	9.44
	20	1 / 49	18700	1860.0	22.04	1.9	23.94	33	9.06
		1 / 49	18900	1880.0	22.91	1.9	24.81	33	8.19
		1 / 49	19100	1900.0	21.24	1.9	23.14	33	9.86



LTE Band 5									
Modulation	Bandwidth (MHz)	RB Size/Offset	Channels	Frequency (MHz)	Tx Average Power (dBm)	Antenna Gain (dBi)	EIRP (dBm)	Limit (dBm)	Margin (dBm)
QPSK	1.4	1 / 3	20407	824.7	23.72	0	23.72	40.61	16.89
		1 / 3	20525	836.5	23.88	0	23.88	40.61	16.73
		1 / 3	20643	848.3	23.45	0	23.45	40.61	17.16
	3	1 / 0	20415	825.5	23.65	0	23.65	40.61	16.96
		1 / 0	20525	836.5	23.86	0	23.86	40.61	16.75
		1 / 0	20635	847.5	23.53	0	23.53	40.61	17.08
	5	1 / 12	20425	826.5	23.83	0	23.83	40.61	16.78
		1 / 12	20525	836.5	23.93	0	23.93	40.61	16.68
		1 / 12	20625	846.5	23.56	0	23.56	40.61	17.05
	10	1 / 0	20450	829	23.90	0	23.90	40.61	16.71
		1 / 0	20525	836.5	23.96	0	23.96	40.61	16.65
		1 / 0	20600	844	23.96	0	23.96	40.61	16.65
16QAM	1.4	1 / 3	20407	824.7	22.76	0	22.76	40.61	17.85
		1 / 3	20525	836.5	22.91	0	22.91	40.61	17.7
		1 / 3	20643	848.3	22.54	0	22.54	40.61	18.07
	3	1 / 7	20415	825.5	22.89	0	22.89	40.61	17.72
		1 / 7	20525	836.5	23.10	0	23.10	40.61	17.51
		1 / 7	20635	847.5	22.68	0	22.68	40.61	17.93
	5	1 / 12	20425	826.5	23.03	0	23.03	40.61	17.58
		1 / 12	20525	836.5	22.99	0	22.99	40.61	17.62
		1 / 12	20625	846.5	22.83	0	22.83	40.61	17.78
	10	1 / 25	20450	829	23.02	0	23.02	40.61	17.59
		1 / 25	20525	836.5	23.13	0	23.13	40.61	17.48
		1 / 25	20600	844	23.05	0	23.05	40.61	17.56



2.4 PEAK-AVERAGE RATIO

2.4.1 Specification Reference

FCC 47 CFR Part 24, Clause 24.232 (d)
RSS-133, Clause 6.4
RSS-132, Clause 5.4

2.4.2 Standard Applicable

FCC 47 CFR Part 24.232:

(d) Power measurements for transmissions by stations authorized under this section may be made either in accordance with a Commission-approved average power technique or in compliance with paragraph (e) of this section. In both instances, equipment employed must be authorized in accordance with the provisions of §24.51. In measuring transmissions in this band using an average power technique, the peak-to-average ratio (PAR) of the transmission may not exceed 13dB.

RSS-132 and RSS-133:

The transmitter's peak-to-average power ratio (PAPR) shall not exceed 13 dB for more than 0.1% of the time using a signal corresponding to the highest PAPR during periods of continuous transmission.

2.4.3 Equipment Under Test and Modification State

Serial No: FF161218B00106 and FF130219B00478 / Test Configuration A

2.4.4 Date of Test/Initial of test personnel who performed the test

March 04 and 06, 2019 / XYZ

2.4.5 Test Equipment Used

The major items of test equipment used for the above tests are identified in Section 3.1.

2.4.6 Environmental Conditions/ Test Location

Test performed at TÜV SÜD America Inc. Rancho Bernardo facility

Ambient Temperature	22.1 - 22.3°C
Relative Humidity	48.8 - 50.5%
ATM Pressure	99.1 - 99.3 kPa



2.4.7 Additional Observations

- This is a conducted test.
- As per FCC KDB 971168 D01 v03r01 clause 5.7, the PAPR was measured in accordance with ANSI C63.26 clause 5.2.3.4.
- Measurement was done using the Spectrum Analyzer's Complementary Cumulative Distribution Function (CCDF) measurement profile. The built-in function is used to determine the largest deviation between the average and the peak power of the EUT in a given bandwidth (crest factor or peak-to-average ratio) The CCDF curve shows how much time the peak waveform spends at or above a given average power level. The percent of time the signals spends at or above the level defines the probability for that particular power level. For GSM signals, an average and a peak trace are used to determine the largest deviation between the average and the peak power of the EUT in a bandwidth greater than the emission bandwidth.
- Low, Middle and High channels for all bandwidths and modulations were verified.
- The path loss for was measured and entered as a level offset.
- There are no measured PAPR levels greater than 13dB. EUT complies.

2.4.8 Test Results

WCDMA				
Band	Channels	Frequency (MHz)	PAR (dB)	Limit for PAR (dB)
2	9262	1852.4	3.27	13
	9400	1880	3.48	13
	9538	1907.6	3.02	13
5	4132	826.4	3.08	13
	4183	836.6	3.39	13
	4233	846.6	3.22	13



LTE Band 2					
Modulation	Bandwidth (MHz)	Channels	Frequency (MHz)	PAR (dB)	Limit for PAR (dB)
QPSK	1.4	18607	1850.7	4.03	13
		18900	1880	4.38	13
		19193	1909.3	4.40	13
	3	18615	1851.5	3.99	13
		18900	1880	4.37	13
		19185	1908.5	4.49	13
	5	18625	1852.5	4.02	13
		18900	1880	4.46	13
		19175	1907.5	4.54	13
	10	18650	1855	4.40	13
		18900	1880	4.55	13
		19150	1905	4.84	13
	15	18675	1857.5	4.74	13
		18900	1880	4.83	13
		19125	1902.5	5.0	13
20	18700	1860	4.83	13	
	18900	1880	4.85	13	
	19100	1900	5.74	13	
16QAM	1.4	18607	1850.7	4.93	13
		18900	1880	5.40	13
		19193	1909.3	5.37	13
	3	18615	1851.5	4.97	13
		18900	1880	5.39	13
		19185	1908.5	5.57	13
	5	18625	1852.5	4.96	13
		18900	1880	5.45	13
		19175	1907.5	5.61	13
	10	18650	1855	5.25	13
		18900	1880	5.69	13
		19150	1905	5.84	13
	15	18675	1857.5	5.64	13
		18900	1880	5.84	13
		19125	1902.5	6.11	13
20	18700	1860	5.78	13	
	18900	1880	6.13	13	
	19100	1900	6.76	13	



LTE Band 5					
Modulation	Bandwidth (MHz)	Channels	Frequency (MHz)	PAR (dB)	Limit for PAR (dB)
QPSK	1.4	20407	824.7	4.82	13
		20525	836.5	4.86	13
		20643	848.3	4.33	13
	3	20415	825.5	4.08	13
		20525	836.5	4.96	13
		20635	847.5	4.39	13
	5	20425	826.5	4.38	13
		20525	836.5	4.91	13
		20625	846.5	4.79	13
	10	20450	829	5.30	13
		20525	836.5	5.27	13
		20600	844	5.51	13
16QAM	1.4	20407	824.7	5.79	13
		20525	836.5	5.96	13
		20643	848.3	5.33	13
	3	20415	825.5	5.16	13
		20525	836.5	5.90	13
		20635	847.5	5.52	13
	5	20425	826.5	5.38	13
		20525	836.5	5.99	13
		20625	846.5	5.69	13
	10	20450	829	6.35	13
		20525	836.5	6.34	13
		20600	844	6.45	13

2.4.9 Example Test Plots

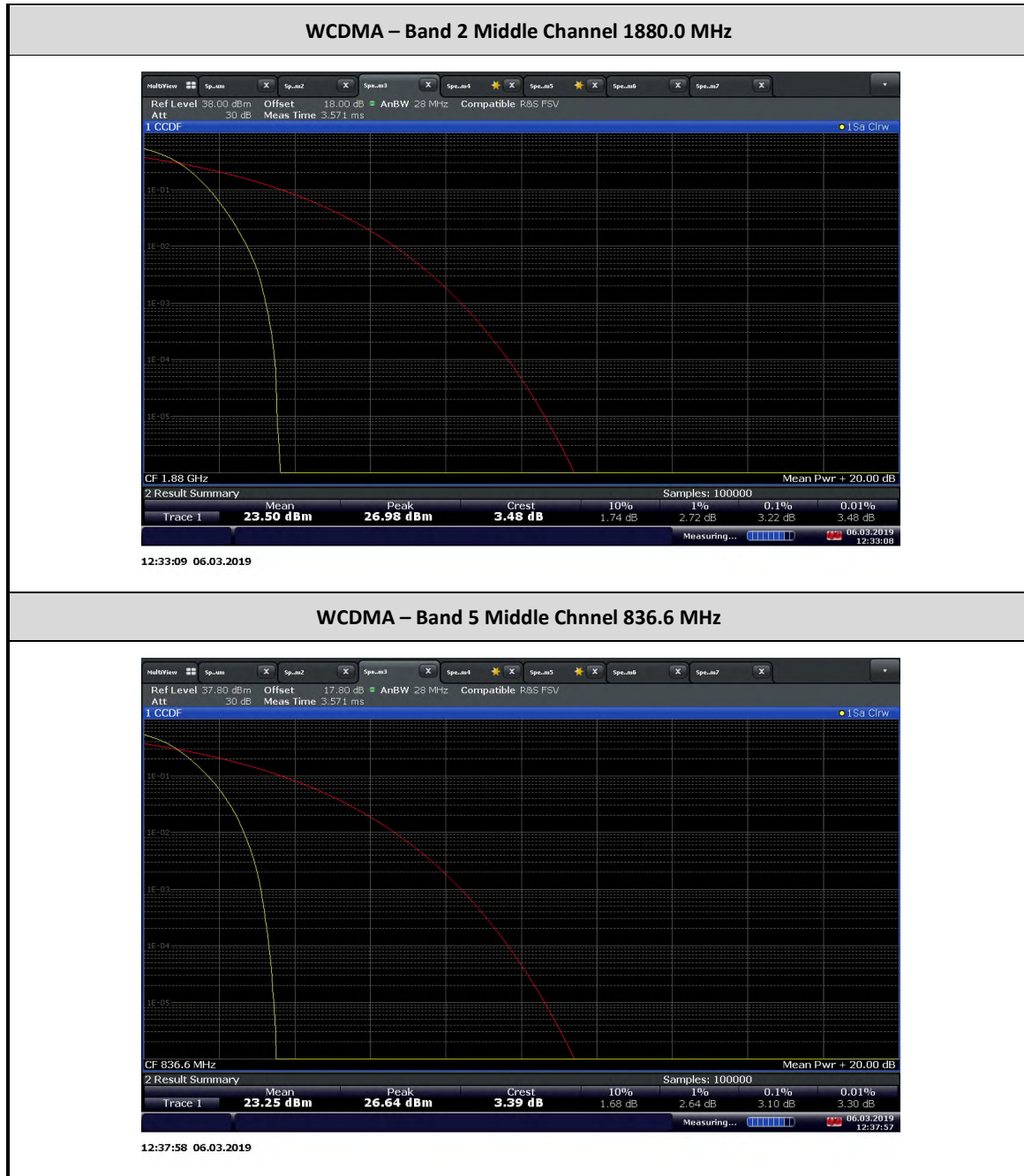



LTE Band 2 (1.4 MHz BW) / Middle Channel 1880 MHz / QPSK



11:34:19 04.03.2019

LTE Band 2 (1.4 MHz BW) / Middle Channel 1880 MHz / 16QAM



11:34:43 04.03.2019



LTE Band 2 (3 MHz BW) / Middle Channel 1880 MHz / QPSK



11:32:56 04.03.2019

LTE Band 2 (3 MHz BW) / Middle Channel 1880 MHz / 16QAM



11:33:28 04.03.2019



LTE Band 2 (5 MHz BW) / Middle Channel 1880 MHz / QPSK



11:31:04 04.03.2019

LTE Band 2 (5 MHz BW) / Middle Channel 1880 MHz / 16QAM



11:32:03 04.03.2019



LTE Band 2 (10 MHz BW) / Middle Channel 1880 MHz / QPSK

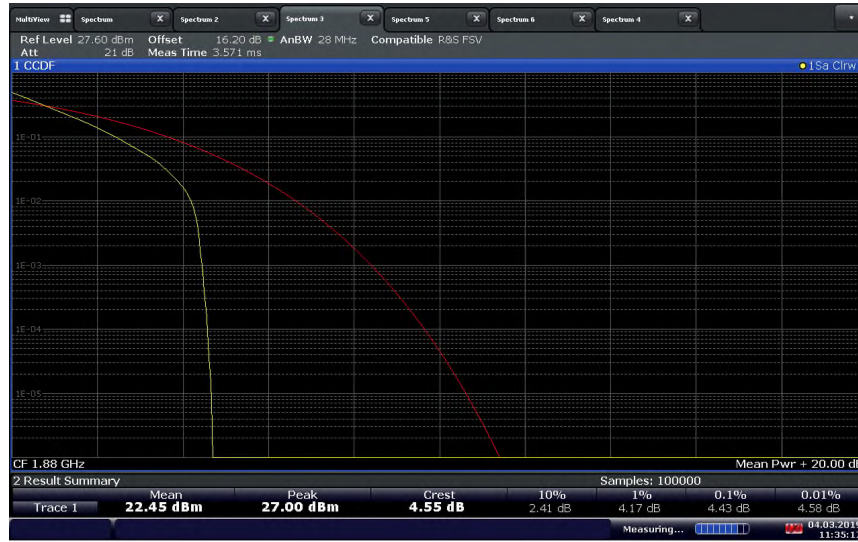

11:35:18 04.03.2019

LTE Band 2 (10 MHz BW) / Middle Channel 1880 MHz / 16QAM



11:35:48 04.03.2019



LTE Band 2 (15 MHz BW) / Middle Channel 1880 MHz / QPSK



11:38:45 04.03.2019

LTE Band 2 (15 MHz BW) / Middle Channel 1880 MHz / 16QAM



11:39:13 04.03.2019



LTE Band 2 (20 MHz BW) / Middle Channel 1880 MHz / QPSK



11:40:06 04.03.2019

LTE Band 2 (20 MHz BW) / Middle Channel 1880 MHz / 16QAM



11:40:40 04.03.2019



LTE Band 5 (1.4 MHz BW) / Middle Channel 836.5 MHz / QPSK



12:11:03 04.03.2019

LTE Band 5 (1.4 MHz BW) / Middle Channel 836.5 MHz / 16QAM



12:11:58 04.03.2019



LTE Band 5 (3 MHz BW) / Middle Channel 836.5 MHz / QPSK



12:12:33 04.03.2019

LTE Band 5 (3 MHz BW) / Middle Channel 836.5 MHz / 16QAM



12:16:21 04.03.2019



LTE Band 5 (5 MHz BW) / Middle Channel 836.5 MHz / QPSK



12:13:31 04.03.2019

LTE Band 5 (5 MHz BW) / Middle Channel 836.5 MHz / 16QAM



12:15:53 04.03.2019



LTE Band 5 (10 MHz BW) / Middle Channel 836.5 MHz / QPSK

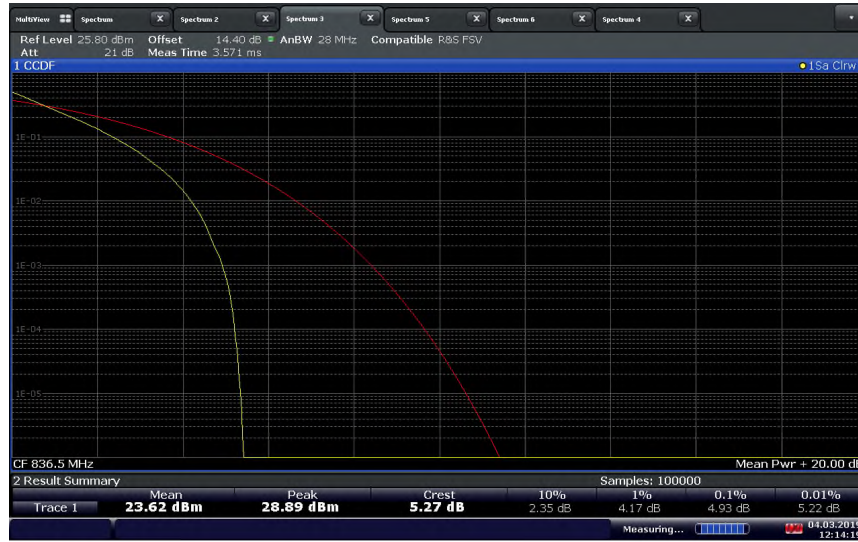

12:14:19 04.03.2019

LTE Band 5 (10 MHz BW) / Middle Channel 836.5 MHz / 16QAM



12:14:48 04.03.2019



2.5 OCCUPIED BANDWIDTH

2.5.1 Specification Reference

FCC 47 CFR Part 2, Clause 2.1049
FCC 47 CFR Part 22, Clause 22.917(b)
FCC 47 CFR Part 24, Clause 24.238(b)
RSS-132, Clause 5.5
RSS-133, Clause 6.5
RSS-GEN, Clause 6.7

2.5.2 Standard Applicable

The transmitted signal bandwidth shall be reported as the 99% emission bandwidth, that is the frequency bandwidth such that, below its lower and above its upper frequency limits, the mean powers radiated are each equal to 0.5 percent of the total mean power radiated by a given emission.

26dB Bandwidth is defined as the width of the signal between two points, one below the carrier center frequency and one above the carrier center frequency, outside of which all emissions are attenuated by at least 26 dB below the transmitter power.

2.5.3 Equipment Under Test and Modification State

Serial No: FF161218B00106 / Test Configuration A

2.5.4 Date of Test/Initial of test personnel who performed the test

March 04 and 06, 2019 / XYZ

2.5.5 Test Equipment Used

The major items of test equipment used for the above tests are identified in Section 3.1.

2.5.6 Environmental Conditions/ Test Location

Test performed at TÜV SÜD America Inc. Rancho Bernardo facility

Ambient Temperature	22.1 - 22.3°C
Relative Humidity	48.8 - 50.5%
ATM Pressure	99.1 - 99.3kPa



2.5.7 Additional Observations

- This is a conducted test. Both 26dB bandwidth and 99% bandwidth presented.
- Using the occupied bandwidth measurement function in the spectrum analyzer, the 99% occupied bandwidth was measured.
- The 26dB bandwidth was measured in accordance with ANSI C63.26 clause 5.4.3 using the ndB measurement function in the spectrum analyzer.
- The transmitter shall be operated at its maximum carrier power measured under normal test conditions.
- The span of the analyzer shall be set to capture all products of the modulation process, including the emission skirts.
- The resolution bandwidth (RBW) shall be in the range of 1% of the occupied bandwidth (OBW) and video bandwidth (VBW) shall be at least 3x RBW.
- Low, Mid and High channels for all bandwidths and modulations were verified. Test results of Mid channel were presented as representative.

2.5.8 Test Results

WCDMA				
Band	Channel	Frequency	99% OBW (MHz)	26dB BW (MHz)
Band 2	9400	1880.0	4.14	4.70
Band 5	4183	836.6	4.13	4.66

LTE Band 2					
Modulation	Bandwidth (MHz)	Channel	Frequency	99% OBW (MHz)	26dB BW (MHz)
QPSK	1.4	18900	1880.0	1.09	1.23
	3			2.70	2.95
	5			4.49	4.91
	10			8.97	9.77
	15			13.46	14.72
	20			17.90	19.10
16QAM	1.4	18900	1880.0	1.09	1.23
	3			2.69	2.95
	5			4.87	4.91
	10			8.97	9.72
	15			13.46	14.59
	20			17.97	19.10



LTE Band 5					
Modulation	Bandwidth (MHz)	Channel	Frequency	99% OBW (MHz)	26dB BW (MHz)
QPSK	1.4	20525	836.5	1.09	1.24
	3			2.69	2.97
	5			4.48	4.93
	10			8.94	9.72
16QAM	1.4	20525	836.5	1.09	1.22
	3			2.69	2.97
	5			4.48	4.93
	10			8.96	9.63



2.5.9 Example Test Plots

WCDMA Band 2 / Middle Channel 1880 MHz / 99% OBW

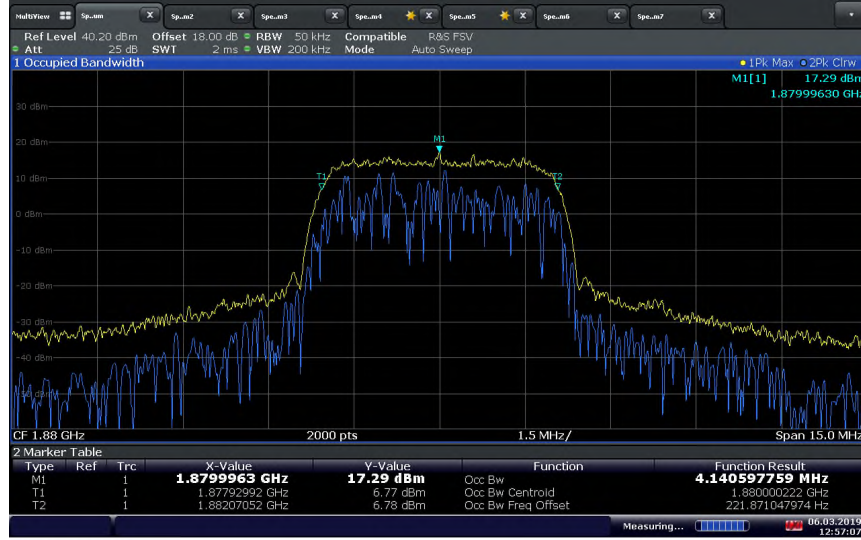

12:57:08 06.03.2019

WCDMA Band 2 / Middle Channel 1880 MHz / 26dB BW

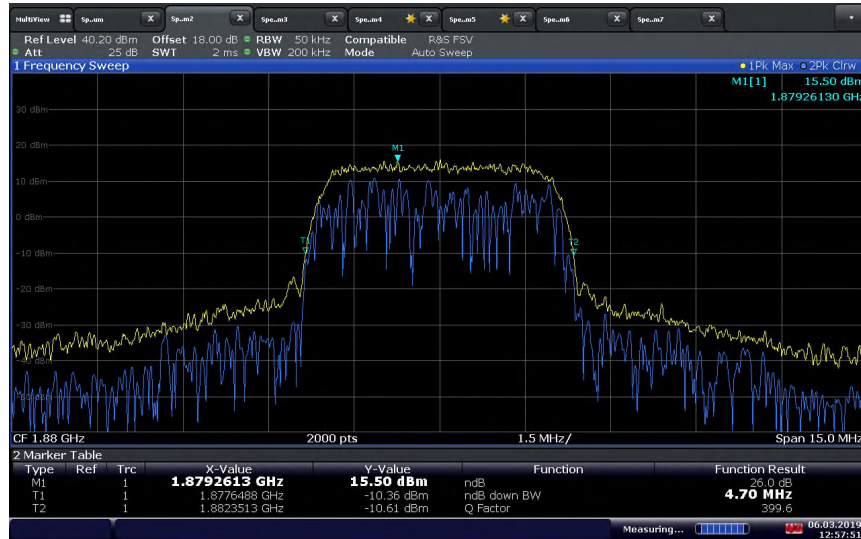

12:57:51 06.03.2019



WCDMA Band 5 / Middle Channel 836.6 MHz /99% OBW

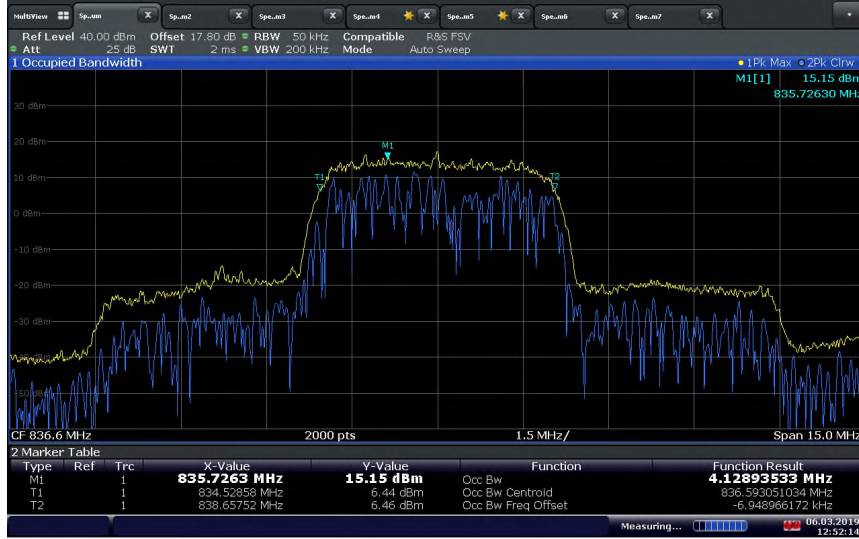

12:52:15 06.03.2019

WCDMA Band 5 / Middle Channel 836.6 MHz / 26dB OBW



12:51:53 06.03.2019



LTE Band 2 (5 MHz BW) / Middle Channel 1880 MHz / QPSK / 99% OBW

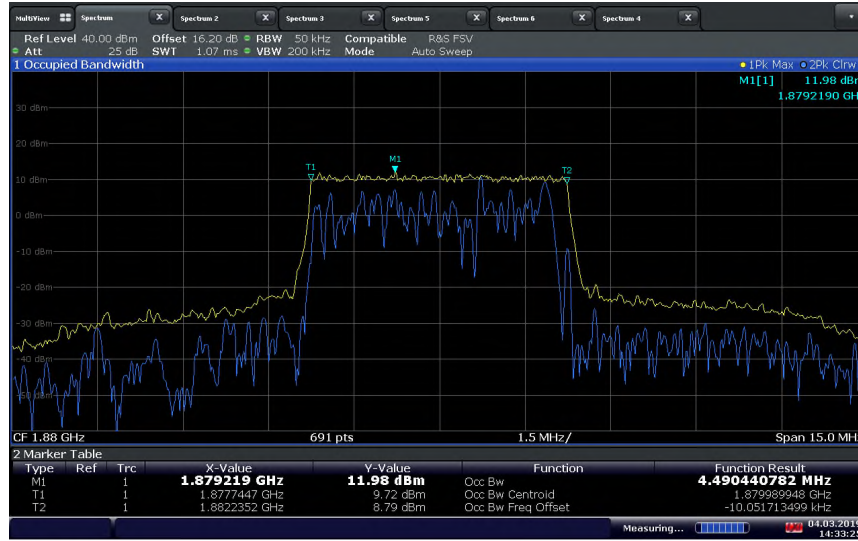

14:33:25 04.03.2019

LTE Band 2 (5 MHz BW) / Middle Channel 1880 MHz / QPSK / 26dB BW



14:33:58 04.03.2019



LTE Band 5 (5 MHz BW) / Middle Channel 836.5 MHz / QPSK / 99% OBW



13:29:41 04.03.2019

LTE Band 5 (5 MHz BW) / Middle Channel 836.5 MHz / QPSK / 26dB BW



13:30:15 04.03.2019