



# FCC RADIO TEST REPORT

**FCC ID** : PKRISGFX31001  
**Equipment** : Indoor Router  
**Brand Name** : Inseego  
**Model Name** : FX3100-1  
**Marketing Name** : FX3100  
**Applicant** : INSEEGO CORP.  
9710 Scranton Road Suite 200, San Diego, CA 92121  
**Manufacturer** : INSEEGO CORP.  
9710 Scranton Road Suite 200, San Diego, CA 92121  
**Standard** : FCC 47 CFR Part 2, 27

The product was received on Mar. 03, 2023 and testing was performed from Apr. 19, 2023 to Apr. 21, 2023. We, Sporton International Inc. EMC & Wireless Communications Laboratory, would like to declare that the tested sample has been evaluated in accordance with the test procedures given in ANSI / TIA-603-E and has been in compliance with the applicable technical standards.

The test results in this partial report apply exclusively to the tested model / sample. Without written approval of Sporton International Inc. EMC & Wireless Communications Laboratory, the test report shall not be reproduced except in full.

Louis Wu

Approved by: Louis Wu

**Sporton International Inc. EMC & Wireless Communications Laboratory**

No. 52, Huaya 1st Rd., Guishan Dist., Taoyuan City 333, Taiwan (R.O.C.)



## Table of Contents

<b>History of this test report.....</b>	<b>3</b>
<b>Summary of Test Result.....</b>	<b>4</b>
<b>1 General Description .....</b>	<b>5</b>
1.1 Product Feature of Equipment Under Test.....	5
1.2 Modification of EUT .....	5
1.3 Testing Location .....	6
1.4 Applicable Standards.....	6
<b>2 Test Configuration of Equipment Under Test .....</b>	<b>7</b>
2.1 Test Mode.....	7
2.2 Connection Diagram of Test System.....	8
2.3 Support Unit used in test configuration and system .....	8
2.4 Measurement Results Explanation Example.....	8
2.5 Frequency List of Low/Middle/High Channels .....	9
<b>3 Conducted Test Items.....</b>	<b>10</b>
3.1 Measuring Instruments .....	10
3.2 Conducted Output Power and EIRP .....	11
3.3 Peak-to-Average Ratio .....	12
3.4 Occupied Bandwidth.....	13
3.5 Conducted Band Edge .....	14
3.6 Conducted Spurious Emission .....	15
3.7 Frequency Stability .....	16
<b>4 Radiated Test Items .....</b>	<b>17</b>
4.1 Measuring Instruments .....	17
4.2 Radiated Spurious Emission Measurement .....	19
<b>5 List of Measuring Equipment.....</b>	<b>20</b>
<b>6 Measurement Uncertainty .....</b>	<b>21</b>
<b>Appendix A. Test Results of Conducted Test</b>	
<b>Appendix B. Test Results of Radiated Test</b>	
<b>Appendix C. Test Setup Photographs</b>	





## Summary of Test Result

Report Clause	Ref Std. Clause	Test Items	Result (PASS/FAIL)	Remark
3.2	§2.1046	Conducted Output Power	Reporting only	-
	§27.50 (k)(3)	Equivalent Isotropic Radiated Power (n77)	Pass	
3.3	§27.50 (k)(4)	Peak-to-Average Ratio	Pass	-
3.4	§2.1049	Occupied Bandwidth	Reporting only	-
3.5	§2.1051	Conducted Band Edge Measurement (n77)	Pass	-
	§27.53 (n)(2)			
3.6	§2.1051	Conducted Spurious Emission (n77)	Pass	-
	§27.53 (n)(2)			
3.7	§2.1055	Frequency Stability Temperature & Voltage	Pass	-
	§27.54			
4.2	§2.1053 §27.53 (n)(2)	Radiated Spurious Emission (n77)	Pass	17.75 dB under the limit at 13803.000 MHz

**Conformity Assessment Condition:**

1. The test results (PASS/FAIL) with all measurement uncertainty excluded are presented against the regulation limits or in accordance with the requirements stipulated by the applicant/manufacturer who shall bear all the risks of non-compliance that may potentially occur if measurement uncertainty is taken into account.
2. The measurement uncertainty please refer to each test result in the section " Measurement Uncertainty ".

**Disclaimer:**

The product specifications of the EUT presented in the test report that may affect the test assessments are declared by the manufacturer who shall take full responsibility for the authenticity.

**Reviewed by: Lewis Ho**

**Report Producer: Rachel Hsieh**



# 1 General Description

## 1.1 Product Feature of Equipment Under Test

Product Feature	
<b>General Specs</b> 4G-LTE, 5G-FR1, Wi-Fi 2.4GHz 802.11 b/g/n/ax, Wi-Fi 5GHz 802.11 a/n/ac/ax, and GNSS.	
<b>Antenna Type</b> WWAN: Fixed Internal Antenna WLAN: Fixed Internal Antenna GPS / Glonass / BDS / Galileo: Fixed Internal Antenna	

Antenna information		
<b>5G FR1 n77</b>	Peak Gain (dBi)	<Ant. 4>: 1.5 <Ant. 6>: 3.5

**Remark:** The EUT's information above is declared by manufacturer. Please refer to Disclaimer in report summary.

## 1.2 Modification of EUT

No modifications are made to the EUT during all test items.



### 1.3 Testing Location

<b>Test Site</b>	Sporton International Inc. EMC & Wireless Communications Laboratory
<b>Test Site Location</b>	No.52, Huaya 1st Rd., Guishan Dist., Taoyuan City 333, Taiwan (R.O.C.) TEL: +886-3-327-3456 FAX: +886-3-328-4978
<b>Test Site No.</b>	<b>Sporton Site No.</b>
	TH03-HY
<b>Test Engineer</b>	George Chen
<b>Temperature (°C)</b>	21~24
<b>Relative Humidity (%)</b>	52~58

<b>Test Site</b>	Sporton International Inc. Wensan Laboratory.
<b>Test Site Location</b>	No.58, Aly. 75, Ln. 564, Wenhua 3rd, Rd., Guishan Dist., Taoyuan City 333010, Taiwan (R.O.C.) TEL: +886-3-327-0868 FAX: +886-3-327-0855
<b>Test Site No.</b>	<b>Sporton Site No.</b>
	03CH12-HY (TAF Code: 3786)
<b>Test Engineer</b>	Jesse Fan, Tim Lee and Wilson Wu
<b>Temperature (°C)</b>	20~25
<b>Relative Humidity (%)</b>	50~60
<b>Remark</b>	The Radiated Spurious Emission test item subcontracted to Sporton International Inc. Wensan Laboratory.

**Note:** The test site complies with ANSI C63.4 2014 requirement.

FCC Designation No.: TW1190 and TW3786

### 1.4 Applicable Standards

According to the specifications of the manufacturer, the EUT must comply with the requirements of the following standards:

- ♦ ANSI C63.26-2015
- ♦ ANSI / TIA-603-E
- ♦ FCC 47 CFR Part 2, 27
- ♦ FCC KDB 971168 D01 Power Meas. License Digital Systems v03r01
- ♦ FCC KDB 412172 D01 Determining ERP and EIRP v01r01
- ♦ FCC KDB 414788 D01 Radiated Test Site v01r01
- ♦ FCC KDB 662911 D01 Multiple Transmitter Output v02r01.

**Remark:**

1. All test items were verified and recorded according to the standards and without any deviation during the test.
2. This EUT has also been tested and complied with the requirements of FCC Part 15, Subpart B, recorded in a separate test report.
3. The TAF code is not including all the FCC KDB listed without accreditation..



## 2.2 Connection Diagram of Test System

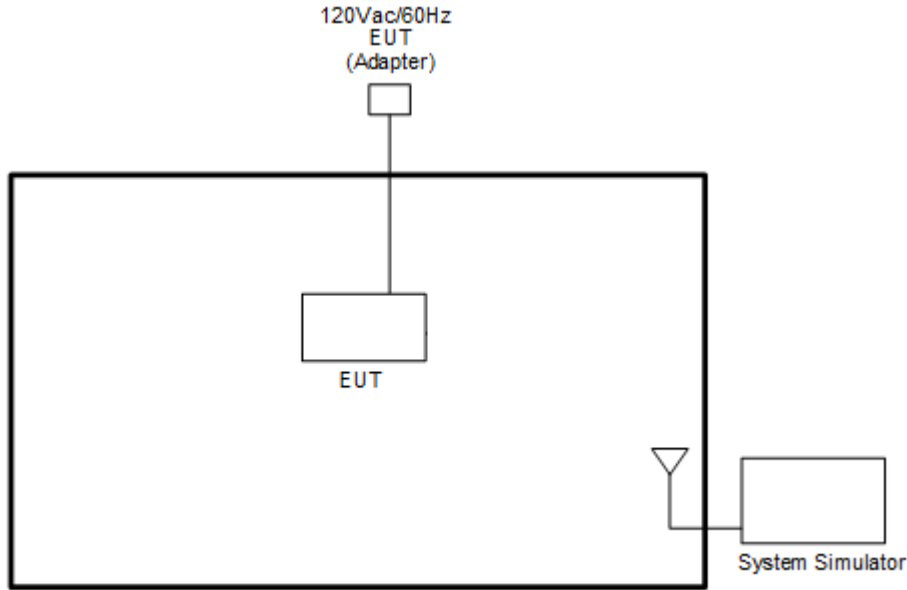

## 2.3 Support Unit used in test configuration and system

Item	Equipment	Brand Name	Model No.	FCC ID	Data Cable	Power Cord
1.	5G Wireless Test Platform	Anritsu	MT8000A	N/A	N/A	Unshielded, 1.8 m
2.	System Simulator	Anritsu	MT8821C	N/A	N/A	Unshielded, 1.8 m

## 2.4 Measurement Results Explanation Example

### For all conducted test items:

The offset level is set in the spectrum analyzer to compensate the RF cable loss and attenuator factor between EUT conducted output port and spectrum analyzer. With the offset compensation, the spectrum analyzer reading level is exactly the EUT RF output level.

The spectrum analyzer offset is derived from RF cable loss and attenuator factor.

*Offset = RF cable loss + attenuator factor.*

Following shows an offset computation example with cable loss 4.2 dB and 10dB attenuator.

Example :

*Offset(dB) = RF cable loss(dB) + attenuator factor(dB).*

$$= 4.2 + 10 = 14.2 \text{ (dB)}$$





### 2.5 Frequency List of Low/Middle/High Channels

5G FR1 Band n77 Channel and Frequency List				
BW [MHz]	Channel/Frequency(MHz)	Lowest	Middle	Highest
100	Channel	-	633334	-
	Frequency	-	3500.01	-
90	Channel	633000	633334	633666
	Frequency	3495	3500.01	3504.99
80	Channel	632668	633334	634000
	Frequency	3490.02	3500.01	3510
70	Channel	632334	633334	634332
	Frequency	3485.01	3500.01	3514.98
60	Channel	632000	633334	634666
	Frequency	3480	3500.01	3519.99
50	Channel	631668	633334	635000
	Frequency	3475.02	3500.01	3525
40	Channel	631334	633334	635332
	Frequency	3470.01	3500.01	3529.98
30	Channel	631000	633334	635666
	Frequency	3465	3500.01	3534.99
20	Channel	630668	633334	636000
	Frequency	3460.02	3500.01	3540
15	Channel	630500	633334	636166
	Frequency	3457.5	3500.01	3542.49
10	Channel	630334	633334	636332
	Frequency	3455.01	3500.01	3544.98

### 3 Conducted Test Items

#### 3.1 Measuring Instruments

See list of measuring instruments of this test report.

##### 3.1.1 Test Setup

##### 3.1.2 Conducted Output Power



##### 3.1.3 Peak-to-Average Ratio, Occupied Bandwidth ,Conducted Band-Edge and Conducted Spurious Emission

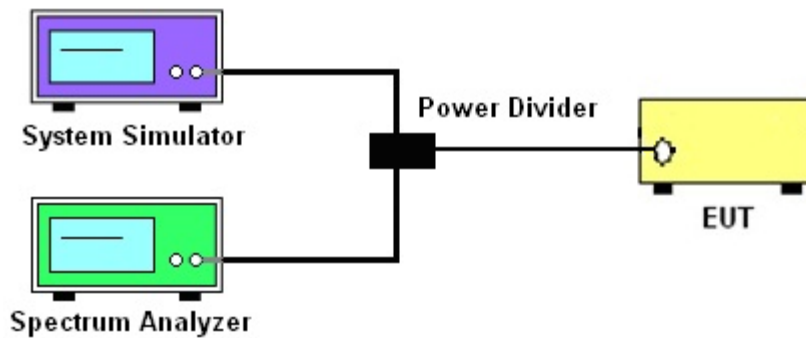

##### 3.1.4 Frequency Stability

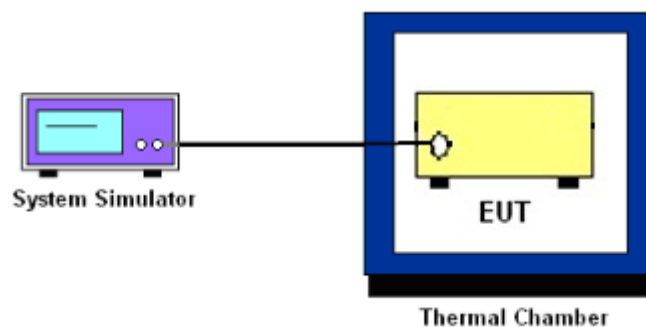

##### 3.1.5 Test Result of Conducted Test

Please refer to Appendix A.



## 3.2 Conducted Output Power and EIRP

### 3.2.1 Description of the Conducted Output Power Measurement and EIRP Measurement

A system simulator was used to establish communication with the EUT. Its parameters were set to force the EUT transmitting at maximum output power. The measured power in the radio frequency on the transmitter output terminals shall be reported.

The EIRP of mobile transmitters must not exceed 1 Watts for 5G FR1 n77

According to KDB 412172 D01 Power Approach,

$EIRP = P_T + G_T - L_C$ ,  $ERP = EIRP - 2.15$ , where

$P_T$  = transmitter output power in dBm

$G_T$  = gain of the transmitting antenna in dBi

$L_C$  = signal attenuation in the connecting cable between the transmitter and antenna in dB

### 3.2.2 Test Procedures

1. The transmitter output port was connected to the system simulator.
2. Set EUT at maximum power through the system simulator.
3. Select lowest, middle, and highest channels for each band and different modulation.
4. Measure and record the power level from the system simulator.
5. The MIMO mode is completely uncorrelated, so the directional gain is selected the maximum gain among all antennas.



## **3.3 Peak-to-Average Ratio**

### **3.3.1 Description of the PAR Measurement**

Power Complementary Cumulative Distribution Function (CCDF) curves provide a means for characterizing the power peaks of a digitally modulated signal on a statistical basis. A CCDF curve depicts the probability of the peak signal amplitude exceeding the average power level. Most contemporary measurement instrumentation include the capability to produce CCDF curves for an input signal provided that the instrument's resolution bandwidth can be set wide enough to accommodate the entire input signal bandwidth. In measuring transmissions in this band using an average power technique, the peak-to-average ratio (PAR) of the transmission may not exceed 13 dB.

### **3.3.2 Test Procedures**

The testing follows ANSI C63.26-2015 Section 5.2.6

1. The EUT was connected to spectrum and system simulator via a power divider.
2. Set the CCDF (Complementary Cumulative Distribution Function) option in spectrum analyzer.
3. The highest RF powers were measured and recorded the maximum PAPR level associated with a probability of 0.1 %.
4. Record the deviation as Peak to Average Ratio.



## 3.4 Occupied Bandwidth

### 3.4.1 Description of Occupied Bandwidth Measurement

The occupied bandwidth is the width of a frequency band such that, below the lower and above the upper frequency limits, the mean powers emitted are each equal to a specified percentage 0.5% of the total mean transmitted power.

The 26 dB emission bandwidth is defined as the frequency range between two points, one above and one below the carrier frequency, at which the spectral density of the emission is attenuated 26 dB below the maximum in-band spectral density of the modulated signal. Spectral density (power per unit bandwidth) is to be measured with a detector of resolution bandwidth equal to approximately 1.0% of the emission bandwidth.

### 3.4.2 Test Procedures

The testing follows ANSI C63.26-2015 Section 5.4.3 (26dB) and Section 5.4.4 (99OB)

1. The EUT was connected to spectrum analyzer and system simulator via a power divider.
2. The spectrum analyzer center frequency is set to the nominal EUT channel center frequency. The span range for the spectrum analyzer shall be between two and five times the anticipated OBW.
3. The nominal resolution bandwidth (RBW) shall be in the range of 1 to 5 % of the anticipated OBW, and the VBW shall be at least 3 times the RBW.
4. Set the detection mode to peak, and the trace mode to max hold.
5. Determine the reference value: Set the EUT to transmit a modulated signal. Allow the trace to stabilize. Set the spectrum analyzer marker to the highest level of the displayed trace.  
(this is the reference value)
6. Determine the “-26 dB down amplitude” as equal to (Reference Value – X).
7. Place two markers, one at the lowest and the other at the highest frequency of the envelope of the spectral display such that each marker is at or slightly below the “-X dB down amplitude” determined in step 6. If a marker is below this “-X dB down amplitude” value it shall be placed as close as possible to this value. The OBW is the positive frequency difference between the two markers.
8. Use the 99 % power bandwidth function of the spectrum analyzer and report the measured bandwidth.



### 3.5 Conducted Band Edge

#### 3.5.1 Description of Conducted Band Edge Measurement

27.53 (n)(2)

(2) For mobile operations in the 3450-3550 MHz band, the conducted power of any emission outside the licensee's authorized bandwidth shall not exceed  $-13$  dBm/MHz. Compliance with this paragraph (n)(2) is based on the use of measurement instrumentation employing a resolution bandwidth of 1 megahertz or greater. However, in the 1 megahertz bands immediately outside and adjacent to the licensee's frequency block, a resolution bandwidth of at least one percent of the emission bandwidth of the fundamental emission of the transmitter may be employed, but limited to a maximum of 200 kHz. In the bands between 1 and 5 MHz removed from the licensee's frequency block, the minimum resolution bandwidth for the measurement shall be 500 kHz. The emission bandwidth is defined as the width of the signal between two points, one below the carrier center frequency and one above the carrier center frequency, outside of which all emissions are attenuated at least 26 dB below the transmitter power.

#### 3.5.2 Test Procedures

The testing follows FCC KDB 971168 D01 v03r01 Section 6.1.

1. The EUT was connected to spectrum analyzer and system simulator via a power divider.
2. The band edges of low and high channels for the highest RF powers were measured.
3. For  $EBW < 20\text{MHz}$ , set  $RBW \geq 1\%$  EBW in the 1MHz band immediately outside and adjacent to the band edge.
4. For  $EBW \geq 20\text{MHz}$ , set  $RBW = 200\text{kHz}$  in the 1MHz band immediately outside and adjacent to the band edge.
5. Between 1 ~5 MHz from the band edge,  $RBW=500$  kHz was used.
6. Set spectrum analyzer with RMS detector.
7. The RF fundamental frequency should be excluded against the limit line in the operating frequency band.
8. Checked that all the results comply with the emission limit line.  
The limit line is derived from  $43 + 10\log(P)\text{dB}$  below the transmitter power P(Watts)
9. For MIMO mode, add additional MIMO factor  $10\log(NTX=2) = 3.01\text{dB}$  into the spectrum analyzer offset.



## **3.6 Conducted Spurious Emission**

### **3.6.1 Description of Conducted Spurious Emission Measurement**

The power of any emission outside of the authorized operating frequency ranges must be lower than the transmitter power (P) by a factor of at least  $43 + 10 \log (P)$  dB.

It is measured by means of a calibrated spectrum analyzer and scanned from 30 MHz up to a frequency including its 10<sup>th</sup> harmonic.

### **3.6.2 Test Procedures**

The testing follows FCC KDB 971168 D01 v03r01 Section 6.1.

1. The EUT was connected to spectrum analyzer and system simulator via a power divider.
2. The RF output of EUT was connected to the spectrum analyzer by RF cable and attenuator. The path loss was compensated to the results for each measurement.
3. The middle channel for the highest RF power within the transmitting frequency was measured.
4. The conducted spurious emission for the whole frequency range was taken.
5. Make the measurement with the spectrum analyzer's RBW = 1MHz, VBW = 3MHz.
6. Set spectrum analyzer with RMS detector.
7. Taking the record of maximum spurious emission.
8. The RF fundamental frequency should be excluded against the limit line in the operating frequency band.
9. The limit line is derived from  $43 + 10\log(P)$ dB below the transmitter power P(Watts)
10. For MIMO mode, add additional MIMO factor  $10\log(NTX=2) = 3.01$ dB into the spectrum analyzer offset.



## 3.7 Frequency Stability

### 3.7.1 Description of Frequency Stability Measurement

27.54

The frequency stability shall be sufficient to ensure that the fundamental emission stays within the authorized frequency block.

### 3.7.2 Test Procedures for Temperature Variation

The testing follows FCC KDB 971168 D01 v03r01 Section 9.0.

1. The EUT was set up in the thermal chamber and connected with the system simulator.
2. With power OFF, the temperature was decreased to  $-30^{\circ}\text{C}$  and the EUT was stabilized before testing. Power was applied and the maximum change in frequency was recorded within one minute.
3. With power OFF, the temperature was raised in  $10^{\circ}\text{C}$  step up to  $50^{\circ}\text{C}$ . The EUT was stabilized at each step for at least half an hour. Power was applied and the maximum frequency change was recorded within one minute.

### 3.7.3 Test Procedures for Voltage Variation

The testing follows FCC KDB 971168 D01 v03r01 Section 9.0.

1. The EUT was placed in a temperature chamber at  $20\pm 5^{\circ}\text{C}$  and connected with the system simulator.
2. The power supply voltage to the EUT was varied from 85% to 115% of the nominal value measured at the input to the EUT.
3. The variation in frequency was measured for the worst case.



## 4 Radiated Test Items

### 4.1 Measuring Instruments

See list of measuring instruments of this test report.

#### 4.1.1 Test Setup

For radiated emissions below 30MHz



For radiated test from 30MHz to 1GHz

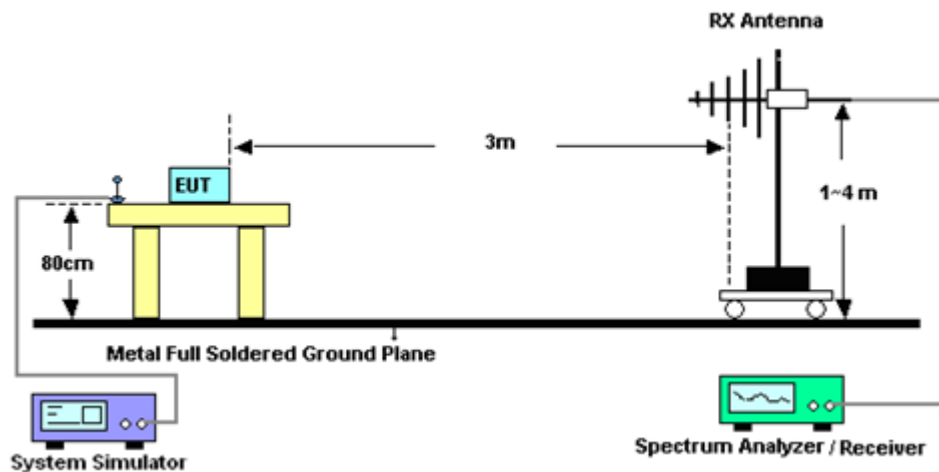

For radiated test from 1GHz to 18GHz

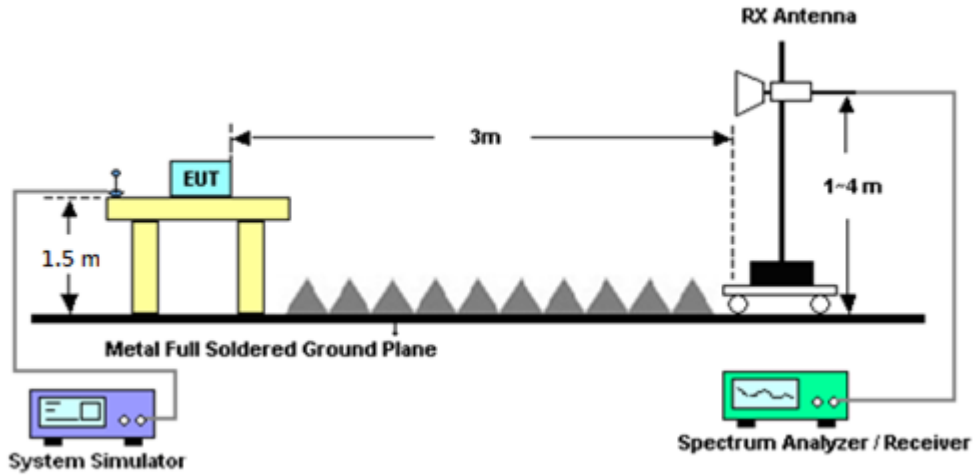

For radiated test above 18GHz

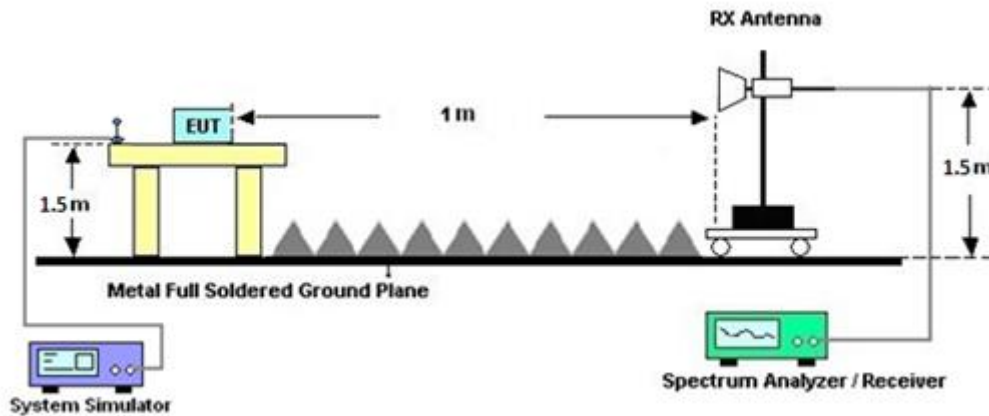

### 4.1.2 Test Result of Radiated Test

Please refer to Appendix B.

**Note:**

The low frequency, which started from 9 kHz to 30MHz, was pre-scanned and the result which was 20dB lower than the limit line was not reported.

There is adequate comparison measurement of both open-field test site and alternative test site - semi-Anechoic chamber according to 414788 D01 Radiated Test Site v01r01, and the result came out very similar.



## **4.2 Radiated Spurious Emission Measurement**

### **4.2.1 Description of Radiated Spurious Emission Measurement**

The radiated spurious emission was measured by substitution method according to ANSI / TIA-603-E. The power of any emission outside of the authorized operating frequency ranges must be attenuated below the transmitter power (P) by a factor of at least  $43 + 10 \log (P)$  dB. The spectrum is scanned from 30 MHz up to a frequency including its 10th harmonic.

### **4.2.2 Test Procedures**

The testing follows FCC KDB 971168 D01 v03r01 Section 7 and ANSI / TIA-603-E Section 2.2.12.

1. The EUT was placed on a turntable with 0.8 meter for frequency below 1GHz and 1.5 meter for frequency above 1GHz respectively above ground.
2. The EUT was set 3 meters from the receiving antenna, which was mounted on the antenna tower.
3. The table was rotated 360 degrees to determine the position of the highest spurious emission.
4. The height of the receiving antenna is varied between one meter and four meters to search the maximum spurious emission for both horizontal and vertical polarizations.
5. Make the measurement with the spectrum analyzer's RBW = 1MHz, VBW = 3MHz, taking the record of maximum spurious emission.
6. A horn antenna was substituted in place of the EUT and was driven by a signal generator.
7. Tune the output power of signal generator to the same emission level with EUT maximum spurious emission.
8. Taking the record of output power at antenna port.
9. Repeat step 7 to step 8 for another polarization.
10. The RF fundamental frequency should be excluded against the limit line in the operating frequency band.

The limit line is derived from  $43 + 10\log(P)$ dB below the transmitter power P(Watts)



## 5 List of Measuring Equipment

Instrument	Brand Name	Model No.	Serial No.	Characteristics	Calibration Date	Test Date	Due Date	Remark
Loop Antenna	Rohde & Schwarz	HFH2-Z2	100488	9 kHz~30 MHz	Sep. 20, 2022	Apr. 19, 2023~ Apr. 20, 2023	Sep. 19, 2023	Radiation (03CH12-HY)
Bilog Antenna	TESEQ	CBL 6111D & 00800N1D01N-06	37059 & 01	30MHz~1GHz	Nov. 10, 2022	Apr. 19, 2023~ Apr. 20, 2023	Nov. 09, 2023	Radiation (03CH12-HY)
Horn Antenna	SCHWARZBE CK	BBHA 9120 D	9120D-02114	1GHz~18GHz	Aug. 09, 2022	Apr. 19, 2023~ Apr. 20, 2023	Aug. 08, 2023	Radiation (03CH12-HY)
SHF-EHF Horn Antenna	SCHWARZBE CK	BBHA9170	00993	18GHz~40GHz	Nov. 24, 2022	Apr. 19, 2023~ Apr. 20, 2023	Nov. 23, 2023	Radiation (03CH12-HY)
Preamplifier	COM-POWER	PA-103	161075	10MHz~1GHz	Mar. 21, 2023	Apr. 19, 2023~ Apr. 20, 2023	Mar. 20, 2024	Radiation (03CH12-HY)
Preamplifier	Agilent	8449B	3008A02375	1GHz~26.5GHz	May 24, 2022	Apr. 19, 2023~ Apr. 20, 2023	May 23, 2023	Radiation (03CH12-HY)
Preamplifier	E-INSTRUME NT TECH LTD.	ERA-100M-18G-5 6-01-A70	EC1900249	1GHz-18GHz	Dec. 21, 2022	Apr. 19, 2023~ Apr. 20, 2023	Dec. 20, 2023	Radiation (03CH12-HY)
Preamplifier	EMEC	EM18G40G	060715	18GHz~40GHz	Dec. 07, 2022	Apr. 19, 2023~ Apr. 20, 2023	Dec. 06, 2023	Radiation (03CH12-HY)
Spectrum Analyzer	Agilent	N9010A	MY53470118	10Hz~44GHz	Jan. 10, 2023	Apr. 19, 2023~ Apr. 20, 2023	Jan. 09, 2024	Radiation (03CH12-HY)
Filter	Wainwright	WLKS1200-12SS	SN2	1.2GHz Low Pass Filter	Mar. 13, 2023	Apr. 19, 2023~ Apr. 20, 2023	Mar. 12, 2024	Radiation (03CH12-HY)
Filter	Wainwright	WHKX8-5872.5-6 750-18000-40ST	SN2	6.75GHz High Pass Filter	Mar. 13, 2023	Apr. 19, 2023~ Apr. 20, 2023	Mar. 12, 2024	Radiation (03CH12-HY)
RF Cable	HUBER + SUHNER	SUCOFLEX 102	803951/2	9kHz~30MHz	Mar. 07, 2023	Apr. 19, 2023~ Apr. 20, 2023	Mar. 06, 2024	Radiation (03CH12-HY)
RF Cable	HUBER + SUHNER	SUCOFLEX 126E	0058/126E	30MHz~18GHz	Dec. 20, 2022	Apr. 19, 2023~ Apr. 20, 2023	Dec. 19, 2023	Radiation (03CH12-HY)
RF Cable	HUBER + SUHNER	SUCOFLEX 102	505134/2	30MHz~40GHz	Dec. 20, 2022	Apr. 19, 2023~ Apr. 20, 2023	Dec. 19, 2023	Radiation (03CH12-HY)
Hygrometer	TECPEL	DTM-303B	TP210090	N/A	Oct. 03, 2022	Apr. 19, 2023~ Apr. 20, 2023	Oct. 02, 2023	Radiation (03CH12-HY)
Controller	EMEC	EM1000	N/A	Control Turn table & Ant Mast	N/A	Apr. 19, 2023~ Apr. 20, 2023	N/A	Radiation (03CH12-HY)
Antenna Mast	EMEC	AM-BS-4500-B	N/A	1m~4m	N/A	Apr. 19, 2023~ Apr. 20, 2023	N/A	Radiation (03CH12-HY)
Turn Table	EMEC	TT2000	N/A	0~360 Degree	N/A	Apr. 19, 2023~ Apr. 20, 2023	N/A	Radiation (03CH12-HY)
Software	Audix	E3 6.2009-8-24	RK-000989	N/A	N/A	Apr. 19, 2023~ Apr. 20, 2023	N/A	Radiation (03CH12-HY)
Programmable Power Supply	GW Instek	PSS-2005	EL890001	50Hz~60Hz	Sep. 29, 2022	Apr. 19, 2023~ Apr. 21, 2023	Sep. 28, 2023	Conducted (TH03-HY)
Signal Analyzer	Rohde & Schwarz	FSV3044	101049	10Hz~44GHz	Oct. 07, 2022	Apr. 19, 2023~ Apr. 21, 2023	Oct. 06, 2023	Conducted (TH03-HY)
Temperature Chamber	ESPEC	SH-641	92013720	-40℃ ~90℃	Sep. 07, 2022	Apr. 19, 2023~ Apr. 21, 2023	Sep. 06, 2023	Conducted (TH03-HY)
Base Station (Measure)	Anritsu	MT8821C	6262116730	LTE	Jun. 15, 2022	Apr. 19, 2023~ Apr. 21, 2023	Jun. 14, 2023	Conducted (TH03-HY)
Base Station (Measure)	Anritsu	MT8000A	6262134933	FR1	Jun. 13, 2022	Apr. 19, 2023~ Apr. 21, 2023	Jun. 12, 2023	Conducted (TH03-HY)



## 6 Measurement Uncertainty

### Uncertainty of Radiated Emission Measurement (30 MHz ~ 1000 MHz)

Measuring Uncertainty for a Level of Confidence of 95% ( $U = 2Uc(y)$ )	3.31 dB
-------------------------------------------------------------------------	---------

### Uncertainty of Radiated Emission Measurement (1 GHz ~ 18 GHz)

Measuring Uncertainty for a Level of Confidence of 95% ( $U = 2Uc(y)$ )	3.25 dB
-------------------------------------------------------------------------	---------

### Uncertainty of Radiated Emission Measurement (18 GHz ~ 40 GHz)

Measuring Uncertainty for a Level of Confidence of 95% ( $U = 2Uc(y)$ )	3.81 dB
-------------------------------------------------------------------------	---------



## Appendix A. Test Results of Conducted Test

### Conducted Output Power(Average power and EIRP)

<SISO Mode>

5G FR1 n77 Maximum Average Power [dBm] (GT - LC = 1.5 dB)								
BW [MHz]	RB Size	RB Offset	Mod	Lowest	Middle	Highest	EIRP (dBm)	EIRP(W)
10	1	1	PI/2 BPSK	22.98	23.12	22.89	24.67	0.2931
10	1	22		22.99	23.09	22.85		
10	12	6		23.07	23.17	22.92		
10	1	0		23.08	23.16	22.89		
10	1	23		23.00	23.09	22.79		
10	24	0		23.05	23.16	22.92		
10	1	1	QPSK	23.08	23.05	22.83		
10	1	22		23.06	23.07	22.81		
10	12	6		23.10	23.14	22.92		
10	1	0		23.02	23.10	22.88		
10	1	23		23.00	23.01	22.75		
10	24	0		23.08	23.17	22.93		
10	1	1	16-QAM	22.80	22.94	22.70	24.68	0.2938
10	1	1	64-QAM	23.06	23.18	22.90		
10	1	1	256-QAM	22.02	22.05	21.91		
Limit	EIRP < 1W			Result			Pass	

5G FR1 n77 Maximum Average Power [dBm] (GT - LC = 1.5 dB)								
BW [MHz]	RB Size	RB Offset	Mod	Lowest	Middle	Highest	EIRP (dBm)	EIRP(W)
15	1	1	PI/2 BPSK	23.20	23.19	23.07	24.74	0.2979
15	1	36		23.18	23.17	22.96		
15	18	9		23.24	23.24	23.04		
15	1	0		23.13	23.20	23.02		
15	1	37		23.24	23.14	22.92		
15	36	0		23.24	23.22	23.01		
15	1	1	QPSK	23.20	23.19	23.08		
15	1	36		23.17	23.12	22.89		
15	18	9		23.24	23.22	23.02		
15	1	0		23.15	23.16	22.98		
15	1	37		23.21	23.10	22.90		
15	36	0		23.24	23.17	23.02		
15	1	1	16-QAM	23.01	23.02	22.88	24.74	0.2979
15	1	1	64-QAM	23.24	23.24	23.10		
15	1	1	256-QAM	22.25	22.21	22.05		
Limit	EIRP < 1W			Result			Pass	



5G FR1 n77 Maximum Average Power [dBm] (GT - LC = 1.5 dB)								
BW [MHz]	RB Size	RB Offset	Mod	Lowest	Middle	Highest	EIRP (dBm)	EIRP(W)
20	1	1	PI/2 BPSK	23.21	23.15	22.97	24.79	0.3013
20	1	49		23.29	23.11	22.92		
20	25	12		23.26	23.18	23.01		
20	1	0		23.24	23.21	23.05		
20	1	50		23.25	23.12	22.85		
20	50	0		23.18	23.16	23.01		
20	1	1	QPSK	23.19	23.14	22.91	24.80	0.3020
20	1	49		23.20	23.08	22.85		
20	25	12		23.21	23.16	22.96		
20	1	0		23.19	23.12	23.02		
20	1	50		23.27	23.03	22.81		
20	50	0		23.25	23.19	22.92		
20	1	1	16-QAM	23.05	22.95	22.69	24.80	0.3020
20	1	1	64-QAM	23.30	23.21	22.98		
20	1	1	256-QAM	22.19	22.24	22.15		
Limit	EIRP < 1W			Result			Pass	



5G FR1 n77 Maximum Average Power [dBm] (GT - LC = 1.5 dB)								
BW [MHz]	RB Size	RB Offset	Mod	Lowest	Middle	Highest	EIRP (dBm)	EIRP(W)
30	1	1	PI/2 BPSK	23.24	23.39	23.05	24.89	0.3083
30	1	76		23.26	23.15	22.83		
30	36	18		23.16	23.24	22.87		
30	1	0		23.25	23.35	23.13		
30	1	77		23.20	23.19	22.85		
30	75	0		23.24	23.31	22.87		
30	1	1	QPSK	23.22	23.35	23.02		
30	1	76		23.21	23.15	22.75		
30	36	18		23.19	23.26	22.86		
30	1	0		23.25	23.34	22.98		
30	1	77		23.24	23.06	22.75		
30	75	0		23.24	23.24	22.98		
30	1	1	16-QAM	23.02	23.15	22.91	24.80	0.3020
30	1	1	64-QAM	23.30	23.24	23.05		
30	1	1	256-QAM	22.24	22.41	22.09		
Limit	EIRP < 1W			Result			Pass	

5G FR1 n77 Maximum Average Power [dBm] (GT - LC = 1.5 dB)								
BW [MHz]	RB Size	RB Offset	Mod	Lowest	Middle	Highest	EIRP (dBm)	EIRP(W)
40	1	1	PI/2 BPSK	23.32	23.41	23.25	24.96	0.3133
40	1	104		23.35	23.17	23.12		
40	50	25		23.26	23.28	23.07		
40	1	0		23.46	23.35	23.25		
40	1	105		23.35	23.21	23.06		
40	100	0		23.41	23.36	23.12		
40	1	1	QPSK	23.24	23.33	23.22		
40	1	104		23.45	23.16	23.02		
40	50	25		23.25	23.27	23.06		
40	1	0		23.35	23.32	23.21		
40	1	105		23.45	23.17	23.04		
40	100	0		23.30	23.34	23.08		
40	1	1	16-QAM	23.15	23.17	23.02	24.95	0.3126
40	1	1	64-QAM	23.35	23.45	23.32		
40	1	1	256-QAM	22.24	22.44	22.24		
Limit	EIRP < 1W			Result			Pass	





5G FR1 n77 Maximum Average Power [dBm] (GT - LC = 1.5 dB)										
BW [MHz]	RB Size	RB Offset	Mod	Lowest	Middle	Highest	EIRP (dBm)	EIRP(W)		
50	1	1	PI/2 BPSK	23.17	23.19	23.09	24.69	0.2944		
50	1	131		22.94	22.79	22.51				
50	64	32		23.09	23.16	22.87				
50	1	0		23.12	23.17	23.07				
50	1	132		22.94	22.85	22.54				
50	128	0		23.07	23.11	22.87				
50	1	1	QPSK	23.09	23.14	23.02			24.65	0.2917
50	1	131		22.94	22.75	22.53				
50	64	32		23.15	23.06	22.86				
50	1	0		23.05	23.11	23.02				
50	1	132		22.90	22.79	22.54				
50	128	0		23.05	23.14	22.87				
50	1	1	16-QAM	22.98	23.03	22.91	24.65	0.2917		
50	1	1	64-QAM	23.12	23.15	23.12				
50	1	1	256-QAM	22.13	22.24	22.12				
Limit	EIRP < 1W			Result			Pass			

5G FR1 n77 Maximum Average Power [dBm] (GT - LC = 1.5 dB)										
BW [MHz]	RB Size	RB Offset	Mod	Lowest	Middle	Highest	EIRP (dBm)	EIRP(W)		
60	1	1	PI/2 BPSK	23.02	23.14	23.10	24.70	0.2951		
60	1	160		22.96	22.81	22.66				
60	81	40		23.20	23.12	22.98				
60	1	0		23.05	23.15	23.08				
60	1	161		22.94	22.82	22.67				
60	162	0		23.08	23.10	22.96				
60	1	1	QPSK	22.93	23.13	23.12			24.74	0.2979
60	1	160		22.95	22.83	22.64				
60	81	40		23.18	23.16	23.03				
60	1	0		23.05	23.12	23.11				
60	1	161		22.95	22.82	22.65				
60	162	0		23.14	23.12	22.97				
60	1	1	16-QAM	23.01	22.95	22.93	24.74	0.2979		
60	1	1	64-QAM	23.15	23.24	23.21				
60	1	1	256-QAM	22.17	22.14	22.12				
Limit	EIRP < 1W			Result			Pass			



5G FR1 n77 Maximum Average Power [dBm] (GT - LC = 1.5 dB)								
BW [MHz]	RB Size	RB Offset	Mod	Lowest	Middle	Highest	EIRP (dBm)	EIRP(W)
70	1	1	PI/2 BPSK	23.02	23.01	23.01	24.52	0.2831
70	1	187		22.73	22.66	22.57		
70	90	45		22.96	22.93	22.94		
70	1	0		22.94	22.98	23.02		
70	1	188		22.71	22.68	22.58		
70	180	0		22.92	22.87	22.87		
70	1	1	QPSK	22.95	22.98	23.02		
70	1	187		22.73	22.75	22.62		
70	90	45		22.92	22.95	22.93		
70	1	0		22.87	22.96	22.99		
70	1	188		22.72	22.65	22.57		
70	180	0		22.94	22.87	22.86		
70	1	1	16-QAM	22.79	22.84	22.88	24.52	0.2831
70	1	1	64-QAM	23.01	23.02	23.02		
70	1	1	256-QAM	21.95	21.98	22.03		
Limit	EIRP < 1W			Result			Pass	

5G FR1 n77 Maximum Average Power [dBm] (GT - LC = 1.5 dB)								
BW [MHz]	RB Size	RB Offset	Mod	Lowest	Middle	Highest	EIRP (dBm)	EIRP(W)
80	1	1	PI/2 BPSK	22.98	22.87	22.93	24.52	0.2831
80	1	215		22.74	22.62	22.56		
80	108	54		23.01	22.99	22.96		
80	1	0		22.95	22.98	23.02		
80	1	216		22.69	22.54	22.53		
80	216	0		22.91	22.92	22.92		
80	1	1	QPSK	22.91	22.85	22.91		
80	1	215		22.72	22.57	22.50		
80	108	54		23.01	22.92	22.92		
80	1	0		22.93	22.98	23.01		
80	1	216		22.73	22.46	22.49		
80	216	0		22.95	22.89	22.93		
80	1	1	16-QAM	22.94	22.78	22.76	24.52	0.2831
80	1	1	64-QAM	22.96	22.92	23.02		
80	1	1	256-QAM	21.98	21.98	21.95		
Limit	EIRP < 1W			Result			Pass	



5G FR1 n77 Maximum Average Power [dBm] (GT - LC = 1.5 dB)								
BW [MHz]	RB Size	RB Offset	Mod	Lowest	Middle	Highest	EIRP (dBm)	EIRP(W)
90	1	1	PI/2 BPSK	22.86	22.85	22.83	24.55	0.2851
90	1	243		22.49	22.56	22.60		
90	120	60		22.96	23.02	23.05		
90	1	0		22.98	22.97	22.98		
90	1	244		22.48	22.57	22.62		
90	243	0		22.93	22.98	22.94		
90	1	1	QPSK	22.81	22.83	22.85		
90	1	243		22.42	22.57	22.48		
90	120	60		22.93	23.01	23.02		
90	1	0		22.92	22.92	22.98		
90	1	244		22.46	22.54	22.53		
90	243	0		22.89	22.92	22.98		
90	1	1	16-QAM	22.68	22.74	22.61	24.48	0.2805
90	1	1	64-QAM	22.98	22.91	22.98		
90	1	1	256-QAM	21.90	21.82	21.98		
Limit	EIRP < 1W			Result			Pass	

5G FR1 n77 Maximum Average Power [dBm] (GT - LC = 1.5 dB)								
BW [MHz]	RB Size	RB Offset	Mod	Lowest	Middle	Highest	EIRP (dBm)	EIRP(W)
100	1	1	PI/2 BPSK	-	22.86	-	24.47	0.2799
100	1	271		-	22.69	-		
100	135	67		-	22.94	-		
100	1	0		-	22.92	-		
100	1	272		-	22.67	-		
100	270	0		-	22.89	-		
100	1	1	QPSK	-	22.76	-		
100	1	271		-	22.65	-		
100	135	67		-	22.97	-		
100	1	0		-	22.87	-		
100	1	272		-	22.67	-		
100	270	0		-	22.86	-		
100	1	1	16-QAM	-	22.65	-	24.43	0.2773
100	1	1	64-QAM	-	22.93	-		
100	1	1	256-QAM	-	21.85	-		
Limit	EIRP < 1W			Result			Pass	



5G FR1 n77 HPUE Maximum Average Power [dBm] (GT - LC = 1.5 dB)								
BW [MHz]	RB Size	RB Offset	Mod	Lowest	Middle	Highest	EIRP (dBm)	EIRP(W)
10	1	1	PI/2 BPSK	26.41	26.30	26.33	27.97	0.6266
10	1	22		26.35	26.29	26.33		
10	12	6		26.47	26.36	26.34		
10	1	0		22.86	22.72	22.85		
10	1	23		22.81	22.74	22.76		
10	24	0		25.89	25.80	25.36		
10	1	1	QPSK	26.44	26.23	26.32		
10	1	22		26.41	26.23	26.31		
10	12	6		26.46	26.39	26.34		
10	1	0		22.86	22.78	22.82		
10	1	23		22.75	22.75	22.81		
10	24	0		25.42	25.36	25.37		
10	1	1	16-QAM	25.57	25.35	25.45	27.07	0.5093
10	1	1	64-QAM	23.89	23.78	23.84		
10	1	1	256-QAM	21.70	21.58	21.63		
Limit	EIRP < 1W			Result			Pass	

5G FR1 n77 HPUE Maximum Average Power [dBm] (GT - LC = 1.5 dB)								
BW [MHz]	RB Size	RB Offset	Mod	Lowest	Middle	Highest	EIRP (dBm)	EIRP(W)
15	1	1	PI/2 BPSK	26.29	26.47	26.41	27.97	0.6266
15	1	36		26.45	26.28	26.44		
15	18	9		26.34	26.22	26.40		
15	1	0		23.10	22.98	22.93		
15	1	37		22.95	22.98	22.88		
15	36	0		26.07	25.95	25.87		
15	1	1	QPSK	26.28	26.41	26.33		
15	1	36		26.24	26.44	26.43		
15	18	9		26.29	26.20	26.40		
15	1	0		23.01	22.87	22.84		
15	1	37		22.88	22.89	22.86		
15	36	0		25.55	25.43	25.38		
15	1	1	16-QAM	25.70	25.50	25.52	27.20	0.5248
15	1	1	64-QAM	24.10	24.02	23.86		
15	1	1	256-QAM	21.87	21.73	21.69		
Limit	EIRP < 1W			Result			Pass	



5G FR1 n77 HPUE Maximum Average Power [dBm] (GT - LC = 1.5 dB)										
BW [MHz]	RB Size	RB Offset	Mod	Lowest	Middle	Highest	EIRP (dBm)	EIRP(W)		
20	1	1	PI/2 BPSK	26.35	26.47	26.45	27.97	0.6266		
20	1	49		26.45	26.47	26.40				
20	25	12		26.36	26.21	26.41				
20	1	0		23.06	22.88	22.89				
20	1	50		22.88	22.92	22.79				
20	50	0		26.08	25.95	25.88				
20	1	1	QPSK	26.35	26.45	26.42			27.26	0.5321
20	1	49		26.44	26.43	26.32				
20	25	12		26.31	26.28	26.40				
20	1	0		23.01	22.90	22.85				
20	1	50		22.83	22.88	22.80				
20	50	0		25.57	25.47	25.38				
20	1	1	16-QAM	25.76	25.59	25.50	27.26	0.5321		
20	1	1	64-QAM	24.15	23.96	23.99				
20	1	1	256-QAM	21.79	21.69	21.66				
Limit	EIRP < 1W			Result			Pass			



5G FR1 n77 HPUE Maximum Average Power [dBm] (GT - LC = 1.5 dB)								
BW [MHz]	RB Size	RB Offset	Mod	Lowest	Middle	Highest	EIRP (dBm)	EIRP(W)
30	1	1	PI/2 BPSK	26.39	26.26	26.35	27.96	0.6252
30	1	76		26.32	26.27	26.21		
30	36	18		26.24	26.21	26.24		
30	1	0		23.21	22.99	23.22		
30	1	77		22.81	23.02	22.99		
30	75	0		26.06	26.04	26.11		
30	1	1	QPSK	26.41	26.26	26.32		
30	1	76		26.28	26.21	26.42		
30	36	18		26.22	26.20	26.46		
30	1	0		23.20	23.05	23.22		
30	1	77		22.79	23.05	22.96		
30	75	0		25.55	25.52	25.60		
30	1	1	16-QAM	25.73	25.65	25.75	27.25	0.5309
30	1	1	64-QAM	24.26	24.13	24.25		
30	1	1	256-QAM	21.98	21.86	21.91		
Limit	EIRP < 1W			Result			Pass	

5G FR1 n77 HPUE Maximum Average Power [dBm] (GT - LC = 1.5 dB)								
BW [MHz]	RB Size	RB Offset	Mod	Lowest	Middle	Highest	EIRP (dBm)	EIRP(W)
40	1	1	PI/2 BPSK	26.44	26.32	26.41	27.97	0.6266
40	1	104		26.43	26.26	26.28		
40	50	25		26.27	26.25	26.25		
40	1	0		23.25	23.09	23.27		
40	1	105		22.92	23.00	22.99		
40	100	0		26.08	26.06	26.03		
40	1	1	QPSK	26.47	26.29	26.40		
40	1	104		26.39	26.20	26.21		
40	50	25		26.25	26.27	26.19		
40	1	0		23.25	23.04	23.15		
40	1	105		22.91	22.96	22.99		
40	100	0		25.59	25.55	25.54		
40	1	1	16-QAM	25.90	25.73	25.83	27.40	0.5495
40	1	1	64-QAM	24.26	24.16	24.26		
40	1	1	256-QAM	22.09	21.87	22.00		
Limit	EIRP < 1W			Result			Pass	



5G FR1 n77 HPUE Maximum Average Power [dBm] (GT - LC = 1.5 dB)								
BW [MHz]	RB Size	RB Offset	Mod	Lowest	Middle	Highest	EIRP (dBm)	EIRP(W)
50	1	1	PI/2 BPSK	26.30	26.19	26.24	27.98	0.6281
50	1	131		26.08	26.16	26.20		
50	64	32		26.33	26.41	26.36		
50	1	0		23.01	22.93	23.00		
50	1	132		22.53	22.57	22.68		
50	128	0		25.82	25.85	25.81		
50	1	1	QPSK	26.23	26.44	26.48		
50	1	131		26.08	26.15	26.15		
50	64	32		26.32	26.40	26.34		
50	1	0		23.06	22.93	22.98		
50	1	132		22.53	22.61	22.63		
50	128	0		25.31	25.37	25.32		
50	1	1	16-QAM	25.65	25.55	25.60	27.15	0.5188
50	1	1	64-QAM	24.06	24.03	24.05		
50	1	1	256-QAM	21.86	21.77	21.81		
Limit	EIRP < 1W			Result			Pass	

5G FR1 n77 HPUE Maximum Average Power [dBm] (GT - LC = 1.5 dB)								
BW [MHz]	RB Size	RB Offset	Mod	Lowest	Middle	Highest	EIRP (dBm)	EIRP(W)
60	1	1	PI/2 BPSK	26.23	26.23	26.46	27.97	0.6266
60	1	160		26.18	26.15	26.22		
60	81	40		26.36	26.45	26.28		
60	1	0		23.09	23.01	22.96		
60	1	161		22.56	22.54	22.59		
60	162	0		25.87	25.93	25.92		
60	1	1	QPSK	26.19	26.20	26.39		
60	1	160		26.12	26.09	26.15		
60	81	40		26.41	26.20	26.47		
60	1	0		23.07	22.98	22.98		
60	1	161		22.60	22.51	22.57		
60	162	0		25.36	25.40	25.45		
60	1	1	16-QAM	25.59	25.64	25.52	27.14	0.5176
60	1	1	64-QAM	24.09	23.98	23.94		
60	1	1	256-QAM	21.79	21.82	21.69		
Limit	EIRP < 1W			Result			Pass	



5G FR1 n77 HPUE Maximum Average Power [dBm] (GT - LC = 1.5 dB)								
BW [MHz]	RB Size	RB Offset	Mod	Lowest	Middle	Highest	EIRP (dBm)	EIRP(W)
70	1	1	PI/2 BPSK	26.28	26.28	26.19	27.93	0.6209
70	1	187		26.03	25.97	26.01		
70	90	45		26.14	26.40	26.43		
70	1	0		22.99	23.15	22.89		
70	1	188		22.43	22.56	22.59		
70	180	0		25.72	25.93	25.91		
70	1	1	QPSK	26.43	26.22	26.28		
70	1	187		25.97	26.07	26.06		
70	90	45		26.17	26.42	26.42		
70	1	0		22.94	23.11	22.96		
70	1	188		22.46	22.43	22.56		
70	180	0		25.22	25.41	25.38		
70	1	1	16-QAM	25.58	25.69	25.62	27.19	0.5236
70	1	1	64-QAM	24.05	24.09	24.07		
70	1	1	256-QAM	21.79	21.83	21.80		
Limit	EIRP < 1W			Result			Pass	

5G FR1 n77 HPUE Maximum Average Power [dBm] (GT - LC = 1.5 dB)								
BW [MHz]	RB Size	RB Offset	Mod	Lowest	Middle	Highest	EIRP (dBm)	EIRP(W)
80	1	1	PI/2 BPSK	26.25	26.39	26.23	27.96	0.6252
80	1	215		25.95	26.04	26.06		
80	108	54		26.34	26.37	26.40		
80	1	0		23.07	23.11	23.04		
80	1	216		22.39	22.48	22.49		
80	216	0		25.87	25.83	25.83		
80	1	1	QPSK	26.22	26.39	26.28		
80	1	215		25.90	26.04	26.02		
80	108	54		26.31	26.37	26.46		
80	1	0		23.08	23.17	23.14		
80	1	216		22.36	22.48	22.55		
80	216	0		25.32	25.34	25.44		
80	1	1	16-QAM	25.76	25.75	25.68	27.26	0.5321
80	1	1	64-QAM	24.13	24.23	24.07		
80	1	1	256-QAM	21.90	21.95	21.81		
Limit	EIRP < 1W			Result			Pass	





5G FR1 n77 HPUE Maximum Average Power [dBm] (GT - LC = 1.5 dB)								
BW [MHz]	RB Size	RB Offset	Mod	Lowest	Middle	Highest	EIRP (dBm)	EIRP(W)
90	1	1	PI/2 BPSK	26.31	26.36	26.32	27.96	0.6252
90	1	243		26.02	26.09	26.15		
90	120	60		26.32	26.43	26.21		
90	1	0		23.14	23.25	23.31		
90	1	244		22.47	22.50	22.61		
90	243	0		25.79	25.89	25.89		
90	1	1	QPSK	26.29	26.33	26.40		
90	1	243		26.02	26.03	26.10		
90	120	60		26.29	26.46	26.45		
90	1	0		23.18	23.22	23.30		
90	1	244		22.44	22.50	22.53		
90	243	0		25.31	25.40	25.42		
90	1	1	16-QAM	25.74	25.74	25.79	27.29	0.5358
90	1	1	64-QAM	24.13	24.20	24.24		
90	1	1	256-QAM	21.90	21.94	21.98		
Limit	EIRP < 1W			Result			Pass	

5G FR1 n77 HPUE Maximum Average Power [dBm] (GT - LC = 1.5 dB)								
BW [MHz]	RB Size	RB Offset	Mod	Lowest	Middle	Highest	EIRP (dBm)	EIRP(W)
100	1	1	PI/2 BPSK	-	26.39	-	27.95	0.6237
100	1	271		-	26.13	-		
100	135	67		-	26.45	-		
100	1	0		-	23.20	-		
100	1	272		-	22.50	-		
100	270	0		-	25.91	-		
100	1	1	QPSK	-	26.35	-		
100	1	271		-	26.08	-		
100	135	67		-	26.44	-		
100	1	0		-	23.25	-		
100	1	272		-	22.55	-		
100	270	0		-	25.38	-		
100	1	1	16-QAM	-	25.76	-	27.26	0.5321
100	1	1	64-QAM	-	24.24	-		
100	1	1	256-QAM	-	21.93	-		
Limit	EIRP < 1W			Result			Pass	



<MIMO Mode>

5G FR1 n77 Maximum Average Power [dBm], DG = 3.5 dBi														
BW (MHz)	RB Size	RB Offset	Mod	Antenna 4			Antenna 6			Combine			EIRP (dBm)	EIRP (W)
				Lowest	Middle	Highest	Lowest	Middle	Highest	Lowest	Middle	Highest		
10	1	1	QPSK	21.05	21.09	20.96	21.44	21.29	20.99	24.26	24.20	23.99	27.77	0.5984
10	1	22		21.11	21.20	20.94	21.35	21.26	21.19	24.24	24.24	24.08		
10	12	6		21.09	21.09	20.87	21.42	21.22	20.97	24.27	24.17	23.93		
10	1	0		19.02	19.06	18.85	19.46	19.35	19.01	22.26	22.22	21.94		
10	1	23		19.01	19.12	18.89	19.41	19.14	18.82	22.22	22.14	21.86		
10	24	0		19.54	19.64	19.35	19.89	19.76	19.44	22.73	22.71	22.41		
10	1	1	16-QAM	20.54	20.65	20.37	21.00	20.91	20.54	23.79	23.79	23.47	27.29	0.5358
10	1	1	64-QAM	18.85	18.93	18.75	19.10	19.00	18.71	21.99	21.98	21.74		
10	1	1	256-QAM	16.04	16.05	15.84	16.35	16.32	15.97	19.21	19.20	18.92		
Limit	EIRP < 1W			Result									Pass	

5G FR1 n77 Maximum Average Power [dBm], DG = 3.5 dBi														
BW (MHz)	RB Size	RB Offset	Mod	Antenna 4			Antenna 6			Combine			EIRP (dBm)	EIRP (W)
				Lowest	Middle	Highest	Lowest	Middle	Highest	Lowest	Middle	Highest		
15	1	1	QPSK	21.26	21.26	21.10	21.64	21.51	21.23	24.46	24.40	24.18	27.98	0.6281
15	1	36		21.34	21.44	21.14	21.60	21.42	21.16	24.48	24.44	24.16		
15	19	9		21.26	21.27	21.01	21.44	21.36	21.12	24.36	24.33	24.08		
15	1	0		19.28	19.33	19.01	19.76	19.46	19.24	22.54	22.41	22.14		
15	1	37		19.36	19.24	18.93	19.60	19.54	19.21	22.49	22.40	22.08		
15	38	0		19.79	19.74	19.45	19.99	19.94	19.58	22.90	22.85	22.53		
15	1	1	16-QAM	20.81	20.82	18.87	21.19	21.23	19.31	24.01	24.04	22.11	27.54	0.5675
15	1	1	64-QAM	19.12	19.18	18.70	19.42	19.21	18.93	22.28	22.21	21.83		
15	1	1	256-QAM	16.32	16.35	15.84	16.74	16.57	16.16	19.55	19.47	19.01		
Limit	EIRP < 1W			Result									Pass	



5G FR1 n77 Maximum Average Power [dBm], DG = 3.5 dBi														
BW (MHz)	RB Size	RB Offset	Mod	Antenna 4			Antenna 6			Combine			EIRP (dBm)	EIRP (W)
				Lowest	Middle	Highest	Lowest	Middle	Highest	Lowest	Middle	Highest		
20	1	1	QPSK	21.32	21.21	21.15	21.55	21.52	21.21	24.45	24.38	24.19	27.97	0.6266
20	1	49		21.32	21.19	21.04	21.60	21.45	21.14	24.47	24.33	24.10		
20	25	12		21.33	21.32	20.98	21.55	21.45	21.14	24.45	24.40	24.07		
20	1	0		19.31	19.29	19.09	19.72	19.62	19.17	22.53	22.47	22.14		
20	1	50		19.35	19.23	18.94	19.78	19.43	19.07	22.58	22.34	22.02		
20	51	0		19.83	19.72	19.46	20.19	19.94	19.59	23.02	22.84	22.54		
20	1	1	16-QAM	20.86	20.87	20.60	21.32	21.23	20.92	24.11	24.06	23.77	27.61	0.5768
20	1	1	64-QAM	19.18	19.11	18.91	19.35	19.36	18.97	22.28	22.25	21.95		
20	1	1	256-QAM	16.32	16.35	16.01	16.85	16.25	16.25	19.60	19.31	19.14		
Limit	EIRP < 1W			Result									Pass	

5G FR1 n77 Maximum Average Power [dBm], DG = 3.5 dBi														
BW (MHz)	RB Size	RB Offset	Mod	Antenna 4			Antenna 6			Combine			EIRP (dBm)	EIRP (W)
				Lowest	Middle	Highest	Lowest	Middle	Highest	Lowest	Middle	Highest		
30	1	1	QPSK	21.32	21.30	21.23	21.60	21.60	21.48	24.47	24.46	24.37	27.97	0.6266
30	1	76		21.32	21.32	21.09	21.47	21.54	21.21	24.41	24.44	24.16		
30	39	19		21.26	21.22	21.20	21.61	21.45	21.24	24.45	24.35	24.23		
30	1	0		19.31	19.37	19.35	19.76	19.69	19.45	22.55	22.54	22.41		
30	1	77		19.33	19.34	19.14	19.62	19.45	19.25	22.49	22.41	22.21		
30	78	0		19.80	19.76	19.74	20.06	19.98	19.76	22.94	22.88	22.76		
30	1	1	16-QAM	20.76	20.86	20.79	21.42	21.31	21.12	24.11	24.10	23.97	27.61	0.5768
30	1	1	64-QAM	19.14	19.17	19.03	19.52	19.42	19.27	22.34	22.31	22.16		
30	1	1	256-QAM	16.39	16.35	16.18	16.81	16.67	16.45	19.62	19.52	19.33		
Limit	EIRP < 1W			Result									Pass	

5G FR1 n77 Maximum Average Power [dBm], DG = 3.5 dBi														
BW (MHz)	RB Size	RB Offset	Mod	Antenna 4			Antenna 6			Combine			EIRP (dBm)	EIRP (W)
				Lowest	Middle	Highest	Lowest	Middle	Highest	Lowest	Middle	Highest		
40	1	1	QPSK	21.32	21.40	21.42	21.57	21.51	21.46	24.46	24.47	24.45	27.98	0.6281
40	1	104		21.38	21.37	21.26	21.55	21.42	21.37	24.48	24.41	24.33		
40	53	26		21.26	21.25	21.15	21.52	21.46	21.21	24.40	24.37	24.19		
40	1	0		19.40	19.45	19.36	19.85	19.69	19.42	22.64	22.58	22.40		
40	1	105		21.37	19.31	19.08	21.51	19.39	19.21	24.45	22.36	22.16		
40	106	0		19.98	19.77	19.72	20.16	19.80	19.72	23.08	22.80	22.73		
40	1	1	16-QAM	20.91	20.82	20.82	21.45	21.33	21.21	24.20	24.09	24.03	27.70	0.5888
40	1	1	64-QAM	19.26	19.25	19.08	19.24	19.45	19.24	22.26	22.36	22.17		
40	1	1	256-QAM	16.35	16.42	16.29	16.85	16.76	16.54	19.62	19.60	19.43		
Limit	EIRP < 1W			Result									Pass	



5G FR1 n77 Maximum Average Power [dBm], DG = 3.5 dBi														
BW (MHz)	RB Size	RB Offset	Mod	Antenna 4			Antenna 6			Combine			EIRP (dBm)	EIRP (W)
				Lowest	Middle	Highest	Lowest	Middle	Highest	Lowest	Middle	Highest		
50	1	1	QPSK	21.35	21.35	21.26	21.52	21.51	21.29	24.45	24.44	24.29	27.95	0.6237
50	1	131		21.16	21.03	20.62	21.23	21.05	20.76	24.21	24.05	23.70		
50	67	33		21.09	21.16	20.70	21.36	21.21	20.94	24.24	24.20	23.83		
50	1	0		19.18	19.31	19.24	19.48	19.45	19.30	22.34	22.39	22.28		
50	1	132		19.02	18.85	18.59	19.15	19.05	18.79	22.10	21.96	21.70		
50	133	0		19.59	19.71	19.45	19.84	19.77	19.48	22.73	22.75	22.48		
50	1	1	16-QAM	20.59	20.72	20.74	21.15	21.12	20.94	23.89	23.93	23.85	27.43	0.5534
50	1	1	64-QAM	18.98	19.02	19.03	19.20	19.25	19.01	22.10	22.15	22.03		
50	1	1	256-QAM	16.13	16.23	16.19	16.54	16.54	16.32	19.35	19.40	19.27		
Limit	EIRP < 1W			Result									Pass	

5G FR1 n77 Maximum Average Power [dBm], DG = 3.5 dBi														
BW (MHz)	RB Size	RB Offset	Mod	Antenna 4			Antenna 6			Combine			EIRP (dBm)	EIRP (W)
				Lowest	Middle	Highest	Lowest	Middle	Highest	Lowest	Middle	Highest		
60	1	1	QPSK	20.92	21.21	20.32	20.98	21.55	20.82	23.96	24.39	23.59	27.89	0.6152
60	1	160		20.52	21.26	20.89	20.41	21.34	21.17	23.48	24.31	24.04		
60	81	40		20.79	21.24	20.56	20.85	21.32	20.95	23.83	24.29	23.77		
60	1	0		18.65	19.33	18.44	18.89	19.54	18.97	21.78	22.45	21.72		
60	1	161		18.38	18.88	18.79	18.41	19.02	19.15	21.41	21.96	21.98		
60	162	0		19.02	19.74	19.08	19.14	19.76	19.54	22.09	22.76	22.33		
60	1	1	16-QAM	20.38	20.83	19.78	20.74	21.26	20.34	23.57	24.06	23.08	27.56	0.5702
60	1	1	64-QAM	18.70	19.24	18.12	18.81	19.42	18.46	21.77	22.34	21.30		
60	1	1	256-QAM	15.89	16.45	15.26	16.14	16.70	15.77	19.03	19.59	18.53		
Limit	EIRP < 1W			Result									Pass	



5G FR1 n77 Maximum Average Power [dBm], DG = 3.5 dBi														
BW (MHz)	RB Size	RB Offset	Mod	Antenna 4			Antenna 6			Combine			EIRP (dBm)	EIRP (W)
				Lowest	Middle	Highest	Lowest	Middle	Highest	Lowest	Middle	Highest		
70	1	1	QPSK	20.94	21.24	21.11	21.42	21.35	21.35	24.20	24.31	24.24	27.81	0.6039
70	1	187		20.76	20.69	20.76	20.94	20.81	20.78	23.86	23.76	23.78		
70	95	47		20.99	21.10	21.02	21.15	21.09	21.08	24.08	24.11	24.06		
70	1	0		19.01	19.13	19.12	19.38	19.35	19.35	22.21	22.25	22.25		
70	1	188		18.72	18.55	18.56	18.92	18.74	18.68	21.83	21.66	21.63		
70	189	0		19.42	19.48	19.47	19.68	19.58	19.51	22.56	22.54	22.50		
70	1	1	16-QAM	20.53	20.52	20.61	21.02	21.02	20.96	23.79	23.79	23.80	27.30	0.5370
70	1	1	64-QAM	18.82	18.88	18.84	19.14	19.13	19.18	21.99	22.02	22.02		
70	1	1	256-QAM	15.92	16.04	16.05	16.38	16.40	16.35	19.17	19.23	19.21		
Limit	EIRP < 1W			Result									Pass	

5G FR1 n77 Maximum Average Power [dBm], DG = 3.5 dBi														
BW (MHz)	RB Size	RB Offset	Mod	Antenna 4			Antenna 6			Combine			EIRP (dBm)	EIRP (W)
				Lowest	Middle	Highest	Lowest	Middle	Highest	Lowest	Middle	Highest		
80	1	1	QPSK	21.05	21.17	21.25	21.23	21.25	21.24	24.15	24.22	24.26	27.76	0.5970
80	1	215		20.74	20.87	20.84	20.85	20.73	20.76	23.81	23.81	23.81		
80	109	54		21.07	21.02	20.95	21.07	21.07	21.01	24.08	24.06	23.99		
80	1	0		19.05	19.02	19.04	19.41	19.32	19.32	22.24	22.18	22.19		
80	1	216		18.72	18.54	18.64	18.84	18.70	18.61	21.79	21.63	21.64		
80	217	0		19.53	19.50	19.43	19.67	19.53	19.50	22.61	22.53	22.48		
80	1	1	16-QAM	20.48	20.41	20.65	20.98	21.10	20.90	23.75	23.78	23.79	27.29	0.5358
80	1	1	64-QAM	18.78	18.76	18.88	19.11	19.11	19.03	21.96	21.95	21.97		
80	1	1	256-QAM	15.95	15.98	16.06	16.37	16.37	16.35	19.18	19.19	19.22		
Limit	EIRP < 1W			Result									Pass	



5G FR1 n77 Maximum Average Power [dBm], DG = 3.5 dBi														
BW (MHz)	RB Size	RB Offset	Mod	Antenna 4			Antenna 6			Combine			EIRP (dBm)	EIRP (W)
				Lowest	Middle	Highest	Lowest	Middle	Highest	Lowest	Middle	Highest		
90	1	1	QPSK	21.14	21.04	21.01	21.48	21.31	21.35	24.32	24.19	24.19	27.82	0.6053
90	1	243		20.95	20.81	20.94	20.90	20.87	20.76	23.94	23.85	23.86		
90	123	61		20.92	20.98	21.07	21.11	21.14	21.11	24.03	24.07	24.10		
90	1	0		18.94	19.01	19.01	19.42	19.41	19.35	22.20	22.22	22.19		
90	1	244		18.69	18.73	18.82	18.85	18.77	18.78	21.78	21.76	21.81		
90	245	0		19.38	19.37	19.48	19.61	19.61	19.58	22.51	22.50	22.54		
90	1	1	16-QAM	21.14	20.49	20.54	21.38	20.98	21.01	24.27	23.75	23.79	27.77	0.5984
90	1	1	64-QAM	18.75	18.78	18.84	19.14	19.15	19.23	21.96	21.98	22.05		
90	1	1	256-QAM	15.98	15.91	16.02	16.42	16.39	16.39	19.22	19.17	19.22		
Limit	EIRP < 1W			Result									Pass	

5G FR1 n77 Maximum Average Power [dBm], DG = 3.5 dBi														
BW (MHz)	RB Size	RB Offset	Mod	Antenna 4			Antenna 6			Combine			EIRP (dBm)	EIRP (W)
				Lowest	Middle	Highest	Lowest	Middle	Highest	Lowest	Middle	Highest		
100	1	1	QPSK	-	21.21	-	-	21.12	-	-	24.18	-	27.68	0.5861
100	1	271		-	20.62	-	-	20.38	-	-	23.51	-		
100	137	68		-	20.96	-	-	20.79	-	-	23.89	-		
100	1	0		-	19.42	-	-	18.94	-	-	22.20	-		
100	1	272		-	18.68	-	-	18.39	-	-	21.55	-		
100	273	0		-	19.45	-	-	19.31	-	-	22.39	-		
100	1	1	16-QAM	-	20.67	-	-	20.31	-	-	23.50	-	27.00	0.5012
100	1	1	64-QAM	-	19.31	-	-	18.93	-	-	22.13	-		
100	1	1	256-QAM	-	16.23	-	-	16.05	-	-	19.15	-		
Limit	EIRP < 1W			Result									Pass	



# FR1 n77

<SISO Mode>

## Peak-to-Average Ratio

Mode	FR1 n77 / 20MHz / DFT-S OFDM				
Mod.	PI/2 BPSK	QPSK	16QAM	64QAM	Limit: 13dB
RB Size	Full RB	Full RB	Full RB	Full RB	Result
Middle CH	4.04	4.72	5.60	7.44	PASS
Mode	FR1 n77 / 20MHz / DFT-S OFDM				
Mod.	256QAM				Limit: 13dB
RB Size	Full RB				Result
Middle CH	6.66				PASS



FR1 n77 / 20MHz / DFT-S OFDM / Middle Channel / Full RB

PI/2 BPSK

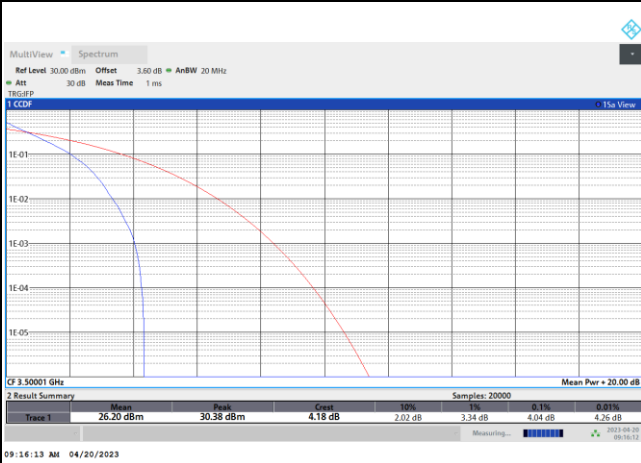

QPSK

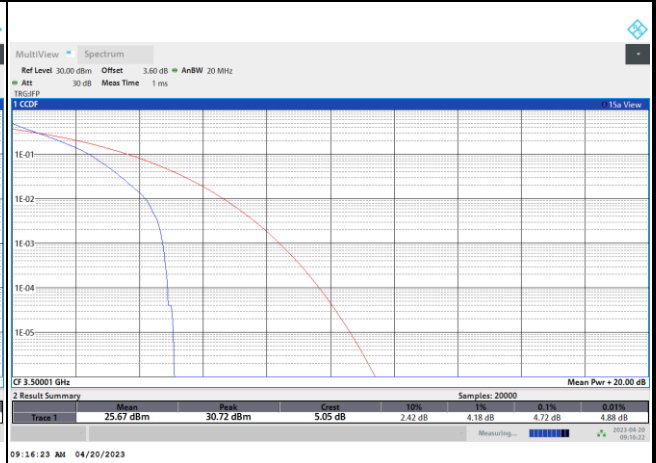

16QAM

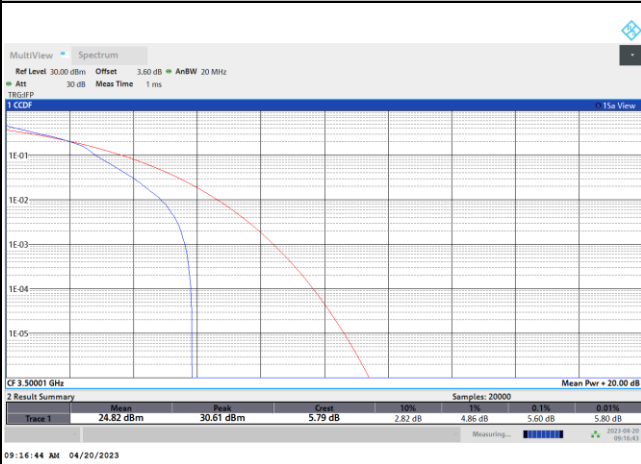

64QAM

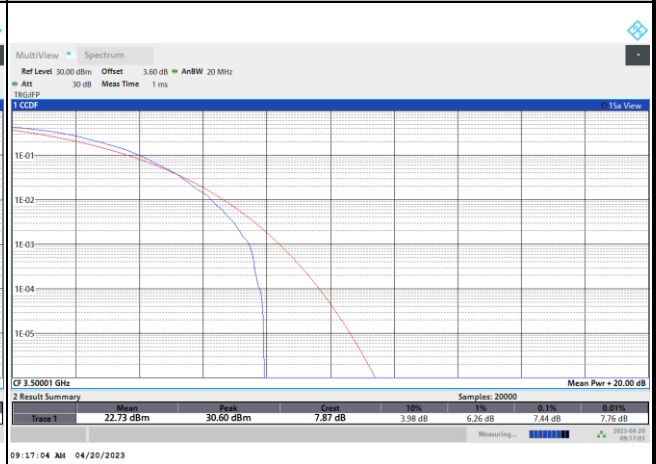

256QAM

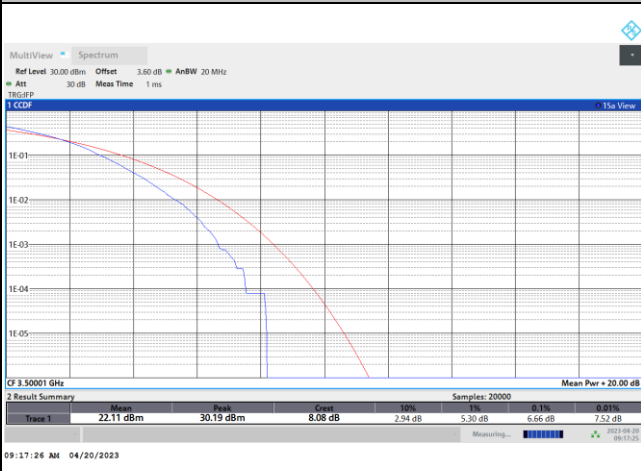





**26dB Bandwidth**

Mode	FR1 n77 : 26dB BW(MHz) / DFT-S OFDM							
BW	10MHz	15MHz	20MHz	25MHz	30MHz	40MHz	50MHz	60MHz
Mod.	PI/2 BPSK	PI/2 BPSK	PI/2 BPSK	PI/2 BPSK	PI/2 BPSK	PI/2 BPSK	PI/2 BPSK	PI/2 BPSK
Middle CH	9.67	14.24	19.38	-	28.47	38.12	48.65	60.54
BW	70MHz	80MHz	90MHz	100MHz				
Mod.	PI/2 BPSK	PI/2 BPSK	PI/2 BPSK	PI/2 BPSK				
Middle CH	66.99	80.40	89.73	99.70				

Mode	FR1 n77 : 26dB BW(MHz) / CP OFDM							
BW	10MHz		15MHz		20MHz		25MHz	
Mod.	QPSK	16QAM	QPSK	16QAM	QPSK	16QAM	QPSK	16QAM
Middle CH	9.73	9.93	15.23	15.08	19.66	19.50	-	-
Mod.	64QAM	256QAM	64QAM	256QAM	64QAM	256QAM	64QAM	256QAM
Middle CH	9.87	9.77	15.11	15.02	19.62	19.50	-	-
BW	30MHz		40MHz		50MHz		60MHz	
Mod.	QPSK	16QAM	QPSK	16QAM	QPSK	16QAM	QPSK	16QAM
Middle CH	29.31	29.37	40.68	40.76	50.45	50.55	60.66	60.90
Mod.	64QAM	256QAM	64QAM	256QAM	64QAM	256QAM	64QAM	256QAM
Middle CH	29.37	29.25	40.36	40.60	50.25	50.05	60.78	60.54
BW	70MHz		80MHz		90MHz		100MHz	
Mod.	QPSK	16QAM	QPSK	16QAM	QPSK	16QAM	QPSK	16QAM
Middle CH	70.77	70.49	80.24	80.72	90.45	90.45	100.70	101.30
Mod.	64QAM	256QAM	64QAM	256QAM	64QAM	256QAM	64QAM	256QAM
Middle CH	70.49	70.49	80.56	80.24	90.63	90.45	101.10	100.70



FR1 n77 / 10MHz / DFT-S OFDM / Middle Channel / Full RB

PI/2 BPSK

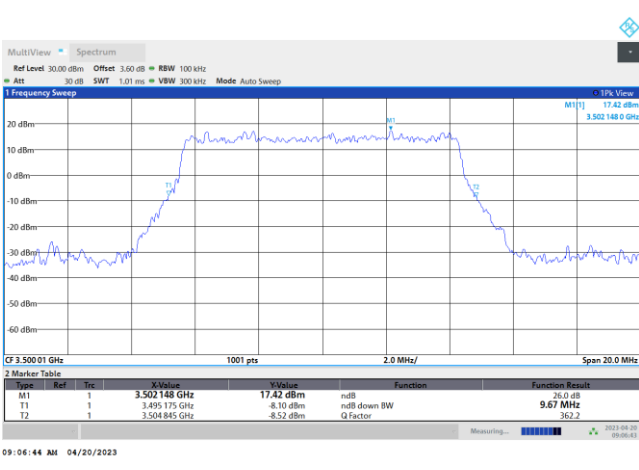

FR1 n77 / 10MHz / CP OFDM / Middle Channel / Full RB

QPSK

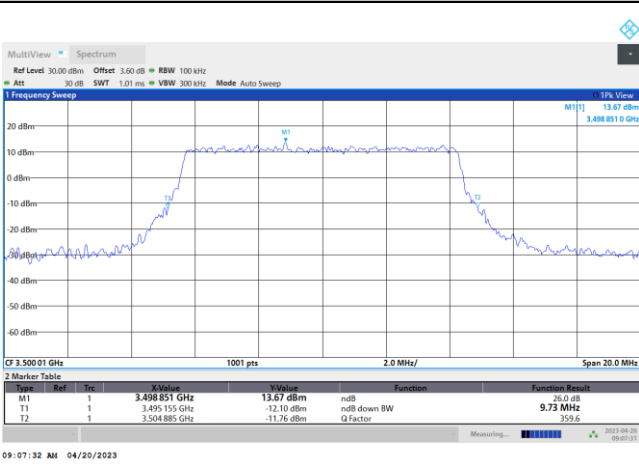

16QAM

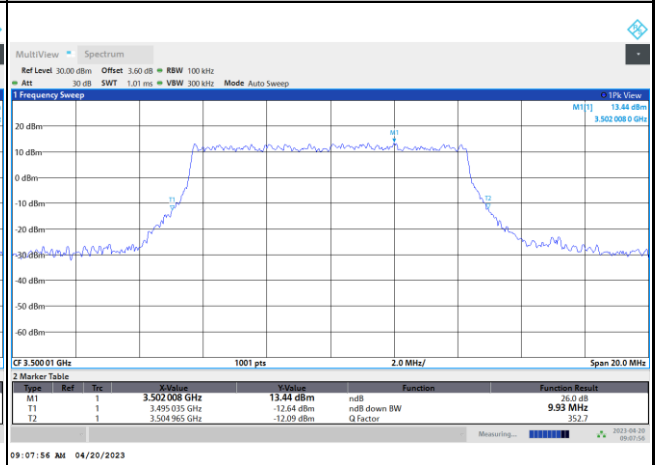

64QAM

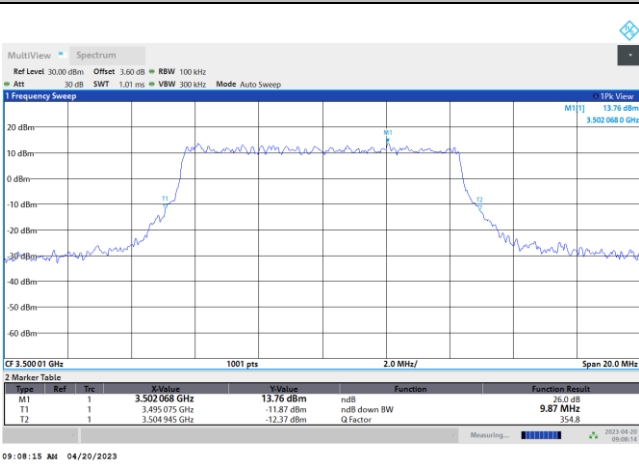

256QAM

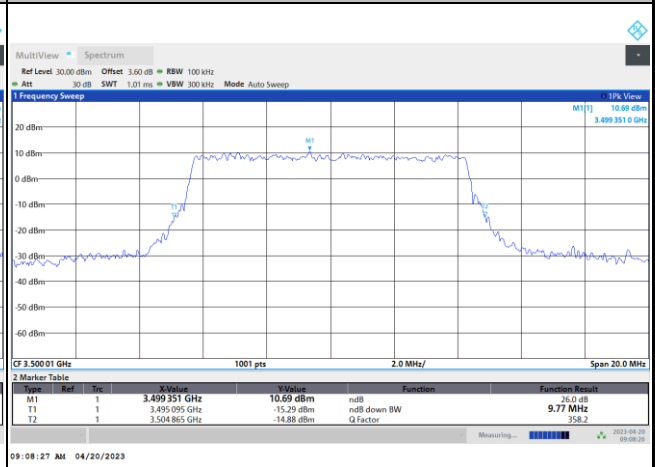



FR1 n77 / 15MHz / DFT-S OFDM / Middle Channel / Full RB

PI/2 BPSK

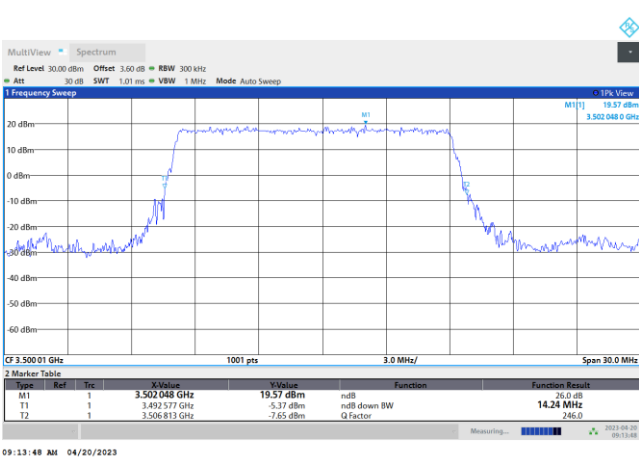

FR1 n77 / 15MHz / CP OFDM / Middle Channel / Full RB

QPSK

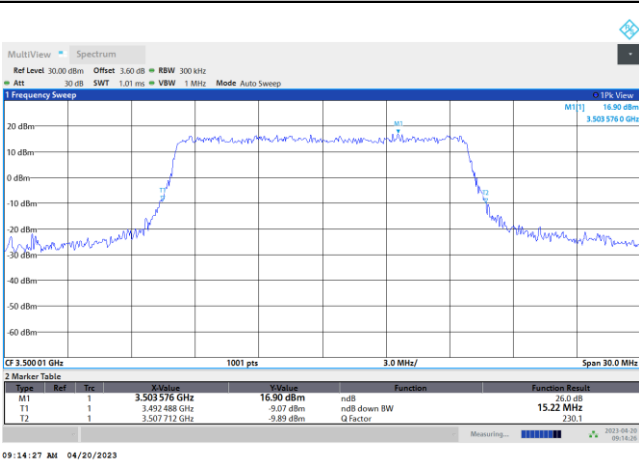

16QAM

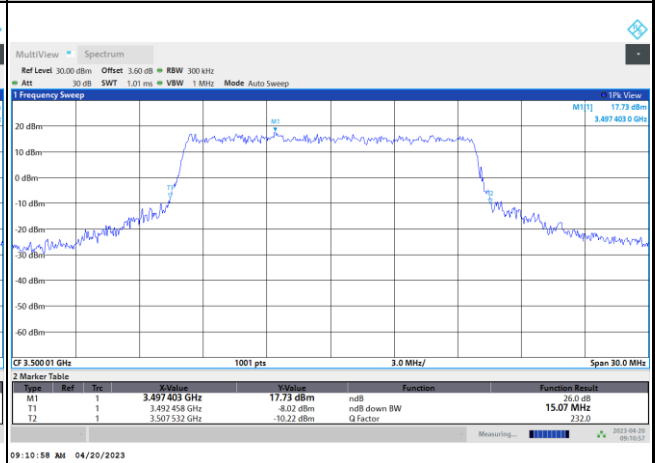

64QAM

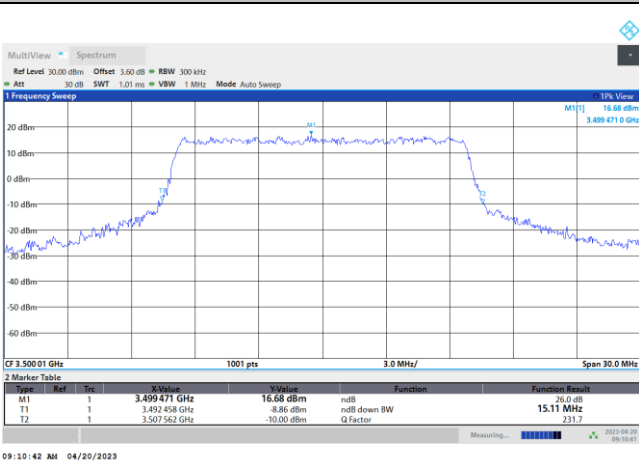

256QAM

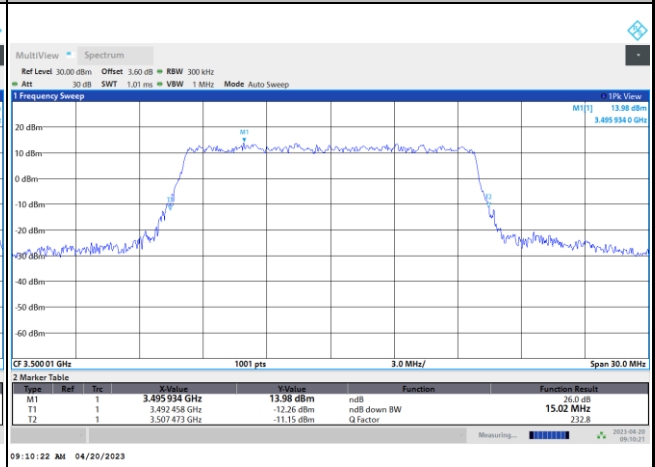



FR1 n77 / 20MHz / DFT-S OFDM / Middle Channel / Full RB

PI/2 BPSK

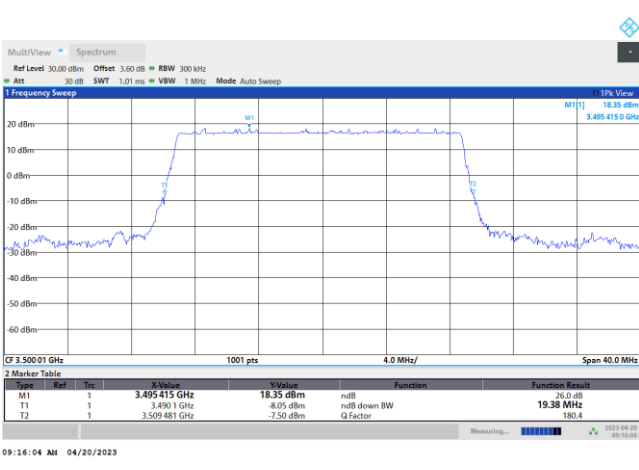

FR1 n77 / 20MHz / CP OFDM / Middle Channel / Full RB

QPSK

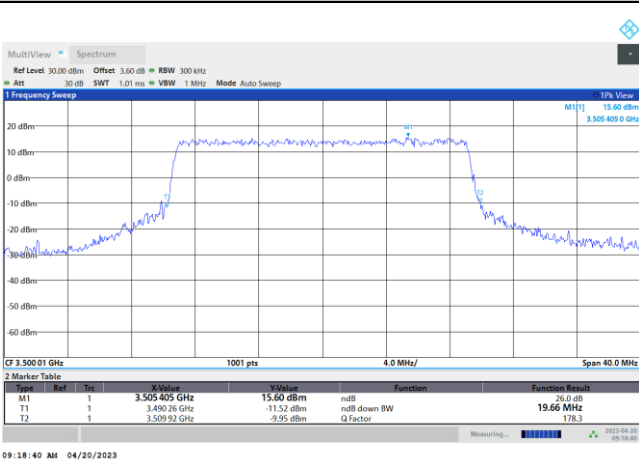

16QAM

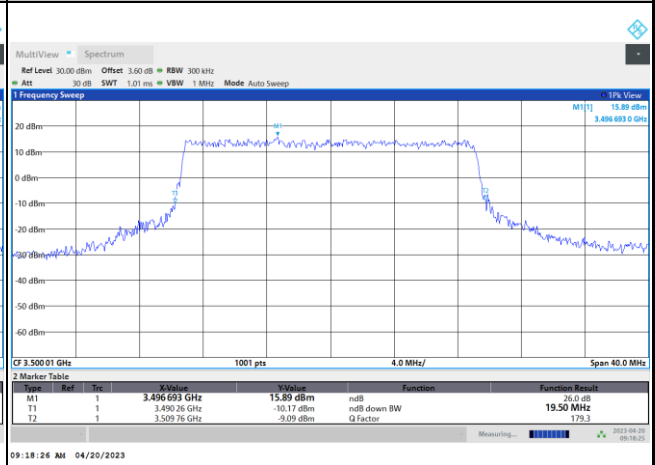

64QAM

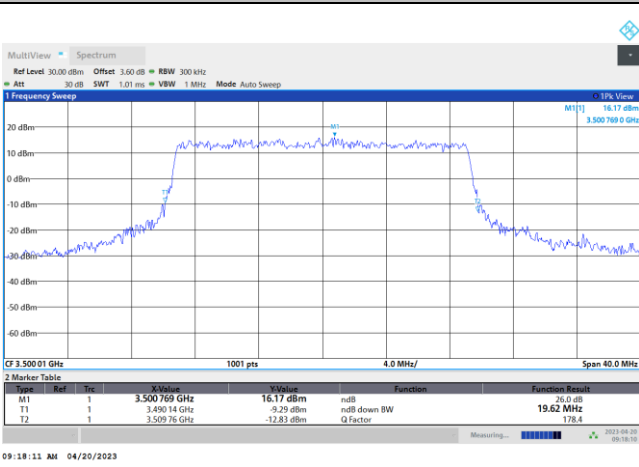

256QAM

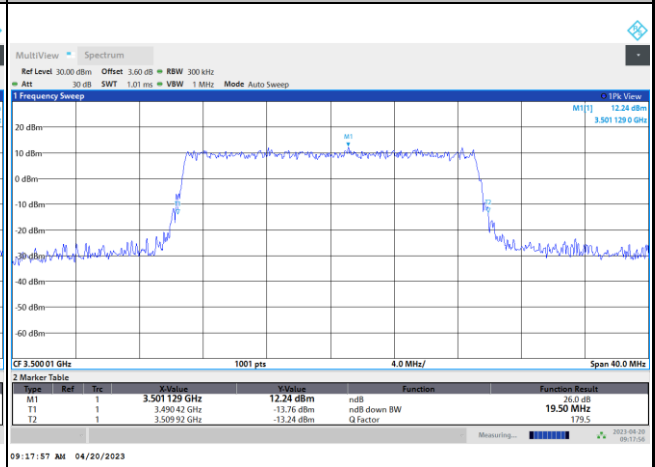



FR1 n77 / 30MHz / DFT-S OFDM / Middle Channel / Full RB

PI/2 BPSK

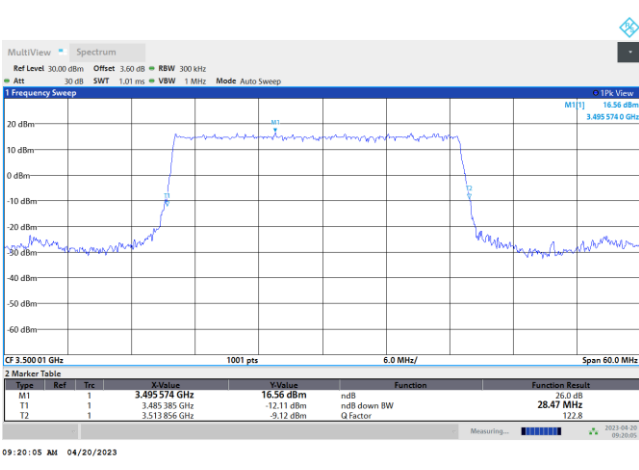

FR1 n77 / 30MHz / CP OFDM / Middle Channel / Full RB

QPSK

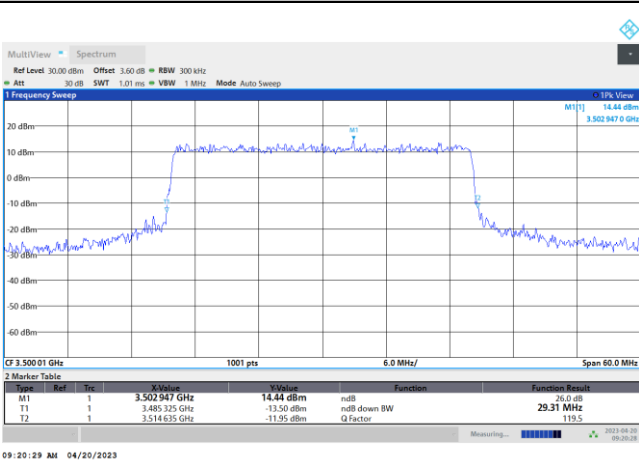

16QAM

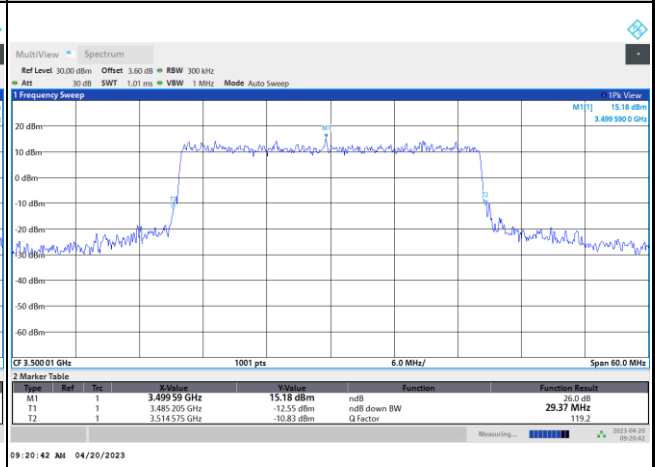

64QAM

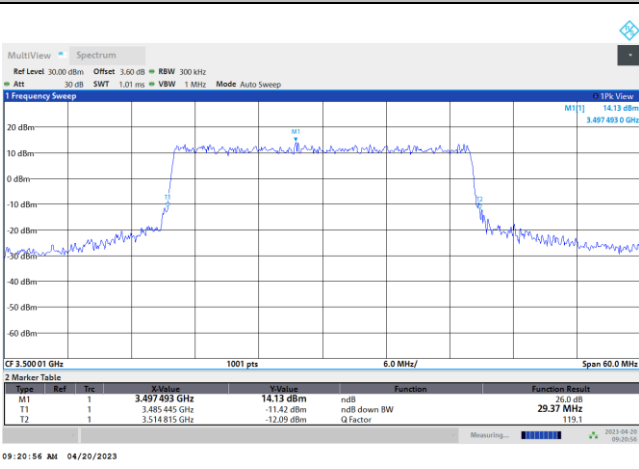

256QAM

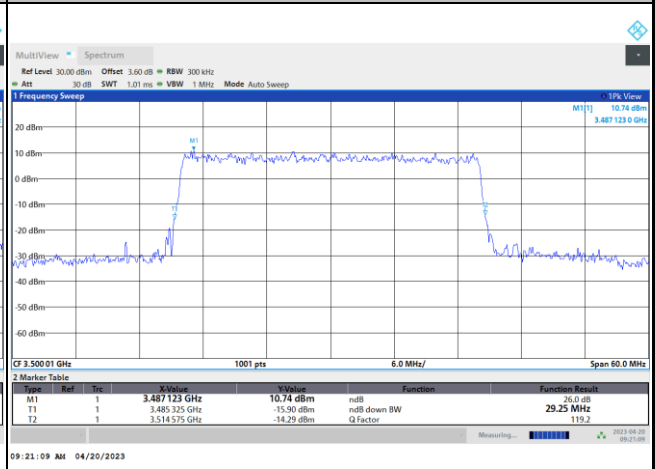



FR1 n77 / 40MHz / DFT-S OFDM / Middle Channel / Full RB

PI/2 BPSK

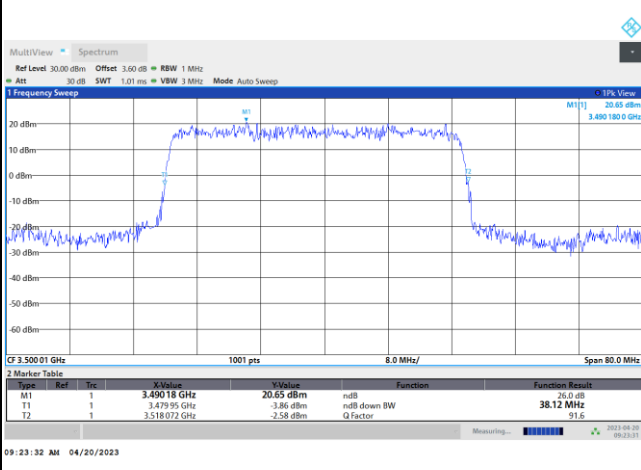

FR1 n77 / 40MHz / CP OFDM / Middle Channel / Full RB

QPSK

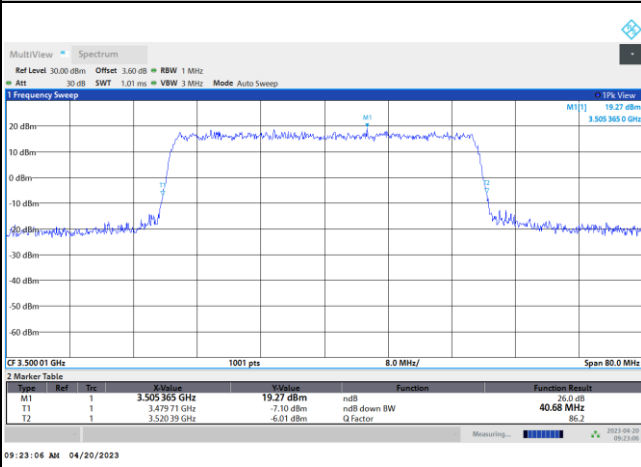

16QAM

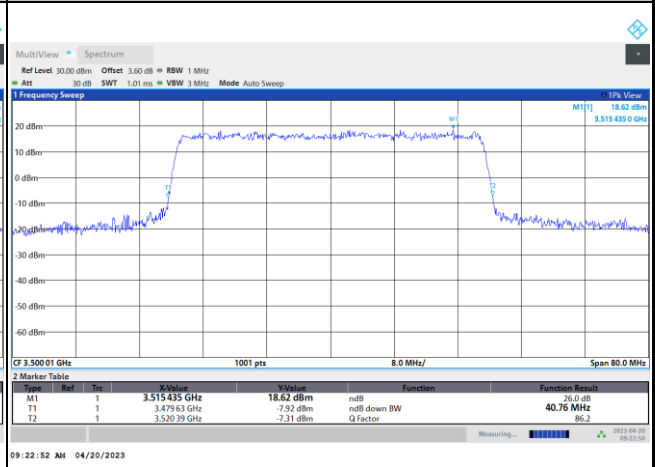

64QAM

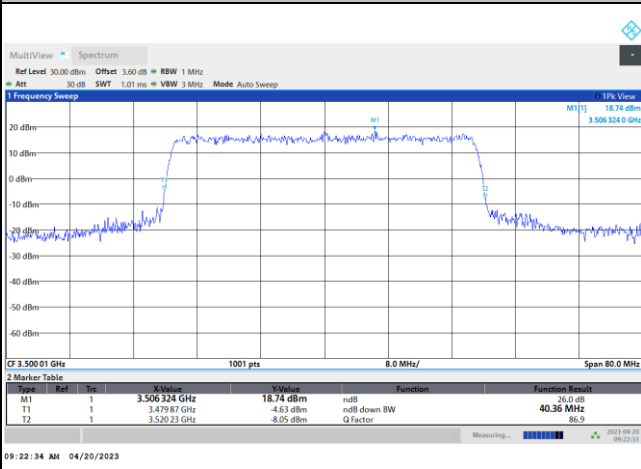

256QAM

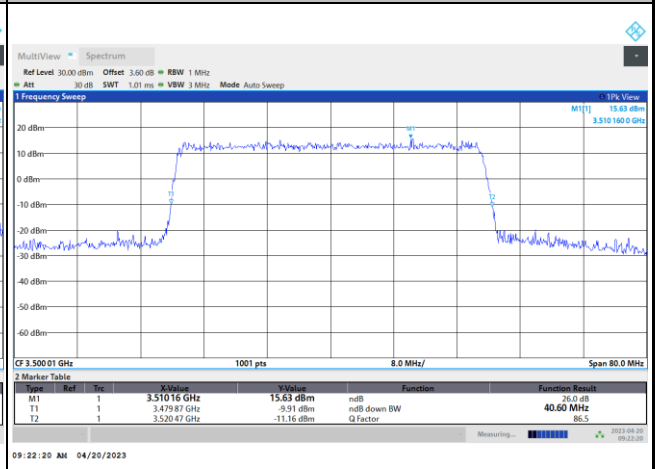



FR1 n77 / 50MHz / DFT-S OFDM / Middle Channel / Full RB

PI/2 BPSK

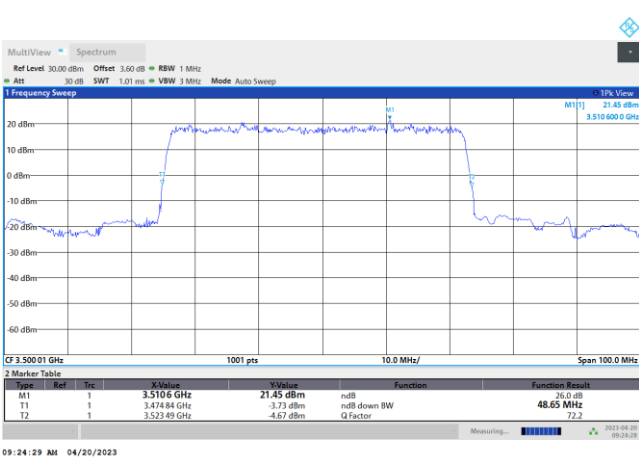

FR1 n77 / 50MHz / CP OFDM / Middle Channel / Full RB

QPSK

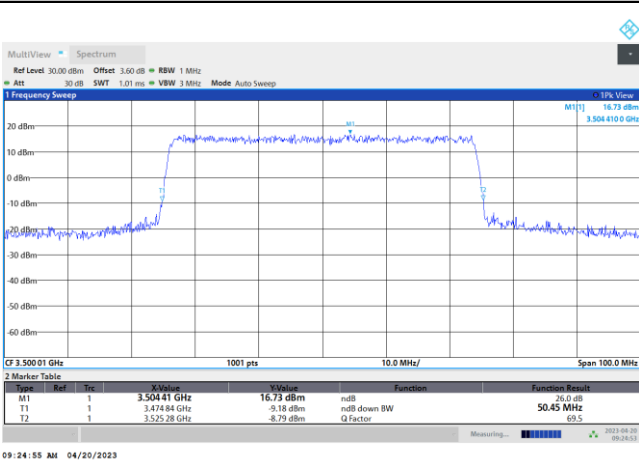

16QAM

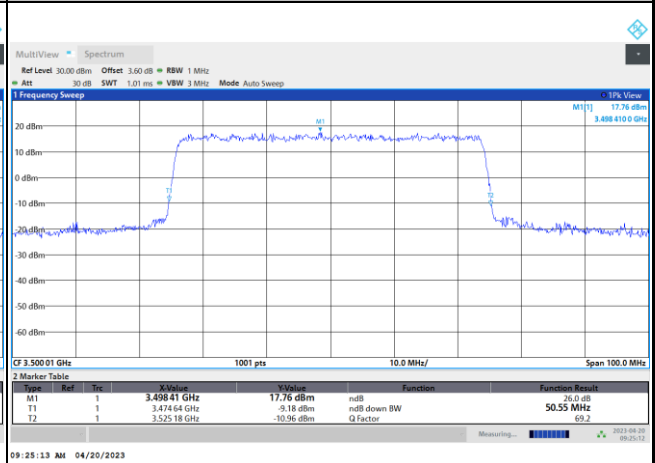

64QAM

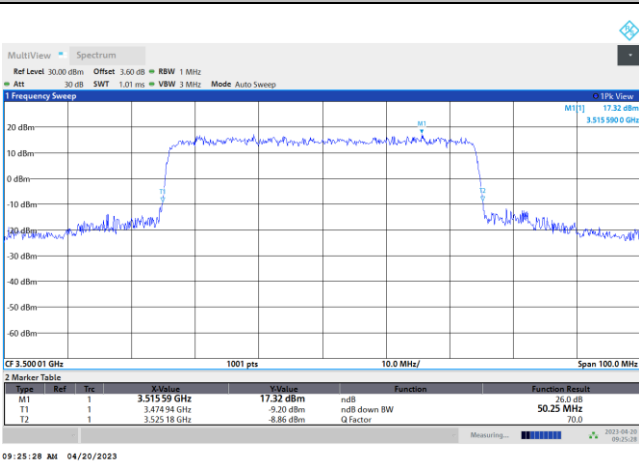

256QAM

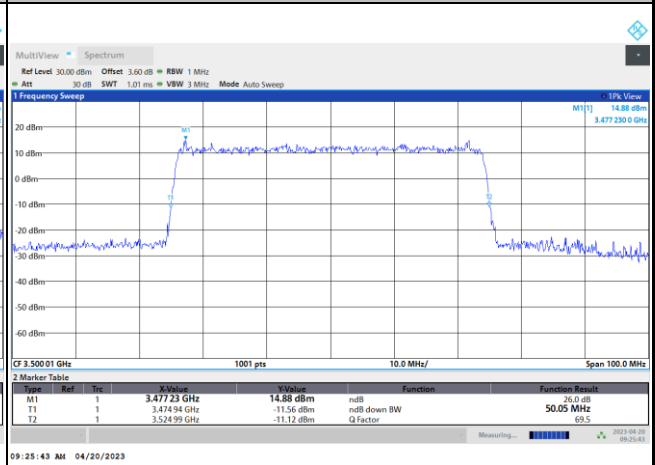



FR1 n77 / 60MHz / DFT-S OFDM / Middle Channel / Full RB

PI/2 BPSK

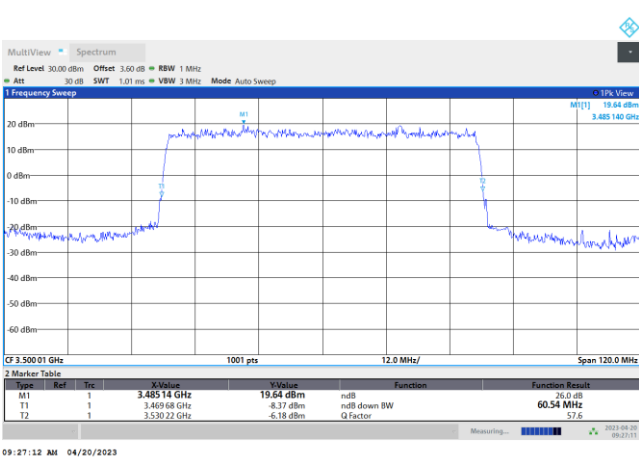

FR1 n77 / 60MHz / CP OFDM / Middle Channel / Full RB

QPSK

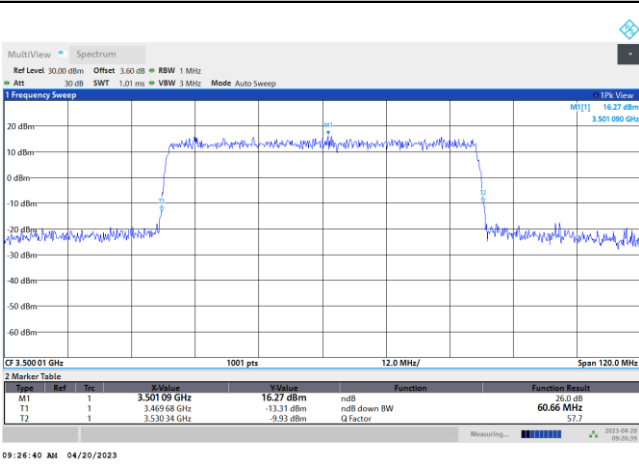

16QAM

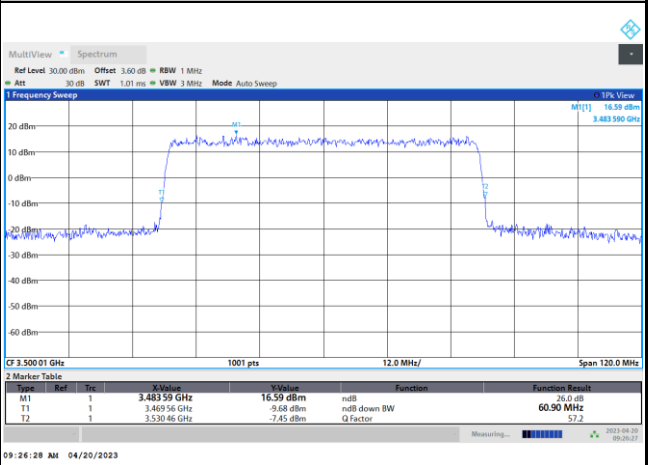

64QAM

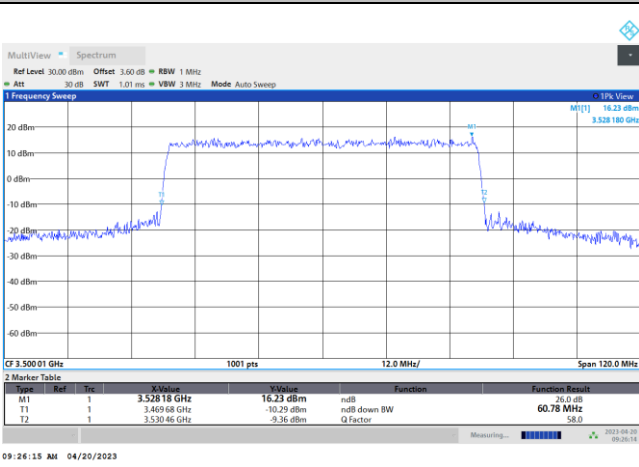

256QAM

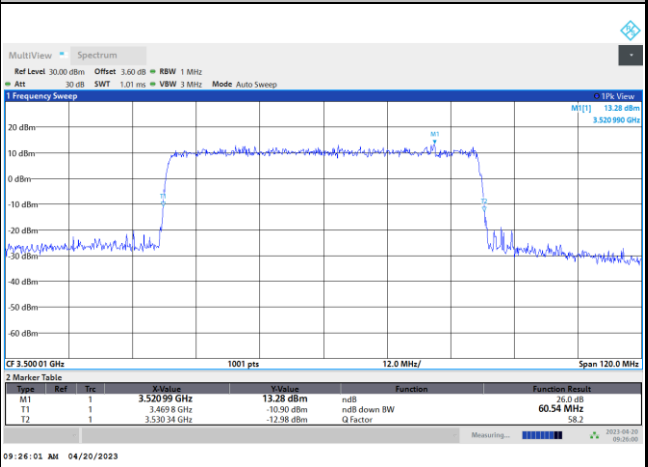





FR1 n77 / 70MHz / DFT-S OFDM / Middle Channel / Full RB

PI/2 BPSK

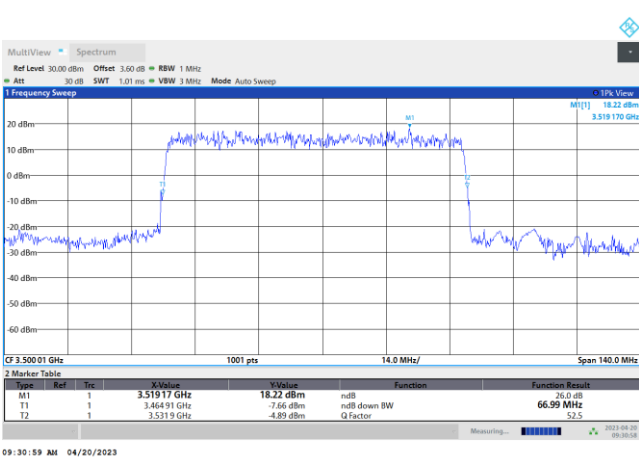

FR1 n77 / 70MHz / CP OFDM / Middle Channel / Full RB

QPSK

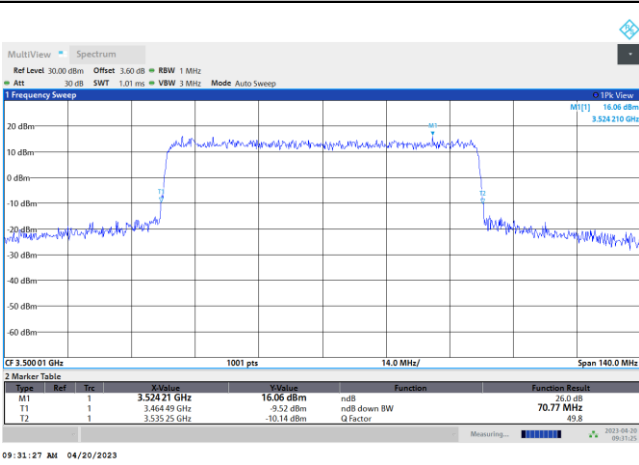

16QAM

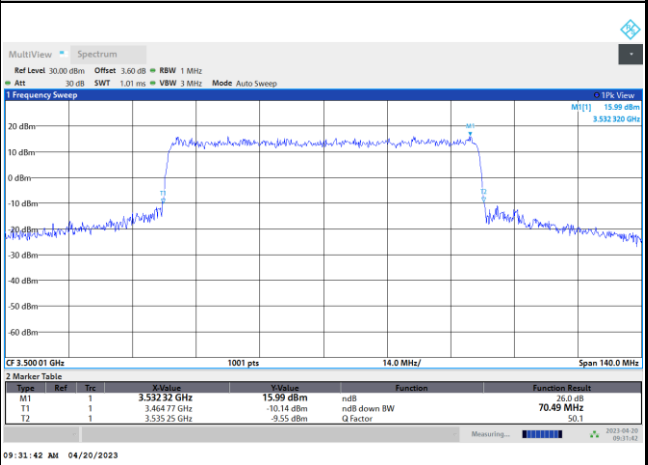

64QAM

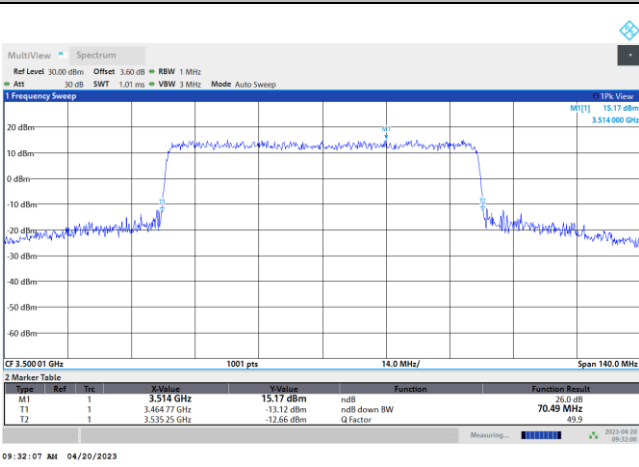

256QAM

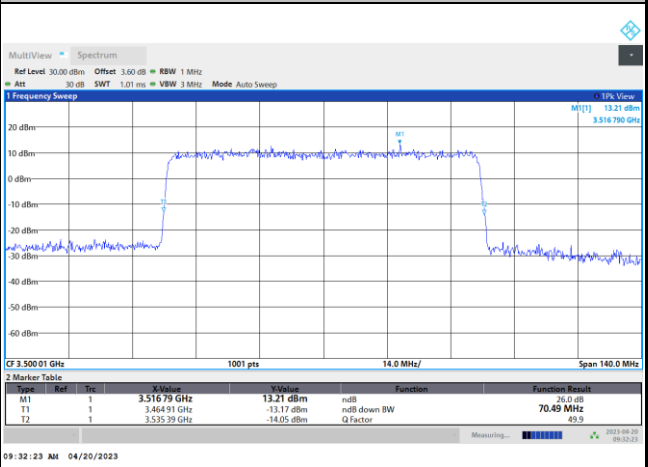



FR1 n77 / 80MHz / DFT-S OFDM / Middle Channel / Full RB

PI/2 BPSK

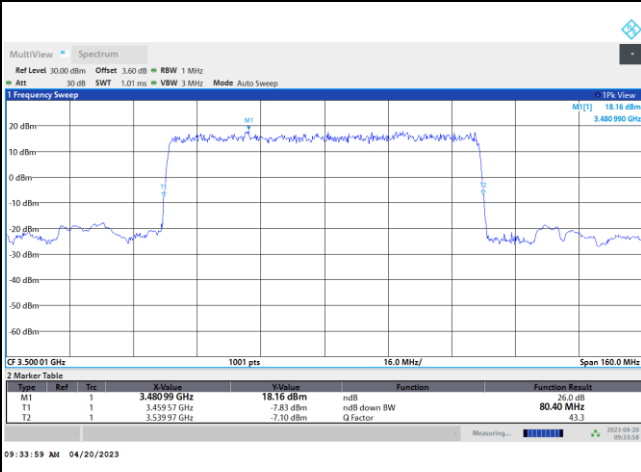

FR1 n77 / 80MHz / CP OFDM / Middle Channel / Full RB

QPSK

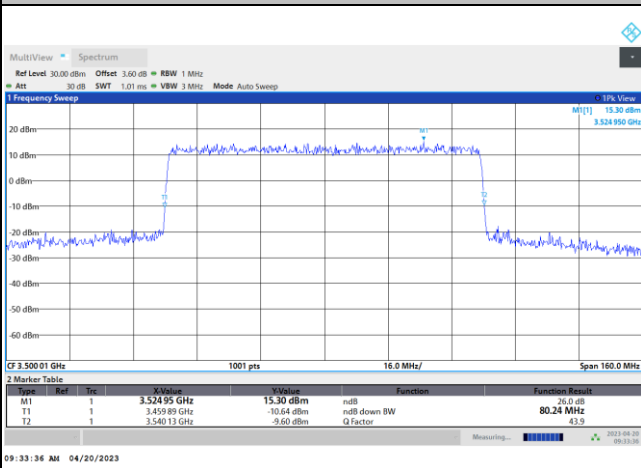

16QAM

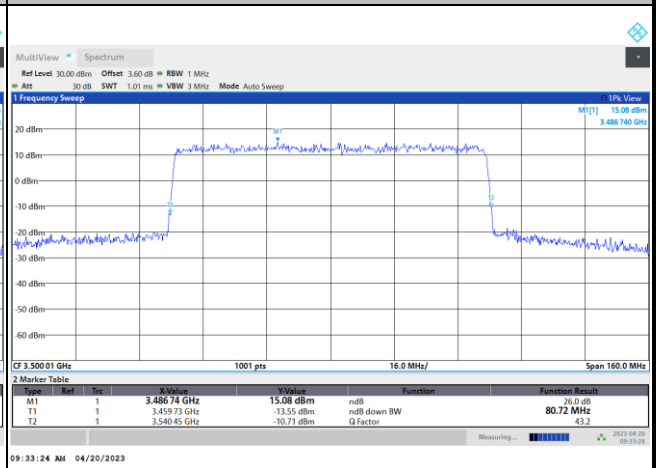

64QAM

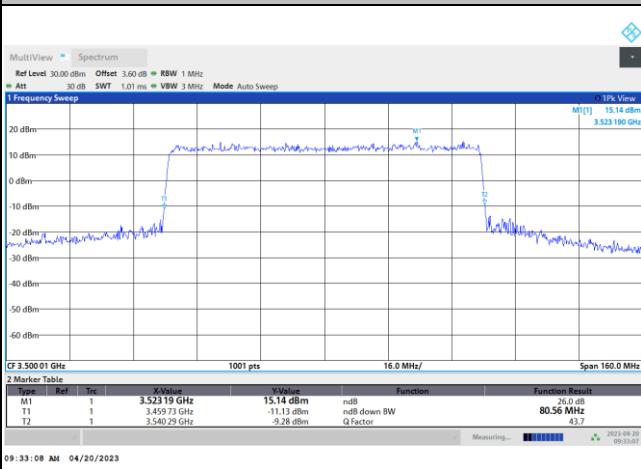

256QAM

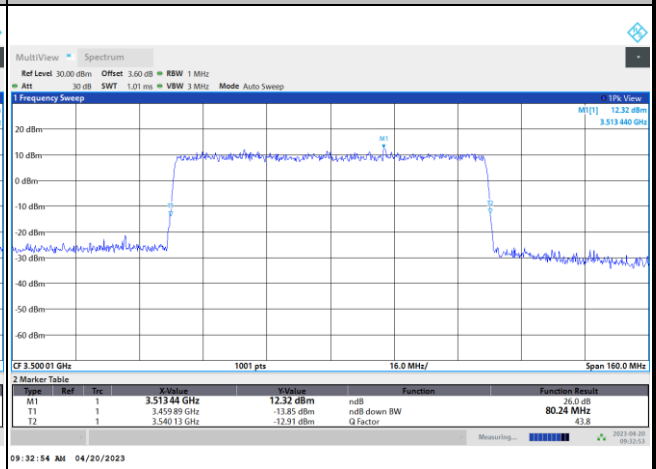



FR1 n77 / 90MHz / DFT-S OFDM / Middle Channel / Full RB

PI/2 BPSK

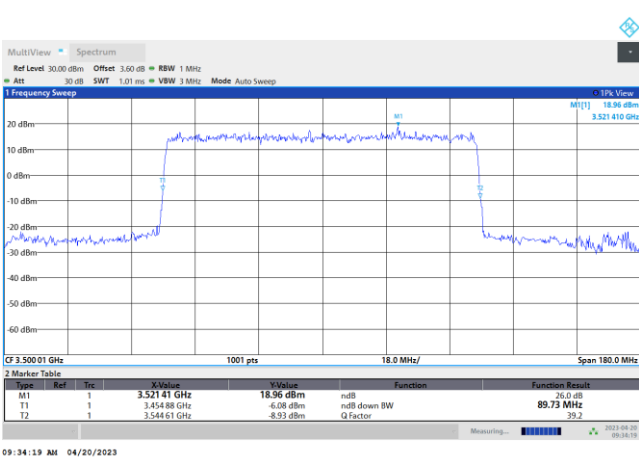

FR1 n77 / 90MHz / CP OFDM / Middle Channel / Full RB

QPSK

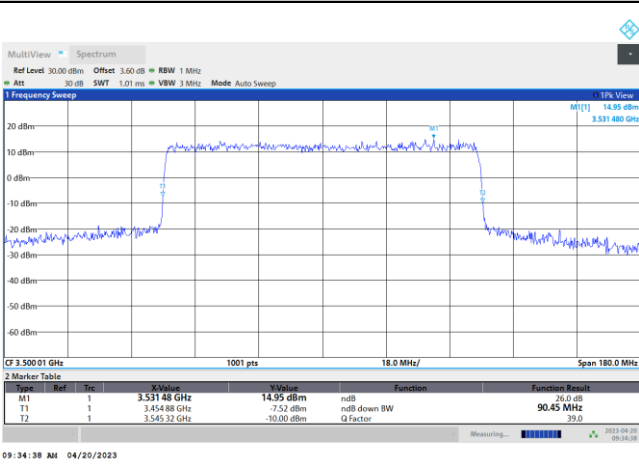

16QAM

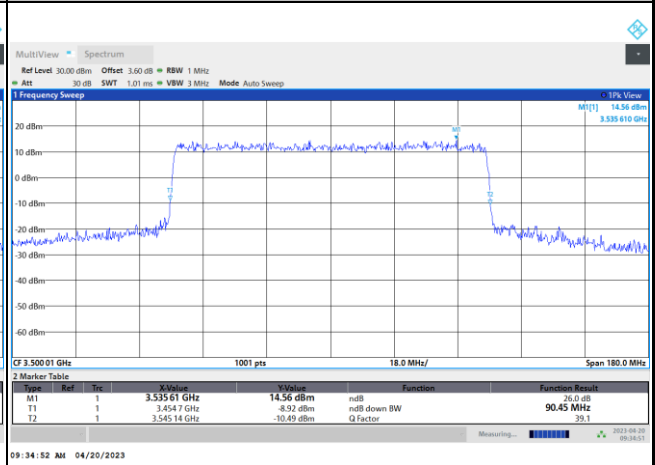

64QAM

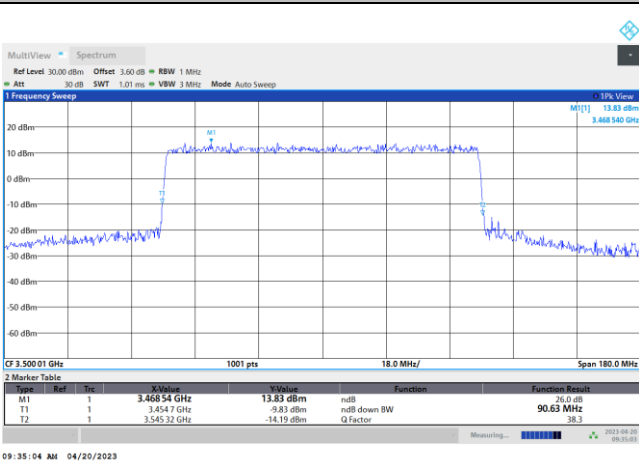

256QAM

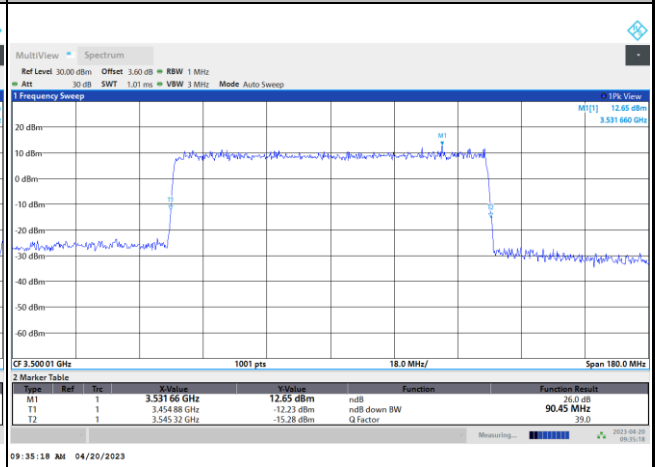



FR1 n77 / 100MHz / DFT-S OFDM / Middle Channel / Full RB

PI/2 BPSK

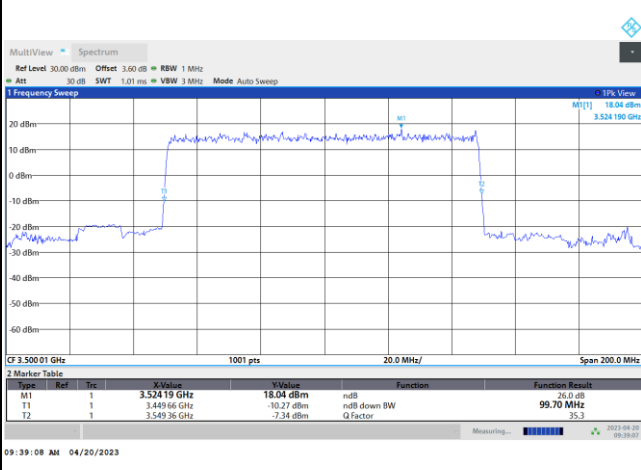

FR1 n77 / 100MHz / CP OFDM / Middle Channel / Full RB

QPSK

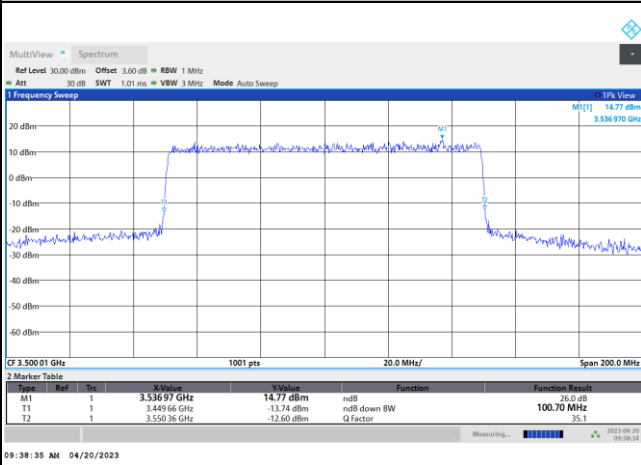

16QAM

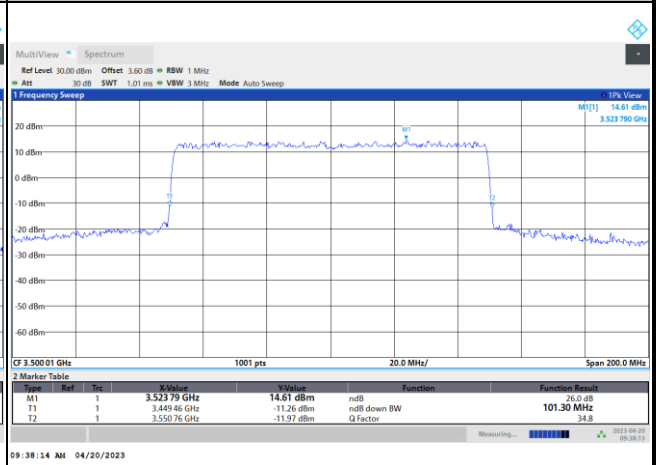

64QAM

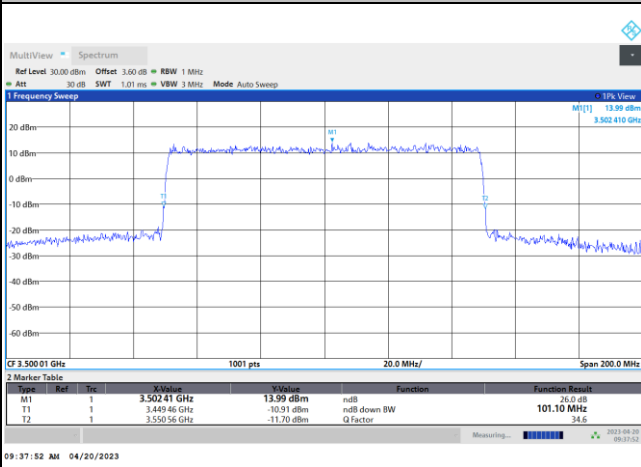

256QAM

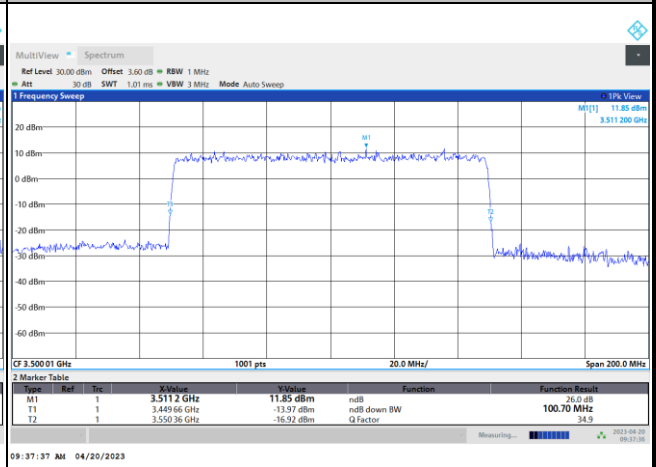



### Occupied Bandwidth

Mode	FR1 n77 : OB BW(MHz) / DFT-S OFDM							
BW	10MHz	15MHz	20MHz	25MHz	30MHz	40MHz	50MHz	60MHz
Mod.	PI/2 BPSK	PI/2 BPSK	PI/2 BPSK	PI/2 BPSK	PI/2 BPSK	PI/2 BPSK	PI/2 BPSK	PI/2 BPSK
Middle CH	8.61	12.98	17.86	-	26.79	35.92	45.84	57.83
BW	70MHz	80MHz	90MHz	100MHz				
Mod.	PI/2 BPSK	PI/2 BPSK	PI/2 BPSK	PI/2 BPSK				
Middle CH	64.30	76.85	86.55	96.25				

Mode	FR1 n77 : OB BW(MHz) / CP OFDM							
BW	10MHz		15MHz		20MHz		25MHz	
Mod.	QPSK	16QAM	QPSK	16QAM	QPSK	16QAM	QPSK	16QAM
Middle CH	8.62	8.61	13.66	13.61	18.22	18.21	-	-
Mod.	64QAM	256QAM	64QAM	256QAM	64QAM	256QAM	64QAM	256QAM
Middle CH	8.65	8.59	13.66	13.64	18.25	18.28	-	-
BW	30MHz		40MHz		50MHz		60MHz	
Mod.	QPSK	16QAM	QPSK	16QAM	QPSK	16QAM	QPSK	16QAM
Middle CH	27.84	27.84	38.08	38.12	47.47	47.55	57.84	57.92
Mod.	64QAM	256QAM	64QAM	256QAM	64QAM	256QAM	64QAM	256QAM
Middle CH	27.88	27.87	38.02	38.16	47.55	47.63	57.85	57.77
BW	70MHz		80MHz		90MHz		100MHz	
Mod.	QPSK	16QAM	QPSK	16QAM	QPSK	16QAM	QPSK	16QAM
Middle CH	67.37	67.45	77.32	77.47	87.49	87.40	97.30	97.26
Mod.	64QAM	256QAM	64QAM	256QAM	64QAM	256QAM	64QAM	256QAM
Middle CH	67.48	67.42	77.32	77.44	87.40	87.41	97.25	97.33



FR1 n77 / 10MHz / DFT-S OFDM / Middle Channel / Full RB

PI/2 BPSK

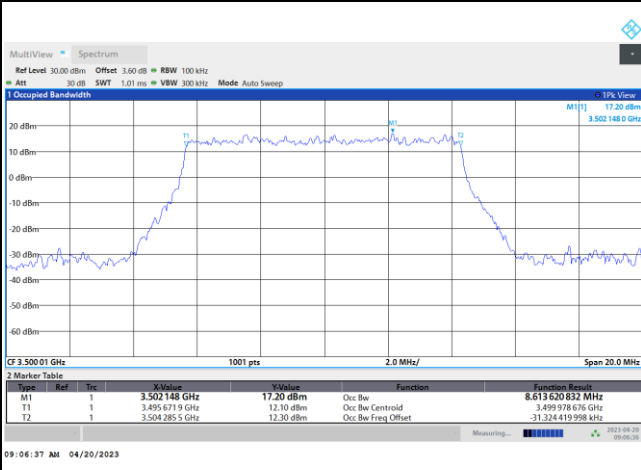

FR1 n77 / 10MHz / CP OFDM / Middle Channel / Full RB

QPSK

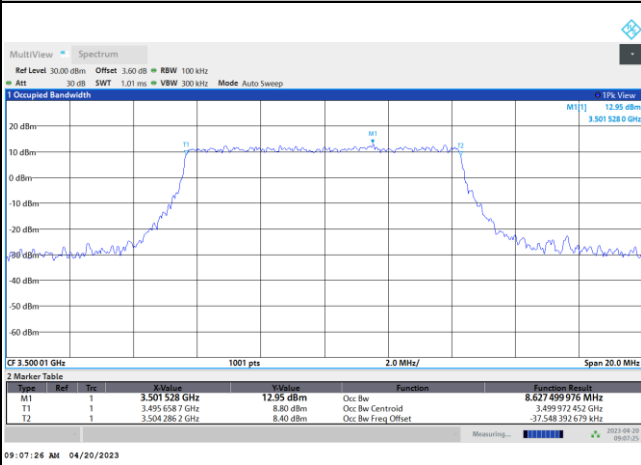

16QAM

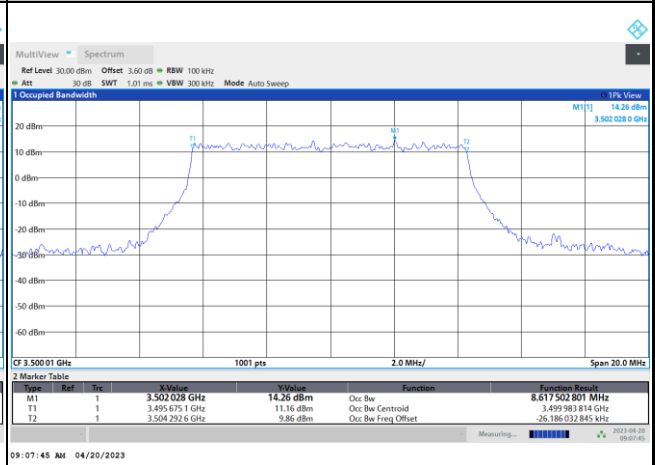

64QAM

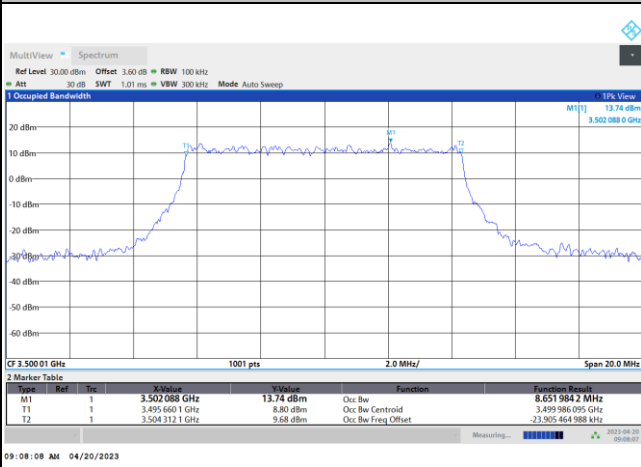

256QAM

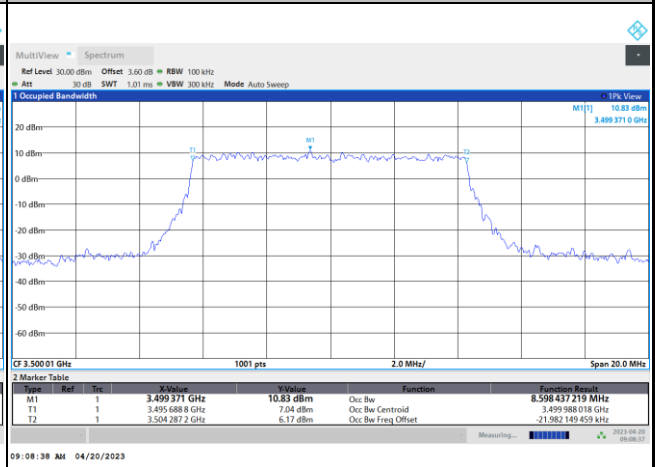



FR1 n77 / 15MHz / DFT-S OFDM / Middle Channel / Full RB

PI/2 BPSK

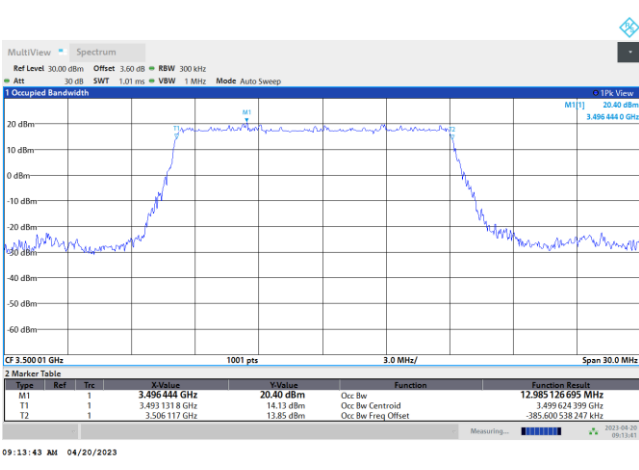

FR1 n77 / 15MHz / CP OFDM / Middle Channel / Full RB

QPSK

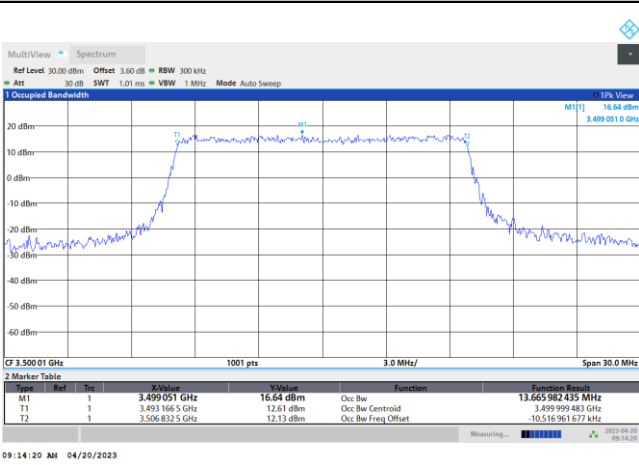

16QAM

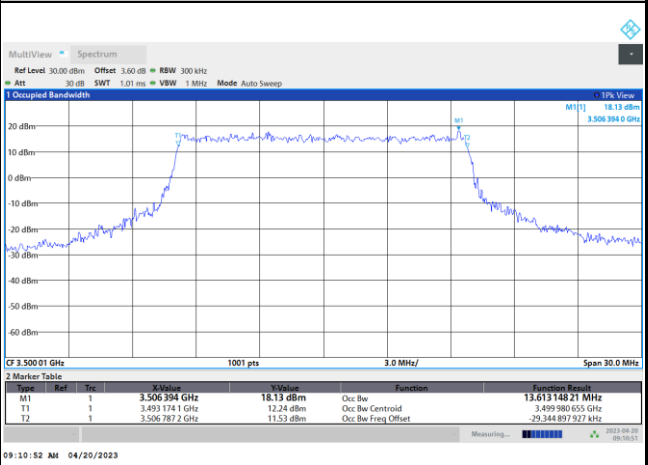

64QAM

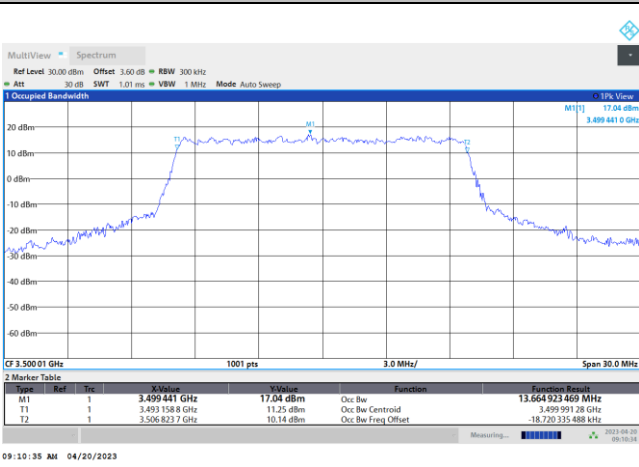

256QAM

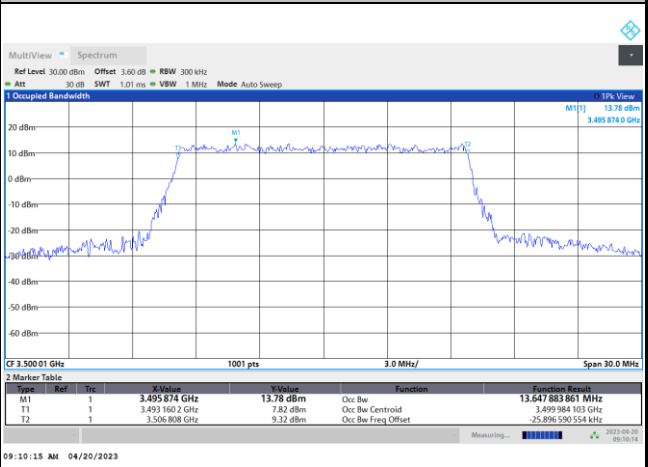



FR1 n77 / 20MHz / DFT-S OFDM / Middle Channel / Full RB

PI/2 BPSK

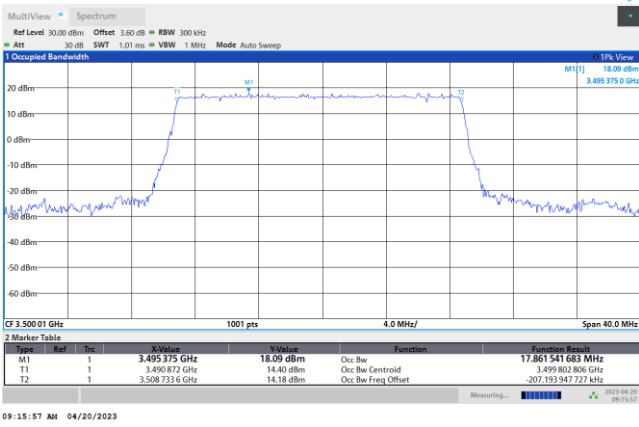

FR1 n77 / 20MHz / CP OFDM / Middle Channel / Full RB

QPSK

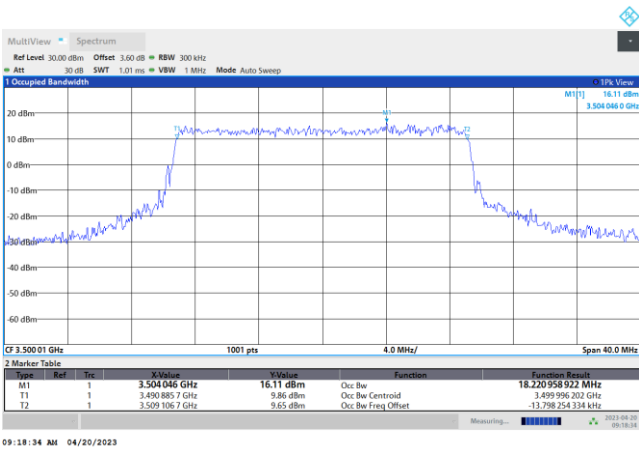

16QAM

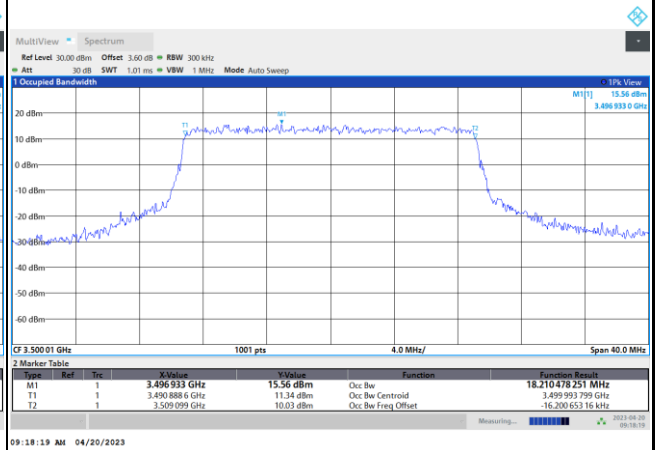

64QAM

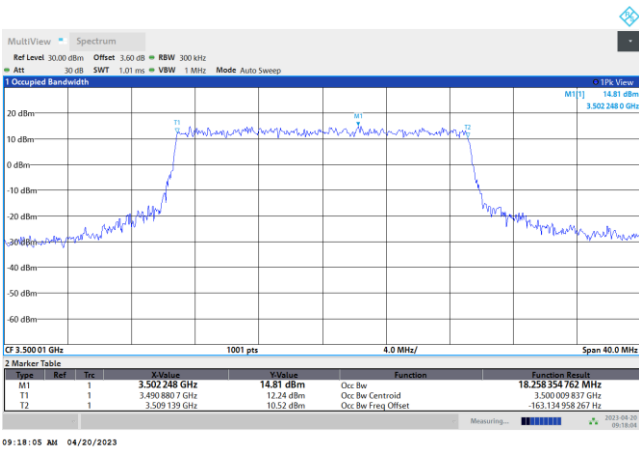

256QAM

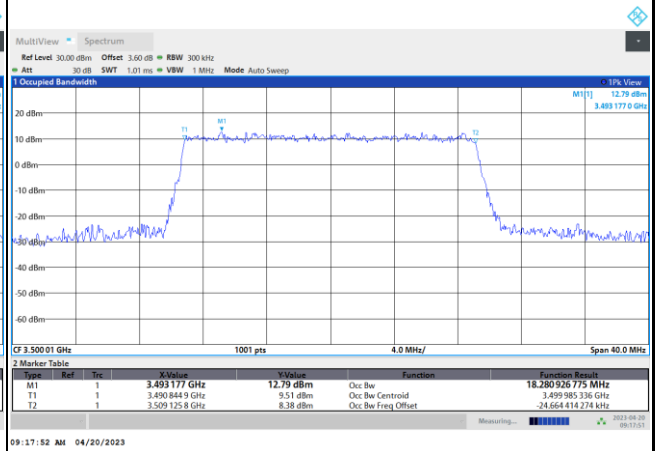





FR1 n77 / 30MHz / DFT-S OFDM / Middle Channel / Full RB

PI/2 BPSK

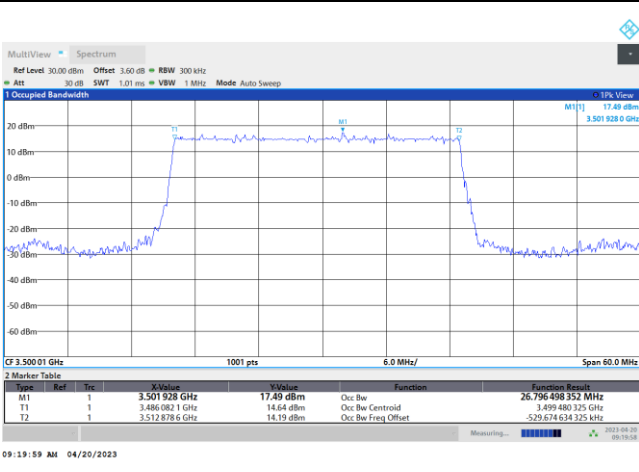

FR1 n77 / 30MHz / CP OFDM / Middle Channel / Full RB

QPSK

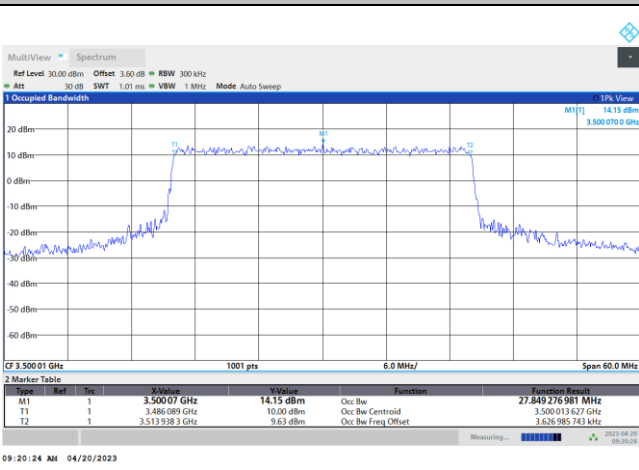

16QAM

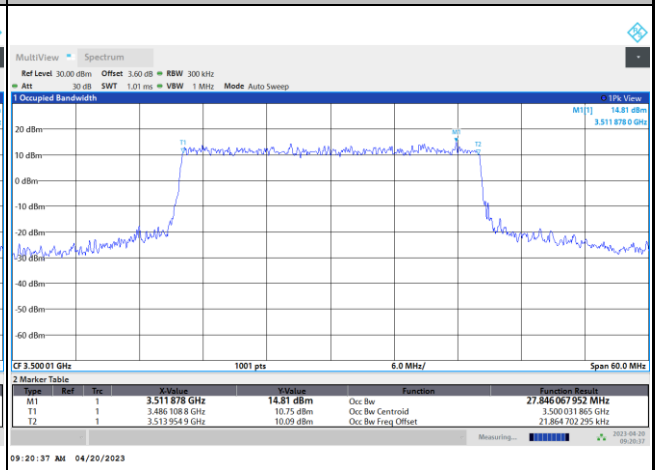

64QAM

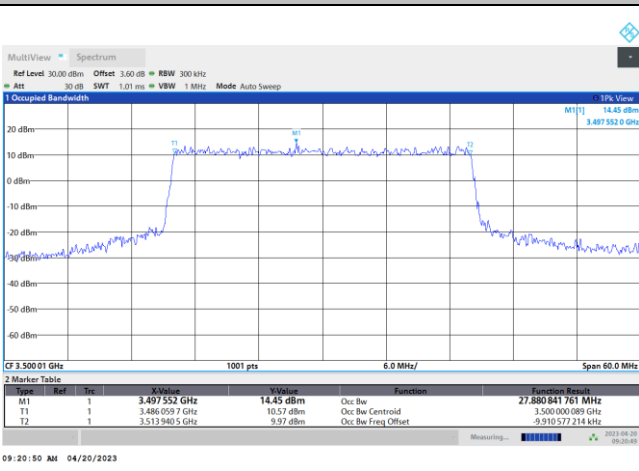

256QAM

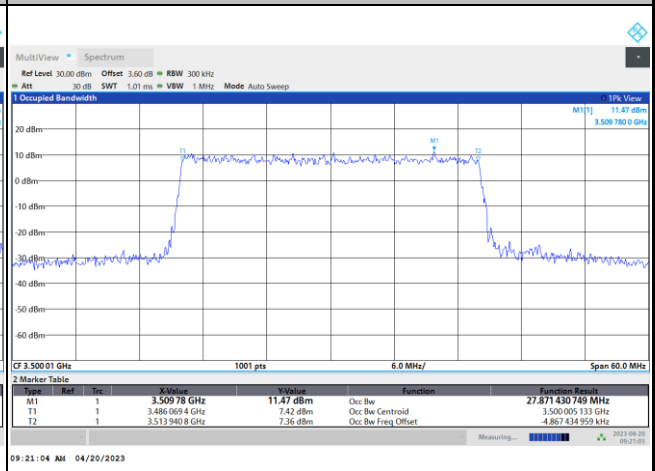



FR1 n77 / 40MHz / DFT-S OFDM / Middle Channel / Full RB

PI/2 BPSK

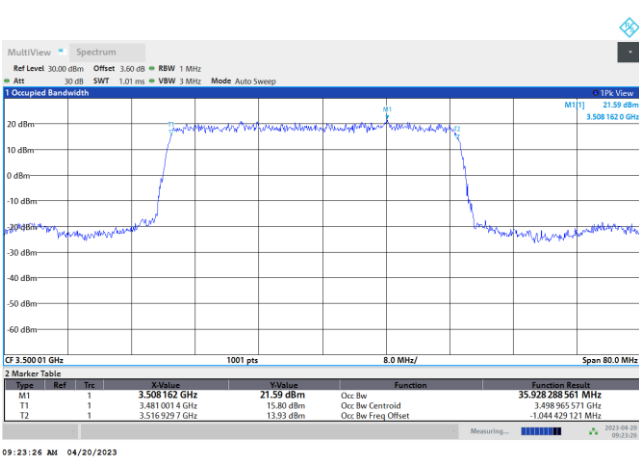

FR1 n77 / 40MHz / CP OFDM / Middle Channel / Full RB

QPSK

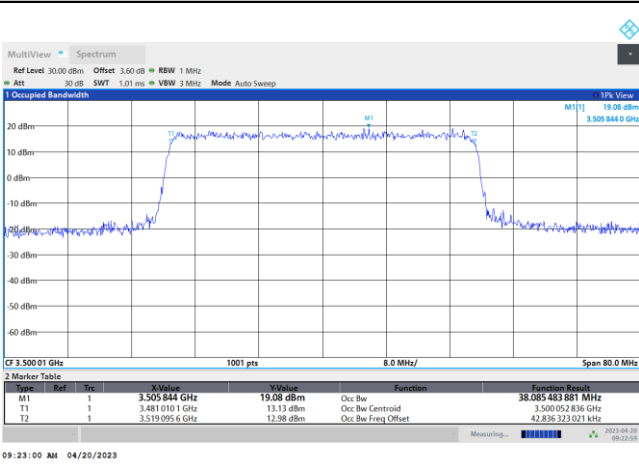

16QAM

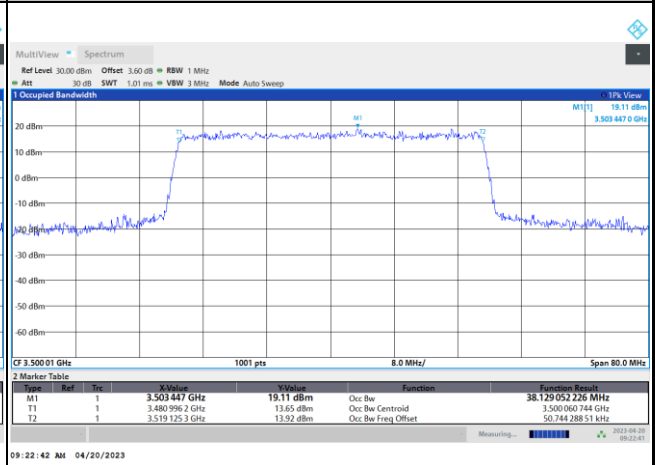

64QAM

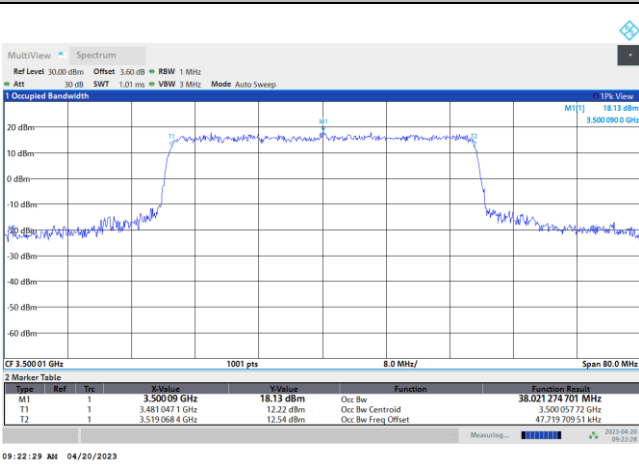

256QAM

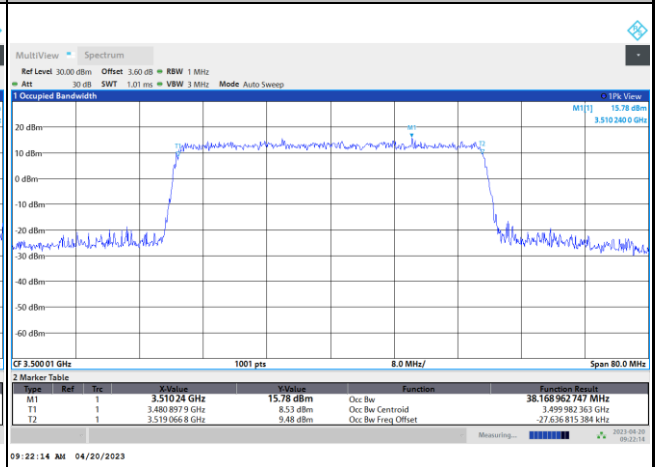



FR1 n77 / 50MHz / DFT-S OFDM / Middle Channel / Full RB

PI/2 BPSK

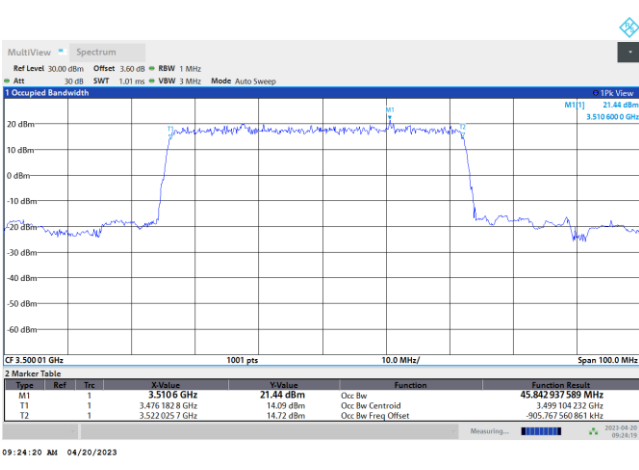

FR1 n77 / 50MHz / CP OFDM / Middle Channel / Full RB

QPSK

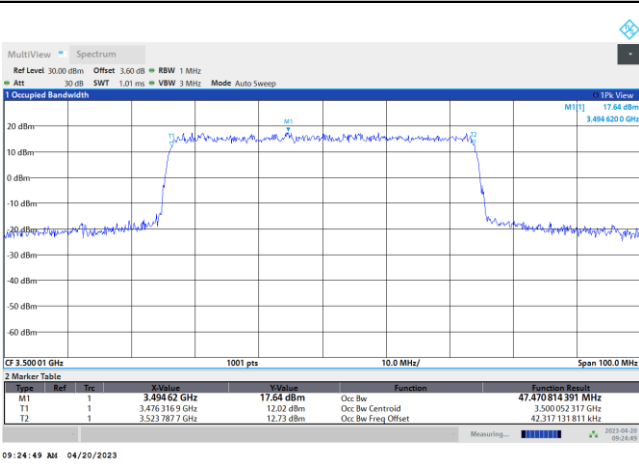

16QAM

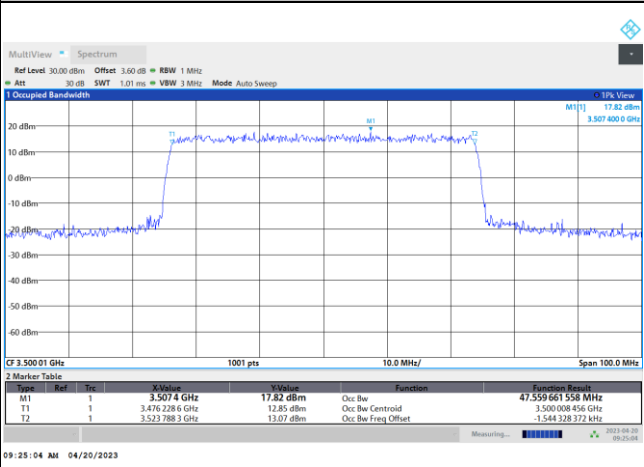

64QAM

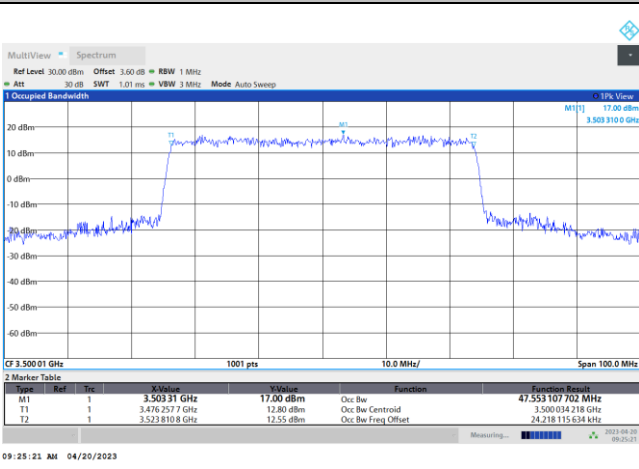

256QAM

